

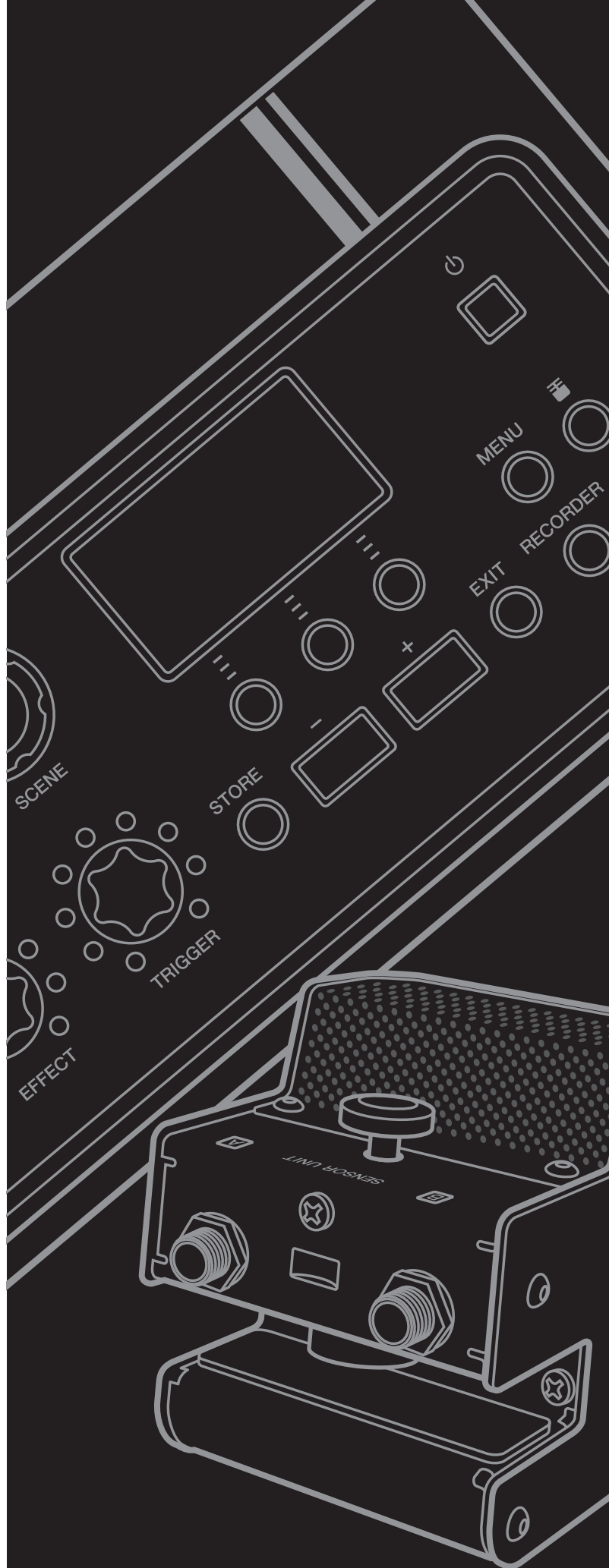

Electronic Acoustic
Drum Module

EAD10

Owner's Manual



Quick Guide

page 6

Features of the EAD10

page 10

SPECIAL MESSAGE SECTION

This product utilizes batteries or an external power supply (adapter). DO NOT connect this product to any power supply or adapter other than one described in the manual, on the name plate, or specifically recommended by Yamaha.

WARNING: Do not place this product in a position where anyone could walk on, trip over, or roll anything over power or connecting cords of any kind. The use of an extension cord is not recommended! If you must use an extension cord, the minimum wire size for a 25' cord (or less) is 18 AWG. NOTE: The smaller the AWG number, the larger the current handling capacity. For longer extension cords, consult a local electrician.

This product should be used only with the components supplied or; a cart, rack, or stand that is recommended by Yamaha. If a cart, etc., is used, please observe all safety markings and instructions that accompany the accessory product.

SPECIFICATIONS SUBJECT TO CHANGE:

The information contained in this manual is believed to be correct at the time of printing. However, Yamaha reserves the right to change or modify any of the specifications without notice or obligation to update existing units.

This product, either alone or in combination with an amplifier and headphones or speaker/s, may be capable of producing sound levels that could cause permanent hearing loss. DO NOT operate for long periods of time at a high volume level or at a level that is uncomfortable. If you experience any hearing loss or ringing in the ears, you should consult an audiologist.

IMPORTANT: The louder the sound, the shorter the time period before damage occurs.

Some Yamaha products may have benches and / or accessory mounting fixtures that are either supplied with the product or as optional accessories. Some of these items are designed to be dealer assembled or installed. Please make sure that benches are stable and any optional fixtures (where applicable) are well secured BEFORE using. Benches supplied by Yamaha are designed for seating only. No other uses are recommended.

NOTICE:

Service charges incurred due to a lack of knowledge relating to how a function or effect works (when the unit is operating as designed) are not covered by the manufacturer's warranty, and are therefore the owners responsibility. Please study this manual carefully and consult your dealer before requesting service.

ENVIRONMENTAL ISSUES:

Yamaha strives to produce products that are both user safe and environmentally friendly. We sincerely believe that our products and the production methods used to produce them, meet these goals. In keeping with both the letter and the spirit of the law, we want you to be aware of the following:

Battery Notice:

This product MAY contain a small non-rechargeable battery which (if applicable) is soldered in place. The average life span of this type of battery is approximately five years. When replacement becomes necessary, contact a qualified service representative to perform the replacement.

This product may also use "household" type batteries. Some of these may be rechargeable. Make sure that the battery being charged is a rechargeable type and that the charger is intended for the battery being charged.

When installing batteries, never mix old batteries with new ones, and never mix different types of batteries. Batteries MUST be installed correctly. Mismatches or incorrect installation may result in overheating and battery case rupture.

Warning:

Do not attempt to disassemble, or incinerate any battery. Keep all batteries away from children. Dispose of used batteries promptly and as regulated by the laws in your area. Note: Check with any retailer of household type batteries in your area for battery disposal information.

Disposal Notice:

Should this product become damaged beyond repair, or for some reason its useful life is considered to be at an end, please observe all local, state, and federal regulations that relate to the disposal of products that contain lead, batteries, plastics, etc. If your dealer is unable to assist you, please contact Yamaha directly.

NAME PLATE LOCATION:

The name plate is located on the bottom of the product. The model number, serial number, power requirements, etc., are located on this plate. You should record the model number, serial number, and the date of purchase in the spaces provided below and retain this manual as a permanent record of your purchase.

Model

Serial No.

Purchase Date

PLEASE KEEP THIS MANUAL

92-BP (bottom)

COMPLIANCE INFORMATION STATEMENT (DECLARATION OF CONFORMITY PROCEDURE)

Responsible Party : Yamaha Corporation of America
Address : 6600 Orangethorpe Ave., Buena Park, Calif. 90620
Telephone : 714-522-9011
Type of Equipment : Electronic Acoustic Drum Module
Model Name : EAD10

This device complies with Part 15 of the FCC Rules.

Operation is subject to the following two conditions:

- 1) this device may not cause harmful interference, and
- 2) this device must accept any interference received including interference that may cause undesired operation.

See user manual instructions if interference to radio reception is suspected.

* This applies only to products distributed by YAMAHA CORPORATION OF AMERICA.

(FCC DoC)

For AC adaptor and EAD10

FCC INFORMATION (U.S.A.)

1. IMPORTANT NOTICE: DO NOT MODIFY THIS UNIT!

This product, when installed as indicated in the instructions contained in this manual, meets FCC requirements. Modifications not expressly approved by Yamaha may void your authority, granted by the FCC, to use the product.

2. IMPORTANT: When connecting this product to accessories and/or another product use only high quality shielded cables. Cable/s supplied with this product **MUST** be used. Follow all installation instructions. Failure to follow instructions could void your FCC authorization to use this product in the USA.

3. NOTE: This product has been tested and found to comply with the requirements listed in FCC Regulations, Part 15 for Class "B" digital devices. Compliance with these requirements provides a reasonable level of assurance that your use of this product in a residential environment will not result in harmful interference with other electronic devices. This equipment generates/uses radio frequencies and, if not installed and used according to the instructions found in the users manual, may cause interference harmful to the operation of other electronic devices. Compliance with FCC regulations does

not guarantee that interference will not occur in all installations. If this product is found to be the source of interference, which can be determined by turning the unit "OFF" and "ON", please try to eliminate the problem by using one of the following measures:

Relocate either this product or the device that is being affected by the interference.

Utilize power outlets that are on different branch (circuit breaker or fuse) circuits or install AC line filter/s.

In the case of radio or TV interference, relocate/reorient the antenna. If the antenna lead-in is 300 ohm ribbon lead, change the lead-in to co-axial type cable.

If these corrective measures do not produce satisfactory results, please contact the local retailer authorized to distribute this type of product. If you can not locate the appropriate retailer, please contact Yamaha Corporation of America, Electronic Service Division, 6600 Orangethorpe Ave, Buena Park, CA90620

The above statements apply **ONLY** to those products distributed by Yamaha Corporation of America or its subsidiaries.

* This applies only to products distributed by YAMAHA CORPORATION OF AMERICA.

(class B)

For AC adaptor

This device complies with Part 15 of the FCC Rules. Operation is subject to the following two conditions: (1) this device may not cause harmful interference, and (2) this device must accept any interference received, including interference that may cause undesired operation.

CAN ICES-3 (B)/NMB-3(B)

(can_b_02)

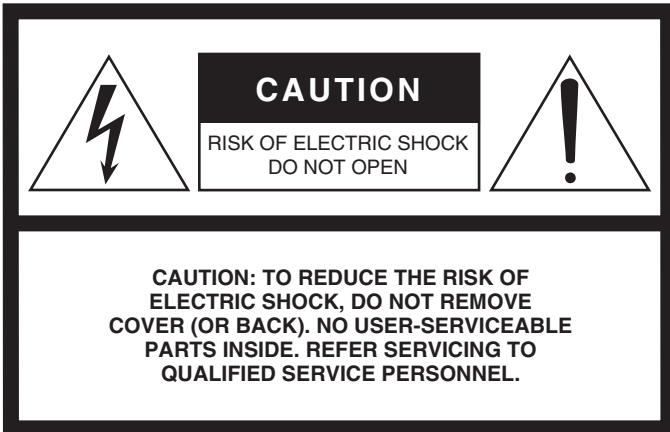

Explanation of Graphical Symbols

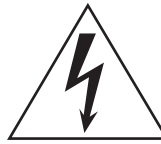

The lightning flash with arrowhead symbol within an equilateral triangle is intended to alert the user to the presence of uninsulated “dangerous voltage” within the product’s enclosure that may be of sufficient magnitude to constitute a risk of electric shock to persons.



The exclamation point within an equilateral triangle is intended to alert the user to the presence of important operating and maintenance (servicing) instructions in the literature accompanying the product.

IMPORTANT SAFETY INSTRUCTIONS

- 1 Read these instructions.
- 2 Keep these instructions.
- 3 Heed all warnings.
- 4 Follow all instructions.
- 5 Do not use this apparatus near water.
- 6 Clean only with dry cloth.
- 7 Do not block any ventilation openings. Install in accordance with the manufacturer’s instructions.
- 8 Do not install near any heat sources such as radiators, heat registers, stoves, or other apparatus (including amplifiers) that produce heat.
- 9 Do not defeat the safety purpose of the polarized or grounding-type plug. A polarized plug has two blades with one wider than the other. A grounding type plug has two blades and a third grounding prong. The wide blade or the third prong are provided for your safety. If the provided plug does not fit into your outlet, consult an electrician for replacement of the obsolete outlet.
- 10 Protect the power cord from being walked on or pinched particularly at plugs, convenience receptacles, and the point where they exit from the apparatus.
- 11 Only use attachments/accessories specified by the manufacturer.
- 12 Use only with the cart, stand, tripod, bracket, or table specified by the manufacturer, or sold with the apparatus. When a cart is used, use caution when moving the cart/apparatus combination to avoid injury from tip-over.
- 13 Unplug this apparatus during lightning storms or when unused for long periods of time.
- 14 Refer all servicing to qualified service personnel. Servicing is required when the apparatus has been damaged in any way, such as power-supply cord or plug is damaged, liquid has been spilled or objects have fallen into the apparatus, the apparatus has been exposed to rain or moisture, does not operate normally, or has been dropped.



WARNING

TO REDUCE THE RISK OF FIRE OR ELECTRIC SHOCK, DO NOT EXPOSE THIS APPARATUS TO RAIN OR MOISTURE.

(UL60065_03)

OBSERVERA!

Apparaten kopplas inte ur växelströmskällan (nätet) så länge som den är ansluten till vägguttaget, även om själva apparaten har stängts av.

ADVARSEL: Netspændingen til dette apparat er IKKE afbrudt, så længe netledningen sidder i en stikkontakt, som er tændt — også selvom der er slukket på apparatets afbryder.

VAROITUS: Laitteen toisiopiiriin kytketty käyttökytkin ei irroita koko laitetta verkosta.

(standby)

Information for users on collection and disposal of old equipment:

This symbol on the products, packaging, and/or accompanying documents means that used electrical and electronic products should not be mixed with general household waste.

For proper treatment, recovery and recycling of old products, please take them to applicable collection points, in accordance with your national legislation.

By disposing of these products correctly, you will help to save valuable resources and prevent any potential negative effects on human health and the environment which could otherwise arise from inappropriate waste handling.

For more information about collection and recycling of old products, please contact your local municipality, your waste disposal service or the point of sale where you purchased the items.

For business users in the European Union:

If you wish to discard electrical and electronic equipment, please contact your dealer or supplier for further information.

Information on Disposal in other Countries outside the European Union:

This symbol is only valid in the European Union. If you wish to discard these items, please contact your local authorities or dealer and ask for the correct method of disposal.

(weee_eu_en_02)

PRECAUTIONS

PLEASE READ CAREFULLY BEFORE PROCEEDING

Please keep this manual in a safe and handy place for future reference.

For AC adaptor



WARNING

- This AC adaptor is designed for use with only Yamaha electronic instruments. Do not use for any other purpose.
- Indoor use only. Do not use in any wet environments.



CAUTION

- When setting up, make sure that the AC outlet is easily accessible. If some trouble or malfunction occurs, immediately turn off the power switch of the instrument and disconnect the AC adaptor from the outlet. When the AC adaptor is connected to the AC outlet, keep in mind that electricity is flowing at the minimum level, even if the power switch is turned off. When you are not using the instrument for a long time, make sure to unplug the power cord from the wall AC outlet.

For EAD10



WARNING

Always follow the basic precautions listed below to avoid the possibility of serious injury or even death from electrical shock, short-circuiting, damages, fire or other hazards. These precautions include, but are not limited to, the following:

Power supply/AC adaptor

- Do not place the power cord near heat sources such as heaters or radiators. Also, do not excessively bend or otherwise damage the cord, or place heavy objects on it.
- Only use the voltage specified as correct for the instrument. The required voltage is printed on the name plate of the instrument.
- Use the specified adaptor (page 63) only. Using the wrong adaptor can result in damage to the instrument or overheating.
- Check the electric plug periodically and remove any dirt or dust which may have accumulated on it.

Do not open

- This instrument contains no user-serviceable parts. Do not open the instrument or attempt to disassemble or modify the internal components in any way. If it should appear to be malfunctioning, discontinue use immediately and have it inspected by qualified Yamaha service personnel.

Water warning

- Do not expose the instrument to rain, use it near water or in damp or wet conditions, or place on it any containers (such as vases, bottles or glasses) containing liquids which might spill into any openings. If any liquid such as water seeps into the instrument, turn off the power immediately and unplug the power cord from the AC outlet. Then have the instrument inspected by qualified Yamaha service personnel.
- Never insert or remove an electric plug with wet hands.

Fire warning

- Do not put burning items, such as candles, on the unit. A burning item may fall over and cause a fire.

If you notice any abnormality

- When one of the following problems occur, immediately turn off the power switch and disconnect the electric plug from the outlet. Then have the device inspected by Yamaha service personnel.
 - The power cord or plug becomes frayed or damaged.
 - It emits unusual smells or smoke.
 - Some object has been dropped into the instrument.
 - There is a sudden loss of sound during use of the instrument.

CAUTION

Always follow the basic precautions listed below to avoid the possibility of physical injury to you or others, or damage to the instrument or other property. These precautions include, but are not limited to, the following:

Power supply/AC adaptor

- Do not connect the instrument to an electrical outlet using a multiple-connector. Doing so can result in lower sound quality, or possibly cause overheating in the outlet.
- When removing the electric plug from the instrument or an outlet, always hold the plug itself and not the cord. Pulling by the cord can damage it.
- Remove the electric plug from the outlet when the instrument is not to be used for extended periods of time, or during electrical storms.

Assembly

- Read carefully the attached documentation explaining the assembly process. Failure to assemble the instrument in the proper sequence might result in damage to the instrument or even injury.

Location

- Do not place the instrument in an unstable position where it might accidentally fall over.
- Before moving the instrument, remove all connected cables, to prevent damage to the cables or injury to anyone who might trip over them.
- When setting up the product, make sure that the AC outlet you are using is easily accessible. If some trouble or malfunction occurs, immediately turn off the power switch and disconnect the plug from the outlet. Even when the power switch is turned off, electricity is still flowing to the product at the minimum level. When you are not using the product for a long time, make sure to unplug the power cord from the wall AC outlet.
- Use the included module holder if you are installing the EAD10 on the hi-hat stand. Also, make sure you use the wing bolts included with the module holder. Failure to do so could cause damage to the internal components or result in the instrument falling over.
- Be sure to securely tighten the clamp screw and module holder wing bolts when setting up the EAD10. Also, do not loosen the clamp screw or module holder wing bolts rapidly. Not doing so can cause parts to fall off the main unit, sensor unit, or module holder resulting in injury.

Connections

- Before connecting the instrument to other electronic components, turn off the power for all components. Before turning the power on or off for all components, set all volume levels to minimum.
- Be sure to set the volumes of all components at their minimum levels and gradually raise the volume controls while playing the instrument to set the desired listening level.

Handling caution

- Do not rest your weight on, or place heavy objects on the instrument, and do not use excessive force on the buttons, switches or connectors.
- Do not use the instrument/device or headphones for a long period of time at a high or uncomfortable volume level, since this can cause permanent hearing loss. If you experience any hearing loss or ringing in the ears, consult a physician.

Yamaha cannot be held responsible for damage caused by improper use or modifications to the instrument, or data that is lost or destroyed.

Always turn the power off when the instrument is not in use.

Even when the [] (Standby/On) switch is in standby status (display is off), electricity is still flowing to the instrument at the minimum level.

When you are not using the instrument for a long time, make sure you unplug the power cord from the wall AC outlet.

NOTICE

To avoid the possibility of malfunction/ damage to the product, damage to data, or damage to other property, follow the notices below.

■ Handling

- Do not use the instrument in the vicinity of a TV, radio, stereo equipment, mobile phone, or other electric devices. Otherwise, the instrument, TV, or radio may generate noise. When you use the instrument along with an application on your iPad, iPhone or iPod touch, we recommend that you set "Airplane Mode" to "ON" on that device in order to avoid noise caused by communication.
- Do not expose the instrument to excessive dust or vibrations, or extreme cold or heat (such as in direct sunlight, near a heater, or in a car during the day) to prevent the possibility of panel disfiguration, damage to the internal components or unstable operation.
- Do not place vinyl, plastic or rubber objects on the instrument, since this might discolor the panel or keyboard.

■ Maintenance

- When cleaning the instrument, use a soft and dry/slightly damp cloth. Do not use paint thinners, solvents, alcohol, cleaning fluids, or chemical-impregnated wiping cloths.

■ Saving data

- System settings (Reference Manual (Advanced)(PDF)) are stored automatically and will not be lost when the power is turned off. However, settings may be lost due to malfunction or improper operation. Save important data to an external device such as a USB flash drive or a computer (pages 25 and 30). Please read page 30 before using a USB flash drive.
- Edits to Scenes, etc., are lost if not saved before the power is turned off. Likewise, edits are lost when the auto power off function turns the power off (page 29). Save data you want to keep to the main unit, or to an external device such as a computer or USB flash drive (pages 25 and 30). However, data stored in the main unit may be lost due to malfunction or improper operation. Save important data to an external device such as a USB flash drive or a computer (pages 25 and 30). Please read page 30 before using a USB flash drive.
- To protect against data loss through USB flash drive damage, we recommend that you save your important data onto spare USB flash drive or an external device such as a computer as backup data.

Information

■ About copyrights

- Copying of the commercially available musical data including but not limited to MIDI data and/or audio data is strictly prohibited except for your personal use.
- This product incorporates and bundles contents in which Yamaha owns copyrights or with respect to which Yamaha has license to use others' copyrights. Due to copyright laws and other relevant laws, you are NOT allowed to distribute media in which these contents are saved or recorded and remain virtually the same or very similar to those in the product.

* The contents described above include a computer program, Accompaniment Style data, MIDI data, WAV data, voice recording data, a score, score data, etc.

* You are allowed to distribute medium in which your performance or music production using these contents is recorded, and the permission of Yamaha Corporation is not required in such cases.

■ About this manual

- The illustrations and LCD screens as shown in this manual are for instructional purposes only, and may appear somewhat different from those on your instrument.
- Windows is a registered trademark of Microsoft® Corporation in the United States and other countries.
- MacOS, iPhone and iPad are trademarks of Apple Inc., registered in the U.S. and other countries.
- The company names and product names in this manual are the trademarks or registered trademarks of their respective companies.
- The names of buttons, terminals, and the like from the EAD10's front, rear and top panels are enclosed in [] (square brackets).

■ Latest Firmware Version

From time to time, Yamaha may update product firmware without prior notice.

We recommend, therefore, that you check our web site (below) for the latest version and keep your EAD10 firmware up to date.

<https://download.yamaha.com/>

The content of this Owner's Manual applies to the newest version of the firmware as of printing. Details regarding any functions added to later versions will also be made available via the above web site.

■ About the Pads

Within this Owner's Manual, the optional external pads that may be connected to the EAD10 are referred to by model name. Please note that these model names were up-to-date as of printing of this manual.

Details regarding any subsequently released models will be made available via the following web site.

<https://download.yamaha.com/>

* Yamaha Corporation reserves the right to modify this URL at any time without prior notice.

The model number, serial number, power requirements, etc., may be found on or near the name plate, which is at the bottom of the unit.
You should note this serial number in the space provided below and retain this manual as a permanent record of your purchase to aid identification in the event of theft.

Model No.

Serial No.

(bottom_en_01)

Quick Guide

Adjusting Volume and Sound Balance

(page 13)

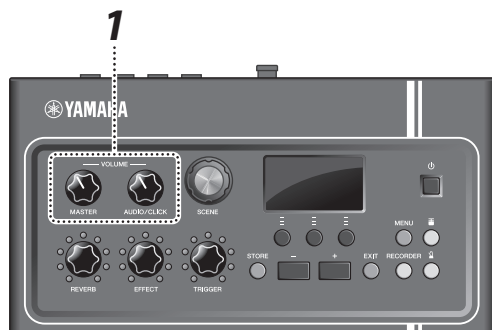

1. Turn the [MASTER VOLUME] knob or [AUDIO/CLICK VOLUME] knob.



MASTER

Overall volume



AUDIO/CLICK

Volume control for the AUX IN (auxiliary input) and Metronome (click)—sounds other than what you play

Hit all drums and cymbals in the drum set to make sure that the EAD10 is picking up the sound.

Changing Sounds

(page 33)

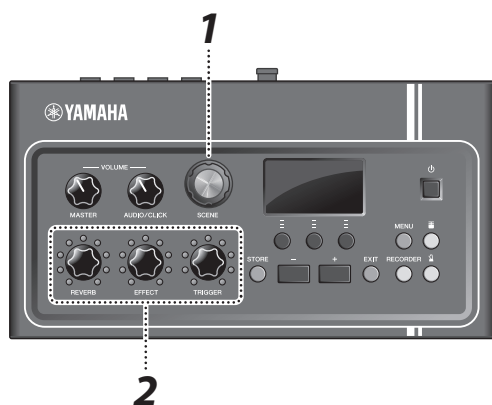

1. Turn the [SCENE] knob to select different sounds (Scenes).
2. Adjust the levels with the [REVERB], [EFFECT], and [TRIGGER] knobs.



REVERB

Adjusts the Reverb depth



EFFECT

Adjusts the Effect depth





TRIGGER

Adjusts the Trigger Sound volume (with the default setting, the Trigger sound is added to the bass drum)

Practicing with the Metronome (Click)

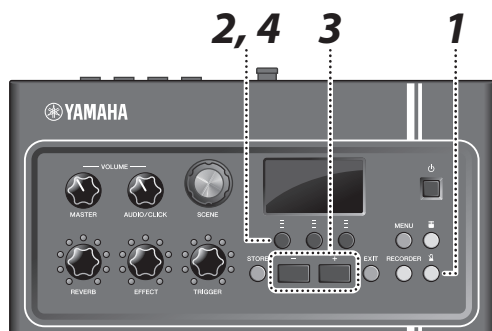
(page 39)



1. Press the [] (Click) button.
2. Press the button below “” to the start the Metronome.



3. Use the [+] or [-] buttons to adjust the tempo.
4. Press the “” button again to stop the Metronome.



Playing Along with a Favorite Song

(page 24)

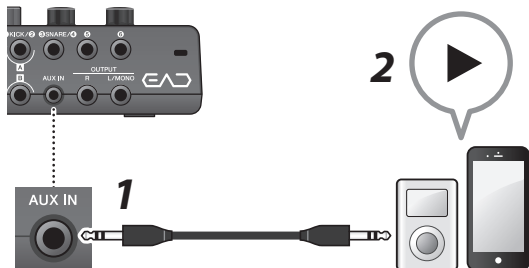

1. Connect a portable music player to the [AUX IN] jack.
2. Start music playback on your portable player.
3. Play the drums while listening with headphones.



Recording Your Performance

(page 41)

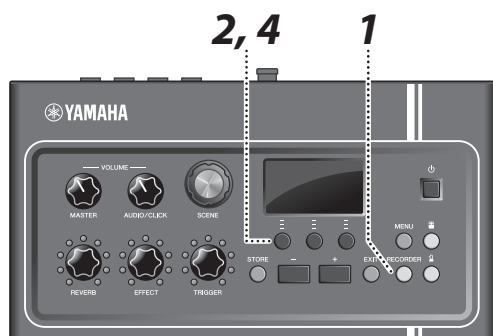

1. Press the [RECORDER] button.
2. Press the button below “●” to start recording.

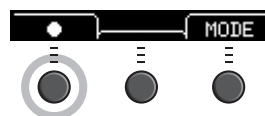

3. Play the drums.
4. Press the button below “○” to stop recording.

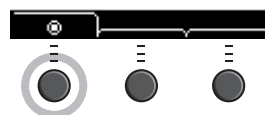

Contents

PRECAUTIONS	2
--------------------	----------

Quick Guide	6
--------------------	----------

Included Accessories	9
-----------------------------	----------

Features of the EAD10	10
How the EAD10 makes sound.....	11

About the Manuals	12
Printed Manual	12
Digital Manual (PDF)	12

Panel Controls and Functions	13
Main Unit	13
Sensor Unit.....	15
About the Trigger Input Jacks.....	16

Setup Guide	17
Setting Up.....	17
Connect with Other Devices and Expand the Fun.....	24
Turning On or Off.....	25
Setting Up the Sensor Unit.....	27
Changing the Overall Settings.....	29
Using a USB Flash Drive.....	30

Basic Guide	32
Performing with Various of Scenes	32
Creating Your Own Scene.....	35
Using the Click (Metronome).....	39
Recording Your Performance	41

Application Guide	48
Enhance Your Drum Set with Separately Sold Add-Ons...	48

Reference	55
Menu List.....	55
Troubleshooting.....	58
Message List	61
Specifications	63
Index.....	64

Welcome

Thank you for purchasing this Yamaha product.

To get the most out of your EAD10, be sure to read this Owner's Manual carefully.

And after reading through this manual, be sure to store it in a safe place so that you can refer back to it again as needed.

Included Accessories

- Owner's Manual (this book)

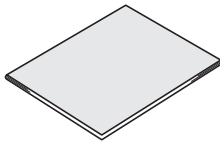

- Module holder wing bolts (× 2)



- AC adaptor

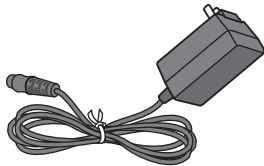

- Connector cables (1 pair)



- Module holder

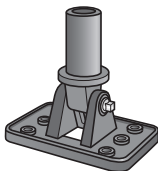

- Cable bands (× 3)

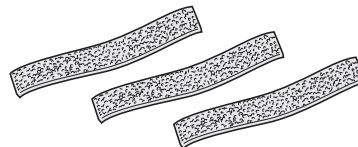

- Adhesive cushions (× 2)

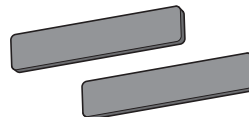

Features of the EAD10

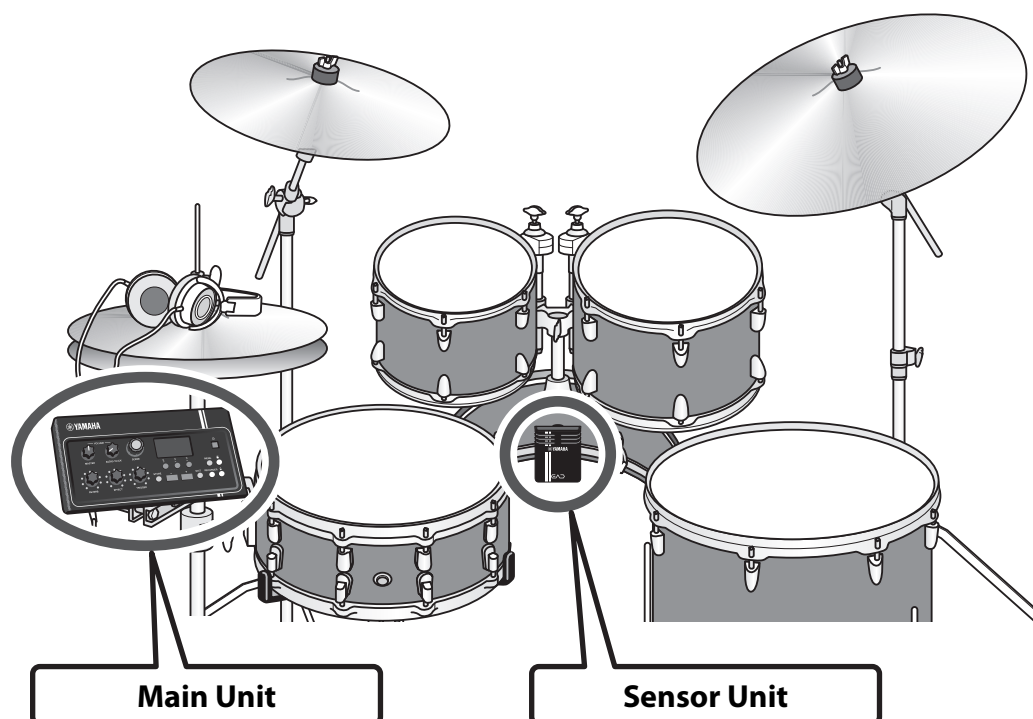

The EAD10 lets you easily change the sound of your acoustic drums into the sound of your liking. Connect a smart phone to the EAD10 and enjoy playing the drums along with your favorite music. Also, it can be used in a wide range of applications from practice, recording to live situations.

Easy setup allows comfortable monitoring of your drum sound while playing

- Sensor Unit that mounts on the bass drum makes setup simple
- Built-in XY configured stereo mic provides high quality monitoring of the entire drum set with natural balance and stereo orientation
- Loud drums can be monitored with proper volume using headphones or earphones

Transforms the sound of your drums into a sound of your liking

- Change effect settings with a single knob and easily save and recall settings
- PCM tone generator makes it easy to change the sound of your bass drum by using a Triggered sound — even in the middle of a performance
- Play a wide range of musical genres from contemporary to the by using the effects, your own samples or the internal Triggered sounds

Use for recording or in-live situations

- Recording and playback possible via USB flash drive or USB audio
- Left and right outputs allow you to easily connect to a PA

■ How the EAD10 makes sound

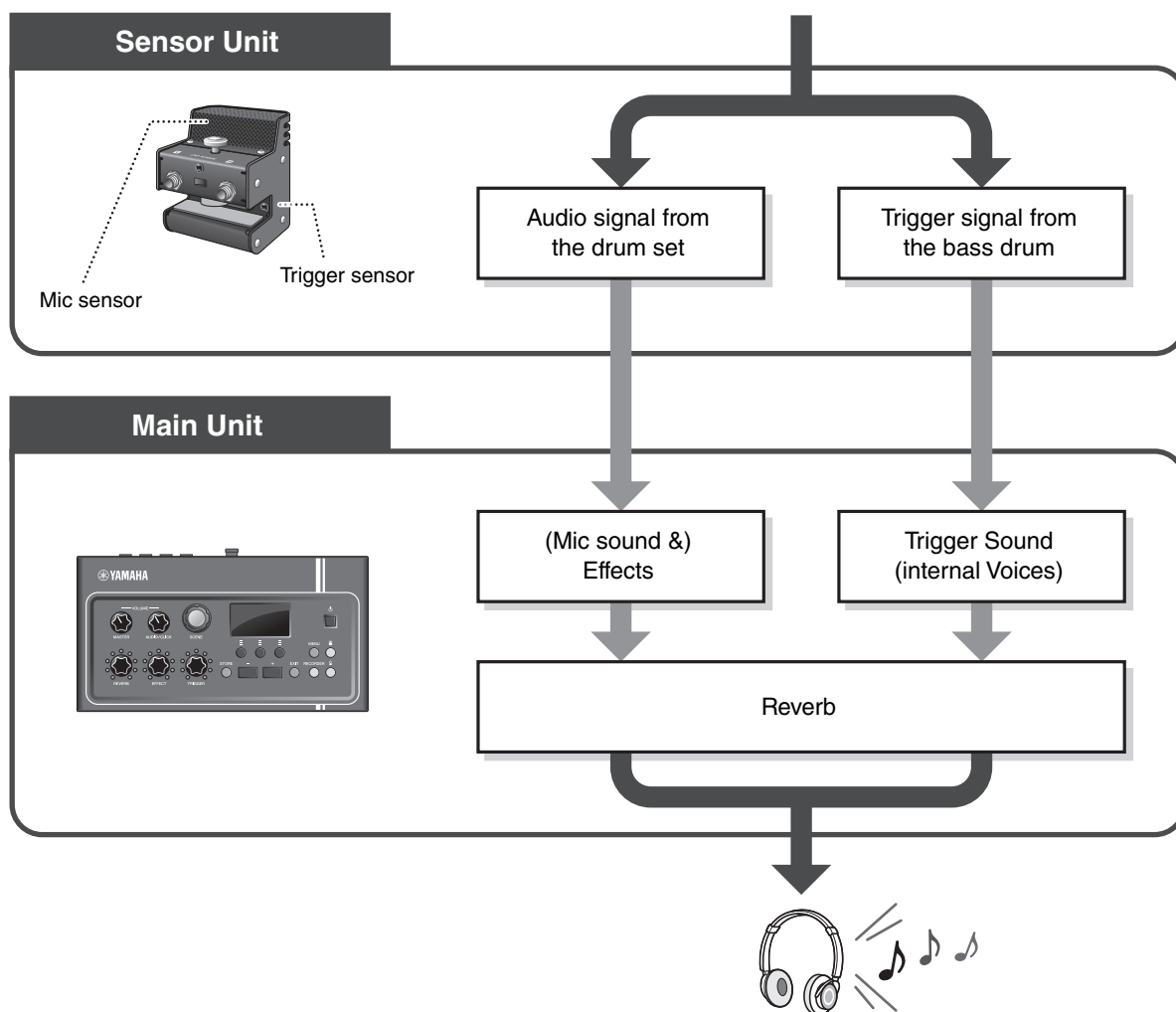

The Sensor Unit sends two types of signals to the Main Unit; an audio signal captured with the mic sensor, and a trigger signal captured with the trigger sensor. The audio signal can be processed with Effects, while the trigger sensor can be used to play Trigger Sounds depending on how you play your drums.

For more information on Trigger Sounds, Effects, and Reverb, please see "What is a Scene?" (page 32).

About the Manuals

The following manuals are provided for using the EAD10. These manuals are intended for users of the EAD10.

Printed Manual



Owner's Manual (this book)

Setup Guide

Explains how to attach and setup the EAD10 for producing sound.

Basic Guide

Describes the fundamentals needed to operate the EAD10.

Application Guide

Describes parameter settings and other more advanced uses.

Reference

Describes troubleshooting techniques and contains other reference materials.

Digital Manual (PDF)



Reference Manual (Advanced)

The Reference Manual provides a description of all of the functions that can be accessed by pressing the [MENU] button.



Data List

This provides lists of Scene and Effect names in the EAD10, and MIDI related information.



iPhone/iPad Connection Manual

Describes how to connect smart devices such as an iPhone and iPad.

The digital format manuals listed above can be obtained from the Yamaha Downloads web page. To do so, go to the web page using the following URL, enter "EAD10" in the "Model Name" field, and then click "Search."

Yamaha Downloads: <https://download.yamaha.com/>

Panel Controls and Functions

Main Unit

Top Panel

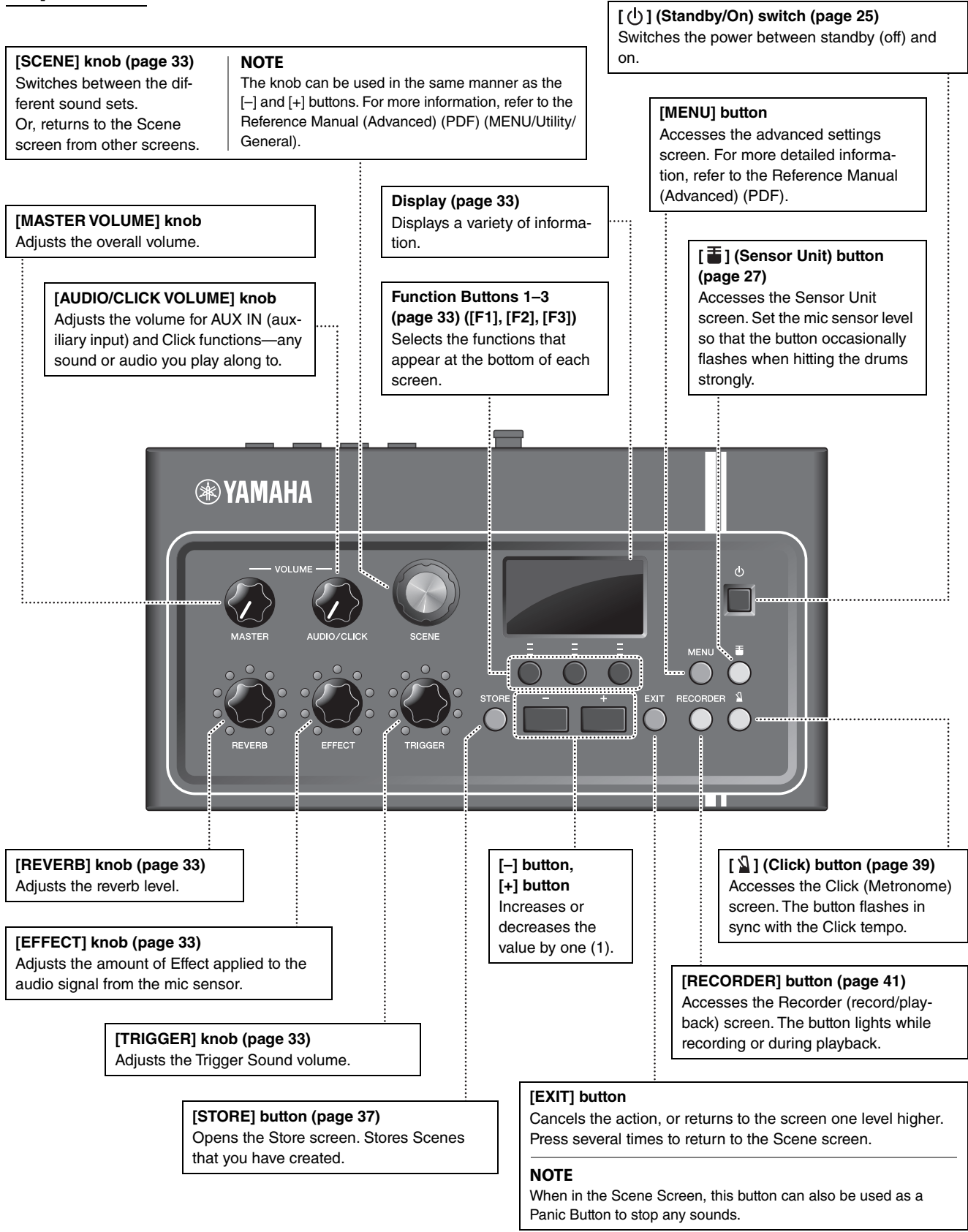

Rear Panel

[FOOT SW] Jack (page 48)
Connects a foot pedal or foot switch (sold separately).

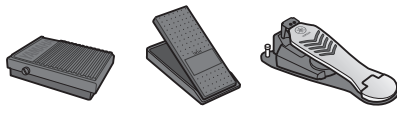

FC5 FC7 HH65
etc.

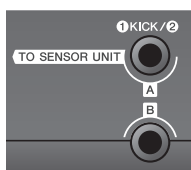

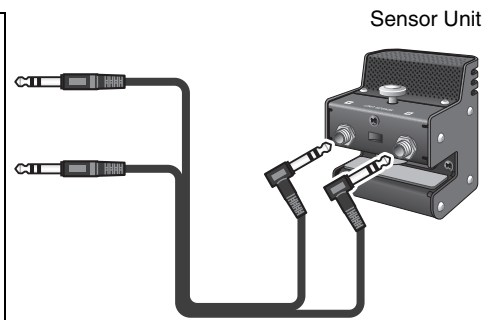

TO SENSOR UNIT [A] jack (page 17)
Connect to the [A] jack on the Sensor Unit using the connector cable (included).

TO SENSOR UNIT [B] jack
Connect to the [B] jack on the Sensor Unit.

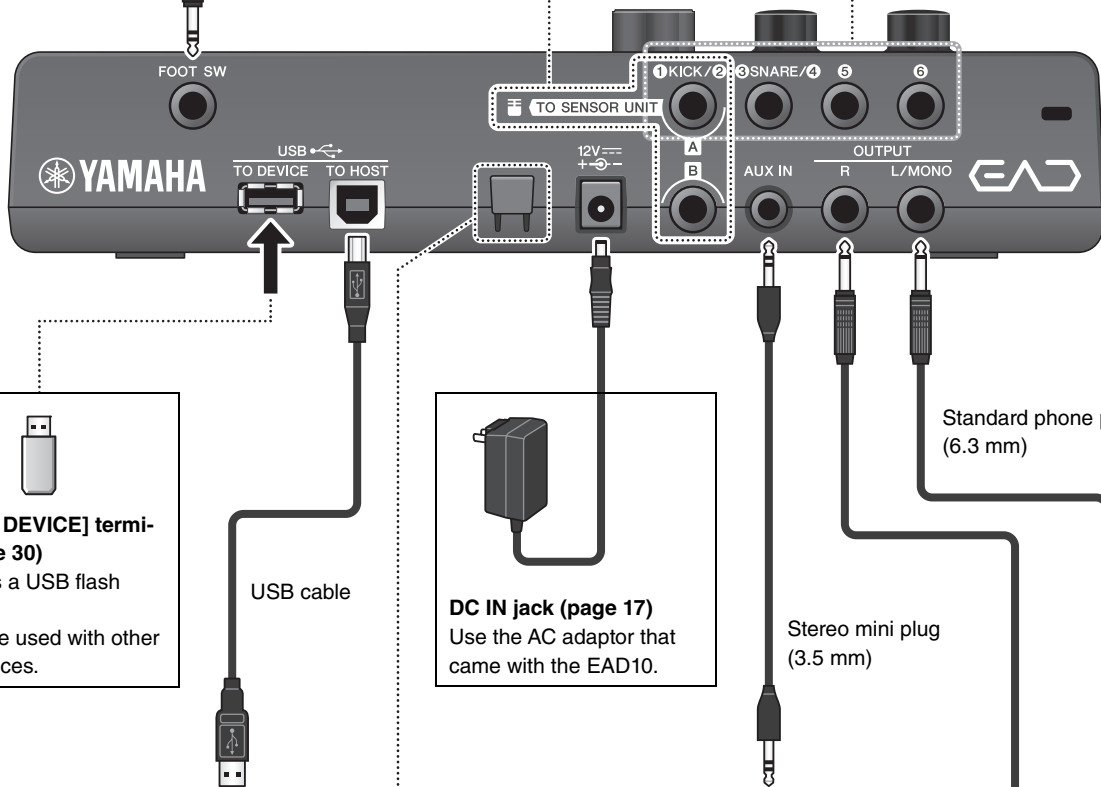

For more information on the [1 KICK/2] to [6] jacks, see "About the Trigger Input Jacks" (page 16).

[USB TO DEVICE] terminal (page 30)
Connects a USB flash drive. Cannot be used with other USB devices.

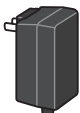

DC IN jack (page 17)
Use the AC adaptor that came with the EAD10.



[USB TO HOST] terminal (page 25)
Connect a computer or smart device such as an iPhone or iPad to send and receive digital signals (audio and MIDI). Additional parts are required for connecting an iPhone or iPad. For more information, refer to "iPhone/iPad Connection Manual" (PDF).

Cord hook (page 17)
Wrap the AC adaptor cord around this hook to prevent accidental unplugging during use.

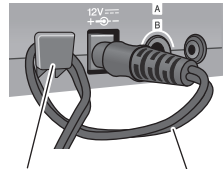

Cord hook

AC adaptor cord



[AUX IN] (auxiliary input) jack (page 17)
Connect to the headphone jack on a smart phone or portable music player.

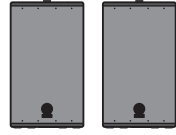

OUTPUT [R]/[L/MONO] jacks (page 17)
Connect to powered speakers or other such PA system. These jacks are standard phone type output jacks. If mono output is required, use only the [L/MONO] jack.

Front Panel

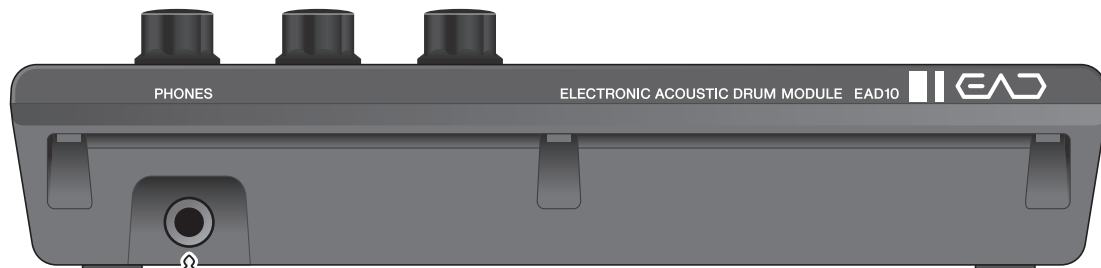

Standard stereo phone plug
(6.3 mm)



[PHONES] jack

Connects headphones. This output jack is a standard stereo phone plug (6.3 mm). Use a 3.5 mm stereo mini to (6.3 mm) stereo adaptor to connect headphones or earphones with a stereo mini plug (3.5 mm) to the [PHONES] jack.

CAUTION

Do not use headphones for a long period of time at high volume. Doing so can cause loss of hearing.

Sensor Unit

NOTICE

Do not hit the Sensor Unit with the drumsticks. Doing so can damage the mic sensor resulting in inferior performance.

Mic Sensor
Captures the whole drum set's acoustic sound converting it into an audio signal.

[A] jack
Connect to the TO SENSOR UNIT [A] jack on the rear panel using the connector cable (included). Sends the trigger sensor signal.

[B] jack
Connect to the TO SENSOR UNIT [B] jack on the rear panel using the connector cable (included). Sends the mic sensor signal.

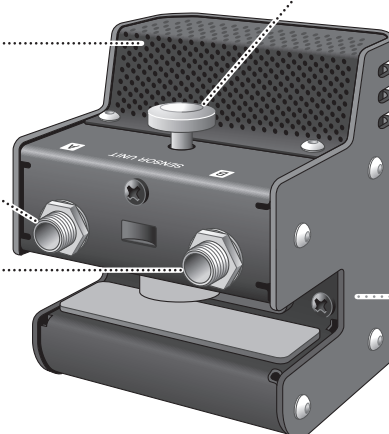

Clamp screw (page 17)
Secures the Sensor Unit to the bass drum hoop.

Trigger sensor
Converts vibrations produced when the bass drum is hit into a trigger signal.

About the Trigger Input Jacks

Trigger signals are received via the trigger input jacks. These are used for connecting separately sold accessories to the EAD10. You can connect up to six pads or drum triggers.

[1 KICK/2] through [6] jacks are located on the rear panel of the Main Unit.

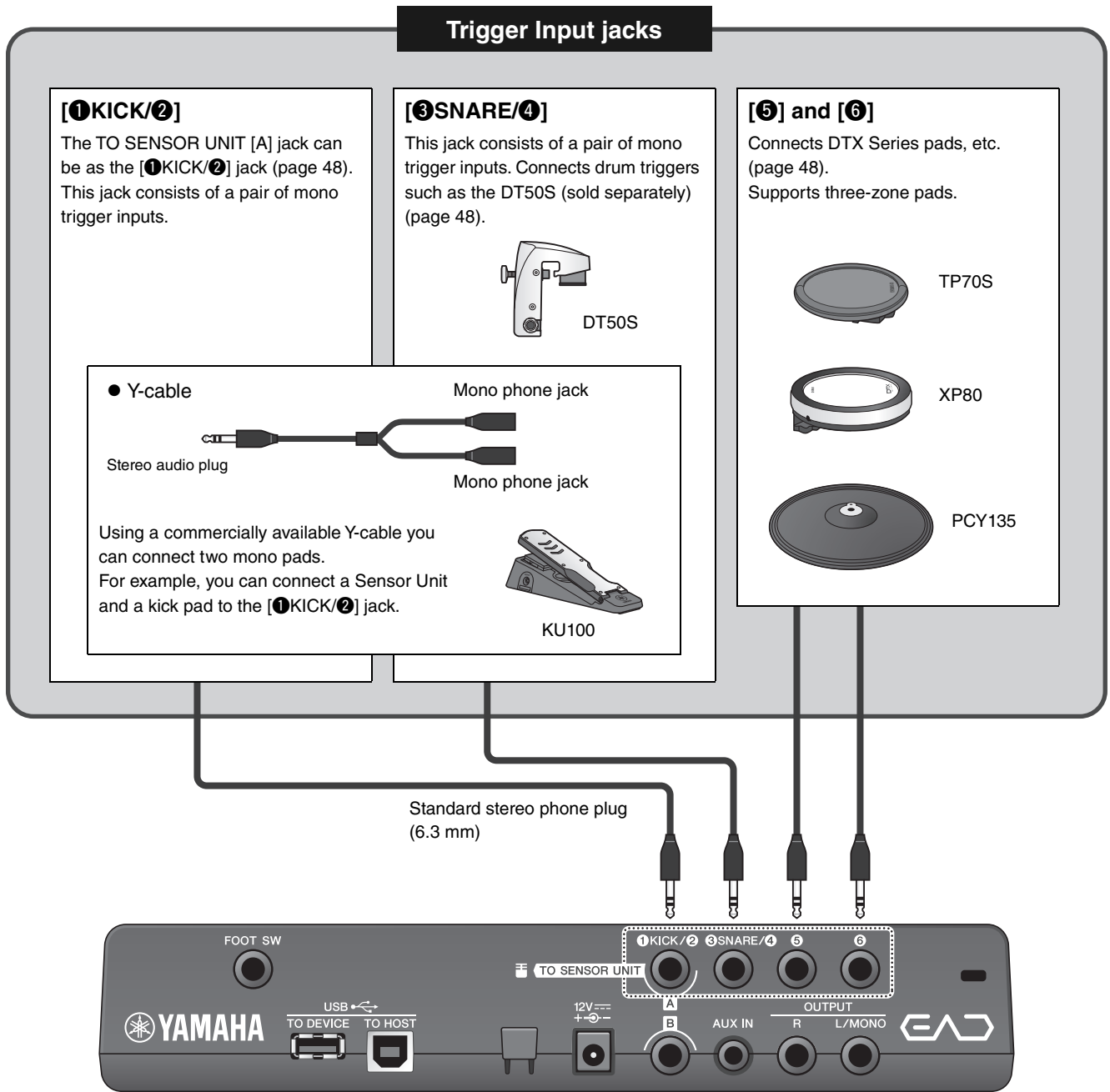

Visit the web page below for more information on separately sold accessories that can be connected to each trigger input jack.

For more information on connections of separately sold accessories, see “Enhance Your Drum Set with Separately Sold Add-Ons” (page 48).

Yamaha Downloads: <https://download.yamaha.com/>

* Yamaha Corporation reserves the right to modify this URL at any time without prior notice.

Setup Guide

This provides information on setup and initial settings in preparation for playing.

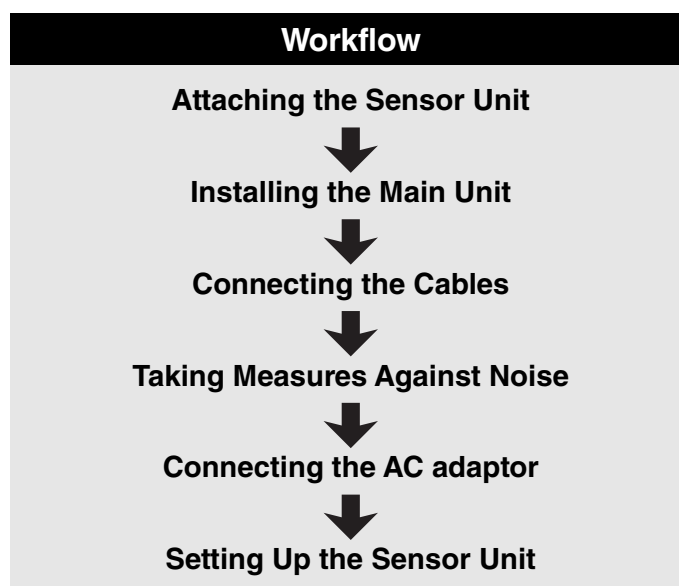

This completes set up.

Setting Up

■ Positioning the drum set



The bass drum should be the central point in the drum set, with the snare, toms, cymbals, positioned in a well balanced manner around it. Instruments positioned away from the Sensor Unit mounted on the bass drum may sound lower in volume. When instruments such as the ride cymbal are positioned too close to the Sensor Unit, the sound will be too loud and out of balance.

Using the sensor with double bass drum set ups gives an uneven and unbalanced sound, so we do not recommend using it in this situation.

■ Attaching the Sensor Unit

Attach the Sensor Unit to the top of the batter side bass drum hoop.

● Standard Straight Hoop

Wood hoops

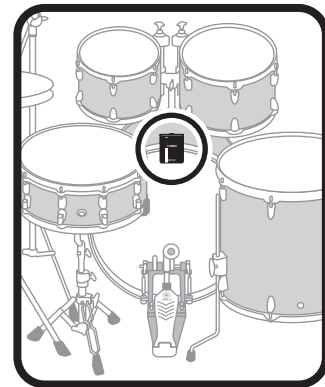
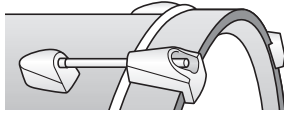

1. Slide the Sensor Unit onto the top of the batter side bass drum hoop as far as possible.
2. Lift the Sensor Unit and after making sure both surfaces shown in the figure below are in contact with the hoop, turn the clamp screw.

Side view

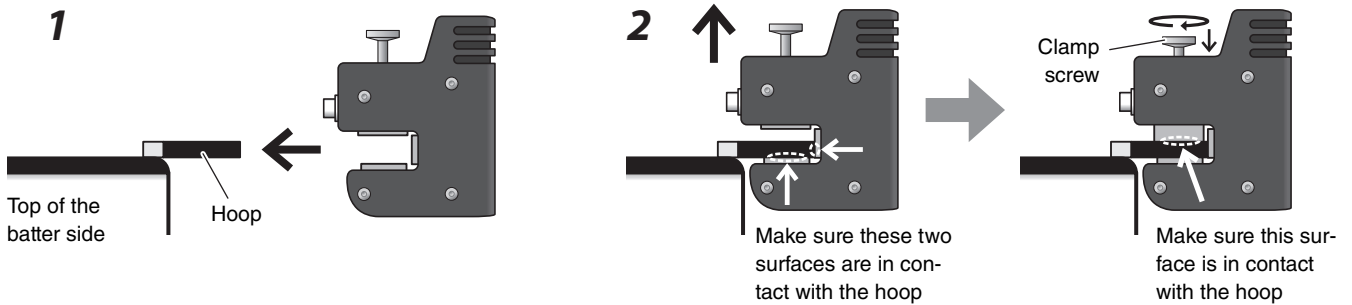

● Other Hoop Types

Metal hoops

Uneven profile type



1. Attach the included adhesive cushions, one each to the top of the inner and outer hoop surfaces.

NOTICE

Make sure the uneven surface is filled with adhesive cushions to provide a secure attachment for the sensor. The Sensor Unit may fall off if the adhesive cushions is not used.

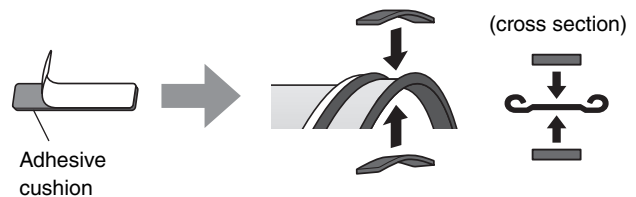

2. Attach the sensor using the same procedure as for a standard hoop drum.

■ Installing the Main Unit

Either place the Main Unit on a table, or attach the Main Unit to a hi-hat stand.

● Placing on a Flat Surface

Place the Main Unit on a table or flat surface.



● Mounting on a Hi-Hat Stand

1. Combine the included module holder with a separately sold cymbal stand attachment (CSAT924A) and mount on the hi-hat stand.

Tighten the module holder wing nuts to securely fasten the Main Unit and module holder.

We recommend attaching the Main Unit to a position where it cannot be hit by your knees.

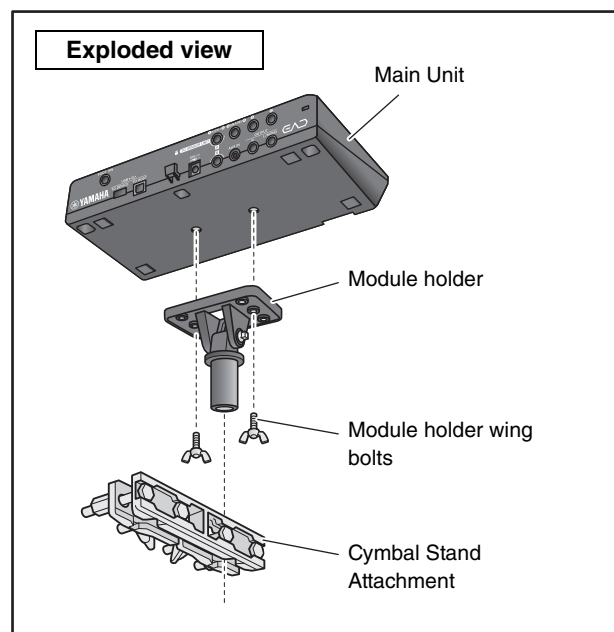
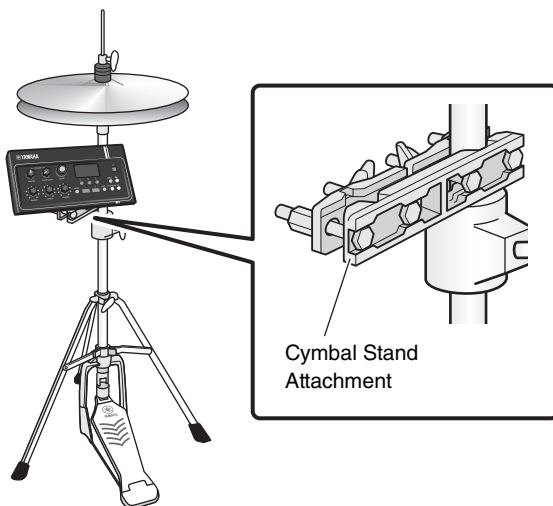

About the Module Holder

The module holder has three sets of holes. Use the center set of holes to mount in a standard position. Use the rear set of holes if you want the unit positioned forward, and use the front set of holes to position the unit to the rear.

NOTE

The module holder is 22.2 mm (7/8") diameter.

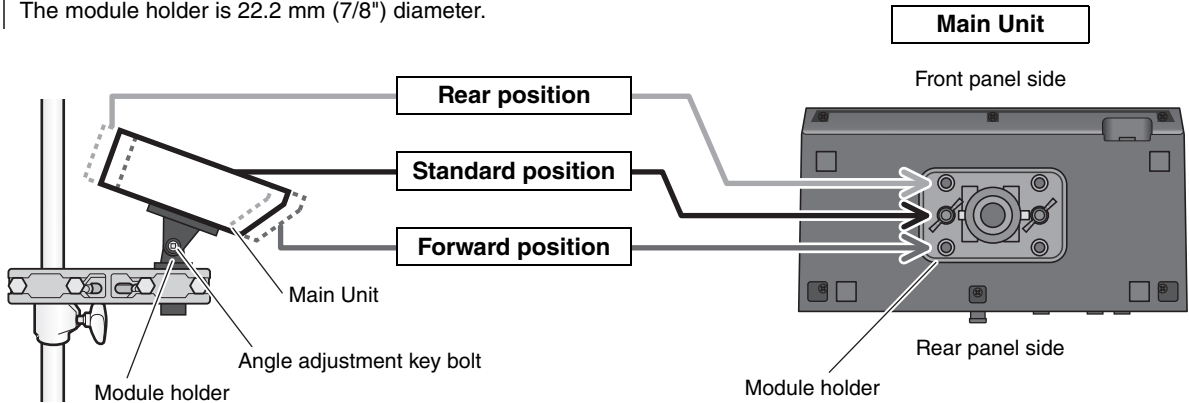

- We recommend positioning the Main Unit so that it is inside the outer edge of the cymbal when viewed from above to avoid hitting the Main Unit.**

Use a drum key (sold separately) on the Main Unit angle adjustment.

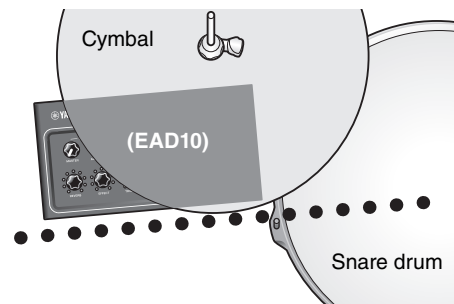

■ Connecting the Cables

Connect the straight plug to the Main Unit, and the L-shaped plug to the Sensor Unit.

Included Connector Cables

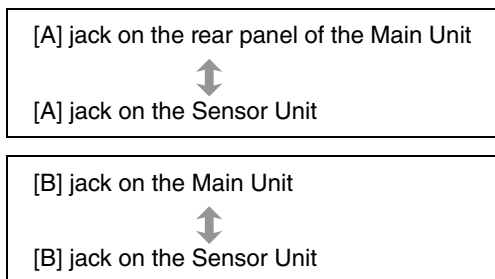

CAUTION
Do not connect or disconnect cables while the power is ON.

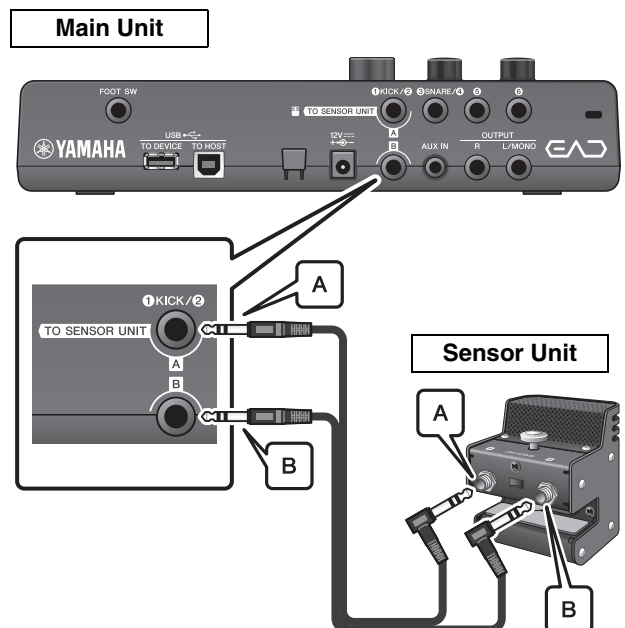

■ Taking Measures Against Noise

To eliminate the cause of the noise, adjust positions beforehand so that your toms do not touch the Sensor Unit or that the Connector Cables do not move around the Sensor Unit during your performance.

● Check the Sensor Unit Location

Make sure the Sensor Unit does not touch the toms or other instruments.

Example of poor placement

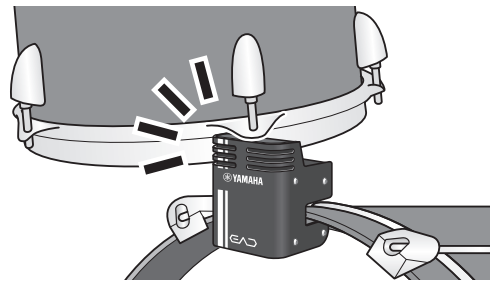

● Securing the Cables

Position the L-shaped plugs connected the Sensor Unit on their sides. This provides a more stable cable position.

Viewed from above

Viewed from the Sensor Unit jack side

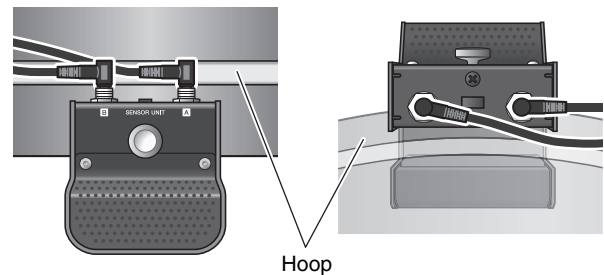

Use the Cable band to secure the Connector Cables close to the Sensor Unit.

Viewed from above

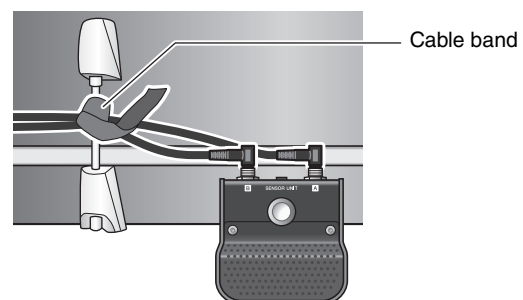

When mounting the Main Unit on a hi-hat stand, use the Cable band to keep the cables from interfering with the foot pedal.

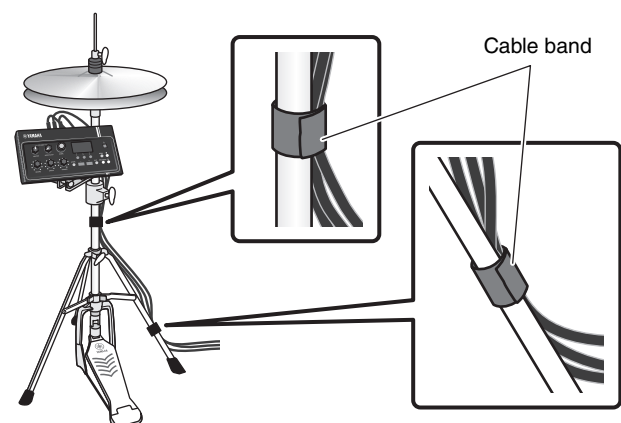

■ Connecting the AC adaptor

⚠ WARNING

Only use the specified AC adaptor (page 63). Using a different AC adaptor can cause malfunction, overheating, fire, and other problems. This may void the warranty so please take careful note.

⚠ CAUTION

Locate the Main Unit close to an AC outlet. If you notice any abnormalities during operation, turn the power off immediately and unplug the AC adaptor.

1. Make sure that the power is turned off (all panel lights and the screen backlight are off).



2. For removable plug type AC adaptors only: Make sure that the plug is not disconnected.

⚠ WARNING

- For AC adaptors with a removable plug, only use the AC adaptor with the plug attached, and keep the plug. Plugging only the plug into the power outlet can cause electric shock or fire.
- If the removable plug comes off from the AC adaptor, avoid touching the metal parts on the plug and slide the AC adaptor onto the plug until you hear it lock on to the adaptor with a click. Also, make sure you keep any foreign objects out of the plug. This can cause electrical shock, short circuit, or failure.

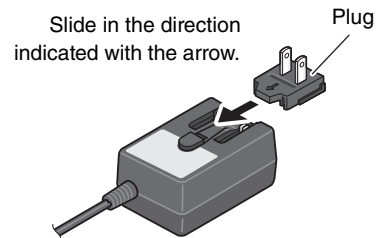

3. Connect the AC adaptor.

⚠ WARNING

Make sure to use the specified AC Adaptor.

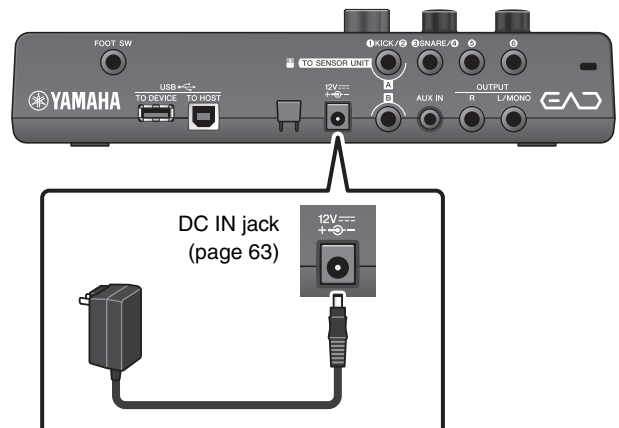

4. Hook the AC adaptor's cord around the cord hook to secure it in place.

⚠ CAUTION

Excessive bending can damage the AC adaptor cord and create a fire hazard. Ensure, therefore, that the power cord is not bent at an extreme angle when wrapped around the hook.

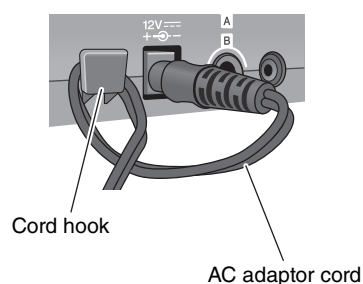

5. Plug the AC adaptor's AC plug into a domestic power outlet.

⚠ CAUTION

Even when the [⏻] (Standby/On) switch is in standby status (power lamp is off/display is off), electricity is still flowing to the instrument at the minimum level. When you are not using the EAD10 for a long period of time, make sure that you unplug the AC adaptor from the wall AC outlet.

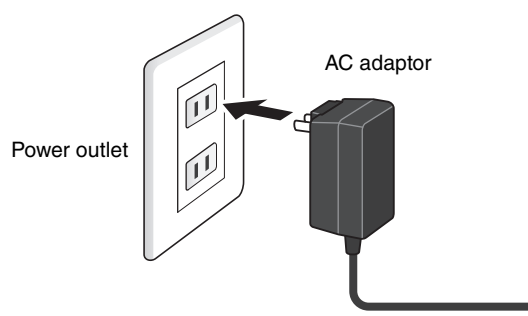

NOTE

When disconnecting the AC adaptor, turn the instrument and then carry out this procedure in reverse order.

■ Connecting Headphones

Connect the headphones to the [PHONES] jack.

⚠ CAUTION

Do not use headphones at high volume for an extended period of time. Doing so can cause loss of hearing.

NOTE

Please take note of the following if you are using open or semi-open headphones.

- Volume tends to sound louder because of the sound of the drums leaking into the headphones when playing.
- When recording or connected to a PA, the Click sound from the headphones may get mixed into your recording or PA system.

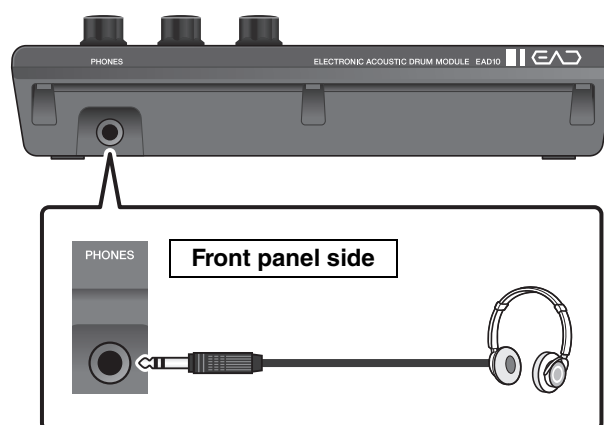

Connect with Other Devices and Expand the Fun

This section describes how to connect to a portable music player and PA system.

■ Connecting a Portable Music Player

You can play along with audio playback from a smartphone or portable music player.

NOTICE

Before making any connections, make sure volume levels on all devices are set at their minimum.

Connect the smartphone or portable music player to the [AUX IN] jack.

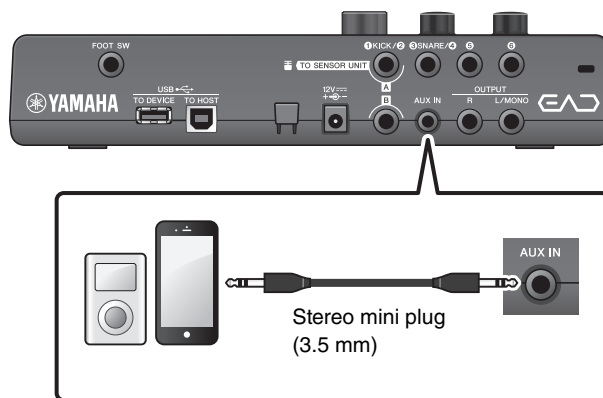

■ Connecting to a PA System

Connect the OUTPUT [R]/[L/MONO] jacks to the PA system.

CAUTION

- Acoustic feedback (a loud squeal or screech) may occur depending upon the position of the microphone and the proximity and direction of the speakers.
- Please note that Scenes using high-gain effects such as distortion or compression are more likely to cause feedback if the speakers are too close or pointed towards the drum set.

NOTICE

- Whenever connecting other devices, make sure that plugs on the cables you are using match the jacks on each device.
- Make sure the volume levels on all external devices are set at their minimum.
- When using the Main Unit with an external device for sound output, turn the Main Unit power on first, and then the power on the external device. When turning power off, do so in the reverse order. Not following the proper order can damage the equipment.

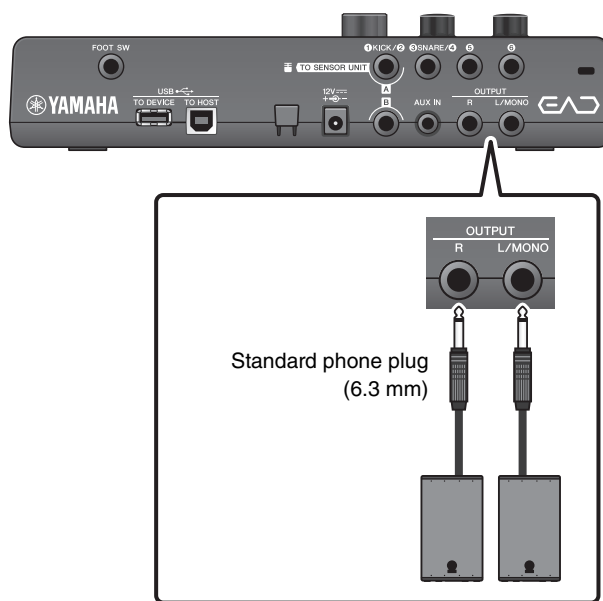

■ Connecting a Computer

If you have a computer and DAW software, connect the Main Unit to the computer and you can record your performance and listen to the playback from the computer. For more information, refer to the Reference Manual (Advanced) (PDF).

Precautions when using the [USB TO HOST] terminal

When connecting the computer to the [USB TO HOST] terminal, make sure to observe the following points. Failing to do so risks freezing the computer and corrupting or losing the data.

If the computer or the instrument freezes, restart the application software or the computer OS, or turn the power to the EAD10 off then on again.

NOTICE

- Use an AB type USB cable of less than 3 meters. USB 3.0 cables cannot be used.
- Before connecting a computer to the [USB TO HOST] terminal, disable any power-saving mode of the computer (such as suspend, sleep, or standby).
- Execute the following before turning the power to the instrument on/off or plugging/unplugging the USB cable to/from the [USB TO HOST] terminal.
 - Quit any open application software on the computer.
- While the computer is connected to the EAD10, you should wait for six seconds or more between these operations: (1) when turning the power of the EAD10 off then on again, or (2) when alternately connecting/disconnecting the USB cable.

Turning On or Off

■ Turning On

⚠ CAUTION

Do not reconnect cables between the Main Unit and Sensor Unit after turning the power on. Doing so will cause noise.

1. Turn the [MASTER VOLUME] knob fully counterclockwise to lower the Main Unit volume to its minimum.



2. Press the [⏻] (Standby/On) switch.

The startup screen appears in the LCD.



May differ from the actual specifications.

- 3. If you are connected to a PA system:
Turn the external speakers on.**

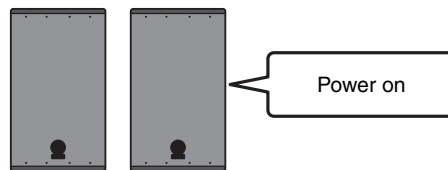

■ Turning Off

NOTICE

- The Main Unit automatically stores settings when the power is turned off, so do not unplug the AC adaptor until the LCD screen is turned off completely.
- Unsaved Scene data will be lost, so always save (Store) data before turning the power off.

- 1. If you are connected to a PA system:
Turn the external speakers off.**

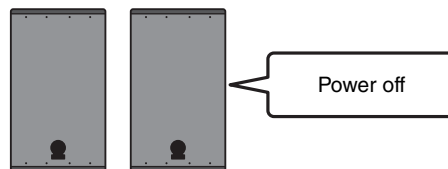

- 2. Turn the [MASTER VOLUME] knob fully counterclockwise to lower the volume to its minimum.**



- 3. Hold down the [⏻] (Standby/On) switch.**

The EAD10 is in Standby and the display and lights are off.



All off

Setting Up the Sensor Unit

■ About the Sensor Unit Settings

Adjust the gain and sensitivity settings for the Mic sensor and Trigger sensor built into the Sensor Unit. When you need to adjust the gain, you can also use the Auto Setting feature.

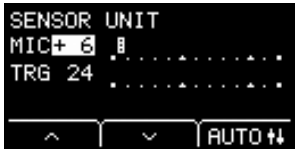
Setting	Screen display	Optimal condition
MIC (Mic gain)		The level should occasionally reach to the right and the [EXIT] (Sensor Unit) button lights by striking all the instruments in the drum set.
TRG (Trigger gain)		The level should reach to the right when the bass drum is struck loudly

■ Setting the Sensor Gain Automatically

1. Press the [EXIT] (Sensor Unit) button.

The SENSOR UNIT screen appears.

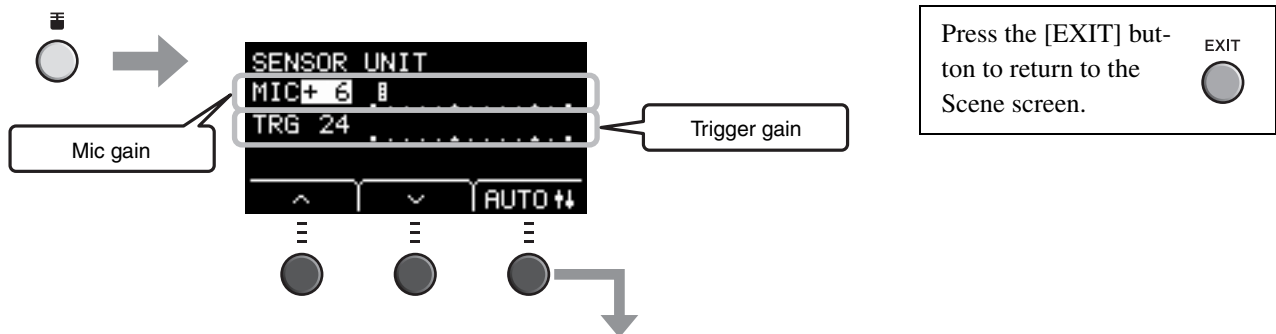

Setting Up Automatically

2. Press the button below "AUTO" ([F3]).

3. Strike each of the instruments in the drum set with an 8-beat rhythm.

The setting is complete after about 10 seconds of playing the drums.

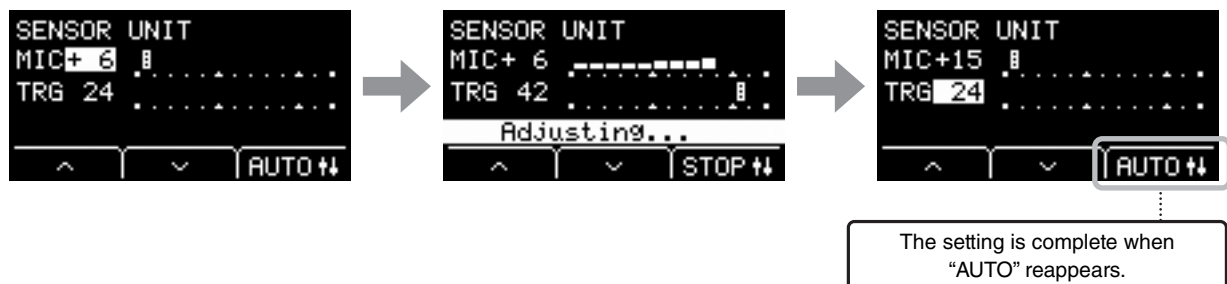

If you want to stop the Auto Setting before completion, press "STOP."

NOTE

Detection may fail in some cases, particularly if there is background noise. When detection fails, try the Auto Setting several times. Fine adjustments should be done manually. If the Auto setting is not successful after several attempts, adjust manually.

Manually Adjusting the Sensor Unit Settings

1. Press the [EXIT] (Sensor Unit) button.

The SENSOR UNIT screen appears.

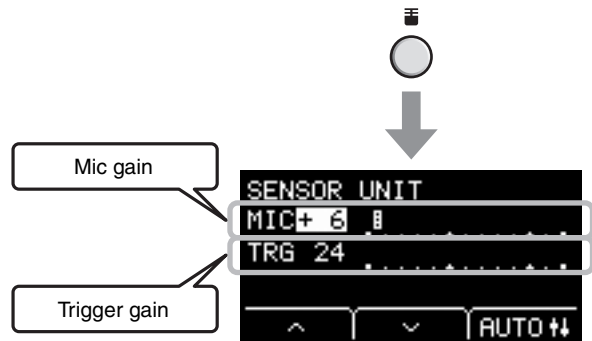
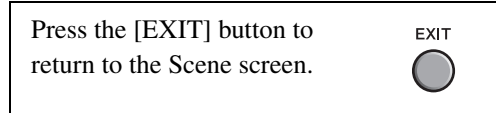

2. Use the buttons below “^” or “v” ([F1] or [F2]) to move the cursor.

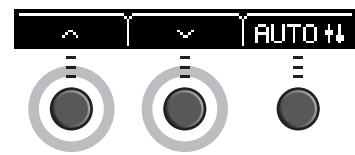

3. Use the [-] or [+] buttons to adjust the value.



Setting Finer Adjustments

1. With the SENSOR UNIT screen displayed, press the button below “v” ([F2]).

The SENSOR UNIT (fine adjustment) screen opens.

TRG SENS (Trigger Sensitivity)	Sensitivity for light strokes	The larger the value, the louder the sound produced when struck lightly. NOTE • If this is set too low, the Trigger sound might not be played. • If this is set too high, the snare drum or toms might trigger the bass drum Trigger Sound when hit.
[L]	Mic gain left	Adjust the L and R settings when the volume balance between the left and right Mics is poor. NOTE The same value is displayed in the [L] setting in the SENSOR UNIT (fine adjustment) screen and in the “MIC” setting in the SENSOR UNIT screen.
[R]	Mic gain right	

SENSOR UNIT screen

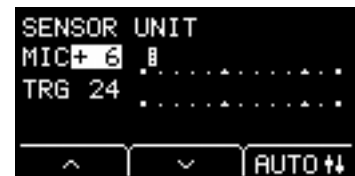

SENSOR UNIT (fine adjustment) screen

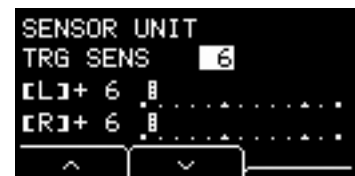

2. Use the buttons below “^” or “v” ([F1] or [F2]) to move the cursor.

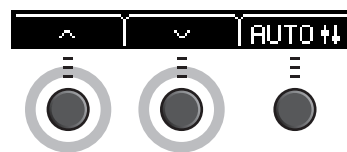

3. Use the [-] or [+] buttons to adjust the value.



Changing the Overall Settings

■ Auto Power-Off

The Auto Power-Off function automatically turns off the Main Unit after a certain period of inactivity. The factory default is set at 15 minutes.

NOTICE

- Unsaved data is lost when the Main Unit is turned off with the Auto Power-Off function. Always store data before turning the power off.
- In certain modes of operation, the Auto Power-Off function will not turn off the Main Unit when the set time has elapsed. So we recommend that you always turn off the Main Unit manually when you are finished using it.
- If you expect the Main Unit to be inactive for a certain length of time while connected to external audio equipment or a PA, we recommend fully lowering the volume on the external equipment. Alternatively, you can disable the Auto Power-Off function to ensure that the Main Unit stays on.

NOTE

To set the Auto Power-Off to a time other than 15 minutes, access the setting from the [MENU] button. (MENU/Utility/General)

● Auto Power-Off Quick Cancel

While holding down the [STORE] button, press the [⏻] (Standby/On) button to cancel the Auto Power-off. The function will remain off until you set a new Auto Power-Off time.

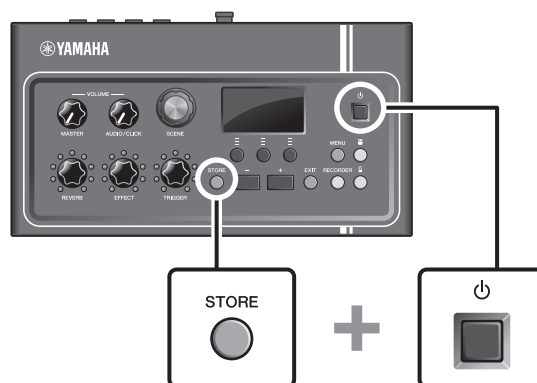

■ Restoring Main Unit Settings to the Factory Defaults (Factory Reset)

Use the Factory Reset function to restore the Main Unit's settings to their factory defaults, even if you have accidentally overwritten them.

NOTICE

A factory reset overwrites any settings you have made with the corresponding factory defaults. Save any important user-defined data to a USB flash drive before carrying out a factory reset. For more information, refer to the Reference Manual (Advanced) (PDF). (MENU/File)

● Performing a Factory Reset

While holding down the [-] and [+] buttons, press the [⏻] (Standby/On) button to perform the factory reset.

NOTE

You can also access the factory reset with the [MENU] button.

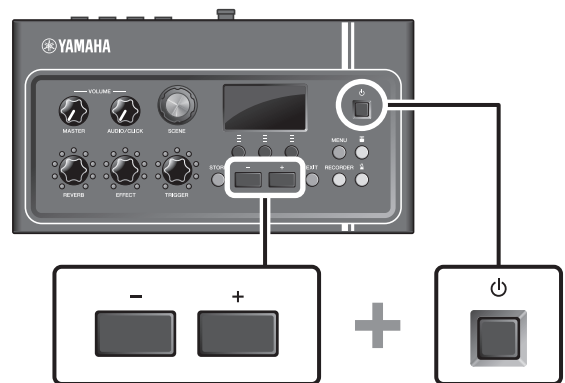

Using a USB Flash Drive

Connect a USB flash drive to the [USB TO DEVICE] terminal on the rear panel of the Main Unit and record your performance directly to the USB flash drive. Also, you can save Main Unit settings to and load settings from a USB flash drive.

■ Connecting a USB Flash Drive to the Main Unit

Precautions When Using the [USB TO DEVICE] Terminal

When connecting a USB device to the terminal, be sure to follow the important precautions below.

NOTE

For more information about the handling of USB flash drives, refer to the owner's manual of your USB flash drive.

● Compatible USB Devices

USB flash drives only

Please check the URL shown below for a list of compatible USB flash drives.

<https://download.yamaha.com/>

NOTE

- Other USB devices such as USB hub, mouse, computer keyboard, cannot be used.
- A USB cable cannot be used to connect a USB device to the [USB TO DEVICE] terminal.

NOTICE

The rating of the [USB TO DEVICE] terminal is a maximum of 5 V / 500 mA. Do not connect USB devices having a rating above this, since this can cause damage to the instrument itself.

● Connecting a USB Flash Drive

When connecting a USB device to the [USB TO DEVICE] terminal, make sure that the connector on the EAD10 is appropriate and that it is connected in the proper direction. The EAD10 conforms to the USB 1.1 specification. USB 2.0 and USB 3.0 flash drives can also be used. However, the transfer speed is equivalent to the USB1.1 specification.

NOTICE

- Avoid connecting or disconnecting the USB device during playback/recording and file management operations (such as Save, Copy, Delete, and Format), or when accessing the USB device. Failure to observe this may result in “freezing” of the operation of the instrument or corruption of the USB device and the data.
 - When connecting then disconnecting the USB device (and vice versa), make sure to wait a few seconds between the two operations.
-

● Formatting the USB Flash Drive

Some USB flash drives should be formatted with this instrument before they can be used. For information on how to format the USB flash drive, refer to the Reference Manual (Advanced) (PDF). (MENU/File/Format)

NOTICE

The format operation erases any previously existing data. Make sure that the USB flash drive you are formatting does not contain any important data.

● To Protect Your Data (Write Protection)

To prevent important data from being inadvertently erased, write-protect the USB flash drive. When you are saving data to the USB flash drive, make sure you disable the write-protect first.

Basic Guide

Performing with Various of Scenes

■ What is a Scene?

A Scene consists of a group of assigned settings for Reverb, Effects, and Trigger Sounds. The Main Unit includes preset Scenes you can select to change the overall sound.

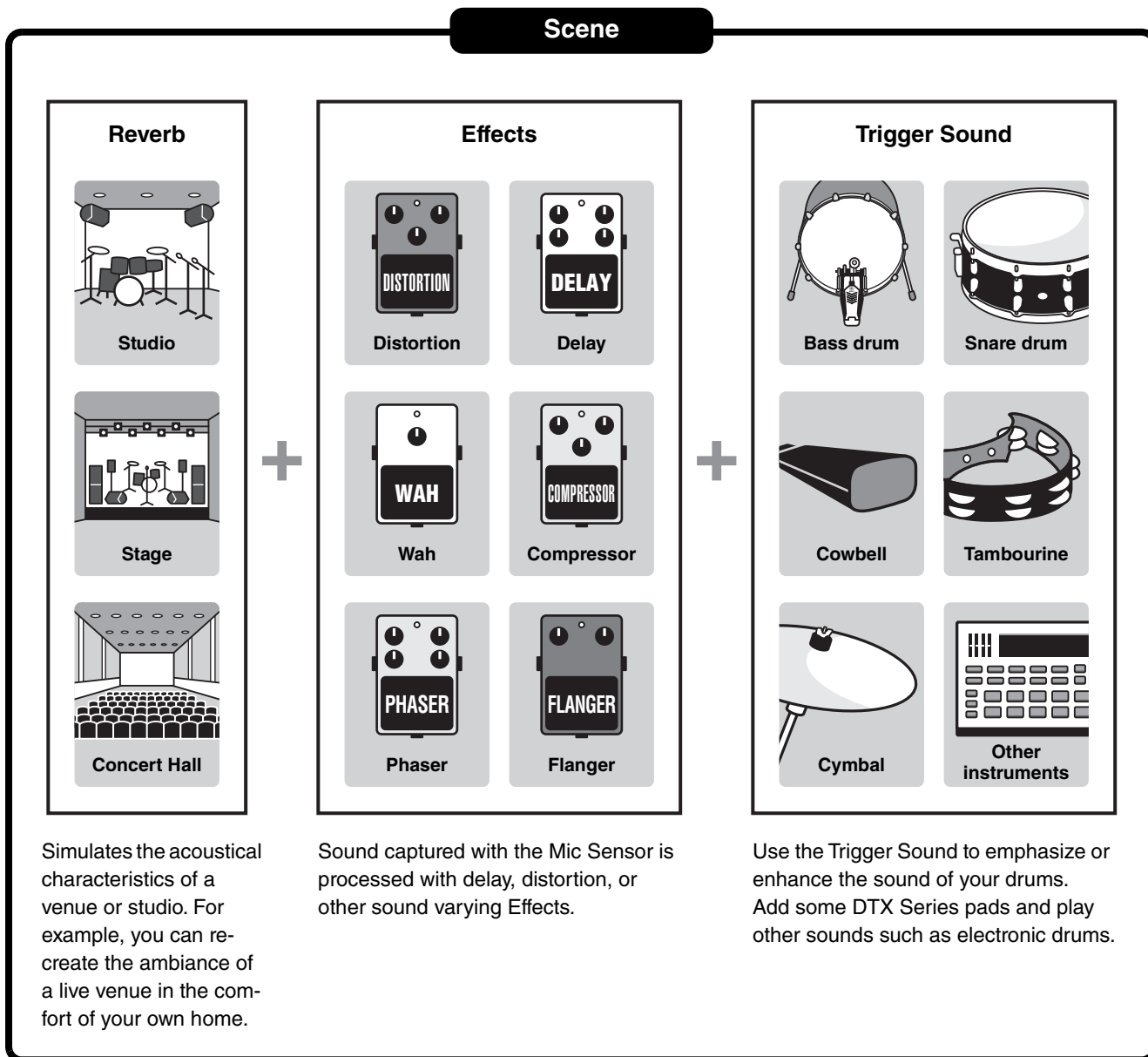

Also, you can save Scene settings as User Scenes, and recall User Scenes by turning the [SCENE] knob. (page 35)

For live use, you can sort and save Scenes in any order then recall Scenes by turning the [SCENE] knob or hitting a pad. For more information, refer to the Reference Manual (Advanced) (PDF). (MENU/Job/Scene, MENU/Utility/PadFunction)

Basic Scene Operation

Switches the Scene type.
Returns you to the Scene Screen from other screens.

NOTE

When in the screens listed below, the knob can be used like the [-] and [+] buttons without returning to the Scene Screen.

- Screens such as Store where it is used for selecting a Scene Number
- Screen for entering a name

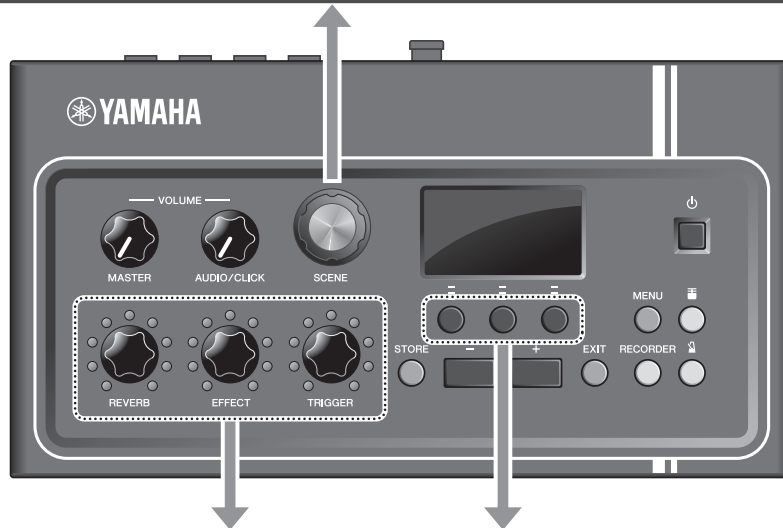

Adjusts the volume of
Reverb, Effect, or Trigger Sound

Changes the type of
Reverb, Effect, or Trigger Sound

How to Read the Scene Screen

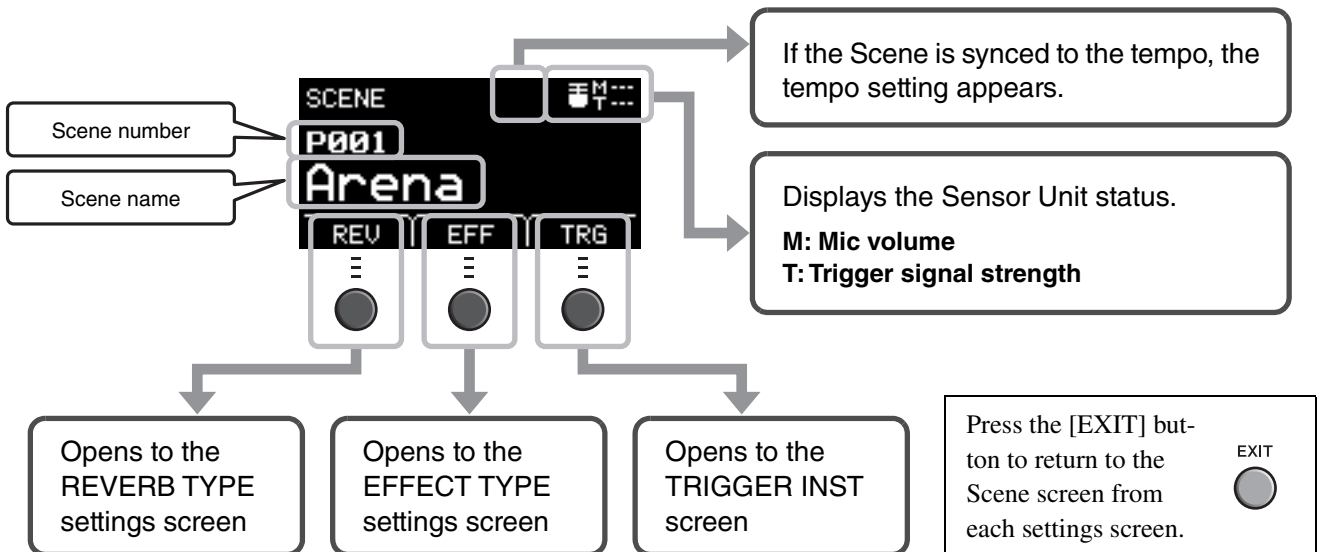

NOTICE

About the “**E**” mark:

The **E** mark appears in the upper left of the screen when a Scene’s settings have been changed. This is to remind you that Scene settings have changed but have not yet been saved (Store). The mark disappears when you store the settings (page 37). When you select another Scene without first storing the settings, the changes will be lost.

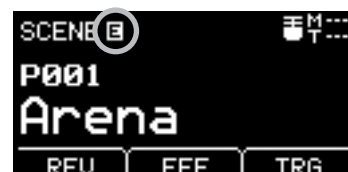

■ Selecting a Scene

1. Rotate the [SCENE] knob.

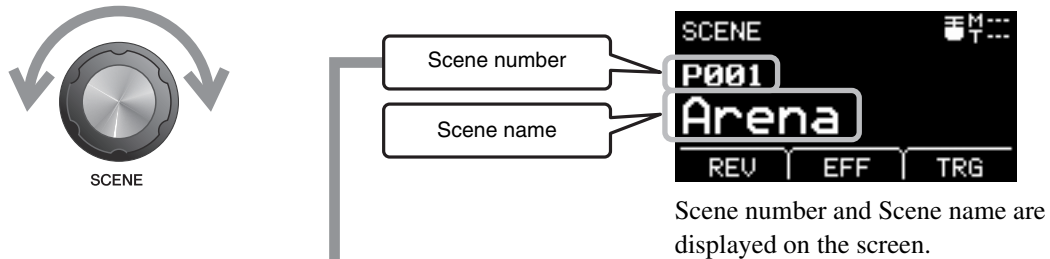

P*:** Preset Scene (Presets that are already stored in the EAD10)

U*:** User Scene (Scene you have created)

NOTE

When you select another Scene before storing the Scene being edited, you can use the recall function to recall the edited contents. For more information, refer to the Reference Manual (Advanced) (PDF) (MENU/Job/Scene/Recall).

■ Adjusting Scenes

● Adjusting Reverb and Effect Levels and Trigger Sound Volume

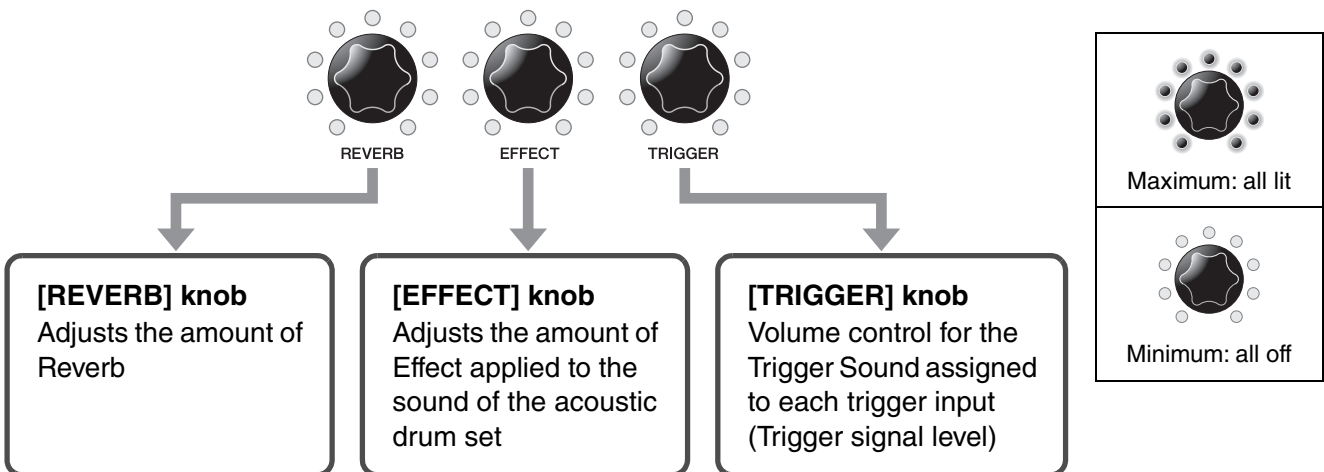

After editing a Scene, your edits will be lost if you select another Scene before saving (Storing) the edits.

Creating Your Own Scene

You can customize preset Scenes to create your own Scene.



NOTE

To check the Trigger Sound, turn the [TRIGGER] knob clockwise to increase the volume.

Changing the Reverb Type

1. Press the button below "REV" ([F1]).

The REVERB TYPE screen opens.



2. Use the [-] or [+] buttons to select the Reverb type you want to use.



Changing the Effect Type

1. Press the button below "EFF" ([F2]).

The EFFECT TYPE screen opens.



2. Use the [-] or [+] buttons to select the Effect type you want to use.



Use the "⏮" ([F1]) and "⏭" ([F2]) buttons to change the tempo for tempo synced Effects.



Changing the Trigger Sound

- Changing the Trigger Sound on the Bass Drum (Set as a Factory Default)

1. Press the button below "TRG" ([F3]).

The TRIGGER INST screen opens.



Trigger Sound name

Trigger Sound number

2. Use the [-] or [+] buttons to select the number for the Trigger Sound you want to use.



About the "BYPASS"

In each screen, selecting "BYPASS" ([F3]) causes the corresponding knob lamps to dimly flash and the Effect not applied. Each press of the [F3] button turns the bypass setting on or off. When you select "BYPASS" while the knob is turned fully to the minimum position, the two lamps below the knob dimly flash.



■ Advanced Trigger Sound Settings

When you attach a Drum Trigger on the snare drum, or add a DTX series pad, you need to assign a Trigger Sound to each device to play Trigger Sounds. This section describes how to change instrument categories to assign different Trigger Sounds, how to audition Trigger Sounds, and how to turn off the Trigger Sound by switching the “BYPASS” setting.

1. Press the button below “TRG” ([F3]).



Switching the Pad

Strike the separately sold add-on pad to select the pad whose sound you want to change.

Make sure that the pad name in the upper right corner of the screen has changed.

The TRIGGER INST screen opens.

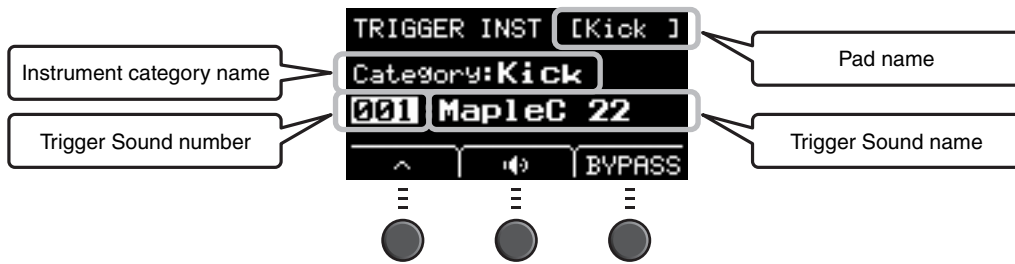

Switching the Instrument Category

2. Press the button below “^” ([F1]) to move the cursor to “Category” (instrument category name).
3. Use the [-] or [+] buttons to select the instrument category you want to use.



Next, move the cursor to Trigger Sound number using the same procedure described in step 2, then select a Trigger Sound using the same procedure as in step 3.

Auditioning Sounds

2. Press the button below “speaker icon” ([F2]).
You can listen to the Trigger Sound.

If you want to make more precise changes to the settings, press the [MENU] button to make detailed settings. For more information, refer to the Reference Manual (Advanced) (PDF). (MENU/Scene Edit/Inst or MENU/Scene Edit/Voice)

■ Using Imported Sounds (.wav)

You can import audio files (.wav) into the EAD10 to use as Trigger Sounds.

For more information on importing audio files and settings, refer to the Reference Manual (Advanced) (PDF). (MENU/Job/Wave)

For more information on using a USB flash drive, see “Using a USB Flash Drive” (page 30).

■ Saving a Scene Under a New Name

1. Press the [STORE] button.

The STORE screen opens.

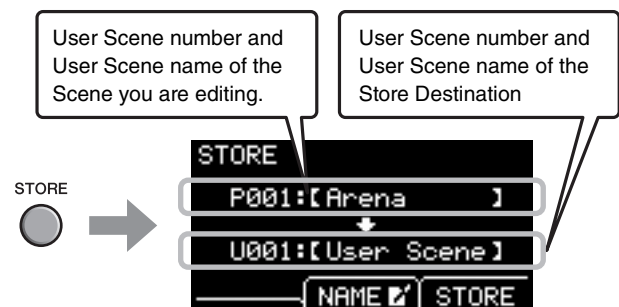

2. Press the button below “NAME” ([F2]) to open the NAME screen.



3. Use the buttons below “<” or “>” ([F1] or [F3]) to select the character position, then use the [-] or [+] buttons to select a letter.

A name of up to 10 characters can be set to the Scene.

NOTE

You can also use the [SCENE] knob to select characters.

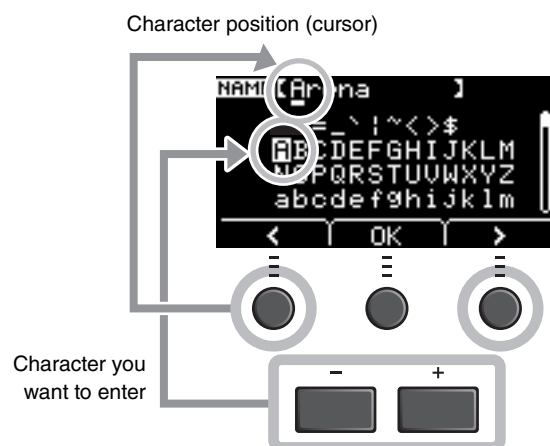

4. After entering all characters, press the button below “OK” ([F2]) and return to the STORE screen.



5. Use the [-] or [+] buttons to select a User Scene Number to store your Scene to.



NOTE

You can also use the [SCENE] knob to make changes.

6. After confirming the new Scene Number and Scene Name, press the button below “STORE” ([F3]).

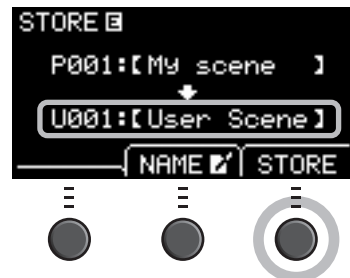

NOTE

You cannot save an edited Scene to a Preset Scene.

NOTICE

When overwriting a Scene, the current Scene settings are replaced with the new settings. Before overwriting a Scene, ensure that the Scene contains no irreplaceable settings.

“Overwrite?” appears when the selected Scene Number already contains a Scene.

If you want to overwrite to save the Scene, press the button below “YES” ([F1]).

If you do not want to overwrite, press the button below “NO” ([F3]) and return to the previous screen where you can select another Scene number.

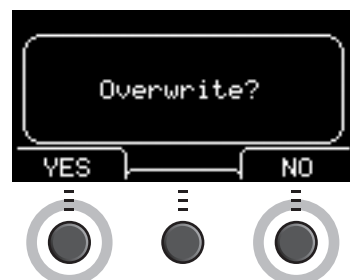

When the Store operation is complete, the display returns to the Scene screen.

Using the Click (Metronome)

Set the Click (Metronome) tempo, volume, type of sound, etc.

1. Press the [] (Click) button.

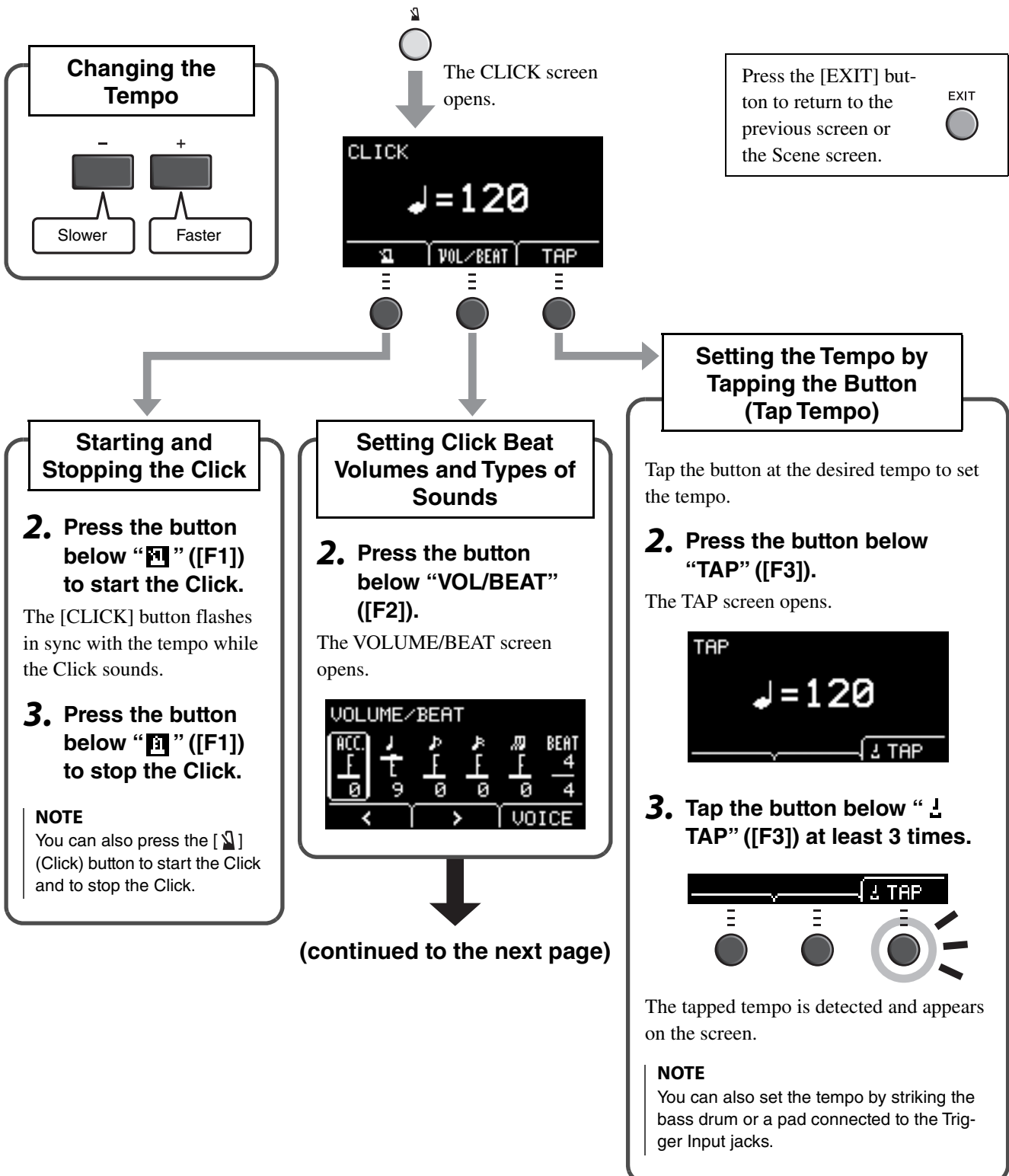



(continued from the previous page)

VOLUME/BEAT screen



Set the volume					Set the time signature
ACC.	♩	♪	♫	♩	BEAT
Accents	Quarter notes	Eighth notes	Sixteenth notes	Eighth note triplets	Beats (1/4–16/4, 1/8–16/8, 1/16–16/16)

3/8, 6/8, 9/8, 12/8, 15/8 beats only have settings for Acc, dotted quarter, eighth, and sixteenth notes.

Setting Individual Click Beat Volumes

- Use the buttons below “<” or “>” ([F1] or [F2]) to move the cursor.
- Use the [-] or [+] buttons to adjust the volume.



Changing the Click Sounds

- Press the button below “VOICE” ([F3]). The CLICK VOICE screen opens.



- Use the [-] or [+] buttons to change the Click Sound.



Recording Your Performance

Use the EAD10 to record your performance. When a USB flash drive is connected to the unit, audio is recorded to the USB flash drive.

■ Recording to the Main Unit (when no USB flash drive is connected to the terminal)

1. Press the [RECORDER] button.

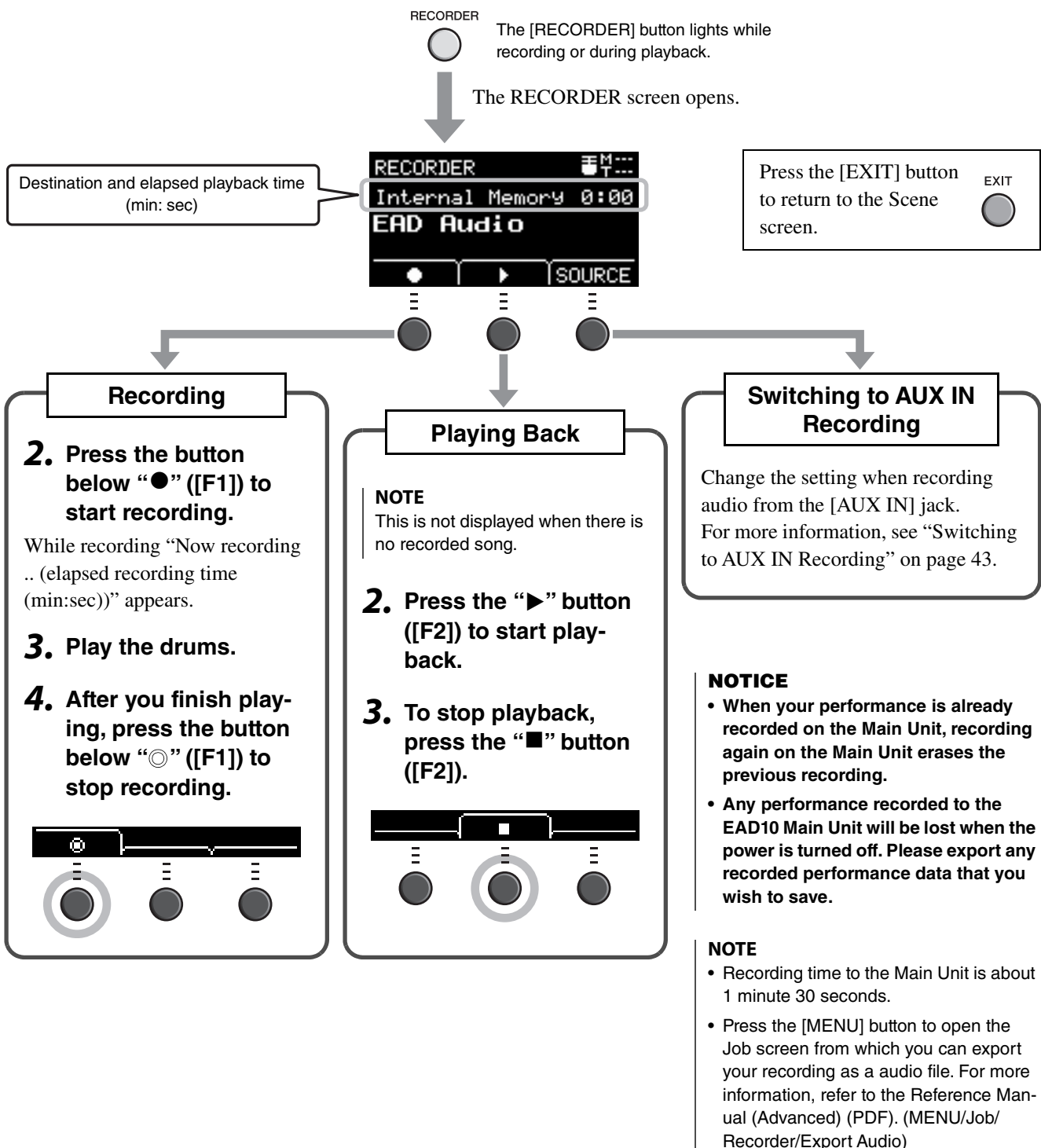

Recording to a USB Flash Drive

1. Connect a USB flash drive to the [USB TO DEVICE] terminal on the rear panel.

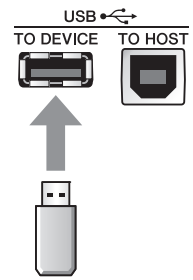

When a USB flash drive is connected

- You can record up to 30 minutes at a time.
- A new file is created every time you record.
- Simultaneously press Playback and Record to overdub your performance onto the currently playing song.

2. Press the [RECORDER] button.

Press the [EXIT] button to return to the Scene screen.

EXIT

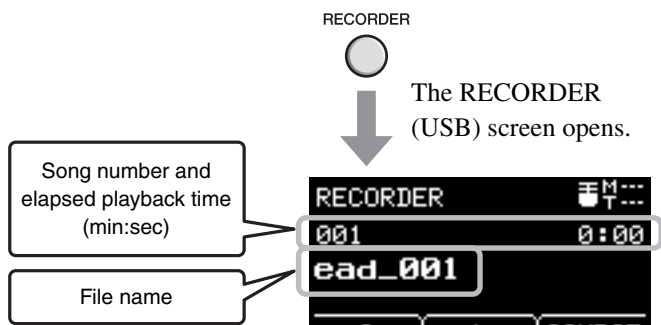

Switching to AUX IN Recording

Change the setting when recording audio from the [AUX IN] jack. For more information, see “Switching to AUX IN Recording” on page 43.

Recording

3. Press the button below “●” ([F1]) to start recording.

While recording “Now recording .. (elapsed recording time (min:sec))” appears.

4. Play the drums.

5. After you finish playing, press the button below “○” ([F1]) to stop recording.

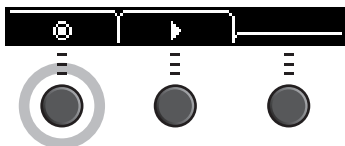

The RECORDER SAVE screen opens.



6. Press the button below “SAVE” ([F3]) and save the file.

Press the button below “CANCEL” ([F2]) if you do not want to save the file.

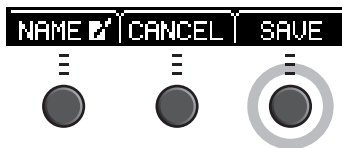

NOTE

If you want to change the file name, press the button below “NAME” ([F1]) and enter a new name. (page 37)

Playing Back

NOTE

This is not displayed when there is no recorded song.

3. Use the [-] or [+] buttons to select a song for playback.



NOTE

Up to 100 songs are recognized.

4. Press the button below “▶” ([F2]) to start playback.

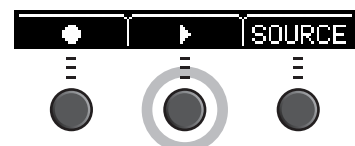

5. Press the button below “■” ([F2]) to stop playback.

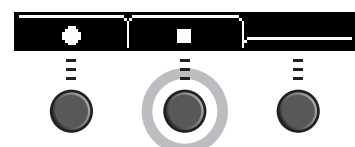

■ Switching to AUX IN Recording

The Input Source must be changed to record from the [AUX IN] jack.

1. Press the [RECORDER] button.



2. Press the button below "SOURCE" ([F3]).

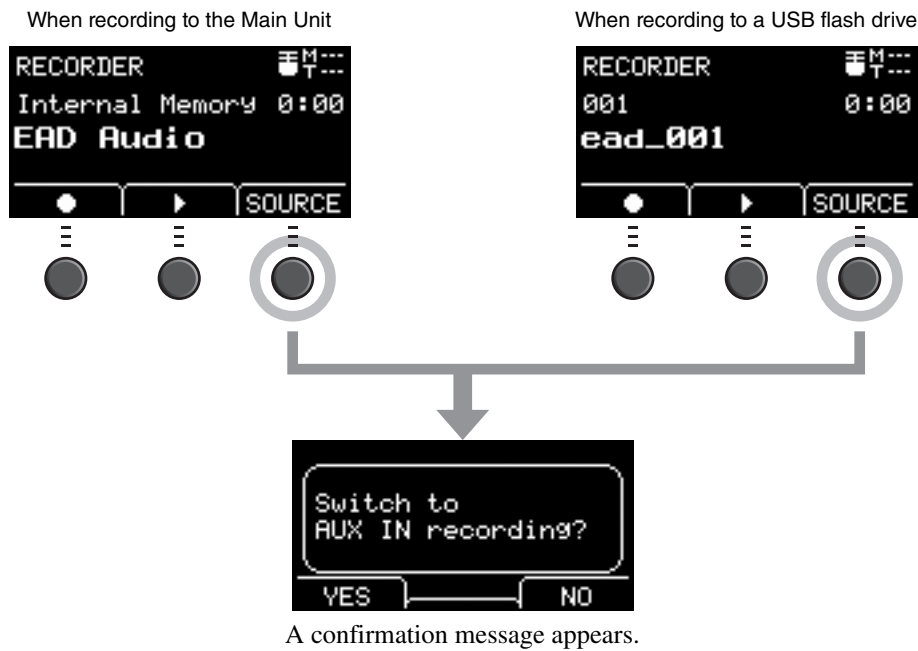

3. Press the button below "YES" ([F1]).

The setting is changed to the AUX IN recording.

NOTE

Your performance does not sound and is not recorded while in AUX IN recording.



After you finish recording, the EAD10 returns to the normal record settings.

■ Overdub Recording Your Performance onto an Accompaniment Song

You can overdub your performance onto a accompaniment song that you've imported onto a USB flash drive and save your performance combined with the accompaniment song as a single audio file.

NOTE

If you play along to a track coming into the Aux Input, only your performance will be recorded.

● Preparing an Accompaniment Song (Audio File)

• Importing from a Computer

Save the audio file (.wav file) from the computer to the root directory on a USB flash drive.

Audio file requirements: 16-bit, 44.1 kHz, stereo, wav format

NOTE

- Some of the audio files may not play back even when the above requirements are met.
- The EAD10 does not recognize the audio file if it is in a folder.

• Importing from the [AUX IN] Jack

Connect a portable music player or other such device to the [AUX IN] jack on the rear panel, and have the song ready for playback.

Recording the Accompaniment Song

- 1. Connect the USB flash drive to the [USB TO DEVICE] terminal on the rear panel, then connect a portable music player to the [AUX IN] jack.**

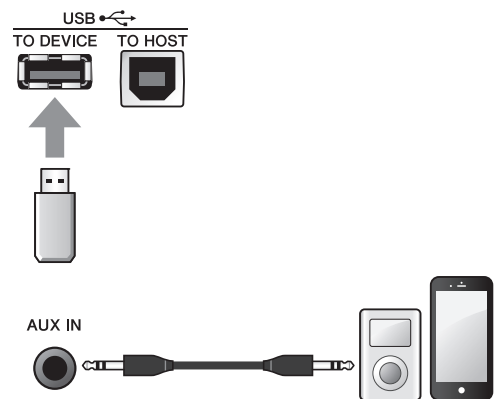

- 2. Press the [RECORDER] button.**

The RECORDER (USB) screen opens.



3. Press the button below “SOURCE” ([F3]).

The “Switch to AUX IN recording?” confirmation screen appears.

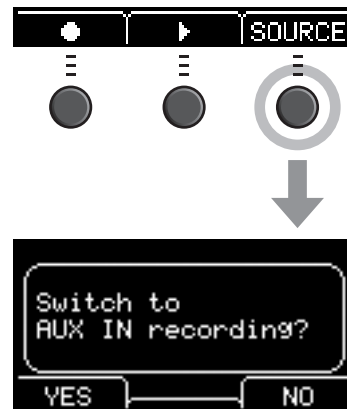

4. Press the button below “YES” ([F1]), to switch to AUX IN Recording.

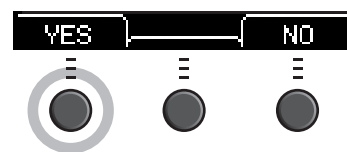

5. Press the button below “●” ([F1]) on the EAD10 to start recording, and simultaneously press Playback on the portable music player to start playback of the accompaniment song.

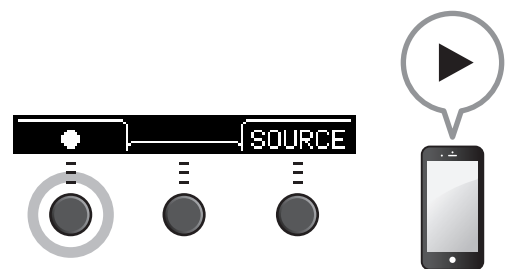

6. After the song playback finishes, press the button below “◎” ([F1]) to stop recording.

The RECORDER SAVE screen opens.



7. Press the button below “SAVE” ([F3]), and save the file.

Press the button below “CANCEL” ([F2]) if you do not want to save the file.



NOTE

If you want to change the file name, press the button below “NAME” ([F1]) and enter a new name. (page 37)

By doing this, the external song you have just recorded is on the USB flash drive, ready for you to use.

● Recording Yourself Playing Along with the Accompaniment Song

1. Use the [-] or [+] buttons to select the accompaniment you have prepared.



2. Press the button below “●” ([F1]) and the button below “▶” ([F2]) to start recording and playback.

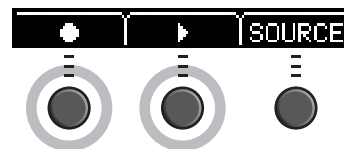

3. Play the drums.

4. After you finish playing, press the button below “○” ([F1]) to stop recording.

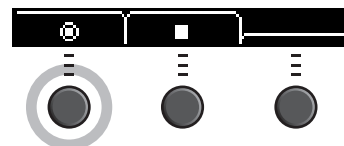

NOTE

Pressing the button below “■” ([F2]) stops accompaniment playback, but recording continues.

You have now just recorded yourself over the song on the USB flash drive.

■ Recording with Smart Device Apps

NOTE

To eliminate the risk of interference due to noise by your iPhone or iPad when used in combination with the EAD10, turn on the Airplane Mode and then turn on Wi-Fi.

NOTICE

Be sure to place your iPhone or iPad on a stable surface to prevent it from falling over and being damaged.

Using apps compatible with the EAD10 provides greater convenience and a more enjoyable user experience. For more information on how to connect, refer to the “iPhone/iPad Connection Manual” (PDF) available at the Yamaha website.

For details on compatible smart devices and applications, refer to the web page below.

<https://download.yamaha.com/>

■ Recording to a Computer

You can connect to a computer and use DAW software to record your performance.

What is DAW Software?

DAW is an abbreviation of Digital Audio Workstation and refers to applications such as Cubase that let you record, edit, and mix audio on a computer.

For more information on how to connect a computer, refer to the Reference Manual (Advanced) (PDF). For more information on how to use the DAW software, refer to the Owner’s Manual for your DAW software.

Application Guide

Enhance Your Drum Set with Separately Sold Add-Ons

You can connect add-ons (sold separately) to the Main Unit's Trigger Input jacks or Footswitch jack and play Trigger Sounds or switch functions.

Here are some of the things you can do with separately sold add-ons.

Connecting to the [1]KICK/[2]-[6] Jacks

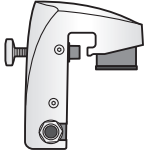
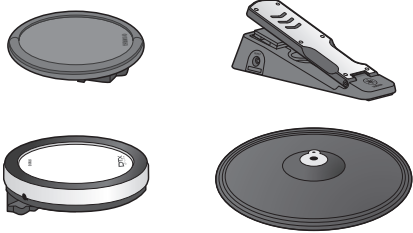
Separately sold add-ons	Main applications
Drum Trigger 	<ul style="list-style-type: none">● Attach a drum trigger to an acoustic drum and trigger a sound from the EAD10 (including your own samples) whenever the drum is played. The EAD10 will change the volume of the sound depending on how hard you play.
Pad (*1) 	<ul style="list-style-type: none">● Play the EAD10 like an electronic drum module.● The pads can also be used to perform in other ways such as kit switching, turning functions on and off and many others.

→ page 50

→ page 52







(*1) About the Pads

Within this Owner's Manual, the separately sold external pads that may be connected to the EAD10 are referred to by model name. Please note that these model names were up-to-date as of printing of this manual. Details regarding any subsequently released models will be made available via the following web site.

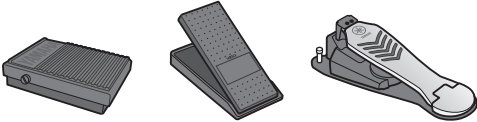
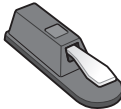
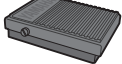
<https://download.yamaha.com/>

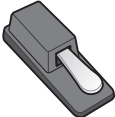
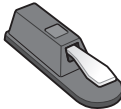
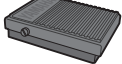
* Yamaha Corporation reserves the right to modify this URL at any time without prior notice.

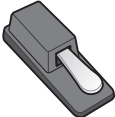
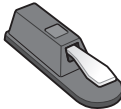
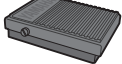
Connecting to the [FOOT SW] Jack

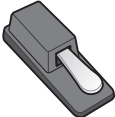
Separately sold add-ons	Main applications								
<p>Pedal</p>  <p>→ page 54</p>	<ul style="list-style-type: none"> ● Switch functions ● Play Trigger Sounds <p>Choose the pedal that best fits your needs.</p> <table border="1"> <tbody> <tr> <td data-bbox="813 537 1133 716"> <ul style="list-style-type: none"> ● Switch on or off <p>FC4 </p> </td> <td data-bbox="1133 537 1452 716"> <p>FC5 </p> </td> </tr> <tr> <td colspan="2" data-bbox="813 716 1452 896"> <ul style="list-style-type: none"> ● Adjust volume (keeps its position when released) <p>FC7 </p> </td> </tr> <tr> <td colspan="2" data-bbox="813 896 1452 1108"> <ul style="list-style-type: none"> ● Switch on or off ● Play Trigger Sounds <p>HH65 </p> </td> </tr> <tr> <td colspan="2" data-bbox="813 1108 1452 1373"> <ul style="list-style-type: none"> ● Switch on or off ● Adjust volume (pedal returns when released) ● Play Trigger Sounds <p>FC3 </p> </td> </tr> </tbody> </table>	<ul style="list-style-type: none"> ● Switch on or off <p>FC4 </p>	<p>FC5 </p>	<ul style="list-style-type: none"> ● Adjust volume (keeps its position when released) <p>FC7 </p>		<ul style="list-style-type: none"> ● Switch on or off ● Play Trigger Sounds <p>HH65 </p>		<ul style="list-style-type: none"> ● Switch on or off ● Adjust volume (pedal returns when released) ● Play Trigger Sounds <p>FC3 </p>	
<ul style="list-style-type: none"> ● Switch on or off <p>FC4 </p>	<p>FC5 </p>								
<ul style="list-style-type: none"> ● Adjust volume (keeps its position when released) <p>FC7 </p>									
<ul style="list-style-type: none"> ● Switch on or off ● Play Trigger Sounds <p>HH65 </p>									
<ul style="list-style-type: none"> ● Switch on or off ● Adjust volume (pedal returns when released) ● Play Trigger Sounds <p>FC3 </p>									

NOTE

- In this manual, the term “FC3” refers to the FC3 and all other equivalent products, such as the FC3A.
- In this manual, the term “FC4” refers to the FC4 and all other equivalent products, such as the FC4A.

* May not be available depending on your area. Check with your Yamaha dealer.

■ Using Drum Triggers to Play Trigger Sounds with Your Acoustic Drums (with Drum Triggers)

Attach a Drum Trigger (sold separately) to the snare drum or tom, and connect the Drum Trigger to the Main Unit, you can play Trigger Sounds according to the timing and intensity of each stroke. For example, layer internal drum sounds to enhance the sound, or layer other instrument sounds like percussion or sound effects.

Drum Trigger Connection Examples

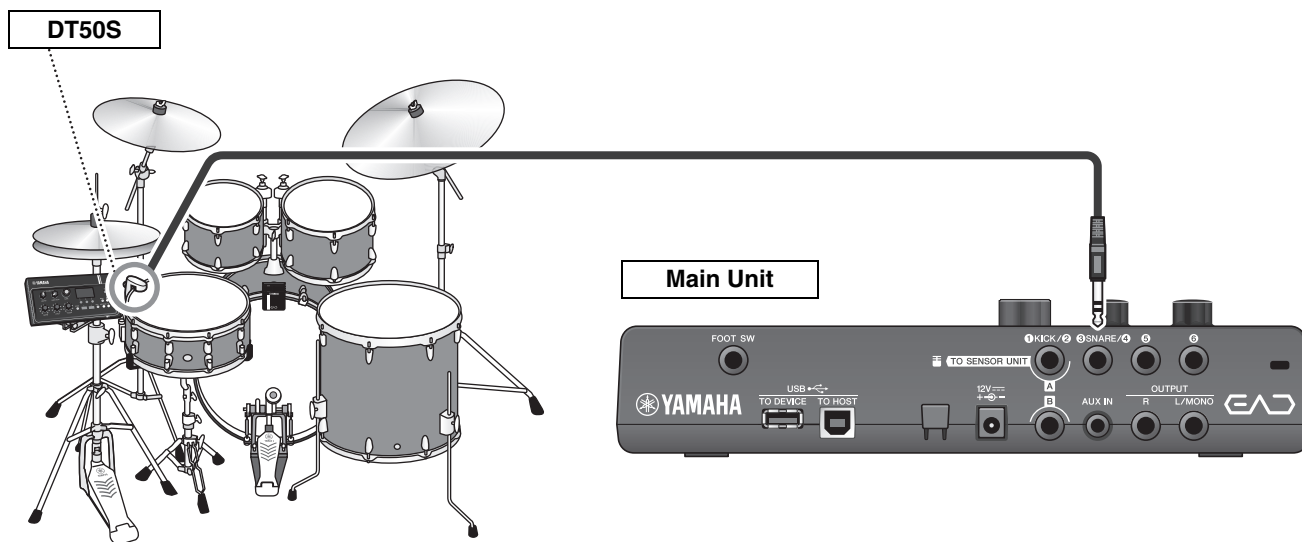

● Procedure: Example) Connecting a DT50S Drum Trigger

1. Turn off the Main Unit.

Make sure the Main Unit is turned off before connecting.



2. Attach the DT50S between two of the tension rods on the snare drum.

NOTE

Position the Drum Trigger far from the drummer to prevent it from being struck accidentally.

For more information, refer to the DT50S Owner's Manual.

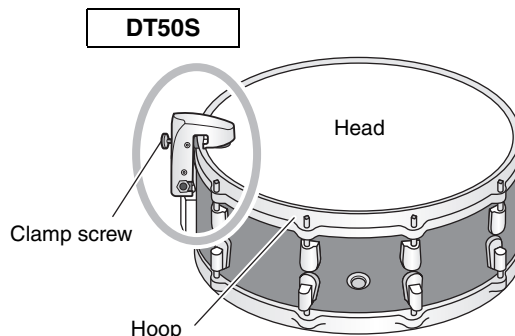

- 3. Connect the DT50S to the [3 SNARE/4] jack on the Main Unit rear panel.**

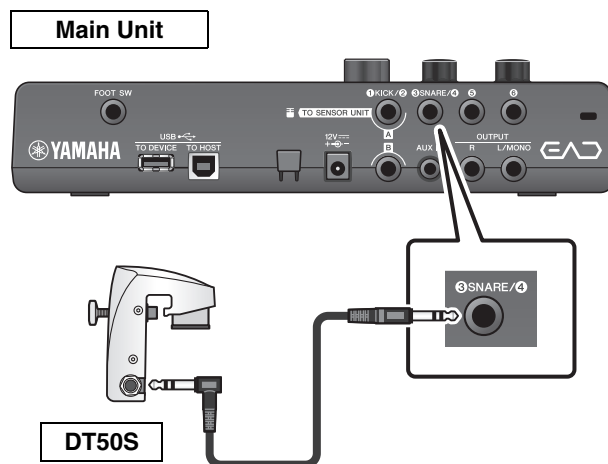

- 4. Press the [MENU] button to make necessary settings for using DT50S.**

When the DT50S is connected to the [3 SNARE/4] jack, settings can be used as they are, without having to make any changes. When any other drum trigger is connected, perform the following settings.

- **Specify the type of trigger that is connected**
Select the appropriate pad from the pad type list. For more information, refer to the Reference Manual (Advanced) (PDF). (MENU/Trigger/Pad Type)
- **Specify the function of the connected trigger**
Play trigger sounds (page 35)



This completes set up.

■ Using Electronic Drum Pads to Play Sounds or Control Functions (with Add-on Pads)

You can play drum, percussion or other sounds, or control functions using pads (sold separately) connected to the Main Unit.

Pad Connection Example

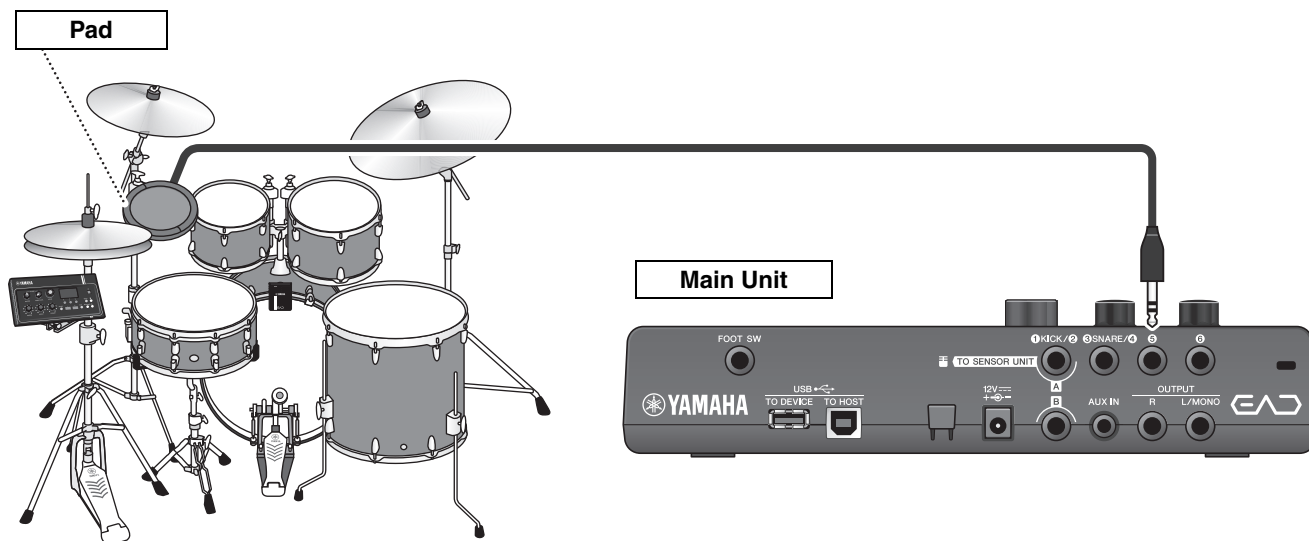

● Procedure: Example) Connecting a TP70S

1. Turn off the Main Unit.

Make sure the Main Unit is turned off before connecting.



2. Attach the pad.

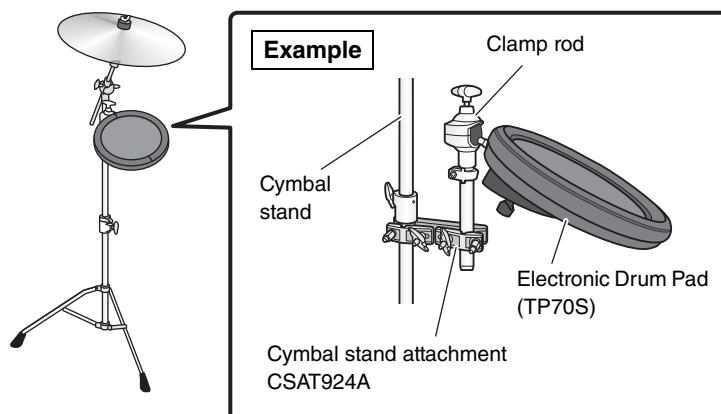

3. Connect the TP70S to the [5] or [6] jack on the Main Unit rear panel.

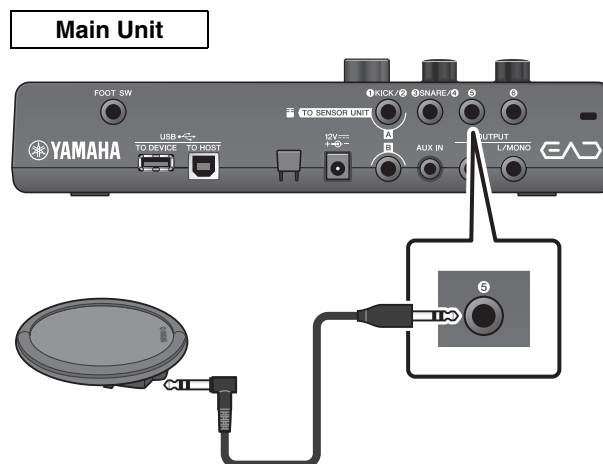

4. Turn on the Main Unit.



5. Press the [MENU] button to make necessary settings for using TP70S.

When the TP70S is connected to the [5] jack or [6] jack, settings can be used as they are, without having to make any changes. When any other pad is connected, perform the following settings.

- **Specify the type of pad that is connected**
Select the appropriate pad from the pad type list. For more information, refer to the Reference Manual (Advanced) (PDF). (MENU/Trigger/Pad Type)
- **Specify the function of the connected pad**
 - Play trigger sounds (page 35)
 - Switch functions (refer to the Reference Manual (Advanced) (PDF)) (MENU/Utility/PadFunction)



This completes set up.

■ Using a Pedal to Play Sounds or Control Functions (with a Foot Pedal or a Foot Controller)

You can connect a foot pedal to the [FOOT SW] jack for a variety of uses.

● Procedure:

Example) Connecting an HH65

1. Turn off the Main Unit.

Make sure the Main Unit is turned off before connecting.



2. Connect the pedal's plug to the [FOOT SW] jack on the Main Unit rear panel.

Plug the other end of the cable that came with the HH65 into the [OUTPUT] jack on the HH65.

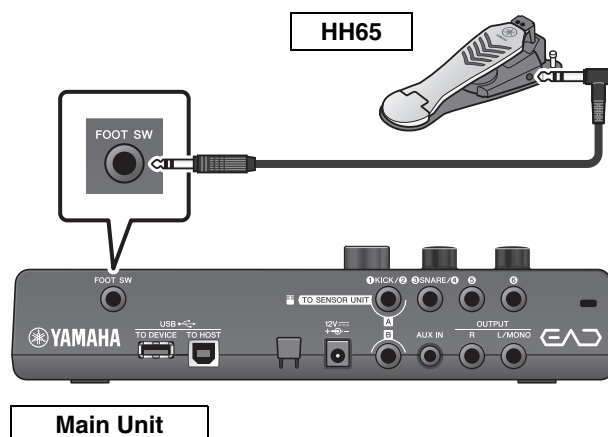

3. Turn the Main Unit on.



4. Press the [MENU] button to carry out the initial setting.

When the HH65 is connected, settings can be used as they are without having to make any changes. Perform the following settings when connecting any other pedal.

- **Specify the type of pedal that is connected**
Select the pedal you connected from MENU/Trigger/FootSwSelect
- **Specify the function of the connected pedal**
 - Specify the function of the connected pedal (MENU/Utility/PadFunction)
 - Select the Trigger Sound (to play sounds) (page 35)



This completes set up.

Reference

Menu List

MENU

Scene Edit

Inst

- Category Instrument Category
- InstNumber Instrument Number

- InstTune Instrument Tuning
- InstDecay Instrument Decay
- InstPan Instrument Pan

Voice

- Category Voice Category
- VoiceNumber Voice Number

- VoiceTune Voice Tuning
- VoiceDecay Voice Decay
- VoicePan Voice Pan

- VoiceFilter Voice Filter Cutoff Frequency
- VoiceQ Voice Filter Resonance (Q)
- VoiceAltGrp Voice Alternate Group
- VoiceHoldMode Voice Hold Mode

- MessageType Select MIDI Message Type

Effect

- ReverbType Reverb Type
- ReverbSend Reverb Send
- RevReturn Reverb Return

- Mic RevSend Mic Reverb Send
- TriggerRevSend Trigger Sound Reverb Send
 - └ Voice RevSend Trigger Sound Voice Reverb Send

- MicEffType Mic Effect Type
- MicEffDepth Mic Effect Depth

- TrgEffType Trigger Sound Effect Type
- TrgEffSend Trigger Sound Effect Send and Dry Balance
- TrgEffReturn Trigger Sound Effect Return
- TrgEffToRev Trigger Voice Effect Reverb Send

Volume

- └ Scene Volume Overall Scene Volume
 - └ Mic Volume Mic Volume
 - └ TriggerVolume Trigger Sound Overall Volume
 - └ Inst Volume Trigger Sound Instrument Volume
 - └ Voice Volume Trigger Sound Voice Volume

- Tempo Tempo for Selected Scene

Menu List

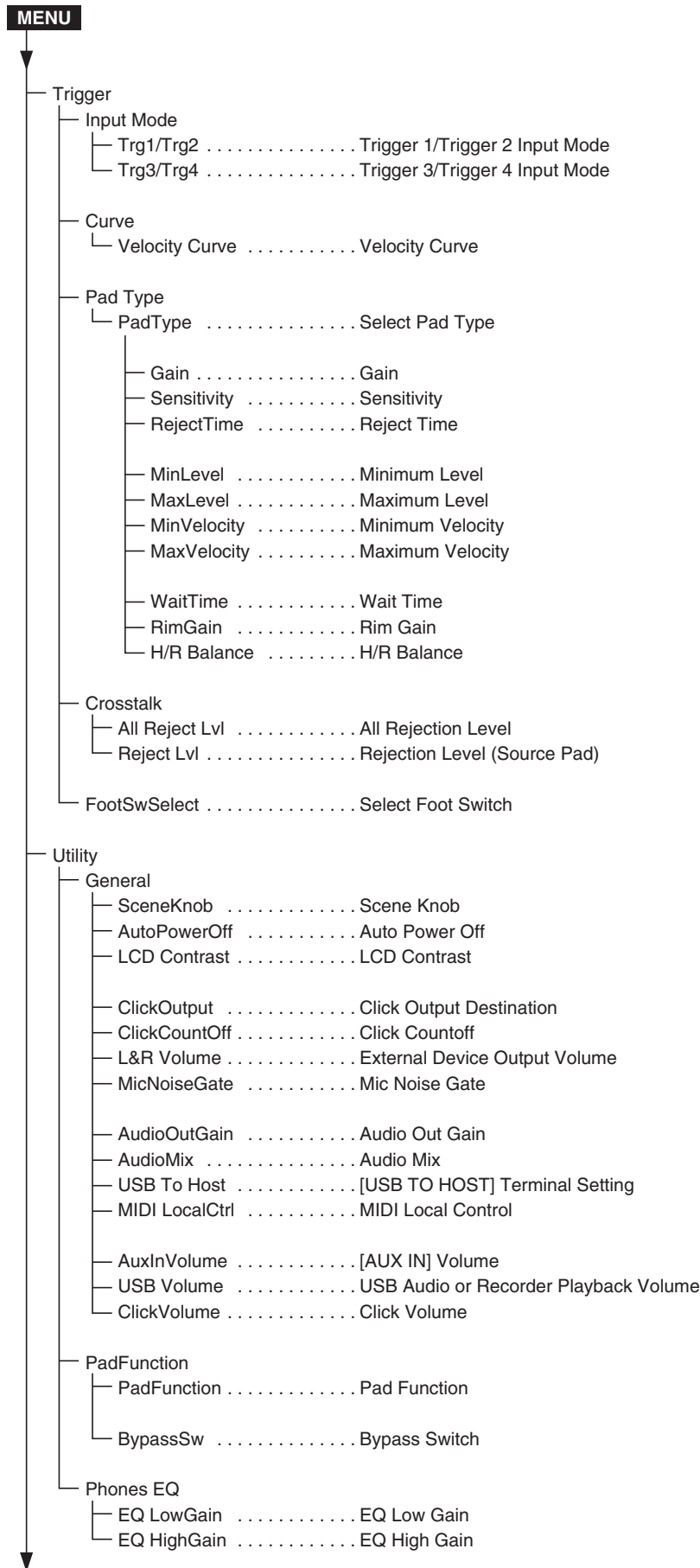

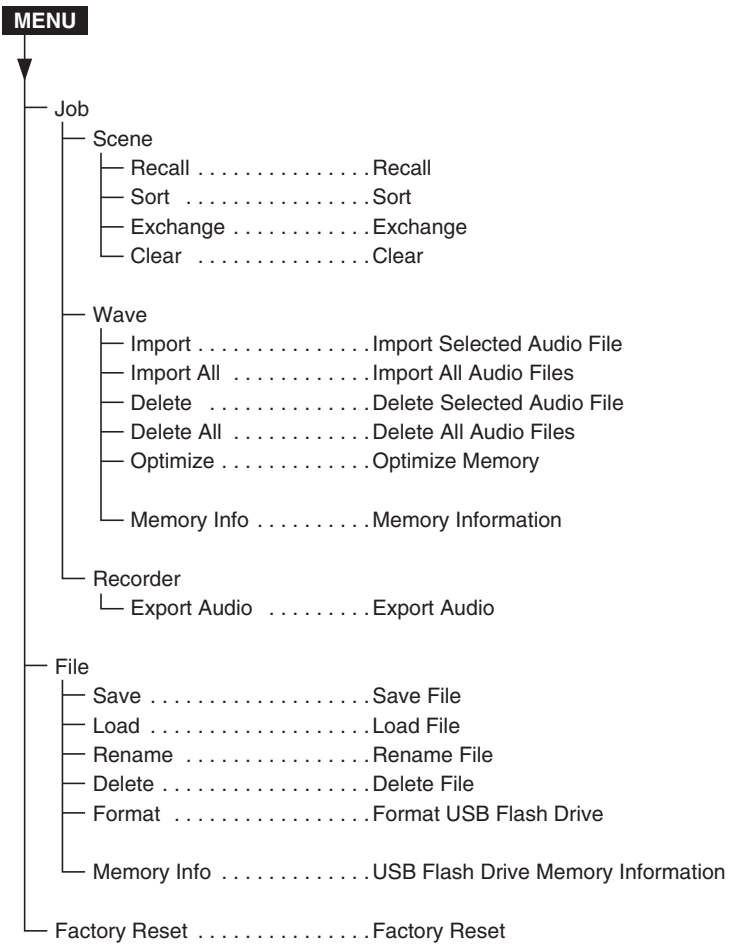

Troubleshooting

Symptom	Possible cause	Solution	Reference page
No sound	EAD10 is not turned on	Make sure that the power is turned on.	page 25
	The volume is not turned up	Check the [MASTER VOLUME] knob setting.	page 13
	The cable is not properly connected or The cable is damaged	Make sure that the Sensor Unit and Main Unit are properly connected with a stereo phone cable.	page 17
		Make sure the cable you are using is in good condition.	
		Make sure that the Main Unit is properly connected to headphones or other audio equipment, such as an amplifier and/or speakers.	
The volume setting is improper.	Check the [MASTER VOLUME] knob setting. Check the power and volume settings on the external devices.	page 13	
Poor volume balance			
Poor volume balance between the Mic Sound and Trigger Sound		Adjust the Trigger Sound volume. If it does not solve the problem, adjust the mic gain.	page 34 page 28
Poor volume balance between the AUX IN and your performance		Adjust the volume on the device connected to the [AUX IN] jack. Adjust the [AUDIO/CLICK VOLUME] knob.	page 13
Poor volume balance between the USB flash memory playback and your performance		Adjust the [AUDIO/CLICK VOLUME] knob.	page 13
Cymbals sound distant or volume of some drums is low		Instruments placed far from the Sensor Unit may sound low in volume. Check the positions of drums and cymbals in the drum set.	page 17
The bass drum Trigger Sound does not play	Trigger settings are improper.	Try using the automatic setting to set up the Sensor Unit.	page 27
	Sensor Unit not properly attached	Make sure the Sensor Unit is properly attached to the hoop.	page 17

Symptom	Possible cause	Solution	Reference page
Hard to notice changes to settings	Reverb/Effect level or Trigger Sound volume is too low	Turn the [REVERB] knob, [EFFECT] knob, or [TRIGGER] knob to the right to adjust depth or volume.	page 33
	The Mic Gain is set too low	Try using the automatic setting to set up the Sensor Unit.	page 27
	Trigger settings are improper		
	The volume for the headphones you are using is low	Use highly-efficient headphones, closed-ear headphones, or ear-phones.	page 23
Noise occurs	Noise from the mic	Secure the cables close to the Sensor Unit using the supplied cable band tape so that the cables do not move about near the Sensor Unit.	page 17
		Make sure the Sensor Unit is properly attached to the hoop.	
		Secure the cable connected to the [B] jack (Mic Sensor cable) on the Main Unit using the supplied cable bands to prevent the cables from moving about.	
Multiple sounds produced with a single strike (double trigger)	Double triggers are occurring	Make sure the Sensor Unit is properly attached to the hoop.	page 17
		The longer the bass drum head vibrates, the easier it is to cause double triggers. Adjust the bass drum so it produces a shorter sound. Try muting or tuning the head or changing the head.	
Separately sold add-on pads do not sound or Hard to produce sound		Make sure the pad type setting is correct.	Reference Manual (Advanced) (PDF)
Sound is produced without striking the pad Sound is produced by a pad that was not struck	Crosstalk is occurring	Increase the Trigger Sound minimum level setting. Setting this too high, however, can prevent light strokes from producing a sound. Adjust as necessary.	page 33 Reference Manual (Advanced) (PDF)
	Crosstalk is occurring with the bass drum Trigger Sound	Try using the automatic setting to set up the Sensor Unit. Check the Trigger Sensitivity setting.	page 27
		If the bass drum sound plays when striking the snare drum, move the snare drum farther away from the Sensor Unit. More distance between the two might improve the problem.	page 17

Troubleshooting

Symptom	Possible cause	Solution	Reference page
Sound is distorted	Mic gain level is set too high	Press the [] button and adjust the mic sensor settings.	page 27
	The Master Volume is set too high	Turn the [MASTER VOLUME] knob to the left.	page 13
	An Effect is applied	Adjust the distortion or other Effect setting.	page 13
Cannot record the Main Unit Cannot record to a USB flash drive	Cannot record audio from the AUX IN	The sound of your performance and the audio from the AUX IN cannot be recorded simultaneously. Audio from the AUX IN must first be recorded to the Main Unit, then you can overdub your performance onto the song.	page 41
	Cannot record the Click	EAD10 is not designed to record the Click.	
	Not enough memory in the USB flash drive	Check the available memory in the USB flash drive.	
	The USB flash drive is write protected	Disable the write protection from the USB flash drive.	
Audio files recorded on a USB flash drive have low volume when playing back on the Main Unit		Adjust the volume to an appropriate level when recording. Adjust the [AUDIO/CLICK VOLUME] knob during playback.	Record: Reference Manual (Advanced) (PDF) Playback: page 13
The audio file in the USB flash drive cannot be played back with the Main Unit or Playback stops in the middle of a song when playing back the audio file from the USB flash drive	Unsupported file format	Check the file format or the sampling frequency.	page 63
	The USB flash drive performance is insufficient.	We recommend using a USB flash drive of 4GB or more. For more information, refer to the “Compatible USB Device List” on the Yamaha web site.	*1
Power turns off unexpectedly	The Auto Power-Off function is enabled	Disable the Auto Power-Off function.	page 29
Does not turn on	The AC adaptor is not connected	Make sure the AC adaptor is connected.	page 22
Edits made to the Scene are lost	Before storing the edits, another Scene was selected	Use the Recall function to recall the edited contents.	page 34

*1 Refer to the website at <https://download.yamaha.com/>

*URL may change without notice.

Message List

Message	Description
Are you sure?	Confirms whether or not you want to execute the specified operation.
Auto power off disabled.	Appears when the [STORE] button is held down while turning on the power informing the user that the Auto Power Off function is disabled.
Backup error.	Appears when writing data to the Flash ROM has failed. If data was not be properly saved when turning off the unit, this message appears the next time the power is turned on. After the error message appears, the Factory Reset automatically executes.
Cancel AUX IN recording?	Appears when the SOURCE button is pressed while the Recorder is in AUX IN Recording. Press the button below "YES" to return to the normal Recorder setting.
Canceled.	Appears when the cancel operation is complete.
Can't use RECORDER now.	Cannot use the recorder because "USB To Host" is set to "audio." Check the "USB to Host" setting.
Completed.	Appears when execution of a Scene Store, File Load/Save, Job, or other function is complete.
Connecting USB device...	Appears when connecting to a USB device.
Excessive demand for USB power.	Power consumption of the USB device exceeds the specified value.
Factory Reset initializing...	Appears on startup if you did a factory reset.
File already exists.	A file with the same name already exists.
File not found.	The selected file type was not found.
Illegal file.	Appears when loading a file and the Main Unit cannot handle the target file or does not support the audio file.
Incompatible USB device.	Appears when an unsupported USB device is connected to the [USB TO DEVICE] terminal.
Invalid USB device.	The USB device is faulty. Format the USB device again.
No data.	Appears when the target data does not exist when using the Recorder or using Wav-related parameters under "Job."
No response from USB device.	There is no response from the USB device.
Now importing...	Appears when importing a .wav file.
Now loading...	Appears when loading a file.
Now processing...	Appears when executing a Scene Store or Job operation. Appears during post-processing after canceling the File Load or File Save operation.
Now saving...	Appears when saving a file.
Now switching audio driver.	Appears when the [USB TO HOST] terminal is connected to a computer or other device and the following operation is performed. When changing the "USB To Host" setting to "MIDI" or "MIDI+audio." When entering or exiting the Recorder screen when the "USB To Host" setting is "auto."
Overwrite?	Appears when saving a file to the USB device and a file with the same name already exists in the USB device. Appears when attempting to rerun the Store User Scene operation for the Scene previously saved.

Message List

Message	Description
Please stop recorder.	Appears when performing an operation that exits the Recorder during recorder playback or recording. Stop the Recorder and try again.
Recording time limit exceeded.	Recording time is about 1 minute 30 seconds with internal memory, and about 30 minutes with a USB flash drive.
Read only file.	Appears when a read-only file is selected during a file operation.
Sample is too long.	Sample is too long and cannot be loaded.
Sample is too short.	Sample is too short and cannot be loaded.
Switch to AUX IN recording?	Appears when the button below “source” is pressed while using the recorder. Press the button below “YES” and switch to recording from the [AUX IN] jack.
USB connection terminated.	Appears if connection with the USB device was interrupted by an abnormal electric current. Disconnect the USB device and press the button below “OK”.
USB device’s transfer speed too slow.	Appears when the transfer speed to the USB device is insufficient. For information on devices that have been tested and confirmed to work properly with the EAD10, refer to the “Compatible USB Device List” ^(*) on the Yamaha web site.
USB device full.	Appears when the USB device is full and files cannot be saved on it. Use a new USB device or make space by erasing unnecessary files from the full device.
USB device not ready.	Appears if the USB device is not properly connected to the Main Unit.
USB device read/write error.	Appears if an error occurred while reading or writing data to the USB device.
USB device write protected.	Appears if the USB device is write-protected.
USB transmission error.	Appears if an error occurred while communicating with the USB device.
Wave memory full.	Appears if the WAVE memory is full and operations such as Import, Job, or Load cannot be carried out.

*1 Refer to the website at <https://download.yamaha.com/>
 *URL may change without notice.

Specifications

Main Unit

Tone Generator Block	Scenes	Preset: 50 User: 200	
	Reverb	11	
	Effects	Mic: 21, Trigger: 10	
	Trigger Sounds	Tone generator	AWM2
		Maximum polyphony	64
	Voices	757	
Recorder	Recording time	Internal memory USB flash drive	
		Approx. 1 min 30 sec Approx. 30 min/file	
	Format	Record/playback	
		WAV (44.1 kHz, 16 bit, stereo)	
Audio Files	Import limit	Up to 100	
	Playback sample rate	44.1 kHz	
	Wave memory	32 MB	
	Maximum loadable sample size	1 mono sample: 1.75 MB 1 stereo sample: 3.5 MB	
	Sample format	WAV (16 bit)	
Click-track	Tempo	30–300 BPM, tap tempo function	
	Time signatures	1/4 to 16/4, 1/8 to 16/8, 1/16 to 16/16	
	Subdivisions	Accents, quarter notes, eighth notes, sixteenth notes, and eighth-note triplets	
Functions		Trigger sensitivity adjustment, USB audio/MIDI, headphone EQ	
Control Interface	Display	Full Dot LCD (128 × 64 dot)	
	Other Controllers	Knobs Buttons	
		MASTER VOLUME, AUDIO/CLICK VOLUME, SCENE, REVERB, EFFECT, TRIGGER MENU, Sensor Unit, Click, RECORDER, EXIT, STORE, Functions 1–3, –, +, Standby/On	
Connectivity	DC IN	DC IN (12 V)	
	Headphones	PHONES (standard stereo phone jack)	
	AUX IN	AUX IN (stereo mini jack)	
	OUTPUT	OUTPUT L/MONO, R (standard phone jack)	
	USB	USB TO DEVICE USB TO HOST	
	Sensor input	For Trigger sensor	A (standard stereo phone jack)
		For Mic sensor	B (standard stereo phone jack)
	Trigger input	Stereo (L: trigger, R: trigger)	① KICK/② (also serves as A), ③ SNARE/④ (standard stereo phone jack)
		Three-zone (L: trigger, R: rim switch)	⑤, ⑥ (standard stereo phone jack)
Foot Pedal	FOOT SW (standard stereo phone jack)		
Power Supply	Power Supply	PA-150 (or an equivalent recommended by Yamaha)	
	Power Consumption	10 W (when using PA-150 AC adaptor)	
	Auto Power Off	Yes	
	Standby Power Consumption	0.3 W	
Size/Weight	Dimensions (W × D × H)	Width × depth × height	
		260 (W) × 138 (D) × 63 (H) mm (10 1/4" × 5 7/16" × 2 1/2")	
	Weight	Main Unit only	
		654 g (1 lb 7 oz)	

Sensor Unit

Sensor Types	Microphone	High SPL mic × 2
	Trigger	Exclusive for bass drum × 1
Connectivity	Sensor outputs	For Trigger sensor For Mic sensor
		A (standard phone jack) B (standard stereo phone jack)
Size/Weight	Dimensions (W × D × H)	Width × depth × height
		76 (W) × 78 (D) × 88 (H) mm (3" × 3 1/16" × 3 7/16")
	Weight	Sensor Unit only
		464 g (1 lb)

Other

Included Accessories	Owner's Manual (this book), PA-150 (or an equivalent recommended by Yamaha)*, Module holder, Module holder wing bolts (× 2), Connector cables (1 pair), Cable bands (× 3), Adhesive cushions (× 2) *May not be included depending on your area. Check with your Yamaha dealer.
Separately Sold Accessories (May not be available depending on your area.)	<ul style="list-style-type: none"> Cymbal stand attachment (CSAT924A) Please check the website for more information on other available accessories (https://download.yamaha.com/)



* The contents of this manual apply to the latest specifications as of the publishing date.

To obtain the latest manual, access the Yamaha website then download the manual file.

Since specifications, equipment or separately sold accessories may not be the same in every locale, please check with your Yamaha dealer.

Index

Symbols

- [] (Click) button 13
- [] (Sensor Unit) button 13, 27
- [] (Standby/On) switch 13, 25
- [-] button, [+] button 13

Numerics

- [] KICK/ SNARE/ 16
- [] SNARE/ 16
- [] 16
- [] 16

A

- [A] jack 15
- AC adaptor 9, 22
- Accompaniment Song 44
- Adhesive cushions 9
- [AUDIO/CLICK VOLUME] knob 13
- audio file 37, 44
- audio signal 11
- Auto Power-Off 29
- Auto setting 27
- [AUX IN] (auxiliary input) jack 14
- AUX IN Recording 43

B

- [B] jack 15
- BYPASS 35

C

- Cable bands 9
- Clamp screw 15
- Click 39
- Computer 25, 47
- Connector cables 9
- Cord hook 14

D

- DAW Software 47
- DC IN jack 14
- Display 13
- double bass drum set ups 17
- drum set 17
- Drum Trigger 48, 50

E

- E mark 33
- [EFFECT] knob 13
- Effects 11, 32
- [EXIT] button 13

F

- [F1], [F2], [F3] 13
- Factory Reset 30
- Foot Controller 54
- Foot Pedal 54
- [FOOT SW] Jack 14
- Front Panel 15
- Function Buttons 1–3 13

G

- Gain 27

H

- Headphones 23
- Hoop 18

I

- Imported Sounds 37
- Input Source 43
- internal Voices 11
- iPhone/iPad 47

L

- [L] (Mic gain left) 28

M

- Main Unit 10, 13
- [MASTER VOLUME] knob 13
- [MENU] button 13
- Metal hoops 18
- Metronome 39
- MIC 27
- Mic gain 27
- Mic Sensor 15
- Mic sound 11
- Module holder 9, 20
- Module holder wing bolts 9

O

- OUTPUT [R]/[L/MONO] jacks 14

P

- PA System 24
- Pad 48, 52
- Pedal 49
- [PHONES] jack 15
- Portable Music Player 24
- Preset Scene 34

R

- [R] (Mic gain right) 28
- Rear Panel 14
- [RECORDER] button 13
- Reverb 11, 32
- [REVERB] knob 13

S

- Scene 32
- [SCENE] knob 13
- Scene Screen 33
- Sensor Unit 10, 15, 27
- Separately Sold Add-Ons 48
- Store 33
- [STORE] button 13, 37

T

- Tap Tempo 39
- Tempo 39
- TO SENSOR UNIT [A] jack 14
- TO SENSOR UNIT [B] jack 14
- Top Panel 13
- TRG 27
- TRG SENS (Trigger Sensitivity) 28
- Trigger gain 27
- Trigger Input Jacks 14, 16
- [TRIGGER] knob 13
- Trigger sensor 15
- trigger signal 11
- Trigger Sound 32

U

- USB Flash Drive 30, 42
- [USB TO DEVICE] terminal 14, 30
- [USB TO HOST] terminal 14, 25
- User Scene 34

W

- .wav 37
- Wood hoops 18

Y

- Y-cable 16

Important Notice: Power management information for customers in European Economic Area (EEA), Switzerland and Turkey

Remarque importante : Informations sur la gestion de l'alimentation pour les clients de l'Espace économique européen (EEE), de Suisse et de Turquie

Yamaha products are equipped with a power management function. Some products allow you to disable that function, or to extend the amount of time that elapses before the power is turned off or set to standby. In these cases, energy consumption will increase.	English
Yamaha-Produkte sind mit einer Power-Management-Funktion ausgestattet. Bei einigen Produkten können Sie diese Funktion ausschalten oder die Zeitdauer, die verstreicht, bis das Instrument ausgeschaltet oder in Bereitschaft versetzt wird, verlängern. In diesen Fällen erhöht sich der Energieverbrauch.	Deutsch
Les produits Yamaha sont équipés d'une fonction de gestion de l'alimentation. Certains produits vous permettent de désactiver cette fonction ou d'allonger le délai avant la mise hors tension ou la mise en veille. Dans ces cas, la consommation d'énergie augmente.	Français
Yamaha-producten zijn uitgerust met een energiebeheerfunctie. Bij sommige producten kunt u die functie uitschakelen of de tijd verlengen die verstrijkt voordat de stroom wordt uitgeschakeld of in stand-by wordt gezet. In deze gevallen zal het energieverbruik toenemen.	Nederlands
Los productos Yamaha están equipados con una función de administración de energía. Algunos productos permiten desactivar esa función o ampliar el tiempo que transcurre antes de apagar la alimentación o poner el producto en modo de espera. En estos casos, el consumo de energía aumentará.	Español
I prodotti Yamaha sono dotati di una funzione di gestione dell'alimentazione. Alcuni prodotti consentono di disattivare tale funzione o di estendere il periodo di tempo che trascorre prima che l'alimentazione venga spenta o impostata in standby. In questi casi, il consumo energetico aumenterà.	Italiano
Os produtos Yamaha são equipados com uma função de gerenciamento de energia. Alguns produtos permitem desativar essa função ou estender o tempo decorrido antes de se desligar ou entrar em standby. Nesses casos, o consumo de energia aumentará.	Português
Τα προϊόντα της Yamaha είναι εξοπλισμένα με μια λειτουργία διαχείρισης ισχύος. Ορισμένα προϊόντα σας δίνουν τη δυνατότητα να απενεργοποιείτε αυτή τη λειτουργία ή να επεκτείνετε το χρονικό διάστημα μέχρι την απενεργοποίηση ή τη θέση σε κατάσταση αναμονής. Σε αυτές τις περιπτώσεις, η κατανάλωση ενέργειας θα αυξηθεί.	Ελληνικά
Yamaha-produkterna är utrustade med en energihanteringsfunktion. För vissa produkter kan du inaktivera den funktionen eller för att förlänga tiden som förflutit innan strömmen stängs av eller ställs i vänteläge. I dessa fall ökar energiförbrukningen.	Svenska
Yamahas produkter har en strømstyringsfunktion. På nogle produkter er det muligt at deaktivere denne funktion eller at forlænge den tid, der går, før der slukkes for strømmen, eller sættes på standby. I disse tilfælde vil strømforbruget stige.	Dansk
Yamaha-tuotteet on varustettu virranhallintatoiminnoilla. Joissakin tuotteissa voit poistaa toiminnon käytöstä tai pidentää aikaa, joka kuluu ennen virran katkaisemista tai valmiustilaan asettamista. Näissä tapauksissa energiankulutus kasvaa.	Suomi
Produkty Yamaha są wyposażone w funkcję zarządzania energią. Niektóre produkty umożliwiają wyłączenie tej funkcji lub wydłużenie czasu, jaki upływa do wyłączenia zasilania lub przejścia w tryb gotowości. W takich przypadkach zużycie energii wzrośnie.	Polski
Produkty Yamaha jsou vybaveny funkcí správy napájení. Některé produkty umožňují tuto funkci zakázat nebo prodloužit dobu, která má uběhnout před vypnutím napájení nebo pohotovostním režimem. V těchto případech se zvýší spotřeba elektřiny.	Čeština
A Yamaha termékek energiamedzszment funkcióval vannak ellátva. Egyes termékek lehetővé teszik, hogy letiltsa ezt a funkciót, vagy meghosszabbítsa a kikapcsolás vagy készenléti állapotba helyezés előtt eltelt időt. Ezekben az esetekben az energiafogyasztás növekedni fog.	Magyar
Yamaha tooted on varustatud toitehalduse funktsiooniga. Mõned tooted võimaldavad teil selle funktsiooni keelata või pikendada aega, mis möödub enne toite väljalülitamist või ooterežiimi seadmist. Sellistel juhtudel suureneb energiatarbimine.	Eesti
Yamaha izstrādājumi ir aprīkoti ar barošanas pārvaldības funkciju. Dažiem izstrādājumiem šo funkciju var atspējot vai paildzināt laiku, kam jāpaiet pirms barošanas atslēgšanas vai pāriešanas gaidstāves režīmā. Šādā gadījumā palielināsies enerģijas patēriņš.	Latviešu
„Yamaha“ gaminiose yra energijos sąnaudų valdymo funkcija. Kai kurie gaminiai leidžia išjungti šią funkciją arba pratęsti laiką, praėjusį prieš išjungiant maitinimą arba įjungiant budėjimo režimą. Tokiais atvejais energijos suvartojimas padidės.	Lietuvių
Produkty spoločnosti Yamaha sú vybavené funkciou správy napájania. Niektoré produkty vám umožňujú túto funkciu vypnúť alebo predĺžiť čas, po uplynutí ktorých sa napájanie vypne alebo nastaví do pohotovostného režimu. V takýchto prípadoch sa zvýši spotreba energie.	Slovenčina
Yamahini izdelki imajo funkcijo upravljanja z napajanjem. Nekateri izdelki vam omogočajo, da onemogočite to funkcijo ali podaljšate čas, ki mora preteči, preden se napajanje izklopi ali nastavi v stanje pripravljenosti. V teh primerih se bo poraba energije povečala.	Slovenščina
Продуктите на Yamaha са снабдени с функция за управление на захранването. Някои продукти ви позволяват да забраните тази функция или да удължите времето, което ще изтече, преди захранването да се изключи или да се настрои в режим на готовност. В тези случаи консумацията на енергия ще се увеличи.	Български
Produsele Yamaha sunt echipate cu o funcție de gestionare a energiei. Unele produse vă permit să dezactivați această funcție sau să prelungiți perioada de timp care trece înainte ca alimentarea să fie oprită sau setată în standby. În aceste cazuri, consumul de energie va crește.	Română
Yamaha proizvodi opremljeni su funkcijom upravljanja potrošnjom energije. Neki vam proizvodi omogućuju onemogućavanje te funkcije ili produženje vremena koje protekne prije isključivanja napajanja ili postavljanja u stanje pripravnosti. U tim će se slučajevima povećati potrošnja energije.	Hrvatski
Yamaha ürünlerinde güç yönetimi işlevi vardır. Bazı ürünler, bu işlevi devre dışı bırakmanıza veya güç kapatılmadan ya da bekleme moduna alınmadan önce geçen süreyi uzatmanıza olanak tanır. Bu gibi durumlarda, enerji tüketimi artacaktır.	Türkçe

(574-M06 EU erp 01)

MEMO

MEMO

MEMO



LIMITED WARRANTY ON YAMAHA DRUMS, HARDWARE AND ACCESSORY PRODUCTS

Thank you for selecting a YAMAHA product. YAMAHA products are designed and manufactured to provide a high level of defect-free performance. Yamaha Corporation of America (“YAMAHA”) is proud of the experience and craftsmanship that goes into each and every YAMAHA product. YAMAHA sells its products through a network of reputable, specially authorized dealers and is pleased to offer you, the Original Owner, the following Limited Warranty, which applies only to products that have been (1) directly purchased from YAMAHA’s authorized dealers in the fifty states of the USA and District of Columbia (the “Warranted Area”) and (2) used exclusively in the Warranted Area. YAMAHA suggests that you read the Limited Warranty thoroughly, and invites you to contact your authorized YAMAHA dealer or YAMAHA Customer Service if you have any questions.

THIS WARRANTY COVERS THE LISTED PRODUCTS AGAINST DEFECTS IN MATERIALS OR WORKMANSHIP.

Warranty Term

Duration of Warranty from Date of Purchase by or for the Original Owner

Type of Product

**Acoustic Drum Shells, Finish, Drum Hardware, Freestanding Hardware, Pedals, Hardware Accessories
Electronic Drums Modules, Pads, Accessories, Hardware, Pedals**

**5 Years
1 Year**

Coverage: YAMAHA will, at its option, repair or replace the product covered by this warranty if it becomes defective, malfunctions or otherwise fails to conform with this warranty under normal use and service during the term of this warranty, without charge for labor or materials. Repairs may be performed using new or refurbished parts that meet or exceed YAMAHA specifications for new parts. If YAMAHA elects to replace the product, the replacement may be a reconditioned unit. You will be responsible for any installation or removal charges and for any initial shipping charges if the product(s) must be shipped for warranty service. However, YAMAHA will pay the return shipping charges to any destination within the USA if the repairs are covered by the warranty. This warranty does not cover (a) damage, deterioration or malfunction resulting from accident, negligence, misuse, abuse, improper installation or operation or failure to follow instructions according to the Owner’s Manual for this product; any shipment of the product (claims must be presented to the carrier); repair or attempted repair by anyone other than YAMAHA or an authorized YAMAHA Service Center; (b) any unit which has been altered or on which the serial number has been defaced, modified or removed; (c) normal wear and any periodic maintenance; (d) deterioration due to perspiration, corrosive atmosphere or other external causes such as extremes in temperature or humidity; (e) damages attributable to power line surge or related electrical abnormalities, lightning damage or acts of God; or (f) RFI/EMI (Interference/noise) caused by improper grounding or the improper use of either certified or uncertified equipment, if applicable. Any evidence of alteration, erasing or forgery of proof-of-purchase documents will cause this warranty to be void. This warranty covers only the Original Owner and is not transferable.

In Order to Obtain Warranty Service: Warranty service will only be provided for defective products within the Warranted Area. Contact your local authorized YAMAHA dealer who will advise you of the procedures to be followed. If this is not successful, contact YAMAHA at the address, telephone number or website shown below. YAMAHA may request that you send the defective product to a local authorized YAMAHA Servicer or authorize return of the defective product to YAMAHA for repair. If you are uncertain as to whether a dealer has been authorized by YAMAHA, please contact YAMAHA’s Service Department at the number shown below, or check Yamaha’s website at <https://usa.yamaha.com>. Product(s) shipped for service should be packed securely and must be accompanied by a detailed explanation of the problem(s) requiring service, together with the original or a machine reproduction of the bill of sale or other dated, proof-of-purchase document describing the product, as evidence of warranty coverage. Should any product submitted for warranty service be found ineligible therefore, an estimate of repair cost will be furnished and the repair will be accomplished only if requested by you and upon receipt of payment or acceptable arrangement for payment.

Limitation of Implied Warranties and Exclusion of Damages: ANY IMPLIED WARRANTIES, INCLUDING WARRANTIES OF MERCHANTABILITY AND FITNESS FOR A PARTICULAR PURPOSE SHALL BE LIMITED IN DURATION TO THE APPLICABLE PERIOD OF TIME SET FORTH ABOVE. YAMAHA SHALL NOT BE RESPONSIBLE FOR INCIDENTAL OR CONSEQUENTIAL DAMAGES OR FOR DAMAGES BASED UPON INCONVENIENCE, LOSS OF USE, DAMAGE TO ANY OTHER EQUIPMENT OR OTHER ITEMS AT THE SITE OF USE OR INTERRUPTION OF PERFORMANCES OR ANY CONSEQUENCES. YAMAHA’S LIABILITY FOR ANY DEFECTIVE PRODUCT IS LIMITED TO REPAIR OR REPLACEMENT OF THE PRODUCT, AT YAMAHA’S OPTION. SOME STATES DO NOT ALLOW LIMITATIONS ON HOW LONG AN IMPLIED WARRANTY LASTS OR THE EXCLUSION OR LIMITATION OF INCIDENTAL OR CONSEQUENTIAL DAMAGES, SO THE ABOVE LIMITATION OR EXCLUSION MAY NOT APPLY TO YOU. This Warranty gives you specific legal rights, and you may also have other rights which vary from state to state. This is the only express warranty applicable to the product specified herein; Yamaha neither assumes nor authorizes anyone to assume for it any other express warranty.

If you have any questions about service received or if you need assistance in locating an authorized YAMAHA Servicer, please contact:



CUSTOMER SERVICE

Yamaha Corporation of America

6600 Orangethorpe Avenue, Buena Park, California 90620-1373

Telephone: 800-854-1569 • <https://usa.yamaha.com>

Do not return any product to the above address without a written Return Authorization issued by YAMAHA.

Important Notice: Guarantee Information for customers in European Economic Area (EEA) and Switzerland

<p>Important Notice: Guarantee Information for customers in EEA* and Switzerland</p> <p>For detailed guarantee information about this Yamaha product, and Pan-EEA* and Switzerland warranty service, please either visit the website address below (Printable file is available at our website) or contact the Yamaha representative office for your country. * EEA: European Economic Area</p>	English
<p>Wichtiger Hinweis: Garantie-Information für Kunden in der EWR* und der Schweiz</p> <p>Für nähere Garantie-Information über dieses Produkt von Yamaha, sowie über den Pan-EWR*- und Schweizer Garantieservice, besuchen Sie bitte entweder die folgend angegebene Internetadresse (eine druckfähige Version befindet sich auch auf unserer Webseite), oder wenden Sie sich an den für Ihr Land zuständigen Yamaha-Vertrieb. *EWR: Europäischer Wirtschaftsraum</p>	Deutsch
<p>Remarque importante: informations de garantie pour les clients de l'EEE et la Suisse</p> <p>Pour des informations plus détaillées sur la garantie de ce produit Yamaha et sur le service de garantie applicable dans l'ensemble de l'EEE ainsi qu'en Suisse, consultez notre site Web à l'adresse ci-dessous (le fichier imprimable est disponible sur notre site Web) ou contactez directement Yamaha dans votre pays de résidence. * EEE : Espace Economique Européen</p>	Français
<p>Belangrijke mededeling: Garantie-informatie voor klanten in de EER* en Zwitserland</p> <p>Voor gedetailleerde garantie-informatie over dit Yamaha-product en de garantieservice in heel de EER* en Zwitserland, gaat u naar de onderstaande website (u vindt een afdrukbaar bestand op onze website) of neemt u contact op met de vertegenwoordiging van Yamaha in uw land. * EER: Europese Economische Ruimte</p>	Nederlands
<p>Aviso importante: información sobre la garantía para los clientes del EEE* y Suiza</p> <p>Para una información detallada sobre este producto Yamaha y sobre el soporte de garantía en la zona EEE* y Suiza, visite la dirección web que se incluye más abajo (la versión del archivo para imprimir esta disponible en nuestro sitio web) o póngase en contacto con el representante de Yamaha en su país. * EEE: Espacio Económico Europeo</p>	Español
<p>Avviso importante: informazioni sulla garanzia per i clienti residenti nell'EEA* e in Svizzera</p> <p>Per informazioni dettagliate sulla garanzia relativa a questo prodotto Yamaha e l'assistenza in garanzia nei paesi EEA* e in Svizzera, potete consultare il sito Web all'indirizzo riportato di seguito (è disponibile il file in formato stampabile) oppure contattare l'ufficio di rappresentanza locale della Yamaha. * EEA: Area Economica Europea</p>	Italiano
<p>Aviso importante: informações sobre as garantias para clientes da AEE* e da Suíça</p> <p>Para obter uma informação pormenorizada sobre este produto da Yamaha e sobre o serviço de garantia na AEE* e na Suíça, visite o site a seguir (o arquivo para impressão está disponível no nosso site) ou entre em contato com o escritório de representação da Yamaha no seu país. * AEE: Área Económica Europeia</p>	Português
<p>Σημαντική σημείωση: Πληροφορίες εγγύησης για τους πελάτες στον ΕΟΧ* και Ελλάδα</p> <p>Για λεπτομερείς πληροφορίες εγγύησης σχετικά με το παρόν προϊόν της Yamaha και την κάλυψη εγγύησης σε όλες τις χώρες του ΕΟΧ και την Ελλάδα, επισκεφτείτε την παρακάτω ιστοσελίδα (Εκτυπώσιμη μορφή είναι διαθέσιμη στην ιστοσελίδα μας) ή απευθυνθείτε στην αντιπροσωπεία της Yamaha στη χώρα σας. * ΕΟΧ: Ευρωπαϊκός Οικονομικός Χώρος</p>	Ελληνικά
<p>Viktigt: Garantiinformation för kunder i EES-området* och Schweiz</p> <p>För detaljerad information om denna Yamahaprodukt samt garantiservice i hela EES-området* och Schweiz kan du antingen besöka nedanstående webbadress (en utskriftsvänlig fil finns på webbplatsen) eller kontakta Yamahas officiella representant i ditt land. * EES: Europeiska Ekonomiska Samarbetsområdet</p>	Svenska
<p>Viktig merknad: Garantiinformasjon for kunder i EØS* og Sveits</p> <p>Detaljert garantiinformasjon om dette Yamaha-produktet og garantiservice for hele EØS-området* og Sveits kan fås enten ved å besøke nettstedene nedenfor (utskriftsversjon finnes på våre nettsider) eller kontakte Yamahas kontoret i landet der du bor. *EØS: Det europeiske økonomiske samarbeidsområdet</p>	Norsk
<p>Vigtig oplysning: Garantioplysninger til kunder i EØO* og Schweiz</p> <p>De kan finde detaljerede garantioplysninger om dette Yamaha-produkt og den fælles garantiserviceordning for EØO* (og Schweiz) ved at besøge det websted, der er angivet nedenfor (der findes en fil, som kan udskrives, på vores websted), eller ved at kontakte Yamahas nationale repræsentationskontor i det land, hvor De bor. * EØO: Det Europæiske Økonomiske Område</p>	Dansk
<p>Tärkeä ilmoitus: Takuutiedot Euroopan talousalueen (ETA)* ja Sveitsin asiakkaille</p> <p>Tämän Yamaha-tuotteen sekä ETA-alueen ja Sveitsin takuuta koskevat yksityiskohtaiset tiedot saatte alla olevasta nettiosoitteesta. (Tulostettava tiedosto saatavissa sivustollamme.) Voitte myös ottaa yhteyttä paikalliseen Yamaha-edustajaan. *ETA: Euroopan talousalue</p>	Suomi
<p>Ważne: Warunki gwarancyjne obowiązujące w EOG* i Szwajcarii</p> <p>Aby dowiedzieć się więcej na temat warunków gwarancyjnych tego produktu firmy Yamaha i serwisu gwarancyjnego w całym EOG* i Szwajcarii, należy odwiedzić wskazaną poniżej stronę internetową (Plik gotowy do wydruku znajduje się na naszej stronie internetowej) lub skontaktować się z przedstawicielstwem firmy Yamaha w swoim kraju. * EOG — Europejski Obszar Gospodarczy</p>	Polski
<p>Důležité oznámení: Záruční informace pro zákazníky v EHS* a ve Švýcarsku</p> <p>Podrobné záruční informace o tomto produktu Yamaha a záručním servisu v celém EHS* a ve Švýcarsku naleznete na níže uvedené webové adrese (soubor k tisku je dostupný na našich webových stránkách) nebo se můžete obrátit na zastoupení firmy Yamaha ve své zemi. * EHS: Evropský hospodářský prostor</p>	Česky
<p>Fontos figyelemzetetés: Garancia-információk az EGT* területén és Svájcban élő vásárlók számára</p> <p>A jelen Yamaha termékre vonatkozó részletes garancia-információk, valamint az EGT*-re és Svájcra kiterjedő garanciális szolgáltatás tekintetében keresse fel webhelyünket az alábbi címen (a webhelyen nyomtatható fájl is talál), vagy pedig lépjen kapcsolatba az országában működő Yamaha képviselői irodával. * EGT: Európai Gazdasági Térség</p>	Magyar
<p>Oluline märkus: Garantiiteave Euroopa Majanduspiirkonna (EMP)* ja Šveitsi klientidele</p> <p>Täpsemat teabe saamiseks selle Yamaha toote garantii ning kogu Euroopa Majanduspiirkonna ja Šveitsi garantiiteeninduse kohta, külastage palun veebisaiti alljärgneval aadressil (meie saidil on saadaval prinditav fail) või pöörduge Teie regioonil Yamaha esinduse poole. * EMP: Euroopa Majanduspiirkond</p>	Eesti keel
<p>Svarīgs paziņojums: garantijas informācija klientiem EEZ* un Šveicē</p> <p>Lai saņemtu detalizētu garantijas informāciju par šo Yamaha produktu, kā arī garantijas apkalpošanu EEZ* un Šveicē, lūdzu, apmeklējiet zemāk norādīto tīmekļa vietnes adresi (tīmekļa vietnē ir pieejams drukājams fails) vai sazinieties ar jūsu valsti apkalpojošo Yamaha pārstāvniecību. * EEZ: Eiropas Ekonomikas zona</p>	Latviešu
<p>Dėmesio: informacija dėl garantijos pirkėjams EEE* ir Šveicarijoje</p> <p>Jei reikia išsamios informacijos apie šį „Yamaha“ produktą ir jo techninę priežiūrą visoje EEE* ir Šveicarijoje, apsilankykite mūsų svetainėje toliau nurodytu adresu (svetainėje yra spausdintinas failas) arba kreipkitės į „Yamaha“ atstovybę savo šalyje. * EEE – Europos ekonominė erdvė</p>	Lietuvių kalba
<p>Dôležité upozornenie: Informácie o záruke pre zákazníkov v EHP* a Švajčiarsku</p> <p>Podrobné informácie o záruke týkajúce sa tohto produktu od spoločnosti Yamaha a garančnom servise v EHP* a Švajčiarsku nájdete na webovej stránke uvedenej nižšie (na našej webovej stránke je k dispozícii súbor na tlač) alebo sa obráťte na zástupcu spoločnosti Yamaha vo svojej krajine. * EHP: Európsky hospodársky priestor</p>	Slovenčina
<p>Pomembno obvestilo: Informacije o garanciji za kupce v EGP* in Švici</p> <p>Za podrobnejše informacije o tem Yamahinem izdelku ter garancijskem servisu v celotnem EGP in Švici, obiščite spletno mesto, ki je navedeno spodaj (natisljiva datoteka je na voljo na našem spletnem mestu), ali se obrnite na Yamahinega predstavnika v svoji državi. * EGP: Evropski gospodarski prostor</p>	Slovenščina
<p>Важно съобщение: Информация за гаранцията за клиенти в ЕИП* и Швейцария</p> <p>За подробна информация за гаранцията за този продукт на Yamaha и гаранционното обслужване в паневропейската зона на ЕИП* и Швейцария или посетете посочения по-долу уеб сайт (на нашия уеб сайт има файл за печат), или се свържете с представителния офис на Yamaha във вашата страна. * ЕИП: Европейско икономическо пространство</p>	Български език
<p>Notificare importantă: Informații despre garanție pentru clienții din SEE* și Elveția</p> <p>Pentru informații detaliate privind acest produs Yamaha și serviciul de garanție Pan-SEE* și Elveția, vizitați site-ul la adresa de mai jos (fișierul imprimabil este disponibil pe site-ul nostru) sau contactați biroul reprezentanței Yamaha din țara dumneavoastră. * SEE: Spațiul Economic European</p>	Limba română
<p>Važna obavijest: Informacije o jamstvu za države EGP-a i Švicarske</p> <p>Za detaljne informacije o jamstvu za ovaj Yamahin proizvod te jamstvenom servisu za cijeli EGP i Švicarsku, molimo Vas da posjetite web-stranicu navedenu u nastavku ili kontaktirate ovlaštenog Yamahinog dobavljača u svojoj zemlji. * EGP: Evropski gospodarski prostor</p>	Hrvatski

<https://europe.yamaha.com/warranty/>

URL_5

Yamaha Worldwide Representative Offices

English

For details on the product(s), contact your nearest Yamaha representative or the authorized distributor, found by accessing the 2D barcode below.

Deutsch

Wenden Sie sich für nähere Informationen zu Produkten an eine Yamaha-Vertretung oder einen autorisierten Händler in Ihrer Nähe. Diese finden Sie mithilfe des unten abgebildeten 2D-Strichcodes.

Français

Pour obtenir des informations sur le ou les produits, contactez votre représentant ou revendeur agréé Yamaha le plus proche. Vous le trouverez à l'aide du code-barres 2D ci-dessous.

Español

Para ver información detallada sobre el producto, contacte con su representante o distribuidor autorizado Yamaha más cercano. Lo encontrará escaneando el siguiente código de barras 2D.

Português

Para mais informações sobre o(s) produto(s), fale com seu representante da Yamaha mais próximo ou com o distribuidor autorizado acessando o código de barras 2D abaixo.

Italiano

Per dettagli sui prodotti, contattare il rappresentante Yamaha o il distributore autorizzato più vicino, che è possibile trovare tramite il codice a barre 2D in basso.

Nederlands

Neem voor meer informatie over de producten contact op met uw dichtstbijzijnde Yamaha-vertegenwoordiger of de geautoriseerde distributeur, te vinden via de onderstaande 2D-barcode.

Polski

Aby uzyskać szczegółowe informacje na temat produktów, skontaktuj się z najbliższym przedstawicielem firmy Yamaha lub autoryzowanym dystrybutorem, którego znajdziesz za pośrednictwem poniższego kodu kreskowego 2D.

Русский

Чтобы узнать подробнее о продукте (продуктах), свяжитесь с ближайшим представителем или авторизованным дистрибьютором Yamaha, воспользовавшись двухмерным штрихкодом ниже.

Dansk

Hvis du vil have detaljer om produktet/produkterne, kan du kontakte den nærmeste Yamaha-repræsentant eller autoriserede Yamaha-distributør, som du finder ved at scanne 2D-stregkode nedenfor.

Svenska

Om du vill ha mer information om produkterna kan du kontakta närmaste Yamaha-representant eller auktoriserade distributör med hjälp av 2D-streckkoden nedan.



https://manual.yamaha.com/dmi/address_list/

Čeština

Podrobnosti o produktu(ech) získáte od nejbližšího zástupce společnosti Yamaha nebo autorizovaného distributora, který by byl nalezen při použití 2D čárového kódu níže.

Slovenčina

Podrobné informácie o produkte(-och) vám poskytnie najbližší zástupca spoločnosti Yamaha alebo autorizovaný distribútor, ktorého nájdete pomocou nižšie uvedeného 2D čiarového kódu.

Magyar

A termék(ek)re vonatkozó részletekért forduljon a legközelebbi Yamaha képviselőhöz vagy a hivatalos forgalmazóhoz, amelyet az alábbi 2D vonalkód segítségével találhat meg.

Slovenščina

Če želite podrobnejše informacije o izdelkih, se obrnite na najbližjega Yamahinega predstavnika ali pooblaščenega distributerja, ki ga najdete prek 2D-kode v nadaljevanju.

Български

За подробности относно продукта/ите се свържете с най-близкия представител на Yamaha или оторизиран дистрибутор, който можете да откриете, като използвате 2D баркода по-долу.

Română

Pentru detalii privind produsele, contactați cel mai apropiat reprezentant Yamaha sau distribuitorul autorizat, pe care îl puteți găsi accesând codul de bare 2D de mai jos.

Latviešu

Lai iegūtu plašāku informāciju par izstrādājumiem, sazinieties ar tuvāko Yamaha pārstāvi vai pilnvaroto izplatītāju, kuru atradīsiet, izmantojot tālāk pieejamo 2D svītrkodu.

Lietuvių

Norėdami gauti daugiau informacijos apie gaminį (-ius), kreipkitės į artimiausią „Yamaha“ atstovą arba įgaliotąjį platintoją, kurį rasite nuskaitytą toliau pateiktą 2D brūkšninį kodą.

Eesti

Toodete kohta täpsema teabe saamiseks võtke ühendust lähima Yamaha esindaja või autoriseeritud levitajaga, kelle leiate allpool asuva 2D-võõtkoodi kaudu.

Hrvatski

Za detalje o proizvodima obratite se lokalnom predstavku ili ovlaštenom distributeru tvrtke Yamaha, kojeg možete pronaći skeniranjem 2D crtičnog koda u nastavku.

Türkçe

Ürünler hakkında ayrıntılar için, aşağıdaki 2D kodlu motora erişerek bulunan size en yakın Yamaha temsilcisine veya yetkili bayiye başvurun.

Head Office/Manufacturer: Yamaha Corporation 10-1, Nakazawa-cho, Chuo-ku, Hamamatsu, 430-8650, Japan

DMI36_22m

Importer (European Union): Yamaha Music Europe GmbH Siemensstrasse 22-34, 25462 Rellingen, Germany

Importer (United Kingdom): Yamaha Music Europe GmbH (UK) Sherbourne Drive, Tilbrook, Milton Keynes, MK7 8BL, United Kingdom

