



CINEMA DSP
DIGITAL

RX-V3000

Natural Sound AV Receiver
Ampli-Tuner Audio-Video



*OWNER'S MANUAL
MODE D'EMPLOI*

IMPORTANT SAFETY INSTRUCTIONS

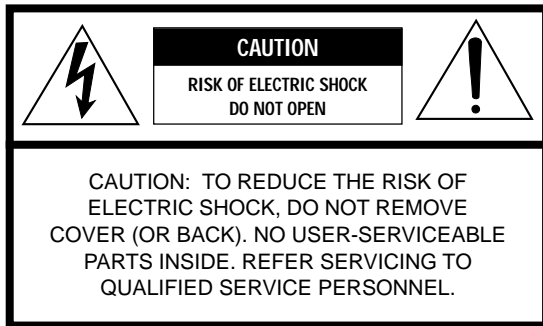

- Explanation of Graphical Symbols

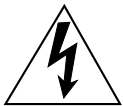

The lightning flash with arrowhead symbol, within an equilateral triangle, is intended to alert you to the presence of uninsulated “dangerous voltage” within the product’s enclosure that may be of sufficient magnitude to constitute a risk of electric shock to persons.



The exclamation point within an equilateral triangle is intended to alert you to the presence of important operating and maintenance (servicing) instructions in the literature accompanying the appliance.

WARNING

TO REDUCE THE RISK OF FIRE OR ELECTRIC SHOCK, DO NOT EXPOSE THIS UNIT TO RAIN OR MOISTURE.

- 1** Read Instructions – All the safety and operating instructions should be read before the unit is operated.
- 2** Retain Instructions – The safety and operating instructions should be retained for future reference.
- 3** Heed Warnings – All warnings on the unit and in the operating instructions should be adhered to.
- 4** Follow Instructions – All operating and other instructions should be followed.
- 5** Water and Moisture – The unit should not be used near water – for example, near a bathtub, washbowl, kitchen sink, laundry tub, in a wet basement, or near a swimming pool, etc.
- 6** Carts and Stands – The unit should be used only with a cart or stand that is recommended by the manufacturer.
- 6A** A unit and cart combination should be moved with care. Quick stops, excessive force, and uneven surfaces may cause the unit and cart combination to overturn.
- 7** Wall or Ceiling Mounting – The unit should be mounted to a wall or ceiling only as recommended by the manufacturer.
- 8** Ventilation – The unit should be situated so that its location or position does not interfere with its proper ventilation. For example, the unit should not be situated on a bed, sofa, rug, or similar surface, that may block the ventilation openings; or placed in a built-in installation, such as a bookcase or cabinet that may impede the flow of air through the ventilation openings.
- 9** Heat – The unit should be situated away from heat sources such as radiators, stoves, or other appliances that produce heat.
- 10** Power Sources – The unit should be connected to a power supply only of the type described in the operating instructions or as marked on the unit.
- 11** Power-Cord Protection – Power-supply cords should be routed so that they are not likely to be walked on or pinched by items placed upon or against them, paying particular attention to cords at plugs, convenience receptacles, and the point where they exit from the unit.
- 12** Cleaning – The unit should be cleaned only as recommended by the manufacturer.
- 13** Nonuse Periods – The power cord of the unit should be unplugged from the outlet when left unused for a long period of time.
- 14** Object and Liquid Entry – Care should be taken so that objects do not fall into and liquids are not spilled into the inside of the unit.
- 15** Damage Requiring Service – The unit should be serviced by qualified service personnel when:
 - A.** The power-supply cord or the plug has been damaged; or
 - B.** Objects have fallen, or liquid has been spilled into the unit; or
 - C.** The unit has been exposed to rain; or
 - D.** The unit does not appear to operate normally or exhibits a marked change in performance; or
 - E.** The unit has been dropped, or the cabinet damaged.
- 16** Servicing – The user should not attempt to service the unit beyond those means described in the operating instructions. All other servicing should be referred to qualified service personnel.
- 17** Power Lines – An outdoor antenna should be located away from power lines.
- 18** Grounding or Polarization – Precautions should be taken so that the grounding or polarization is not defeated.
- 19 For US customers only:**
 - Outdoor Antenna Grounding** – If an outside antenna is connected to this unit, be sure the antenna system is grounded so as to provide some protection against voltage surges and built-up static charges. Article 810 of the National Electrical Code, ANSI/NFPA 70, provides information with regard to proper grounding of the mast and supporting structure, grounding of the lead-in wire to an antenna discharge unit, size of grounding conductors, location of antenna discharge unit, connection to grounding electrodes, and requirements for the grounding electrode.



Note to CATV system installer:

This reminder is provided to call the CATV system installer's attention to Article 820-40 of the NEC that provides guidelines for proper grounding and, in particular, specifies that the cable ground shall be connected to the grounding system of the building, as close to the point of cable entry as practical.

EXAMPLE OF ANTENNA GROUNDING

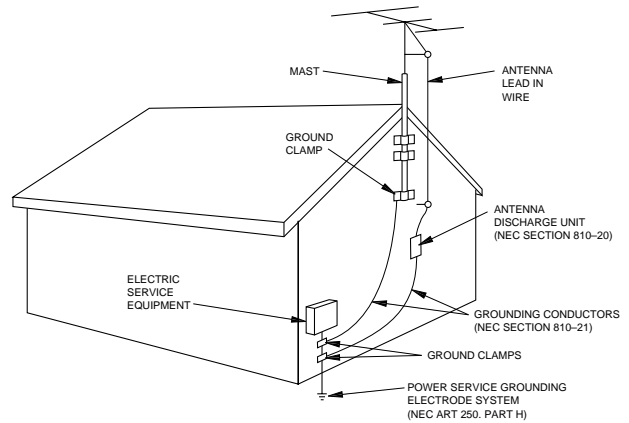

NEC – NATIONAL ELECTRICAL CODE

FCC INFORMATION (for US customers only)

1. IMPORTANT NOTICE : DO NOT MODIFY THIS UNIT!

This product, when installed as indicated in the instructions contained in this manual, meets FCC requirements. Modifications not expressly approved by Yamaha may void your authority, granted by the FCC, to use the product.

2. IMPORTANT : When connecting this product to accessories and/or another product use only high quality shielded cables. Cable/s supplied with this product **MUST** be used. Follow all installation instructions. Failure to follow instructions could void your FCC authorization to use this product in the USA.

3. NOTE : This product has been tested and found to comply with the requirements listed in FCC Regulations, Part 15 for Class "B" digital devices. Compliance with these requirements provides a reasonable level of assurance that your use of this product in a residential environment will not result in harmful interference with other electronic devices.

This equipment generates/uses radio frequencies and, if not installed and used according to the instructions found in the users manual, may cause interference harmful to the operation of other electronic devices.

Compliance with FCC regulations does not guarantee that interference will not occur in all installations. If this product is found to be the source of interference, which can be determined by turning the unit "OFF" and "ON", please try to eliminate the problem by using one of the following measures:

Relocate either this product or the device that is being affected by the interference.

Utilize power outlets that are on different branch (circuit breaker or fuse) circuits or install AC line filter/s.

In the case of radio or TV interference, relocate/reorient the antenna. If the antenna lead-in is 300 ohm ribbon lead, change the lead-in to coaxial type cable.

If these corrective measures do not produce satisfactory results, please contact the local retailer authorized to distribute this type of product. If you can not locate the appropriate retailer, please contact Yamaha Electronics Corp., U.S.A. 6660 Orangethorpe Ave, Buena Park, CA 90620.

The above statements apply **ONLY** to those products distributed by Yamaha Corporation of America or its subsidiaries.

We Want You Listening For A Lifetime

YAMAHA and the Electronic Industries Association's Consumer Electronics Group want you to get the most out of your equipment by playing it at a safe level. One that lets the sound come through loud and clear without annoying blaring or distortion – and, most importantly, without affecting your sensitive hearing.

Since hearing damage from loud sounds is often undetectable until it is too late, YAMAHA and the Electronic Industries Association's Consumer Electronics Group recommend you to avoid prolonged exposure from excessive volume levels.



CAUTION

CAUTION: READ THIS BEFORE OPERATING THIS UNIT.

- 1 To assure the finest performance, please read this manual carefully. Keep it in a safe place for future reference.
- 2 Install this unit in a well ventilated, cool, dry, clean place with at least 30 cm on the top, 20 cm on the right and left, and 10 cm at the back of this unit for ventilation space — away from direct sunlight, heat sources, vibration, dust, moisture, and/or cold.
- 3 Locate this unit away from other electrical appliances, motors, or transformers to avoid humming sounds. To prevent fire or electrical shock, do not place this unit where it may get exposed to rain, water, and/or any type of liquid.
- 4 Do not expose this unit to sudden temperature changes from cold to hot, and do not locate this unit in a environment with high humidity (i.e. a room with a humidifier) to prevent condensation inside this unit, which may cause an electrical shock, fire, damage to this unit, and/or personal injury.
- 5 On the top of this unit, do not place:
 - Other components, as they may cause damage and/or discoloration on the surface of this unit.
 - Burning objects (i.e. candles), as they may cause fire, damage to this unit, and/or personal injury.
 - Containers with liquid in them, as they may cause electrical shock to the user and/or damage to this unit.
- 6 Do not cover this unit with a newspaper, tablecloth, curtain, etc. in order not to obstruct heat radiation. If the temperature inside this unit rises, it may cause fire, damage to this unit, and/or personal injury.
- 7 Do not plug in this unit to a wall outlet until all connections are complete.
- 8 Do not operate this unit upside-down. It may overheat, possibly causing damage.
- 9 Do not use force on switches, knobs, and/or cords.
- 10 When disconnecting the power cord from the wall outlet, grasp the plug; do not pull the cord.
- 11 Do not clean this unit with chemical solvents; this might damage the finish. Use a clean, dry cloth.
- 12 Only the voltage specified on this unit must be used. Using this unit with a higher voltage than specified is dangerous and may cause fire, damage to this unit, and/or personal injury. YAMAHA will not be held responsible for any damage resulting from use of this unit with a voltage other than specified.
- 13 To prevent damage by lightning, disconnect the power cord from the wall outlet during an electrical storm.
- 14 Take care of this unit so that no foreign objects and/or liquid drops inside this unit.
- 15 Do not attempt to modify or fix this unit. Contact qualified YAMAHA service personnel when any service is needed. The cabinet should never be opened for any reasons.
- 16 When not planning to use this unit for long periods of time (i.e. vacation), disconnect the AC power plug from the wall outlet.
- 17 Be sure to read the “Troubleshooting” section on common operating errors before concluding that this unit is faulty.
- 18 Before moving this unit, press STANDBY/ON to set this unit in the standby mode, and disconnect the AC power plug from the wall outlet.

This unit is not disconnected from the AC power source as long as it is connected to the wall outlet, even if this unit itself is turned off. This state is called the standby mode. In this state, this unit is designed to consume a very small quantity of power.

FREQUENCY STEP switch

(General and China models only)

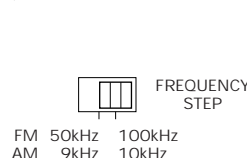

Because the interstation frequency spacing differs in different areas, set the FREQUENCY STEP switch (located at the rear) according to the frequency spacing in your area. Be sure to change the setting of this switch with the AC supply lead of this unit disconnected from the AC outlet.

For CANADIAN CUSTOMERS

To prevent electric shock, match wide blade of plug to wide slot and fully insert.

This Class B digital apparatus complies with Canadian ICES-003.



Manufactured under license from Dolby Laboratories. “Dolby”, “AC-3”, “Pro Logic” and the double-D symbol are trademarks of Dolby Laboratories.

Confidential Unpublished Works. ©1992-1997 Dolby Laboratories, Inc. All rights reserved.



Manufactured under license from Digital Theater Systems, Inc. US Pat. No. 5,451,942 and other world-wide patents issued and pending. “DTS”, “DTS Digital Surround” and “DTS ES” are trademarks of Digital Theater Systems, Inc. Copyright 1996 Digital Theater Systems, Inc. All Rights Reserved.

Contents

| | |
|---|-----------|
| <i>Introduction</i> | 2 |
| Getting Started | 3 |
| Controls and Functions | 4 |
| <i>Preparations</i> | 8 |
| Speaker System Configurations | 9 |
| Hookups | 10 |
| On-Screen Displays (OSD) | 19 |
| Speaker Placement | 20 |
| Speaker Settings | 21 |
| Speaker Output Levels | 22 |
| <i>Basic Operation</i> | 24 |
| Basic Playback | 25 |
| AM/FM Tuner | 29 |
| Basic Recording | 33 |
| <i>Advanced Operation</i> | 34 |
| SET MENU Items | 35 |
| Remote Control Features | 44 |
| ZONE 2 | 55 |
| Adjusting the Levels of the Effect Speakers | 57 |
| Setting the Sleep Timer | 57 |
| <i>Additional Information</i> | 58 |
| Digital Sound Field Processing (DSP) | 59 |
| CINEMA-DSP | 61 |
| DSP Parameter | 64 |
| <i>Appendix</i> | 68 |
| Troubleshooting | 69 |
| Specifications | 73 |

Introduction

Welcome to the exciting world of digital home entertainment. This unit is the most complete and advanced AV receiver available. Though some of the more advanced features of this unit may not be familiar to you, they are easy to use. Incorporated state-of-the-art technology such as Dolby Digital and DTS can bring the same audio experience to your home as they have brought to feature films in quality theaters around the world. To make the listening experience even more enjoyable, this unit includes a number of exclusive, digitally created listening environments known as digital sound fields. Choosing a sound field program is like transporting yourself to such venues as an outdoor arena, a European church, or a cozy jazz club. Take some time now to read more about these features and enjoy the new experiences this unit brings to your home theater.

Features

- **Dolby Digital and DTS decoder**
- **Dolby Digital Matrix 6.1/DTS ES decoder**
- **Digital Sound Fields (DSP)**
- **CINEMA-DSP: Dolby Digital + DSP and DTS + DSP**
- **Virtual CINEMA DSP and HP CINEMA DSP**
- **Multi-function remote control**
- **Built-in 8-channel power amplifier**

Getting Started

3

| | |
|--|---|
| Checking the Package Contents | 3 |
| Installing Batteries in the Remote Control | 3 |
| Using the Remote Control | 3 |

Controls and Functions

4

| | |
|--------------------------|---|
| Front Panel | 4 |
| Display Indicators | 5 |
| Rear panel | 6 |
| Remote Control | 7 |

Getting Started

Checking the Package Contents

Check your package to make sure it has the following items.

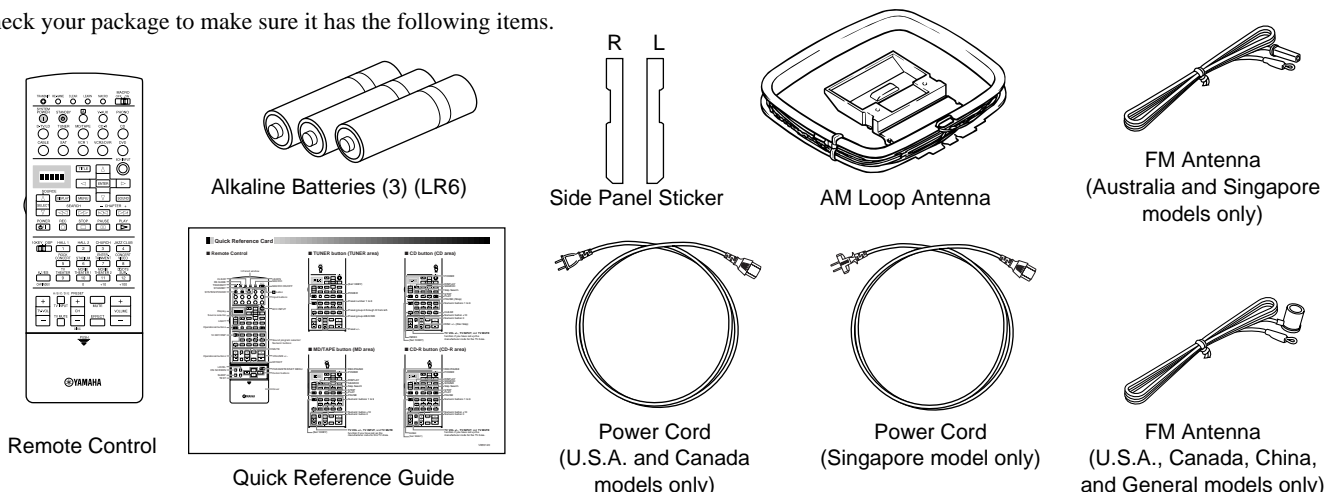

When finding it difficult to fit this unit onto the shelf, remove the side panels after removing the screws tightened on the side panels. Put this sticker to cover the screw holes after tearing off the back side of the sticker.

Installing Batteries in the Remote Control

Insert the batteries in the correct direction by aligning the + and – marks on the batteries with the polarity illustrations (+ and –) inside the battery compartment.

Change the batteries periodically. Do not use old batteries together with new ones.

Do not use different types of batteries (such as alkaline and manganese batteries) together. Read the packaging carefully as these different types of batteries may have the same shape and color.

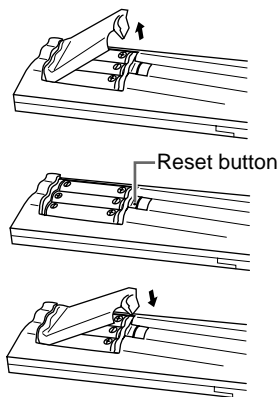

About changing batteries

As the batteries wear out, the operating range of the remote control decreases and the **TRANSMIT** indicator does not flash or its light becomes dim. When you notice any of these conditions, change all of the batteries.

Notes:

- If the remote control is without batteries for more than 20 minutes, or if worn out batteries remain in the unit, the contents of the memory may be cleared. If the memory is cleared, insert new batteries and reprogram any functions that may have been cleared.
- After you insert new batteries, be sure to push **RESET** in the battery compartment using a ball point pen or similar object before using the remote control. (This does not clear the contents of the memory.)

Using the Remote Control

The remote control transmits a directional infrared beam. Be sure to aim the remote control directly at the remote control sensor on the main unit to operate. When the sensor is covered or there is a large object between the remote control and the main unit, the sensor cannot receive signals. The sensor may not be able to receive signals properly when it is exposed to direct sunlight or a strong artificial light (such as a fluorescent or strobe light). In this case, change the direction of the light or reposition the main unit to avoid direct lighting.

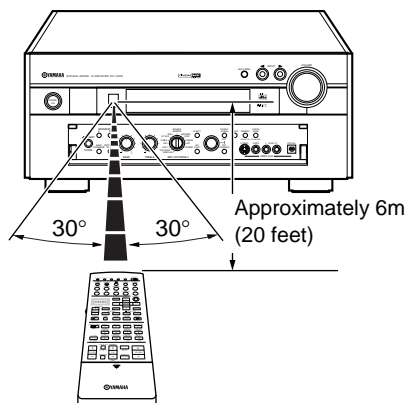

About handling the remote control

Handle the remote control with care.

Do not spill water or other liquids on the remote control.

Do not drop the remote control.

Do not leave or store the remote control in the following types of conditions:

- high humidity or temperature such as near a heater, stove or bath; or
- dusty places; or
- in places subject to extremely low temperatures.

Controls and Functions

Front Panel

When you are not operating the controls behind the front panel door, close the door. To open the door, press gently on the lower part of the panel.

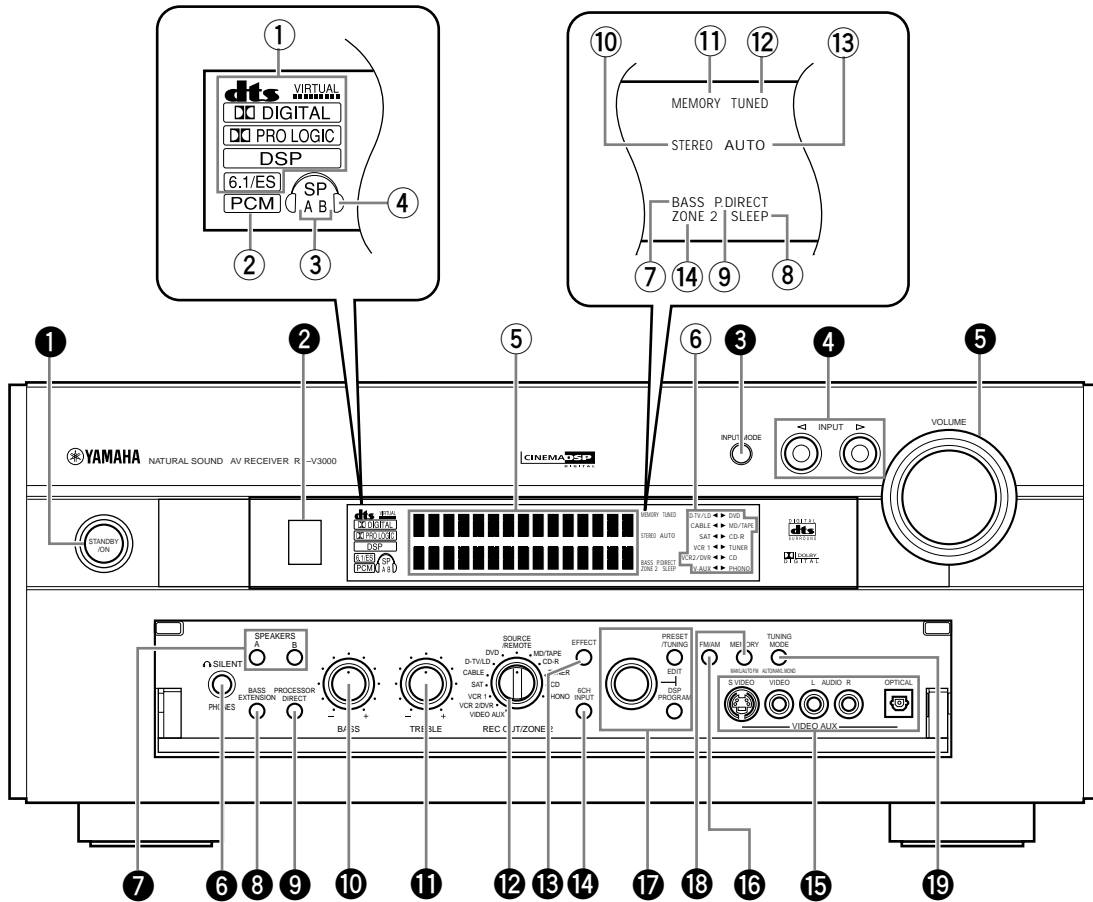

1 STANDBY/ON

Turns this unit on (On mode) and off (Standby mode). When you turn on this unit, you will hear a click and there will be a four to five second delay before this unit can reproduce sound. In Standby mode, this unit consumes a small amount of power to be ready to respond to the remote control.

2 Remote Control Sensor

3 INPUT MODE

Selects the type of audio signal for the selected source.

4 INPUT selector

Selects a source component.

5 VOLUME

Controls the output level of all audio channels. This does not affect the REC OUT level.

6 PHONES

Outputs audio signals for private listening using headphones. When you connect headphones, no signals are output to the PREOUT jacks or the speakers.

7 SPEAKERS A/B

When SPEAKERS A/B is on, these buttons turn on the set of Main speakers connected to the A and/or B terminals on the rear panel.

8 BASS EXTENSION ON/OFF

When BASS EXTENSION is on, this feature boosts the bass frequency of the left and right Main channels by +6dB (60Hz) while maintaining overall tonal balance. This boost is useful if you do not use a subwoofer. However, this boost may not be noticeable if the Main speakers are set to "SMALL" and the bass output mode is set to "SWFR."

9 PROCESSOR DIRECT ON/OFF

When PROCESSOR DIRECT is on, BASS, TREBLE, BALANCE, and BASS EXTENSION are bypassed, eliminating any alteration of the original signal.

10 BASS

Adjusts the low frequency response for the left and right Main speaker channels. Turn the control to the right to increase the low frequency response and turn the control to the left to decrease the low frequency response.

11 TREBLE

Adjusts the high frequency response for the left and right Main channels. Turn the control to the right to increase the high frequency response.

12 REC OUT/ZONE 2

Selects the source you want to direct to the audio/video recorder.

13 EFFECT

Switches the effect speakers (Center, Front Effect, Rear and Rear Center) on and off. If you turn off the output of these speakers using **EFFECT**, all DTS and Dolby Digital audio signals are directed to the Main left and right channels except for the LFE channel.

14 6CH INPUT

Switches between 6CH INPUT mode and normal input modes. 6CH INPUT mode takes priority over the source selected with the **INPUT** selector. You cannot use DSP sound field programs while using an external decoder.

15 VIDEO AUX

Inputs audio and video signals from a portable external source such as a video camera. To reproduce source signals from these jacks, select V-AUX as the input source. To direct this source to the **VCR 1** and **VCR 2/DVR** output jacks, select VIDEO AUX using **REC OUT**.

16 FM/AM

Switches the reception band between FM and AM.

17 Multi jog knob

Selects the tuning frequency in the tuning mode.

Selects the preset station after pressing **PRESET/TUNING** to display a colon (:) in the tuning mode.

Selects the DSP program after pressing **DSP PROGRAM**.

18 MEMORY (MAN'L/AUTO FM)

Stores a station in the memory.

19 TUNING MODE (AUTO/MAN'L MONO)

Switches the tuning mode between automatic and manual. To select the automatic tuning mode, press this button so that the AUTO tuning indicator appears in the front panel display (the STEREO indicator also appears if receiving a stereo broadcast).

To select the manual tuning mode, press this button so that the AUTO tuning indicator does not appear.

Display Indicators**1 Processor indicators**

When any function of DTS/VIRTUAL/Dolby Digital/Dolby PROLOGIC/DSP/Dolby Digital Matrix 6.1/DTS ES is operating, its indicator lights up.

2 PCM

Lights up when this unit is reproducing PCM (Pulse Code Modulation) digital audio signals.

3 SPEAKERS A/B

Lights up according to which set of Main speakers is selected. Both indicators light up when both sets of speakers are selected.

4 Headphones

Lights up when headphones are connected.

5 Multi-information display

Shows the current DSP program and other information when adjusting or changing settings.

6 Input source

Shows the current input source with the arrow-shaped cursor.

7 BASS

Lights up while the **BASS EXTENSION** is on.

8 SLEEP

Lights up while the Sleep Timer is on.

9 P. DIRECT

Lights up while the **PROCESSOR DIRECT** is on.

10 STEREO

Lights up when the AUTO tuning indicator is on and the unit is receiving a strong signal for an FM stereo broadcast.

11 MEMORY

Flashes to show a station can be saved.

12 TUNED

Lights up when this unit tunes into a station.

13 AUTO

Shows that the Tuner is in Automatic tuning mode.

14 ZONE 2

Lights up when you select the input source while the remote control is in the Zone 2 mode.

Rear panel

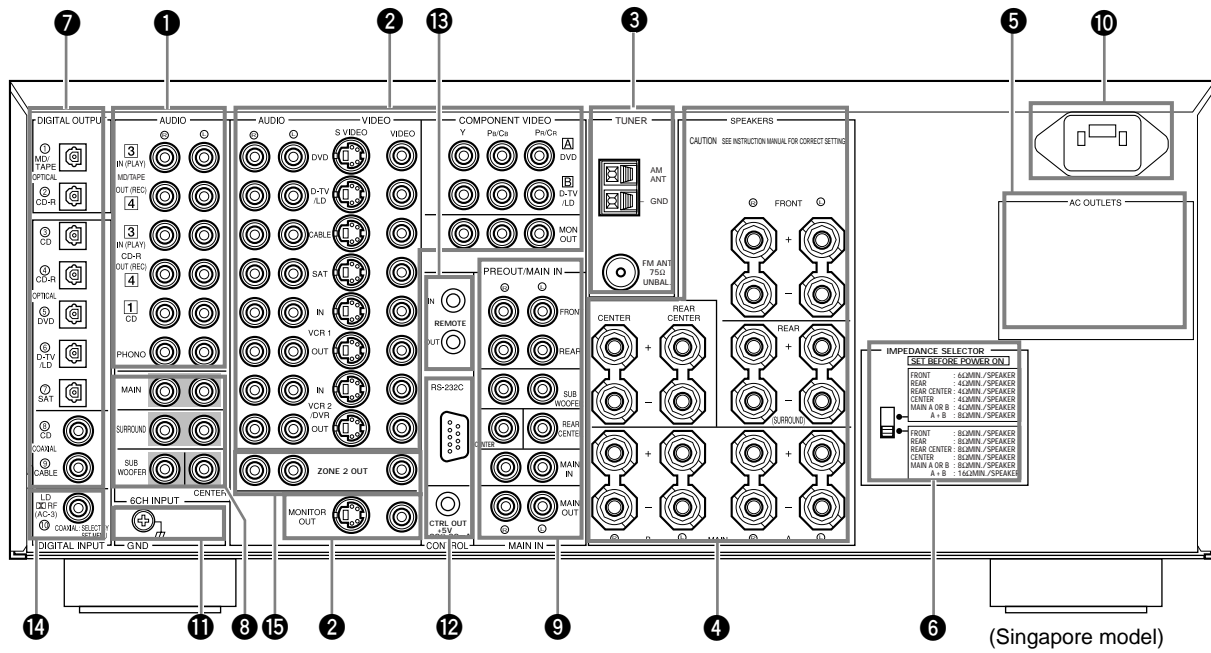

① Audio component jacks

② Video component jacks

③ Antenna input terminals

④ Speaker terminals

⑤ AC OUTLETS

Use these outlets to supply power to your other audio/video component.

⑥ IMPEDANCE SELECTOR

⑦ DIGITAL OPTICAL/COAXIAL jacks

⑧ 6CH INPUT jacks

⑨ PRE OUT/MAIN IN jacks

⑩ AC power cord

Connect to a power outlet.

General, China, and Australia models cannot disconnect the AC power cord from the unit.

⑪ GROUND terminal

⑫ RS232C/CTRL OUT +5V terminals

These are control expansion terminals for Substitute Custom Installation use. Consult your dealer for details.

⑬ REMOTE IN/OUT jacks

⑭ RF (AC-3) input jack

General, China, and Singapore models only.

⑮ ZONE 2 OUT jack

Remote Control

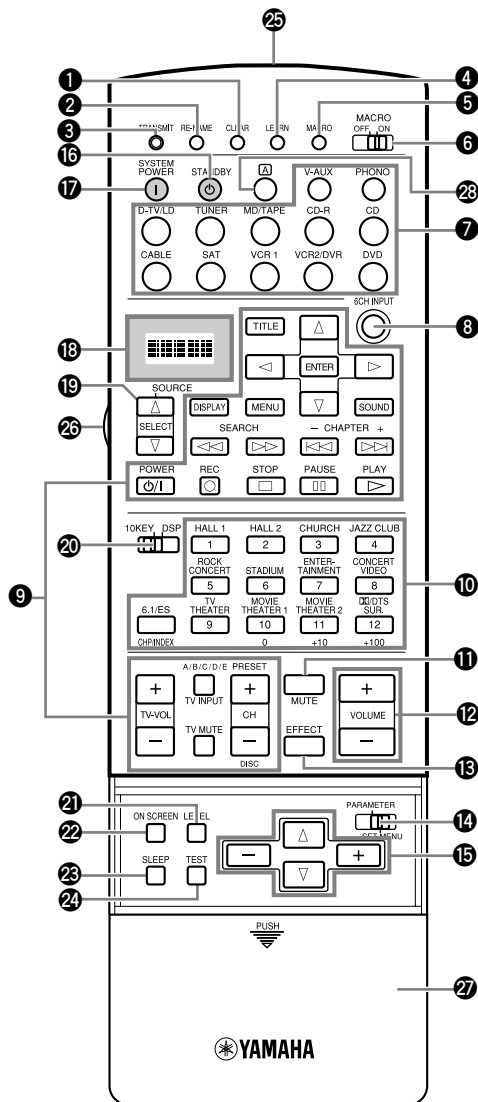

- 1 CLEAR**
Erases the content of learning.
- 2 RE-NAME**
Renames the input name.
- 3 TRANSMIT**
Flashes while the remote control is sending signals.
- 4 LEARN**
Starts the learning function.
- 5 MACRO**
Makes the MACRO setting.
- 6 MACRO ON/OFF**
Turns the macro function on and off.
- 7 Input buttons**
Selects the input source for playback.
- 8 6CH INPUT**
Switches to the 6CH INPUT mode when using an external decoder.
- 9 Operational buttons**
Performs the operation selected by input selector.
- 10 Sound program selector/Numeric buttons**
Selects the sound program.
- 11 MUTE**
Mutes the sound. Press again to restore audio output at the previous volume level.
- 12 VOLUME +/-**
Increases or decreases the volume level.
- 13 EFFECT**
Switches the effect speakers (Center, Front, Rear, and Rear Center) on and off.
- 14 PARAMETER/SET MENU**
Selects the PARAMETER mode or SET MENU mode.
- 15 Cursor buttons**
Selects and adjusts DSP program parameters and SET MENU items according to the position of PARAMETER/SET MENU.
- 16 STANDBY**
Turns off the power.
- 17 SYSTEM POWER**
Turns on the power.
- 18 Display**
Displays the input or operation status.
- 19 Source selector**
Selects the source component.
- 20 10 KEY/DSP**
Selects the numeric button mode or DSP program mode.
- 21 LEVEL**
Selects the effect speaker channel to be adjusted and sets the level.
- 22 ON SCREEN**
Selects the On-Screen Display mode for your video monitor.
- 23 SLEEP**
Sets the sleep timer.
- 24 TEST**
Outputs the test tone to adjust the speaker levels.
- 25 Infrared window**
- 26 LIGHT**
Turns the light on or off. When you press this button once, the light turns on for about ten seconds. Press again to turn off the light.
- 27 Cover**
- 28 A button**
Switches the control area.

Preparations

Speaker System Configurations **9**

Hookups **10**

| | |
|--------------------------------------|----|
| Connecting Audio Components | 10 |
| Connecting Video Components | 12 |
| Connecting Speakers | 14 |
| Connecting Subwoofers | 16 |
| Connecting an External Decoder | 17 |
| Connecting External Amplifiers | 17 |
| Others | 18 |

On-Screen Displays (OSD) **19**

| | |
|------------------------------|----|
| OSD Modes | 19 |
| Selecting the OSD Mode | 19 |

Speaker Placement **20**

Speaker Settings **21**

Speaker Output Levels **22**

| | |
|---------------------------|----|
| Before You Begin | 22 |
| Dolby Surround Test | 22 |
| DSP Test | 23 |

Speaker System Configurations

The most complete speaker configuration consists of eight speakers: the left and right Main speakers, a Center speaker, the left and right Rear speakers, the left and right Front Effect speakers, and a Rear Center speaker. If you do not use eight speakers, you can direct the signals for speakers that are not in your system to other speakers in your configuration. A Subwoofer can be used with any of these configurations to produce a fuller sound.

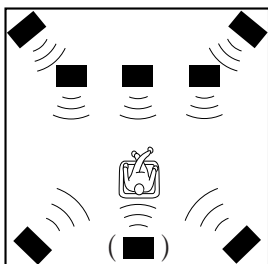
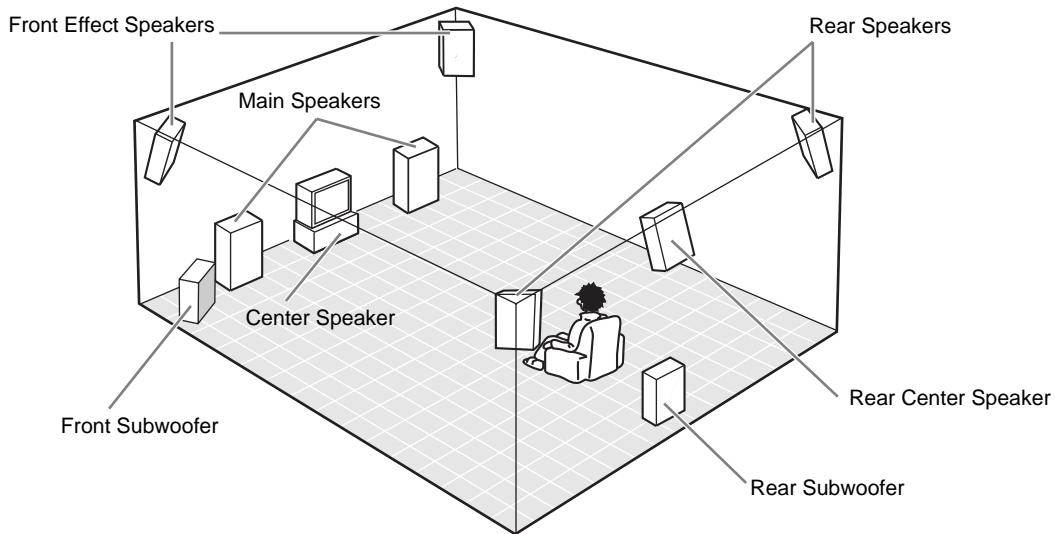

■ Eight or Seven Speaker Configuration –Full Cinema DSP–

When you reproduce feature film software, this configuration fully expresses the powerful and realistic sound qualities of 70 mm multitrack audio. The dialogue is positioned as if it were coming from directly on the screen, the sound effect is positioned slightly behind the screen, and the soundtrack music is positioned even further behind the screen to express the width and depth of the overall presentation. This configuration makes the most of this unit's capability.

The Rear Center speaker is useful for playback of 6-channel Digital Surround.

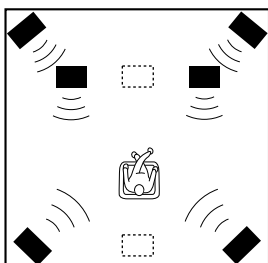

■ Six Speaker Configuration –Hi Fi DSP–

This configuration is used the most for audio playback with HiFi DSP. It does not position the dialogue sound as well as a seven or eight speaker configuration. However, it creates a dynamic DSP (Digital Sound Field Processor) sound field which adds depth to the sound.

For this speaker configuration, change SET MENU item 1A. CENTER SP to "NONE" and 1D. REAR CT SP to "NONE".

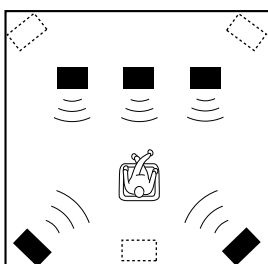

■ Five Speaker Configuration –Standard 5.1 Channel–

This configuration does not express the height of the sound field as well as the seven or eight speaker configuration. However, it positions the dialogue sound as coming directly from the screen.

For this speaker configuration, change SET MENU item 1F. FRNT EFCT SP to "NONE" and 1D. REAR CT SP to "NONE".

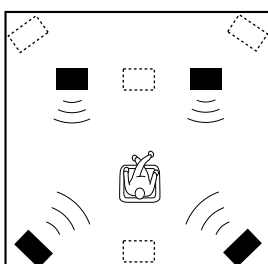

■ Four Speaker Configuration –Minimum Requirement–

In this configuration, the Center speaker signals and Front Effect speaker signals are directed to the left and right Main speakers.

For this speaker configuration, change SET MENU item 1A. CENTER SP to "NONE," item 1F. FRNT EFCT SP to "NONE," and item 1D. REAR CT SP to "NONE".

Connecting Audio Components

Before you connect any components, disconnect the power supply to all the components you plan to connect including this unit and determine which jacks are for the left and right channels and for input and output.

When you connect other YAMAHA audio component (such as a CD player or changer, MD deck, or tape deck), connect to terminals with the same number labels. Yamaha applies this labelling system to all its products.

In the hookup illustrations on the following pages:

■ Connecting to digital jacks

This unit has digital jacks for direct transmission of digital signals through either coaxial or fiber optic cables. You can use the digital jacks to input PCM, DTS, and Dolby Digital bitstreams. When you connect components to both the **COAXIAL** and **OPTICAL** jacks (for CD and CABLE) priority is given to the input signals from the **COAXIAL** jack. All digital input jacks are acceptable for 96 kHz/24 bit digital signals.



■ About the dust protection cap

Pull out the cap from the optical jack before you connect the fiber optic cable. Do not discard the cap. When you are not using the optical jack, be sure to put the cap back in place. This cap protects the jack from dust.

The **OPTICAL** jacks on this unit conform to the EIA standard. If you use a fiber optic cable that does not conform to this standard, this unit may not function properly.

■ Connecting a turntable

These jacks are for connecting a turntable with an MM or high output MC cartridge. If you have a turntable with a low output MC cartridge, use an inline boosting transformer or MC-head amplifier when connecting to these jacks.

The GND terminal does not electrically ground the turntable. It simply reduces noise in the signal. In some cases, you may hear less noise if you do not connect to the GND terminal.

■ Connecting a CD player

- The **COAXIAL CD** and **OPTICAL CD** jacks are available for a CD player which has coaxial or optical digital outputs.
- When you connect a CD player to both the **COAXIAL CD** and **OPTICAL CD** jacks, priority is given to the input signals from the **COAXIAL CD** jack.

■ Connecting an MD or DAT deck

- When you connect a recorder to this unit, keep the deck's power on while using this unit. If the power is off, this unit may distort the sound from other component.
- When you record from source component connected to this unit while this unit's power is off, the recorded sound may be distorted. To avoid this problem, turn on this unit.
- When you connect a CD recorder to both the analog and digital input and output jacks, priority is given to the digital signals.

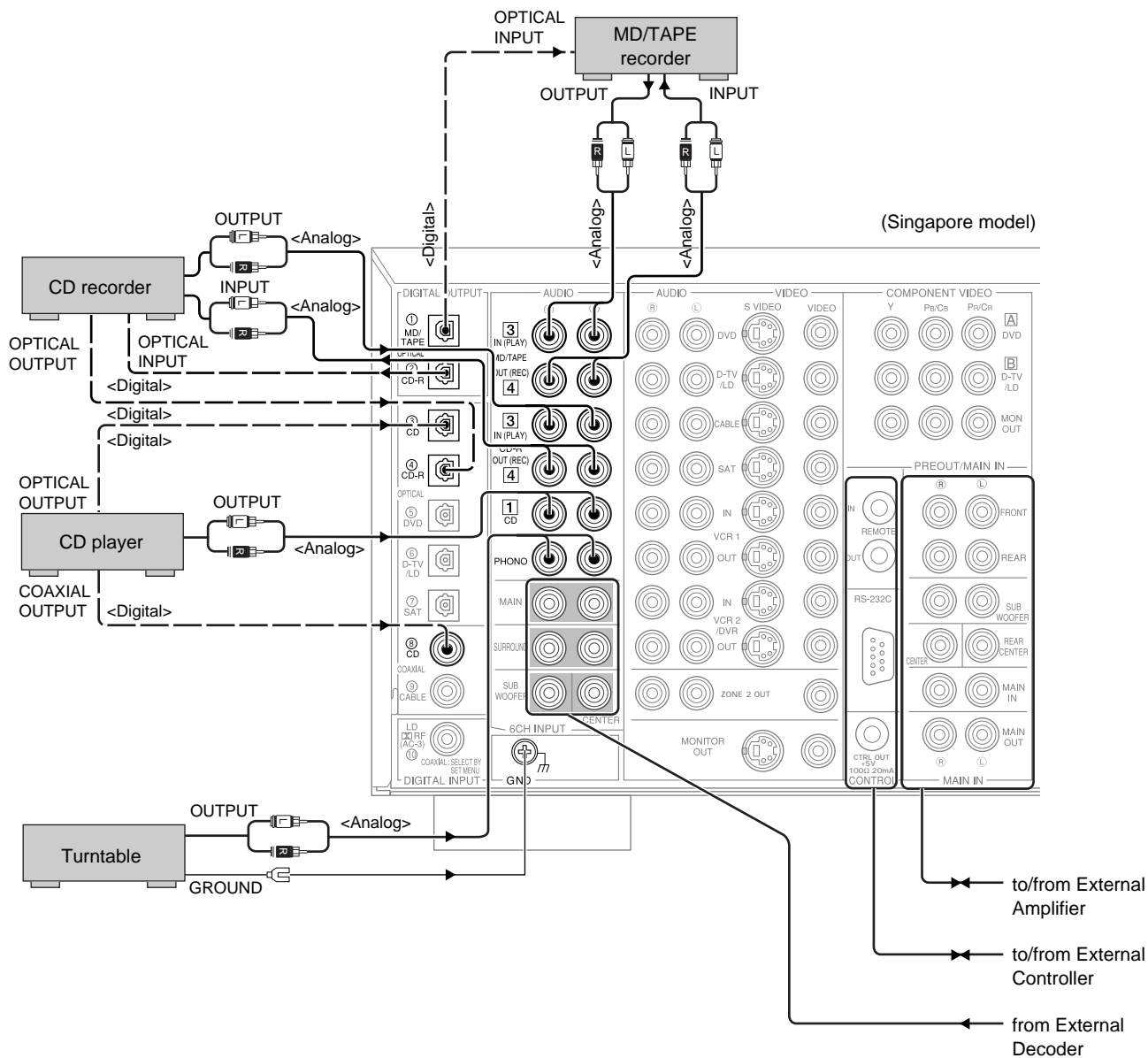

Connecting Video Components

Before you connect any components, disconnect the power supply to all the components you plan to connect including this unit and determine which jacks are for the left and right channels and for input and output. After you finish all hookups, check them again to make sure they are correct.

About the video jacks

There are three types of video jacks. Video signals input through the **VIDEO** jacks are the conventional composite video signals. Video signals input through the **S VIDEO** jacks are separated into luminance (Y) and color (C) video signals. The S-video signals achieve high quality color reproduction.

Video signals input through the **COMPONENT VIDEO** jacks are separated into luminance (Y) and color difference (**P_B/C_B**, **P_R/C_R**) video signals. The jacks are also separated into three for each signal. The labels of the component video jacks may be different depending on the component (e.g. Y, C_B, C_R / Y, P_B, P_R / Y, B-Y, R-Y/ etc.). Component video signals provide the best quality in picture reproduction.

Composite **VIDEO** jack



S VIDEO jack



COMPONENT VIDEO jacks

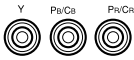

If your video component has an S-video output or component video output, you can connect it to this unit. Connect the S-video signal output jack on your video component to the **S-VIDEO** jack or connect the component signal output jacks on your video component to the **COMPONENT VIDEO** jacks.

Notes:

- Each type of video jack works independently. Signals input through the composite video, S-video, and component jacks are output through the corresponding composite video, S-video, and component jacks respectively.
- Use a commercially available S-video cable when connecting to the **S VIDEO** jacks, and commercially available video cables when connecting to the **COMPONENT VIDEO** jacks.
- When you are using the **COMPONENT VIDEO** jacks, check the details in the owner's manual that came with the component being connected.

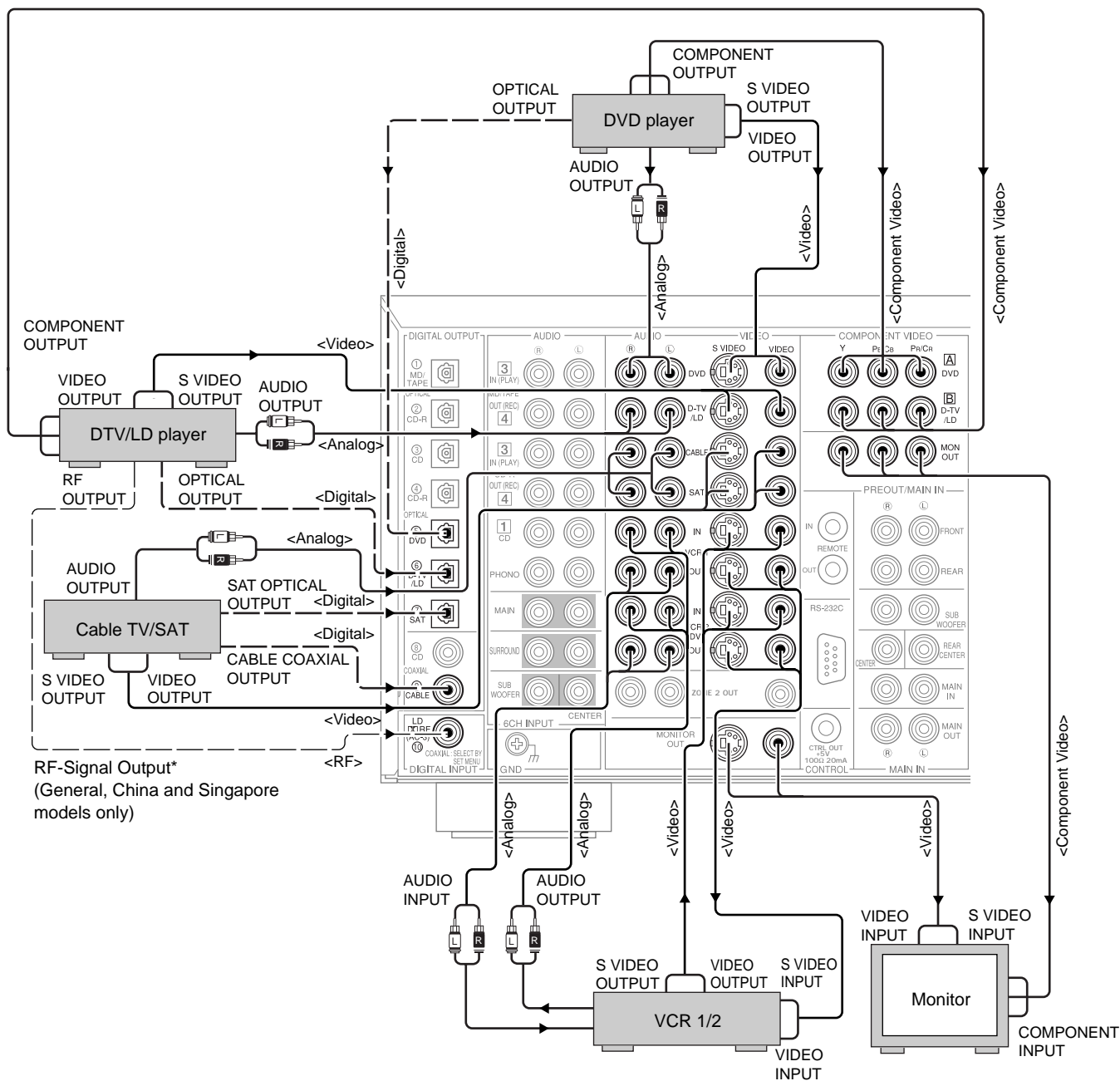

* <U.S.A., Canada, and Australia models>

If your LD player has a Dolby Digital RF signal output jack, connect it to this unit through an external RF demodulator. (You can connect the Dolby Digital RF signal output of your LD player to the **COAXIAL** jacks using the "I/O ASSIGN" on the SET MENU.)

Connecting Speakers

This section explains how to connect speakers to this unit. After you finish connecting your speakers, use the SET MENU to change the signal output settings according to the number and size of the speakers in your configuration.

Before connecting any speaker cords, identify which terminals are for the right and left channels and also the + and – polarities. If you connect speakers with the wrong polarity (+ to –), this unit will not reproduce clear sound.

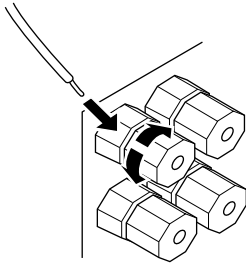

Banana Plug

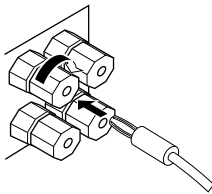

(Except for Singapore model)

Using speaker cords

A speaker cord is actually a pair of insulated cables running side by side. One of the cables is colored or shaped differently, perhaps with a stripe, groove, or ridge. To make sure you always connect speakers with the correct polarity, determine the difference between the cables of your speaker cord, make a note of which cable you plan to use for which polarity (+ and –), and always connect the speaker cords consistently.

- 1 Strip off 9 mm (3/8 in.) of an inch of insulation from the ends of the cables.
- 2 Twist the exposed wires of the cable together to prevent short circuits.
- 3 Loosen the terminal knob by turning it counterclockwise.
- 4 Insert only the exposed portion of the cable into the slot in the side of the terminal, and tighten the terminal knob.

Note:

- If your speaker cords have banana plugs, tighten the terminal knob and insert the plug into the end of the terminal. (Except for Singapore model)

Caution:

- Connect the speaker cords with care to avoid creating a short circuit. If you turn on the power and there is a short circuit, this unit may be damaged even though the protection circuit automatically shuts off the power.

About the RF (AC-3) signal input jack <For China, Singapore, and General models only.>

If your LD player has an RF (AC-3) signal output jack, connect it to the RF (AC-3) input jack on this unit. For this connection, change SET MENU item 7D. COAXIAL IN (10) to “LD-RF”. If RF (AC-3) and analog signals are input at the same time, priority is given to the RF signals. When you want to reproduce RF (AC-3) signals, set the input mode to “D.D. RF” using **INPUT MODE**.

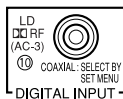

Note:

- RF (AC-3) signals cannot be output using the **REC OUT** selector. When you record sound or images from an LD player, be sure to connect the player to either the **DIGITAL OPTICAL** or analog **AUDIO** jacks.

Caution:

- Even if you connect an LD player with an RF (AC-3) output jack to this unit, you cannot reproduce Dolby Digital sound from all LD discs. You must playback an LD disc encoded with Dolby Digital signals in order to take advantage of the Dolby Digital sound.

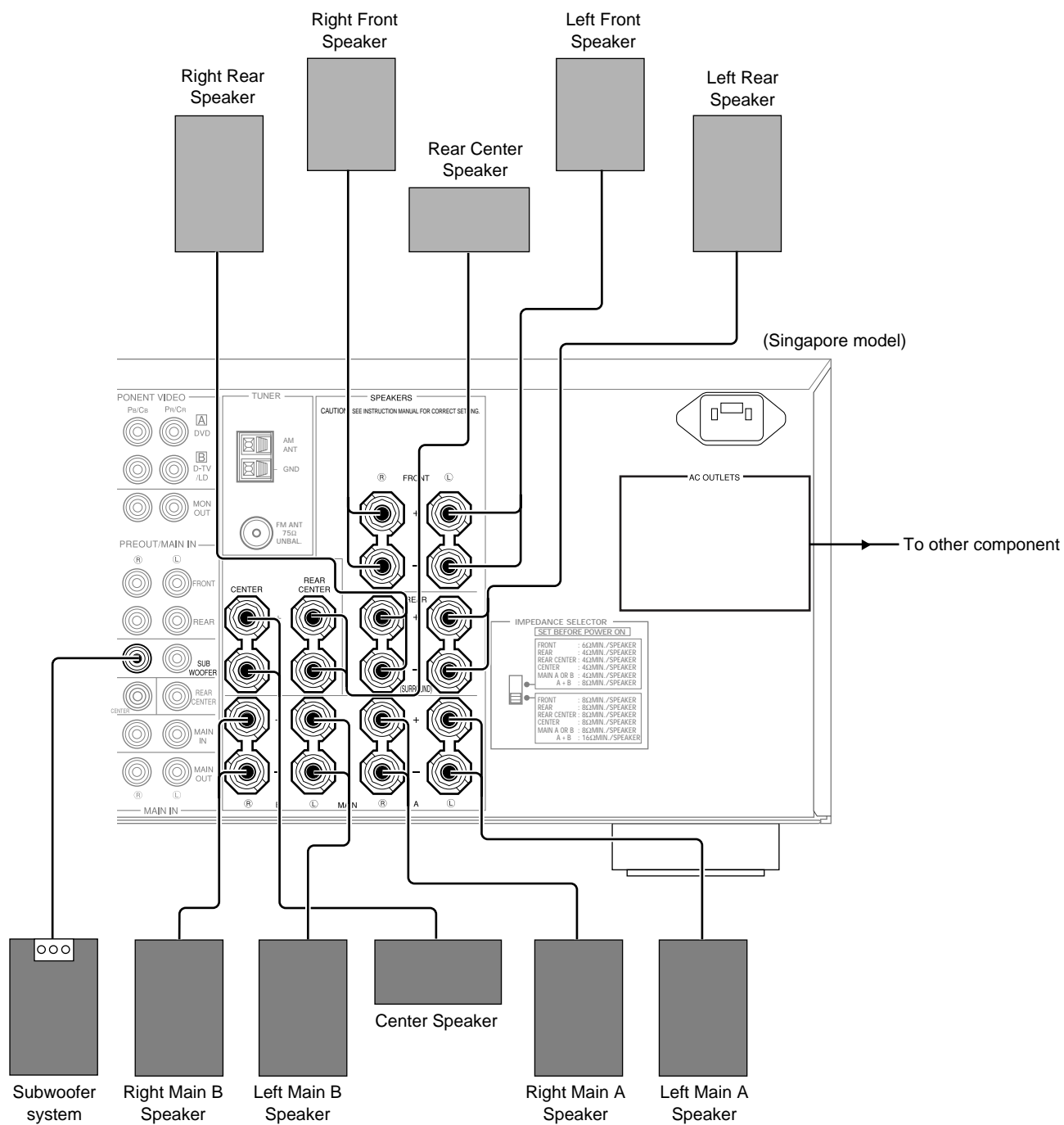

Connecting Subwoofers

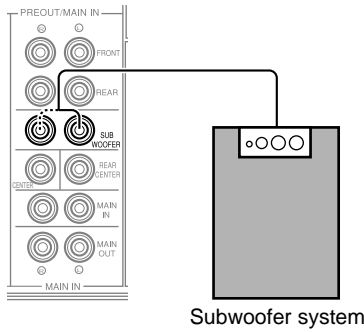

Subwoofer system

■ Connecting a front subwoofer

- Connect the signal input jack on your subwoofer to one of the **PRE OUT/MAIN IN SUBWOOFER** jacks.

Notes:

- The **SUBWOOFER** jacks (output) have a built-in high cut-off filter (90 Hz). When using a powered subwoofer, set the high cut-off frequency to “MAX” on your Subwoofer.
- Both **SUBWOOFER** jacks output the same signal.

■ Connecting a rear subwoofer

By using both Front and Rear Subwoofers, the CINEMA-DSP sound field programs can produce realistic movie effects with powerful, dynamic sound. To take advantage of this dynamic sound, be sure to set the 1C. REAR L/R SP item in the SET MENU to “LARGE”, and connect your Rear speakers and Subwoofer as described below.

- 1 Connect the right + input terminal on your Subwoofer to the **REAR ^R +** terminal, and the right – input terminal on your Subwoofer to the **REAR ^R –** terminal with speaker cords.
- 2 Connect the left + input terminal on your Subwoofer to the **REAR ^L +** terminal, and the left – input terminal on your Subwoofer to the **REAR ^L –** terminal with speaker cords.
- 3 Connect your Rear speakers to the output terminals on the Rear Subwoofer.

Be sure to connect the Rear speakers to the Subwoofer with the correct polarity.

Note:

- Adjust the speaker volume for the Subwoofer with the controls on the Subwoofers, not on this unit.

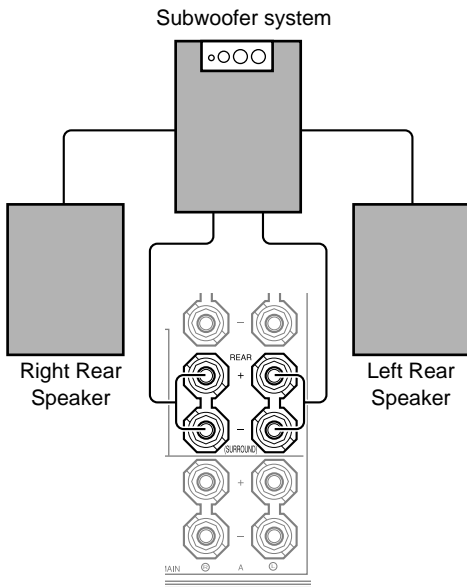

Connecting an External Decoder

This unit is equipped with six additional input jacks (left and right MAIN, CENTER, left and right SURROUND and SUBWOOFER) for discrete multi-channel input from an external decoder, sound processor, or pre-amplifier. Connect the output jacks on your external decoder to the **6CH INPUT** jacks.

Be sure to match the left and right outputs to the left and right input jacks for the main and surround channels.

To listen to the sound from your external decoder, press **6CH INPUT** on this unit or the remote control.

Notes:

- When you select **6CH INPUT** as the input source, this unit automatically turns off the digital sound field processor, and you cannot listen to DSP programs.
- When you select **6CH INPUT** as the input source, changing **SPEAKER SET** on the SET MENU is not affected.

Connecting External Amplifiers

If you want to increase the power output to the speakers, or want to use another amplifier, connect an external amplifier to the **PRE OUT/MAIN IN** terminals as follows.

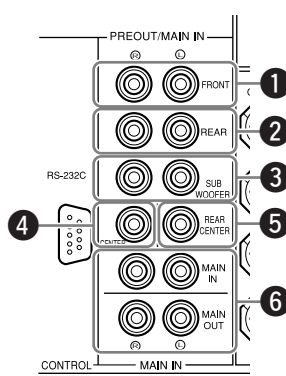

① FRONT jacks

Front Effect channel line output jacks.

② REAR (Surround) jacks

Rear channel line output jacks.

③ SUBWOOFER jacks

Main, Center, and Rear channel frequencies below 90 Hz are output through these jacks. You can also direct DTS and Dolby Digital LFE signals to this output.

Adjust the volume level of the subwoofer with the control on the subwoofer. Subwoofer volume cannot be adjusted from this unit.

④ CENTER jack

Center channel line output jack.

⑤ REAR CENTER jack

Rear Center channel line output jack.

⑥ MAIN jacks

MAIN IN jacks Line input to this unit's Main channel amplifiers.

When connecting to these jacks, signals input to the preamplifier of this unit will not be output from the main amplifier of this unit.

MAIN OUT jacks Main channel line output jacks. The signals output through these jacks are affected by **BASS**, **TREBLE**, **BALANCE**, and **BASS EXTENSION** settings.

Others

Preparations

WARNING

Do not change the **IMPEDANCE SELECTOR** switch setting while the power to this unit is on, otherwise this unit may be damaged.

IF THIS UNIT FAILS TO TURN ON WHEN THE STANDBY/ON SWITCH IS PRESSED:

The **IMPEDANCE SELECTOR** switch may not be set to either end. If so, set the switch to either end when this unit is in the standby mode.

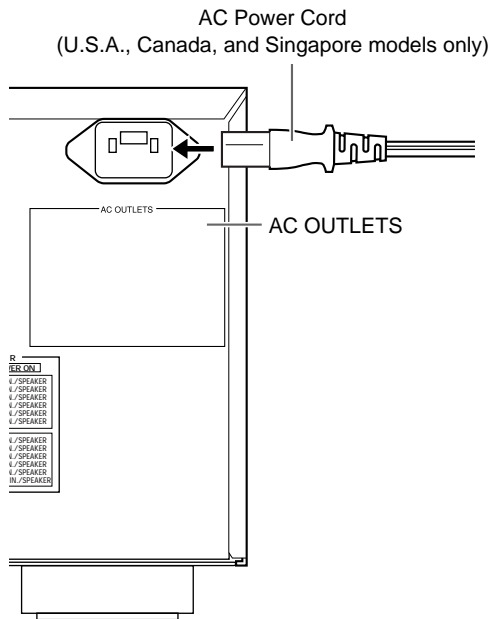
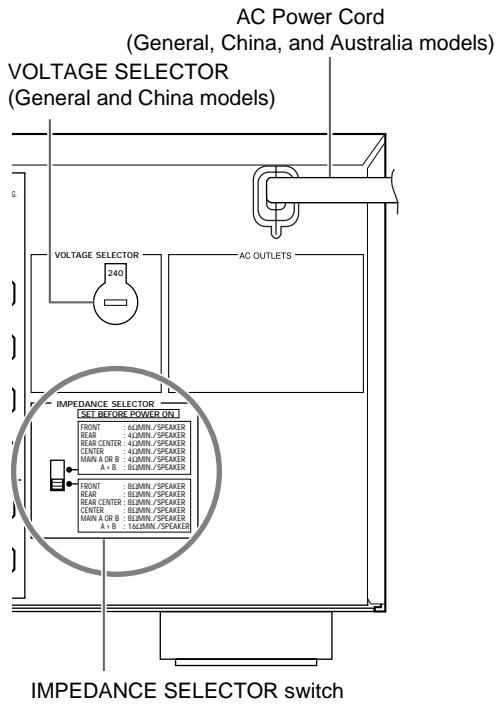

■ IMPEDANCE SELECTOR switch

Select the position whose requirements your speaker system meets.

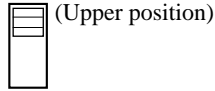

FRONT EFFECT:

The impedance of each speaker must be 6Ω or higher.

<U.S.A. and Canada models>

- REAR:** The impedance of each speaker must be 4Ω or higher.
- REAR CENTER:** The impedance of the speaker must be 4Ω or higher.

<Except for U.S.A. and Canada models>

- REAR:** The impedance of each speaker must be 6Ω or higher.
- REAR CENTER:** The impedance of the speaker must be 6Ω or higher.
- CENTER:** The impedance of the speaker must be 4Ω or higher.

- MAIN:** If you use one pair of main speakers, the impedance of each speaker must be 4Ω or higher.
If you use two pairs of main speakers, the impedance of each speaker must be 8Ω or higher.

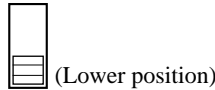

FRONT EFFECT:

The impedance of each speaker must be 8Ω or higher.

- REAR:** The impedance of each speaker must be 8Ω or higher.
- REAR CENTER:** The impedance of the speaker must be 8Ω or higher.

- CENTER:** The impedance of the speaker must be 8Ω or higher.

- MAIN:** **<Except for Canada model>**
If you use one pair of main speakers, the impedance of each speaker must be 8Ω or higher.
If you use two pairs of main speakers, the impedance of each speaker must be 16Ω or higher.

<For Canada model only>

The impedance of each speaker must be 8Ω or higher.

■ Connecting the AC power cord

Plug in this unit to a wall outlet when all connections are complete.

Caution:

- Do not use other AC power cords than the one provided. (U.S.A., Canada, and Singapore models only)

■ AC OUTLETS

Use these to connect the power cords from your other components to this unit. The power to the switched outlets is controlled by this unit's **STANDBY/ON** (**SYSTEM POWER** or **STANDBY** on the remote). These outlets will supply power to any connected unit whenever this unit is turned on. The maximum power (total power consumption of components) that can be connected to **AC OUTLETS** is 100 W.

■ Voltage selector (General and China models)

The voltage selector on the rear panel of this unit must be set for your local main voltage **BEFORE** plugging into the AC main supply.

On-Screen Displays (OSD)

You can display the operation information for this unit on a video monitor. If you display the SET MENU and DSP sound field program parameter settings on a screen, it is much easier to see the available options and parameters than it is by reading this information on the front panel display.

If a video source is being reproduced, the OSD is superimposed over the image.

If a video source is not being reproduced (or the source component is set in the standby mode), you can set the OSD to turn on (blue background) or off with "14 DISPLAY SET" on the SET MENU.

OSD Modes



Full Display (ex.)

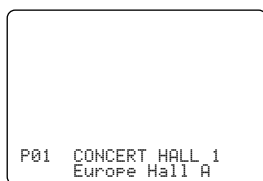

Short Display (ex.)

You can change the amount of information the OSD shows.

Full Display This mode always shows the sound field program parameter settings on the video monitor.

Short Display This mode briefly shows the same contents as the front panel display at the bottom of the screen, then disappears.

Display Off This mode briefly shows the "DISPLAY OFF" message at the bottom of the screen, then disappears. Afterwards, no changes to operations appear on the screen except those of the **ON SCREEN**.

Notes:

- When you choose the Full Display mode, the **INPUT** selector, **VOLUME**, and some other types of operation information are displayed at the bottom of the screen in the same format as the front panel display.
- The OSD signal is not output through the **REC OUT** selector, and will not be recorded with any video signal.
- The SET MENU, TEST DOLBY SUR and TEST DSP appear regardless of the OSD mode.

Selecting the OSD Mode

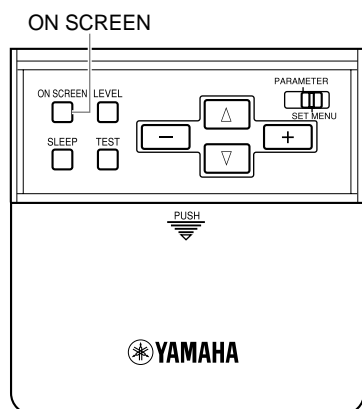

- 1 When you turn on the power, the video monitor and front panel display shows the level of the main volume for a few seconds and then switches to show the current sound field program.
- 2 Press **ON SCREEN** on the remote control repeatedly to change the display mode.

The OSD mode changes in the following order: Full Display, Short Display, and Display Off.

Notes:

- If you choose a video input source that has component connected to both the **S VIDEO IN** and composite **VIDEO IN** jacks, and both the **S VIDEO OUT** and composite **VIDEO OUT** jacks are connected to a video monitor, the video signal is output to both the **S VIDEO OUT** and **VIDEO OUT** jacks. However, the OSD is carried only on the S-video signal. If no video signal is input, the OSD is carried on both the S-video and composite video signals.
- If your video monitor is connected only to the **COMPONENT VIDEO** jacks of this unit, the OSD is not shown. Make sure to connect your video monitor to the **COMPONENT VIDEO** jack and either **VIDEO** or **S VIDEO** jacks if you would like to see the OSD.
- Playing back video software that has an anti-copy signal or video signals with a lot of noise may produce unstable images.

Speaker Placement

Where you place your speakers has a tremendous effect on how well your system sounds.

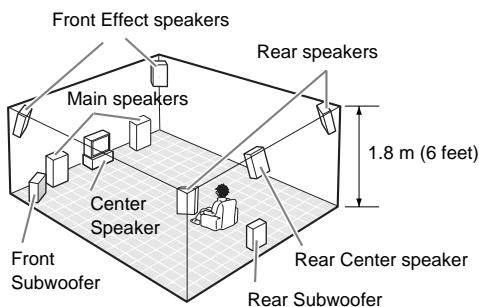
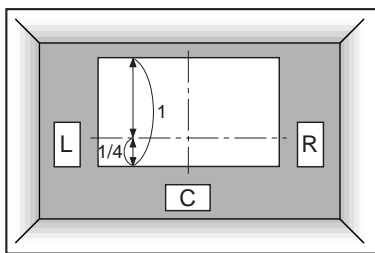
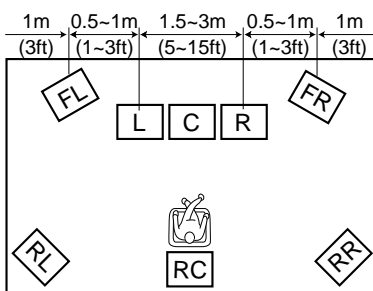
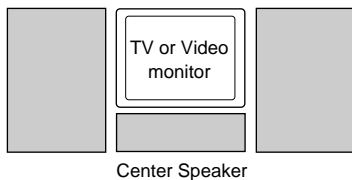

■ Placing the Main speakers

Place the left and right Main speakers an equal distance from the main listening position.

If you have a TV or video monitor in your system, the distance of each speaker from each side of the TV or video monitor should be the same.

■ Placing the Center speaker

If you have a TV or video monitor in your system, align the front face of the Center speaker with the front face of the monitor. Place the speaker as close to the monitor as possible, such as directly over or under the monitor. If you place the speaker under the monitor, the Front Effect speakers can adjust the height of the sound to correspond with the action on the screen (depending on the listener's position). If you have a projection screen in your system, place the Center speaker under the screen. Be sure to align the speaker with the center of the screen.

■ Placing the Front Effect, Rear, and Rear Center speakers

The Front Effect speakers should be placed about 0.5~1m (1~3 feet) outside the Main speakers and in the front of the room. They should be turned toward the main listening position. Place the Rear speakers in the back of the room so they face the main listening position. The Rear speakers can be placed farther apart than the Front Effect speakers. The Front Effect and Rear speakers should be placed about 1.8m (6 feet) above the floor.

Once you begin listening to programs, continue to adjust the speaker placement until you obtain a balanced sound from the Main speakers and the Front Effect and Rear speakers.

■ When you use a projection screen

Place the speakers as shown in the illustration.

The Main speakers should be placed about one-quarter of the way up from the bottom of the screen.

Place the Center speaker in the center and directly under the screen. The Center speaker provides precise dialogue localization.

When you use a projection screen with your system, the Front Effect speakers provide better effect quality. The CINEMA-DSP sound field programs raise the sound from the Center speaker upward and provide natural sound corresponding with the video images.

■ Placing the Subwoofers

Place the Front Subwoofer near the Main speakers. Turn it slightly toward the center of the room to reduce wall reflections.

If you use a Rear Subwoofer, place it behind the main listening position. The placement of the Rear Subwoofer is not critical because of the ultralow frequencies of the sound being reproduced.

By adding a high quality Subwoofer to the speaker system configurations shown on page 9, you can enjoy more powerful and realistic movie effects, even if your Main speakers are large.

Notes:

- If you use different brands of speakers (with different tonal qualities) in your configuration, the tone of a moving human voice and other types of sound may not shift smoothly. We recommend that you use speakers from the same manufacturer or speakers with the same tonal quality.
You can also adjust the output levels and equalization of your effect speakers using the SET MENU.
- If you are using small speakers, the addition of a Subwoofer will reinforce the sound effects of movies.

Speaker Settings

This unit has seven SPEAKER SET items in the SET MENU that you must set according to the number of speakers in your configuration and their size. The following table summarizes these SPEAKER SET items, and shows the initial settings as well as other possible settings. If the initial settings are not appropriate for your speaker configuration, change the settings in the SET MENU.

Summary of SPEAKER SET items 1A through 1G

| Item | Description | Initial Setting |
|------------------|---|-----------------|
| 1A. CENTER SP | Selects the Center channel output mode according to the size of the Center speaker. The possible settings are LRG (large), SML (small), and NONE. | LRG |
| 1B. MAIN SP | Selects the Main channel output mode according to the size of the Main speakers. The possible settings are LARGE and SMALL. | LARGE |
| 1C. REAR L/R SP | Selects the Rear channel output mode according to the size of the Rear speakers. The possible settings are LRG (large), SML (small), and NONE. | LRG |
| 1D. REAR CT SP | Selects the Rear Center channel output according to the size of the Rear Center speaker. The possible settings are LRG (large), SML (small), and NONE. | LRG |
| 1E. LFE/BASS OUT | Selects a speaker for the LFE/Bass signal output. The possible settings are SWFR (subwoofer), MAIN, and BOTH. | BOTH |
| 1F. FRNT EFCT SP | Selects the Front Effect signal output mode for the Front Effect signals. The possible settings are YES and NONE. | YES |
| 1G. MAIN LEVEL | Selects the output level for the Main channel signal. The possible settings are Normal and -10 dB. | Normal |

Note:

- When you adjust the balance of the output level from the Right and Left Main speakers, use "L/R BALANCE" on the SET MENU.

Speaker Output Levels

This section explains how to set the speaker levels using the test tone. There are two tests; Dolby Surround test and DSP test.

Before You Begin

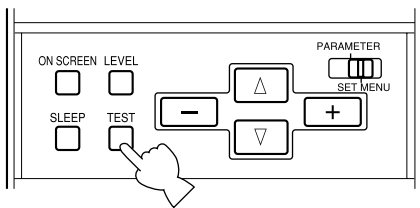

- 1 Set **BASS** and **TREBLE** on the front panel to “0” (the center position) and turn off **BASS EXTENSION**.
- 2 Use the remote control for the next three steps. Sit in the main listening position and set **PARAMETER/SET MENU** on the remote control to **PARAMETER**.
- 3 Set **10 KEY/DSP** to **DSP** and press **DOLBY/DTS SUR.**
- 4 Press **TEST** to select the test to be performed.

Select “TEST DOLBY SUR.” to match the output levels of the Center, Rear Center and Rear Left and Rear Right speakers to the left and right Main speakers.

Select “TEST DSP” to match the output levels of the Front Effect speakers to the Main speakers.

Dolby Surround Test

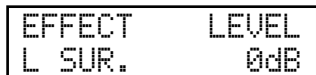
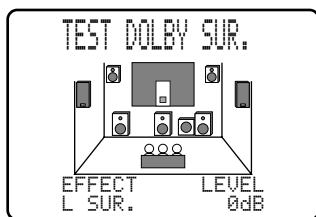
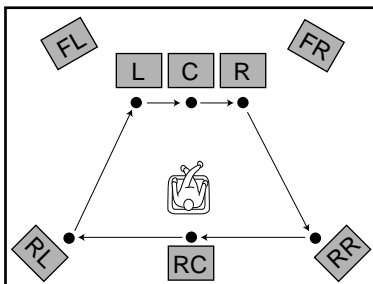

- 1 After the Dolby Surround test is selected, “TEST DOLBY SUR.” appears in the video monitor and in the front display.
- 2 Adjust **VOLUME +/-** to hear the test tone for each speaker. Make an adjustment so that the output level coming from each speaker is same.
 - The test tone is produced from the left Main speaker, Center speaker, right Main speaker, Rear Right speaker, Rear Center speaker, and Rear Left speaker in order. The tone lasts for 2.5 seconds each time.
 - Press and hold Δ or ∇ to stop the sequence temporarily.
 - Press Δ or ∇ to select the speaker to be tested.
- 3 When adjusting is complete, press **TEST** twice to stop the test tone.

You can increase the output levels of the effect channels (Rear Left, Rear Right, Rear Center, and Center) to +10dB. If the output level of the Center, Rear and Rear Center speakers is lower than that from the Main speakers even after you have increased the sound volume level of the Center, Rear, and Rear Center speakers up to +10dB, set the 1G. MAIN LEVEL item to this setting decreases the Main speaker volume level to about one-third the normal level. After you set the 1G. MAIN LEVEL item in the SET MENU to “-10dB,” adjust the levels for the Center, Rear, and Rear Center speakers again.

DSP Test

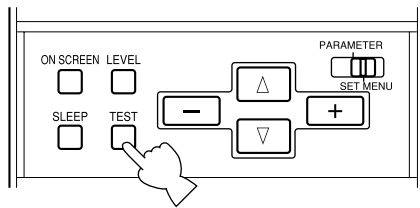

TEST DSP
MAIN

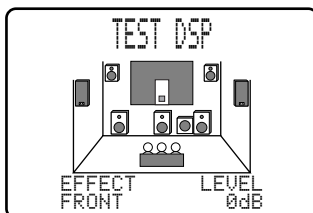
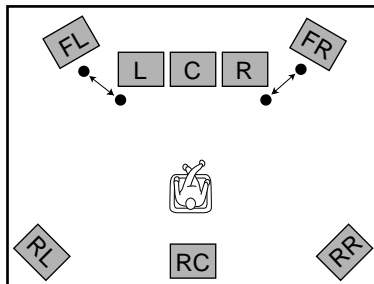

EFFECT FRONT LEVEL
FRONT 0dB

1 After the dsp test is selected, “TEST DSP” appears on the video monitor and in the front display.

2 Adjust **VOLUME +/-** to hear the test tone. Make an adjustment so that the output level coming from the Front Effect speakers is the same as that of the Main speakers.

- The test tone is produced alternately from the Front Effect speakers and Main speakers. The tone is produced for 2.5 seconds each time.

3 Adjust the output level of the Front Effect speakers using **+** and **-** so the output level coming from the Front Effect speakers is the same as that of the Main speakers.

- The test tone is automatically produced from the Front Effect speakers while you are adjusting the level.

Notes:

- If you cannot hear the test tone, set **VOLUME**, turn off the power, and check the speaker cords and hookups.
- The test tone can be reproduced separately from the left and right Front Effect speakers. This is useful when you want to check the hookups to these speakers. Press Δ to reproduce the test tone from the left speaker, and press ∇ to reproduce the tone from the right speaker. (The OSD shows which speaker is reproducing the tone.)
- You cannot adjust the output level of the left and right Front Effect speakers separately.
- You can hear the test tone only from the Right Front Effect speaker by pressing ∇ and the Left Front Effect speaker by pressing Δ . You can return to the original mode by releasing the buttons.
- The tonal quality of the speakers can be adjusted using the 5. CENTER GEQ items in the SET MENU.
- If the sound volume of the Front Effect speakers is lower than that of the Main speakers, even after you have increased the output level up to +10 dB, set the 1G. MAIN LEVEL item in the SET MENU to “-10dB.” Setting the 1G. MAIN LEVEL item to “-10dB” decreases the Main speaker output level to about one-third of the normal level. After you set the 1G. MAIN LEVEL item in the SET MENU to “-10dB,” repeat the TEST DOLBY SUR. procedure on the previous page.
- If you do not use Front Effect speakers, set the 1F FRNT EFCT SP item in the SET MENU to “NONE”, and the DSP Front Effect signals will be mixed with the Main channel signals.
- When the headphones are connected to this unit, you cannot select the Dolby Surround test and the dsp test.

Basic Operation

Basic Playback 25

| | |
|---------------------------------------|----|
| Power Control | 25 |
| Selecting a Source | 26 |
| Input Modes and Indications | 27 |
| Selecting a Sound Field Program | 28 |

AM/FM Tuner 29

| | |
|----------------------------------|----|
| Connecting the Antennas | 29 |
| Automatic Tuning | 30 |
| Tuning to Preset Stations | 30 |
| Presetting Stations | 31 |
| Exchanging Preset Stations | 32 |

Basic Recording 33

| | |
|--------------------|----|
| Preparations | 33 |
|--------------------|----|

Basic Playback

Playback operation is described with buttons on this unit and the remote control. These button names are noted in the order of “button name (remote control button name).”

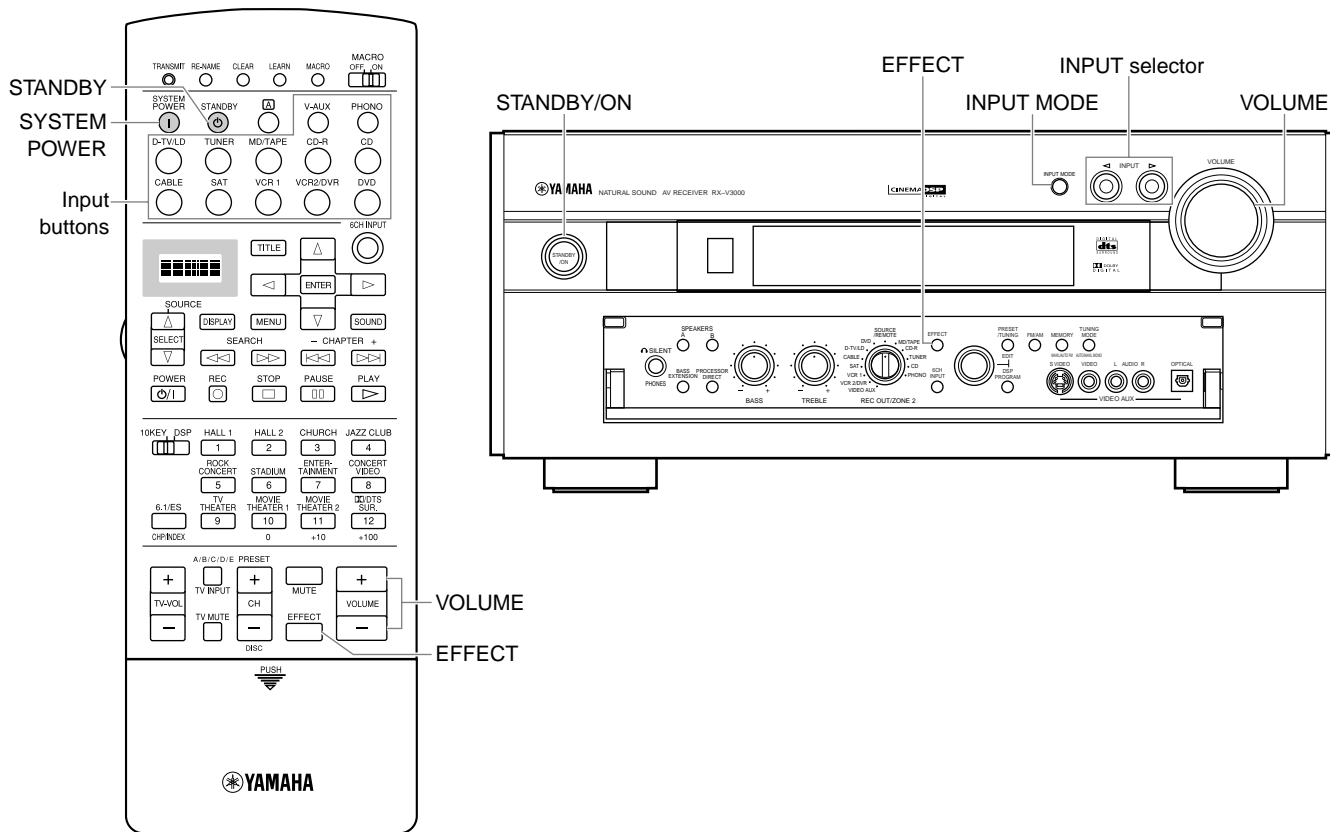

Power Control

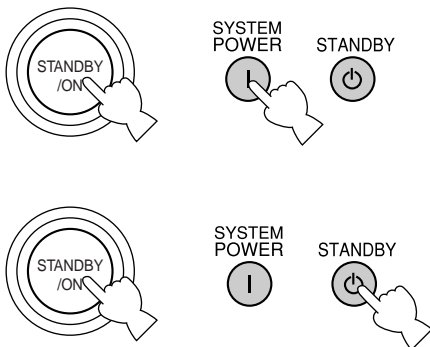

1 Press **STANDBY/ON** (or **SYSTEM POWER** on the remote control) to turn on the power.

- The front panel (and the monitor screen) shows the level of the volume for a few seconds and then switches to show the current sound field program.

2 Press **STANDBY/ON** (or **STANDBY** on the remote control) to turn off the power.

Note:

- This unit stores its current operational status in memory before the power is turned off. By connecting a commercially available timer to this unit, you can easily playback or record a source at any time you wish.

Selecting a Source

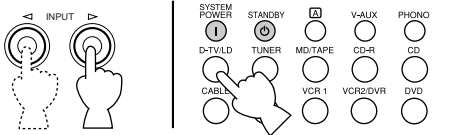

The selected source

| | |
|----------|---------|
| D-TV/LD | DVD |
| CABLE | MD/TAPE |
| SAT | CD-R |
| VCR 1 | TUNER |
| VCR2/DVR | CD |
| V-AUX | PHONO |

1 Select the source using the **INPUT** selector, or press one of the input buttons on the remote control.

- The current source is indicated on the front panel display with an arrow.
- The current source name and input mode appear on the front panel display and the video monitor for a few seconds.

Select this source:

To reproduce the signal from this component.

| | | |
|-----------|-------|--|
| DVD | | DVD player |
| D-TV/LD | | LD player/Digital TV or TV |
| CABLE | | Cable TV |
| VCR 1 | | Video deck 1 |
| VCR 2/DVR | | Video deck 2 or Digital Video Recorder |
| V-AUX | | Other AV component |
| PHONO | | Turntable |
| CD | | CD player |
| TUNER | | AM/FM tuner |
| MD/TAPE | | MD recorder/TAPE deck |
| CD-R | | CD Recorder |
| SAT | | Satellite tuner |

2 Start playback (or select a broadcast station) on the source component.

- Refer to the operation instructions for the component.

3 Adjust **VOLUME** (or **VOLUME +/-** on the remote control).

Caution:

- If the power of the component connected to the **VCR 1**, **VCR 2/DVR**, **MD/TAPE**, and **CD-R OUT** jacks is turned off, reproduced sound may be distorted or the volume may be lowered. In these cases, turn on the component.

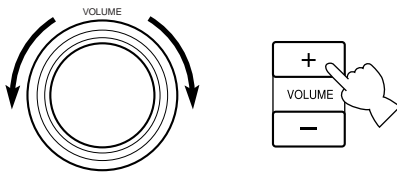

■ BGV (Back Ground Video) function

The BGV (Back Ground Video) function allows you to combine a video signal from a video source with a sound signal from an audio source. (For example, you can listen to classical music while you are watching a video.)

Using the remote control, select a source from the video group, then select a source from the audio group. Use the input buttons on the remote control to make your selections. The BGV function does not work if you select the sources using the **INPUT** selector on the front panel.

Input Modes and Indications

This unit comes with various input jacks. If your external component is connected to more than one type of input jack, you can set the priority of the input signal. Press **INPUT MODE** on the front panel or an input button (press it repeatedly) on the remote control to display or change the input mode.

• AUTO

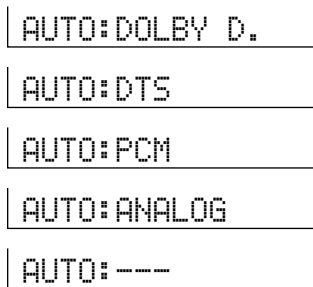

• DTS

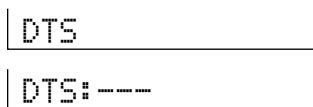

• ANALOG

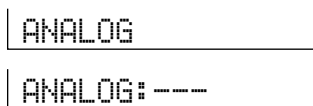

AUTO: This mode is automatically selected when you turn on the power of this unit. In this mode, the input signal is automatically selected in the following order.

- 1) Dolby Digital or DTS encoded signals
- 2) Digital (PCM) signals
- 3) Analog signals

DTS: In this mode, only digital input signals encoded with DTS are selected even if other signals are input at the same time.

ANALOG: In this mode, only analog input signals are selected even if digital signals are input at the same time.

<When LD is selected as the input source> (General, China, and Singapore models only)

AUTO: In this mode, this unit automatically selects the signal in the following order.

- 1) Dolby Digital RF encoded signals
- 2) DTS encoded signals
- 3) Digital (PCM) signals
- 4) Analog signals

D.D. RF: This unit only selects Dolby Digital RF signals.

DTS: In this mode, only digital input signals encoded with DTS are selected even if other signals are input at the same time.

DGTL: This unit only selects digital signals input through the **OPTICAL** jacks.

ANALOG: This unit only selects signals input through the **ANALOG** jacks. This unit will not select Dolby Digital RF or DTS signals.

Notes:

- If digital signals are input from both the **COAXIAL** and **OPTICAL** jacks, the digital signal from the **COAXIAL** jack is selected.
- When AUTO is selected, this unit automatically determines the type of signal. If this unit detects a Dolby Digital or DTS signal, the decoder automatically switches to the appropriate setting and reproduces 5.1 channel source.
- The sound output may be interrupted for some LD and DVD players in the following situation: The input mode is set to AUTO. A search is performed while playing the disc encoded with Dolby Digital or DTS, and then disc playing is restored. The sound output is interrupted for a moment because the digital signal was selected again.

■ Notes on playing a source encoded with a DTS signal

- If the digital output data of the player has been processed in any way, you may not be able to perform DTS decoding even if you make a digital connection between this unit and the player.
- If you play a source encoded with a DTS signal and set the input mode to ANALOG, this unit reproduces the noise of an unprocessed DTS signal. When you want to play a DTS source, be sure to connect the source to a digital input jack and set the input mode to AUTO or DTS.
- If you switch the input mode to ANALOG while playing a source encoded with a DTS signal, this unit reproduces no sound.
- If you play a source encoded with a DTS signal and set the input mode to AUTO, there will be a moment of noise while the unit recognizes the DTS signal and turns on the DTS decoder. This is not a malfunction. You can avoid this by setting the input mode to DTS beforehand.
- If you continue to play a source encoded with a DTS signal with the input mode setting left to AUTO, this unit automatically switches to the "DTS-decoding" mode to prevent noise from being generated during subsequent operation. (The "dts" indicator lights up on the front panel display.) The "dts" indicator will flash immediately after playback of a source encoded with a DTS signal has finished. Only a source encoded with a DTS signal can be played back while this indicator is flashing. If you want to play a normal PCM source soon, set the input mode back to AUTO.
- The "dts" indicator will flash when the input mode is set to AUTO and a search or skip operation is performed while playing back a source encoded with a DTS signal. If this status continues for 30 or more seconds, the unit will automatically switch from the "DTS-decoding" mode to PCM digital signal input mode and the "dts" indicator will go out.

■ Notes on playing an LD or DTS CD source

- For LD software that does not contain a digital soundtrack, connect the LD player to the analog jacks and set the input mode to AUTO or ANALOG.
- If the LD player is transmitting a signal by a non-standard method, this unit cannot detect the Dolby Digital or DTS signal. In this case, the decoder automatically switches to PCM or analog.
- Some A/V components such as LD players output different audio signals through their analog and digital jacks. Change the input mode as necessary.
- While you are operating the LD player and playing a disc encoded with a Dolby Digital signal, if you switch from the pause or chapter forwarding function to normal playback, you may hear the PCM or analog sound an instant before the Dolby Digital signal is played.

Selecting a Sound Field Program

You can enhance your listening experience by selecting a DSP sound field program. The 25 DSP sound field programs are divided into 12 DSP program groups.

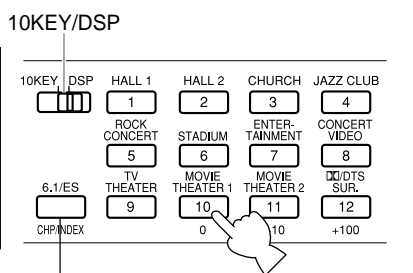

6.1/ES

If you want to utilize the Rear Center speaker with a 5.1 channel program source, press **6.1/ES**.

- 1 Set **10KEY/DSP** on the remote to **DSP**.
- 2 Press the **DSP** button on main unit and rotate the Multi jog knob to select the desired sound field program.

Notes:

- If a DTS or Dolby Digital signal is input when the input mode is set to "AUTO", the sound field program automatically switches to the appropriate decoding program.
- Choose a sound field program based on your listening preference, not on the name of the program. The acoustics of your listening room affect the sound field program. Minimize the sound reflections in your room to maximize the effect created by the program.
- When you select an input source, the main unit automatically selects the last sound field program used with that source.
- When you turn off the main unit, the current source and sound field program are memorized and are automatically selected when you turn on the power again.
- When high rate 96 kHz sampling digital signals are output from source equipment, the DSP sound field cannot operate on the source sounds. In this case, the sounds are reproduced as normal 2-channel stereo.

Hi-Fi DSP Programs

| Concert Hall 1 | Concert Hall 2 | Church | Jazz Club | Rock Concert | Stadium | Entertainment |
|--------------------------------|-------------------------------|-----------------------|---------------------------------|-----------------------|-----------------|---------------------|
| Europe Hall A Europe Hall B | U.S.A. Hall C Live Concert | Freiburg Royaumont | Village Gate The Bottom Line | Roxy Theatre Arena | Anaheim Bowl | Disco 8ch Stereo |

CINEMA-DSP Programs

| Entertainment | Concert Video | TV Theater | Movie Theater 1 | Movie Theater 2 | DOLBY/DTS SURROUND |
|---------------|-----------------------------|------------------------------|---------------------|----------------------|---|
| Game | Pop/Rock Classical/Opera | Mono Movie Variety/Sports | Spectacle Sci-Fi | Adventure General | Normal/Matrix 6.1/ES Enhanced/6.1/ES |

Virtual CINEMA DSP and HP CINEMA DSP

You can experience the virtual CINEMA DSP sound field by setting the 1C. REAR L/R SP item in the SET MENU to "NONE." The sound field processing is changed to the Virtual CINEMA DSP mode according to the selected sound field program. The Virtual CINEMA DSP allows you to enjoy the virtual sound fields without Rear speakers. Signals for Rear channels are output from the Main speakers. You can also listen to HP (Headphone) CINEMA DSP by connecting your headphones to the **PHONES** jack while the DSP sound fields are on. When high rate 96 kHz sampling digital signals are output from source component, the Virtual CINEMA DSP and HP CINEMA DSP cannot operate on the source sounds.

Note:

- This unit is not set in the virtual CINEMA DSP mode even if "1C REAR L/R SP" is set to NONE in the following cases:
 - when the 8ch Stereo, DOLBY DIGITAL/Normal or DTS/Normal program is selected;
 - when the sound effect is turned off;
 - when 6CH INPUT is selected as the input source;
 - when 96-kHz sampling digital signals are input to this unit;
 - when the Dolby Digital KARAOKE source is played;
 - when using the test tone; or
 - when connecting the headphones.

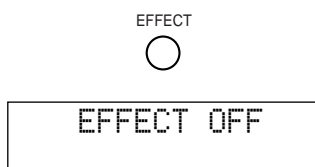

Normal stereo reproduction

For normal stereo reproduction, press **EFFECT** to turn off the effect.

Notes:

- When you turn off the effect, no sound is reproduced from the Front Effect, Center, Rear, and Rear Center speakers.
- If you turn off the effect while DTS or Dolby Digital signals are being reproduced, the dynamic range of the signal is automatically compressed.
- The sound volume may be extremely reduced when you turn off the effect or if you change a SET MENU item. In this case turn on the effect.

Connecting the Antennas

Both AM and FM indoor antennas are included with this unit. These antennas should provide sufficient signal strength in most situations. However, a properly installed outdoor antenna provides clearer reception. If you experience poor reception quality using the indoor antennas, an outdoor antenna may improve the reception. Connect each antenna as shown below.

Indoor FM antenna (included)

AM loop antenna (included)

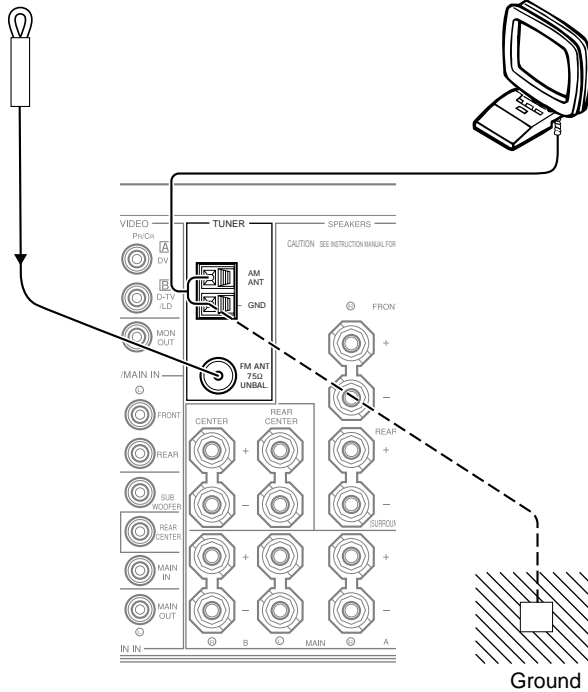

■ Connecting the indoor FM antenna

Connect the included indoor antenna to the **75Ω UNBAL. FM ANT** terminal.

■ Optional outdoor FM/AM antenna

Consult your dealer or authorized service center about the best method of selecting and erecting outdoor antennas.

■ Connecting the AM loop antenna

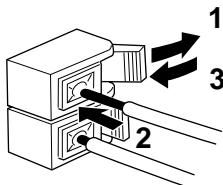

- 1 Press the tab to unlock the terminal hole.
- 2 Insert the AM loop antenna lead wires to the **AM ANT** and **GND** terminals.
- 3 Lift the tab to its original position to lock the lead wires.
Lightly pull on the lead wires to confirm a good connection.
- 4 Attach the loop antenna to the antenna stand.
- 5 Orient the AM loop antenna so that the best reception is obtained.

Notes:

- The AM loop antenna should be placed away from this unit. The antenna may be hung on a wall.
- The AM loop antenna should remain connected, even if an outdoor AM antenna is connected to this unit.
- To minimize the influence of automobile ignition noise, locate the antenna as far from heavy traffic as possible.
- Keep the ribbon cable or coaxial cable as short as possible.
Do not bundle or roll up excess cable.
- The antenna should be at least 1.8m (6 feet) from reinforced concrete walls and metallic structures.

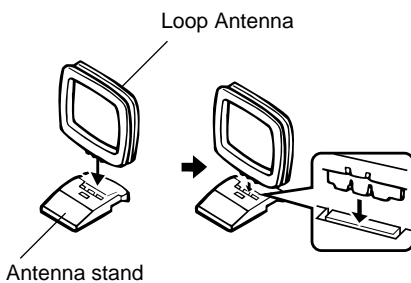

Automatic Tuning

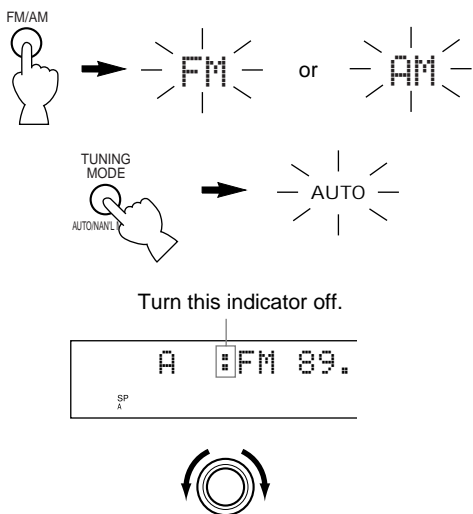

- 1 Select “TUNER” as the input source.
You can use the **INPUT** selector on the main unit or the input button on the remote control.
- 2 Press **AM/FM** to select the reception band.
“FM” or “AM” appears in the display.
- 3 Press **TUNING MODE** so that the AUTO tuning indicator appears in the display.
If the colon (:) appears in the display next to the AM or FM indicator, press **PRESET/TUNING** to turn it off.
- 4 Turn the Multi jog knob clockwise or counterclockwise to start automatic tuning.
Turn the Multi jog knob clockwise to tune to a higher frequency or counterclockwise to tune to a lower frequency.
Use manual tuning if the tuning search does not stop at the correct station because the signals are weak.

■ For manual tuning

- 1 Press **TUNING MODE** so that the AUTO tuning indicator goes off in the display.
If the colon (:) appears in the display next to the AM or FM indicator, press **PRESET/TUNING** to turn it off.
- 2 Turn the Multi jog knob clockwise or counterclockwise to tune to the desired station manually.
Hold on the knob to continue the tuning search.

Automatic tuning is effective when the radio signals are strong and have no interference. However, manual tuning is best for weaker signals that have some interference.

Note:

- Manually selecting an FM station will automatically change the reception to monaural to increase the signal quality.

Tuning to Preset Stations

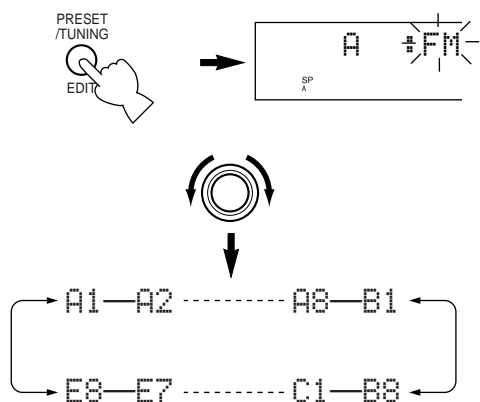

- 1 Press **PRESET/TUNING** so that the colon (:) appears next to the AM or FM indicator.
The colon (:) must appear in the display to recall preset stations. If necessary, press **PRESET/TUNING** again.
- 2 Turn the Multi jog knob clockwise or counterclockwise to select the desired preset station number.
The preset number appears in the display along with the band, frequency and signal strength information.

Presetting Stations

■ Automatically presetting stations

You can use the Automatic Preset Tuning feature to store FM stations. With this function, the unit automatically tunes to FM stations with strong signals, then stores up to 40 of those stations in order.

- 1 Tune to the FM station from which you want automatic presetting to begin.
- 2 Press and hold **MEMORY** for more than 3 seconds.

The preset number and the MEMORY and AUTO tuning indicators flash. Then, after about five seconds, automatic preset tuning begins. When Automatic Preset Tuning is complete, the display shows the frequency of the last preset station.

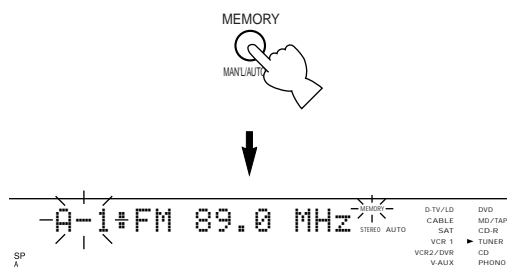

Automatic Preset Tuning Options

Before Automatic Preset Tuning begins (within about five seconds), you can set the preset number from which the unit will store FM stations and the direction in which the unit will scan for stations.

- 1 Press **PRESET/TUNING** to display the colon (:). Then turn the Multi jog knob to select the preset station number where the first station will be stored. The unit will stop storing stations if it reaches preset number E8.
- 2 Press **PRESET/TUNING** to turn off the colon (:). Then turn the Multi jog knob counterclockwise to scan for lower frequency stations or clockwise to scan for higher frequency stations. If you do not turn either direction before Automatic Preset Tuning begins, the unit will scan for higher frequency stations.

Notes:

- You can replace a preset station with another FM or AM station manually by simply following the procedure of the section “Manually presetting stations”.
- If the number of received stations does not reach to E8, the search finishes automatically after searching all frequencies.
- With this function, only FM stations with sufficient signal strength are stored automatically. If the station you want to program is weak in signal strength, tune to it in monaural mode manually, then program it by following the procedure in “Manually presetting stations”.

■ Manually presetting stations

This unit can store up to 40 stations (8 stations x 5 groups). Using this feature, you can easily tune to any preset station by selecting the preset station number.

- 1 Tune to a station.
- 2 Press **MEMORY (MAN'L/AUTO FM)**.

The MEMORY indicator flashes for about five seconds.

- 3 Turn the Multi jog knob clockwise or counterclockwise to select a preset station number.

Note:

- You must select a preset station number before the MEMORY indicator goes off (about five seconds).

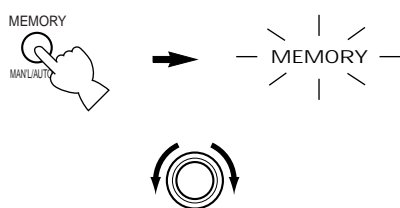



Shows the displayed station has been programmed to A-1.



4 Press **MEMORY (MAN'L/AUTO FM)**.

The station band and frequency appear in the display with the preset group and number you selected.

5 Repeat steps 1 through 4 to store other stations.

You can store up to 40 stations (A1~A8, B1~B8, C1~C8, D1~D8, and E1~E8).

Exchanging Preset Stations

You can exchange the stations stored on two preset numbers. The example below describes the procedure for exchanging the stored stations at preset numbers E1 and A5.

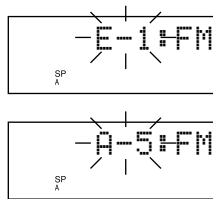

Shows the exchange of stations is completed.

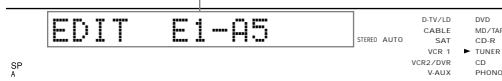

1 Tune to the E1 preset station number.

See "Tuning to Preset Stations."

2 Press and hold **PRESET/TUNING (EDIT)** for more than 3 seconds.

"E-1" flashes in the display.

3 Tune to the A5 preset station number.

See "Tuning to Preset Stations."

A-5 flashes in the display.

4 Press **PRESET/TUNING (EDIT)** again.

The stations stored at the two preset locations are exchanged.

Notes:

- The memory back-up circuit prevents the stored data from being lost even if this unit is set to standby mode, the power cord is disconnected from the AC outlet, or power service is temporarily cut due to power failure. However, if the power is cut for more than one week, the memory may be deleted.
- Any stored station data existing at a preset number is cleared when you store a new station at that preset number.
- The reception mode (stereo or monaural) is stored along with the station frequency.

REC OUT allows you to record one source while viewing and/or listening to another source.

Preparations

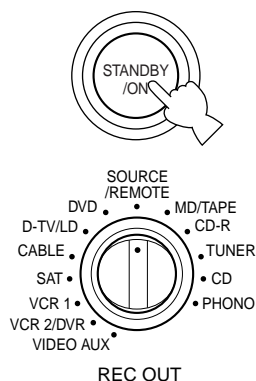

- 1 Turn on the power to this unit and all connected component.
- 2 Select the source component you want to record using **REC OUT**.
 - To record the current source, set **REC OUT** to **SOURCE/REMOTE**.
 - To record a source that you do not want to reproduce, set **REC OUT** to the source you want to record.
- 3 Start playback (or select a broadcast station) on the source component.
- 4 Start recording on the recording component.
 - If you want to listen to another source, and **REC OUT** is not set to **SOURCE/REMOTE**, select the source you want to reproduce with the **INPUT** selector and adjust the volume.

Notes:

- Do a test recording before you start an actual recording.
- When this unit's power is off, you cannot record between other component connected to this unit.
- Operating **BASS** and **TREBLE**, **BASS EXTENSION**, **BALANCE**, **VOLUME**, and DSP programs do not affect the recorded signal.

■ Special considerations when recording DTS software

The DTS signal is a digital bitstream. Attempting to digitally record the DTS bitstream will result in noise being recorded. Therefore, if you want to use this unit to record sources that have DTS signals recorded on them, the following considerations need to be made.

For DTS encoded LDs, DVDs, and CDs:

Only 2-channel analog audio signals may be recorded as follows:

- **LDs:**
Set your Laser Disc player's left and right outputs to the analog soundtrack.
- **DVDs:**
Use the disc menu to set the DVD player's mixed 2-channel left and right audio outputs to the PCM or Dolby Digital soundtrack.
- **CDs:**
The DTS signal recorded on CDs can only be output as a digital bitstream, and therefore cannot be recorded.

Advanced Operation

SET MENU Items 35

| | |
|--|----|
| Operating the SET MENU | 36 |
| 1. SPEAKER SET (1A. CENTER SP to 1G. MAIN LEVEL) | 37 |
| 2. LOW FREQ. TEST | 39 |
| 3. L/R BALANCE | 40 |
| 4. HP TONE CTRL (Headphone Tone Control) | 40 |
| 5. CENTER GEQ (Center Graphic Equalizer) | 40 |
| 6. INPUT RENAME | 40 |
| 7. I/O ASSIGN | 41 |
| 8. INPUT MODE | 41 |
| 9. PARAMETER INI (Parameter Initialization) | 41 |
| 10. DOLBY D. SET (Dolby Digital Set) | 42 |
| 11. DTS SET | 42 |
| 12. 6.1/ES AUTO | 42 |
| 13. SP DELAY TIME | 43 |
| 14. DISPLAY SET | 43 |
| 15. MEMORY GUARD | 43 |
| 16. ZONE 2 SET | 43 |

Remote Control Features 44

| | |
|---|----|
| Using the Remote Control | 44 |
| Each Component Control Area | 46 |
| Setting the Manufacturer Code in the Remote Control | 49 |
| Programming a New Remote Control Function | 50 |
| Using the Macro Feature | 51 |
| Changing the Source Name in the Display Window | 53 |
| Clearing a Learned Function or Macro | 53 |
| Clearing Learned Functions and Setups | 54 |

ZONE 2 55

| | |
|--------------------------------|----|
| Connections | 55 |
| Remote Control in Zone 2 | 56 |

Adjusting the Levels of the Effect Speakers 57

Setting the Sleep Timer 57

SET MENU Items

The SET MENU consists of sixteen items including the Speaker Set, Center Graphic Equalizer and Parameter Initialization features. Choose the appropriate item and adjust or select the values as necessary.

Notes:

- You can adjust the items in the SET MENU while reproducing a source.
- We recommend that you adjust the items in the SET MENU while using a video monitor. It is easier to see the video monitor screen than it is to see the front panel display on this unit while adjusting SET MENU items.

| Items | Descriptions | Setting | Page |
|--|--|---|-------|
| 1. SPEAKER SET 1A. CENTER SP 1B. MAIN SP 1C. REAR L/R SP 1D. REAR CT SP 1E. LFE/BASS OUT 1F. FRNT EFCT SP 1G. MAIN LEVEL | Selects the output mode suitable for your Center speaker. Selects the output mode suitable for your Main speakers. Selects the output mode suitable for your Rear speakers. Selects the output mode suitable for your Rear Center speaker. Selects the output mode for LFE/BASS signal output. Selects the output mode suitable for your Front Effect speakers. Selects the output level for your Main channels. | LRG / SML / NONE LARGE / SMALL LRG / SML / NONE LRG / SML / NONE SWFR / MAIN / BOTH YES / NONE Normal / -10dB | 37-39 |
| 2. LOW FREQ. TEST | Matches the Subwoofer level with the level of the other speakers. | TEST TONE; OFF / ON OUTPUT; MAIN L/R, MAIN L, CENTER, MAIN R, R SUR, REAR CT, L SUR, SWFR, FRONT FREQ.; 35Hz—250Hz (Wide or narrow band) | 39 |
| 3. L/R BALANCE | Adjusts the sound balance for Left and Right channels. | L to 0 to R | 40 |
| 4. HP TONE CTRL | Adjusts the tonal balance of the headphones. | BASS; -6dB to +3dB TRBL; -6dB to +3dB | 40 |
| 5. CENTER GEQ | Matches the Center speaker tonal quality with the Main speakers. | 5-band; -6dB to +6dB | 40 |
| 6. INPUT RENAME | Changes the name of the inputs. | Up to eight characters. | 40 |
| 7. I/O ASSIGN | Assigns the I/O terminals to the designated input sources. | Digital I/O, CMPNT input. | 41 |
| 8. INPUT MODE | Selects the initial input mode of the sources. | AUTO / LAST | 41 |
| 9. PARAMETER INI | Initializes the parameters of a group of DSP programs. | 1 to 12 | 41 |
| 10. DOLBY D. SET 10A. LFE LEVEL 10B. D-RANGE | Adjusts the output level of the LFE channel for Dolby Digital signals. Adjusts the dynamic range for Dolby Digital signals. | SP, HP; -20dB to 0dB SP, HP; MAX / STD / MIN | 42 |
| 11. DTS SET | Adjusts the output level of the LFE channel for DTS signals. | SP, HP; -10dB to +10dB | 42 |
| 12. 6.1/ES AUTO | Selects the AUTO mode of Dolby Digital Matrix 6.1 and DTS ES decoding. | ON / OFF | 42 |
| 13. SP DELAY TIME | Adjusts the delay time for Center and Rear Center speakers. | CENTER; 0ms to 5ms REAR CNTR; 0ms to 30ms | 43 |
| 14. DISPLAY SET | Selects the display settings. | BLUE BACK; AUTO/OFF OSD SHIFT; 0 to 10 DIMMER; -4 to 0 | 43 |
| 15. MEMORY GUARD | Locks DSP program parameters and other SET MENU settings. | OFF / ON | 43 |
| 16. ZONE 2 SET | Selects the mode of Zone 2. | ZONE2 OUT; FIXED / VAR. (variable) | 43 |

Operating the SET MENU

Adjustment should be performed with the remote control. Some items require extra steps to change to the desired setting.

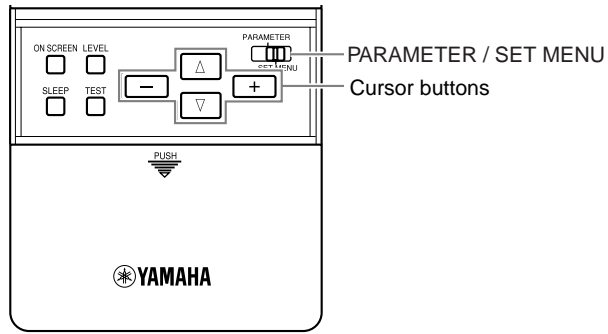

- 1 Set **PARAMETER/SET MENU** to **SET MENU**.



- 2 Press Δ or ∇ repeatedly to select an item from the table of SET MENU, then press **+** or **-** to enter the setting of that item.

- The last item you adjusted appears on the display.
- Some items have sub items.

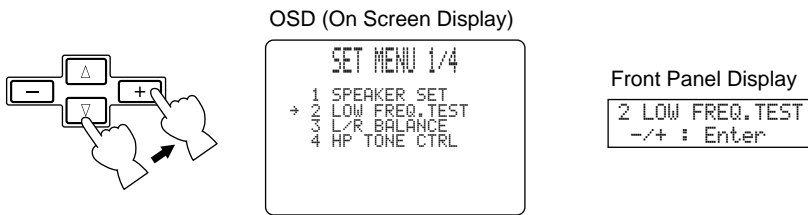

- 3 Press **+** or **-** to change the setting of the item.

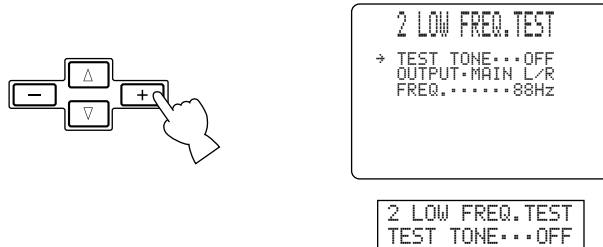

- 4 Press Δ or ∇ repeatedly or a DSP program button to exit the SET MENU.

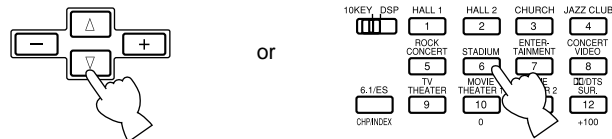

1. SPEAKER SET (1A. CENTER SP to 1G. MAIN LEVEL)

Use this feature to select suitable output modes for your speaker configuration. You must set the output mode when you use a subwoofer.

■ 1A. CENTER SP (Center Speaker Mode)

By adding a Center speaker to your speaker configuration, this unit can provide good dialogue localization for many listeners and superior synchronization of sound and images. The OSD shows a large, small, or no center speaker depending on how you set this item. The initial setting is "LRG".

- Select the "LRG" (Large) setting if you have a large Center speaker. The entire range of Center channel signals is sent to the Center speaker.
- Select the "SML" (Small) setting if you have a small Center speaker. Center channel low frequency signals of 90 Hz and below are directed to the speakers selected with the 1E. LFE/BASS OUT item.
- Select the "NONE" setting if you do not have a Center speaker. All of the Center channel signals are directed to the left and right Main speakers. The "NONE" position provides good dialogue localization for the person sitting in the main listening position.

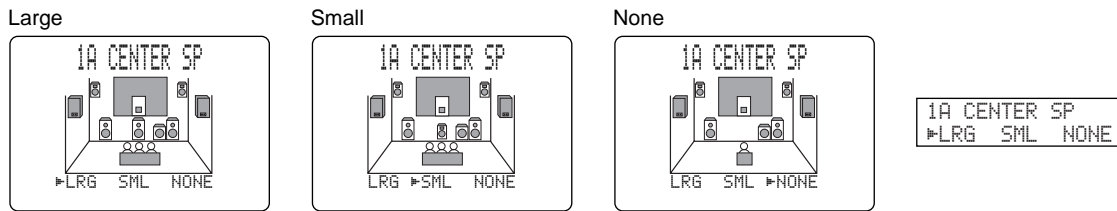

■ 1B. MAIN SP (Main Speaker Mode)

The display shows small or large Main speakers depending on how you set this item. The initial setting is "LARGE".

- Select the "LARGE" setting if you have large Main speakers. The entire range of left and right Main channel signals is directed to the left and right Main speakers.
- Select the "SMALL" setting if you have small Main speakers. The Main channel low frequency signals of 90 Hz and below are directed to the speakers selected with the 1E. LFE/BASS OUT item.

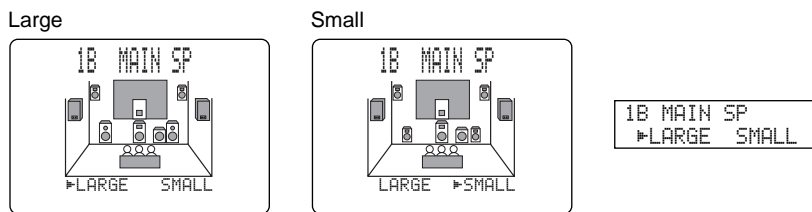

Note:

- When you select the "MAIN" setting for the 1E. LFE/BASS OUT item, the Main channel low frequency signals of 90 Hz and below are directed to the Main speakers even if you select the "SMALL" setting for the Main speaker mode.

■ 1C. REAR L/R SP (Rear Speaker Mode)

The OSD shows large, small, or no Rear speakers depending on how you set this item. The initial setting is "LRG".

- Select the "LRG" setting if you have large left and right Rear speakers or if you use a Rear Subwoofer. The entire range of Rear channel signals is sent to the left and right Rear speakers.
- Select the "SML" setting if you have small left and right Rear speakers. Rear channel low frequency signals of 90 Hz and below are directed to the speakers selected with the 1E. LFE/BASS OUT item.
- Select the "NONE" setting if you do not have Rear speakers.
 - In this case, the Rear Center speaker will automatically be set to "NONE" and the 1D. REAR CT SP item will be skipped.

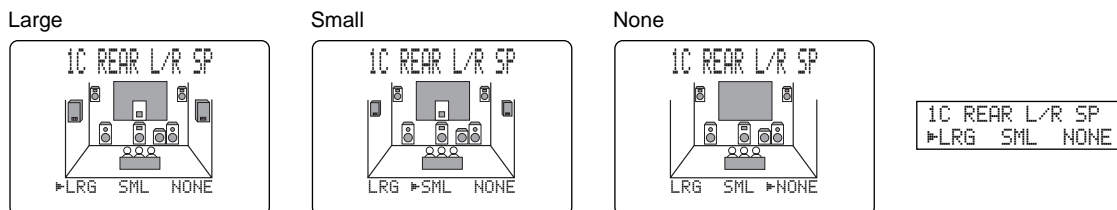

1D. REAR CT SP (Rear Center Speaker Mode)

By adding a Rear Center speaker to your speaker configuration, this unit can provide more realistic front-to-back and back-to-front transitions. The initial setting is “LRG”.

- Select the “LRG” setting if you have a large Rear Center speaker. The entire range of Rear Center channel signals is sent to the Rear Center speakers.
- Select the “SML” (small) setting if you have a small Rear Center speaker. Rear Center channel low frequency signals of 90 Hz and below are distributed to speakers selected with the 1E. LFE/BASS OUT item.
- Select the “NONE” setting if you do not have a Rear Center speaker. The Rear Center signal is directed to the Rear L/R speakers.

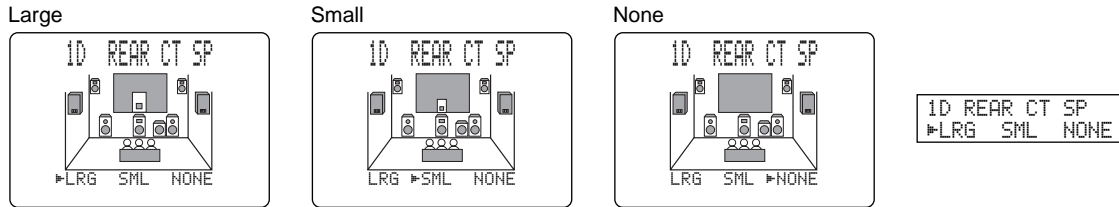

1E. LFE/BASS OUT (Bass Output Mode)

LFE signals carry low frequency effects when this unit decodes DTS or Dolby Digital signals. Low frequency signals are defined as 90 Hz and below. The initial setting is “BOTH”.

- Select the “SWFR” (Subwoofer) setting if you use a Subwoofer. The LFE signals are directed to the Subwoofer.
- Select the “MAIN” setting if you do not use a Subwoofer. The LFE signals are directed to the Main speakers.
- Select the “BOTH” setting if you use a Subwoofer and you want to mix the Main channel low frequency sound signals with the LFE signals.

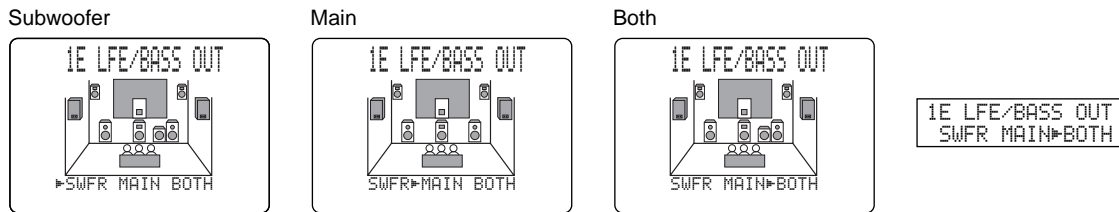

Note:

- The low frequency signals of 90Hz and below from all Main, Center, Rear, and Rear Center channels are directed to the LFE channel when you select the small speaker setting in items 1A, 1B, 1C, and 1D.

1F. FRNT EFCT SP (Front Effect Speaker Mode)

This unit uses Front Effect speakers to localize the virtual sound sources of the sound field programs. If you do not use Front Effect speakers, you can direct the Front Effect signals to the Main speakers.

The OSD shows small or no Front Effect speakers depending on how you set this item. The initial setting is “YES”.

- Select the “YES” setting if you use Front Effect speakers.
- Select the “NONE” setting if you do not use Front Effect speakers. The Front Effect signals are mixed with the Main channels.

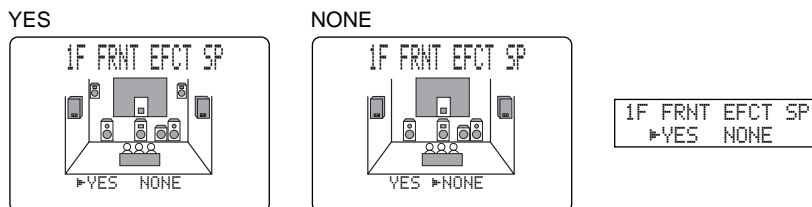

1G. MAIN LEVEL

Change this setting if you cannot match the sound volume of the Front, Rear, and Center speakers with the Main speakers because of the unusually high efficiency performance of the Main speakers. The initial setting is “Normal”.

- Select the “Normal” setting if you can match the volume of your effect speakers with the volume of your Main speakers using the Dolby Surround Test.
- Select the “-10dB” setting if you cannot match the volume of your effect speakers with the volume of your Main speakers using the Dolby Surround Test.

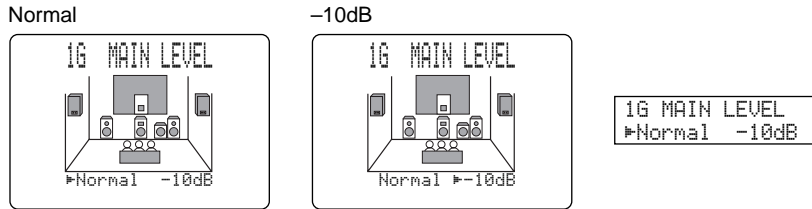

Notes:

- When 96-kHz sampling digital signals are input to this unit, level adjustments in items 1B and 1E are possible, but those in items 1A, 1C, 1D and 1F are not affected.
- When 6CH INPUT is selected as the input source, level adjustments in items 1A through 1F are not affected.

2. LOW FREQ. TEST

Use this feature to adjust the Subwoofer volume so it matches the volume of the other speakers in your configuration. Change the setting using the remote control while sitting in the main listening position.

- Press **+** or **-** to set the TEST TONE to “ON”, and adjust the volume using **VOLUME +** so you can hear the tone.
- Press **∇** repeatedly to go to OUTPUT and press **+** or **-** to select the speaker you want to compare with the Subwoofer.
 - If “SUBWOOFER” is selected, test tones above 90 Hz will not be output from the Subwoofer. The test tone will not necessarily be output from the selected speakers. The output mode of the test tone depends on the settings of the 1. SPEAKER SET items in the SET MENU.
- Press **∇** repeatedly to go to FREQ. and press **+** or **-** to select the frequency you want to use.

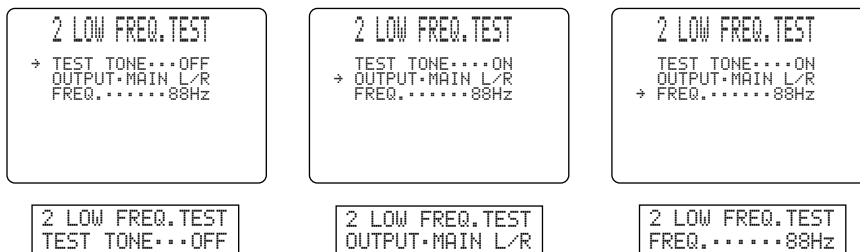

- Adjust the Subwoofer volume using the controls on the Subwoofer so it matches the volume of the speaker you are comparing it to.

Notes:

- Do not turn up the **VOLUME** too high.
- If no test tone is heard, turn off the power and make sure all the necessary hookups are correct.
- When the headphones are connected to this unit, you cannot set the TEST TONE to “ON”.

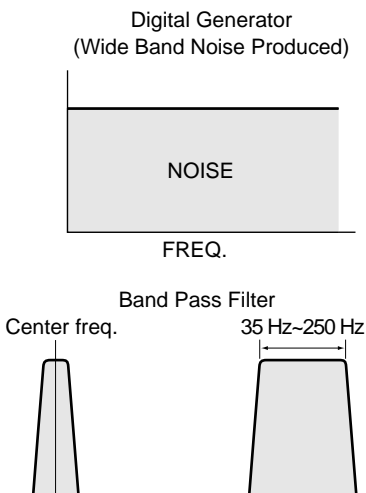

About the test tone

The test tone is produced by the tone generator. The tone generator produces a narrow band of noise centered at a specified frequency by the band pass filter. You can change the center frequency from 35 Hz through 250 Hz in one-sixth octave steps. You can use the test tone not only for adjusting the subwoofer level, but also for checking the low frequency characteristics of your listening room. Low frequency sounds are especially affected by the listener’s position, speaker placement, subwoofer polarity, and other conditions.

3. L/R BALANCE

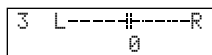

Use this feature to adjust the balance of the output level from the right and left main speakers. Initial setting is the neutral position.

4. HP TONE CTRL (Headphone Tone Control)

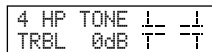
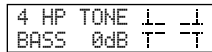

Use this feature to adjust the level of bass and treble when you use your headphones. The initial Setting is 0 dB for both bass and treble.

- Select BASS or TRBL and press + or – to change each level. You can adjust the level from –6 dB to +3 dB.

5. CENTER GEQ (Center Graphic Equalizer)

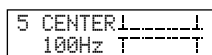
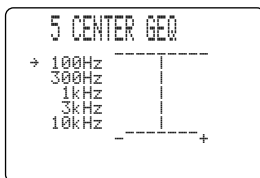

Use this feature to adjust the built-in five band graphic equalizer so the Center speaker tone matches that of the left and right Main speakers. You can select the 100 Hz, 300 Hz, 1 kHz, 3 kHz, or 10 kHz frequencies.

- 1 Use ▾ to select a higher frequency and ▴ to select a lower frequency.
- 2 Press + or – to adjust the level of that frequency.

Note:

- You can monitor the Center speaker sound while adjusting this item using the Dolby Surround test tone generator. Press **TEST** before starting the procedure above. “TEST DOLBY SUR.” appears, and the test tone starts alternating among the speakers. Once you begin the procedure above, the test tone remains at the Center speaker and you can hear how the sound changes as you adjust the various frequency levels. To turn off the test tone generator, press **TEST** repeatedly until the current DSP program appears.

6. INPUT RENAME

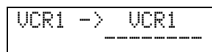

Use this feature to change the name of the input which appears on the OSD or the front panel display.

- 1 Select the input you want to change the name of by pressing an input button (or using the **INPUT** selector).
- 2 Press + or – to blink the underbar for the space or character you want to edit.
- 3 Press ▴ or ▾ to select the character you want to use and + or – to move to the next one.
 - Press ▾ to change the character in the following order, or press ▴ to go in the reverse order.
A~Z, a space, 0~9, a space, a~z, a space, #, *, +, and so on.
 - Follow the procedure above to rename other inputs.
- 4 Press + or – repeatedly to exit the INPUT RENAME mode.

7. I/O ASSIGN

Use this feature to designate the input for the **COMPONENT** jacks (A and B) and **DIGITAL INPUT/OUTPUT** jacks (1) to (10)* to any sources you want. Change the setting when there are not enough digital input jacks depending on the source components you are using. (*10) can be selected for General, China, and Singapore models only.) Initial settings are shown on the display.

7A. For the COMPONENT VIDEO INPUT jacks [A] and [B]

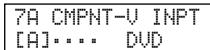
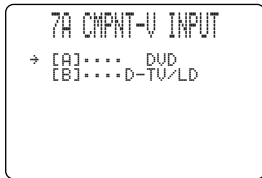

7B. For the OPTICAL OUTPUT jacks (1) and (2)

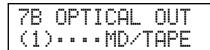
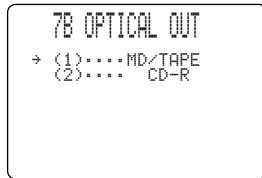

7C. For the OPTICAL INPUT jacks (3) to (7)

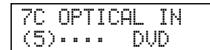
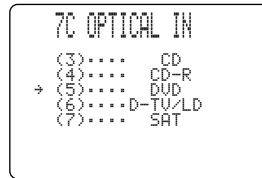

7D. For the COAXIAL INPUT jacks (8) to (10)*

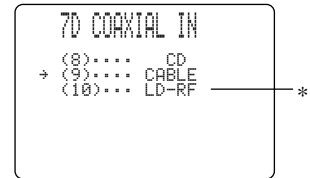

8. INPUT MODE

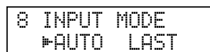

Use this feature to designate the input mode for sources connected to **DIGITAL INPUT** jacks when you turn on this unit.

- Select "AUTO" to allow this unit to automatically detect the type of input signal and select the appropriate input mode.
- Select "LAST" to set this unit to automatically select the last input mode used for that source.

9. PARAMETER INI (Parameter Initialization)

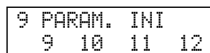
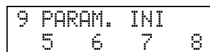
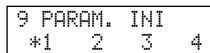
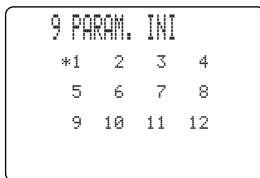

Use this feature to initialize the parameters for each DSP program within a DSP program group. When you initialize a DSP program group, all of the parameter values within that group revert to their initial settings.

- Press the DSP program group button on the remote control for the DSP program you want to initialize.
 - All of the DSP programs within the selected program group are initialized.
- Repeat this step to initialize other DSP program groups.

Notes:

- The asterisk (*) mark next to a DSP program group number indicates that you have changed the parameter values in one or more DSP programs within that group.
- The parameter values of the DSP programs do not change if you initialize a program group that does not have the asterisk (*) mark.
- When the MEMORY GUARD function is set to "ON", you cannot initialize any program groups.
- You cannot initialize the individual DSP programs within a group separately.

Caution:

- Once you initialize a DSP program group, you cannot have this unit revert the parameter values back to the previous settings automatically.

10. DOLBY D. SET (Dolby Digital Set)

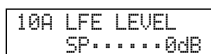

■ 10A. LFE LEVEL

Use this feature to adjust the output level of the LFE (low frequency effect) channel when playing back Dolby Digital encoded software. This setting is effective only when this unit decodes Dolby Digital signals. The LFE signal carries the low frequency special effect sound which is only added to certain scenes.

- You can adjust the levels from 0 dB to -20 dB.
 - Adjust the LFE levels according to the capacity of your subwoofer or headphones.

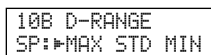

■ 10B. D-RANGE (Dynamic Range)

Use this feature to adjust the dynamic range. This setting is effective only when this unit decodes Dolby Digital signals.

- Select the “MAX” setting for feature films.
- Select the “STD” (Standard) setting for general use.
- Select the “MIN” setting for listening to sources at extremely low volume levels.

11. DTS SET



■ 11. LFE LEVEL

Use this feature to adjust the output level of the LFE (low frequency effect) channel when playing back DTS encoded software. This setting is effective only when this unit decodes DTS signals. The LFE signal carries the low frequency special effect sound which is only added to certain scenes.

- You can adjust the levels from -10 dB to +10 dB.
 - Adjust the LFE level according to the capacity of your subwoofer or headphones.

12. 6.1/ES AUTO

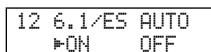

Use this feature to switch the DOLBY Digital Matrix 6.1 and DTS ES AUTO mode on or off.

- Select “ON” to allow the main unit to automatically turn on the Dolby Digital Matrix 6.1 or DTS ES decoder when the software with identification signal is detected.
- Select “OFF” if you want to control the mode manually by pressing **6.1/ES** on the remote.

13. SP DELAY TIME

```

13 SP DELAY TIME
→ CENTER.....0ms
  REAR CNTR...3ms
  
```

```

13 SP DLY TIME
CENTER.....0ms
  
```

Use this feature to adjust the delay of the Center and the Rear Center channel sounds. This feature works when this unit decodes DTS or Dolby Digital signals. Ideally, the Center speaker and the Rear Center speaker should be the same distance from the main listening position as the left and right Main speakers. However, in most home situations, the Center speaker or the Rear Center speaker is placed in line with the Main speakers or the Rear speakers. By delaying the sound from the Center speaker and the Rear Center speaker, the apparent distance from the Center speaker and the Rear Center speaker to the main listening position can be adjusted to make it seem the same as the distance between the left and right Main speaker, and the left and right Rear speakers to the listening position. Adjusting the delay time for the Center speaker is especially important for giving depth to the dialogue.

- You can adjust the delay time from 0 ms to 5 ms for the Center speaker and from 0 ms to 30 ms for the Rear Center speaker.
- Increasing the delay 1 ms simulates moving the speakers about 30 cm (one foot) farther away from the listening position.

14. DISPLAY SET

```

14 DISPLAY SET
→ BLUE BACK...AUTO
  OSD SHIFT...0
  DIMMER.....0
  
```

```

14 DISPLAY SET
BLUE BACK...AUTO
  
```

■ BLUE BACK > AUTO/OFF

You can set the OSD background to blue if the video source is not being reproduced (or the power of the source component is off).

■ OSD SHIFT

This setting is used to adjust the vertical position of the OSD.

■ DIMMER

You can adjust the brightness of the front panel display.

15. MEMORY GUARD

```

15 MEMORY GUARD
>OFF ON
  
```

```

15 MEMORY GUARD
▶OFF ON
  
```

Use this feature to prevent accidental changes to DSP program parameter values and other settings on this unit.

- Select "ON" to use MEMORY GUARD to protect the following features:
 - DSP program parameters
 - All SET MENU items
 - Front, Rear Center speaker and Subwoofer levels
 - The On-Screen Display mode

Notes:

- When MEMORY GUARD is "ON", you cannot use any of the test modes.
- When MEMORY GUARD is "ON", you cannot select any other SET MENU item.

16. ZONE 2 SET

```

16 ZONE2 SET
FIXED VAR.
  
```

```

16 ZONE2 SET
▶FIXED VAR.
  
```

Select ZONE2 OUT to change the setting of the ZONE 2 output volume.

- Select "FIXED" when you don't want to change the volume of output to ZONE 2 with the remote control.
- Selecting "VAR." allows you to control the volume output to ZONE 2 with the remote control.

Remote Control Features

The remote control can operate not only the main unit but also other Yamaha and other manufactures' audio and video components by using the Learning function and other manufactures' code settings. The Macro feature also improves the operability of this unit allowing you to program a series of operations in sequence onto a single button.

Using the Remote Control

<Main Unit Control Area>

The main unit control area is the shaded area shown below. It is for controlling this unit. You can use functions within this area no matter which component control area is selected.

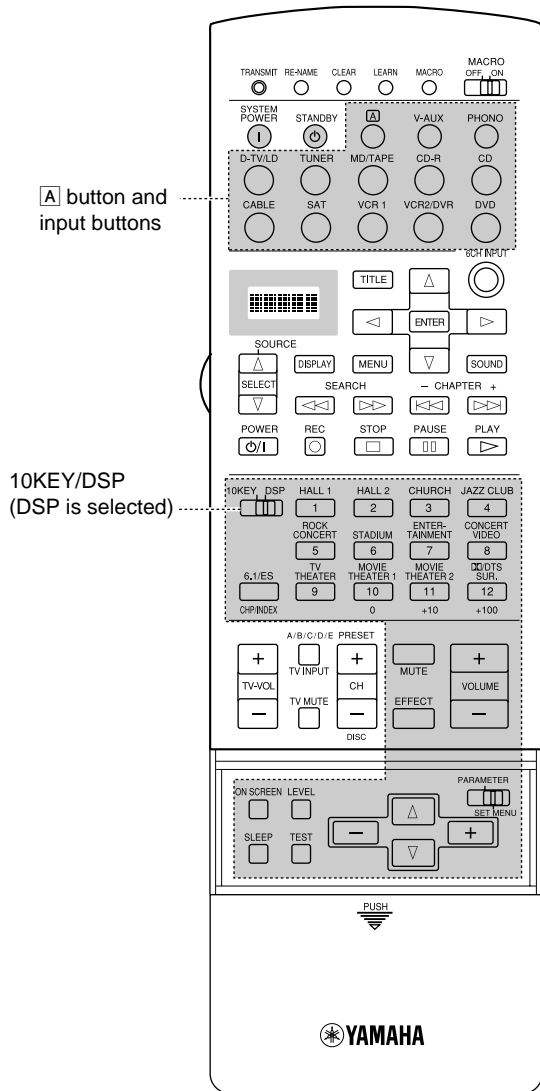

<Component Control Area>

The component control area is the shaded area shown below. Each component has different functions for operation buttons in the component control area. The component, which was chosen by pressing an input button, can be controlled and the display window shows the corresponding name of the input.

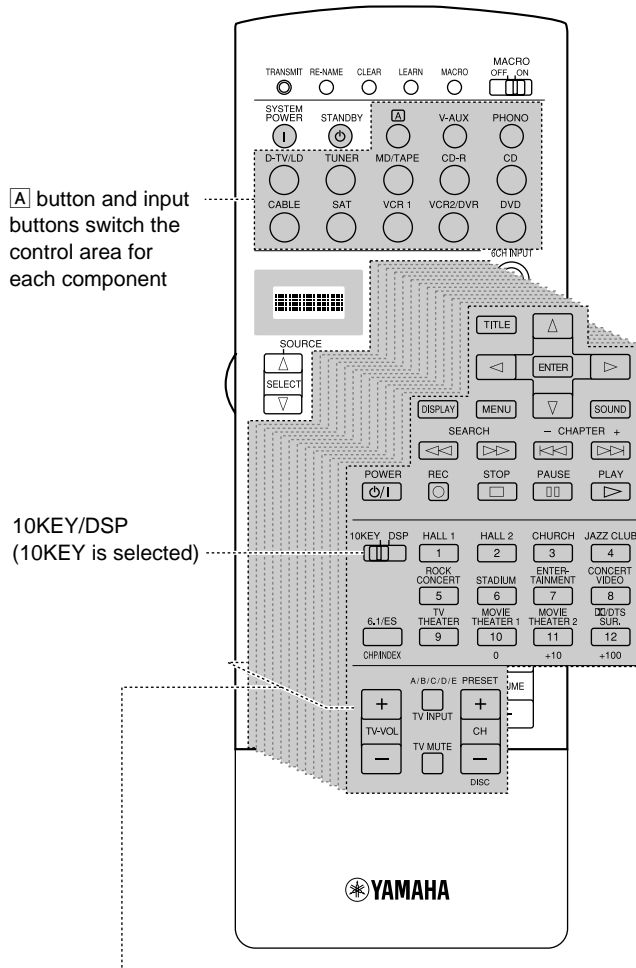

There are 14 component control areas. You can setup the manufacturer code and program other remote control functions in each area (Cannot setup the manufacturer code in the OPTN area).

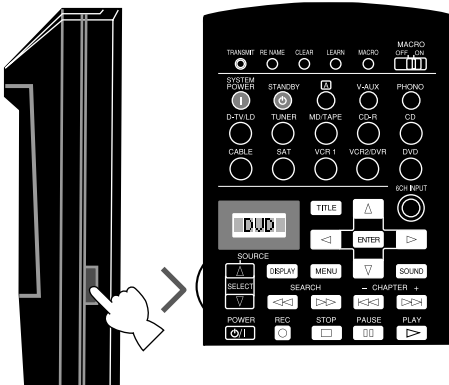
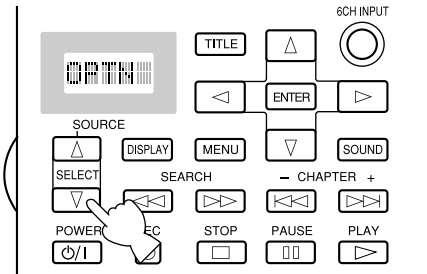
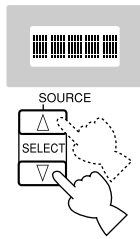

■ SOURCE SELECT

You can control another component independently from the input you selected by pressing an input button.

- 1 Press **SOURCE SELECT** Δ or ∇ to choose a component and set the remote control to be used for it.
- 2 The display window will show one of the following: **V-AUX**, **TAPE**, **PHONO**, **TUNER**, **MD**, **CD**, **VCR 1**, **VCR 2**, **DVD**, **CD-R**, **CABLE** (Cable TV), **SAT** (Satellite TV), **A**, **TV/LD** (digital and regular TV/LD player), **OPTN** (Option).

■ About OPTN

OPTN is an extra component control area to be programmed with other remote control functions. (You cannot setup the manufacturer code in this area.)

■ Light up function

The buttons which are active and the display window light up for 10 seconds after pressing **LIGHT**.

Each Component Control Area

The general operational buttons are shown for each area. Some of them may not function depending on the component you have.

■ TUNER button (Tuner area)

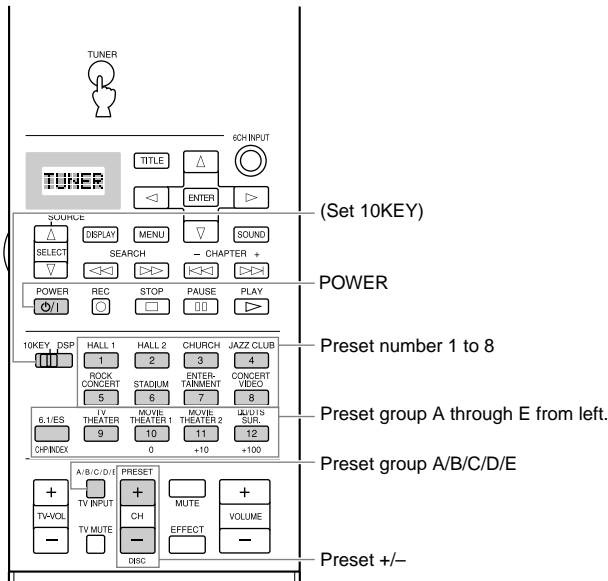

■ CD button (CD area)

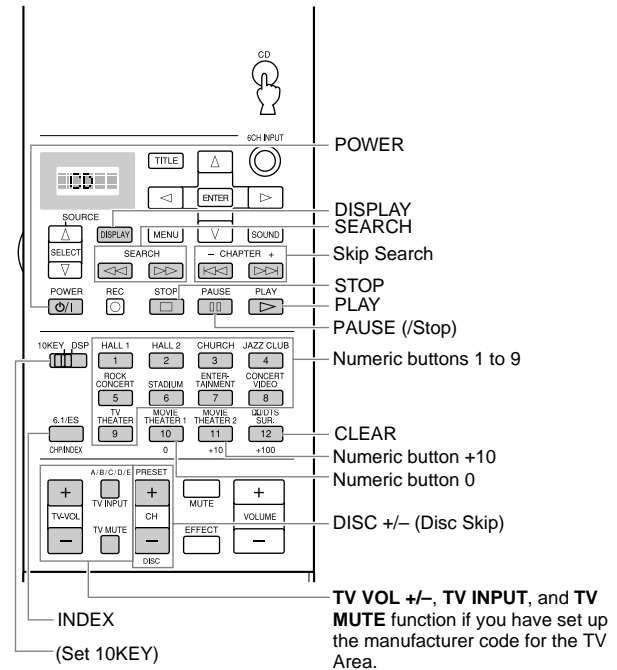

■ MD/TAPE button (MD area*1)

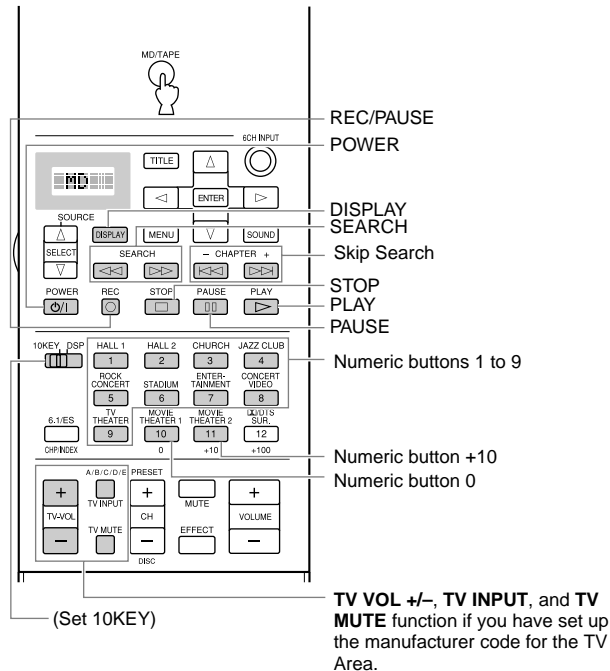

■ CD-R button (CD-R area)

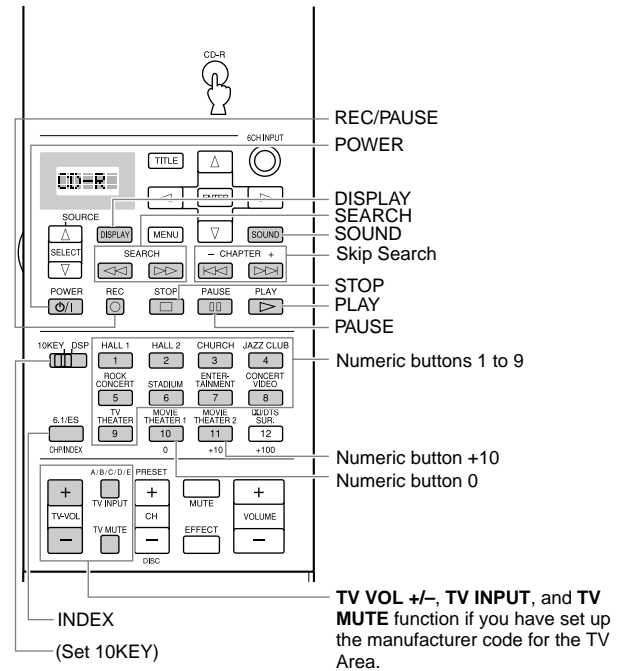

*1 When operating a Tape Deck, set the manufacturer code for TAPE before using the remote control.

PHONO and V-AUX buttons, and OPTN area*2

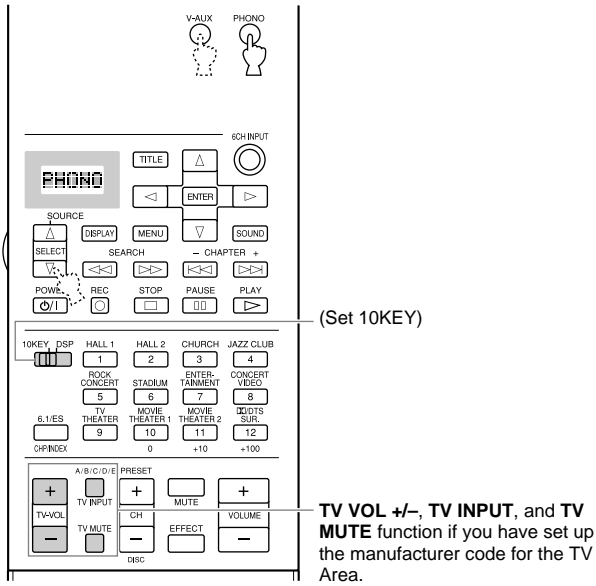

*2 Operational buttons do not work without setting the manufacturer code for the source component.

DVD button (DVD area)

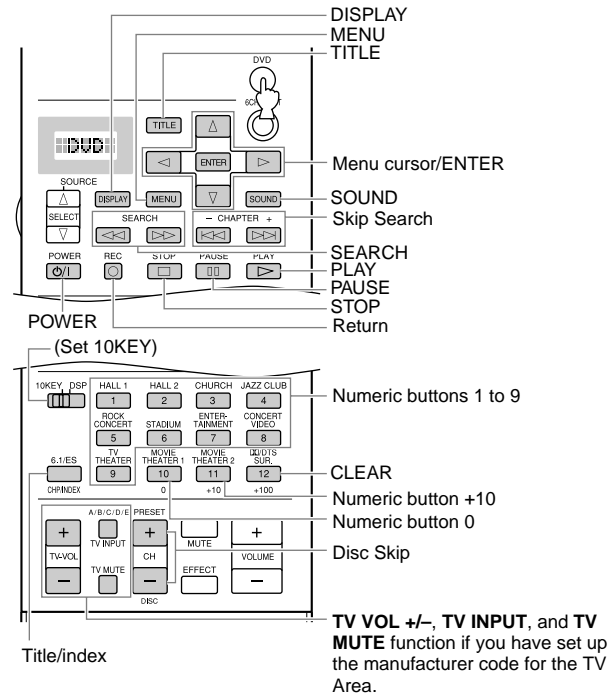

Title/index

D-TV/LD button (TV area*3)

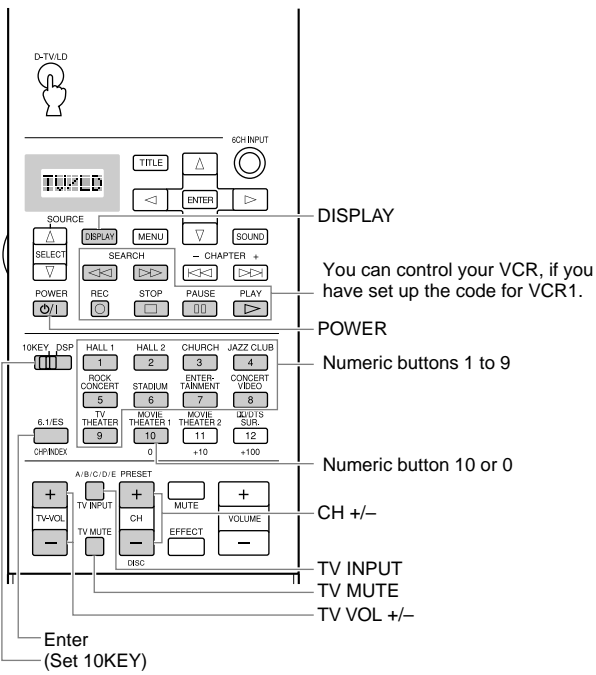

*3 Set the manufacturer code for TV before using the remote control. When operating a LD player, set the manufacturer code for LD before using the remote control. When LD is selected, TV cannot be operated. Set TV code in PHONO button if necessary.

VCR1 and VCR2/DVR button (VCR areas*4)

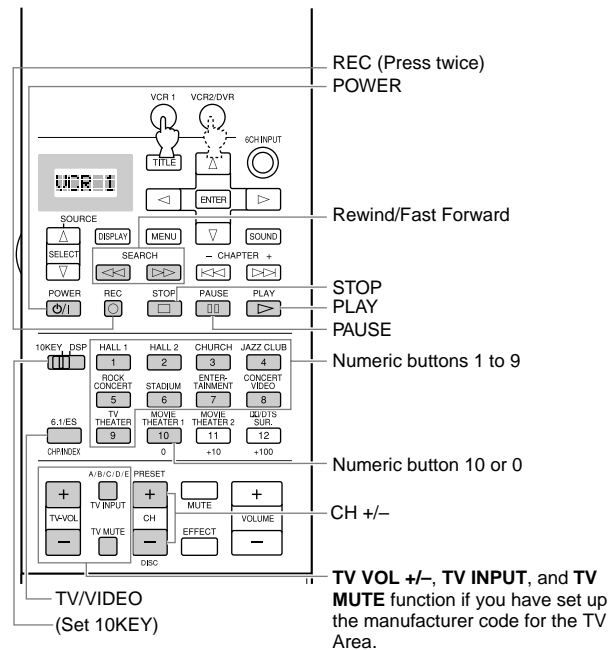

*4 Set the manufacturer code for VCR before using the remote control.

■ **CABLE and SAT buttons (CABLE and SAT areas*5)**

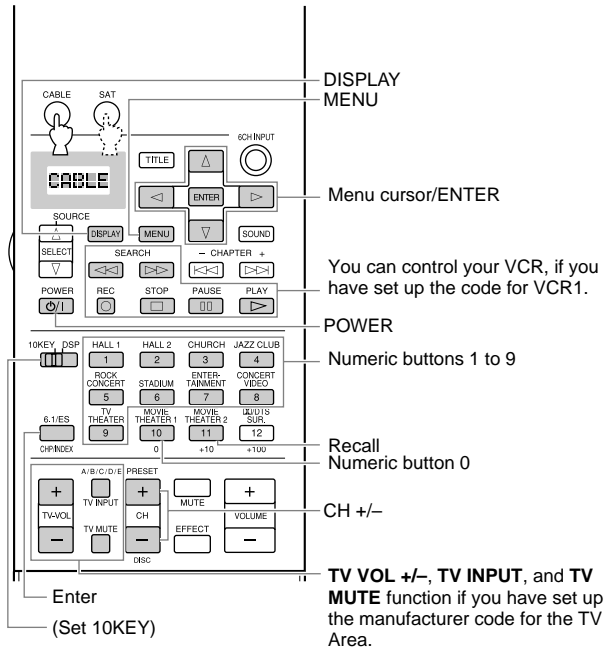

*5 Set the manufacturer code for Cable TV Tuner and Satellite Tuner before using the remote control.

■ **[A] button (ex. LD area*6)**

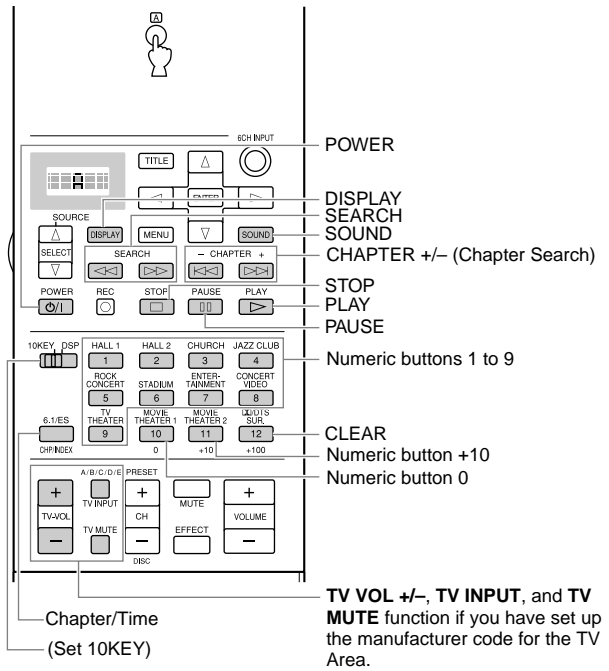

*6 You can control other components that are not connected to this unit. ("A") cannot be used as an Input selector.)

Setting the Manufacturer Code in the Remote Control

You can control other components by setting a manufacturer code. A code can be set up in each component control area except for the OPTN area. The Yamaha code is factory preset for DVD, CD-R, CD, MD, TUNER, and **A** (LD code). There is no factory preset code on VCR1, VCR2/DVR, V-AUX, PHONO, TAPE, CABLE, SAT.

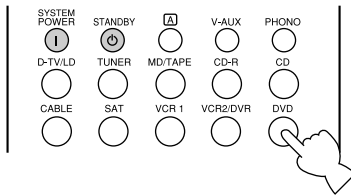

- 1 Select the source component you want to preset by using the input buttons.

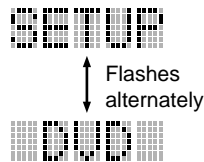

- 2 Press and hold **LEARN** for about three seconds using a ballpoint pen or similar object.

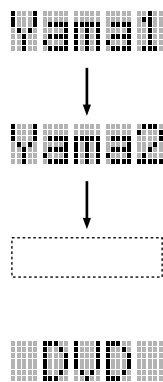
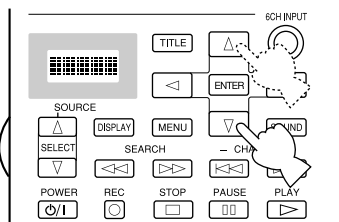

- 3 Use Δ/∇ to select the name of your component's manufacturer.

- You will find the names of most audio-video manufacturers worldwide in alphabetical order on the display window.

- 4 Press **POWER** (or any other button) on the remote control while pointing it at the component to check if you have set up the code correctly. If the component cannot be controlled by the remote control, try entering another code for the same manufacturer.

- 5 Press **LEARN** to confirm the preset.

- If you want to preset another code for another component immediately, press **ENTER** and repeat steps 1 to 4.

Note:

- If you have already programmed a remote control function to a button, the function takes priority over the set up manufacturer code's function.

Controlling a different component from the source component (input) you selected

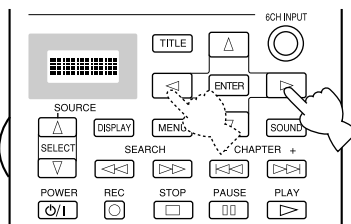

- 1 Repeat steps 1 and 2 of the procedure in "Setting the Manufacturer Code in the Remote Control".

- 2 Select a Library (component category) by using \triangle/∇ .

- There are 13 Libraries to set up a manufacturer code; L:TV, L:CAB (CABLE), L:DBS, L:SAT, L:VCR, L:DVD, L:LD, L:CD, L:MD, L:TAP (TAPE), L:TUN (TUNER), L:CDR, *L:AMP.

- 3 Repeat steps 3 and 4 of the procedure in "Setting the Manufacturer Code in the Remote Control".

About amplifier libraries (L:AMP)

L:AMP has 4 codes: YPC, Zone2, DSP, and No. "YPC" or "Zone2" should be selected to operate this unit. "DSP" is for operating YAMAHA DSP amplifiers other than this unit. "No" is to clear this unit control area functions. ("YPC" is factory-set as the amplifier library. When you make up a second audio-video room with this unit's Zone 2 feature, you must set "Zone2" as the amplifier library in the remote control.)

Note:

- "ERROR" appears in the display window in the following conditions: when pressing a button other than the cursor and **ENTER**; when pressing more than one button at once; and when one of **MACRO ON/OFF**, **10KEY/DSP**, **PARAMETER/SET MENU** is switched to another position.

Programming a New Remote Control Function

If you desire to program functions not included in the basic operations covered by the manufacturer code, or a manufacturer code is not available, the following procedure needs to be performed. The possible programming area is the same as a component control area, so buttons are programmable independently for each source component area. It is also possible to program in the main unit control area.

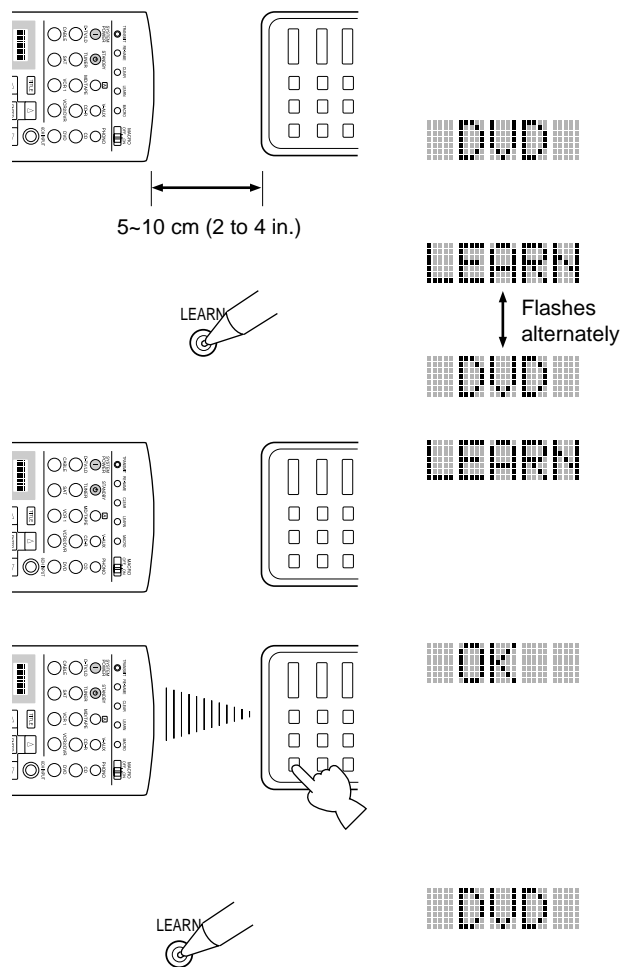

- 1 Place this remote control and the other remote control about 5 to 10 cm (2 to 4 in.) apart on a flat surface so that their infrared transmitters are aimed at each other.
- 2 Select a source component.
- 3 Press **LEARN** using a ball point pen or similar object.
Do not press and hold **LEARN** longer than three seconds. Otherwise this unit enters the Setting the Manufacture Code mode.
- 4 Press and release the button where you want the new function to be programmed.
- 5 Press and hold the button on the other remote control that has the function you want to program into this remote control until "OK" appears in the display window.
 - "NG" appears in display window when programming is not done correctly. Repeat step 4 until "OK" appears in the display.
- 6 Repeat Steps 4 and 5 to program additional functions.
- 7 Press **LEARN** again to exit the Learn mode.

Notes:

- If you do not press any button within 30 seconds, the learning process is canceled.
- This remote control transmits infrared rays. If the other remote control also uses infrared rays, this remote control can learn most of the other remote control's functions. However, you may not be able to program some special signals or extremely long transmissions. (Refer to the operation instructions for the other remote control.) When the memory is full, "FULL" appears in the display window, and this remote control cannot acquire any more functions. Clear unnecessary programmed functions to allow the unit to acquire new functions.
- Even if the batteries in the other remote control have enough power to transmit signals for operation, they may not have enough power to transmit signals to this remote control.
- When the remote controls are either too close together or too far apart, you may not be able to program this remote control.
- Direct sunlight interferes with infrared rays.
- "ERROR" appears in the display window in the following conditions: when pressing more than one button at once; and when **MACRO ON/OFF** is switched to another position.

Using the Macro Feature

The Macro feature makes it possible to perform a series of operations by pressing just one button. For example, when you want to play a CD, normally you would turn on the components, select the CD input, and press the play button to start playback. Using the Macro feature, you can perform all those operations by simply pressing the CD macro button. The macro buttons (the input buttons and **SYSTEM POWER / STANDBY**) are factory preset with macro programs. You can also program your own macros.

(ex) Press a Macro button

Automatically transmits signals of each button sequentially

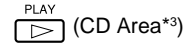

| Macro button |
|--------------|
| |
| V-AUX |
| PHONO |
| D-TV/LD |
| TUNER |
| MD/TAPE |
| CD-R |
| CABLE |
| SAT |
| VCR 1 |
| VCR2/DVR |
| DVD |
| SYSTEM POWER |
| STANDBY |



| First | Second | Third |
|---------|---------------------|------------------------|
| | | |
| | V-AUX | |
| | PHONO | |
| | D-TV/LD | |
| | TUNER | |
| | MD/TAPE | PLAY (MD/TAPE Area*3) |
| | CD-R | PLAY (CD-R Area*3) |
| | CABLE | |
| | SAT | |
| | VCR 1 | PLAY (VCR1 Area*3) |
| | VCR2/DVR | PLAY (VCR2/DTR Area*3) |
| | DVD | PLAY (DVD Area*3) |
| | POWER (D-TV Area*2) | |
| STANDBY | | |

- *1 In order to turn on some Yamaha components connected to this unit, connect those components to **AC OUTLETS** on the rear panel.
- *2 If the macro you select includes power on/off functions, the component may turn off if it is already on when you press the macro button. For example, if your TV is on and you press the **SYSTEM POWER** macro button, the TV turns off.
- *3 The components for which playback can be started are any YAMAHA remote control-compatible MD recorders, CD players, CD recorders, and DVD players. When using macros to operate components other than these or non-YAMAHA components, it is either necessary to learn the **PLAY** button on the control area of that component or to setup a manufacturer code.

■ Operating the Macro feature

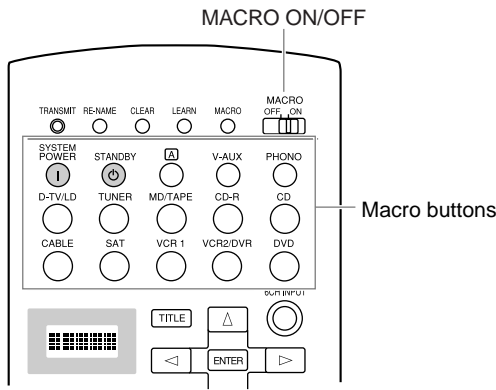

- 1 Set **MACRO ON/OFF** to **ON**.
- 2 Press a Macro button.

Notes:

- When you are finished using the Macro feature, set **MACRO ON/OFF** to **OFF**.
- While the main unit is carrying out a macro program, the main unit does not receive any other button's function until the macro is complete (the **TRANSMIT** indicator stops flashing).
- Continue to aim the remote control at the component the macro is operating until the macro program is complete.

■ Programming a Macro

You can use the Macro feature to transmit many remote control commands by pressing a single button.

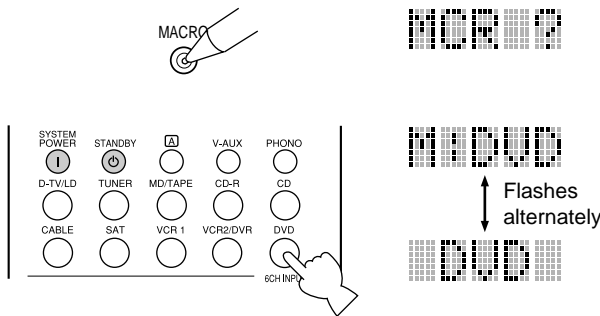

- 1 Press **MACRO** using a ball point pen or similar object.
 - If you do not initiate the procedure within 30 seconds, the macro programming process is canceled.
- 2 Press the macro button on which you want to program the Macro.
 - If you want to change the source component, use **SOURCE SELECT** Δ/∇ or input buttons. When you use input buttons, input is selected as a Macro step, whereas **SOURCE SELECT** Δ/∇ only changes the component.
 - The display window shows the button you chose for programming the macro and the component name in alternation.

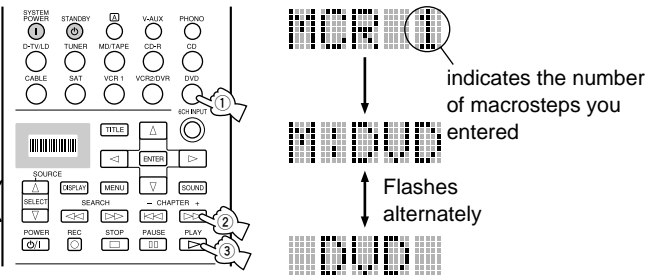

- 3 Press the buttons of the functions that you want to include in the macro sequence in order.
 - You can set up to 10 Macro steps (10 functions).

(ex)

- 1 MCR 1 : DVD input
- 2 MCR 2 : DVD $\triangleright\triangleright$
- 3 MCR 3 : DVD \triangleright

- 4 Press **MACRO** again when the sequence you want to program is complete.
 - After you set 10 steps, "FULL" is displayed.

Notes:

- "NG" appears in the display window when programming is not done correctly.
- "ERROR" appears in the display window in the following conditions: when pressing more than one button at once; and when **MACRO ON/OFF** is switched to another position.

Changing the Source Name in the Display Window

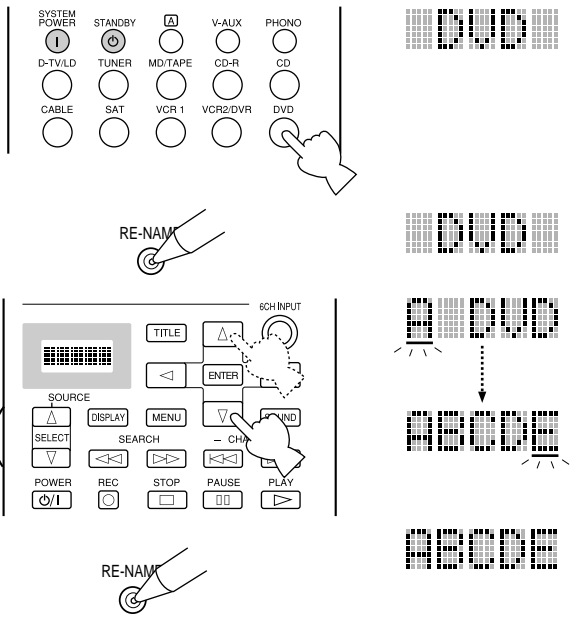

- 1 Select the source component you want to rename by using the input buttons.
- 2 Press **RE-NAME** using a ballpoint pen or similar object.
- 3 Use the cursor buttons Δ/∇ to select a character.
 - Pressing ∇ changes the character in the following order: A~Z, a~z, 0~9, space, -(hyphen), /(slash).
- 4 Use the cursor buttons $\triangleleft/\triangleright$ to enter a character or move to the next cursor position.
- 5 Press **RE-NAME** to confirm renaming.
 - If you want to rename another source component immediately, press **ENTER** and repeat steps 1, 3 and 4.

Clearing a Learned Function or Macro

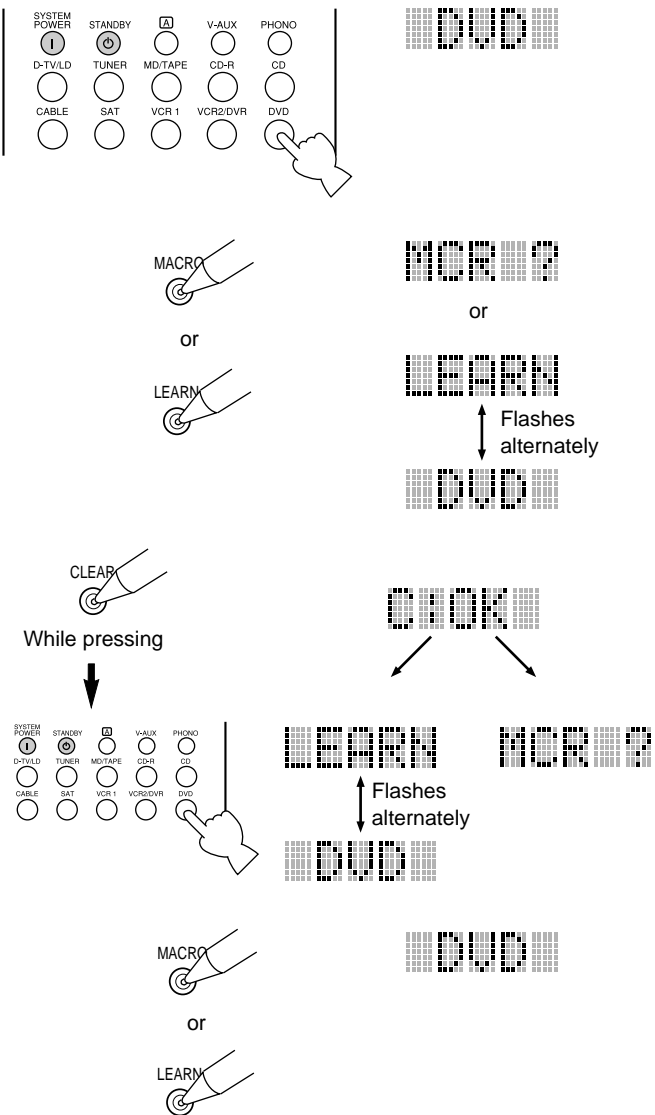

- 1 Select the source component that you want to clear on the window by using input buttons.
- 2 Press **LEARN** if you want to clear a learned function, or press **MACRO** to clear a programmed macro, using a ball point pen or similar object.
- 3 Press and hold **CLEAR** using a ball point pen or similar object, and at the same time press the button from which you want to clear the learned function or macro for about 3 seconds.
 - “C:NG” appears in the display window if the operation is unsuccessful. Should this occur, try doing step 3 again.

You can clear other learned functions and macros at this time by continuing to hold down **CLEAR** and pressing the other buttons on which those learned functions or macros are programmed.
- 4 Press **LEARN** again to confirm clearing a learned function, or press **MACRO** again to confirm clearing a programmed macro.
 - Once you clear a learned function or macro from a button, the button reverts to its factory preset function or macro.

Clearing Learned Functions and Setups



CLEAR

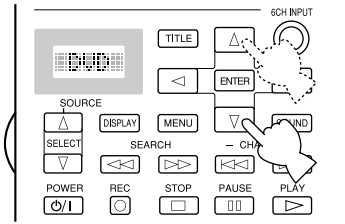

For example, when DVD is selected as the source component.

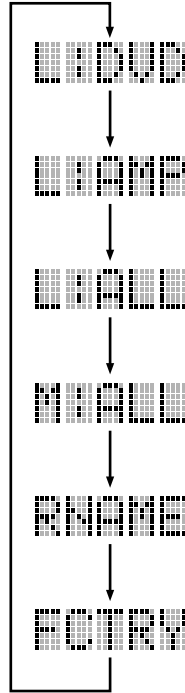

- 1 Press **CLEAR** using a ballpoint pen or similar object.
- 2 Press Δ/∇ to select the mode to be cleared. The mode is shown in the window in the following order:
 - (L: name of a component) Clears all learning functions of the component.
 - Clears all learning functions of the main unit control area.
 - Clears all learning functions.
 - Clears all macros.
 - Clears all renamed displays in the display window.
 - Clears all programmed functions including manufacturer code presets. This returns to the factory presets.



CLEAR

- 3 Press and hold **CLEAR** again for about 3 seconds.
 - “C:NG” appears in the display window if the operation is unsuccessful.

CLEAR



DVD

- 4 Press **CLEAR** to confirm clearing.
 - Once you clear a learned function or macro from a button, the button reverts to its factory preset function or macro.

Notes:

- If the remote control is without batteries for more than twenty minutes, or if worn out batteries remain in the unit, the contents of the memory may be cleared. When the memory is cleared, insert new batteries and program any acquired functions that may have been cleared.
- “ERROR” appears in the display window for the following conditions: when pressing a button other than the cursor and **ENTER**; when pressing more than one button at once; and when one of **MACRO ON/OFF**, **10KEY/DSP**, **PARAMETER/SET MENU** is switched to another position.

ZONE 2

You can make up a multi-room audio-video system with this unit. With this feature, you can set this unit to reproduce separate input sources in the main room and in a second (Zone 2) room using the supplied remote control in the second room.

Only analog signals are sent to the second room. For any source you wish to listen to in the second room, you must connect the analog output from the source to the corresponding analog input on this unit.

Connections

To use the multi-room functions of this unit, you need several additional components:

- Since there are so many ways to connect and use this unit in a multi-room installation, we recommend that you consult with a custom installation specialist for the Zone 2 connections which will best meet your requirements.
- Some Yamaha models are able to connect directly to the **REMOTE OUT** jacks of this unit. If you own these products, you may not need to use an infrared emitter. Up to six Yamaha components can be connected as shown.

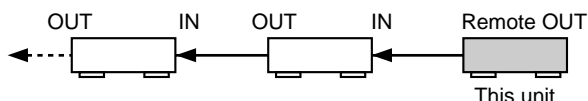

■ A sample of system configuration and connections

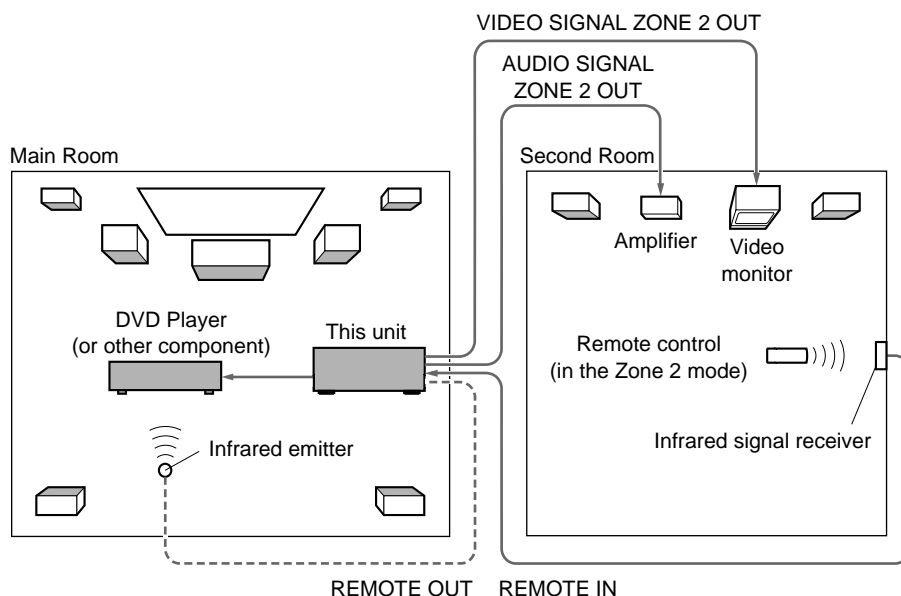

■ Special considerations when using DTS software

The DTS signal is a digital bitstream. Therefore, if you attempt to send the DTS signal to Zone 2, you will only be able to hear the digital noise sound that could damage your loudspeakers.

Due to this characteristic of DTS encoded discs, the following considerations and adjustments need to be made.

For DTS encoded LDs or DVDs

Only 2-channel audio signals may be sent to Zone 2, as follows:

- LDs – Set your Laser Disc player's left and right outputs to the analog sound track.
- DVDs – Use the disc menu to set the DVD player's mixed 2-channel left and right audio outputs to PCM or Dolby Digital.

For DTS encoded compact discs

DO NOT USE the Zone 2 feature with DTS encoded compact discs.

Remote Control in Zone 2

In the second room (Zone 2), the supplied remote control can be used for the Zone 2 remote control. You can select the input source and control the component which is located in the main room directly from the second room regardless of the listening condition in the main room.

Before starting the following procedure, set **REC OUT/ZONE 2** on the front panel to the **SOURCE/REMOTE** position.

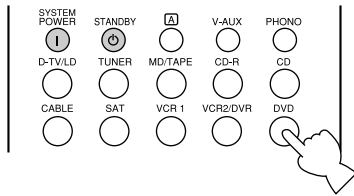

- 1 Press an input button to select the source component you want to set up.



Flashes alternately



- 2 Press and hold **LEARN** for about 3 seconds by using a ballpoint pen or similar object.

“SETUP” and the selected component name appear alternately in the display window.

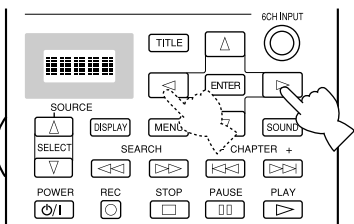

- 3 Press \triangle/∇ to select “L:AMP”.

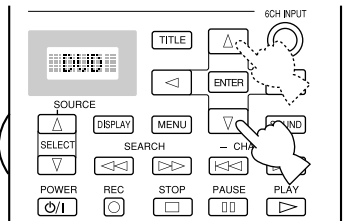

- 4 Press \triangle/∇ to select “ZONE 2”.

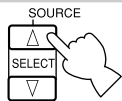

- 5 Press **LEARN** to complete the Zone 2 setup.

- 6 Press **SOURCE SELECT** \triangle to display “Zone2” in the display window.

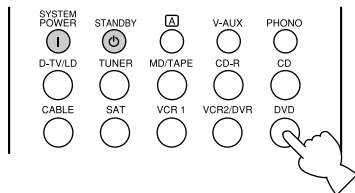

- 7 Press an input button to select the input source you want to listen to in the second room.

The display window shows “2: (name of selected input)” if the remote control is in the Zone 2 mode.

- 8 You can control the component by using the component control area buttons.

Note:

- **VOLUME +/-** can be used to adjust the volume if you set the SET MENU item 16. ZONE2 SET, ZONE2 OUT to “VAR.”.

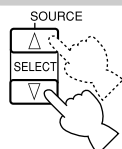

- Press **SOURCE SELECT** \triangle/∇ to exit from the Zone 2 mode.

Adjusting the Levels of the Effect Speakers

You can adjust the volume level of each effect speaker (Center, Right Rear, Rear Center, Left Rear, Front Effect, and Subwoofer) while listening to a music source.

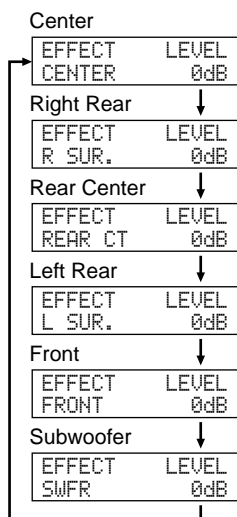
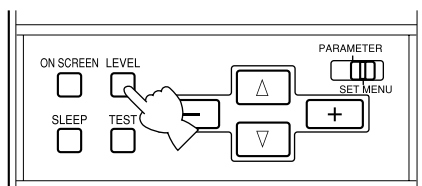

1 Set **PARAMETER/SET MENU** to **PARAMETER**.

2 Press **LEVEL** to select the speaker(s) you want to adjust.

Each time you press this button the selected speaker changes and appears in the front panel display only as follows: Center, Right Rear, Rear Center, Left Rear, Front Effect speakers, and Subwoofer

3 Adjust the speaker volume level using the **+** or **-** on the remote control.

You can adjust the Center, Right Rear, Rear Center, Left Rear, Front Effect speakers from +10 dB to -10 dB.

You can adjust the Subwoofer from 0 dB down to -20 dB.

Notes:

- You cannot adjust the left and right speakers independently.
- When you adjust the speaker level using **LEVEL**, the settings you made using the Dolby Surround Test and DSP Test change.
- When **PARAMETER/SET MENU** is set to **SET MENU**, you cannot adjust the speaker level using **LEVEL**. However, each time you press **LEVEL** the current level setting of each speaker appears. Select the speaker level you want to check using Δ or ∇ .
- When the headphones are connected to this unit, the levels of the effect speakers cannot be adjusted.

Setting the Sleep Timer

Use this feature to automatically turn off the main unit after the amount of time you set. The Sleep Timer is useful when you plan to fall asleep while the main unit is reproducing or recording a source. The Sleep Timer also automatically turns off external components connected to **AC OUTLETS**. The Sleep Timer can only be set using the remote control.

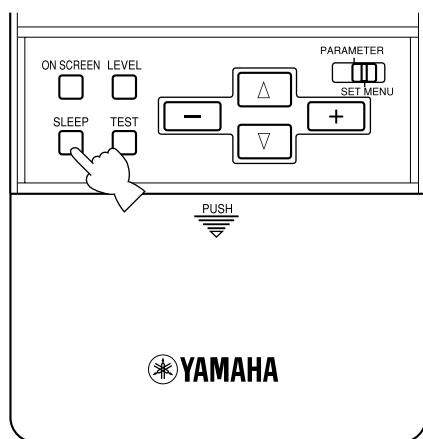

To set the sleep timer

1 Select a source using the **INPUT** selector and start playback (or select a broadcast station) on the source component.

2 Press **SLEEP** repeatedly to set the amount of time before the main unit automatically turns off.

Each time you press **SLEEP**, the front panel display changes as shown below. After a few seconds the display returns to the previous indication.

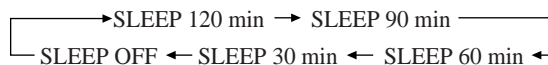

To cancel the sleep timer

1 Press **SLEEP** repeatedly until "SLEEP OFF" appears in the front panel display.

After a few seconds, the display returns to the previous indication.

Note:

- The Sleep Timer setting can also be canceled by turning off the main unit using **STANDBY** on the remote control (or **STANDBY/ON** on the front panel) or by disconnecting the AC Power Cord from the AC outlet.

Additional Information

Digital Sound Field Processing (DSP) 59

| | |
|----------------------------------|----|
| Understanding Sound Fields | 59 |
| Hi-Fi DSP Programs | 60 |

CINEMA-DSP 61

| | |
|----------------------------------|----|
| Sound Design of CINEMA-DSP | 61 |
| CINEMA-DSP Programs | 62 |

DSP Parameter 64

| | |
|---|----|
| Changing Parameter Settings | 64 |
| Parameter Descriptions | 64 |
| Resetting to the Factory Preset Value | 67 |

Understanding Sound Fields



A sound field is defined as the “characteristic sound reflections of a particular space.” In concert halls and other music venues, we hear early reflections and reverberations as well as the direct sound produced by the artist(s). The variations in the early reflections and other reverberations among the different music venues is what gives each venue its special and recognizable sound quality.

Yamaha sent teams of sound engineers all around the world to measure the sound reflections of famous concert halls and music venues, and collect detailed sound field information such as the direction, strength, range, and delay time of those reflections. Then we stored this enormous amount of data in the ROM chips of this unit.

■ Recreating a sound field

Recreating the sound field of a concert hall or an opera house requires localizing the virtual sound sources in your listening room. The traditional stereo system that uses only two speakers is not capable of recreating a realistic sound field. Yamaha’s DSP requires four effect speakers to recreate sound fields based on the measured sound field data. The processor controls the strength and delay time of the signals output from the four effect speakers to localize the virtual sound sources in a full circle around the listener.

The DSP sound field programs can be classified in two types based on the sound field processing method: programs that use early reflections only and programs that use both early reflections and reverberation.

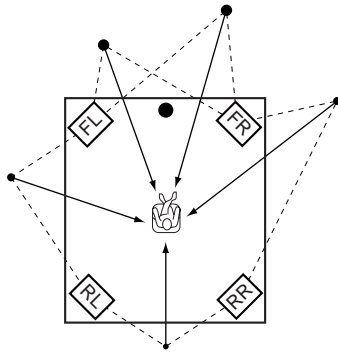

■ E/R (Early Reflection)

Each sound field is distinguished by the structure of the reflected sound. The increased processing capability of DSP technology enables Yamaha engineers to incorporate even minute reflections with long delay times into the sound field data.

■ 4ch REV. (Four Channel Reverberation)

This type of program consists of early reflections and high quality digital reverberation processing. Reverberation is the most important element for recreating the sound field of a church, for example. To recreate a realistic spatial sound image from reverberation data, Yamaha has adapted the four-channel-output reverberation technology.

■ Illustration of the virtual sound sources and echo patterns

The virtual sound sources and echo patterns for the DSP sound field programs are shown below. The illustration of the virtual sound sources shows early reflection sound only and the illustration of the echo patterns shows both reflected sound and reverberation.

Virtual Sound Sources

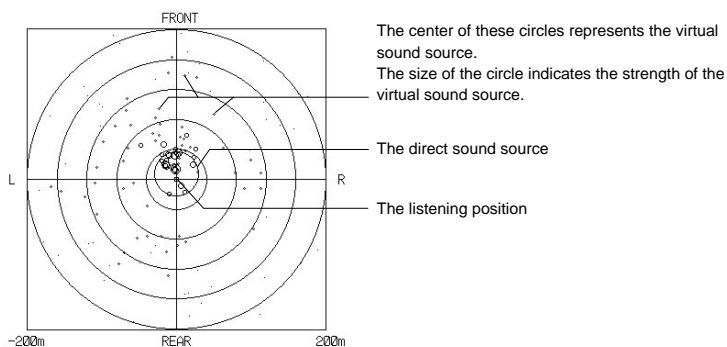

Echo Patterns

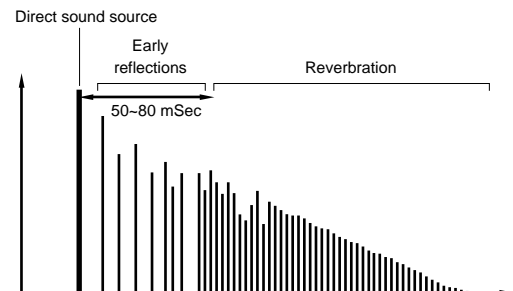

Hi-Fi DSP Programs**Concert Hall 1**

Program Group 1

■ Europe Hall A

This is a large fan-shaped concert hall with approximately 2500 seats. There is relatively little reflection from the walls, and sound spreads finely and beautifully.

■ Europe Hall B

A classic shoe-box type concert hall with approximately 1700 seats. Pillars and ornate carvings create extremely complex reflections which produce a very full, rich sound.

Concert Hall 2

Program Group 2

■ U.S.A. Hall C

This is a large 2600 seat concert hall in the United States which features a fairly traditional European design. The middle and high frequencies are richly and beautifully reinforced.

■ Live Concert

A large round concert hall with a rich surround effect. Pronounced reflections from all directions emphasize the extension of sounds. The sound field has a great deal of presence, and your virtual seat is near the center, close to the stage.

Church

Program Group 3

■ Freiburg

This program recreates the acoustic environment of a big church located in south Germany. The reverberation delay is very long while the early reflections are smaller than with other sound field programs.

■ Royaumont

This program features the sound field created by the refectory (dining hall) of a beautiful medieval Gothic monastery located in Royaumont on the outskirts of Paris.

Jazz Club

Program Group 4

■ Village Gate

This is the sound field at a jazz club in New York. It is in a basement and has a relatively spacious floor area. The listener's virtual seat is at the center left of the hall.

■ The Bottom Line

This is the sound field at stage front in "The Bottom Line", a famous New York jazz club. The floor can seat 300 people to the left and right in a sound field offering a real and vibrant sound.

Rock Concert

Program Group 5

■ Roxy Theatre

The ideal program for lively, dynamic rock music. The data for this program was recorded at LA's "hottest" rock club. The listener's virtual seat is at the center-left of the hall.

■ Arena

A classic shoe-box type concert hall. This program gives you long delays between direct sounds and effect sounds, with the extraordinarily spacious feel of a large arena.

Stadium

Program Group 6

■ Anaheim

This program gives you the long delays and extraordinarily spacious feel of a stadium that is no less than 990 feet (300 meters) in diameter.

■ Bowl

This program gives you the feel of an outdoor stadium with the typical bowl-shaped seating arrangement.

Entertainment

Program Group 7

■ Disco

This program recreates the acoustic environment of a lively disco in the heart of a big city. The sound is dense and highly concentrated.

■ 8ch Stereo

This is a sound field suitable for background music at parties where you can hear the sound directly from the rear as well. The number of speakers to output depends on SPEAKER SET in SET MENU.

Sound Design of CINEMA-DSP

Filmmakers intend the dialog to be located right on the screen, the effect sound a little farther back, the music spread even farther back, and the surround sound around the listener. Of course, all of these sounds must be synchronized with the images on the screen.

CINEMA-DSP is an upgraded version of YAMAHA DSP specially designed for movie soundtracks. CINEMA-DSP integrates the DTS, Dolby Digital, and Dolby Pro Logic surround sound technologies with YAMAHA DSP sound field programs to provide the surround sound field. It recreates the most complete movie sound design in your audio room. In CINEMA-DSP sound field programs, Yamaha's exclusive DSP processing is added to the right and left Main and Center channels, so the listener can enjoy realistic dialogue, depth of sound, smooth transition between sound sources, and a surround sound field that goes beyond the screen.

When a DTS or Dolby Digital signal is detected, the CINEMA-DSP sound field processor automatically chooses the most suitable sound field program for that signal.

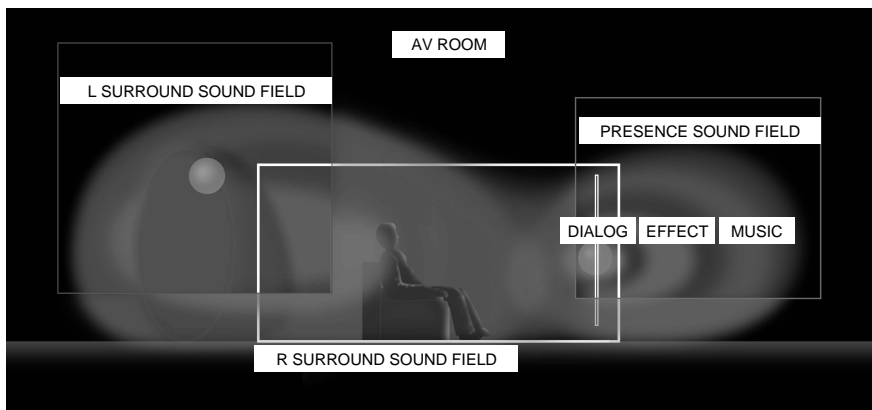

■ Movie theater programs

The six-channel soundtracks found on 70 mm film produce precise sound field localization and rich, deep sound without using matrix processing. This unit's Movie Theater 70 mm Programs provide the same quality of sound and sound localization that six-channel soundtracks do. The built-in Dolby Digital decoder brings the professional quality sound designed for movie theaters into your home. With this unit's Movie Theater program, you can recreate a dynamic sound that gives you the feeling of being at a public theater in your living room using the Dolby Digital technology.

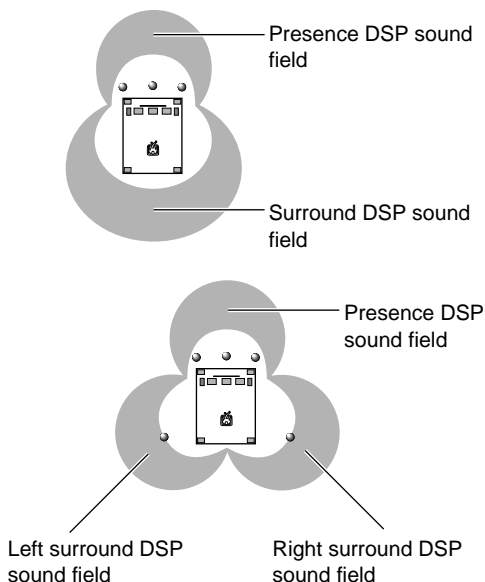

Dolby Pro Logic + DSP sound field effect

These programs express an immense sound field and a large surround effect. They also give depth to the sound from the Main speakers to recreate the realistic sound of a Dolby Stereo theater.

Dolby Digital/DTS + DSP sound field effect

These programs use Yamaha's tri-field DSP process on each of the Dolby Digital or DTS signals for the front, Left surround, and Right surround channels. This processing enables this unit to reproduce the immense sound field and surround expression of a Dolby Digital or DTS equipped movie theater without sacrificing the clear separation of all channels.

Dolby Digital Matrix 6.1/DTS ES + DSP sound field effect

These programs provide you the maximum experience of the spacious surround effects since an extra rear center DSP sound field created from the Rear Center channel is added.

CINEMA-DSP Programs

According to the input signal format, this unit automatically chooses the appropriate decoder and DSP sound field pattern.

Table of Program Names for Each Input Format

| Input | | Stereo (2ch) | DOLBY DIGITAL (5.1ch) | DTS (5.1ch) | DOLBY DIGITAL (6.1ch)* | DTS ES (6.1ch)* |
|-------|-----------------|-----------------|-----------------------|---------------|------------------------|-----------------|
| 7 | ENTERTAINMENT | Game | ———— | ———— | ———— | ———— |
| 8 | CONCERT VIDEO | Classical/Opera | ———— | ———— | ———— | ———— |
| | | Pop/Rock | ———— | ———— | ———— | ———— |
| 9 | TV THEATER | Mono Movie | ———— | ———— | ———— | ———— |
| | | Variety/Sports | ———— | ———— | ———— | ———— |
| 10 | MOVIE THEATER 1 | 70 mm Spectacle | DGTL Spectacle | DTS Spectacle | Spectacle 6.1 | Spectacle ES |
| | | 70 mm Sci-Fi | DGTL Sci-Fi | DTS Sci-Fi | Sci-Fi 6.1 | Sci-Fi ES |
| 11 | MOVIE THEATER 2 | 70 mm Adventure | DGTL Adventure | DTS Adventure | Adventure 6.1 | Adventure ES |
| | | 70 mm General | DGTL General | DTS General | General 6.1 | General ES |
| 12 | PRO LOGIC | Normal | ———— | ———— | ———— | ———— |
| | | Enhanced | ———— | ———— | ———— | ———— |
| | DOLBY DIGITAL | ———— | Normal | ———— | Matrix 6.1 | ———— |
| | | ———— | Enhanced | ———— | Enhanced 6.1 | ———— |
| | DTS DIGITAL SUR | ———— | ———— | Normal | ———— | ES |
| | | ———— | ———— | Enhanced | ———— | Enhanced ES |

* The Matrix decoder is ON.

■ Program groups 7 (Game)~9

These are sound field programs for audio-video sources.

■ Program groups 10~12

Ideal for reproducing a movie program which is encoded with Dolby Surround, Dolby Digital, or DTS. When the newest movie program encoded with 6-channel Digital Surround is input, you can enjoy the full 6.1 channel reproduction using the internal Matrix decoder.

PRO LOGIC functions when the input signal is analog or PCM audio, or encoded with Dolby Digital in two channels.

DOLBY DIGITAL functions when the input signal is encoded with Dolby Digital in more than two channels.

DTS DIGITAL SUR functions when the input signal is encoded with DTS.

Note:

- No sound will be output from the Main speakers when a monaural source is played with sound field Program Groups 7 (Game) and 8–12.

EntertainmentProgram Group **7****■ Game**

This program adds a deep and spatial feeling to video game sounds.

Concert VideoProgram Group **8****■ Classical/Opera**

This program provides excellent vocal depth and overall clarity by restraining excessive reverberation. The surround sound field is relatively moderate but it reproduces beautiful sound using data collected from a concert hall.

■ Pop/Rock

This program produces an enthusiastic atmosphere and lets you feel as if you are at an actual jazz or rock concert.

TV TheaterProgram Group **9****■ Mono Movie**

This program is provided for reproducing monaural video sources (such as old movies). The program produces the optimum reverberation to create sound depth using only the presence sound field.

■ Variety/Sports

Though the presence sound field is relatively narrow, the surround sound field employs the sound environment of a large concert hall. With this program, you can enjoy watching various TV programs such as news, variety shows, music programs, or sports programs.

Movie Theater 1Program Group **10****■ Spectacle**

This program creates the extremely wide sound field of a 70 mm movie theater. It precisely reproduces the source sound in detail, making both the video and the sound fields incredibly real. This program is ideal for any kind of Dolby Surround video source (especially large-scale movie productions).

■ Sci-Fi

This program clearly reproduces the broad and expansive cinematic space from the soundtracks of the latest science fiction films.

Movie Theater 2Program Group **11****■ Adventure**

This program is ideal for precisely reproducing the sound design of the newest 70 mm and multichannel soundtrack films. The sound field is made to be similar to that of the newest movie theaters, so the reverberations of the sound field itself are restrained as much as possible.

■ General

This program is for reproducing sounds from 70 mm and multichannel soundtrack films, and is characterized by a soft and extensive sound field. The presence sound field is relatively narrow. It spatially spreads all around and toward the screen, restraining the effect of conversations without losing clarity.

Dolby/DTS SurroundProgram Group **12****■ Normal/Matrix 6.1/ES**

The built-in decoder precisely reproduces sounds and sound effects from sources. The highly efficient decoding process improves crosstalk and channel separation and makes sound positioning smoother and more precise. In this program, no DSP effect is applied.

■ Enhanced/6.1/ES

This program ideally simulates the multiple surround speaker systems of 35 mm film theaters. The Dolby Surround decoding and the digital sound field processing create precise effects without altering the original sound orientation. The surround effects produced by this sound field wrap around the viewer naturally from the back to the left and right and toward the screen.

DSP Parameter

You can enjoy good quality sound with the preset parameters. Although you do not have to change the initial settings, you can change some of the parameters to better suit the input source or your listening room.

Changing Parameter Settings

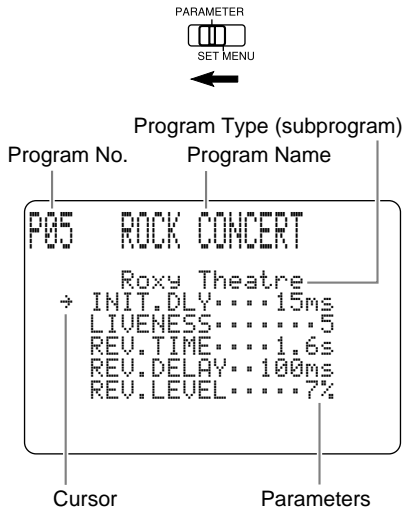

Example using the ROCK CONCERT program

- 1 Set **PARAMETER/SET MENU** to **PARAMETER** on the remote control.
- 2 Turn on your video monitor and press **ON SCREEN** to select the full display.
- 3 Select the sound field program you want to adjust.
- 4 Press ∇ or \triangle to select the parameter.
- 5 Press **+** or **-** to change the parameter value.

When you set the parameter to a value other than the factory preset value, an asterisk mark appears by the parameter name on the monitor screen.

- 6 Repeat steps 3 through 5 above as necessary to change other program parameters.

Parameter Descriptions

You can adjust the values of certain digital sound field parameters so the sound fields are recreated accurately in your listening room. Not all of the following parameters are found in every program.

INIT. DLY (Initial Delay)

[P. INT. DLY for the presence sound field]

Control Range 1 – 99 msec

Function This parameter changes the apparent distance from the source sound by adjusting the delay between the direct sound and the first reflection heard by the listener.

Description The smaller the value, the closer the sound source seems to the listener. The larger the value, the farther the apparent distance seems. For a small room, this parameter would be set to a small value, and for a large room, it would be set to a large value.

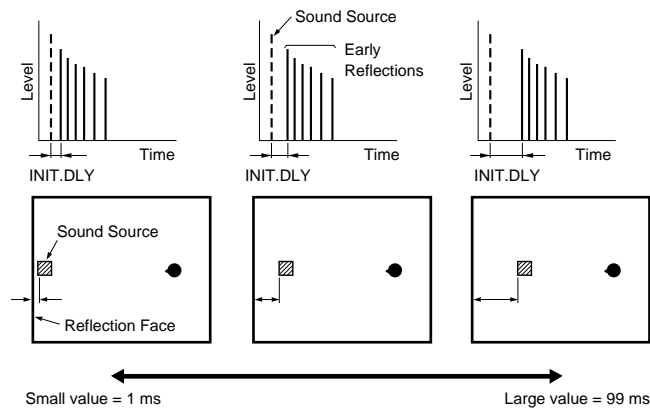

ROOM SIZE

[P. ROOM SIZE for the presence sound field]

Control Range 0.1 – 2.0

Function This parameter adjusts the apparent size of the surround sound field. The larger the value, the larger the surround sound field becomes.

Description As the sound is repeatedly reflected around a room, the larger the hall is, the longer the time between the original reflected sound and the subsequent reflections. By controlling the time between the reflected sounds, you can change the apparent size of the virtual venue. Changing this parameter from one to two, doubles the apparent length of the room.

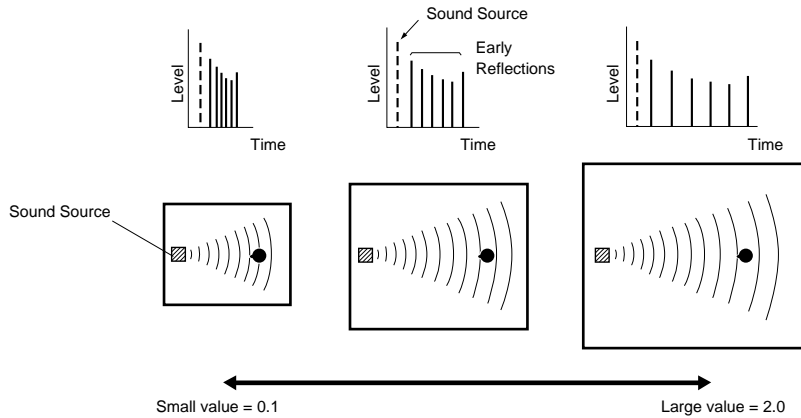

LIVENESS

Control Range 0 – 10

Function This parameter adjusts the reflectivity of the virtual walls in the hall by changing the rate at which the early reflections decay.

Description The early reflections of a sound source decay much faster in a room with acoustically absorbent wall surfaces than in one which has highly reflective surfaces. A room with acoustically absorbent surfaces is referred to as “dead,” while a room with highly reflective surfaces is referred to as “live.” The LIVENESS parameter lets you adjust the early reflection decay rate, and thus the “liveness” of the room.

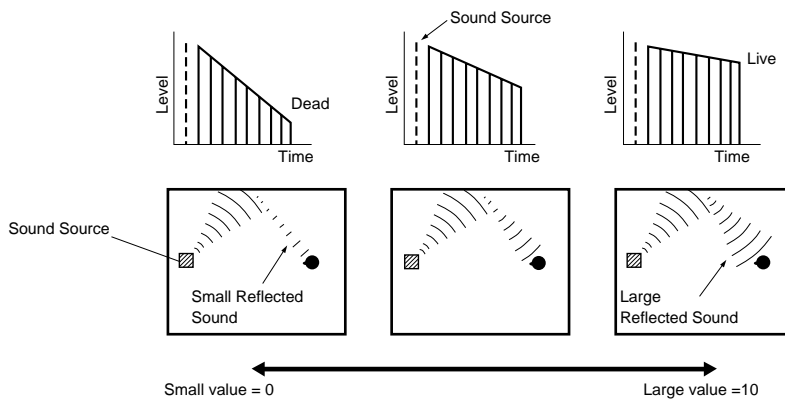

S. DELAY (Surround Delay)

Control Range 0 – 49 msec (The range depends on the signal format.)

Function This parameter adjusts the delay between the direct sound and the first reflection in the surround sound field.

S. INIT. DLY (Surround Initial Delay)

Control Range 1 – 49 msec

Function This parameter adjusts the delay between the direct sound and the first reflection on the surround side of the sound field. You can only adjust this parameter when at least two front channels and two rear channels are used.

S. ROOM SIZE (Surround Room Size)

Control Range 0.1 – 2.0

Function This parameter adjusts the apparent size of the surround sound field.

S. LIVENESS (Surround Liveness)

Control Range 0 – 10

Function This parameter adjusts the apparent reflectivity of the virtual walls in the surround sound field.

RC. INIT. DLY (Rear Center Initial Delay)

Control Range 1 – 49 msec

Function This parameter adjusts the delay between the direct sound and the first reflection in the rear center sound field.

RC. ROOM SIZE (Rear Center Room Size)

Control Range 0.1 – 2.0

Function This parameter adjusts the apparent size of the rear center sound field.

RC. LIVENESS (Rear Center Liveness)

Control Range 0 – 10

Function This parameter adjusts the apparent reflectivity of the virtual wall in the rear center sound field.

REV. TIME (Reverberation Time)

Control Range 1.0 – 5.0 sec

Function This parameter adjusts the amount of time it takes for the dense, subsequent reverberation sound to decay by 60 dB (at 1 kHz). This changes the apparent size of the acoustic environment over an extremely wide range.

Description Set a longer reverberation time for “dead” sources and listening room environments, and a shorter time for “live” sources and listening room environments.

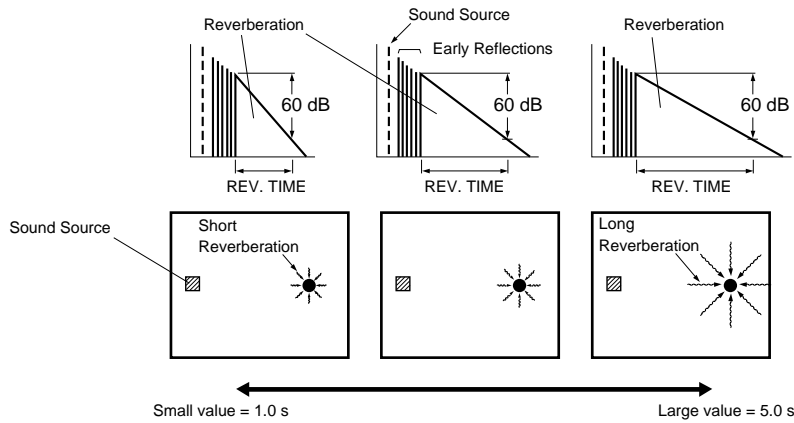

REV. DELAY (Reverberation Delay)

Control Range 0 – 250 msec

Function This parameter adjusts the time difference between the beginning of the direct sound and the beginning of the reverberation sound.

Description The larger the value, the later the reverberation sound begins. A later reverberation sound makes you feel like you are in a larger acoustic environment.

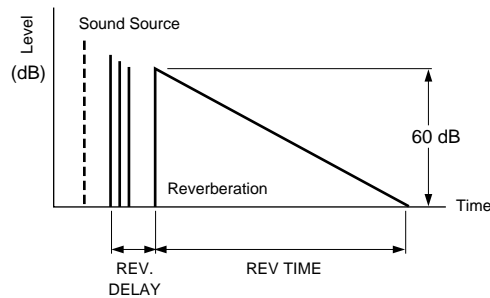

REV. LEVEL (Reverberation Level)

Control Range 0 – 100 %

Function This parameter adjusts the volume of the reverberation sound.
 Description The larger the value, the stronger the reverberation becomes.

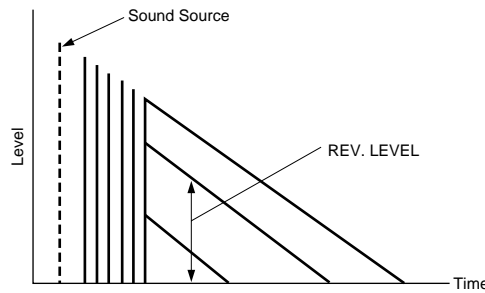

CT. DELAY (Center Delay)

Control Range 0 – 50 msec

Function These parameters adjust the sound delay for each channel in 8 channel stereo mode.

LS. DELAY (Left Surround Delay)

Control Range 0 – 50 msec

Function These parameters adjust the sound delay for each channel in 8 channel stereo mode.

RC. DELAY (Rear Center Delay)

Control Range 0 – 50 msec

Function These parameters adjust the sound delay for each channel in 8 channel stereo mode.

RS. DELAY (Right Surround Delay)

Control Range 0 – 50 msec

Function These parameters adjust the sound delay for each channel in 8 channel stereo mode.

FL. DELAY (Front Left Delay)

Control Range 0 – 50 msec

Function These parameters adjust the sound delay for each channel in 8 channel stereo mode.

FR. DELAY (Front Right Delay)

Control Range 0 – 50 msec

Function These parameters adjust the sound delay for each channel in 8 channel stereo mode.

Resetting to the Factory Preset Value

■ To reset a parameter to the factory preset value

Select the parameter you want to reset. Then, press and hold + or – until the value stops at the factory preset value temporarily. (The asterisk mark by the parameter name disappears on the video monitor.)

■ To reset all of the parameters back to the factory preset values

Use the SET MENU to reset all of the parameter values of all DSP programs within the selected group to the factory preset values. This operation resets all of the parameter values of all DSP programs within that group to the factory preset values.

Notes:

- The available parameters may be displayed on more than one OSD page for some of the programs. To scroll through pages, press ▽ or △.
- When “MEMORY GUARD!” appears on the screen, the Memory Guard function is on, and you cannot change parameter values. Turn off the Memory Guard function using the SET MENU.

Appendix

Troubleshooting

Refer to the chart below when this unit does not function properly. If the problem you are experiencing is not listed below or if the instruction below does not help, turn the power off, disconnect the power cord, and contact your dealer or the nearest Yamaha Audio Products Service Department.

After this unit is exposed to strong external electric shock (such as lightning and large static electricity) or you mishandle the operation of this unit, it may not function properly. In these cases, turn the power off, unplug the power cord, plug it back in after 30 seconds, and start operating.

General

| Problem | Possible Cause | What to Do |
|---|---|--|
| The unit fails to turn on when STANDBY/ON is pressed, or returns to standby mode suddenly soon after the power is turned on. | The power cord is not plugged in or is not completely inserted. | Plug in the power cord securely. |
| | IMPEDANCE SELECTOR on the rear panel is not set correctly. | Set the switch completely to either position (depending on your speakers) while this unit is in standby mode. |
| | The protection circuitry has been activated. | Make sure all speaker wire connections on this unit and on all speakers are secure and that the wire for each connection does not touch anything other than its respective connection. |
| Hum | There is a faulty cable connection. | Connect the audio plugs securely. If the problem persists, the cords may be defective. |
| | No connection from the turntable to the GND terminal. | Connect the grounding cord of your turntable to the GND terminal of this unit. |
| No sound or no picture | The volume is turned down. | Turn up the volume. |
| | Faulty or incorrect input or output connection. | Connect the component correctly. If the problem persists, the cords may be defective. |
| | Incorrect input source. | Select the appropriate input source with the INPUT selector. |
| | This unit is set to DTS input mode. | Press INPUT MODE to select another input mode |
| | Digital signals other than PCM audio, Dolby Digital, or DTS encoded signals are input to this unit by playing a CD-ROM, etc. | Play a source whose signals this unit can reproduce. |
| No picture | The source component is connected to this unit using an S-video cable, but there is no S-video connection between this unit and your video monitor. | Connect this unit's S VIDEO MONITOR OUT terminal to the TV's S-video input terminal or disconnect the S-video cable from the source component. |
| No sound is coming from one side. | There is a faulty cable connection. | Connect all cables securely. If the problem persists, the cords may be defective. |
| The volume level cannot be increased very much when adjusting VOLUME . | MUTE is on. | Turn VOLUME to minimum, press MUTE to restore audio, and adjust the volume again. |
| | The component connected to the MD/TAPE OUT or CD-R OUT jacks of this unit is turned off. | Turn on the power to the component. |
| The sound suddenly goes off. | The protection circuitry has been activated because of short circuit etc. | Check that the IMPEDANCE SELECTOR switch is set to the appropriate position and then turn the unit back on. Check that the speaker wires are not touching each other and then turn the unit back on. |
| | The SLEEP timer came on. | Cancel the SLEEP timer function. |
| | The sound is muted. | Press MUTE or any operation buttons of this unit to cancel a mute and adjust the volume. |
| No sound is coming from the Effect speakers. | The effect is off. | Press EFFECT to turn on the effect sound. |
| | A Dolby Surround or DTS decoding sound field program is being used with material not encoded with Dolby Surround or DTS. | Select another sound field program. |
| No OSD on the video monitor. | DISPLAY OFF is selected. | Select "Full Display" or "Short Display". |
| | BLUE BACK is OFF at DISPLAY SET . | Select "AUTO". |

Troubleshooting

| Problem | Possible Cause | What to Do |
|--|---|--|
| No sound is coming from the Front Effect speakers. | PRO LOGIC/Normal, DOLBY DIGITAL/Normal or DTS DIGITAL SUR./Normal of DSP program 12 is selected. | Select another sound field program. |
| | The front level is set to minimum. | Adjust the Front Effect speaker level. |
| | The 1F. FRNT EFCT item in the SET MENU is set to "NONE". | Select "YES". |
| No sound is coming from the Center speaker. | The 1A. CENTER SP item in the SET MENU is set to "NONE". | Select the appropriate mode for your Center speaker. |
| | One of the Hi-Fi DSP sound field programs (1 to 7 (except "Game")) is selected. | Select another sound field program. |
| | The input signals of a source encoded with Dolby Digital or DTS do not include center channel signals. | Refer to the instructions for the source currently playing. |
| No sound is coming from the Rear Effect speakers. | The right and left Rear speaker levels are set to minimum. | Increase the right and left Rear speaker levels. |
| | A monaural source is played with sound field program 12. | Select another sound field program. |
| No sound is coming from the Subwoofer. | The 1E. LFE/BASS OUT item in the SET MENU is set to "MAIN" when a Dolby Digital or DTS encoded software is played. | Select "SWFR" or "BOTH". |
| | The 1E. LFE/BASS OUT item in the SET MENU is set to "SWFR" or "MAIN" when 2-channel encoded software is played. | Select "BOTH". |
| Poor bass reproduction. | The 1E. LFE/BASS OUT item in the SET MENU is set to "SWFR" or "BOTH" and your system does not include a subwoofer. | Select "MAIN". |
| | The output mode selection for each channel (MAIN, CENTER, or REAR) in the SET MENU does not match your speaker configuration. | Select the appropriate output mode for each channel based on the size of the speakers in your configuration. |
| The volume level cannot be increased, or sound is distorted. | The power to the component connected to the REC OUT jacks of this unit is off. | Turn on the power to the component. |
| DSP parameters and some other settings on this unit cannot be changed. | The 15. MEMORY GUARD item in the SET MENU is set to "ON". | Select "OFF". |
| This unit does not operate properly. | The internal microcomputer has been frozen by an external electric shock (such as lightning or excessive static electricity) or by a power supply with low voltage. | Disconnect the AC power cord from the outlet, then plug it in again after about one minute. |
| A source cannot be recorded by a tape deck or VCR connected to this unit. | The source unit is connected to this unit using digital jacks only. | Make additional connections to the analog jacks. |
| CHECK SP WIRES!" appears on the display. | Speaker cables are short circuited. | Make sure all speaker cables are connected correctly. |
| There is noise from a nearby TV or tuner. | This unit is too close to the affected component. | Move this unit farther away from the affected component. |
| The sound is degraded when listening with the headphones connected to a CD player or cassette deck that is connected to this unit. | The power to this unit is off. | Turn on the power to this unit. |
| "INPUT DATA ERROR" appears on the display and no sound is heard. | A non-standard source is played back, or the component playing back the source is not operating correctly. | Check the source, or turn off the source component, then turn it on again. |

Tuner

| | Problem | Possible Cause | What to Do |
|----|---|--|---|
| FM | FM stereo reception is noisy. | Because of the characteristics of FM stereo broadcasts, this is limited to cases where the transmitter is too far away or the antenna input is poor. | Check the antenna connections. Try using a high quality directional FM antenna. Set TUNING MODE to the manual tuning mode. |
| | There is distortion and clear reception cannot be obtained even with a good FM antenna. | There is multipath interference. | Adjust the antenna orientation to eliminate multipath interference. |
| | A desired station cannot be tuned in with the automatic tuning method. | The station is too weak. | Use the manual tuning method. Use a high quality directional FM antenna. |
| | Previously preset stations can no longer be tuned in using preset tuning. | This unit has been unplugged for a long period. | Repeat the presetting procedure. |
| AM | A desired station cannot be tuned in with the automatic tuning method. | Weak signal or loose antenna connections. | Tighten the AM loop antenna connections and adjust the antenna's orientation for best reception. Use the manual tuning method. |
| | There are continuous crackling and hissing noises. | Noises result from lightning, fluorescent lamps, motors, thermostats and other electrical component. | Use an outdoor antenna and a ground wire. This will help somewhat but it is difficult to eliminate all the noises. |
| | There are buzzing and whining noises (especially in the evening). | A television set is being used nearby. | Relocate this unit away from the TV. |

Remote Control

| Problem | Possible Cause | What to Do |
|--|--|--|
| The remote control does not work. | The batteries are dead. | Replace the batteries with new ones and press RESET inside the battery compartment. |
| | The internal microcomputer has “frozen”. | Press RESET inside the battery compartment. |
| The remote control does not function properly. | Wrong distance or angle. | The remote control will function within a maximum range of 6 m (20 feet), no more than 30 degrees off-axis from the front panel. |
| | Direct sunlight or lighting (such as an inverter type of fluorescent lamp) is striking the remote control sensor of this unit. | Change the position of this unit. |
| | The internal microcomputer has “frozen”. | Press RESET inside the battery compartment. |
| The remote control does not “learn” new functions. (The TRANSMIT indicator does not light up or flash.) | The batteries of this remote control and/or the other remote control are too weak. | Replace the batteries (and press RESET inside the battery compartment). |
| | The distance between the two remote controls is too far or near. | Place the remote controls at the proper distance. |
| | The signal coding or modulation of the other remote control is not compatible with this remote control. | Learning is not possible. |
| | Memory capacity is full. | Further learning is not possible without deleting unnecessary functions. |
| | The internal microcomputer has “frozen”. | Press RESET inside the battery compartment. |
| Continuous functions such as volume are learned, but operate only for a moment before stopping. | The learning process is incomplete. | Be sure to press and hold the function button on the other remote control until TRANSMIT begins flashing slowly. |

Specifications

Audio Section

| | |
|---|-------------------------|
| Minimum RMS Output Power | |
| 20 Hz to 20 kHz, 0.02% THD, 8 ohms | |
| Main L/R, Center, Rear L/R, Rear Center | 100 W |
| 1 kHz, 0.05% THD | |
| Front L/R | 25 W |
| <General and China models> | |
| Maximum Output Power (EIAJ) | |
| 1 kHz, 10% THD, 8 ohms | |
| Main L/R, Center, Rear L/R, Rear Center | 135 W |
| Front L/R | 35 W |
| DIN Standard Output Power | |
| 1 kHz, 0.7% THD, 4 ohms, Main L/R | 160 W |
| IEC Output Power | |
| 1 kHz, 0.015% THD, 8 ohms, Main L/R | 115 W |
| Dynamic Power (IHF) | |
| 8/6/4/2 ohms, Main L/R | 140/170/220/320 W |
| Damping Factor | |
| 20 Hz to 20 kHz, 8 ohms, Main L/R | 200 or more |
| Power Band Width | |
| 50 W, 0.08% THD, 8 ohms, Main L/R | 10 Hz to 50 kHz |
| Frequency Response | |
| CD to Main L/R | 10 Hz to 100 kHz, -3 dB |
| Total Harmonic Distortion | |
| 20 Hz to 20 kHz, 50 W, 8 ohms, Main L/R | 0.015% |
| Signal to Noise Ratio (IHF-A Network) | |
| CD (250 mV input shorted) to Main L/R, Effect Off | 100 dB |
| PHONO (5 mV input shorted) to Main L/R, Effect Off | |
| [U.S.A., Canada, General and China models] | 86 dB |
| [Australia and Singapore models] | 82 dB |
| Residual Noise (IHF-A Network) | |
| Main L/R | 150 µV or less |
| Channel Separation (1 kHz/10 kHz) | |
| CD (5.1k terminated) to Main L/R | 60 dB/45 dB |
| Tone Control (Main L/R) | |
| BASS Boost/Cut | ±10 dB/50 Hz |
| TREBLE Boost/Cut | ±10 dB/20 kHz |
| Bass Extension | +6 dB/60 Hz |
| Phones Output | 150 mV/100 ohms |
| Input Sensitivity | |
| CD etc. | 150 mV/47 kohms |
| Phono | 2.5 mV/47 kohms |
| Main In | 1 V/47 kohms |
| Output Level | |
| REC OUT | 150 mV/1 kohms |
| PRE OUT | 1 V/1.2 kohms |
| SUB WOOFER | 4 V/1.2 kohms |
| ZONE 2 OUT | 1 V/1.5 kohms |

Video Section

| | |
|--|--------------------|
| Video Signal Type | |
| [U.S.A. and Canada models] | NTSC |
| [Australia and Singapore models] | PAL |
| [General and China models] | NTSC/PAL |
| Component Video Signal Level | 1 Vp-p/75 ohms |
| S-Video Signal Level | |
| Y | 1 Vp-p/75 ohms |
| C | 0.286 Vp-p/75 ohms |

| | |
|----------------------------------|----------------------|
| Component Video Signal Level | |
| Y | 1 Vp-p/75 ohms |
| PB/CB, PR/CR | 0.7 Vp-p/75 ohms |
| Signal to Noise Ratio | 50 dB |
| Frequency Response (MONITOR OUT) | |
| Composite, S-Video | 5 Hz to 10 MHz -3 dB |
| Component | DC to 30 MHz -3 dB |

FM Section

| | |
|---|-------------------------------------|
| Tuning Range | |
| [U.S.A. and Canada models] | 87.5 to 107.9 MHz |
| [Others] | 87.50 to 108.00 MHz |
| 50 dB Quieting Sensitivity (IHF, 100% mod.) | |
| Mono/Stereo | 2.0 µV (17.3 dBf) /25 µV (39.2 dBf) |
| Selectivity (400 kHz) | 70 dB |
| Signal to Noise Ratio (IHF) | |
| Mono/Stereo | 76 dB/70 dB |
| Harmonic Distortion (1 kHz) | |
| Mono/Stereo | 0.2%/0.3% |
| Stereo Separation (1 kHz) | 45 dB |
| Frequency Response | 20 Hz to 15 kHz +0.5, -2 dB |

AM Section

| | |
|--|--------------------------|
| Tuning Range | |
| [U.S.A. and Canada models] | 530 to 1710 kHz |
| [General and China models] | 530/531 to 1710/1611 kHz |
| [Australia and Singapore models] | 531 to 1611 kHz |
| Usable Sensitivity | 300 µV/m |

General

| | |
|--|--|
| Power Supply | |
| [U.S.A. and Canada models] | AC 120 V/60 Hz |
| [Australia model] | AC 240 V/50 Hz |
| [Singapore model] | AC 230 V/50 Hz |
| [General and China models] | AC 110/120/220/240 V, 50/60 Hz |
| Power Consumption | 480 W/630 VA |
| Standby Mode | 1.5 W |
| AC Outlets (Total 100W /1A maximum) | 3 (Switched) |
| [Australia model] | 1 (Switched) |
| Dimension (W x H x D) | |
| | 449 x 191 x 468 mm (17-5/8" x 7-1/2" x 18-7/16") |
| Weight | 22 kg (48.5 lbs) |
| Accessories | Remote Control |
| | Batteries |
| | AM Loop Antenna |
| | Indoor FM Antenna |
| | Quick Reference Guide |
| | Side Panel Sticker |
| [U.S.A., Canada, and Singapore models] | Power Cord |

* Specifications are subject to change without notice.



YAMAHA ELECTRONICS CORPORATION, USA 6660 ORANGETHORPE AVE., BUENA PARK, CALIF. 90620, U.S.A.
YAMAHA CANADA MUSIC LTD. 135 MILNER AVE., SCARBOROUGH, ONTARIO M1S 3R1, CANADA
YAMAHA ELECTRONIK EUROPA G.m.b.H. SIEMENSSTR. 22-34, 25462 RELLINGEN BEI HAMBURG, F.R. OF GERMANY
YAMAHA ELECTRONIQUE FRANCE S.A. RUE AMBROISE CROIZAT BP70 CROISSY-BEAUBOURG 77312 MARNE-LA-VALLÉE CEDEX02, FRANCE
YAMAHA ELECTRONICS (UK) LTD. YAMAHA HOUSE, 200 RICKMANSWORTH ROAD WATFORD, HERTS WD1 7JS, ENGLAND
YAMAHA SCANDINAVIA A.B. J A WETTERGRENS GATA 1, BOX 30053, 400 43 VÄSTRA FRÖLUNDA, SWEDEN
YAMAHA MUSIC AUSTRALIA PTY, LTD. 17-33 MARKET ST., SOUTH MELBOURNE, 3205 VIC., AUSTRALIA

YAMAHA CORPORATION
Printed in Japan **UP** VIDEO V652420-1

Quick Reference Card

Remote Control

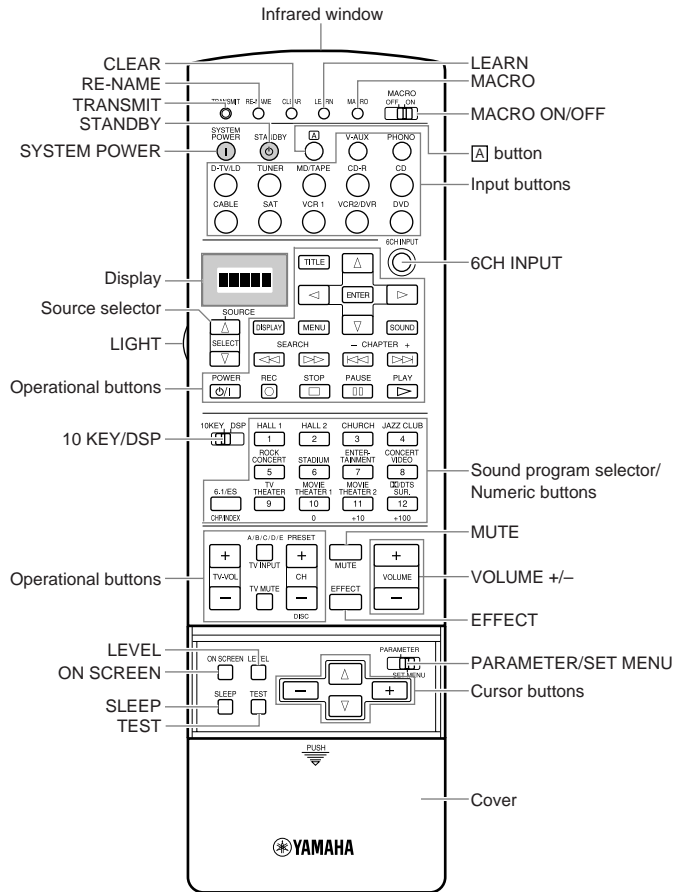

TUNER button (TUNER area)

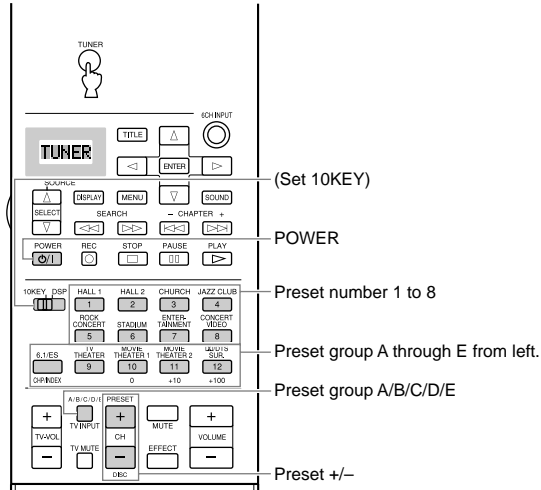

CD button (CD area)

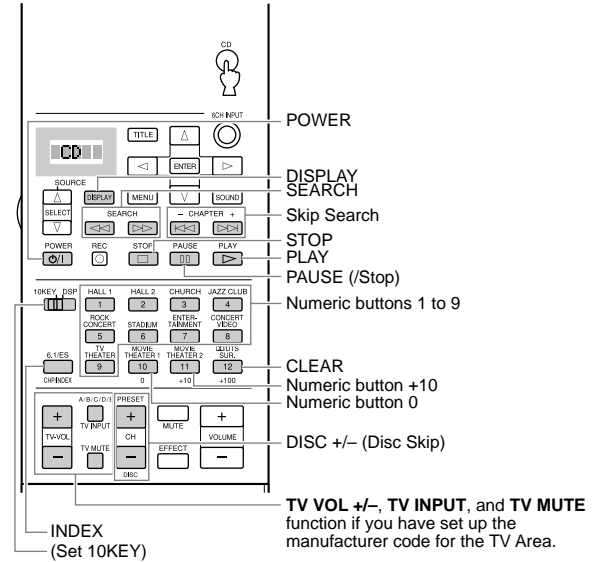

MD/TAPE button (MD area)

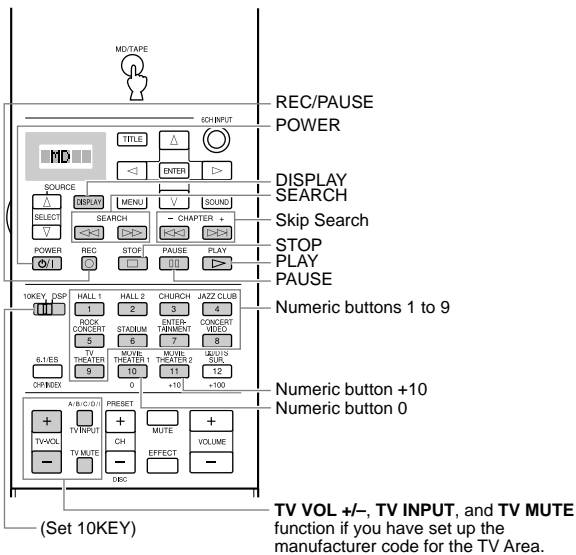

CD-R button (CD-R area)

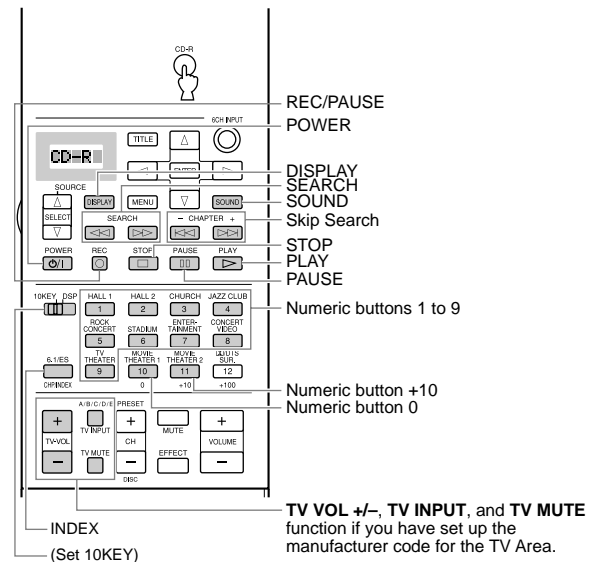

Quick Reference Card

PHONO and V-AUX buttons, and OPTN area

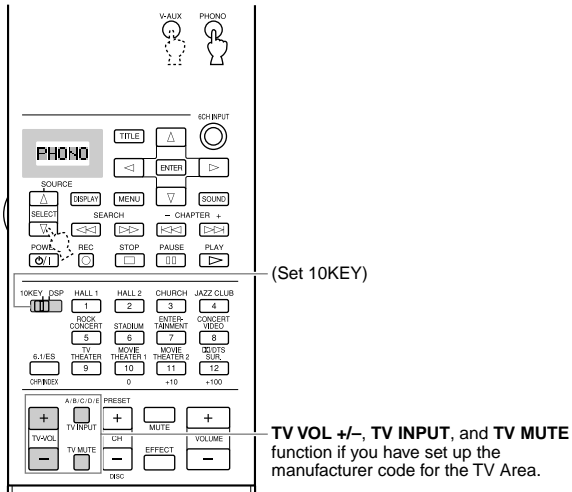

D-TV/LD button (TV area)

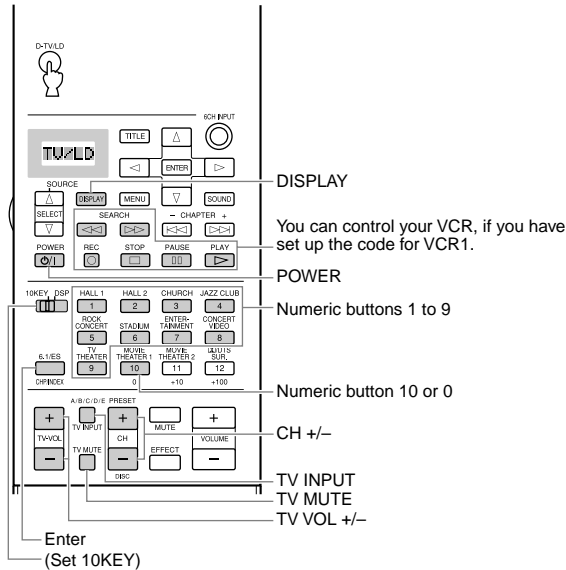

CABLE and SAT buttons (CABLE and SAT areas)

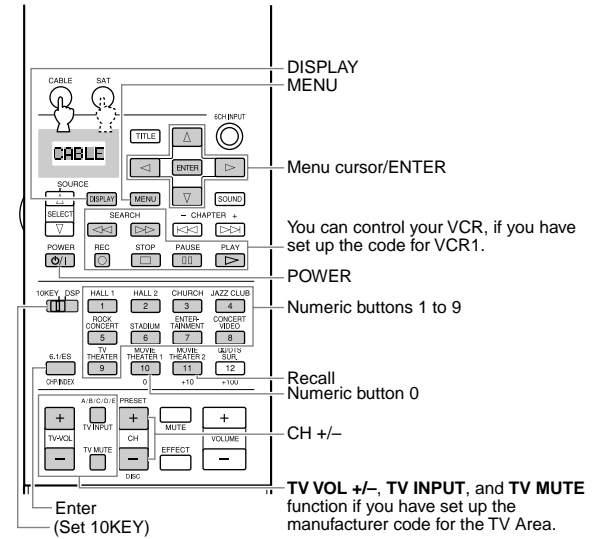

DVD button (DVD area)

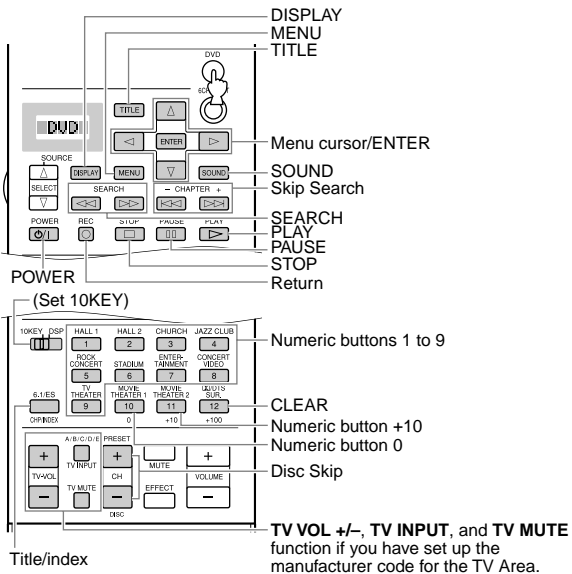

VCR1 and VCR2/DVR button (VCR areas)

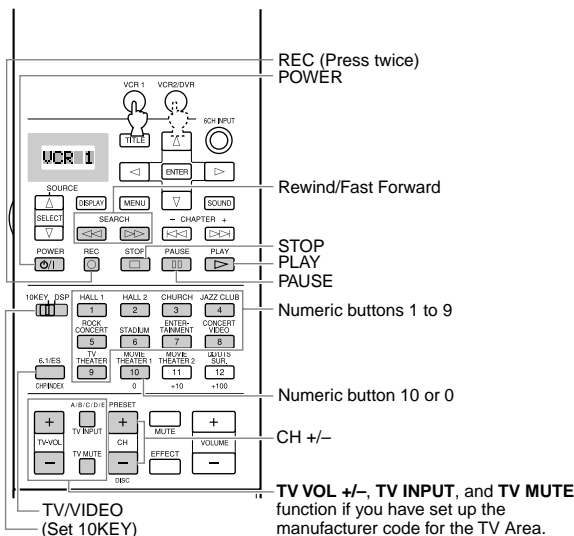

A button (ex. LD area)

