

YAMAHA

VIRTUAL ACOUSTIC TONE GENERATOR

VL1-m

Feature Reference

Owner's Manual 2

FCC INFORMATION (U.S.A.)

1. IMPORTANT NOTICE: DO NOT MODIFY THIS UNIT!

This product, when installed as indicated in the instructions contained in this manual, meets FCC requirements. Modifications not expressly approved by Yamaha may void your authority, granted by the FCC, to use the product.

2. IMPORTANT:

When connecting this product to accessories and/or another product use only high quality shielded cables. Cable/s supplied with this product MUST be used. Follow all installation instructions. Failure to follow instructions could void your FCC authorization to use this product in the USA.

3. NOTE:

This product has been tested and found to comply with the requirements listed in FCC Regulations, Part 15 for Class "B" digital devices. Compliance with these requirements provides a reasonable level of assurance that your use of this product in a residential environment will not result in harmful interference with other electronic devices. This equipment generates/uses radio frequencies and, if not installed and used according to the instructions found in the users manual, may cause interference harmful to the operation of other electronic devices. Compliance with FCC regulations does not guarantee that interference will not occur in all installations. If this product is found to be the source of interference, which can be determined by turning the unit "OFF" and "ON", please try to eliminate the problem by using one of the following measures:

Relocate either this product or the device that is being affected by the interference.

Utilize power outlets that are on different branch (circuit breaker or fuse) circuits or install AC line filter/s.

In the case of radio or TV interference, relocate/reorient the antenna. If the antenna lead-in is 300 ohm ribbon lead, change the lead-in to co-axial type cable.

If these corrective measures do not produce satisfactory results, please contact the local retailer authorized to distribute this type of product. If you can not locate the appropriate retailer, please contact Yamaha Corporation of America, Electronic Service Division, 6600 Orangethorpe Ave, Buena Park, CA 90620

The above statements apply ONLY to those products distributed by Yamaha Corporation of America or its subsidiaries.

* This applies only to products distributed by YAMAHA CORPORATION OF AMERICA.

Dette apparat overholder det gældende EF-direktiv vedrørende radiostøj.

Cet appareil est conforme aux prescriptions de la directive communautaire 87/308/CEE.

Diese Geräte entsprechen der EG-Richtlinie 82/499/EWG und/oder 87/308/EWG.

This product complies with the radio frequency interference requirements of the Council Directive 82/499/EEC and/or 87/308/EEC.

Questo apparecchio è conforme al D.M.13 aprile 1989 (Direttiva CEE/87/308) sulla soppressione dei radiodisturbi.

Este producto está de acuerdo con los requisitos sobre interferencias de radio frecuencia fijados por el Consejo Directivo 87/308/CEE.

YAMAHA CORPORATION

IMPORTANT NOTICE FOR THE UNITED KINGDOM

Connecting the Plug and Cord

IMPORTANT: The wires in this mains lead are coloured in accordance with the following code:

GREEN-AND-YELLOW	: EARTH
BLUE	: NEUTRAL
BROWN	: LIVE

As the colours of the wires in the mains lead of this apparatus may not correspond with the coloured markings identifying the terminals in your plug, proceed as follows:

The wire which is coloured GREEN and YELLOW must be connected to the terminal in the plug which is marked by the letter E or by the safety earth symbol or coloured GREEN and YELLOW.

The wire which is coloured BLUE must be connected to the terminal which is marked with the letter N or coloured BLACK.

The wire which is coloured BROWN must be connected to the terminal which is marked with the letter L or coloured RED.

* This applies only to products distributed by YAMAHA - KEMBLE MUSIC (U.K.) LTD.

Litiumbatterier!

Bör endast bytas av servicepersonal.
Explosionsfara vid felaktig hantering.

VAROITUS!

Lithiumparisto, Räjähdyksvaara.
Pariston saa vaihtaa ainoastaan alan ammattimies.

ADVARSEL!

Lithiumbatterier!
Eksplussionsfare. Udskiftning må kun foretages af en sagkyndig, – og som beskrevet i servicemanualen.

Bescheinigung des Importeurs

Hiermit wird bescheinigt, daß der/die/das

Virtual Acoustic Tone Generator Typ : VL1-m

(Gerät, Typ, Bezeichnung)

in Übereinstimmung mit den Bestimmungen der

VERFÜGUNG 1046/84

(Amtsblattverfügung)

funk-entstört ist.

Der Deutschen Bundespost wurde das Inverkehrbringen dieses Gerätes angezeigt und die Berechtigung zur Überprüfung der Serie auf Einhaltung der Bestimmungen eingeräumt.

Yamaha Europa GmbH

Name des Importeurs

* Dies bezieht sich nur auf die von der Yamaha Europa GmbH vertriebenen Produkte.

SPECIAL MESSAGE SECTION

PRODUCT SAFETY MARKINGS: Yamaha electronic products may have either labels similar to the graphics shown below or molded/stamped facsimiles of these graphics on the enclosure. The explanation of these graphics appears on this page. Please observe all cautions indicated on this page and those indicated in the safety instruction section.

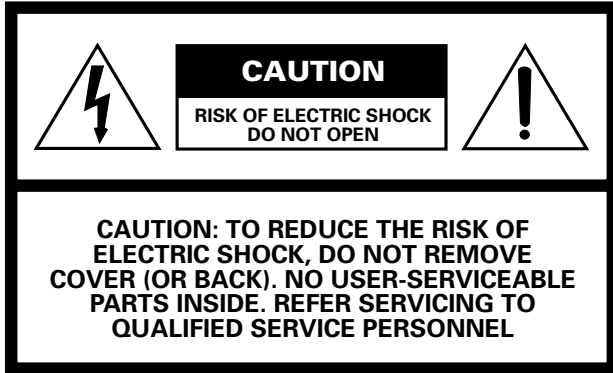

● Explanation of Graphical Symbols



The exclamation point within the equilateral triangle is intended to alert the user to the presence of important operating and maintenance (servicing) instructions in the literature accompanying the product.



The lightning flash with arrowhead symbol within the equilateral triangle is intended to alert the user to the presence of uninsulated “dangerous voltage” within the product’s enclosure that may be of sufficient magnitude to constitute a risk of electrical shock.

IMPORTANT NOTICE: All Yamaha electronic products are tested and approved by an independent safety testing laboratory in order that you may be sure that when it is properly installed and used in its normal and customary manner, all foreseeable risks have been eliminated. **DO NOT** modify this unit or commission others to do so unless specifically authorized by Yamaha. Product performance and/or safety standards may be diminished. Claims filed under the expressed warranty may be denied if the unit is/has been modified. Implied warranties may also be affected.

SPECIFICATIONS SUBJECT TO CHANGE: The information contained in this manual is believed to be correct at the time of printing. However, Yamaha reserves the right to change or modify any of the specifications without notice or obligation to update existing units.

ENVIRONMENTAL ISSUES: Yamaha strives to produce products that are both user safe and environmentally friendly. We sincerely believe that our products and the production

methods used to produce them, meet these goals. In keeping with both the letter and the spirit of the law, we want you to be aware of the following:

Battery Notice: This product **MAY** contain a small non-rechargeable battery which (if applicable) is soldered in place. The average life span of this type of battery is approximately five years. When replacement becomes necessary, contact a qualified service representative to perform the replacement.

Warning: Do not attempt to recharge, disassemble, or incinerate this type of battery. Keep all batteries away from children. Dispose of used batteries promptly and as regulated by applicable laws. Note: In some areas, the servicer is required by law to return the defective parts. However, you do have the option of having the servicer dispose of these parts for you.

Disposal Notice: Should this product become damaged beyond repair, or for some reason its useful life is considered to be at an end, please observe all local, state, and federal regulations that relate to the disposal of products that contain lead, batteries, plastics, etc.

NOTICE: Service charges incurred due to lack of knowledge relating to how a function or effect works (when the unit is operating as designed) are not covered by the manufacturer’s warranty, and are therefore the owners responsibility. Please study this manual carefully and consult your dealer before requesting service.

NAME PLATE LOCATION: The graphic below indicates the location of the name plate. The model number, serial number, power requirements, etc., are located on this plate. You should record the model number, serial number, and the date of purchase in the spaces provided below and retain this manual as a permanent record of your purchase.

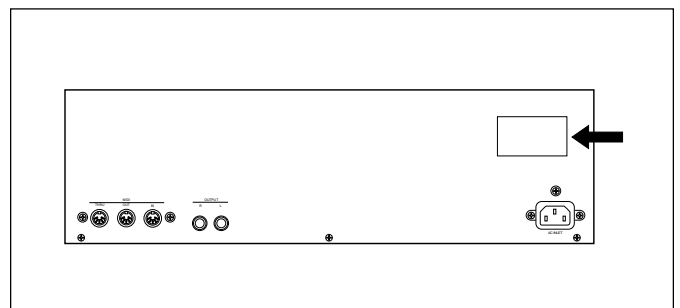

Model _____

Serial No. _____

Purchase Date _____

IMPORTANT SAFETY INSTRUCTIONS

INFORMATION RELATING TO PERSONAL INJURY, ELECTRICAL SHOCK, AND FIER HAZARD POSSIBILITIES HAS BEEN INCLUDED IN THIS LIST.

WARNING — When using any electrical or electronic product, basic precautions should always be followed. These precautions include, but are not limited to, the following:

1. Read all Safety Instructions, Installation Instructions, Special Message Section items, and any Assembly Instructions found in this manual BEFORE making any connections, including connection to the main supply.
2. Main Power Suplly Verifications: Yamaha products are manufactured specifically for the supply voltage in the area where they are to be sold. If you should move, or if any doubt exists about the supply voltage in your area, please contact your dealer for supply voltage verification and (if applicable) instructions. The required supply voltage is printed on the name plate. For name plate location, please refer to the graphic found in the Special Message Section of this manual.
3. This product may be equipped with a polarized plug (one blade wider than the other). If you are unable to insert the plug into the outlet, turn the plug over and try again. If the problem persists, contact electrician to have the obsolete outlet replaced. Do NOT defeat the safety purpose of the plug.
4. Some electronic products utilize external power supplies or adapters. DO NOT connect this type of product to any power supply or adapter other than one described in the owners manual, on the name plate, or specifically recommended by Yamaha.
5. **WARNING:** Do not place this product or any other objects on the power cord or place it in a position where anyone could walk on, trip over, or roll anything over power or connecting cords of any kind. The use of an extension cord is not recommended! If you must use an extension cord, the minimum wire size for a 25' cord (or less) is 18 AWG. NOTE: The smaller the AWG number, the larger the current handling capacity. For longer extension cords, consult a local electrician.
6. Ventilation: Electronic products, unless specifically designed for enclosed installations, should be placed in locations that do not interfere with proper ventilation. If instructions for enclosed installations are not provided, it must be assumed that unobstructed ventilation is required.
7. Temperature considerations: Electronic products should be installed in locations that do not significantly contribute to their operating temperature. Placement of this product close to heat sources such as; radiators, heat registers and other devices that produce heat should be avoided.
8. This product was NOT designed for use in wet/damp locations and should not be used near water or exposed to rain. Examples of wet/damp locations are; near a swimming pool, spa, tub, sink, or wet basement.
9. This product should be used only with the components supplied or; a cart, rack, or stand that is recommended by the manufacturer. If a cart, rack, or stand is used, please observe all safety markings and instructions that accompany the accessory product.
10. The power supply cord (plug) should be disconnected from the outlet when electronic products are to be left unused for extended periods of time. Cords should also be disconnected when there is a high probability of lightning and/or electrical storm activity.
11. Care should be taken that objects do not fall and liquids are not spilled into the enclosure through any openings that may exist.
12. Electrical/electronic products should be serviced by a qualified service person when:
 - a. The power supply cord has been damaged; or
 - b. Objects have fallen, been inserted, or liquids have been spilled into the enclosure through openings; or
 - c. The product has been exposed to rain; or
 - d. The product does not operate, exhibits a marked change in performance; or
 - e. The product has been dropped, or the enclosure of the product has been damaged.
13. Do not attempt to service this product beyond that described in the user-maintenance instructions. All other servicing should be referred to qualified service personnel.
14. This product, either alone or in combination with an amplifier and headphones or speaker/s, may be capable of producing sound levels that could cause permanent hearing loss. DO NOT operate for a long period of time at a high volume level or at a level that is uncomfortable. If you experience any hearing loss or ringing in the ears, you should consult an audiologist. IMPORTANT: The louder the sound, the shorter the time period before damage occurs.
15. Some Yamaha products may have benches and/or accessory mounting fixtures that are either supplied as a part of the product or as optional accessories. Some of these items are designed to be dealer assembled or installed. Please make sure that benches are stable and any optional fixtures (where applicable) are well secured BEFORE using. Benches supplied by Yamaha are designed for seating only. No other uses are recommended.

PLEASE KEEP THIS MANUAL

VLI-m

Virtual Acoustic Tone Generator



Feature Reference

Owner's Manual 2

Contents

About the Manuals	4
■ The Getting Started Manual	4
■ The Feature Reference Manual (this manual) .	5
■ Conventions	5

General Operation

■ The Three Main Modes	8
■ Finding Functions & Parameters	9
■ Other Navigation Aids	11
■ Selecting & Editing Parameters	12

Play Mode

■ The Main Play Mode Display	14
■ Voice Selection	15
■ Controller Views	17
■ Quick Editing In the Play Mode	19
■ The Monitor Mode	20

Edit Mode

■ Element Selection In the Edit Mode	22
■ The Edit Compare Function	23
■ The Copy Function	24
■ Storing Edited Data	27

Initial Edit Page

Common Miscellaneous

■ 1: Setting	35
■ 2: Controller	36
■ 3: Element Pitch	37
■ 4: Element Level & Pan	38
■ 5: Portamento	40
■ 6: Micro Tuning	42
■ 7: Quick Edit Assign	43

Common Effect

■ 1: Setting	45
■ 2: Modulation Effect	46
• Flanger	47
• Pitch Change	49
• Distortion	51

■ 3: Feedback Delay	53
• Mono Delay	53
• L,R Delay	55
• L,C,R Delay	57
■ 4:Reverberation	60
• Hall1, Hall2, Room1, Room2, Studio, Plate, Space, Reverse	61

Element Controller

■ 1: Pressure	65
■ 2: Embouchure	66
■ 3: Pitch	67
■ 4: Vibrato	69
■ 5: Tonguing	70
■ 6: Amplitude	71
■ 7: Scream	72
■ 8: Breath Noise	73
■ 9: Growl	74
■ 10: Throat Formant	75
■ 11: Dynamic Filter	77
■ 12; Harmonic Enhancer	78
■ 13: Damping	80
■ 14: Absorption	81
■ Controller Search & Replace	82

Element Miscellaneous

■ 1: Setting	85
■ 2: Breath Noise	86
• 2-1: Breath Noise Level Key Scaling .	88
• 2-2: Breath Noise HPF Key Scaling .	89
• 2-3: Breath Noise LPF Key Scaling .	90
■ 3: Throat Formant	91
• 3-1: Throat Formant Pitch Key Scaling .	93
• 3-2: Throat Formant Amount Key Scaling	94
• 3-3: Throat Formant Intensity Key Scaling	95
• 3-4: Throat Formant HPF Key Scaling .	96
• 3-5: Throat Formant LPF Key Scaling .	97
■ 4: Mixing	98
• 4-1: Mixing Driver Output Key Scaling	100
• 4-2: Mixing Pipe/String Output Key Scaling	101



- 4-3: Mixing Tap Output Key Scaling . 102
- 4-4: Mixing Tap Location Key Scaling 103
- 5: Amplitude 104
 - 5-1: Total Amplitude Level Key Scaling 104
- Element Modifier 106**
 - 1: Harmonic Enhancer 107
 - 1-1: Harmonic Enhancer HPF Key
Scaling 110
 - 1-2: Harmonic Enhancer Overdrive Key
Scaling 111
 - 1-3: Harmonic Enhancer Carrier Level
Key Scaling 112
 - 1-4: Harmonic Enhancer Modulator
Index Key Scaling 113
 - 1-5: Harmonic Enhancer Balance Key
Scaling 114
 - 2: Dynamic Filter 115
 - 2-1: Dynamic Filter Cutoff Key Scaling 117
 - 2-2: Dynamic Filter Resonance Key
Scaling 118
 - 3: Equalizer Auxiliary 119
 - 3-1: Equalizer Auxiliary HPF Key
Scaling 120
 - 3-2: Equalizer Auxiliary LPF Key
Scaling 121
 - 4: Equalizer Band 122
 - 5: Impulse Expander & Resonator Setting .. 123
 - 6: Impulse Expander 125
 - 7: Resonator 126
- Element Envelope 128**
 - 1: Pressure 129
 - 2: Embouchure & Pitch 130
 - 2-1: Embouchure & Pitch Hold Time
Key Scaling 132
 - 2-2: Embouchure & Pitch Initial Level
Key Scaling 133
 - 2-3: Embouchure & Pitch Decay Rate
Key Scaling 134

- 3: Vibrato 135
 - 3-1: Vibrato Delay Time Key Scaling . 137
 - 3-2: Vibrato Attack Rate Key Scaling . 138
 - 3-3: Vibrato Depth Key Scaling 139
 - 3-4: Vibrato Speed Key Scaling 140
- 4: Growl 141
 - 4-1: Growl Speed Key Scaling 142
- 5: Amplitude & Filter 143
 - 5-1: Amplitude & Filter Attack Rate
Key Scaling 146
 - 5-2: Amplitude & Filter Attack 1 Level
Key Scaling 147
 - 5-3: Amplitude & Filter Decay Rate
Key Scaling 148
 - 5-4: Amplitude & Filter Sustain Level
Key Scaling 149
 - 5-5: Amplitude & Filter Release Rate
Key Scaling 150

Utility Mode

- System 152**
- MIDI Bulk Dump 160**
- Disk 162**
- Edit Recall 172**
- Demo 174**

Appendix

- VL1 & VL1-m Compatibility 178**
- Troubleshooting 179**
- Error Messages 182**
- Specifications 184**
- Index 186**

About the Manuals



The VL1-m comes with two manuals — *Getting Started* and *Feature Reference*. If you're just starting out with the VL1-m we urge you to begin with the *Getting Started* manual since it describes basic concepts and procedures that are essential to proper operation of the VL1-m.

The Getting Started Manual

The *Getting Started* manual contains seven chapters that take you through essential information and procedures you will need to know to become familiar with your VL1-m:

1. VL1-m Basics [≥ Page 8]

Basic concepts you'll need to understand in order to get the most out of the VL1-m.

2. The Controls & Connectors [≥ Page 16]

Brief descriptions of the VL1-m controls and connectors, and their functions.

3. Setting Up [≥ Page 22]

System connections, powering up, playing the demo, calibrating the Breath Controller, and loading the pre-programmed voices.

4. Voice Selection [≥ Page 34]

Several ways to select and play the VL1-m's 128 voices.

5. The Controllers [≥ Page 38]

The VL1-m controllers and how they can be assigned and edited for optimum control.

6. Mixing & The Modifiers [≥ Page 48]

Customizing the sound to suit your own personal needs.

7. Effects [≥ Page 58]

An overview of the built-in digital effects that you can use to add depth and ambience to the VL1-m sound.

We recommend that you go through the chapters in sequence and actually try out the various operations described. Once you've gone through the entire *Getting Started* manual in this way, you should be familiar enough with the VL1-m to need only the VL1-m *Feature Reference* manual in future.



The Feature Reference Manual (this manual)

The *Feature Reference* manual is the “nuts and bolts” reference for the VL1-m, individually describing its many functions in detail. The *Feature Reference* manual is divided into five main sections, each describing the various functions within a particular VL1-m edit or utility mode.

- | |
|--|
| <ol style="list-style-type: none">1. General Operation [≥ Page 7]2. Play Mode [≥ Page 13]3. Edit Mode [≥ Page 21]4. Utility Mode [≥ Page 151]5. Appendix [≥ Page 177] |
|--|

Once you have become familiar with the way the VL1-m works by going through the *Getting Started* manual, you should only need to refer to the *Feature Reference* manual from time to time to get details on functions you’ve never used before, or refresh your memory about functions that you don’t use very often.

Each section of the *Feature Reference* manual has its own table of contents, so you should be able to locate any particular function quickly and easily. Functions and references can also be located by referring to the index at the back of the manual.

Conventions

The following conventions are used through the VL1-m manuals to avoid confusion and make the text easier to read.

Buttons & Controls

Button and control names used on the VL1-m panel appear in the text in capital letters within a border: “the `PLAY` button”, for example.

Parameter Names

Parameter names and other labels which appear on the VL1-m display are printed in the `courier` typeface for easier identification: for example, “adjust the “Balance” parameter as required”.

Parameter Ranges

An ellipsis is used to indicate a range of parameter values: e.g. “0 ... 127”. This minimizes the confusion sometimes caused by the use of a hyphen or dash for this purpose.





General Operation



The VL1-m makes operation as easy as possible by providing a consistent, logical control interface via which its many functions and parameters can be accessed and edited. Once you become familiar with the system, operation should be smooth, efficient, and easy.

- **The Three Main Modes** 8
- **Finding Functions & Parameters** 9
- **Other Navigation Aids** 11
- **Selecting & Editing Parameters** 12

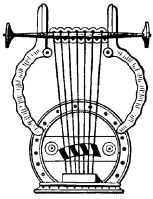

The Three Main Modes

The VL1-m has three main modes: **PLAY**, **EDIT**, and **UTILITY**. Each of these modes can be directly accessed by pressing the **PLAY**, **EDIT**, or **UTILITY** button, respectively.

PLAY

The **PLAY** mode is the one you use to select and play the VL1-m voices. The **PLAY** mode also includes several “Controller Views” that allow you to check controller assignments, the status of several important performance parameters, and the quick edit assignments.
 ≥ *Pages 13 through 20.*

EDIT

All voice editing functions are accessed via the **EDIT** mode: controller assignments, mixing, modifiers, effects, and more.
 ≥ *Pages 21 through 150.*

UTILITY

The **UTILITY** mode includes a range of functions that affect overall operation of the VL1-m rather than individual voices. For example: master tuning, MIDI settings, disk operations, etc.
 ≥ *Pages 151 through 175.*

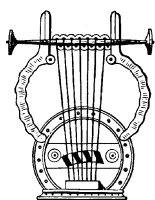

Finding Functions & Parameters

To facilitate access to the many functions provided, the EDIT and UTILITY mode functions are organized into logical groups arranged in a hierarchical structure (the PLAY mode is simple enough that it doesn't require this type of structure). The basic structure of the EDIT mode, for example, looks like this:

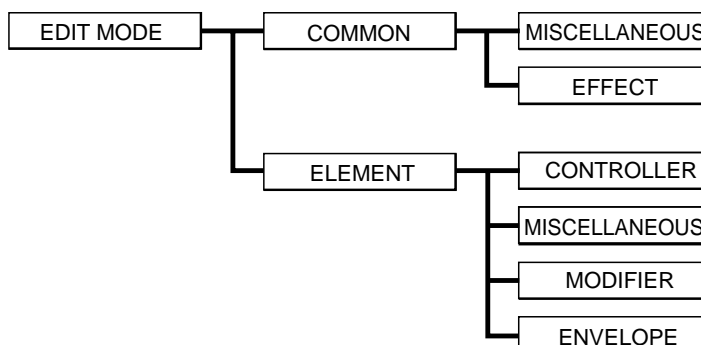

Here you can see that the EDIT mode functions are divided into two main groups: COMMON and ELEMENT, and that these are further sub-divided into related groups of functions. The COMMON EFFECT group, for example, includes all the effect parameters (flange, reverb, etc.) that apply to the entire voice. Here's how you would access the reverb parameters, starting from the PLAY mode:

● Example: Locate the Effect Reverb Parameters

1. Press **EDIT**

Pressing the **EDIT** button from the PLAY or UTILITY mode will normally take you to the initial EDIT display page (if the current voice has already been edited but not stored, you will automatically return to the last EDIT mode page that was selected).

```

EDIT
A07<007>
Voice Name = Tull Flute
Key Mode = Mono
Voice Mode = Dual
E1 Name = Tull Flute
E2 Name = Tull Stuff
Com  E1  E2                                     Name
  
```

2. Press **F1** ("Com")

Since you want the effect functions, which are in the common group, press the **F1** function button (immediately below "Com" on the display).

```

EDIT/COM
A07<007>:Tull Flute
<Miscellaneous>
1:Settings          5:Portamento
2:Controller       6:Micro Tuning
3:Element Pitch    7:Quick Edit Assi9n
4:Element Level&Pan
Misc Efect
  
```

3. If Necessary, Press **[F2]** (“Efct”)

If the miscellaneous directory is showing (in this case “Misc” above the **[F1]** button will be highlighted), press the **[F2]** button below “Efct” on the display to select the effect directory.

```

EDIT/COM
A07(007):Tull Flute
<Effect>
1:Settings
2:Modulation Effect
3:Feedback Delay
4:Reverberation
Misc [F1]
    
```

4. Move the Cursor To “4:Reverberation” and Press **[ENTER]**

Use the cursor buttons (or the **[INC]** and **[DEC]** buttons, or the data dial) to move the cursor to “4:Reverberation” and press the **[ENTER]** button. This will take you to the first page of reverb parameters.

```

EDIT/COM/EFFECT/REVERBERATION
A07(007):Tull Flute
Reverb Type      = Hall
Return           = 26%
Reverb Time      = 1.6sec
Reverb Time Boost = 0
High Control     = 0.7
    
```

NOTES ■ Notice that the top line of the display shows the “path” to the current level or function: “EDIT/COM/EFFECT/REVERBERATION”.

This example illustrates the two methods used to move *downward* through the EDIT mode levels: 1) press the appropriate function button and 2) move the cursor to the desired selection and press **[ENTER]**.

From any point within the structure you can move *upward* toward the topmost level (in this case the initial EDIT mode display) by pressing the **[EXIT]** button. You move up one level each time the **[EXIT]** button is pressed, until the topmost level is reached.

To exit from the EDIT mode itself you must press either the **[PLAY]** or **[UTILITY]** button, depending on the mode you want to switch to. You can exit from the EDIT mode at any level by doing this, and you will be returned automatically to the same display page the next time you press the **[EDIT]** button as long as the voice being edited is not stored or a new voices is not selected.



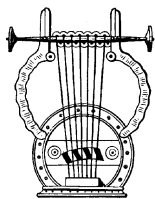

Other Navigation Aids

In addition to the standard procedures described in the previous section, the VL1-m sometimes provides additional help in moving between related functions via the function buttons.

In this example display page from the ELEMENT CONTROLLER group, “Bpag” (back page) and “Fpag” (forward page) appear above the [F6] and [F7] function buttons. In this case these buttons can be used to move forward and backward through the entire list of controller functions so you don’t have to move up to the function directory and then down to the next function every time you want to select a different element controller page.

```

EDIT/E1/CTRL/VIBRATO
BA07(007):Tull Flute/E1:Tull Flute
Controller = off
Depth      = 68
    
```

BPag FPag Para

Also note the “Para” (Parameter) abbreviation above the [F8] button. This enables you to go directly to the parameters related to the current page: in this case the vibrato parameters.

```

EDIT/E1/ENU/VIBRATO
BA07(007):Tull Flute/E1:Tull Flute
Delay Time = 340 Attack Rate = 1050
Sustain Lvl = 0 Vibrato Dpth = 1270
Dpth To Emb = 60 Dpth To Ptch = 16
Offset      = 0 Randomness  = 0
Speed      = 590 Speed Shift = 0
    
```

KSC Ctrl

From here you can go back to the vibrato controller page by pressing the [F8] function button again (note that it is now labelled “Ctrl”), or to the vibrato key scaling parameters by pressing [F7], below “KSC” on the display.

```

EDIT/E1/ENU/VIBRATO/KSC
BA07(007):Tull Flute/E1:Tull Flute
D1Time = 34
1: F 1 0
2: A#4 0
    
```

FPag

Another variation appears in the COMMON EFFECT parameter displays. In most cases the number of parameters available for each effect exceeds the capacity of the display, so the [F1] and [F2] function buttons are used to scroll up and down the parameter list — note the “▲” and “▼” arrows above the buttons in the display.

```

EDIT/COM/EFFECT/REVERBERATION
BA07(007):Tull Flute
Reverb Type = Hall
Return      = 26%
Reverb Time = 1.6sec
Reverb Time Boost = 0
High Control = 0.7
    
```

▲ ▼

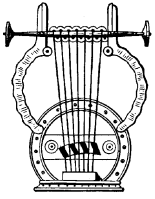

Selecting & Editing Parameters

Once you've locate the display page that contains the parameter(s) you want to edit, simply use the cursor buttons to move the cursor to the parameter, and then use the data dial or the **DEC** and **INC** buttons to set the parameter as required. The data dial is ideal for quickly covering a large range of settings, while the **DEC** and **INC** buttons are best for small stepwise changes.



Play Mode



The primary function of the PLAY mode is to allow you to select and play voices. The VL1-m play mode additionally offers a range of controller views that let you check controller assignments, and simple “quick edit” capability. Select the PLAY mode from either the EDIT or UTILITY mode by pressing the **PLAY** button.

- **The Main Play Mode Display** 14
- **Voice Selection** 15
- **Controller Views** 17
- **Quick Editing In the Play Mode** 19
- **The Monitor Mode** 20

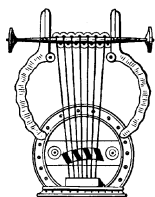

The Main Play Mode Display

When you select the PLAY mode by pressing the **PLAY** button, the main PLAY mode display will appear. This display includes a considerable amount of information in addition to the name of the currently selected voice.

■ The Normal Voice Display

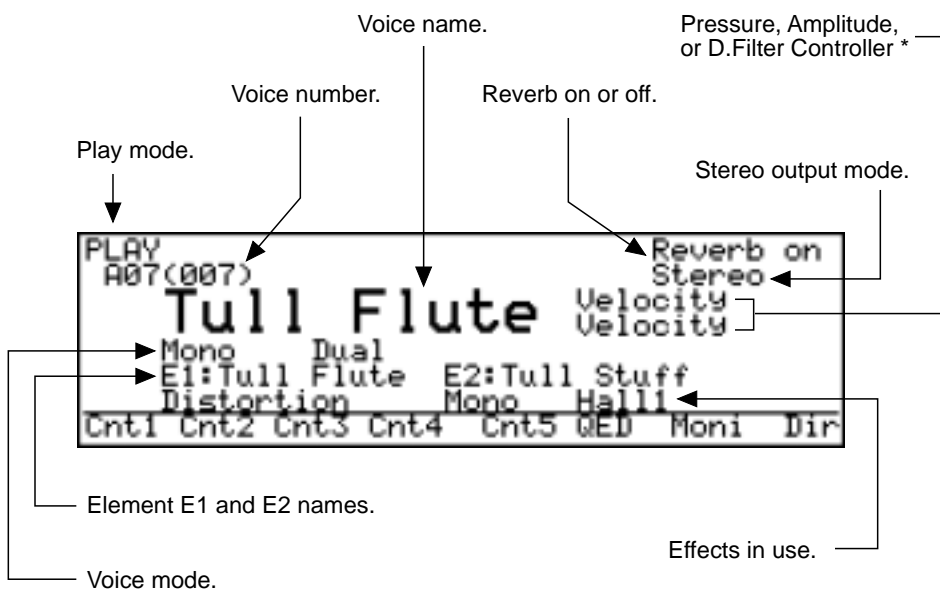

* If controllers are assigned to both Pressure and Amplitude, the controller with the highest amplitude depth value will be displayed. If neither is assigned, the Dynamic Filter controller will be displayed (if assigned).

The abbreviations in the section separated by a line at the bottom of the display (“Cnt1”, “Cnt2”, etc) indicate the functions of the corresponding function buttons below the display (described below).



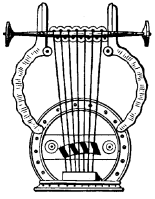

Voice Selection

The VL1-m's 128 voices are organized into 8 banks — “A” through “H” — of 16 voices each (8 x 16 = 128). These can be selected in sequence by using either the data dial or the **DEC** and **INC** buttons. Note that the voice number which appears on the play mode display includes both the voice bank/number (“A01” through “A16”, “B01” through “B16”, etc.) and the absolute voice number in parentheses following the bank/number (“001” through “128”).

● **DEC** and **INC** Buttons

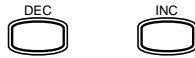

These are best for small, step-wise changes — e.g. selecting adjacent voice numbers, or numbers that are only a few steps away. Press the **DEC** or **INC** key briefly to decrement or increment the voice number by one, or hold either key for continuous decrementing or incrementing in the corresponding direction. The **DEC** and **INC** buttons also have a largestep function which allows you to skip ahead or backward in increments of 16: press either the **DEC** or **INC** button while holding the other button. The bank will switch automatically if you cross a bank voice-number boundary.

● **Data Dial**

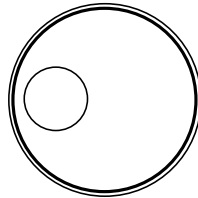

The data dial provides a fast, efficient way to cover a broad range of voice numbers when, for example, you're looking for a voice but don't know the voice number. Simply rotate the data dial clockwise for higher voice numbers or counter-clockwise for lower voice numbers while watching the display. The banks are automatically switched when necessary as the voice numbers are changed.



● Using the Voice Directory

The VL1-m also features a voice directory display that can be more convenient than the normal voice display in some situations. To switch to the voice directory display, press the **F8** button — located directly below “Dir” on the display. The directory display shows all 16 voices in the current bank. Voices can be selected using either the data dial or **DEC** and **INC** buttons as described above — the cursor will move to the selected voice. You can also use the cursor keys to move the cursor to the next voice to be selected (the voice is not actually selected in this case — the cursor will flash), then press the **ENTER** key to actually select the specified voice. This method lets you switch directly to the specified voice without having to go through all others in between.

To return to the normal voice display press the **EXIT** or **PLAY** button.

● The Sound Function

You can check the sound of the current voice in the PLAY mode directly from the VL1-m panel: press the **ENTER/SOUND** key. The pitch played is C4. When a voice is played in this way all 14 controller parameters (“Pressure” through “Absorption”) are turned off.



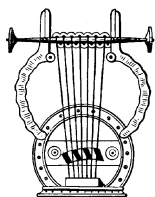

Controller Views

In the PLAY mode, function buttons **F1** (“Cnt1”) through **F6** (“QED”) are used to select “controller view” displays that list all controller assignments for the currently selected voice. You can press the **EXIT** or **PLAY** button from any controller view to return to the normal play-mode display.

● **F1** (“Cnt1”) through **F4** (“Cnt4”): Main Controllers

F1 through **F4** display the assignments for the controller parameters.

F1
 (“Cnt1”)

PLAY/CONTROLLER VIEW 1		
A07(A07):Tull Flute		
	Element1	Element2
Pressure	Touch EG	Touch EG
Embouchure	After Touc	After Touc
Pitch	Pitch Bend	Pitch Bend
Vibrato	off	off
Cnt1 Cnt2 Cnt3 Cnt4 Cnt5 QED Moni Dir		

Pressure	≥	Page 65.
Embouchure	≥	Page 66.
Pitch	≥	Page 67.
Vibrato	≥	Page 69.

F2
 (“Cnt2”)

PLAY/CONTROLLER VIEW 2		
A07(A07):Tull Flute		
	Element1	Element2
Tonguing	off	off
Amplitude	Velocity	Velocity
Scream	off	off
Breath Noise	off	off
Cnt1 Cnt2 Cnt3 Cnt4 Cnt5 QED Moni Dir		

Tonguing	≥	Page 70.
Amplitude	≥	Page 71.
Scream	≥	Page 72.
Breath Noise	≥	Page 73.

F3
 (“Cnt3”)

PLAY/CONTROLLER VIEW 3		
A07(A07):Tull Flute		
	Element1	Element2
Growl	Modulation	Modulation
Throat Formant	off	off
D.Filter	Touch EG	off
H.Enhancer	off	off
Cnt1 Cnt2 Cnt3 Cnt4 Cnt5 QED Moni Dir		

Growl	≥	Page 74.
Throat Formant	≥	Page 75.
Dynamic Filter	≥	Page 77.
Harmonic Enhancer	≥	Page 78.

[F4]
("Cnt4")

PLAY/CONTROLLER VIEW 4		
A07(A07):Tull Flute		
	Element1	Element2
Damping	off	off
Absorption	off	off
Cnt1	Cnt2	Cnt3
	Cnt4	Cnt5
	QED	Moni
		Dir

Damping	≥	Page 80.
Absorption	≥	Page 81.

The controller parameters are listed in the left column of the controller view display, and the controllers assigned to them are listed in the center and right columns, corresponding to elements 1 and 2, respectively.

● ∞ ("Cnt5"): Other Controller Settings

If you press the ∞ function button from the play mode you'll see the following controller view:

PLAY/CONTROLLER VIEW 5		
A07(A07):Tull Flute		
Polyphony	off	
Sustain	off	
Pitchbend	Normal	
Portamento	off	MIDI Ctrl off
Effect	off	off
Cnt1	Cnt2	Cnt3
	Cnt4	Cnt5
	QED	Moni
		Dir

Polyphony	≥	Page 36.
Sustain	≥	Page 35.
Pitch Bend	≥	Page 35.
Portamento	≥	Page 40.
Effect	≥	Page 45.

The controller parameters listed in this screen are not in the same category as those discussed in the preceding section, and therefore need to be introduced separately. All of the related parameters will be discussed in detail in the Feature Reference manual (pages listed below).

● **F6** (“QED”): Quick Edit

The **F6** function button calls the Quick Edit (“QED”) controller view, which will look something like this:

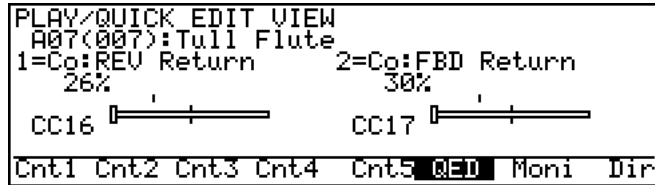

Two MIDI controllers (control change numbers 16 and 17) can be independently assigned to several parameters that you can control in real time while playing (also see “Quick Editing In the Play Mode”, below). The parameters available for editing via the controllers are individually preset for each voice. You can select from the available range by using the “Quick Edit Assign” assignment function (≥ Page 43).

The quick edit view shows you which parameters are assigned to which controller as well as the current positions of the controllers and their corresponding values. When the positions of the MIDI controllers used do not correspond to the internal parameters, the values of the internal parameters are displayed.

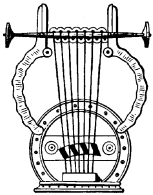

Quick Editing In the Play Mode

Although detailed voice editing is carried out in the EDIT mode, the MIDI controllers assigned to the quick edit parameters can be used to change the assigned parameters in real time while playing in the PLAY mode. This can be used simply as an expressive tool, or as a way to actually change the sound of the voice to suit your individual musical requirements. Since the controllers actually edit the parameters to which they are assigned, the “new” voice created by using the sliders can be stored to one of the VL1-m’s voice memory locations and used just as if it had been edited in the EDIT mode (≥ the STORE operation is described on page 27). The parameters available for editing via the MIDI controllers are individually preset for each voice. You can select from the available range by using the “Quick Edit Assign” assignment function (≥ Page 43).



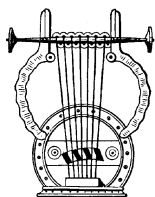

The Monitor Mode

In the PLAY mode the **[F7]** function button (“Moni”) selects a “Monitor” display which shows the most recently received MIDI values for a range of parameters, plus that from a breath controller connected to the BREATH jack. Press the **[EXIT]** or **[PLAY]** key to return to the normal play mode display.

```

PLAY/MONITOR
A07<007>:Tull Flute
013 = 64 Main Volume = 127
Modulation = 0 Pitch Bend = 0
Breath Con = 0 After Touch = 0
Foot Contr = 127 Note = A#4 / 45
Cnt1 Cnt2 Cnt3 Cnt4 Cnt5 QED Moni Dir
    
```

Control Change	The most recently received MIDI control change value for the specified control change number. This parameter can be set to any control change number from “001” (Modulation) to “119”, or “off”. To change the control change number move the cursor to the number and set as required via the data dial or [DEC] and [INC] buttons.
Modulation Wheel (001)	The most recently received modulation value (0 ... 127).
Breath Controller (002)	The most recently received breath controller value (0 ... 127). Data from both the front-panel BEATH jack and the MIDI IN connector are displayed (last-received priority).
Foot Controller (004)	The most recently received foot controller value (0 ... 127).
Main Volume (007)	The most recently received main volume value (0 ... 127).
Pitch Bend	The most recently received pitch bend value (-64 ... 63).
After Touch	The most recently received after touch value (0 ... 127).
Note	The most recently received note number and velocity value (note: C-2 ... G8. velocity: 1 ... 127).



Edit Mode



All voice editing functions are accessed via the EDIT mode: controller assignments, mixing, modifiers, effects, and more.

● Element Selection	
In the Edit Mode	22
● The Edit Compare Function	23
● The Copy Function	24
● Storing Edited Data	27
Initial Edit Page	30
Common Miscellaneous	34
Common Effect	44
Element Controller	64
Element Miscellaneous	84
Element Modifier	106
Element Envelope	128

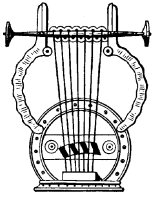

Element Selection In the Edit Mode

In the EDIT mode you'll need to be able to select the element to be edited, and independently turn the elements on and off to monitor the sound.

● Element Select

The ∞ function button and ◀ and ▼ cursor buttons are used to select the element to be edited in a 2-element voice when an ELEMENT parameter is selected. Press ◀ while holding ∞ to select element 1, or press ▼ while holding ∞ to select element 2. The currently selected element is shown in the function name at the top of the display page: “E1” for element 1 and “E2” for element 2.

In the example display below, element 2 is selected for editing (“EDIT/E2/CTRL/PRESSURE”):

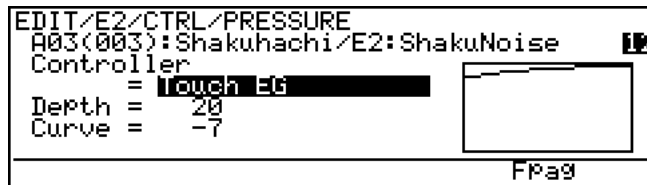

The element cannot be selected when a COMMON parameter is selected. Of course, “E2” can only be selected in a voice that uses two elements. Single-element voices use only “E1”.

● Element On/Off

While editing a 2-element voice it is handy to be able to turn one or the other element off so you can clearly hear the result of edits to the element you are working on. The ∞ function button and ▶ and ▲ cursor buttons perform this function. Hold ∞ and press the ▲ button to toggle element 1 on and off, or hold ∞ and press the ▶ button to toggle element 2 on and off. The on/off status of the elements is indicated by the element numbers (“12”) at the right end of the second display line: a highlighted number indicates that the element is on, a plain number that the element is off. In the following display, for example, element 2 is on while element 1 is off:

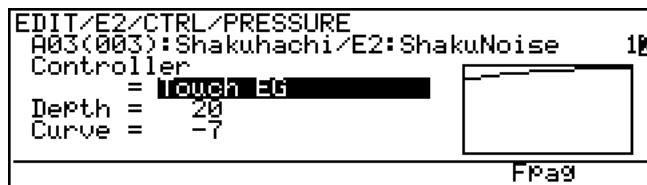

The element ON/OFF settings are only effective in the edit mode.

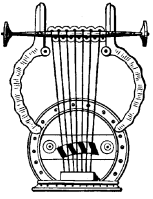

The Edit Compare Function

When editing a voice in the EDIT mode, a copy of the original voice is retained in the VL1-m “edit buffer”, allowing the edited voice to be compared with the edited version by using the “Edit Compare” function.

The Edit Compare function is engaged by pressing the **EDIT** button while in the EDIT mode (after making at least one change to the voice data). When the Edit Compare mode is engaged the **EDIT** indicator will flash, the inverse “E” () before the voice number will disappear, and the sound of the original (pre-edit) voice can be monitored. Press the **EDIT** button again to return to the EDIT mode and the edited version of the voice. You can toggle back and forth between the edited and original voices while editing to monitor the effect of changes you make to the voices parameters.

NOTES ■ *Editing can not be carried out while the Edit Compare function is engaged.*



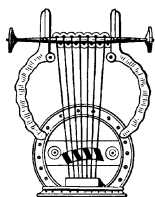

The Copy Function

The copy function makes it possible to copy common or element data from any specified voice to the current voice. You can copy all common or element data, or only the data from a specified group of functions or a single function. It is also possible to copy the original (pre-edit) data from the voice being edited to restore the specified data to its original values.

● Procedure

1. Specify the Data You Want To Copy

In the EDIT mode select the display page and function corresponding to the data you want to copy:

- To copy all common data, go to the initial EDIT mode display and move the cursor to the “Voice Name”, “Key Mode”, or “Voice Mode” parameter.

■ Example: Copy all common data.

```

EDIT
A07(007)
Voice Name = Tull Flute
Key Mode = Mono
Voice Mode = Dual
E1 Name = Tull Flute
E2 Name = Tull Stuff
Com E1 E2 Name
    
```

- To copy all common miscellaneous data select the miscellaneous directory, or to copy all common effect data select the Effect directory.

■ Example: Copy all common miscellaneous data.

```

EDIT/COM
A07(007):Tull Flute
<Miscellaneous>
1:Settings 5:Portamento
2:Controller 6:Micro Tuning
3:Element Pitch 7:Quick Edit Assign
4:Element Level&Pan
Misc Effect
    
```

- To copy the data from a single common miscellaneous or common effect function select the display page for that function.

■ Example: Copy the common miscellaneous element pitch data.

```

EDIT/COM/MISC/ELEMENT PITCH
A07(007):Tull Flute
Element1 Detune = 0 Note Shift = 0
Random Pitch = 0
Element2 Detune = 0 Note Shift = -12
Random Pitch = 0
    
```



- To copy all element data, go to the initial EDIT mode display and move the cursor to the “E1 Name” or “E2 Name” parameter.

■ Example: Copy all element data.

```

EDIT
A07(007)
Voice Name = Tull Flute
Key Mode = Mono
Voice Mode = Dual
E1 Name = Tull Flute
E2 Name = Tull Stuff
Com E1 E2 Swap Name
    
```

- To copy the E1 or E2 controller, miscellaneous, modifier, or envelope data, select the corresponding directory display page.

■ Example: Copy all E1 element modifier data.

```

EDIT/E1
A07(007):Tull Flute/E1:Tull Flute
<Modifier>
1:Harmonic Enhancer 5:IE & RSN Setting
2:Dynamic Filter 6:Impulse Expander
3:Equalizer Auxiliary 7:Resonator
4:Equalizer Band
Ctrl Misc Mod Env
    
```

- To copy the data from a single element function select the display page for that function.

■ Example: Copy the E2 harmonic enhancer data.

```

EDIT/E2/MODIFIER/HARMONIC ENHANCER
A07(007):Tull Flute/E2:Tull Stuff
Signal Select = 0:1234567890
HPF Cutoff = 30.8 Hz
Over Drive = 1.6810
Level = 1270
Balance = -460 Dry Wet
Ctrl Mod
    
```

2. Press COPY

Press the COPY button to call the COPY display.

```

EDIT E2 H.ENHANCER COPY
A07 * E2:Tull Stuff
Sig A08(008):BagPipes /E1:Chanter
HPF E2:BagPipesDro
Ove A09(009):GuitarHero /E1:GuitarHero
Lev E2:GuitarHero
Bal A10(010):Mizu Horne /E1:I'm Horny
Ctrl E1 123 ABC...
    
```

3. Select the Voice You Want To Copy From

Use the cursor buttons, data dial, or DEC and INC buttons to select the voice you want to copy the data from (and the element when copying element data).

- At this point you can play the voice to hear how it will sound after the specified data is copied before actually copying the data.

- The voice/element preceded by an asterisk (*) in the copy window is the current voice/element. If you select this voice/element as the copy source the pre-edit data will be copied, thus restoring the specified data to its original values.
- Press **F6** under “123...” to display the voices in numerical order, or **F7** under “ABC...” to display the voices in alphabetical order. Sometimes it may take a few seconds to sort the data as specified — the “Now Sorting!” message will appear during the sort operation.
- When copying element data in a 2-element voice “E1” or “E2” will appear above **F3** — this will be the name of the element not currently being edited. In this case the **F3** function button can be pressed to copy the data from the second element to the element being edited.

4. Press **ENTER and Confirm To Copy**

Press the **ENTER** button once you’ve selected the copy source (at this point you can also press the **EXIT** button to cancel the copy function).



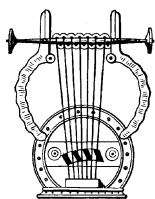

Storing Edited Data

Once you've created a new voice in the edit mode, it's necessary to store the voice to one of the VL1-m's internal memory locations otherwise the edited data will be lost when a new voice is selected.

NOTES ■ Any previous data in the memory location to which the new voice is stored will be erased. If you want to keep the previous data, save it to floppy disk (≥ Page 166).

■ Edited voice data can only be saved to floppy disk after it has been stored to an internal memory location.

■ The STORE function can be accessed from the EDIT or PLAY mode.

■ If you have accidentally lost an edited voice by selecting a different voice after returning to the PLAY mode, the RECALL function can be used to restore the edited data as long as no other data has been edited in the meantime (≥ Page 172).

● Procedure

1. Make Sure Memory Protection Is Off

Make sure that the UTILITY mode Memory Protect function is turned off: press **UTILITY** to select the UTILITY mode; make sure the "Sys" page is selected; select "5:Miscellaneous" and press **ENTER**; move the cursor to "Memory Protect" and press **DEC** to turn it "off".

2. Press **STORE** In the EDIT or PLAY Mode

If you had to go to the UTILITY mode to turn memory protection off, return to either the EDIT or PLAY mode and press **STORE**. At this point you will get a "Memory Protected" error message if memory protection is turned on — go back and turn Memory Protect "off".

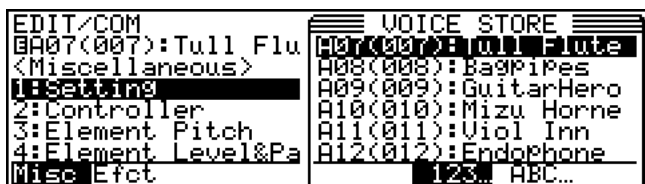

3. Select the Destination Memory Location

Use the cursor buttons, data dial, or **DEC** and **INC** buttons to select the memory location you want to store the edited voice to.

NOTES ■ Press **F6** under "123..." to display the voices in numerical order, or **F7** under "ABC..." to display the voices in alphabetical order. Sometimes it may take a few seconds to sort the data as specified — the "Now Sorting!" message will appear during the sort operation.

4. Press **ENTER** and Confirm To Store

Press the **ENTER** button once you've selected the store destination (at this point you can also press the **EXIT** button to cancel the store function). If you press **ENTER** the confirmation display will appear.

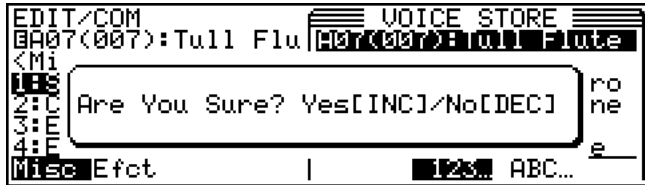

Press the **INC** button to actually store the data (or **DEC** to cancel). "Completed" will appear on the display when the data has been successfully stored.

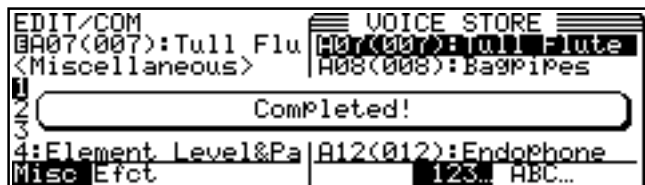

5. Press **EXIT**

Press the **EXIT** button to clear the STORE display and return to the previous mode.





Initial Edit Page

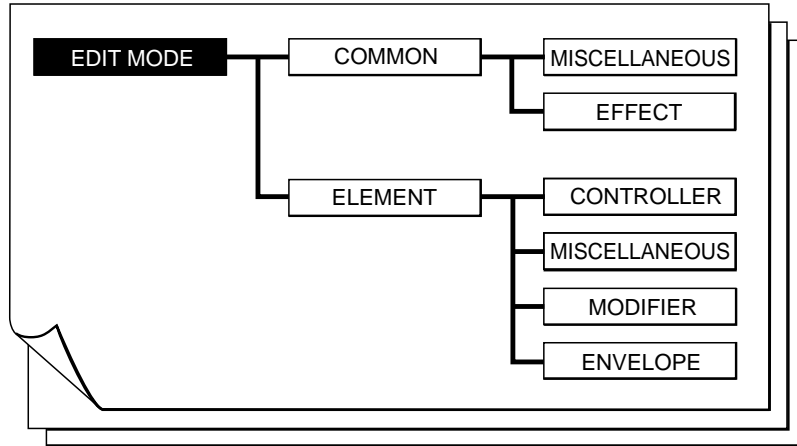

Select the EDIT mode from either the PLAY or UTILITY mode by pressing the **EDIT** button. The initial EDIT display will appear.

```

EDIT
A07(007)
Voice Name = 00000000
Key Mode = Mono
Voice Mode = Dual
E1 Name = Tull Flute
E2 Name = Tull Stuff
Com E1 E2 Name
  
```

NOTES ■ If you are re-entering the EDIT mode while editing a voice (i.e. you have edited but not yet stored the current voice), the last selected EDIT display page will appear.

● Voice Name

≤ *A name of up to 10 characters.*

To enter a new voice name position the cursor at the “Voice Name” parameter and press **ENTER** or **F8** (“Name” — “Name” only appears above the **F8** button when the cursor is positioned at the “Voice Name” parameter). The VOICE NAME display will appear.

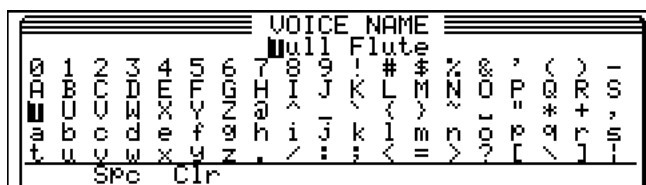

- Use the cursor **◀** and **▶** buttons to move the cursor to the character in the voice name at the top of the display that you want to change.
- Use the **DEC** and **INC** buttons or data dial to select a new character by moving through the character list row by row.
- Press the **F2** button (“SpC”) to enter a space at the current cursor position.
- Press the **F3** button (“Clr”) to clear the entire voice name.
- Press **EXIT** or **ENTER** when the voice name is complete.

● E1 Name, E2 Name

≤ *A name of up to 10 characters.*

These parameters allow independent names to be entered for the E1 and E2 elements of the current voice (only E1 is available in a single-element voice). To enter a new element name position the cursor at the “E1 Name” or “E2 Name” parameter and press **ENTER** or **F8** (“Name”). The ELEMENT NAME display will appear. Procedure is the same as for the Voice Name parameter, above, except for the function of the **F4** button, below.

- Press the **F4** button (“Auto”) to copy the voice name to the element name (suffixes “_A” and “_B” will be appended to the E1 and E2 names respectively).

● Key Mode

≤ *Mono, Poly, Unison.*

In conjunction with the Voice Mode parameter, below, the Key Mode parameter determines how the VL1-m’s two elements are used to produce sound.

Mono	Only a single note can be played at a time.
Poly	Two different notes may be played simultaneously.
Unison	Playing a single key produces two notes in unison.





● Voice Mode

≤ *Single, Dual.*

In conjunction with the Key Mode parameter, above, the Voice Mode parameter determines how the VL1-m's two elements are used to produce sound.

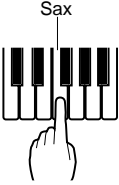
Single	Only the sound of one element will be produced at a time.
Dual	The sound of two elements may be produced simultaneously.

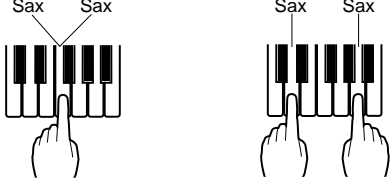
● Various Key Mode and Voice Mode setting combinations produce the following results:

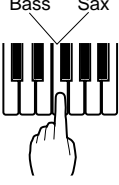
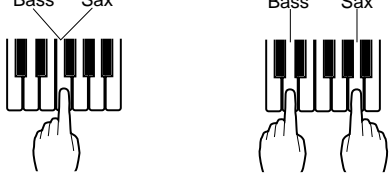
Key: Mono Voice: Single	
Key: Poly Voice: Single	
Key: Unison Voice: Single	
Key: Mono Voice: Dual	
Key: Poly Voice: Dual	
Key: Unison Voice: Dual	



- When the cursor is positioned at the “E1 Name” or “E2 Name” parameter in the initial EDIT mode display, “Swap” appears above the **F7** button. Pressing this button exchanges the E1 and E2 data, including the element names. This function can be used to swap the elements used for the high and low notes when Key Mode is set to “Unison” and Voice Mode is set to “Dual”. Since E2 always contains data, the Swap function can be used to temporarily switch elements even when Key Mode is set to “Single”.



Common Miscellaneous

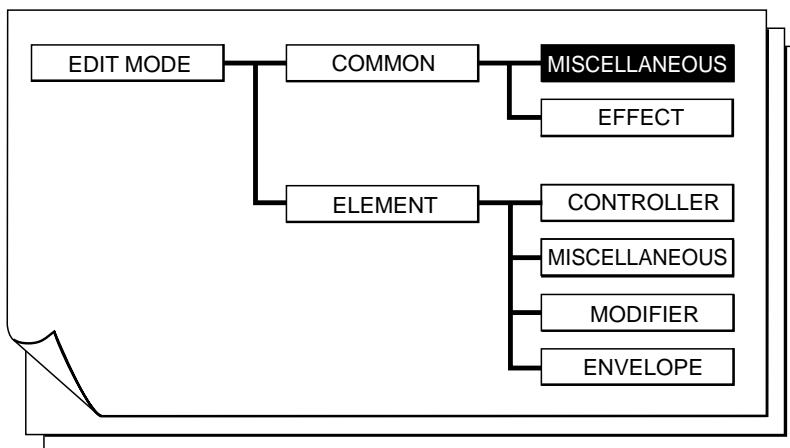

The COMMON MISCELLANEOUS group includes a miscellaneous range of functions which affect the entire voice.

■ 1: Setting	35
■ 2: Controller	36
■ 3: Element Pitch	37
■ 4: Element Level & Pan	38
■ 5: Portamento	40
■ 6: Micro Tuning	42
■ 7: Quick Edit Assign	43

```

EDIT/COM
A07(007):Tull Flute
<Miscellaneous>
1:Setting          5:Portamento
2:Controller      6:Micro Tuning
3:Element Pitch   7:Quick Edit Assign
4:Element Level&Pan
Misc Efect
  
```



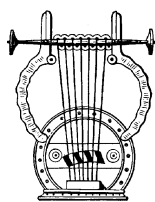

1: Setting

```

EDIT/COM/MISC/SETTING
A07(007):Tull Flute

Assign Mode      = Last Note
Pitchbend Mode   = Normal
Sustain          = off
    
```

● Assign Mode

≤ *Bottom Note, Top Note, Last Note.*

Determines which note(s) will be played when more than one note is played at a time. Operation is different in the mono, poly, and unison key modes (≥ Page 31), as noted below. This parameter also affects how the VL1-m responds to external MIDI control.

Bottom Note	The lowest note(s) played sounds.
Top Note	The highest note(s) played sounds.
Last Note	The last note(s) played sounds.

- The above settings apply when the “Mono” key mode is selected.
- When the “Poly” key mode is selected, “Top Note*” will appear in place of the “Last Note” setting and operation will be the same as when “Top Note” is selected.
- When the “Unison” key mode is selected, the lowest and highest notes played will sound regardless of the Assign Mode setting.

● Pitchbend Mode

≤ *Normal, Bottom, Top.*

Sets the pitch bend mode. The “Bottom” and “Top” modes are only effective when the poly or unison key mode (≥ Page 31) is selected.

Normal	Both notes are effected by pitch bend data.
Bottom	The lowest of two notes played will be affected by pitch bend data.
Top	The highest of two notes played will be affected by pitch bend data.

● Sustain

≤ *off, on.*

Turns the VL1-m sustain function on or off. When “off” the sustain function will not work even if a “sustain on” MIDI message is received.

Off	Sustain can not be applied via MIDI.
On	Sustain can be applied via MIDI.

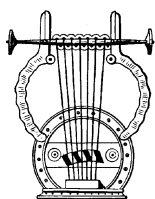

2: Controller

```

EDIT/COM/MISC/CONTROLLER
A07(007):Tull Flute
Breath Attack Time = 5.00msec
Gain = 127
Touch EG Time = 161 msec
Polyphony Ctrl = off
    
```

● Breath Attack Time

≤ 5.00msec ... 1.24 sec.

Determines how quickly the VL1-m responds to changes in breath pressure applied to the breath controller. A setting of “5.00msec” produces the fastest response; “1.24 sec” produces the slowest response. This parameter should be used with the “Breath Attack Gain” parameter, below, to determine overall breath controller response.

● Breath Attack Gain

≤ 0 ... 127.

Determines the amount of audible change produced by a changes in breath pressure applied to the breath controller. A setting of “0” results in no change; “127” produces maximum change. “127” is the normal setting for this parameter.

● Touch EG Time

≤ 5.00msec ... 1.24 sec.

Sets the response time of the VL1-m Touch Envelope Generator. The Touch Envelope Generator controls the transition from the initial key velocity to aftertouch pressure when a key is played. A setting of “5.00msec” produces the fastest response; “1.24 sec” produces the slowest response.

● Polyphony Ctrl

≤ off, Modulation Wheel ... 119.

The VL1-m allows any physical MIDI controller to be used to switch between the mono and poly key modes while playing. This parameter assigns the desired controller to the key-mode switching function.

off	The key-mode switching function is off. This setting automatically selected when Key Mode set to Mono or Unison.
Modulation Wheel ... 119.	The selected controller will switch between the Mono and Poly key modes.

- The key-mode switching function can only be activated (i.e. a controller assigned) when the Key Mode parameter is set to “Poly”.



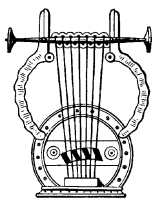

3: Element Pitch

```

EDIT/COM/MISC/ELEMENT PITCH
A07(007):Full Flute
Element1 Detune = 0 Note Shift = 0
Random Pitch = 0

Element2 Detune = 0 Note Shift = -12
Random Pitch = 0

```

● Element 1 Detune

● Element 2 Detune

≤ -7 ... 7.

Produces a slight upward or downward shift in the pitch of Element 1 or Element 2, and therefore a detuning effect in relation to the other element. Minus values lower the pitch while positive values raise the pitch. The change in pitch produced by each increment is very slight (on the order of a few cents per increment). Both elements can be independently detuned in relation to each other, and in relation to the VL1-m's true pitch as determined by the UTILITY mode "Master Tuning" parameter (≥ Page 153). If a 1-element voice is being edited the "Element 2 Detune" parameter will not appear — unless the Voice Mode is set to "Single" and the Key Mode is set to "Unison". In the latter case the "Element 2 Detune" parameter appears because the same voice is being played in the unison mode.

● Element 1 Note Shift

● Element 2 Note Shift

≤ -64 ... 63.

Shifts the pitch of Element 1 or Element 2 up or down in semitone increments. Minus values lower the pitch while positive values raise the pitch. The pitches of both elements can be independently shifted in relation to each other, and in relation to the VL1-m's true pitch as determined by the UTILITY mode "Master Tuning" parameter (≥ Page 153).

● Element 1 Random Pitch

● Element 2 Random Pitch

≤ 0 ... 7.

Produces a slight random variation in the pitch of Element 1 or Element 2, simulating the effect of acoustic instruments in which perfectly stable effect is rarely achieved. A setting of "0" produces no random pitch variation; "7" produces maximum random pitch variation.

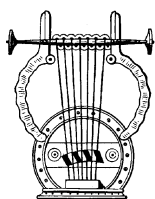

4: Element Level & Pan

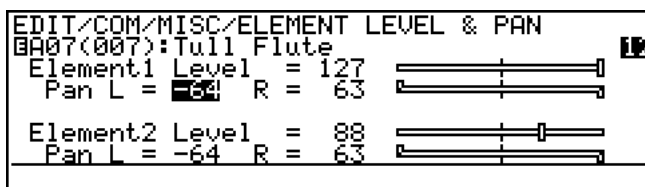

● Element 1 Level

● Element 2 Level

≤ 0 ... 127.

Sets the level (volume) of the output from Element 1 or Element 2. A setting of “0” produces no output; “127” produces maximum output. Independent level parameters are provided for Element 1 and Element 2, making it easy to create the desired “balance”. The graphic bar to the right of the numeric parameter provides a visual indication of the level setting: higher settings move the graphic “slider” to the right.

● Element 1 Pan L

● Element 1 Pan R

● Element 2 Pan L

● Element 2 Pan R

≤ -64 ... 63.

Determines the position of Element 1 or Element 2 in the stereo sound field. Normally there would be only one pan parameter for each element, placing the sound of the element anywhere from full left to right in the stereo sound field. The output from the VL1-m elements and modifier stages is already in stereo, so two pan parameters (L and R) and provided for each element, offering maximum panning versatility. The “Element 1 Pan L” parameter, for example, determines the position of the left-channel output signal from Element 1, while the “Element 1 Pan R” parameter determines the position of the right-channel output from the same element. The graphic bar to the right of the numeric parameters provides a visual indication of the pan settings: the “L” slider extends above the bar and the “R” slider extends below the bar. Higher settings move the corresponding slider to the right.

- To reproduce the original stereo sound of the element, set the “Pan L” parameter to “-64” and the “Pan R” parameter to “63”.

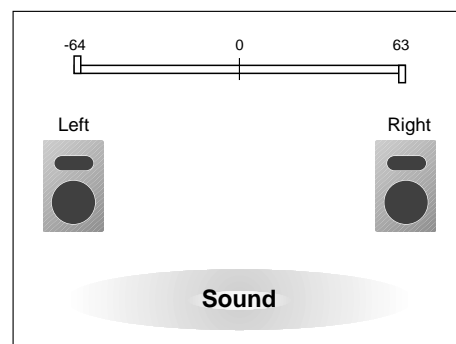

- To limit the sound of Element 1 to the left half of the sound field, for example, set “Element 1 Pan L” to “-64” and “Element 1 Pan R” to “0”.

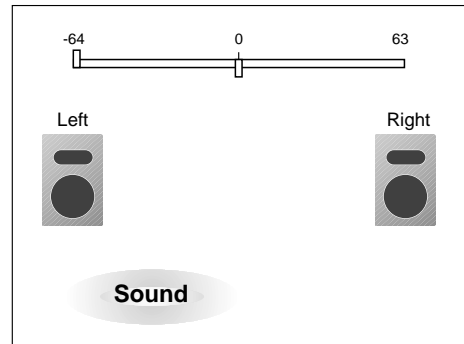

- If both the “L” and “R” parameters are set to the same value, the sound of the corresponding element will appear as a mono source at the appropriate position in the stereo sound field. If both parameters are set to “0”, for example, the sound of the element will be heard only in the center of the sound field.

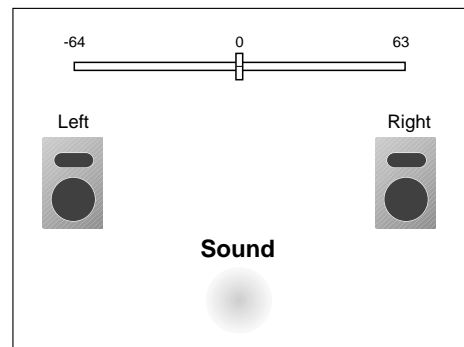

- The Element 2 pan and level parameters will not appear if the Voice Mode parameter is set to “Single”.
- The pan parameters have no effect if the UTILITY mode “Output” parameter is set to “Monaural”.

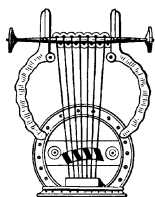

5: Portamento

```

EDIT/COM/MISC/PORTAMENTO
0A07(007):Tull Flute
Portamento Mode = Full Time
Time MIDI Control = off
Time = 0
Element1 = off
Element2 = off
    
```

● Portamento Mode

≤ *Full Time, Fingered.*

Portamento produces a “slide” effect between subsequently played notes. The “Portamento Mode” parameter determines how the portamento slide is produced.

Full Time	The portamento slide will occur between any two subsequent notes when the portamento switch is on, even if the first note is released before the second is played.
Fingered	The portamento slide will only occur if the first note is still held when the second note is played.

- If the “Key Mode” parameter (≥ Page 31) is set to “Poly” or “Unison” the “Portamento Mode” parameter is fixed at “Full Time” and cannot be changed.

● Time MIDI Control

≤ *off, on.*

The portamento time (the length of slide between notes) can be controlled in realtime via MIDI portamento time messages from an external device. This parameter turns realtime portamento time control off or on.

● Time

≤ *0 ... 127.*

This parameter becomes active only when the “Time MIDI Control” parameter, above, is turned “off”. The “Time” parameter sets the portamento time. A setting of “0” produces the fastest portamento time; “127” produces the longest portamento slide effect.

● Element 1

≤ *off, on.*

Turns portamento off or on for element 1 only.



● Element 2

≤ off, on.

Turns portamento off or on for element 2 only.

- The “Element 2” parameter will not appear if the “Voice Mode” parameter (≥ Page 32) is set to “Single”.



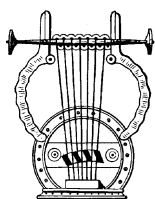

6: Micro Tuning

```

EDIT/COM/MISC/MICROTUNING
0A07(007):Tull Flute
Element1 = off
Element2 = off
    
```

● Element 1

● Element 2

≤ off, I-1 ... I-2, P-1 ... P-54.

Selects the micro-tuning for Element 1 or Element 2.

off	Equal Temperament: The standard modern keyboard tuning with perfectly even intervals between all 12 notes of the scale. This tuning allows transposition to any key without modification.
I-1, I-2	Internal Microtuning: These tunings are included in the system data on the VL1-m voice disk.
P-1 ... P-12	Pure Major C ... Pure Major B: A brass-instrument tuning based on their natural harmonic series. Produces a beautiful beat-free sound in ensemble, but the tuning must be changed to match the key of the music.
P-13 ... P-24	Pure Minor C ... Pure Minor B: Same as the Pure Major scales above, but for minor keys.
P-25 ... P-36	Mean Tone C ... Mean Tone B: This tuning was originally devised to eliminate the conflict caused by the third degree of the Pythagorean tuning (below). The tuning must be matched to the key of the music.
P-37 ... P-48	Pythagorean: A classic tuning from ancient Greece — with a few rough spots that were fixed in later improvements. The tuning must be matched to the key of the music.
P-49	Werckmeister: This and the following two tunings were created to allow transposition to any key without the need for re-tuning. They have the curious characteristic, however, that the “tension” of the sound increases in proportion to the number of sharps or flats in the key being played. Many of the classics were created using these tunings.
P-50	Kirnberger: See “Werckmeister”.
P-51	Vallotti & Young: See “Werckmeister”.
P-52	1/4 Shifted Equal: This is an equal temperament tuning with the overall pitch raised 1/4 tone. It can be used with other instruments in standard equal temperament tuning for some unusual and very “tense” effects.
P-53	1/4 Tone: All semitones on the keyboard become 1/4-tone intervals.
P-54	1/8 Tone: All semitones on the keyboard become 1/8-tone intervals.

- The I-1 and I-2 tunings (Internal Microtuning) cannot be edited or modified using the VL1-m. Microtuning data from the Yamaha SY99 or SY77 synthesizer, however, can be loaded into the VL1-m via a MIDI bulk dump or parameter change operation.



- The “Element 2” parameter will not appear if the “Voice Mode” parameter (≥ Page 32) is set to “Single”.

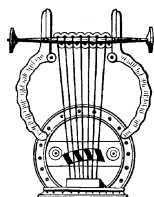

7: Quick Edit Assign

```

EDIT/COM/MISC/QUICK EDIT ASSIGN
BA07(007):Tull Flute
QED1(CC16) = Com:REV Return
QED2(CC17) = Com:FBD Return
    
```

● QED1 (cc16)

● QED2 (cc17)

≤ off, Com, E1, E2, Both — plus the parameters available for the current voice.

Assigns the available common or element edit parameters to the corresponding MIDI controller (QED1 = control change number 16; QED2 = control change number 17). The controllers can then be used in the PLAY mode to edit the assigned parameters in real time while playing (the same applies to the EDIT and UTILITY modes). The parameter consists of two parts which can be selected independently by moving the cursor horizontally. The first (leftmost) part determines what type of parameter will be controlled.

off	Controller not assigned. Choose this setting if you don't want the controller to affect any edit parameters.
Com	Selects the common edit parameters.
E1	Selects the element 1 edit parameters. This setting will appear as “E1*” if previously set to “E2” or “Both” with the Voice Mode parameter set to “Dual”, then the Voice Mode parameter is switched to “Single”.
E2	Selects the element 2 edit parameters.
Both	Selects element edit parameters that will affect both element 1 and element 2.

The second (rightmost) part is the actual parameter which will be controlled. The parameters available for editing via the continuous sliders are individually preset for each voice.

- Since the controllers actually edit the parameters to which they are assigned, the “new” voice created by using the controllers can be stored to one of the VL1-m’s voice memory locations and used just as if it had been edited in the EDIT mode (≥ the STORE operation is described on page 27).
- The quick edit view function, available in the PLAY mode (≥ Page 13), shows you which parameters are assigned to which controller as well as the current positions of the controllers and their corresponding values.

Common Effect

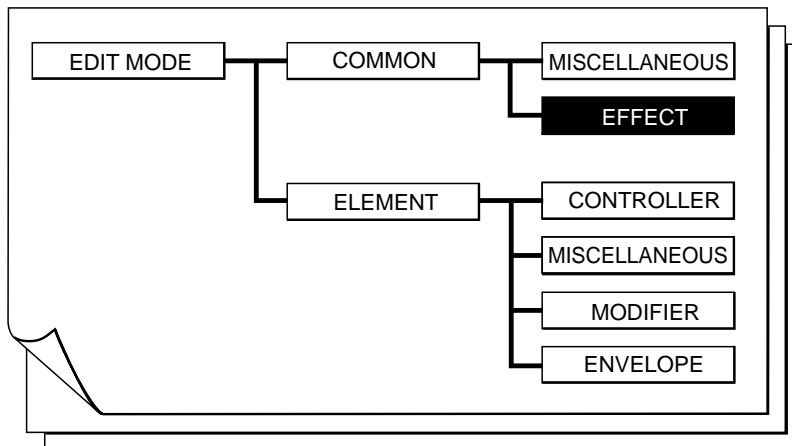

The COMMON EFFECT parameters provide access to the VL1-m's sophisticated three-stage digital signal processing system.

■ 1: Setting	45	■ 3: Feedback Delay	53
■ 2: Modulation Effect	46	● Mono Delay	53
● Flanger	47	● L,R Delay	55
● Pitch Change	49	● L,C,R Delay	57
● Distortion	51	■ 4: Reverberation	60
		● Hall1, Hall2, Room1, Room2, Studio, Plate, Space, Reverse	61

```

EDIT/COM
BA07(007):Tull Flute
<Effect>
1:Setting
2:Modulation Effect
3:Feedback Delay
4:Reverberation
Misc Efect
    
```



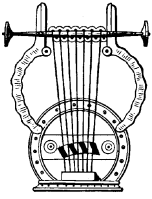

1: Setting

```

EDIT/COM/EFFECT/SETTING
0007(007):Tull Flute
Feedback Delay/Reverb.Mode = Serial
Effect Control
Destination Effect
= off
Controller = off
    
```

Common Effect

● Feedback Delay/Reverb Mode

≤ *Serial, Parallel.*

Determines whether the Feedback Delay and Reverb effect stages are connected in series (Serial) or in parallel, as shown in the illustration.

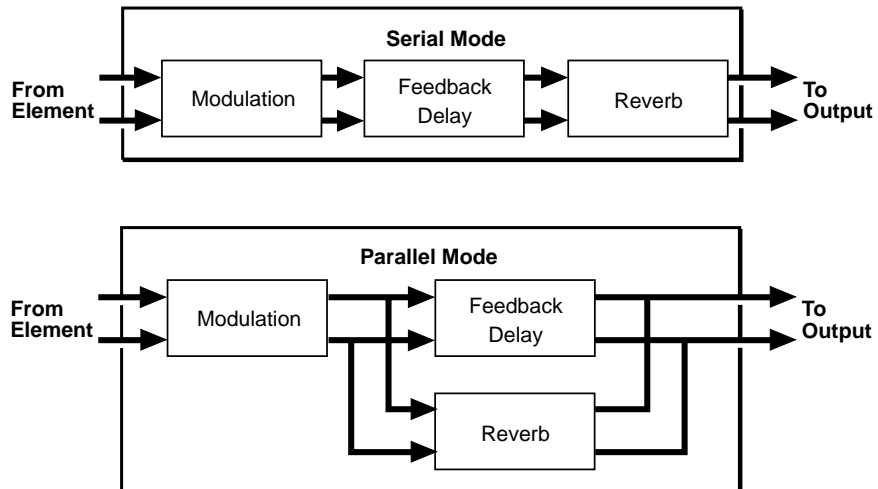

● Effect Control — Destination Effect

≤ *off, Flanger Freq., Pitch Change Wet/Dry, Distortion Presence, FB Delay Send Level, Reverb Send Level.*

This and the following parameter make it possible to control certain effect parameters in real time via any physical MIDI controller. Use this parameter to select the effect parameter you want to control (only settings corresponding to the currently selected effects will be available). If the currently selected effect stage is turned off, “isn’t used” will appear on the display and selection will not be possible.

● Effect Control — Controller

≤ *off, Modulation Wheel ... Velocity.*

Selects the controller which will be used to control the parameter selected via the “Destination Effect” parameter. All MIDI control numbers and keyboard velocity are available. Be sure to turn this parameter “off” if you don’t require realtime effect control.



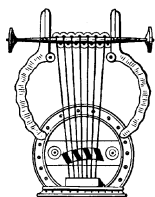

2: Modulation Effect

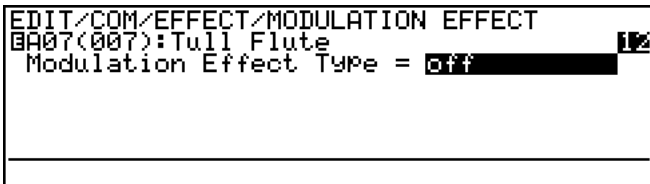

● Modulation Effect Type

≤ *off, Flanger, Pitch Change, Distortion.*

Selects the type of effect to be produced by the modulation effect stage. The effect types and their parameters are individually described on the following pages. No effect parameters appear when the modulation effect stage is turned “off”.

Flanger	This type of effect is created by slightly delaying the sound and periodically varying the delay time. The delayed signal is then added to the direct signal causing a variable comb-filter effect which results in the familiar “swishing” flanger sound.
Pitch Change	A dual pitch change effect which can be used in the Mono mode, in which both pitch-shifted notes appear on both channels, or the Stereo mode in which one pitch-shifted note appears on the left channel and the other on the right. The pitch of the two pitch-shifted notes can be set over a two-octave range — from one octave below to one octave above the input note.
Distortion	An extremely versatile distortion effect which offers transistor, vintage tube, fuzz and other distortion types, a variety of speaker types, and a comprehensive range of other parameters that can be used to refine the distortion sound.



Flanger

```

EDIT/COM/EFFECT/MODULATION EFFECT
BA07(007):Tull Flute
Modulation Effect Type = Flanger
Element on/off      E1: on   E2: on
Wave = Triangle     Freq. = 0.370 Hz
Depth = 76%         Delay = 1.04 ms
Phase = -22.5deg
    
```

```

EDIT/COM/EFFECT/MODULATION EFFECT
BA07(007):Tull Flute
Modulation Effect Type = Flanger
FB Gain = 80%      High = 0.9
Analog Feel = 5
Wet/Dry Balance = 50%
    
```

- Use the [F1] (“▲”) and [F2] (“▼”) buttons to switch between the two pages of effect parameters.

● Element on/off — E1: & E2:



≤ *off, on.*

In this parameter the cursor can be positioned at “E1:” or “E2:” to individually turn the flanger effect on or off for elements 1 and 2, respectively. When “on” the output of the corresponding element is fed to the input of the modulation stage, and when “off” the modulation stage is bypassed. The “E2:” parameter will not appear when editing a single-element voice.

● Wave

≤ *Triangle, Sine, Random.*

Selects the waveform which will be used to modulate the flanger effect.

Triangle	
Sine	
Random	

● Freq.

≤ *0.057 ... 40.0 Hz when Triangle or Sine Wave selected,*

≤ *0.229 ... 160.0 Hz when Random Wave selected.*

Sets the speed of modulation and therefore the rate of flanger effect variation.

● Depth

≤ *0 ... 100 %.*

Sets the depth of modulation. Higher values produce deeper modulation and therefore a more pronounced flanger effect.

Flanger

● **Delay**

$\leq 0.33 \dots 32.87 \text{ ms.}$

Sets the flanger delay time (the flanger effect is basically produced by modulating the delay time of one signal in relation to another). Shorter delay times produce the greatest effect in the high-frequency range, while longer delay times extend the effect to the middle and lower frequencies. Delays longer than about 5 milliseconds produce a more chorus-like effect.

● **Phase**

$\leq -180.0 \dots 180.0 \text{ deg.}$

Sets the phase difference between the left and right channel flanger signals. The larger the value, the greater the “spread” in the sound. A setting of “0” produces a centered effect.

● **FB Gain**

$\leq -100 \dots 100 \text{ \%}$.

Determines the amount of effect-sound feedback returned to the input of the flanger stage. Higher negative or positive values produce a more pronounced effect.

● **High**

$\leq 0.1 \dots 1.0$.

Determines the amount of high-frequency effect-sound feedback returned to the input of the flanger stage. Lower values produce more cut in the high-frequency range.

● **Analog Feel**

$\leq 0 \dots 10$.

This parameters simulates the sound of traditional analog flanger devices. The higher the value the stronger the “analog feel”.

● **Wet/Dry Balance**

$\leq 0 \dots 100 \text{ \%}$.

Sets the balance between the direct (“dry”) and effect (“wet”) sound. Higher values produce a greater proportion of effect sound in relation to direct sound.

■ **Flanger Effect Block Diagram**

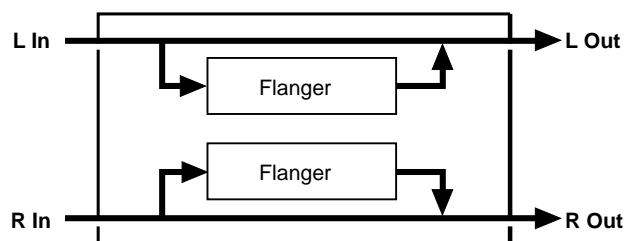

Pitch Change

```

EDIT/COM/EFFECT/MODULATION EFFECT
BA07(007):Tull Flute
Modulation Effect Type = Pitch Change
Element on/off      E1: on   E2: on
Mode                = Monaural
1 Pitch             = 0       Fine = 12
1 Output            = 80%
    
```

```

EDIT/COM/EFFECT/MODULATION EFFECT
BA07(007):Tull Flute
Modulation Effect Type = Pitch Change

Wet/Dry Balance = 70%
2 Pitch         = 0       Fine = -8
2 Output       = 80%
    
```

- Use the [F1] (“▲”) and [F2] (“▼”) buttons to switch between the two pages of effect parameters.

● Element on/off — E1: & E2:

≤ *off, on.*

In this parameter the cursor can be positioned at “E1:” or “E2:” to individually turn the pitch change effect on or off for elements 1 and 2, respectively. When “on” the output of the corresponding element is fed to the input of the modulation stage, and when “off” the modulation stage is bypassed. The “E2:” parameter will not appear when editing a single-element voice.

● Mode

≤ *Monaural, Stereo.*

Selects the monaural or stereo pitch change effect mode. In the monaural mode both pitch-shifted notes appear on both channels. In the stereo mode one pitch-shifted note appears on the left channel and the other on the right.

■ Monaural Mode Block Diagram

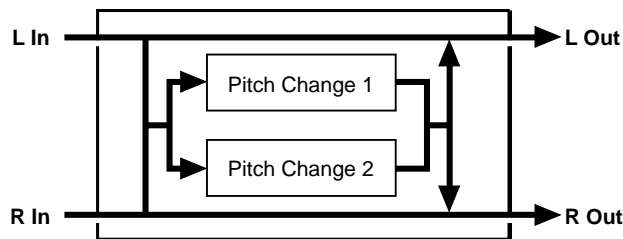

■ Stereo Mode Block Diagram

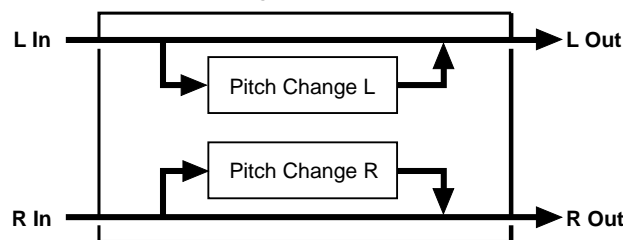

Pitch Change

● **1 Pitch (L Pitch)**● **2 Pitch (R Pitch)**

$\leq -12 \dots 12.$

These two parameters individually set the pitch of the first and second pitch-changed note between one octave below (“-12”) and one octave above (“+12”) the input note. When the “Stereo” mode is selected, the “1 Pitch” parameter applies to the left channel and the “2 Pitch” parameter to the right.

● **1 Fine (L Fine)**● **2 Fine (R Fine)**

$\leq -100 \dots 100.$

Permit fine tuning of the first and second pitch-changed note in 1-cent steps (1 cent is 1/100th of a semitone). When the “Stereo” mode is selected, the “L Fine” parameter applies to the left channel and the “R Fine” parameter to the right.

● **1 Output (L Output)**● **2 Output (R Output)**

$\leq 0 \dots 100\%.$

Set the output level of the corresponding pitch-changed note. The higher the value the higher the output level. When the “Stereo” mode is selected, the “1 Output” parameter applies to the left channel and the “2 Output” parameter to the right.

● **Wet/Dry Balance**

$\leq 0 \dots 100\%.$

Sets the balance between the direct (“dry”) and effect (“wet”) sound. Higher values produce a greater proportion of effect sound in relation to direct sound. When set to “0” no pitch change effect is produced.

Distortion

```

EDIT/COM/EFFECT/MODULATION EFFECT
BA07(007):Tull Flute
Modulation Effect Type = Distortion
Element on/off      E1: on   E2: on
Overdrive           = 50%
Device              = Transistor
Output Level        = 60%
    
```

```

EDIT/COM/EFFECT/MODULATION EFFECT
BA07(007):Tull Flute
Modulation Effect Type = Distortion
Speaker             = Stack
Presence            = 0
    
```

- Use the [F1] (“▲”) and [F2] (“▼”) buttons to switch between the two pages of effect parameters.

● Element on/off — E1: & E2:

≤ *off, on.*

In this parameter the cursor can be positioned at “E1:” or “E2:” to individually turn the distortion effect on or off for elements 1 and 2, respectively. When “on” the output of the corresponding element is fed to the input of the modulation stage, and when “off” the modulation stage is bypassed. The “E2:” parameter will not appear when editing a single-element voice.

● Overdrive

≤ *0 ... 100 %.*

Sets the intensity of the overdrive or distortion effect. Higher values produce more distortion.

● Device

≤ *Transistor, Vintage Tube, Distortion 1, Distortion 2, Fuzz.*

Determines the basic sound of the distortion effect.

Transistor	The crisp, tight distortion of an overdriven transistor amplifier.
Vintage Tube	Simulates the warm, relatively “soft” distortion produced by vacuum tube amplifiers.
Distortion 1	A traditional “stomp-box” type distortion unit, type 1.
Distortion 2	A traditional “stomp-box” type distortion unit, type 2.
Fuzz	Early “fuzz boxes” produced this type of distortion — rough and somewhat rude.

Distortion

● **Output Level**

≤ 0 ... 100 %.

Sets the output level of the distortion sound. Higher values produce higher level.

● **Speaker**

≤ Flat, Stack, Combo, Twin, Radio, Megaphone.

Simulates a variety of speaker types and configurations via which the distortion sound might be reproduced.

Flat	No speaker — the sound of a “direct feed” to a recording or sound reinforcement console.
Stack	The powerful, expansive sound of stacked speaker cabinets.
Combo	A single 12" speaker unit in an open-backed enclosure.
Twin	Two 12" speaker units in a relatively small open-backed enclosure.
Radio	The small, compressed, but pleasant tone of a radio receiver.
Megaphone	Constricted tone with emphasis on the middle frequencies.

● **Presence**

≤ -10 ... 10.

Varies the “presence” or “brilliance” of the sound. Higher values produce more presence and “punch”.

■ **Distortion Effect Block Diagram**

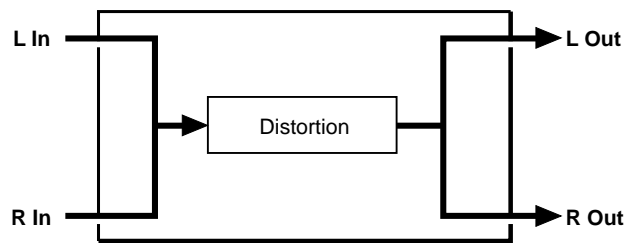

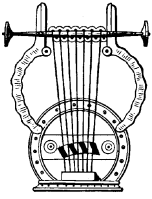

3: Feedback Delay

```

EDIT/COM/EFFECT/FEEDBACK DELAY
BA07(007):Tull Flute
Delay Type      = off
    
```

● Delay Type

≤ off, Mono, L,R, L,C,R.

Selects the type of effect to be produced by the Feedback Delay effect stage. The effect types and their parameters are individually described on the following pages. No effect parameters appear when the Feedback Delay effect stage is turned “off”.

Mono	The Mono delay effect produces a single delay sound which appears in the center of the stereo sound field.
L,R	This variation provides independently programmable delays for the left and right stereo channels.
L, C, R	Independent delays are provided for the left and right channels, plus a center delay.

Mono Delay

```

EDIT/COM/EFFECT/FEEDBACK DELAY
BA07(007):Tull Flute
Delay Type      = Mono
Return         = 80%
FB Delay Time  = 750ms
FB Gain        = 50%
High          = 0.7
    
```

```

EDIT/COM/EFFECT/FEEDBACK DELAY
BA07(007):Tull Flute
Delay Type      = Mono
Delay Time     = 500ms
Level          = 80%
    
```

- Use the [F1] (“▲”) and [F2] (“▼”) buttons to switch between the two pages of effect parameters.

● Return

≤ 0 ... 100 %.

Determines how much of the delayed sound is mixed with the direct sound. Higher values produce higher delay sound levels.

Mono Delay

● **FB Delay Time**

≤ 0 ... 1024 ms.

Sets the delay time between repeats. The higher the value the longer the delay.

- Use the VL1-m “Time Calculation” function (≥ Page 59) to enter delay times based on musical tempo and note lengths.

● **FB Gain**

≤ 0 ... 100 %.

Determines the amount of effect-sound feedback returned to the input of the delay stage. Higher values produce a greater number of repeats.

● **High**

≤ 0.1 ... 1.0.

Produces a natural decay in the high-frequency components of subsequent repeats. The lower the value the faster and more pronounced the drop-off in high-frequencies.

● **Delay Time**

≤ 0 ... 1024 ms.

Sets the delay time between the direct sound and the first repeat.

- Use the VL1-m “Time Calculation” function (≥ Page 59) to enter delay times based on musical tempo and note lengths.

● **Level**

≤ 0 ... 100 %.

Sets the overall level of the delay sound. Higher values produce higher delay level.

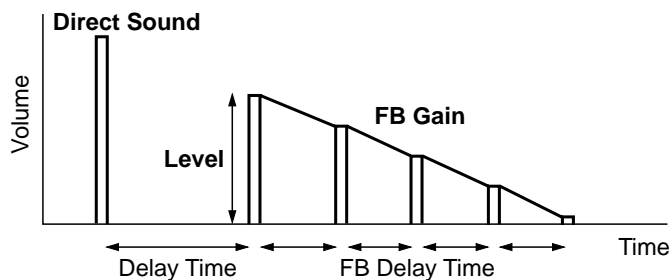

■ **Mono Delay Effect Block Diagram**

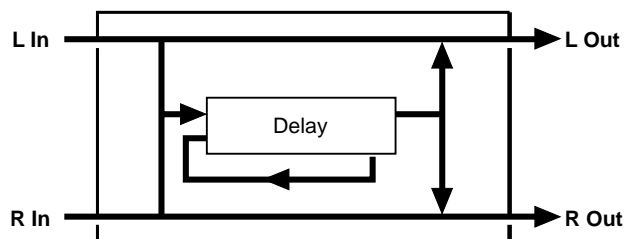

L,R Delay

```

EDIT/COM/EFFECT/FEEDBACK DELAY
BA07(007):Tull Flute
Delay Type      = L,R
Return         = 80%
Lch Delay Time = 500ms   Level = 80%
Lch FB Gain    = 50%    High  = 0.7
    
```

```

EDIT/COM/EFFECT/FEEDBACK DELAY
BA07(007):Tull Flute
Delay Type      = L,R
Rch Delay Time = 500ms   Level = 80%
Rch FB Gain    = 50%    High  = 0.7
    
```

- Use the [F1] (“▲”) and [F2] (“▼”) buttons to switch between the two pages of effect parameters.

● Return

≤ 0 ... 100 %.

Determines how much of the delayed sound is mixed with the direct sound. Higher values produce higher delay sound levels.

● Lch Delay Time

● Rch Delay Time

≤ 0 ... 512 ms.

Set the delay time between repeats. Independent parameters are provided for the left (“Lch”) and right (“Rch”) channels.

- Use the VL1-m “Time Calculation” function (≥ Page 59) to enter delay times based on musical tempo and note lengths.

● Lch Level

● Rch Level

≤ 0 ... 100 %.

Set the overall level of the delay sound. Higher values produce higher delay level. Independent parameters are provided for the left (“Lch”) and right (“Rch”) channels.

● Lch FB Gain

● Rch FB Gain

≤ 0 ... 100 %.

Determine the amount of effect-sound feedback returned to the input of the delay stage. Higher values produce a greater number of repeats. Independent parameters are provided for the left (“Lch”) and right (“Rch”) channels.

L,R Delay

● **Lch High**

● **Rch High**

≤ 0.1 ... 1.0.

Produces a natural decay in the in the high-frequency components of subsequent repeats. The lower the value the faster and more pronounced the drop-off in high-frequencies. Independent parameters are provided for the left (“Lch”) and right (“Rch”) channels.

■ **L,R Delay Effect Block Diagram**

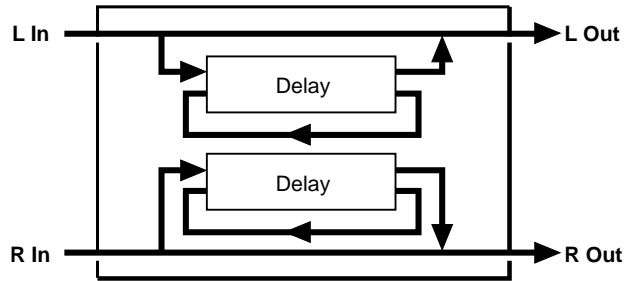

L,C,R Delay

```

EDIT/COM/EFFECT/FEEDBACK DELAY
BA07(007):Tull Flute
Delay Type      = 80%
Return         = 80%
FB Delay Time  = 750ms
FB Gain       = 50%
High          = 0.7
    
```

```

EDIT/COM/EFFECT/FEEDBACK DELAY
BA07(007):Tull Flute
Delay Type      = 80%
Lch Delay Time = 125ms   Level = 80%
Cch Delay Time = 500ms  Level = 80%
Rch Delay Time = 250ms  Level = 80%
    
```

- Use the [F1] (“▲”) and [F2] (“▼”) buttons to switch between the two pages of effect parameters.

● Return

≤ 0 ... 100 %.

Determines how much of the delayed sound is mixed with the direct sound. Higher values produce higher delay sound levels.

● FB Delay Time

≤ 0 ... 1024 ms.

Sets the delay time between repeats. The higher the value the longer the delay.

- Use the VL1-m “Time Calculation” function (≥ Page 59) to enter delay times based on musical tempo and note lengths.

● FB Gain

≤ 0 ... 100 %.

Determines the amount of effect-sound feedback returned to the input of the delay stage. Higher values produce a greater number of repeats.

● High

≤ 0.1 ... 1.0.

Produces a natural decay in the in the high-frequency components of subsequent repeats. The lower the value the faster and more pronounced the drop-off in high-frequencies.

L,C,R Delay

- **Lch Delay Time**
- **Cch Delay Time**
- **Rch Delay Time**

≤ 0 ... 1024 ms.

Set the delay time between the direct sound and the first repeat. Independent parameters are provided for the left (“Lch”), center (“Cch”), and right (“Rch”) channels.

- Use the VL1-m “Time Calculation” function (≥ Page 59) to enter delay times based on musical tempo and note lengths.

- **Lch Level**
- **Cch Level**
- **Rch Level**

≤ 0 ... 100 %.

Set the overall level of the delay sound. Higher values produce higher delay level. Independent parameters are provided for the left (“Lch”), center (“Cch”), and right (“Rch”) channels.

■ **L,C,R Delay Effect Block Diagram**

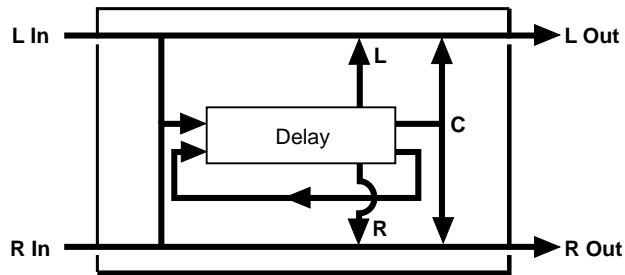

Musical Time Calculation

Since the goal in producing a delay effect is often to match the delay time to a musical time value, the VL1-m includes a “time calculation” function that makes it easy to convert standard note values to their corresponding delay times in milliseconds.

1. Select a Delay Time Parameter

Position the cursor at the delay time parameter you want to edit — “Calc” will appear above the **F8** button.

2. Press **F8**

Press the **F8** function button (“calc”). The “TIME CALCULATION” window will appear.

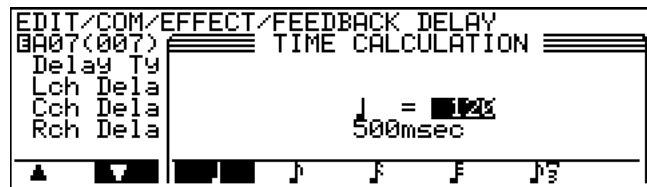

3. Set the Required Tempo

Use the data dial or **DEC** and **INC** buttons to specify the tempo you will be playing at (quarter-note beats per minute). The delay time corresponding to one quarter note at the specified tempo will appear, in milliseconds, below the selected tempo.

4. Select the Required Note Length

Use the **F3** through **F7** buttons to select the note length to which you want to match the delay time. The corresponding delay time will appear, as in the preceding step.

5. Press **ENTER**

Press the **ENTER** button. The “TIME CALCULATION” window will disappear and the calculated delay time will automatically be entered for the delay time parameter (you can also press **EXIT** to cancel this operation).

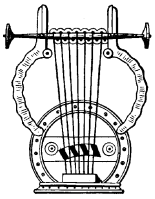

4: Reverberation

```

EDIT/COM/EFFECT/REVERBERATION
0A07(007):Tull Flute
Reverb Type      = off
    
```

● Reverb Type

≤ *off, Hall1, Hall2, Room1, Room2, Studio, Plate, Space, Reverse.*

Selects the type of effect to be produced by the Reverb effect stage. Unlike the preceding effect stages, the parameters are the same for all Reverb effect types. No effect parameters appear when the Reverb effect stage is turned “off”.

Hall 1	A simulation of the reverberation characteristics of a fairly standard concert hall.
Hall 2	This hall simulation produces a richer low-frequency reverb sound than the Hall 1 program.
Room 1	The ambience of a small room rather than a large hall. This effect is ideal when you just want a subtle touch of ambience.
Room 2	A larger room than the Room 1 simulation, with a correspondingly “bigger” reverb sound.
Studio	In recording studios it is generally desirable to suppress low-frequency reverberation without entirely losing the “live” sound of the room. The Studio program simulates this type of environment.
Plate	The plate reverb unit is a classic tool of the recording trade — it was the first mechanical method of creating artificial reverberation that was capable of producing satisfactory results in the studio. This is a very realistic simulation.
Space	A diffuse reverberation of the type you might experience in an extremely large space.
Reverse	In this effect the reverb sound plays in reverse, building up to maximum level rather than decaying as normal.



Hall1, Hall2, Room1, Room2, Studio, Plate, Space, Reverse

```

EDIT/COM/EFFECT/REVERBERATION
BA07(007):Tull Flute
Reverb Type = Hall1
Return = 51%
Reverb Time = 2.4sec
Reverb Time Boost = 0
High Control = 0.6
    
```

```

EDIT/COM/EFFECT/REVERBERATION
BA07(007):Tull Flute
Reverb Type = Hall1
Diffusion = 5
Initial Delay = 35ms
Feel = 1
Bass = 0 Treble = -7
    
```

- Use the [F1] (“▲”) and [F2] (“▼”) buttons to switch between the two pages of effect parameters.

● **Return**

≤ 0 ... 100 %.

Determines how much of the reverb sound is mixed with the direct sound. Higher values produce higher reverb sound levels.

● **Reverb Time**

≤ 0.05 ... 100.0 sec.

Sets the amount of time it takes for the reverb sound to decay by 60 dB (virtually to silence).

● **Reverb Time Boost**

≤ 0 ... 10.

This parameter can be used to extend the tail end of the reverb sound. The higher the value the greater the “boost”.

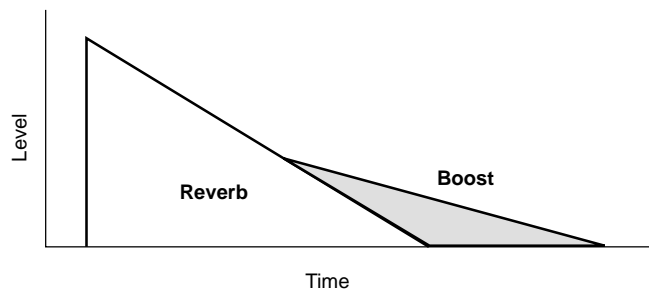

● High Control

$\leq 0.1 \dots 1.0.$

Sets the reverb time of the high frequencies in relation to the overall reverb time. Higher values produce longer high-frequency reverb times, gradually approaching the overall reverb time.

● Diffusion

$\leq 0 \dots 10.$

Adjusts the left-right “spread” of the reverb sound. The higher the value the greater the spread.

● Initial Delay

$\leq 0 \dots 405 \text{ ms.}$

Sets the delay time before the reverb sound begins.

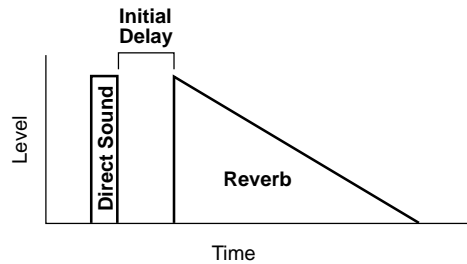

● Feel

$\leq 0 \dots 3.$

Selects one of four variations in density or overall sound available for each of the VL1-m’s reverb types.

● Bass

$\leq -21 \dots 12.$

Emphasizes the bass frequencies. The higher the value the greater the bass emphasis.

● Treble

$\leq -21 \dots 12.$

Emphasizes the treble frequencies. The higher the value the greater the treble emphasis.



■ Reverb Effect Block Diagram

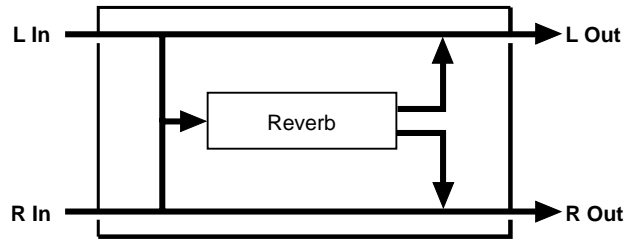

Element Controller

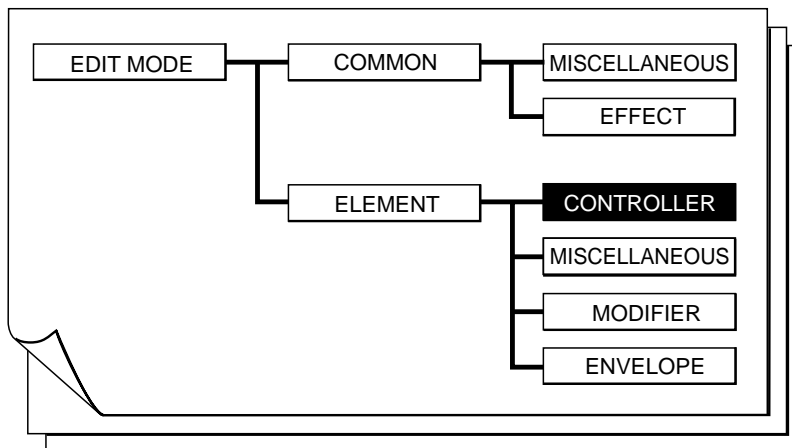

■ 1: Pressure	65	■ 9: Growl	74
■ 2: Embouchure	66	■ 10: Throat Formant	75
■ 3: Pitch	67	■ 11: Dynamic Filter	77
■ 4: Vibrato	69	■ 12: Harmonic Enhancer	78
■ 5: Tonguing	70	■ 13: Damping	80
■ 6: Amplitude	71	■ 14: Absorption	81
■ 7: Scream	72	■ Controller Search & Replace	82
■ 8: Breath Noise	73		

```

EDIT/E1
BA07(007):Tull Flute/E1:Tull Flute
<Controller>
01:Pressr 05:Tnguing 09:Growl 13:Dampng
02:Embchr 06:AmPltd 10:Throat 14:AbsrPtn
03:Pitch 07:Scream 11:D.Filtr
04:Vibrato 08:B.Noise 12:H.Enhnc
Ctrl Misc Modi Env S&R
  
```

Pressing the **[F8]** button (“S&R”) from this page will take you to the “CONTROLLER SEARCH & REPLACE” window, allowing you to see which controllers are assigned to which parameters, and to modify the assignments as required (≥ Page 82).



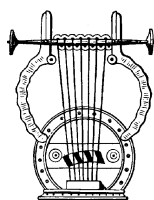

1: Pressure



- The **[F7]** button (“Fpag”) can be used to go directly the next Element Controller page without having to return to the directory.

● Controller

≤ *off, Modulation Wheel ... Touch EG (124 settings).*

The “Pressure” parameter corresponds to the amount of breath pressure applied to a reed or mouthpiece, or the speed of the bow applied to a string. Pressure variations affect both volume and timbre. The “Controller” parameter specifies the controller to be used for pressure control. When set to “off” maximum pressure is applied at all times.

- Please note that accurate keyboard pitch is produced only at maximum pressure.
- The actual pressure value applied to the VL1-m tone generator is the product of the pressure from the controller and that from the pressure envelope (≥ Page 129).

● Depth

≤ *-127 ... 127.*

Sets the amount of variation produced by the controller assigned to pressure. The higher the value the greater the variation. Positive values cause an increase in pressure in response to higher controller values (e.g. increased breath pressure or higher modulation wheel position), while minus values cause a decrease in pressure in response to higher controller values. The “Depth” setting is reflected in the graph to the right of the parameters — the horizontal axis represents the controller value and the vertical axis represents pressure.

● Curve

≤ *-16 ... 16.*

Determines the relationship between the controller value and pressure. When set to “0” the relationship is linear. That is, a change in the controller value produces a corresponding change in pressure. As the curve value increases the lower end of the controller range has relatively little effect on the sound while higher controller values produce more dramatic changes. Negative curve values have the opposite effect: the sound changes dramatically at low controller values while higher values produce relatively little effect. The “Curve” setting is reflected in the graph to the right of the parameters — the horizontal axis represents the controller value and the vertical axis represents pressure.

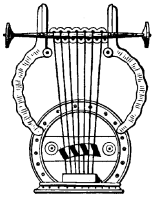

2: Embouchure

```

EDIT/E1/CTRL/EMBOUCHURE
0A07(007):Tull Flute/E1:Tull Flute
Controller = After Touch
Upper Depth = 127
Lower Depth = 0
Mode = Center Base
BPag FPa9

```

- The **[F6]** and **[F7]** buttons (“Bpag” and “Fpag”) can be used to go directly backward or forward to the next Element Controller page without having to return to the directory.

● Controller

≤ *off, Modulation Wheel ... Touch EG (124 settings).*

The “Embouchure” parameter corresponds to the tightness of the lips against the reed or against each other. In a string instrument voice Embouchure corresponds to how strongly the bow is pressed against the string. Affects both pitch and timbre. The “Controller” parameter specifies the controller to be used for embouchure control. When set to “off” medium embouchure is applied at all times.

- Please note that accurate keyboard pitch is produced only at medium embouchure.
- The actual embouchure value applied to the VL1-m tone generator is a mix of the embouchure from the controller and that from the embouchure and pitch envelopes (≥ Page 130).

● Upper Depth

≤ *-127 ... 127.*

Sets the amount of variation produced by the controller assigned to embouchure when the controller is set to its maximum position (e.g. a modulation wheel rolled all the way up). The higher the value the greater the variation. Positive values cause an increase in embouchure in response to higher controller values, while minus values cause a decrease in embouchure in response to higher controller values. The value of the “Lower Depth” parameter, below, is automatically changed in response to changes in the “Upper Depth” value (the “Lower Depth” value is always negative when “Upper Depth” is positive, and vice versa).

● Lower Depth

≤ *-127 ... 127.*

Sets the amount of variation produced by the controller assigned to embouchure when the controller is set to its minimum position (e.g. a modulation wheel rolled all the way down). The higher the value the greater the variation. Positive values cause an increase in embouchure in response to lower controller values, while minus values cause a decrease in embouchure in response to lower controller values. Changing the value of the “Lower Depth” parameter has no effect on the “Upper Depth” value. The



“Lower Depth” parameter is not available when the “Mode” parameter, below, is set to “Minimum Base”.

● Mode

≤ *Center Base, Minimum Base.*

Selects the controller value (position) which will produce “normal” embouchure. When set to “Center Base” a central controller position will produce normal embouchure, allowing both downward and upward variation. A setting of “Minimum Base” will produce normal embouchure when the controller is set to its minimum position, allowing only upward variation.

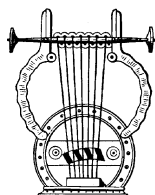

3: Pitch

```

EDIT/E1/CTRL/PITCH
BA07(007):Tull Flute/E1:Tull Flute
Controller = Pitch Bend
Upper Depth = 2
Lower Depth = -2
Mode = Center Base
BPag FPa9
    
```

- The [F6] and [F7] buttons (“BPag” and “FPag”) can be used to go directly backward or forward to the next Element Controller page without having to return to the directory.

● Controller

≤ *off, Modulation Wheel ... Touch EG (124 settings).*

The “Pitch” parameter changes the length of the air column or string, and thereby the pitch of the sound. The “Controller” parameter specifies the controller to be used for pitch control. When set to “off” no pitch variation is produced.

- The actual pitch value applied to the VL1-m tone generator is a mix of the pitch value from the controller and that from the embouchure and pitch envelopes (≥ Page 130).
- For the same type of simple pitch control available in conventional synthesizers, assign only the Pitch parameter to controller you intend to use for pitch control (normally the pitch bend wheel). For more natural, realistic pitch bend effects, it is sometimes effective to assign both the Pitch and Embouchure parameters to the same controller.



● Upper Depth

≤ -12 ... 12.

Sets the amount of variation produced by the controller assigned to pitch when the controller is set to its maximum position (e.g. a pitch wheel rolled all the way up). The higher the value the greater the variation. Positive values cause an increase in pitch in response to higher controller values, while minus values cause a decrease in pitch in response to higher controller values. The value of the “Lower Depth” parameter, below, is automatically changed in response to changes in the “Upper Depth” value (the “Lower Depth” value is always negative when “Upper Depth” is positive, and vice versa).

● Lower Depth

≤ -12 ... 12.

Sets the amount of variation produced by the controller assigned to pitch when the controller is set to its minimum position (e.g. a pitch wheel rolled all the way down). The higher the value the greater the variation. Positive values cause an increase in pitch in response to lower controller values, while minus values cause a decrease in pitch in response to lower controller values. Changing the value of the “Lower Depth” parameter has no effect on the “Upper Depth” value. The “Lower Depth” parameter is not available when the “Mode” parameter, below, is set to “Minimum Base”.

● Mode

≤ Center Base, Minimum Base.

Selects the controller value (position) which will produce normal pitch. When set to “Center Base” a central controller position will produce normal pitch, allowing both downward and upward variation. A setting of “Minimum Base” will produce normal pitch when the controller is set to its minimum position, allowing only upward variation.

- Please note that accurate keyboard pitch is produced only when the “Mode” parameter is set to “Center Base”.



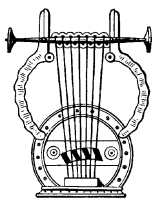

4: Vibrato

```

EDIT/E1/CTRL/VIBRATO
BA07(007):Tull Flute/E1:Tull Flute
Controller = off
Depth      = 68

```

BPa9 FPa9 Para

- The **F6** and **F7** buttons (“Bpa9” and “Fpa9”) can be used to go directly backward or forward to the next Element Controller page without having to return to the directory.
- The **F8** button (“Para”) can be used to go directly to the Vibrato parameter page (≥ Page 135), also available from the ELEMENT ENVELOPE directory. You can then return to the controller vibrato page by pressing **F8** (“Ctrl”) again.

● Controller

≤ *off, Modulation Wheel ... Touch EG (124 settings).*

This is essentially a standard vibrato (pitch modulation) effect. An extensive range of parameters makes it possible to achieve extremely natural vibrato effects. The amounts of vibrato applied via pitch and embouchure, for example, are independently programmable. The “Controller” parameter specifies the controller to be used for vibrato depth control. When set to “off” no vibrato can be applied.

● Depth

≤ *-127 ... 127.*

Sets the amount of variation produced by the controller assigned to vibrato. The higher the value the greater the variation. Positive values cause an increase in vibrato depth in response to higher controller values (e.g. increased breath pressure or higher modulation wheel position), while minus values cause a decrease in vibrato depth in response to higher controller values.

- No vibrato effect can be applied via any controller if the ELEMENT ENVELOPE “Vibrato Depth”, “Depth to Embouchure”, or “Depth to Pitch” parameters are set to “0” (≥ Page 135, 136).

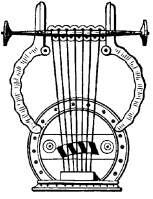

5: Tonguing



- The **[F6]** and **[F7]** buttons (“Bpa9” and “Fpa9”) can be used to go directly backward or forward to the next Element Controller page without having to return to the directory.

● Controller

≤ *off, Modulation Wheel ... Touch EG (124 settings).*

The “Tonguing” parameter simulates the half-tonguing technique used by saxophone players by changing the “slit” of the reed. The slit is the space between the tip of the reed and the mouthpiece. The “Controller” parameter specifies the controller to be used for tonguing control. When set to “off” no tonguing is applied.

- Please note that accurate keyboard pitch is produced only when maximum tonguing is applied or the tonguing controller is turned off.

● Depth

≤ *-127 ... 127.*

Sets the amount of variation produced by the controller assigned to tonguing. The higher the value the greater the variation. Positive values cause a decrease in tonguing in response to higher controller values (e.g. increased breath pressure or higher modulation wheel position), while minus values cause an increase in tonguing in response to higher controller values. The “Depth” setting is reflected in the graph to the right of the parameters — the horizontal axis represents the controller value and the vertical axis represents tonguing.

● Curve

≤ *-16 ... 16.*

Determines the relationship between the controller value and tonguing. When set to “0” the relationship is linear. That is, a change in the controller value produces a corresponding change in tonguing. As the curve value increases the lower end of the controller range has relatively little effect on the sound while higher controller values produce more dramatic changes. Negative curve values have the opposite effect: the sound changes dramatically at low controller values while higher values produce relatively little effect. The “Curve” setting is reflected in the graph to the right of the parameters — the horizontal axis represents the controller value and the vertical axis represents tonguing.



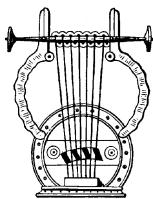

6: Amplitude



- The **[F6]** and **[F7]** buttons (“BPa9” and “FPa9”) can be used to go directly backward or forward to the next Element Controller page without having to return to the directory.

● Controller

≤ *off, Modulation Wheel ... Touch EG (124 settings).*

Unlike pressure, the “Amplitude” parameter controls the volume of the sound without varying timbre. The “Controller” parameter specifies the controller to be used for amplitude control. When set to “off” no amplitude control can be applied.

- Amplitude control via this parameter actually occurs between the modifier Dynamic Filter and Equalizer stages, the effect of the subsequent impulse expander and resonator stages is therefore not affected by the amplitude setting. In contrast, amplitude control applied via MIDI volume control change number (007) affects the sound level at the instrument’s output, and therefore the total output from all modifier and effect stages.
- The Amplitude parameter affects the level of the sound prior to the VL1-m effect stages, so it can be used to vary the amount of overdrive produced by the distortion effect, for example (≥ Page 51).

● Depth

≤ *-127 ... 127.*

Sets the amount of variation produced by the controller assigned to amplitude. The higher the value the greater the variation. Positive values cause an increase in amplitude in response to higher controller values (e.g. increased breath pressure or higher modulation wheel position), while minus values cause a decrease in amplitude in response to higher controller values. The “Depth” setting is reflected in the graph to the right of the parameters — the horizontal axis represents the controller value and the vertical axis represents amplitude.

● Curve

≤ *-16 ... 16.*

Determines the relationship between the controller value and amplitude. When set to “0” the relationship is linear. That is, a change in the controller value produces a corresponding change in amplitude. As the curve value increases the lower end of the controller range has relatively little effect on the sound while higher controller values produce more dramatic changes. Negative curve values have the opposite effect: the sound changes dramatically at low controller values while higher values produce relatively little effect. The “Curve” setting is reflected in the graph to the right of the parameters — the horizontal axis represents the controller value and the vertical axis represents amplitude.

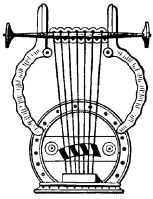

7: Scream



- The **[F6]** and **[F7]** buttons (“Bpa9” and “Fpa9”) can be used to go directly backward or forward to the next Element Controller page without having to return to the directory.

● Controller

≤ *off, Modulation Wheel ... Touch EG (124 settings).*

The “Scream” parameter drives the entire system into chaotic oscillation, creating effects that can only be achieved with physical modeling technology. The “Controller” parameter specifies the controller to be used for scream control. When set to “off” no scream effect variation can be produced, but an absolute scream value can be set via the “Value” parameter, below.

● Depth

≤ *-127 ... 127.*

Sets the amount of variation produced by the controller assigned to scream. The higher the value the greater the variation. Positive values cause an increase in scream effect in response to higher controller values (e.g. increased breath pressure or higher modulation wheel position), while minus values cause a decrease in scream effect in response to higher controller values. The “Depth” setting is reflected in the graph to the right of the parameters — the horizontal axis represents the controller value and the vertical axis represents scream.

● Curve

≤ *-16 ... 16.*

Determines the relationship between the controller value and scream. When set to “0” the relationship is linear. That is, a change in the controller value produces a corresponding change in scream effect. As the curve value increases the lower end of the controller range has relatively little effect on the sound while higher controller values produce more dramatic changes. Negative curve values have the opposite effect: the sound changes dramatically at low controller values while higher values produce relatively little effect. The “Curve” setting is reflected in the graph to the right of the parameters — the horizontal axis represents the controller value and the vertical axis represents scream.

● Value

≤ *0 ... 127.*

Determines the amount of scream effect produced when the “Controller” parameter is set to “off”. The higher the value the greater the effect.



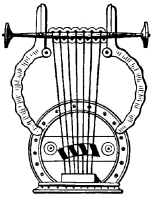

8: Breath Noise

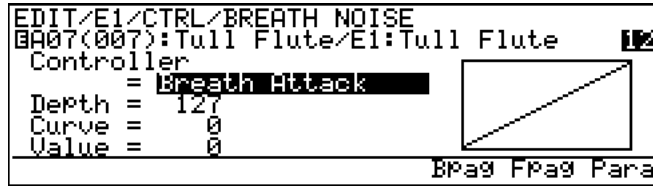

- The **[F6]** and **[F7]** buttons (“Bpa9” and “Fpa9”) can be used to go directly backward or forward to the next Element Controller page without having to return to the directory.
- The **[F8]** button (“Para”) can be used to go directly to the Breath Noise parameter page (≥ Page 86), also available from the ELEMENT MISCELLANEOUS directory. You can then return to the controller Breath Noise page by pressing **[F8]** (“Ctrl”) again.

● Controller

≤ *off, Modulation Wheel ... Touch EG (124 settings).*

The “Breath Noise” parameter can be used to add the required amount of breath noise to a voice. The sound of the breath noise itself can be varied over a wide range using the Breath Noise parameters — accessible from this page by pressing the **[F8]** button, or from the ELEMENT MISCELLANEOUS directory. The “Controller” parameter specifies the controller to be used for breath noise control. When set to “off” no breath noise variation can be produced, but an absolute breath noise value can be set via the “Value” parameter, below.

● Depth

≤ *-127 ... 127.*

Sets the amount of variation produced by the controller assigned to breath noise. The higher the value the greater the variation. Positive values cause an increase in breath noise in response to higher controller values (e.g. increased breath pressure or higher modulation wheel position), while minus values cause a decrease in breath noise in response to higher controller values. The “Depth” setting is reflected in the graph to the right of the parameters — the horizontal axis represents the controller value and the vertical axis represents breath noise.

● Curve

≤ *-16 ... 16.*

Determines the relationship between the controller value and breath noise. When set to “0” the relationship is linear. That is, a change in the controller value produces a corresponding change in breath noise. As the curve value increases the lower end of the controller range has relatively little effect on the sound while higher controller values produce more dramatic changes. Negative curve values have the opposite effect: the sound changes dramatically at low controller values while higher values produce rela-

tively little effect. The “Curve” setting is reflected in the graph to the right of the parameters — the horizontal axis represents the controller value and the vertical axis represents breath noise.

● Value

≤ 0 ... 127.

Determines the amount of breath noise produced when the “Controller” parameter is set to “off”. The higher the value the greater the effect.

- No breath noise can be applied via any controller if the ELEMENT MISCELLANEOUS Breath Noise page “Level” parameter is set to “0” or the “Control Balance” parameter is set to “63” (≥ Page 86).

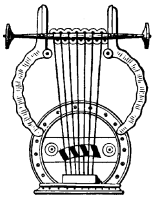

9: Growl

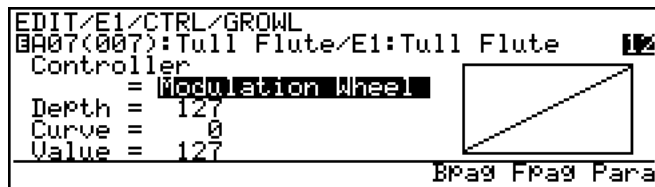

- The **F6** and **F7** buttons (“Bpag” and “Fpag”) can be used to go directly backward or forward to the next Element Controller page without having to return to the directory.
- The **F8** button (“Para”) can be used to go directly to the Growl parameter page (≥ Page 141), also available from the ELEMENT ENVELOPE directory. You can then return to the controller Growl page by pressing **F8** (“Ctrl”) again.

● Controller

≤ *off, Modulation Wheel ... Touch EG (124 settings).*

The “Growl” parameter produces a periodic pressure modulation which produces the “growl” effect often heard in wind instruments. An extensive range of parameters allow remarkably realistic effects. The “Controller” parameter specifies the controller to be used for growl control. When set to “off” no growl variation can be produced, but an absolute growl value can be set via the “Value” parameter, below.

● Depth

≤ -127 ... 127.

Sets the amount of variation produced by the controller assigned to growl. The higher the value the greater the variation. Positive values cause an increase in growl



effect in response to higher controller values (e.g. increased breath pressure or higher modulation wheel position), while minus values cause a decrease in growl effect in response to higher controller values. The “Depth” setting is reflected in the graph to the right of the parameters — the horizontal axis represents the controller value and the vertical axis represents growl.

● **Curve**

≤ -16 ... 16.

Determines the relationship between the controller value and growl. When set to “0” the relationship is linear. That is, a change in the controller value produces a corresponding change in growl. As the curve value increases the lower end of the controller range has relatively little effect on the sound while higher controller values produce more dramatic changes. Negative curve values have the opposite effect: the sound changes dramatically at low controller values while higher values produce relatively little effect. The “Curve” setting is reflected in the graph to the right of the parameters — the horizontal axis represents the controller value and the vertical axis represents growl.

● **Value**

≤ 0 ... 127.

Determines the amount of growl effect produced when the “Controller” parameter is set to “off”. The higher the value the greater the effect.

- No growl effect can be applied via any controller if the ELEMENT ENVELOPE Growl page “Depth to Pres” and “Depth to BNoise” parameter are set to “0” or the “Offset” parameter is set to “63” (≥ Page 141).

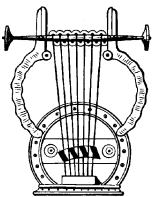

10: Throat Formant



- The **F6** and **F7** buttons (“Bpag” and “Fpag”) can be used to go directly backward or forward to the next Element Controller page without having to return to the directory.
- The **F8** button (“Para”) can be used to go directly to the Throat Formant parameter page (≥ Page 91), also available from the ELEMENT MISCELLANEOUS directory. You can then return to the controller Throat Formant page by pressing **F8** (“Ctrl”) again.

● Controller

\leq *off, Modulation Wheel ... Touch EG (124 settings).*

The “Throat Formant” parameter controls the characteristics of the simulated player’s lungs, trachea, and oral cavity. Can add a realistic “roughness” to the sound. The “Controller” parameter specifies the controller to be used for throat formant control. When set to “off” no throat formant variation can be produced, but an absolute throat formant value can be set via the “Value” parameter, below.

● Depth

\leq *-127 ... 127.*

Sets the amount of variation produced by the controller assigned to throat formant. The higher the value the greater the variation. Positive values cause an increase in throat formant effect in response to higher controller values (e.g. increased breath pressure or higher modulation wheel position), while minus values cause a decrease in throat formant effect in response to higher controller values. The “Depth” setting is reflected in the graph to the right of the parameters — the horizontal axis represents the controller value and the vertical axis represents throat formant depth.

● Curve

\leq *-16 ... 16.*

Determines the relationship between the controller value and throat formant depth. When set to “0” the relationship is linear. That is, a change in the controller value produces a corresponding change in throat formant depth. As the curve value increases the lower end of the controller range has relatively little effect on the sound while higher controller values produce more dramatic changes. Negative curve values have the opposite effect: the sound changes dramatically at low controller values while higher values produce relatively little effect. The “Curve” setting is reflected in the graph to the right of the parameters — the horizontal axis represents the controller value and the vertical axis represents throat formant depth.

● Value

\leq *0 ... 127.*

Determines the amount of throat formant effect produced when the “Controller” parameter is set to “off”. The higher the value the greater the effect.

- No throat formant effect can be applied via any controller if the ELEMENT MISCELLANEOUS Throat Formant page “Amount” or “Intensity” parameters are set to “0” (\geq Page 91, 92).



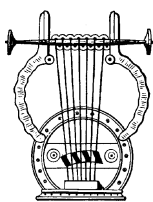

11: Dynamic Filter



- The **[F6]** and **[F7]** buttons (“Bpāg” and “Fpāg”) can be used to go directly backward or forward to the next Element Controller page without having to return to the directory.
- The **[F8]** button (“Para”) can be used to go directly to the Dynamic Filter parameter page (≥ Page 115), also available from the ELEMENT MODIFIER directory. You can then return to the controller Dynamic Filter page by pressing **[F8]** (“Ctrl”) again.

● Controller

≤ *off, Modulation Wheel ... Touch EG (124 settings).*

The VL1-m dynamic filter has selectable high-pass, bandpass, band elimination, and low-pass modes. The “Controller” parameter specifies the controller to be used for filter cutoff frequency control. When set to “off” no filter frequency variation can be applied via a controller.

- The actual dynamic filter frequency value applied to the VL1-m tone generator is a mix of the value from the controller, the value from the Dynamic Filter parameter page, and that from the amplitude & filter envelope (≥ Page 143).

● Depth

≤ *-127 ... 127.*

Sets the amount of variation produced by the controller assigned to dynamic filter. The higher the value the greater the variation. Positive values cause an increase in filter cutoff frequency in response to higher controller values (e.g. increased breath pressure or higher modulation wheel position), while minus values cause a decrease in filter cutoff frequency in response to higher controller values. The “Depth” setting is reflected in the graph to the right of the parameters — the horizontal axis represents the controller value and the vertical axis represents filter cutoff frequency.

● Curve

≤ *-16 ... 16.*

Determines the relationship between the controller value and dynamic filter cutoff frequency. When set to “0” the relationship is linear. That is, a change in the controller value produces a corresponding change in frequency. As the curve value increases the lower end of the controller range has relatively little effect on the sound while higher controller values produce more dramatic changes. Negative curve values have the oppo-

site effect: the sound changes dramatically at low controller values while higher values produce relatively little effect. The “Curve” setting is reflected in the graph to the right of the parameters — the horizontal axis represents the controller value and the vertical axis represents filter cutoff frequency.

- No dynamic filter frequency variation can be applied via any controller if the ELEMENT MODIFIER Dynamic Filter page “Balance” parameter is set to “-64” (≥ Page 116).

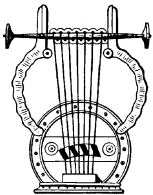

12: Harmonic Enhancer

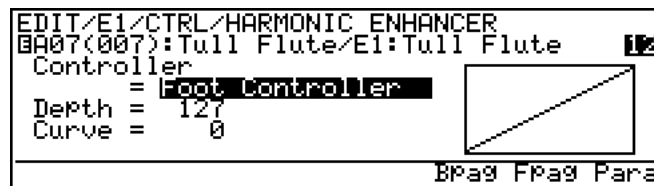

- The **F6** and **F7** buttons (“Bpag” and “Fpag”) can be used to go directly backward or forward to the next Element Controller page without having to return to the directory.
- The **F8** button (“Para”) can be used to go directly to the Harmonic Enhancer parameter page (≥ Page 107), also available from the ELEMENT MODIFIER directory. You can then return to the controller Harmonic Enhancer page by pressing **F8** (“Ctrl”) again.

● Controller

≤ off, Modulation Wheel ... Touch EG (124 settings).

The Harmonic Enhancer can vary the harmonic structure of the sound over a wide range. The “Controller” parameter specifies the controller to be used for harmonic enhancer depth (wet/dry balance) control. When set to “off” no harmonic enhancer depth variation can be applied via a controller.

● Depth

≤ -127 ... 127.

Sets the amount of variation produced by the controller assigned to the harmonic enhancer. The higher the value the greater the variation. Positive values cause an increase in harmonic enhancer depth in response to higher controller values (e.g. increased breath pressure or higher modulation wheel position), while minus values cause a decrease in harmonic enhancer depth in response to higher controller values. The “Depth” setting is reflected in the graph to the right of the parameters — the horizontal axis represents the controller value and the vertical axis represents harmonic enhancer depth.



● Curve

≤ -16 ... 16.

Determines the relationship between the controller value and harmonic enhancer depth. When set to “0” the relationship is linear. That is, a change in the controller value produces a corresponding change in harmonic enhancer depth. As the curve value increases the lower end of the controller range has relatively little effect on the sound while higher controller values produce more dramatic changes. Negative curve values have the opposite effect: the sound changes dramatically at low controller values while higher values produce relatively little effect. The “Curve” setting is reflected in the graph to the right of the parameters — the horizontal axis represents the controller value and the vertical axis represents harmonic enhancer depth.

- No harmonic enhancer variation can be applied via any controller if the ELEMENT MODIFIER Harmonic Enhancer page “Balance” parameter is set to “-64” (≥ Page 108).



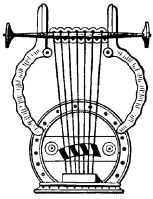

13: Damping



- The **[F6]** and **[F7]** buttons (“BPa9” and “FPa9”) can be used to go directly backward or forward to the next Element Controller page without having to return to the directory.

● Controller

≤ *off, Modulation Wheel ... Touch EG (124 settings).*

Simulates the effect of damping due to losses within the body of a wind instrument or in a string due to air friction. Affects both pitch and timbre. The “Controller” parameter specifies the controller to be used for damping control. When set to “off” no damping variation can be applied via a controller.

- Please note that accurate keyboard pitch is produced only when damping is maximum.

● Depth

≤ *-127 ... 127.*

Sets the amount of variation produced by the controller assigned to damping. The higher the value the greater the variation. Positive values cause a decrease in damping in response to higher controller values (e.g. increased breath pressure or higher modulation wheel position), while minus values cause an increase in damping in response to higher controller values. The “Depth” setting is reflected in the graph to the right of the parameters — the horizontal axis represents the controller value and the vertical axis represents damping.

● Curve

≤ *-16 ... 16.*

Determines the relationship between the controller value and damping. When set to “0” the relationship is linear. That is, a change in the controller value produces a corresponding change in damping. As the curve value increases the lower end of the controller range has relatively little effect on the sound while higher controller values produce more dramatic changes. Negative curve values have the opposite effect: the sound changes dramatically at low controller values while higher values produce relatively little effect. The “Curve” setting is reflected in the graph to the right of the parameters — the horizontal axis represents the controller value and the vertical axis represents damping.



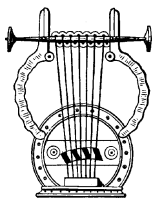

14: Absorption

```

EDIT/E1/CTRL/ABSORPTION
BA07(007):Tull Flute/E1:Tull Flute
Controller
  = Breath Controller
Depth = 15
Curve = -16
  
```

- The **F6** button (“Bpag”) can be used to go directly back to the next Element Controller page without having to return to the directory.

● Controller

≤ *off, Modulation Wheel ... Touch EG (124 settings).*

The absorption parameter simulates the effect of high-frequency loss at the end of the air column or string. The “Controller” parameter specifies the controller to be used for absorption control. When set to “off” no absorption variation can be applied via a controller.

- Please note that accurate keyboard pitch is produced only at when absorption is maximum.

● Depth

≤ *-127 ... 127.*

Sets the amount of variation produced by the controller assigned to absorption. The higher the value the greater the variation. Positive values cause a decrease in absorption in response to higher controller values (e.g. increased breath pressure or higher modulation wheel position), while minus values cause an increase in absorption in response to higher controller values. The “Depth” setting is reflected in the graph to the right of the parameters — the horizontal axis represents the controller value and the vertical axis represents absorption.

● Curve

≤ *-16 ... 16.*

Determines the relationship between the controller value and absorption. When set to “0” the relationship is linear. That is, a change in the controller value produces a corresponding change in absorption. As the curve value increases the lower end of the controller range has relatively little effect on the sound while higher controller values produce more dramatic changes. Negative curve values have the opposite effect: the sound changes dramatically at low controller values while higher values produce relatively little effect. The “Curve” setting is reflected in the graph to the right of the parameters — the horizontal axis represents the controller value and the vertical axis represents absorption.

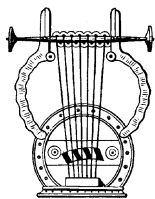

Controller Search & Replace

This function is accessed by pressing the **F8** button (“S&R”) from the element controller directory page. It provides a fast, convenient way to see which controllers are assigned to which parameters, and to modify the assignments as required.

```

EDIT/E1
0A07(007):Tull Flute/E1:Tull Flute
<Controller>
0:Presser 05:Thwain9 08:Growl 13:Dampin9
02:Embochr 06:Amplitd 10:Throat 14:Absrptn
03:Pitch 07:Scream 11:D.Filtr
04:Vibrato 09:B.Noise 12:H.Ehnc
Ctrl Misc Modi Env S&R
    
```

1. Select the Controller Search & Replace Window

From the element controller directory page, press **F8**.

2. Select a Controller

When the “CONTROLLER SEARCH & REPLACE” window appears, use the **F6** and **F7** buttons (“Prev” and “Next”) to search through the assigned controllers (unassigned controllers are not displayed). All parameters assigned to the selected controller are displayed below the controller name (or number).

- In this example, only the Growl parameter is assigned to the Modulation Wheel:

```

EDIT/E1
0A CONTROLLER SEARCH & REPLACE
<C Ctrl. Source = Modulation Wheel
01 Growl
02
03
04
05 Prev Next
    
```

- In the following example both Pitch and Scream are assigned to the Pitch bend wheel.

```

EDIT/E1
0A CONTROLLER SEARCH & REPLACE
<C Ctrl. Source = Pitch Bend
01 Pitch Scream
02
03
04
05 Prev Next
    
```

3. Make a New Assignment As Required

You can assign a different controller to the parameters shown by using the data dial or **DEC** and **INC** buttons — without cancelling the original assignments. When a different controller is selected the controller name will flash and any other parameters assigned to that controller will appear in non-highlighted text.

- Here, for example, the Pitch Bend controller shown in the previous example has been replaced with the Velocity controller, which is current is assigned to the Amplitude.



Element Miscellaneous

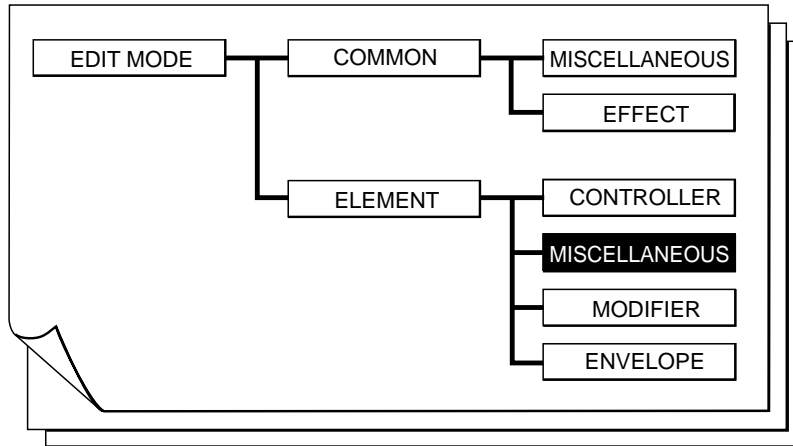

■ 1: Setting	85	■ 4: Mixing	98
■ 2: Breath Noise	86	● 4-1: Mixing Driver Output Key Scaling	100
● 2-1: Breath Noise Level Key Scaling	88	● 4-2: Mixing Pipe/String Output Key Scaling ..	101
● 2-2: Breath Noise HPF Key Scaling	89	● 4-3: Mixing Tap Output Key Scaling	102
● 2-3: Breath Noise LPF Key Scaling	90	● 4-4: Mixing Tap Location Key Scaling	103
■ 3: Throat Formant	91	■ 5: Amplitude	104
● 3-1: Throat Formant Pitch Key Scaling	93	● 5-1: Amplitude Level Key Scaling	104
● 3-2: Throat Formant Amount Key Scaling	94		
● 3-3: Throat Formant Intensity Key Scaling	95		
● 3-4: Throat Formant HPF Key Scaling	96		
● 3-5: Throat Formant LPF Key Scaling	97		

```

EDIT/E1
A07(007):Tull Flute/E1:Tull Flute
<Miscellaneous>
1:Setting 5:Amplitude
2:Breath Noise
3:Throat Formant
4:Mixing
Ctrl Misc Modi Env
    
```

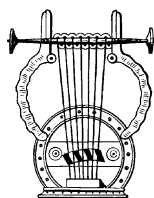
1: Setting

```

EDIT/E1/MISC/SETTING
BA07(007):Tull Flute/E1:Tull Flute
Trigger Mode      = Single
Xfade Speed      = 1.33msec
Interpolate Speed = 0.20msec
    
```

● Trigger Mode

≤ *Single, Multi.*

Determines how the attack portion of the sound will be triggered.

Single	If a note is played on the keyboard, then a subsequent note or notes are played while the first is still held, no attack is produced.
Multi	The attack is always reproduced regardless of whether a previous note is held or not.

- The “Single” setting makes it easy to produce the “hammering on” and “pulling off” type effects used by guitar players, for example.

● Xfade Speed

≤ *Fastest, 0.09msec ... 390msec.*

Simulates the naturally slow note-to-note transitions of acoustic instruments. The slight “slur” that occurs between notes on wind instruments with tone holes is one example. The “Fastest” setting produces the fastest, most synthesizer-like transition between subsequently-played notes. The higher the value, the longer the transition. Normally, as setting somewhere between 1 and 2 milliseconds produces the most natural sound.

● Interpolate Speed

≤ *Fastest, 0.09msec ... 6.35msec.*

Determines the response time of the VL1-m to control changes — Pressure, Embouchure, etc. The higher the value the slower the response (e.g. the slower the attack when pressure is applied). Normally, as setting somewhere between 1 and 2 milliseconds produces the most natural sound. Decay-type voices sound best a somewhat shorter value.

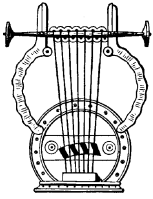

2: Breath Noise

```

EDIT/E1/MISC/BREATH NOISE
@A07(007):Tull Flute/E1:Tull Flute
Level = 123 Slit Drive = 28
Ctrl Balance = 29 Ctrl = Slit
HPF Cutoff Frq = 3.84 kHz
LPF Cutoff Frq = 24.0 kHz
Key On Reset = off
KSC Ctrl
    
```

- The **[F8]** button (“Ctrl”) can be used to go directly to the breath noise controller page (≥ Page 73), also available from the ELEMENT CONTROLLER directory. You can then return to the miscellaneous breath noise page by pressing **[F8]** (“Para”) again.
- An inverse “K”(**[K]**) next to a value means that key scaling can be applied to that parameter. Position the cursor at the appropriate parameter and then press the **[F7]** button (“KSC”) to go directly to the key scaling page for that parameter. You can return to the breath noise parameter page by pressing the **[EXIT]** button.

● Level

≤ 0 ... 127.

Sets the level (volume) of the breath noise sound. The higher the value the higher the level.

- If this parameter is set to “0”, no breath noise can be applied via a controller.

● Slit Drive

≤ 0 ... 32.

Breath noise is produced at the “slit” portion of the VL1-m’s physical model (in a reed instrument, the space between the reed and the mouthpiece). This parameter determines the intensity of the breath noise. The smaller the value the more intense and rough the breath noise.

- If this parameter is set to “63”, no breath noise can be applied via a controller.

● Ctrl Balance

≤ -64 ... 63.

Sets the balance between two factors that determine the overall level of the breath noise: “Ctrl” is the amount of control applied via the controller assigned to breath noise, and “Slit” is the amount of breath noise produced by the slit. The graphic slider to the right of the parameter provides a visual indication of the current balance.



● HPF Cutoff Frq

≤ 31.1 Hz ... 21.6 kHz.

Sets the cutoff frequency of the breath noise high-pass filter. Noise components *below* the specified frequency are cut off.

● LPF Cutoff Frq

≤ 31.1 Hz ... 24.0 kHz.

Sets the cutoff frequency of the breath noise low-pass filter. Noise components *above* the specified frequency are cut off.

- Virtually no breath noise sound will be produced if the high-pass filter is set to a higher cutoff frequency than the low-pass filter.

● Key On Reset

≤ off, on.

Determines the feel of the breath noise attack.

off	The noise generator is not reset for each note, result in a different, and therefore natural, attack feel for each note played.
on	The noise generator is reset for each note, resulting in the same breath noise attack feel for each note played.



2-1: Breath Noise Level Key Scaling

Breath noise level key scaling produces natural breath noise level variations across the range of the keyboard by allowing different level offset values to be applied to each of six breakpoints set at appropriate keys.

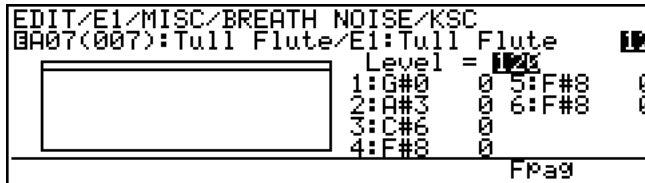

- The **[F7]** button (“Fpag”) can be used to go directly the next breath noise key scaling page without having to return to the main parameter page.

● Level

≤ 0 ... 127.

The “Level” parameter is linked to the main breath noise “Level” parameter, and sets the level (volume) of the breath noise sound. The higher the value the higher the level. This value also determines the main level on which all key-scaled variations are based (indicated by a dotted line on the graph).

● Breakpoint 1 ... 6 Key

≤ C-2 ... G8.

Allows six separate key scaling breakpoints to be set at any notes between C-2 and G8. You can position the cursor at the appropriate breakpoint key parameter and use any of the normal data entry procedures, or use a keyboard. To use a keyboard for breakpoint entry, position the cursor at the appropriate breakpoint key parameter, press the **[F8]** button (“Kbd”), and then press the key at which you want to set the breakpoint while “Kbd” appears in inverse characters.

No breakpoint can be set to a key lower than the breakpoint to its left.

● Breakpoint 1 ... 6 Offset

≤ -64 ... 63.

Set the amount of level offset for each of the breakpoints defined by the breakpoint key parameters, above. Negative values reduce the level, and positive values increase the level at the corresponding breakpoint. No matter what offset value is chosen, the actual level will never exceed its minimum or maximum absolute value. When different offset values are applied to adjacent breakpoints, the level varies smoothly between the breakpoints.

NOTES

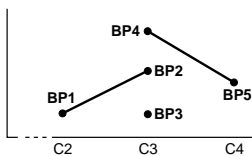

■ If two breakpoints are set to the same note, the lower one functions as the end of the key scaling segment connecting to the next lowest breakpoint while the higher one functions as the end of the segment connecting to the next highest breakpoint. Further, the higher breakpoint applies to the specified note while the lower one actually applies to the next note to its left. If more than two breakpoints are set to the same note, only the lowest and highest of these will function as ends of the corresponding key scaling segments while the rest are ignored.

2-2: Breath Noise HPF Key Scalling

Breath noise HPF key scalling produces natural breath noise tone variations across the range of the keyboard by allowing different cutoff frequency offset values to be applied to each of two breakpoints set at appropriate keys.

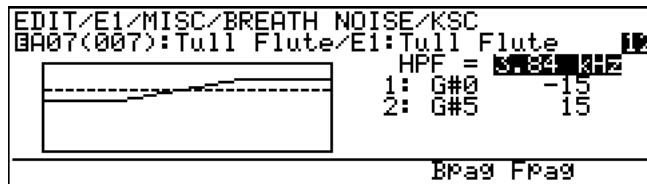

- The **[F6]** and **[F7]** buttons (“Bpag” and “Fpag”) can be used to go directly backward or forward to the next breath noise key scalling page without having to return to the main parameter page.

● HPF

≤ 31.1 Hz ... 21.6 kHz.

The “HPF” parameter is linked to the main breath noise “HPF Cutoff Frq” parameter, and sets the cutoff frequency of the breath noise high-pass filter. Noise components *below* the specified frequency are cut off. This value also determines the main cutoff frequency on which all key-scaled variations are based (indicated by a dotted line on the graph).

● Breakpoint 1 & 2 Key

≤ C-2 ... G8.

Allows two separate key scalling breakpoints to be set at any notes between C-2 and G8. You can position the cursor at the appropriate breakpoint key parameter and use any of the normal data entry procedures, or use a keyboard. To use a keyboard for breakpoint entry, position the cursor at the appropriate breakpoint key parameter, press the **[F8]** button (“Kbd”), and then press the key at which you want to set the breakpoint while “Kbd” appears in inverse characters.

No breakpoint can be set to a key lower than the breakpoint to its left.

● Breakpoint 1 & 2 Offset

≤ -64 ... 63.

Set the amount of cutoff frequency offset for each of the breakpoints defined by the breakpoint key parameters, above. Negative values lower the cutoff frequency, and positive values raise the cutoff frequency at the corresponding breakpoint. No matter what offset value is chosen, the actual cutoff frequency will never exceed its minimum or maximum absolute value. When different offset values are applied to adjacent breakpoints, the cutoff frequency varies smoothly between the breakpoints.

2-3: Breath Noise LPF Key Scalling

Breath noise LPF key scalling produces natural breath noise tone variations across the range of the keyboard by allowing different cutoff frequency offset values to be applied to each of two breakpoints set at appropriate keys.

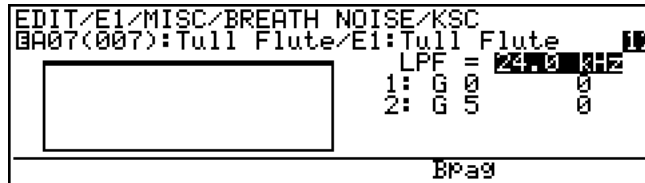

- The **[F6]** button (“Bpag”) can be used to go directly back to the next breath noise key scalling page without having to return to the main parameter page.

● LPF

≤ 31.1 Hz ... 24.0 kHz.

The “LPF” parameter is linked to the main breath noise “LPF Cutoff Frq” parameter, and sets the cutoff frequency of the breath noise low-pass filter. Noise components *above* the specified frequency are cut off. This value also determines the main cutoff frequency on which all key-scaled variations are based (indicated by a dotted line on the graph).

● Breakpoint 1 & 2 Key

≤ C-2 ... G8.

Allows two separate key scalling breakpoints to be set at any notes between C-2 and G8. You can position the cursor at the appropriate breakpoint key parameter and use any of the normal data entry procedures, or use a keyboard. To use a keyboard for breakpoint entry, position the cursor at the appropriate breakpoint key parameter, press the **[F8]** button (“Kbd”), and then press the key at which you want to set the breakpoint while “Kbd” appears in inverse characters.

No breakpoint can be set to a key lower than the breakpoint to its left.

● Breakpoint 1 & 2 Offset

≤ -64 ... 63.

Set the amount of cutoff frequency offset for each of the breakpoints defined by the breakpoint key parameters, above. Negative values lower the cutoff frequency, and positive values raise the cutoff frequency at the corresponding breakpoint. No matter what offset value is chosen, the actual cutoff frequency will never exceed its minimum or maximum absolute value. When different offset values are applied to adjacent breakpoints, the cutoff frequency varies smoothly between the breakpoints.

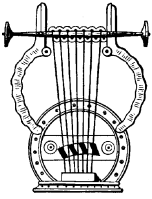

3: Throat Formant

```

EDIT/E1/MISC/THROAT FORMANT
0A07(007):Tull Flute/E1:Tull Flute
Pitch Tracking = KeyTrack
Pitch          = 1.66oct
Amount        = 00    Intens = 111
HPF Cutoff Freq = 98.3 Hz
LPF Cutoff Freq = 4.05 kHz
Ctrl
    
```

- The **[F8]** button (“Ctrl”) can be used to go directly to the throat formant controller page (≥ Page 75), also available from the ELEMENT CONTROLLER directory. You can then return to the miscellaneous throat formant page by pressing **[F8]** (“Para”) again.
- An inverse “K”(**[K]**) next to a value means that key scaling can be applied to that parameter. Position the cursor at the appropriate parameter and then press the **[F7]** button (“KSC”) to go directly to the key scaling page for that parameter. You can return to the throat formant parameter page by pressing the **[EXIT]** button.

● Pitch Tracking

≤ Fixed, KeyTrack.

Determines whether the throat formant pitch is fixed or tracks the notes played.

Fixed	The throat formant is fixed at the pitch specified by the “Pitch” parameter, below.
KeyTrack	The pitch of the throat formant tracks the note(s) played, offset by the amount specified by the “Pitch” parameter, below.

● Pitch

≤ 23.1 Hz ... 48.0 kHz (when “Fixed” and “Intens” ≥ 0).

≤ 11.4 Hz ... 24.0 kHz (when “Fixed” and “Intens” < 0).

≤ -2.00oct ... 1.98oct (when “KeyTrack”).

When the “Pitch Tracking” parameter is set to “Fixed”, this parameter sets the throat formant pitch to a specific frequency. When “Pitch Tracking” is set to “KeyTrack”, however, this parameter determines how much the throat formant pitch is offset from the pitch of the note played in octave units. In the latter case negative values offset the throat formant pitch *below* the pitch of the note played, while positive values offset the throat formant pitch *above* that of the note played.

● Amount

≤ -64 ... 63.

Determines the amount of effect the throat formant sound has on the air velocity within the instrument. Positive values increase the air velocity, thereby increasing the throat formant effect. Minus values decrease the air velocity, producing a more subtle throat formant effect.

- If this parameter is set to “0”, no throat formant effect can be applied via a controller.

● **Intens**

≤ -127 ... 127.

Sets the intensity of the throat formant effect. Higher values in both the positive and negative ranges increase the intensity of the throat formant effect.

- If this parameter is set to “0”, no throat formant effect can be applied via a controller.

● **HPF Cutoff Frq**

≤ 31.1 Hz ... 21.6 kHz.

Sets the cutoff frequency of the throat formant high-pass filter. Noise components *below* the specified frequency are cut off.

● **LPF Cutoff Frq**

≤ 31.1 Hz ... 24.0 kHz.

Sets the cutoff frequency of the throat formant low-pass filter. Noise components *above* the specified frequency are cut off.

- Virtually no throat formant sound will be produced if the high-pass filter is set to a higher cutoff frequency than the low-pass filter.



3-1: Throat Formant Pitch Key Scaling

Throat formant pitch key scaling produces natural throat formant pitch variations across the range of the keyboard by allowing different pitch offset values to be applied to each of four breakpoints set at appropriate keys.

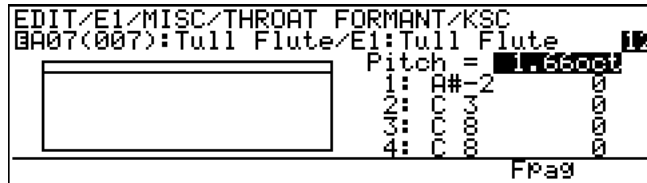

- The **[F7]** button (“Fpag”) can be used to go directly the next throat formant key scaling page without having to return to the main parameter page.

● Pitch

- ≤ 23.1 Hz ... 48.0 kHz (when “Fixed” and “Intens” ≥ 0).
- ≤ 11.4 Hz ... 24.0 kHz (when “Fixed” and “Intens” < 0).
- ≤ -2.00oct ... 1.98oct (when “KeyTrack”).

The “Pitch” parameter is linked to the main throat formant “Pitch” parameter, and has the same effect. When the “Pitch Tracking” parameter is set to “Fixed”, this parameter sets the throat formant pitch to a specific frequency. When “Pitch Tracking” is set to “KeyTrack”, however, this parameter determines how much the throat formant pitch is offset from the pitch of the key played in octave units. In the latter case negative values offset the throat formant pitch *below* the pitch of the key played, while positive values offset the throat formant pitch *above* that of the key played. This value also determines the main pitch on which all key-scaled variations are based (indicated by a dotted line on the graph).

● Breakpoint 1 ... 4 Key

- ≤ C-2 ... G8.

Allows four separate key scaling breakpoints to be set at any notes between C-2 and G8. You can position the cursor at the appropriate breakpoint key parameter and use any of the normal data entry procedures, or use a keyboard. To use a keyboard for breakpoint entry, position the cursor at the appropriate breakpoint key parameter, press the **[F8]** button (“Kbd”), and then press the key at which you want to set the breakpoint while “Kbd” appears in inverse characters.

No breakpoint can be set to a key lower than the breakpoint to its left.

● Breakpoint 1 ... 4 Offset

- ≤ -127 ... 127.

Set the amount of pitch offset for each of the breakpoints defined by the breakpoint key parameters, above. Negative values lower the pitch, and positive values raise the pitch at the corresponding breakpoint. No matter what offset value is chosen, the actual pitch will never exceed its minimum or maximum absolute value. When different offset values are applied to adjacent breakpoints, the pitch varies smoothly between the breakpoints.

3-2: Throat Formant Amount Key Scaling

Throat formant amount key scaling produces natural throat formant variations across the range of the keyboard by allowing different amount offset values to be applied to each of four breakpoints set at appropriate keys.

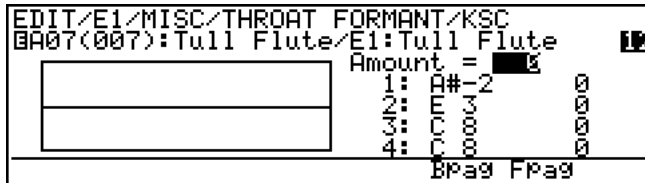

- The **[F6]** and **[F7]** buttons (“Bpag” and “Fpag”) can be used to go directly backward or forward to the next throat formant key scaling page without having to return to the main parameter page.

● Amount

≤ -64 ... 63.

The “Amount” parameter is linked to the main throat formant “Amount” parameter, and determines the amount of effect the throat formant sound has on the air velocity within the instrument. Positive values increase the air velocity, thereby increasing the throat formant effect. Minus values decrease the air velocity, producing a more subtle throat formant effect.

This value also determines the main amount value on which all key-scaled variations are based (indicated by a dotted line on the graph).

● Breakpoint 1 ... 4 Key

≤ C-2 ... G8.

Allows four separate key scaling breakpoints to be set at any notes between C-2 and G8. You can position the cursor at the appropriate breakpoint key parameter and use any of the normal data entry procedures, or use a keyboard. To use a keyboard for breakpoint entry, position the cursor at the appropriate breakpoint key parameter, press the **[F8]** button (“Kbd”), and then press the key at which you want to set the breakpoint while “Kbd” appears in inverse characters.

No breakpoint can be set to a key lower than the breakpoint to its left.

● Breakpoint 1 ... 4 Offset

≤ -64 ... 63.

Set the amount offset for each of the breakpoints defined by the breakpoint key parameters, above. Negative values reduce the amount, and positive values increase the amount at the corresponding breakpoint. No matter what offset value is chosen, the actual amount will never exceed its minimum or maximum absolute value. When different offset values are applied to adjacent breakpoints, the amount varies smoothly between the breakpoints.

3-3: Throat Formant Intensity Key Scaling

Throat formant intensity key scaling produces natural throat formant intensity variations across the range of the keyboard by allowing different intensity offset values to be applied to each of four breakpoints set at appropriate keys.

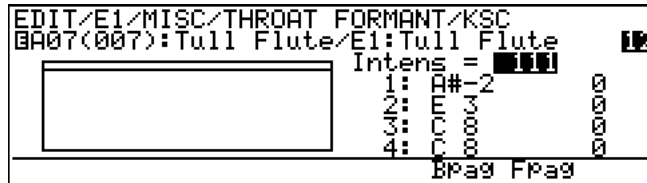

- The **F6** and **F7** buttons (“Bpag” and “Fpag”) can be used to go directly backward or forward to the next throat formant key scaling page without having to return to the main parameter page.

● Intens

≤ -127 ... 127.

The “Intens” parameter is linked to the main throat formant “Intens” parameter, and sets the intensity of the throat formant effect. Higher values in both the positive and negative ranges increase the intensity of the throat formant effect. This value also determines the main intensity value on which all key-scaled variations are based (indicated by a dotted line on the graph).

● Breakpoint 1 ... 4 Key

≤ C-2 ... G8.

Allows four separate key scaling breakpoints to be set at any notes between C-2 and G8. You can position the cursor at the appropriate breakpoint key parameter and use any of the normal data entry procedures, or use a keyboard. To use a keyboard for breakpoint entry, position the cursor at the appropriate breakpoint key parameter, press the **F8** button (“Kbd”), and then press the key at which you want to set the breakpoint while “Kbd” appears in inverse characters.

No breakpoint can be set to a key lower than the breakpoint to its left.

● Breakpoint 1 ... 4 Offset

≤ -127 ... 127.

Set the amount of intensity offset for each of the breakpoints defined by the breakpoint key parameters, above. Negative values reduce the intensity, and positive values increase the intensity at the corresponding breakpoint. No matter what offset value is chosen, the actual intensity will never exceed its minimum or maximum absolute value. When different offset values are applied to adjacent breakpoints, the intensity varies smoothly between the breakpoints.



3-4: Throat Formant HPF Key Scalling

Throat formant HPF key scalling produces natural throat formant tone variations across the range of the keyboard by allowing different cutoff frequency offset values to be applied to each of three breakpoints set at appropriate keys.

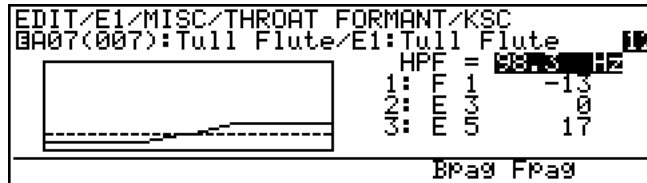

- The **[F6]** and **[F7]** buttons (“Bpag” and “Fpag”) can be used to go directly backward or forward to the next throat formant key scalling page without having to return to the main parameter page.

● HPF

≤ 31.1 Hz ... 21.6 kHz.

The “HPF” parameter is linked to the main breath noise “HPF Cutoff Frq” parameter, and sets the cutoff frequency of the throat formant high-pass filter. Components *above* the specified frequency are cut off. This value also determines the main cutoff frequency on which all key-scaled variations are based (indicated by a dotted line on the graph).

● Breakpoint 1 ... 3 Key

≤ C-2 ... G8.

Allows three separate key scalling breakpoints to be set at any notes between C-2 and G8. You can position the cursor at the appropriate breakpoint key parameter and use any of the normal data entry procedures, or use a keyboard. To use a keyboard for breakpoint entry, position the cursor at the appropriate breakpoint key parameter, press the **[F8]** button (“Kbd”), and then press the key at which you want to set the breakpoint while “Kbd” appears in inverse characters.

No breakpoint can be set to a key lower than the breakpoint to its left.

● Breakpoint 1 ... 3 Offset

≤ -64 ... 63.

Set the amount of cutoff frequency offset for each of the breakpoints defined by the breakpoint key parameters, above. Negative values lower the cutoff frequency, and positive values raise the cutoff frequency at the corresponding breakpoint. No matter what offset value is chosen, the actual cutoff frequency will never exceed its minimum or maximum absolute value. When different offset values are applied to adjacent breakpoints, the cutoff frequency varies smoothly between the breakpoints.

3-5: Throat Formant LPF Key Scaling

Throat formant LPF key scaling produces natural throat formant tone variations across the range of the keyboard by allowing different cutoff frequency offset values to be applied to each of three breakpoints set at appropriate keys.

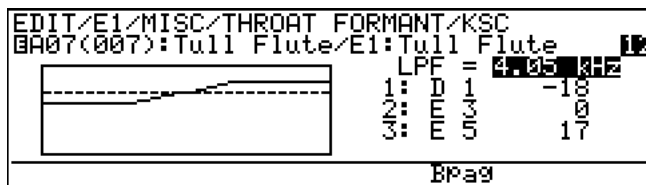

- The **[F6]** button (“BPag”) can be used to go directly back to the next throat formant key scaling page without having to return to the main parameter page.

● LPF

≤ 31.1 Hz ... 24.0 kHz.

The “LPF” parameter is linked to the main throat formant “LPF Cutoff Frq” parameter, and sets the cutoff frequency of the throat formant low-pass filter. Components *above* the specified frequency are cut off. This value also determines the main cutoff frequency on which all key-scaled variations are based (indicated by a dotted line on the graph).

● Breakpoint 1 ... 3 Key

≤ C-2 ... G8.

Allows three separate key scaling breakpoints to be set at any notes between C-2 and G8. You can position the cursor at the appropriate breakpoint key parameter and use any of the normal data entry procedures, or use a keyboard. To use a keyboard for breakpoint entry, position the cursor at the appropriate breakpoint key parameter, press the **[F8]** button (“Kbd”), and then press the key at which you want to set the breakpoint while “Kbd” appears in inverse characters.

No breakpoint can be set to a key lower than the breakpoint to its left.

● Breakpoint 1 ... 3 Offset

≤ -64 ... 63.

Set the amount of cutoff frequency offset for each of the breakpoints defined by the breakpoint key parameters, above. Negative values lower the cutoff frequency, and positive values raise the cutoff frequency at the corresponding breakpoint. No matter what offset value is chosen, the actual cutoff frequency will never exceed its minimum or maximum absolute value. When different offset values are applied to adjacent breakpoints, the cutoff frequency varies smoothly between the breakpoints.

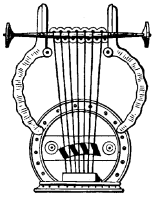

4: Mixing

```

EDIT/E1/MISC/MIXING
0A07(007):Tull Flute/E1:Tull Flute
Driver Output      = 50
Pipe/String Output = 109
Tap Output         = 00 Tap Sign = -
Tap Setting        = Driving Point
    
```

KSC

- An inverse “K” (K) next to a value means that key scaling can be applied to that parameter. Position the cursor at the appropriate parameter and then press the [F7] button (“KSC”) to go directly to the key scaling page for that parameter. You can return to the mixing parameter page by pressing the [EXIT] button.

● Driver Output

≤ 0 ... 127.

Adjusts the level of the instrument’s “driver” output. The “Driver” signal is the direct output from the mouthpiece (or bow/string interface) without the resonance of the instrument’s body. The higher the value the higher the output.

● Pipe/String Output

≤ 0 ... 127.

Adjusts the main output from the instrument’s pipe or string. The higher the value the higher the output.

● Tap Output

≤ 0 ... 127.

By “tapping” the output from a specific point along the instrument’s pipe or string and mixing that signal with the Driver and Pipe/String signals, a range of variations can be produced. This parameter adjusts the tap output. The higher the value the higher the output.

● Tap Sign

≤ -, +.

Sets the phase of the tap signal: “+” for positive or normal phase, “-” for negative or inverse phase.

● Tap Setting

≤ Variable, Driving Point.

When set to “Driving Point” the tap location is fixed at the instrument’s driving point (mouthpiece or bow/string interface). When set to “Variable” the tap location is determined by the “Tap Location” parameter, below.



● Tap Location

≤ 0 ... 99.2 %.

This parameter only appears when the “Tap Setting” parameter is set to “Variable”, and is used to set the location of the tap at an appropriate point along the instrument’s pipe or string.

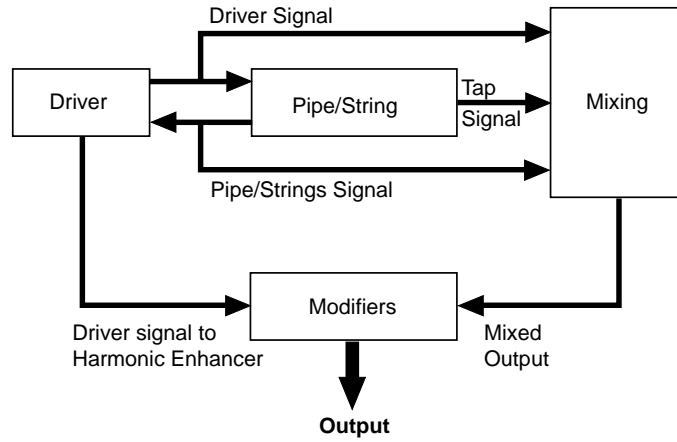

4-1: Mixing Driver Output Key Scalling

Mixing driver output key scaling produces natural timbre variations across the range of the keyboard by allowing different driver output offset values to be applied to each of six breakpoints set at appropriate keys.

```

EDIT/E1/MISC/MIXING/KSC
BA07(007):Tull Flute/E1:Tull Flute
DrivOut= 0
1:A#-2 0 5:C 0 0
2:C 0 0 6:C 0 0
3:C 0 0
4:C 0 0
FPag
    
```

- The **[F7]** button (“FPag”) can be used to go directly the next throat formant key scaling page without having to return to the main parameter page.

● DrivOut

≤ 0 ... 127.

The “DrivOut” parameter is linked to the main throat formant “Driver Output” parameter, and has the same effect. This value also determines the main output level on which all key-scaled variations are based (indicated by a dotted line on the graph).

● Breakpoint 1 ... 6 Key

≤ C-2 ... G8.

Allows six separate key scaling breakpoints to be set at any notes between C-2 and G8. You can position the cursor at the appropriate breakpoint key parameter and use any of the normal data entry procedures, or use a keyboard. To use a keyboard for breakpoint entry, position the cursor at the appropriate breakpoint key parameter, press the **[F8]** button (“Kbd”), and then press the key at which you want to set the breakpoint while “Kbd” appears in inverse characters.

No breakpoint can be set to a key lower than the breakpoint to its left.

● Breakpoint 1 ... 6 Offset

≤ -64 ... 63.

Set the amount of output offset for each of the breakpoints defined by the breakpoint key parameters, above. Negative values reduce the output, and positive values increase the output at the corresponding breakpoint. No matter what offset value is chosen, the actual output level will never exceed its minimum or maximum absolute value. When different offset values are applied to adjacent breakpoints, the output varies smoothly between the breakpoints.

4-2: Mixing Pipe/String Output Key Scalling

Mixing pipe/string output key scaling produces natural timbre variations across the range of the keyboard by allowing different pipe/string output offset values to be applied to each of six breakpoints set at appropriate keys.

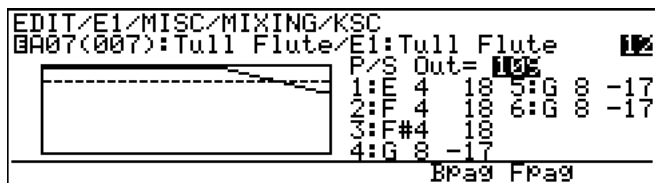

- The **[F6]** and **[F7]** buttons (“Bpag” and “Fpag”) can be used to go directly backward or forward to the next mixing key scaling page without having to return to the main parameter page.

● P/S Out

≤ 0 ... 127.

The “P/S Out” parameter is linked to the main mixing “Pipe/String Output” parameter, and has the same effect. This value also determines the main output level on which all key-scaled variations are based (indicated by a dotted line on the graph).

● Breakpoint 1 ... 6 Key

≤ C-2 ... G8.

Allows six separate key scaling breakpoints to be set at any notes between C-2 and G8. You can position the cursor at the appropriate breakpoint key parameter and use any of the normal data entry procedures, or use a keyboard. To use a keyboard for breakpoint entry, position the cursor at the appropriate breakpoint key parameter, press the **[F8]** button (“Kbd”), and then press the key at which you want to set the breakpoint while “Kbd” appears in inverse characters.

No breakpoint can be set to a key lower than the breakpoint to its left.

● Breakpoint 1 ... 6 Offset

≤ -64 ... 63.

Set the amount of output offset for each of the breakpoints defined by the breakpoint key parameters, above. Negative values reduce the output, and positive values increase the output at the corresponding breakpoint. No matter what offset value is chosen, the actual output level will never exceed its minimum or maximum absolute value. When different offset values are applied to adjacent breakpoints, the output varies smoothly between the breakpoints.

4-3: Mixing Tap Output Key Scalling

Mixing tap output key scalling produces natural timbre variations across the range of the keyboard by allowing different tap output offset values to be applied to each of six breakpoints set at appropriate keys.



- The [F6] and [F7] buttons (“Bpag” and “Fpag”) can be used to go directly backward or forward to the next mixing key scalling page without having to return to the main parameter page.
- Tap Output Key Scalling has no effect when the main Mixing page “Tap Setting” parameter is set to “Driving Position”.

● TapOut

≤ 0 ... 127.

The “TapOut” parameter is linked to the main mixing “Tap Output” parameter, and has the same effect. This value also determines the main output level on which all key-scaled variations are based (indicated by a dotted line on the graph).

● Breakpoint 1 ... 6 Key

≤ C-2 ... G8.

Allows six separate key scalling breakpoints to be set at any notes between C-2 and G8. You can position the cursor at the appropriate breakpoint key parameter and use any of the normal data entry procedures, or use a keyboard. To use a keyboard for breakpoint entry, position the cursor at the appropriate breakpoint key parameter, press the [F8] button (“Kbd”), and then press the key at which you want to set the breakpoint while “Kbd” appears in inverse characters.

No breakpoint can be set to a key lower than the breakpoint to its left.

● Breakpoint 1 ... 6 Offset

≤ -64 ... 63.

Set the amount of output offset for each of the breakpoints defined by the breakpoint key parameters, above. Negative values reduce the output, and positive values increase the output at the corresponding breakpoint. No matter what offset value is chosen, the actual output level will never exceed its minimum or maximum absolute value. When different offset values are applied to adjacent breakpoints, the output varies smoothly between the breakpoints.

4-4: Mixing Tap Location Key Scalling

Mixing tap location key scalling produces natural timbre variations across the range of the keyboard by allowing different tap location offset values to be applied to each of six breakpoints set at appropriate keys.



- The **[F6]** button (“Bpag”) can be used to go directly back to the next mixing key scalling page without having to return to the main parameter page.
- Tap Location Key Scalling has no effect when the main Mixing page “Tap Setting” parameter is set to “Driving Position”.

● TapLoc

≤ 0 ... 99.2%.

The “TapLoc” parameter is linked to the main mixing “Tap Location” parameter, and has the same effect. This value also determines the main tap location on which all key-scaled variations are based (indicated by a dotted line on the graph).

● Breakpoint 1 ... 6 Key

≤ C-2 ... G8.

Allows six separate key scalling breakpoints to be set at any notes between C-2 and G8. You can position the cursor at the appropriate breakpoint key parameter and use any of the normal data entry procedures, or use a keyboard. To use a keyboard for breakpoint entry, position the cursor at the appropriate breakpoint key parameter, press the **[F8]** button (“Kbd”), and then press the key at which you want to set the breakpoint while “Kbd” appears in inverse characters.

No breakpoint can be set to a key lower than the breakpoint to its left.

● Breakpoint 1 ... 6 Offset

≤ -64 ... 63.

Set the amount of tap location offset for each of the breakpoints defined by the breakpoint key parameters, above. Negative values reduce the tap location value, and positive values increase the tap location value at the corresponding breakpoint. No matter what offset value is chosen, the actual tap location will never exceed its minimum or maximum absolute value. When different offset values are applied to adjacent breakpoints, the tap location varies smoothly between the breakpoints.

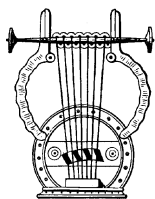

5: Amplitude

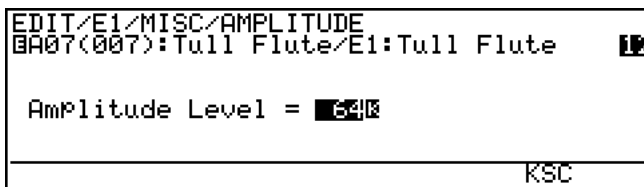

- Key scaling can be applied to the Amplitude Level parameter. Press the **[F7]** button (“KSC”) to go directly to the key scaling page. You can return to the amplitude parameter page by pressing the **[EXIT]** button.

● Amplitude Level

≤ 0 ... 127.

Sets the final output level of the selected Element, after mixing. The higher the value the higher the level.

5-1: Amplitude Level Key Scaling

Amplitude level key scaling produces natural level variations across the range of the keyboard by allowing different level offset values to be applied to each of eight break-points set at appropriate keys.

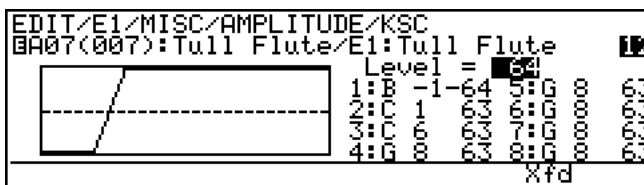

- The **[F7]** button (“Xfd”) can be used to invert the curve of the Amplitude Key Scaling for the other element when a 2-element voice is being edited to produce a crossfade key scaling effect between elements (“Xfd” will not appear when a 1-element voice is edited).

● Level

≤ 0 ... 127.

The “Level” parameter is linked to the main amplitude “Amplitude Level” parameter, and sets the final output level of the selected Element, after mixing. The higher the value the higher the level. This value also determines the main level on which all key-scaled variations are based (indicated by a dotted line on the graph).



● Breakpoint 1 ... 8 Key

≤ C-2 ... G8.

Allows eight separate key scaling breakpoints to be set at any notes between C-2 and G8. You can position the cursor at the appropriate breakpoint key parameter and use any of the normal data entry procedures, or use a keyboard. To use a keyboard for breakpoint entry, position the cursor at the appropriate breakpoint key parameter, press the **F8** button (“Kbd”), and then press the key at which you want to set the breakpoint (indicated by a dotted line on the graph).

No breakpoint can be set to a key lower than the breakpoint to its left.

● Breakpoint 1 ... 8 Offset

≤ -64 ... 63.

Set the amount of level offset for each of the breakpoints defined by the breakpoint key parameters, above. Negative values reduce the level, and positive values increase the level at the corresponding breakpoint. No matter what offset value is chosen, the actual level will never exceed its minimum or maximum absolute value. When different offset values are applied to adjacent breakpoints, the level varies smoothly between the breakpoints.



Element Modifier

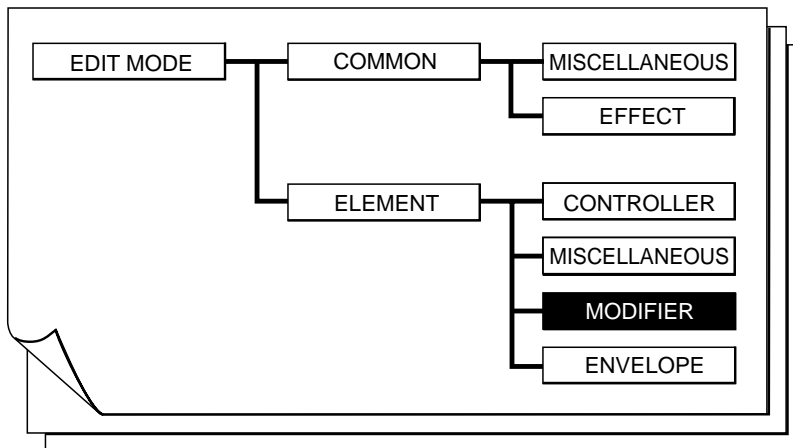

■ 1: Harmonic Enhancer	107	■ 3: Equalizer Auxiliary	119
● 1-1: Harmonic Enhancer HPF Key Scaling ...	110	● 3-1: Equalizer Auxiliary HPF Key Scaling	120
● 1-2: Harmonic Enhancer Overdrive Key Scaling	111	● 3-2: Equalizer Auxiliary LPF Key Scaling	121
● 1-3: Harmonic Enhancer Carrier Level Key		■ 4: Equalizer Band	122
Scaling	112	■ 5: Impulse Expander & Resonator Setting ...	123
● 1-4: Harmonic Enhancer Modulator Index Key		■ 6: Impulse Expander	125
Scaling	113	■ 7: Resonator	126
● 1-5: Harmonic Enhancer Balance Key Scaling	114		
■ 2: Dynamic Filter	115		
● 2-1: Dynamic Filter Cutoff Key Scaling	117		
● 2-2: Dynamic Filter Resonance Key Scaling ..	118		

```

EDIT/E1
A07(007):Tull Flute/E1:Tull Flute
<Modifier>
1:Harmonic Enhancer 5:IE & RSN Setting
2:Dynamic Filter 6:Impulse Expander
3:Equalizer Auxiliary 7:Resonator
4:Equalizer Band
Ctrl Misc Modi Env
    
```

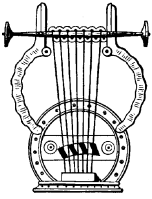

1: Harmonic Enhancer

■ Carrier Parameters

```

EDIT/E1/MODIFIER/HARMONIC ENHANCER
BA07(007):Tull Flute/E1:Tull Flute
Signal Select = Normal
HPF Cutoff = 30.8 Hz
Over Drive = 1.000
Level = 127
Balance = -64 Dry Wet
Ctrl Mod Ctrl
    
```

■ Modulator Parameters

```

EDIT/E1/MODIFIER/HARMONIC ENHANCER
BA07(007):Tull Flute/E1:Tull Flute
Signal Select = Normal
HPF Cutoff = 227.0 Hz
Over Drive = 3.666
Phase = 170deg Index = 90
Balance = -64 Dry Wet
Ctrl Mod Ctrl
    
```

- The Harmonic Enhancer has both a “Carrier” and “Modulator” block, as shown in the block diagram below. Each has its own parameters and therefore two separate parameter pages are provided. Press the **[F1]** button (“Crr”) to select the carrier parameter page or **[F2]** (“Mod”) to select the modulator parameter page.

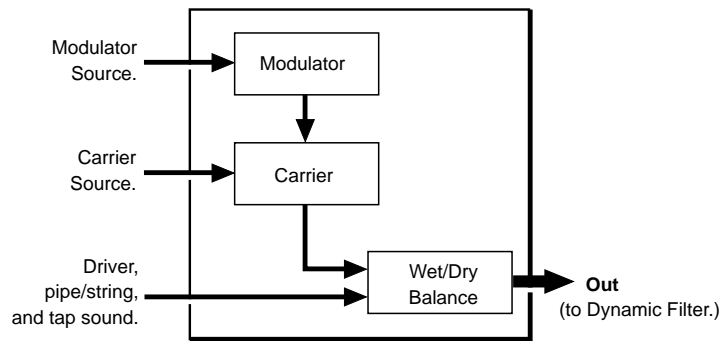

- The **[F8]** button (“Ctrl”) can be used to go directly to the harmonic enhancer controller page (≥ Page 78), also available from the ELEMENT CONTROLLER directory. You can then return to the modifier harmonic enhancer page by pressing **[F8]** (“Para”) again.
- An inverse “K”(**[K]**) next to a value means that key scaling can be applied to that parameter. Position the cursor at the appropriate parameter and then press the **[F7]** button (“KSC”) to go directly to the key scaling page for that parameter. You can return to the harmonic enhancer parameter page by pressing the **[EXIT]** button.

● Signal Select

≤ Normal, Breath Noise Amp., Flow Rate Saturation, Beat, Slit/Friction, Reed.

Selects the signal to be used by the carrier or modulator.

Normal	This is the total output of the instrument model: a mix of the driver, pipe/string, and tap signals.
Breath Noise Amplitude	This signal represents the instantaneous amplitude of the breath noise produced at the driver. It is basically a highly distorted version of the Slit/Friction signal described below.
Flow Rate Saturation	When the pressures on either side of an aperture (e.g. a mouthpiece/reed assembly) differ, a corresponding flow of air is produced. There is, however, a limit to the speed of the airflow which can be produced (saturation). The relationship between the pressure difference and resulting airflow is derived as the Flow Rate Saturation signal.
Beat	The beat signal represents contact between the vibrating reed and the mouthpiece.
Slit/Friction	As the reed vibrates, the area of gap (slit) between it and the mouthpiece varies accordingly. The Slit/Friction signal corresponds to the varying area of the reed/mouthpiece slit.
Reed	This signal is derived directly from the flexing of the reed.

● HPF Cutoff

≤ 17.0 Hz ... 11.2 kHz.

Both the modulator and carrier blocks have high-pass filters that can be used to roll off the low frequencies of the corresponding signal. This parameter sets the cutoff frequency of the carrier or modulator high-pass filter.

● Over Drive

≤ 0.063 ... 15.31.

This parameter boosts the corresponding modulator or carrier signal, forcing it into distortion and thereby drastically changing its harmonic structure. The higher the value the greater the distortion. No distortion is produced below a setting of “1.0”.

● Level (Carrier only)

≤ 0 ... 127.

Sets the output level of the carrier. The higher the value the greater the output level.

● Balance

≤ -64 ... 63.

Sets the balance between the “wet” (the output of the harmonic enhancer) and “dry” (the direct signal) signals. The higher the value the more “wet” the signal, and therefore the more pronounced the harmonic enhancer effect. The carrier and modulator page “Balance” parameters are linked.



● Phase (Modulator only)

≤ 0deg ... 360deg.

This parameter is provided for the modulator block only. It allows a degree of timbral variation by varying the phase of the modulator signal through 360 degrees in 2- or 3-degree increments.

● Index (Modulator only)

≤ 0 ... 127.

Determines how much modulation is applied to the carrier signal (i.e. the level of the modulator signal applied to the carrier). The higher the value the greater the modulation.

Notes On Using the Harmonic Enhancer

Although any modulator source signal can be applied to any carrier source signal, two approaches are recommended when attempting to create an acoustic instrument simulation.

The first is to set the carrier signal to “Normal” and the modulator signal to any other than normal, set the dry/wet “Balance” to 63 (all wet), and set a relatively high “Index” value. In this case the total output of the instrument model (“Normal” signal) will be modulated by one of the component signals, so the dry/wet “Balance” can be set to fully wet (carrier output only) since the carrier source and dry signals are essentially the same. The Index parameter determines how much modulation is applied, so a higher value is generally required to create sufficient variation.

The second approach is to set the carrier signal to any other than normal and the modulator signal to any of the six possibilities, set the dry/wet “Balance” to a more central value, and set a relatively low “Index” value. In this situation it is necessary to set the “Balance” more toward the “Dry” side since the carrier source signal is not the normal signal and at least some of the dry signal is necessary to provide the basic sound of the instrument model. In other words, the sound produced by the Harmonic Enhancer is simply added to the basic sound of the instrument, in contrast with the first approach in which the basic sound of the instrument is modulated directly.

Please note that these are only guidelines, and are by no means the only way to work with the Harmonic Enhancer. Since the Harmonic Enhancer tends to respond differently with different instrument models, experimentation and experience are your most valuable tools.



1-1: Harmonic Enhancer HPF Key Scaling

Harmonic Enhancer HPF key scaling produces natural timbral variations across the range of the keyboard by allowing different cutoff frequency offset values to be applied to each of two breakpoints set at appropriate keys. Key scaling can be applied independently to the carrier and modulator high-pass filters.

■ Carrier Parameters

```

EDIT/E1/MODIFIER/HARMONIC ENHANCER/KSC
BA07(007):Tull Flute/E1:Tull Flute
CrrHPF = 1078 Hz
1: A#-2 0
2: C 8 0
FPa9
    
```

■ Modulator Parameters

```

EDIT/E1/MODIFIER/HARMONIC ENHANCER/KSC
BA07(007):Tull Flute/E1:Tull Flute
ModHPF = 2270 Hz
1: A#-2 0
2: C 8 0
BPa9 FPa9
    
```

- Separate key scaling parameter pages are provided for the carrier and modulator high-pass filters. The appropriate key scaling page will be selected when you press **[F7]** (“KSC”) from the main carrier or modulator parameter page.
- The **[F6]** and **[F7]** buttons (“Bpa9” and “Fpa9”) can be used to go directly backward or forward to the next harmonic enhancer key scaling page without having to return to the main parameter page.

● CrrHPF, ModHPF

≤ 17.0 Hz ... 11.2 kHz.

The “CrrHPF” and “ModHPF” parameters are linked to the main harmonic enhancer “HPF Cutoff” parameters, and set the cutoff frequency of the carrier or modulator high-pass filter. Frequency components *below* the specified frequency are cut off. This value also determines the main cutoff frequency on which all key-scaled variations are based (indicated by a dotted line on the graph).

● Breakpoint 1 & 2 Key

≤ C-2 ... G8.

Allows two separate key scaling breakpoints to be set at any notes between C-2 and G8. You can position the cursor at the appropriate breakpoint key parameter and use any of the normal data entry procedures, or use a keyboard. To use a keyboard for breakpoint entry, position the cursor at the appropriate breakpoint key parameter, press the **[F8]** button (“Kbd”), and then press the key at which you want to set the breakpoint while “Kbd” appears in inverse characters.

No breakpoint can be set to a key lower than the breakpoint to its left.

NOTES

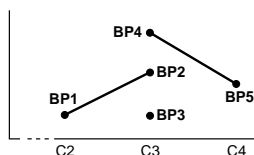

■ If two breakpoints are set to the same note, the lower one functions as the end of the key scaling segment connecting to the next lowest breakpoint while the higher one functions as the end of the segment connecting to the next highest breakpoint.

Further, the higher breakpoint applies to the specified note while the lower one actually applies to the next note to its left. If more than two breakpoints are set to the same note, only the lowest and highest of these will function as ends of the corresponding key scaling segments while the rest are ignored.

● Breakpoint 1 & 2 Offset

≤ -64 ... 63.

Set the amount of cutoff frequency offset for each of the breakpoints defined by the breakpoint key parameters, above. Negative values lower the cutoff frequency, and positive values raise the cutoff frequency at the corresponding breakpoint. No matter what offset value is chosen, the actual cutoff frequency will never exceed its minimum or maximum absolute value. When different offset values are applied to adjacent breakpoints, the cutoff frequency varies smoothly between the breakpoints.

1-2: Harmonic Enhancer Overdrive Key Scaling

Harmonic Enhancer overdrive key scaling produces natural timbral variations across the range of the keyboard by allowing different overdrive offset values to be applied to each of two breakpoints set at appropriate keys. Key scaling can be applied independently to the carrier and modulator overdrive parameters.

■ Carrier Parameters



■ Modulator Parameters



- Separate key scaling parameter pages are provided for the carrier and modulator overdrive parameters. The appropriate key scaling page will be selected when you press **[F7]** (“KSC”) from the main carrier or modulator parameter page.
- The **[F6]** and **[F7]** buttons (“BPag” and “Fpag”) can be used to go directly backward or forward to the next harmonic enhancer key scaling page without having to return to the main parameter page.

● CrrOvr, ModOvr

≤ 0.063 ... 15.31 kHz.

The “CrrOvr” and “ModOvr” parameters are linked to the main harmonic enhancer “Over Drive” parameters, and set the amount of distortion produced by the carrier or modulator. This value also determines the main overdrive level on which all key-scaled variations are based (indicated by a dotted line on the graph).

● Breakpoint 1 & 2 Key

≤ C-2 ... G8.

Allows two separate key scaling breakpoints to be set at any notes between C-2 and G8. You can position the cursor at the appropriate breakpoint key parameter and use any of the normal data entry procedures, or use a keyboard. To use a keyboard for breakpoint entry, position the cursor at the appropriate breakpoint key parameter, press the **[F8]** button (“Kbd”), and then press the key at which you want to set the breakpoint while “Kbd” appears in inverse characters.

No breakpoint can be set to a key lower than the breakpoint to its left.

● Breakpoint 1 & 2 Offset

≤ -64 ... 63.

Set the amount of overdrive offset for each of the breakpoints defined by the breakpoint key parameters, above. Negative values reduce the overdrive level, and positive values increase the overdrive level at the corresponding breakpoint. No matter what offset value is chosen, the actual overdrive level will never exceed its minimum or maximum absolute value. When different offset values are applied to adjacent breakpoints, the overdrive level varies smoothly between the breakpoints.

1-3: Harmonic Enhancer Carrier Level Key Scaling

Harmonic Enhancer carrier level key scaling produces natural timbral variations across the range of the keyboard by allowing different carrier level offset values to be applied to each of four breakpoints set at appropriate keys.

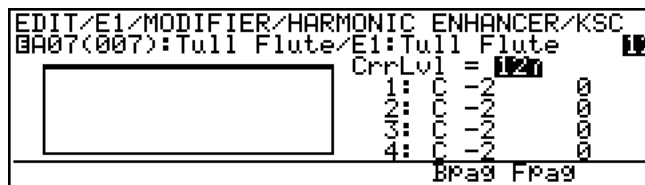

- The **[F6]** and **[F7]** buttons (“Bpag” and “Fpag”) can be used to go directly backward or forward to the next harmonic enhancer key scaling page without having to return to the main parameter page.

● CrrLvl

≤ 0 ... 127.

The “CrrLvl” parameter is linked to the main harmonic enhancer carrier “Level” parameter, and sets the output level of the carrier block. This value also determines the main carrier level on which all key-scaled variations are based (indicated by a dotted line on the graph).

● Breakpoint 1 ... 4 Key

≤ C-2 ... G8.

Allows four separate key scaling breakpoints to be set at any notes between C-2 and G8. You can position the cursor at the appropriate breakpoint key parameter and use any

of the normal data entry procedures, or use a keyboard. To use a keyboard for breakpoint entry, position the cursor at the appropriate breakpoint key parameter, press the **[F8]** button (“Kbd”), and then press the key at which you want to set the breakpoint while “Kbd” appears in inverse characters.

No breakpoint can be set to a key lower than the breakpoint to its left.

● Breakpoint 1 ... 4 Offset

≤ -64 ... 63.

Set the amount of level offset for each of the breakpoints defined by the breakpoint key parameters, above. Negative values reduce the carrier level, and positive values increase the carie level at the corresponding breakpoint. No matter what offset value is chosen, the actual carrier level will never exceed its minimum or maximum absolute value. When different offset values are applied to adjacent breakpoints, the carrier level varies smoothly between the breakpoints.

1-4: Harmonic Enhancer Modulator Index Key Scaling

Harmonic Enhancer modulator index key scaling produces natural timbral variations across the range of the keyboard by allowing different modulator index offset values to be applied to each of four breakpoints set at appropriate keys.

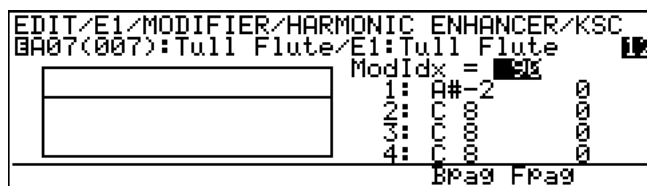

- The **[F6]** and **[F7]** buttons (“BPa9” and “FPa9”) can be used to go directly backward or forward to the next harmonic enhancer key scaling page without having to return to the main parameter page.

● ModIdx

≤ 0 ... 127.

The “ModIdx” parameter is linked to the main harmonic enhancer modulator “Index” parameter, and sets the amount of modulation applied to the carrier. This value also determines the main modulator index on which all key-scaled variations are based (indicated by a dotted line on the graph).

● Breakpoint 1 ... 4 Key

≤ C-2 ... G8.

Allows four separate key scaling breakpoints to be set at any notes between C-2 and G8. You can position the cursor at the appropriate breakpoint key parameter and use any of the normal data entry procedures, or use a keyboard. To use a keyboard for breakpoint entry, position the cursor at the appropriate breakpoint key parameter, press the **[F8]** button (“Kbd”), and then press the key at which you want to set the breakpoint while “Kbd” appears in inverse characters.

No breakpoint can be set to a key lower than the breakpoint to its left.

● Breakpoint 1 ... 4 Offset

≤ -64 ... 63.

Set the amount of modulator index offset for each of the breakpoints defined by the breakpoint key parameters, above. Negative values reduce the modulator index, and positive values increase the modulator index at the corresponding breakpoint. No matter what offset value is chosen, the actual modulator index will never exceed its minimum or maximum absolute value. When different offset values are applied to adjacent breakpoints, the modulator index varies smoothly between the breakpoints.

1-5: Harmonic Enhancer Balance Key Scaling

Harmonic Enhancer balance key scaling produces natural timbral variations across the range of the keyboard by allowing different balance offset values to be applied to each of two breakpoints set at appropriate keys.

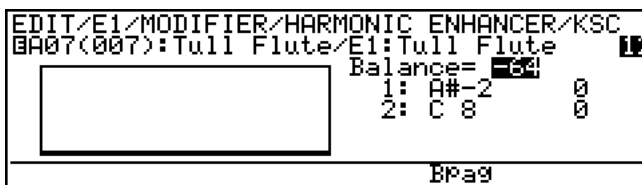

- The **[F6]** button (“BPag”) can be used to go directly backward to the next harmonic enhancer key scaling page without having to return to the main parameter page.

● Balance

≤ -64 ... 63.

The “Balance” parameter is linked to the main harmonic enhancer “Balance” parameter, and sets the balance between the wet and dry sound. This value also determines the main balance value on which all key-scaled variations are based (indicated by a dotted line on the graph).

● Breakpoint 1 & 2 Key

≤ C-2 ... G8.

Allows two separate key scaling breakpoints to be set at any notes between C-2 and G8. You can position the cursor at the appropriate breakpoint key parameter and use any of the normal data entry procedures, or use a keyboard. To use a keyboard for breakpoint entry, position the cursor at the appropriate breakpoint key parameter, press the **[F8]** button (“Kbd”), and then press the key at which you want to set the breakpoint while “Kbd” appears in inverse characters.

No breakpoint can be set to a key lower than the breakpoint to its left.

● Breakpoint 1 & 2 Offset

≤ -64 ... 63.

Set the amount of balance offset for each of the breakpoints defined by the breakpoint key parameters, above. Negative values reduce the balance value (toward “dry”),

and positive values increase the balance value (toward “wet”) at the corresponding breakpoint. No matter what offset value is chosen, the actual balance setting will never exceed its minimum or maximum absolute value. When different offset values are applied to adjacent breakpoints, the balance varies smoothly between the breakpoints.

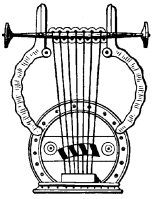

2: Dynamic Filter

```

EDIT/E1/MODIFIER/DYNAMIC FILTER
BA07(007):Tull Flute/E1:Tull Flute
Filter Mode = LPF Input Gain = 127
Balance = -64 Dry |-----| Wet
Cutoff Tracking = KeyTrack
Cutoff Freq. = -0.50oct
Resonance = 1.00Q
Ctrl
    
```

- The **[F8]** button (“Ctrl”) can be used to go directly to the dynamic filter controller page (≥ Page 77), also available from the ELEMENT CONTROLLER directory. You can then return to the modifier dynamic filter page by pressing **[F8]** (“Para”) again.
- An inverse “K”(**[K]**) next to a value means that key scaling can be applied to that parameter. Position the cursor at the appropriate parameter and then press the **[F7]** button (“KSC”) to go directly to the key scaling page for that parameter. You can return to the dynamic filter parameter page by pressing the **[EXIT]** button.

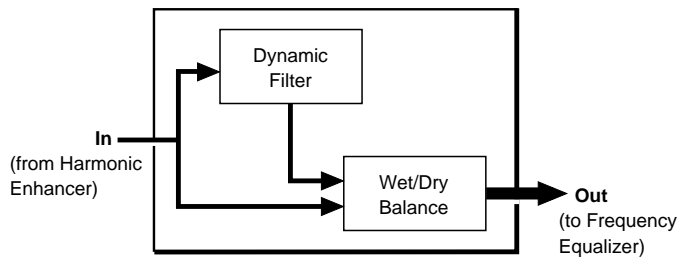

● Filter Mode

≤ LPE, BPE, HPE, BEF.

Selects the filter mode.

LPF	Low-pass filter. Frequencies below the cutoff frequency are passed while those above are cut off. The cutoff slope is -12 dB/octave.
BPF	Band-pass filter. In this case the “cutoff frequency” is actually the center frequency of a narrow band of frequencies which will be passed. The cutoff slope is -6 dB/octave.
HPF	High-pass filter. Frequencies above the cutoff frequency are passed while those below are cut off. The cutoff slope is -12 dB/octave.
BEF	Band-eliminaton filter. The cutoff frequency is the center frequency of a narrow band of frequencies which will be cut off. The cutoff slope is -6 dB/octave.

● Input Gain

≤ 0 ... 127.

Adjusts the level of the input signal to the dynamic filter stage. The higher the value the higher the input level.

● Balance

≤ -64 ... 63.

Sets the balance between the “wet” (the output of the dynamic filter) and “dry” (direct) signals. The higher the value the more “wet” the signal, and therefore the more pronounced the dynamic filter effect.

● Cutoff Tracking

≤ Fixed, KeyTrack.

Determines whether the dynamic filter cutoff frequency is fixed or tracks the notes played.

Fixed	The dynamic filter is fixed at the frequency specified by the “Cutoff Freq.” parameter, below.
KeyTrack	The cutoff frequency of the dynamic filter tracks the note(s) played, offset by the amount specified by the “Cutoff Freq.” parameter, below.

● Cutoff Freq.

≤ 26.9 Hz ... 11.9 kHz (when “Fixed”).

≤ -4.00oct ... 3.94oct (when “KeyTrack”).

When the “Cutoff Tracking” parameter is set to “Fixed”, this parameter sets the dynamic filter cutoff frequency to a specific frequency between 26.9 hertz and 11.9 kilohertz. When “Cutoff Tracking” is set to “KeyTrack”, however, this parameter determines how much the cutoff frequency is offset from the frequency of the note played in octave units. In the latter case negative values offset the cutoff frequency *below* the frequency of the note played, while positive values offset the cutoff frequency *above* that of the note played.

● Resonance

≤ 1.00 ... 15.67.

This parameter produces a “peaking” effect at the filter’s cutoff frequency, further emphasizing the frequencies at that point. This higher the value the higher the resonant peak.



2-1: Dynamic Filter Cutoff Key Scaling

Dynamic filter cutoff frequency key scaling produces natural timbral variations across the range of the keyboard by allowing different cutoff frequency offset values to be applied to each of three breakpoints set at appropriate keys.

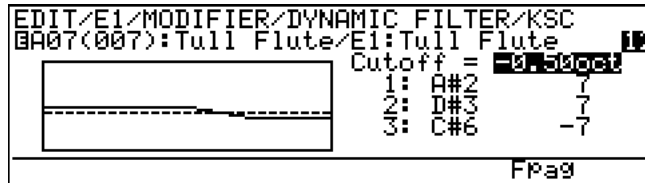

- The **[F7]** button ("Fpag") can be used to go directly forward to the next dynamic filter key scaling page without having to return to the main parameter page.

● Cutoff

≤ 26.9 Hz ... 11.9 kHz (when "Fixed").

≤ -4.0oct ... 3.94oct (when "KeyTrack").

The "Cutoff" parameter is linked to the main dynamic filter "Cutoff Freq." parameter, and has the same effect. This value also determines the main cutoff frequency on which all key-scaled variations are based (indicated by a dotted line on the graph).

● Breakpoint 1 ... 3 Key

≤ C-2 ... G8.

Allows three separate key scaling breakpoints to be set at any notes between C-2 and G8. You can position the cursor at the appropriate breakpoint key parameter and use any of the normal data entry procedures, or use a keyboard. To use a keyboard for breakpoint entry, position the cursor at the appropriate breakpoint key parameter, press the **[F8]** button ("Kbd"), and then press the key at which you want to set the breakpoint while "Kbd" appears in inverse characters.

No breakpoint can be set to a key lower than the breakpoint to its left.

● Breakpoint 1 ... 3 Offset

≤ -64 ... 63.

Set the amount of cutoff frequency offset for each of the breakpoints defined by the breakpoint key parameters, above. Negative values lower the cutoff frequency, and positive values raise the cutoff frequency at the corresponding breakpoint. No matter what offset value is chosen, the actual cutoff frequency will never exceed its minimum or maximum absolute value. When different offset values are applied to adjacent breakpoints, the cutoff frequency varies smoothly between the breakpoints.

2-2: Dynamic Filter Resonance Key Scaling

Dynamic filter resonance key scaling produces natural timbral variations across the range of the keyboard by allowing different resonance offset values to be applied to each of three breakpoints set at appropriate keys.

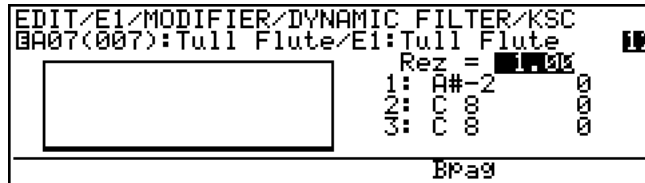

- The **[F6]** button (“Bpag”) can be used to go directly backward to the next dynamic filter key scaling page without having to return to the main parameter page.

● Rez

≤ 1.00 ... 15.67.

The “Rez” parameter is linked to the main dynamic filter “Resonance” parameter, and has the same effect. This value also determines the main resonance value on which all key-scaled variations are based (indicated by a dotted line on the graph).

● Breakpoint 1 ... 3 Key

≤ C-2 ... G8.

Allows three separate key scaling breakpoints to be set at any notes between C-2 and G8. You can position the cursor at the appropriate breakpoint key parameter and use any of the normal data entry procedures, or use a keyboard. To use a keyboard for breakpoint entry, position the cursor at the appropriate breakpoint key parameter, press the **[F8]** button (“Kbd”), and then press the key at which you want to set the breakpoint while “Kbd” appears in inverse characters.

No breakpoint can be set to a key lower than the breakpoint to its left.

● Breakpoint 1 ... 3 Offset

≤ -64 ... 63.

Set the amount of resonance offset for each of the breakpoints defined by the breakpoint key parameters, above. Negative values reduce the resonance, and positive values increase the resonance at the corresponding breakpoint. No matter what offset value is chosen, the actual resonance setting will never exceed its minimum or maximum absolute value. When different offset values are applied to adjacent breakpoints, the resonance varies smoothly between the breakpoints.

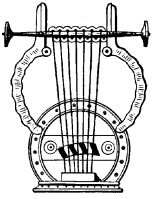

3: Equalizer Auxiliary

```

EDIT/E1/MODIFIER/EQUALIZER AUXILIARY
BA07(007):Tull Flute/E1:Tull Flute
Input Gain      = 120
HPF Cutoff Freq. = 94.1 Hz
LPF Cutoff Freq. = 3.64 kHz
  
```

- An inverse “K” (K) next to a value means that key scaling can be applied to that parameter. Position the cursor at the appropriate parameter and then press the **F7** button (“KSC”) to go directly to the key scaling page for that parameter. You can return to the equalizer auxiliary parameter page by pressing the **EXIT** button.

● Input Gain

≤ 0 ... 127.

Adjusts the level of the input signal to the equalizer stage. The higher the value the higher the input level.

● HPF Cutoff Freq.

≤ 17.0 Hz ... 11.2 kHz.

Sets the cutoff frequency of the high-pass filter. Frequency components *below* the specified frequency are cut off.

● LPF Cutoff Freq.

≤ 31.1 Hz ... 24.0 kHz.

Sets the cutoff frequency of the low-pass filter. Frequency components *above* the specified frequency are cut off. The low-pass filter is completely bypassed when set to “off”.

3-1: Equalizer Auxiliary HPF Key Scaling

Equalizer HPF key scaling produces natural tone variations across the range of the keyboard by allowing different cutoff frequency offset values to be applied to each of three breakpoints set at appropriate keys.

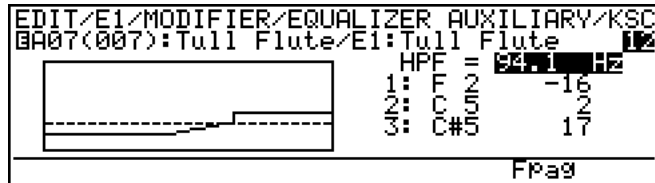

- The **[F7]** button (“Fpag”) can be used to go directly forward to the next equalizer auxiliary key scaling page without having to return to the main parameter page.

● HPF

≤ 17.0 Hz ... 11.2 kHz.

The “HPF” parameter is linked to the main equalizer auxiliary “HPF Cutoff Freq.” parameter, and sets the cutoff frequency of the high-pass filter. Frequency components *below* the specified frequency are cut off. This value also determines the main cutoff frequency on which all key-scaled variations are based (indicated by a dotted line on the graph).

● Breakpoint 1 ... 3 Key

≤ C-2 ... G8.

Allows three separate key scaling breakpoints to be set at any notes between C-2 and G8. You can position the cursor at the appropriate breakpoint key parameter and use any of the normal data entry procedures, or use a keyboard. To use a keyboard for breakpoint entry, position the cursor at the appropriate breakpoint key parameter, press the **[F8]** button (“Kbd”), and then press the key at which you want to set the breakpoint while “Kbd” appears in inverse characters.

No breakpoint can be set to a key lower than the breakpoint to its left.

● Breakpoint 1 ... 3 Offset

≤ -64 ... 63.

Set the amount of cutoff frequency offset for each of the breakpoints defined by the breakpoint key parameters, above. Negative values lower the cutoff frequency, and positive values raise the cutoff frequency at the corresponding breakpoint. No matter what offset value is chosen, the actual cutoff frequency will never exceed its minimum or maximum absolute value. When different offset values are applied to adjacent breakpoints, the cutoff frequency varies smoothly between the breakpoints.

3-2: Equalizer Auxiliary LPF Key Scaling

Equalizer LPF key scaling produces natural tone variations across the range of the keyboard by allowing different cutoff frequency offset values to be applied to each of three breakpoints set at appropriate keys.

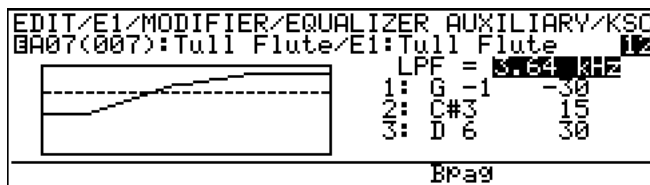

- The **[F6]** button (“Bpag”) can be used to go directly backward to the next equalizer auxiliary key scaling page without having to return to the main parameter page.

● LPF

≤ 31.1 Hz ... 24.0 kHz.

The “LPF” parameter is linked to the main equalizer auxiliary “LPF Cutoff Freq.” parameter, and sets the cutoff frequency of the low-pass filter. Frequency components *above* the specified frequency are cut off. This value also determines the main cutoff frequency on which all key-scaled variations are based (indicated by a dotted line on the graph).

● Breakpoint 1 ... 3 Key

≤ C-2 ... G8.

Allows three separate key scaling breakpoints to be set at any notes between C-2 and G8. You can position the cursor at the appropriate breakpoint key parameter and use any of the normal data entry procedures, or use a keyboard. To use a keyboard for breakpoint entry, position the cursor at the appropriate breakpoint key parameter, press the **[F8]** button (“Kbd”), and then press the key at which you want to set the breakpoint while “Kbd” appears in inverse characters.

No breakpoint can be set to a key lower than the breakpoint to its left.

● Breakpoint 1 ... 3 Offset

≤ -64 ... 63.

Set the amount of cutoff frequency offset for each of the breakpoints defined by the breakpoint key parameters, above. Negative values lower the cutoff frequency, and positive values raise the cutoff frequency at the corresponding breakpoint. No matter what offset value is chosen, the actual cutoff frequency will never exceed its minimum or maximum absolute value. When different offset values are applied to adjacent breakpoints, the cutoff frequency varies smoothly between the breakpoints.

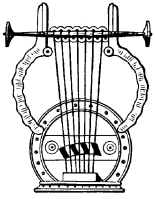

4: Equalizer Band

EDIT/E1/MODIFIER/EQUALIZER BAND			
0A07(007):Tull Flute/E1:Tull Flute			
Bnd1:	Freq=217.0 Hz	Q=5.57	Level= 0.0
Bnd2:	=217.0 Hz	=0.95	= 0.0
Bnd3:	=704.0 Hz	=7.45	= 0.0
Bnd4:	=1.54 kHz	=3.93	= 0.6
Bnd5:	=10.0 kHz	=1.55	= 11.3

- The Equalizer Band block is a 5-band parametric equalizer with frequency, Q (bandwidth), and level control. The Band block functions in the same way as any standard parametric equalizer, allowing flexible response control over a wide range.

● Bnd1 Freq

≤ 40.0 Hz ... 321.0 Hz.

● Bnd2 Freq

≤ 104.0 Hz ... 838.0 Hz.

● Bnd3 Freq

≤ 284.0 Hz ... 2.00 kHz.

● Bnd4 Freq

≤ 646.0 Hz ... 5.21 kHz.

● Bnd5 Freq

≤ 1.54 kHz ... 10.0 kHz.

These parameters individually set the center frequencies of the equalizer stage's five bands. Note that the bands overlap somewhat for smooth, seamless control.

● Bnd1 ... Bnd5 Q

≤ 0.5 ... 20.0.

Individually set the Q (bandwidth) for each of the equalizer's five bands. The higher the value the narrower the bandwidth.

● Bnd1 ... Bnd5 Level

≤ -24.0 ... 23.6.

Individually set the level of the equalizer's five bands. Negative values produce a cut at the frequency of the corresponding band while positive values produce a boost.

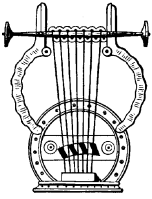

5: Impulse Expander & Resonator Setting

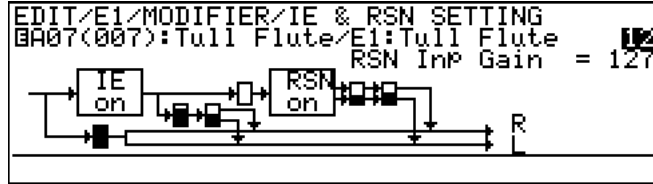

- This page provide access to a range of parameters which affect operation of the Impulse Expander and Resonator stages (described later) and how they interact. It contains a number of parameters which are accessed by moving the cursor to the appropriate block within the diagram. The corresponding parameter will appear in the upper right area of the display.

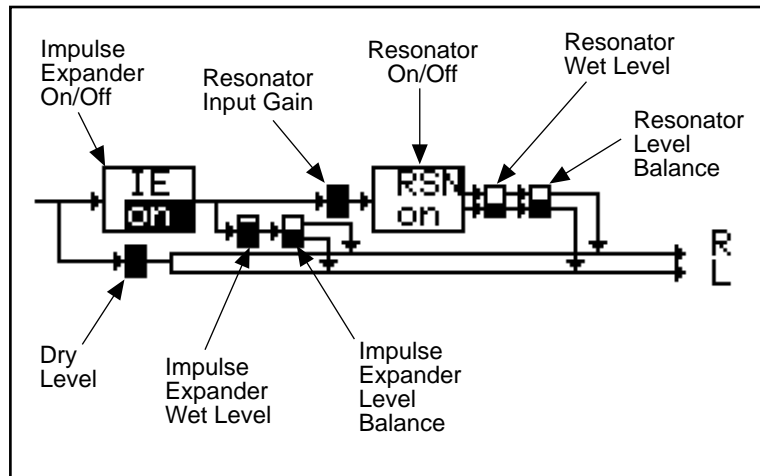

- When the cursor is positioned at the “IE on/off” or “RSN on/off” block, “Para” will appear above the **[F8]** button. Press this button to go directly to the main Impulse Expander (≥ Page 125) or Resonator (≥ Page 126) parameter page, respectively.

● IE

≤ off, on.

Turns the Impulse Expander stage off or on. When off (and the Resonator, below, is on) the display will appear as shown below. Only parameters which appear in the diagram are available for editing.

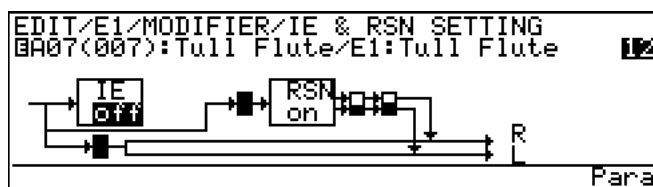

● RSN

≤ off, on.

Turns the Resonator stage off or on. When off (and the Impulse Expander, above, is on) the display will appear as shown below. Only parameters which appear in the diagram are available for editing.

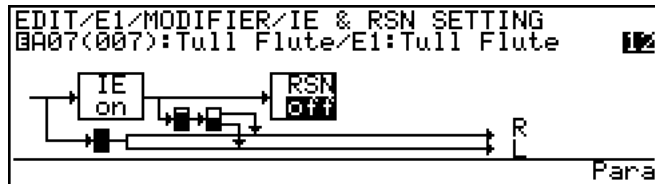

● Dry Level

≤ 0 ... 127.

Sets the level of the dry signal (i.e. the direct signal which does not pass through either the Impulse Expander or the Resonator).

● IE Wet Level

≤ 0 ... 127.

Sets the “wet” output level from the Impulse Expander. The higher the value the higher the Impulse Expander level.

● IE Level Bal

≤ -64 ... 63.

Adjusts the left-right balance of the wet Impulse Expander signal returned to the stereo signal path. Positive values route more signal to the right channel while negative values route more signal to the left channel.

● RSN Inp Gain

≤ 0 ... 127.

Sets the level of the Impulse Expander output signal received at the input of the Resonator stage. The higher the value the higher the input level.

● RSN Wet Level

≤ 0 ... 127.

Sets the “wet” output level from the Resonator. The higher the value the higher the Resonator level.

● RSN Level Bal

≤ -64 ... 63.

Adjusts the left-right balance of the wet Resonator signal returned to the stereo signal path. Positive values route more signal to the right channel while negative values route more signal to the left channel.



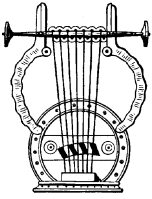

6: Impulse Expander

```

EDIT/E1/MODIFIER/IMPULSE EXPANDER
BA07(007):Tull Flute/E1:Tull Flute
Density      = 6.97msec
Dispersion   = 349.5msec
Roughness    = 7
Set
  
```

- This display will not appear — “Impulse Expander is not used” will appear — if the “IE on/off” block in the “Impulse Expander & Resonator Setting” page is turned “off” (≥ Page 123). All level and balance settings relating to the Impulse Expander are also available in that display page.
- Press the **[F8]** button (“Set”) to go directly to the “Impulse Expander & Resonator Setting” page.

The Impulse Expander works in conjunction with the Resonator, described below, to simulate the effect of an instrument’s resonant cavity or sound box. It can also be used to simulate the acoustic environment in which the instrument is played.

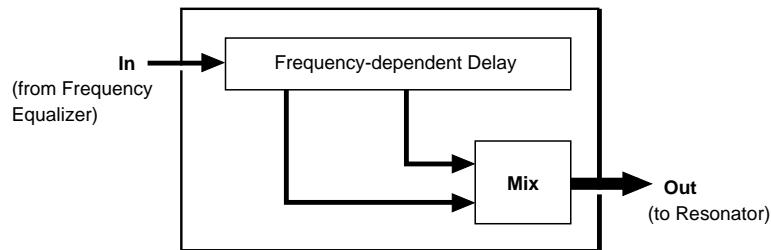

● Density

≤ 0.146 msec ... 20.77 msec.

Adjusts the density of the sound, and therefore its texture. Higher values produce greater density.

● Dispersion

≤ 4.028 msec ... 4.000 sec.

Determines the resonance time. The higher the value the longer the resonance.

- A high dispersion setting produces an early-reflections type reverberation effect.

● Roughness

≤ 0 ... 16.

This parameter imparts a “roughness” to the overall frequency response in the form of steep peaks and dips in the response. The higher the value the greater the roughness.

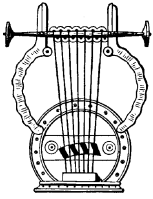

7: Resonator

```

EDIT/E1/MODIFIER/RESONATOR
@A07(007):Tull Flute/E1:Tull Flute
DL1 : DL2 : DL3 : DL4 : DL5
0.29 11.71 5.29 6.54[msec]
Decay Time = 106.1msec
LPF Cutoff Freq. = 4.05 kHz
Diffusion = 16 Phase = 0
Set
    
```

- This display will not appear — “Resonator is not used” will appear — if the “RES on/off” block in the “Impulse Expander & Resonator Setting” page is turned “off” (≥ Page 124). All level and balance settings relating to the Resonator are also available in that display page.
- Press the **[F8]** button (“Set”) to go directly to the “Impulse Expander & Resonator Setting” page.

While the Impulse Expander tends to give the sound a metallic quality, the Resonator produces a more woody resonance effect. Careful adjustment of the resonator’s parameters can often bring a not-quite-right voice to life.

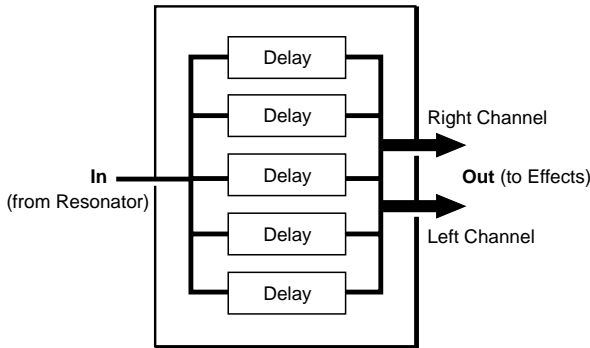

● DL1 ... DL5

≤ 0.29 msec ... 41.54 msec.

These parameters independently set the delay times for the Resonator’s five delay lines.

Delay times for “natural” effects can be calculated by dividing the instrument’s body dimensions by the speed of sound (34 centimeters per millisecond). For example, an instrument with a body which measures 68 cm x 34 cm would naturally include delay times of 2 msec ($68/34 = 2$ msec) and 1 msec ($34/34 = 1$ msec). These values can then be fine-adjusted to achieve the desired results.

● Decay Time

≤ 4,028 msec ... 4.000 sec.

Determines the length of decay of the sound. The higher the value the longer the decay.

● LPF Cutoff Freq.

≤ 31.1 Hz ... 24.0 kHz.

Sets the cutoff frequency of the low-pass filter. Produces a natural decay in the high-frequency components of the delay sound.

● Diffusion

≤ 0 ... 16.

Determines how the resonance sound “spreads” in the stereo sound field. The higher the value the wider the sound.

● Phase

≤ -16 ... 16.

Sets the phase of the resonance signal, changing its position in the stereo sound field. Positive values move the resonance sound to the left while negative values move it to the right.



Element Envelope

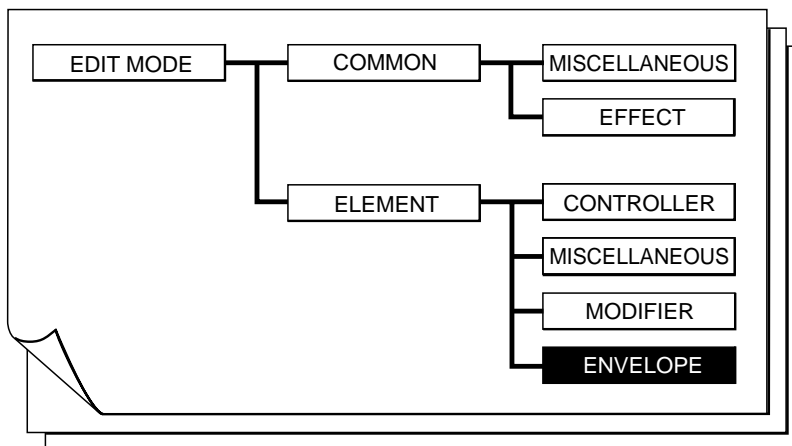

■ 1: Pressure	129	■ 4: Growl	141
■ 2: Embouchure & Pitch	130	● 4-1: Growl Speed Key Scaling	142
● 2-1: Embouchure & Pitch Hold Time Key Scaling	132	■ 5: Amplitude & Filter	143
● 2-2: Embouchure & Pitch Initial Level Key Scaling	133	● 5-1: Amplitude & Filter Attack Rate Key Scaling ..	146
● 2-3: Embouchure & Pitch Decay Rate Key Scaling	134	● 5-2: Amplitude & Filter Attack 1 Level Key Scaling	147
■ 3: Vibrato	135	● 5-3: Amplitude & Filter Decay Rate Key Scaling .	148
● 3-1: Vibrato Delay Time Key Scaling	137	● 5-4: Amplitude & Filter Sustain Level Key Scaling	149
● 3-2: Vibrato Attack Rate Key Scaling	138	● 5-5: Amplitude & Filter Release Rate Key Scaling	150
● 3-3: Vibrato Depth Key Scaling	139		
● 3-4: Vibrato Speed Key Scaling	140		

```

EDIT/E1
A07(007):Tull Flute/E1:Tull Flute
<Envelope>
1:Pressure 5:Amplitude&Filter
2:Embouchure&Pitch
3:Vibrato
4:Growl
Ctrl Misc Modi Env
    
```

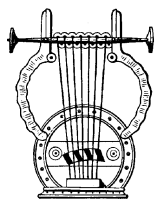

1: Pressure

```

EDIT/E1/ENU/PRESSURE
0A07(007):Tull Flute/E1:Tull Flute
EG Mode = ADSR
Attack Rate Offset = 0
Release Rate Offset = 0
Velocity Sens To Level = 16
                To Rate = 11
    
```

- Each VL1-m voice has its own pressure envelope which determines how it responds to pressure changes. The parameters in this display page determine how the pressure envelope is used and how it will respond to keyboard velocity.

● EG Mode

≤ Disable, ADSR, AR.

This parameter determines whether or how the pressure envelope will be used.

Disable	The voice's pressure envelope is not used, and pressure always corresponds exactly to the position or value of the controller assigned to pressure. If no controller is assigned the pressure is always maximum. In this case the "Attack Rate Offset", "Release Rate Offset", "Velocity Sens To Level", and "Velocity Sens To Rate" parameters have no effect.
ADSR	Pressure responds according to the attack, decay, sustain, and release settings of the voice's pressure envelope.
AR	Pressure responds according to the attack and release settings of the voice's pressure envelope. The decay and sustain settings are ignored.

● Attack Rate Offset

≤ -16 ... 16.

Adjusts the attack rate of the voice's pressure envelope. Positive values produce a faster attack while negative values produce a slower attack.

● Release Rate Offset

≤ -16 ... 16.

Adjusts the release rate of the voice's pressure envelope. Positive values produce a faster release while negative values produce a slower release.

● Velocity Sens To Level

≤ 0 ... 16.

Determines the relationship between pressure and keyboard velocity. When set to "0", keyboard velocity (i.e. how fast or hard the keyboard is played) has no effect on pressure. At values higher than "1", however, high keyboard velocities will increase the pressure and low keyboard velocities will decrease the pressure. The higher the value the greater the effect of keyboard velocity on pressure.

● Velocity Sens To Rate

≤ 0 ... 16.

Determines the relationship between the voice's pressure envelope rates (attack, decay, and release) and keyboard velocity. When set to "0", keyboard velocity (i.e. how fast or hard the keyboard is played) has no effect on the envelope rates. At values higher than "1", however, high keyboard velocities will increase the rates and low keyboard velocities will decrease the rates. The higher the value the greater the effect of keyboard velocity on the pressure envelope rates.

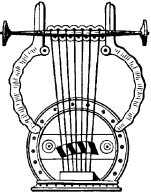

2: Embouchure & Pitch

```

EDIT/E1/ENV/EMBOUCHURE & PITCH
[A07<007>]:Tull Flute/E1:Tull Flute
VISns To Lvl = 5 VISns To Rate = 2
Dpth To Emb = 0 Dpth To Pch = 0
Hold Time = 00
Initial Lvl = 00
Decay Rate = 1270
    
```

- Each VL1-m voice has its own embouchure & pitch envelope which determines how it responds to embouchure and pitch changes. The parameters in this display page determine how the embouchure & pitch envelope is used and how it will respond to keyboard velocity.
- An inverse "K" (K) next to a value means that key scaling can be applied to that parameter. Position the cursor at the appropriate parameter and then press the [F7] button ("KSC") to go directly to the key scaling page for that parameter. You can return to the embouchure & pitch envelope parameter page by pressing the [EXIT] button.

● VISns To Lvl

≤ 0 ... 16.

Determines the relationship between embouchure/pitch and keyboard velocity. When set to "0", keyboard velocity (i.e. how fast or hard the keyboard is played) has no effect on embouchure or pitch. At values higher than "1", however, high keyboard velocities produce a higher embouchure and pitch variation while low keyboard velocities produce a smaller variation. The higher the value the greater the effect of keyboard velocity on embouchure & pitch.

● VISns To Rate

≤ -16 ... 16.

Determines the relationship between the voice's embouchure & pitch envelope decay rate and keyboard velocity. When set to "0", keyboard velocity (i.e. how fast or hard the keyboard is played) has no effect on the decay rate. At values higher than "1",



however, high keyboard velocities will increase the decay rate and low keyboard velocities will decrease the decay rate. Negative values have the opposite effect. The higher the value the greater the effect of keyboard velocity on the embouchure & pitch envelope decay rate.

● Dpth To Emb

$\leq 0 \dots 64.$

This parameter determines how deeply the settings in this display page affect embouchure. The higher the value the greater the effect.

● Dpth To Ptch

$\leq 0 \dots 64.$

This parameter determines how deeply the settings in this display page affect pitch. The higher the value the greater the effect.

● Hold Time

$\leq 0 \dots 127.$

Sets the hold time of the embouchure & pitch envelope. That is, the length of time the initial envelope level is held before the decay portion of the envelope begins (see “Initial Lvl”, below). The higher the value the longer the hold time.

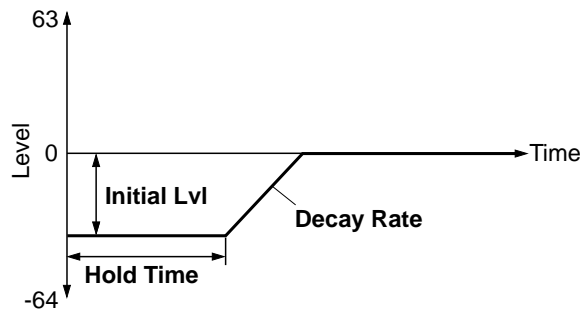

● Initial Lvl

$\leq -64 \dots 63.$

Sets the initial level of the embouchure & pitch envelope. That is, the level of the envelope (pitch in the case of the pitch parameter) at the instant a key is played. The higher the value the higher the initial level.

- If the “Initial Lvl” parameter is set to “0” the embouchure & pitch envelope has no effect.

● Decay Rate

$\leq 0 \dots 127.$

Sets the decay rate of the embouchure & pitch envelope. That is, the rate at which the envelope level (pitch in the case of the pitch parameter) changes from the initial level to “0” after the hold time has elapsed. The higher the value the faster the decay rate.



2-1: Embouchure & Pitch Hold Time Key Scaling

Embouchure & pitch hold time key scaling produces natural hold time variations across the range of the keyboard by allowing different hold time offset values to be applied to each of two breakpoints set at appropriate keys.

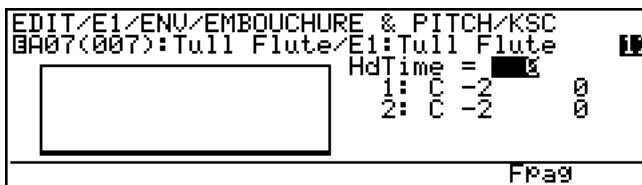

- The **[F7]** button (“Fpa9”) can be used to go directly forward to the next Embouchure & Pitch key scaling page without having to return to the main parameter page.

● HdTime

≤ 0 ... 127.

The “HdTime” parameter is linked to the main Embouchure & Pitch “Hold Time” parameter, and has the same effect. This value also determines the hold time on which all key-scaled variations are based (indicated by a dotted line on the graph).

● Breakpoint 1 & 2 Key

≤ C-2 ... G8.

Allows two separate key scaling breakpoints to be set at any notes between C-2 and G8. You can position the cursor at the appropriate breakpoint key parameter and use any of the normal data entry procedures, or use a keyboard. To use a keyboard for breakpoint entry, position the cursor at the appropriate breakpoint key parameter, press the **[F8]** button (“Kbd”), and then press the key at which you want to set the breakpoint while “Kbd” appears in inverse characters.

No breakpoint can be set to a key lower than the breakpoint to its left.

● Breakpoint 1 & 2 Offset

≤ -64 ... 63.

Set the amount of hold time offset for each of the breakpoints defined by the breakpoint key parameters, above. Negative values reduce the hold time, and positive values increase the hold time at the corresponding breakpoint. No matter what offset value is chosen, the actual hold time will never exceed its minimum or maximum absolute value. When different offset values are applied to adjacent breakpoints, the hold time varies smoothly between the breakpoints.

NOTES

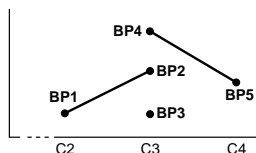

■ If two breakpoints are set to the same note, the lower one functions as the end of the key scaling segment connecting to the next lowest breakpoint while the higher one functions as the end of the segment connecting to the next highest breakpoint. Further, the higher breakpoint applies to the specified note while the lower one actually applies to the next note to its left. If more than two breakpoints are set to the same note, only the lowest and highest of these will function as ends of the corresponding key scaling segments while the rest are ignored.

2-2: Embouchure & Pitch Initial Level Key Scaling

Embouchure & pitch initial level key scaling produces natural initial level variations across the range of the keyboard by allowing different level offset values to be applied to each of two breakpoints set at appropriate keys.

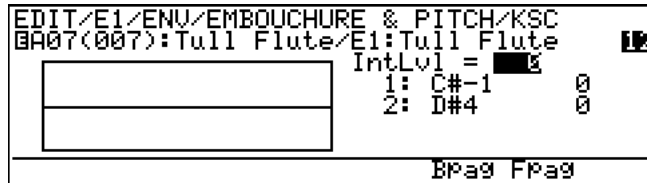

- The **[F6]** and **[F7]** buttons (“Bpag” and “Fpag”) can be used to go directly backward or forward to the next Embouchure & Pitch key scaling page without having to return to the main parameter page.

● IntLvl

≤ -64 ... 63.

The “IntLvl” parameter is linked to the main Embouchure & Pitch “Initial Level” parameter, and has the same effect. This value also determines the main initial level on which all key-scaled variations are based (indicated by a dotted line on the graph).

● Breakpoint 1 & 2 Key

≤ C-2 ... G8.

Allows two separate key scaling breakpoints to be set at any notes between C-2 and G8. You can position the cursor at the appropriate breakpoint key parameter and use any of the normal data entry procedures, or use a keyboard. To use a keyboard for breakpoint entry, position the cursor at the appropriate breakpoint key parameter, press the **[F8]** button (“Kbd”), and then press the key at which you want to set the breakpoint while “Kbd” appears in inverse characters.

No breakpoint can be set to a key lower than the breakpoint to its left.

● Breakpoint 1 & 2 Offset

≤ -64 ... 63.

Set the amount of initial level offset for each of the breakpoints defined by the breakpoint key parameters, above. Negative values reduce the initial level, and positive values increase the initial level at the corresponding breakpoint. No matter what offset value is chosen, the actual initial level will never exceed its minimum or maximum absolute value. When different offset values are applied to adjacent breakpoints, the initial level varies smoothly between the breakpoints.

2-3: Embouchure & Pitch Decay Rate Key Scaling

Embouchure & pitch decay rate key scaling produces natural decay rate variations across the range of the keyboard by allowing different rate offset values to be applied to each of two breakpoints set at appropriate keys.

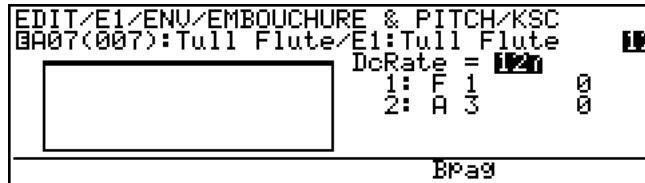

- The **[F6]** button (“Bpag”) can be used to go directly backward to the next Embouchure & Pitch key scaling page without having to return to the main parameter page.

● DcRate

≤ 0 ... 127.

The “DcRate” parameter is linked to the main Embouchure & Pitch “Decay Rate” parameter, and has the same effect. This value also determines the main decay rate on which all key-scaled variations are based (indicated by a dotted line on the graph).

● Breakpoint 1 & 2 Key

≤ C-2 ... G8.

Allows two separate key scaling breakpoints to be set at any notes between C-2 and G8. You can position the cursor at the appropriate breakpoint key parameter and use any of the normal data entry procedures, or use a keyboard. To use a keyboard for breakpoint entry, position the cursor at the appropriate breakpoint key parameter, press the **[F8]** button (“Kbd”), and then press the key at which you want to set the breakpoint while “Kbd” appears in inverse characters.

No breakpoint can be set to a key lower than the breakpoint to its left.

● Breakpoint 1 & 2 Offset

≤ -64 ... 63.

Set the amount of decay rate offset for each of the breakpoints defined by the breakpoint key parameters, above. Negative values reduce the decay rate, and positive values increase the decay rate at the corresponding breakpoint. No matter what offset value is chosen, the actual decay rate will never exceed its minimum or maximum absolute value. When different offset values are applied to adjacent breakpoints, the decay rate varies smoothly between the breakpoints.

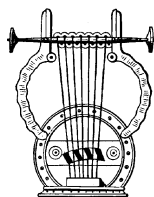

3: Vibrato

```

EDIT/E1/ENU/VIBRATO
BA07(007):Tull Flute/E1:Tull Flute
Delay Time = 84[K] Attack Rate = 105[K]
Sustain Lvl = 0 Vibrato Dpth = 127[K]
Dpth To Emb = 60 Dpth To Ptch = 16
Offset = 0 Randomness = 0
Speed = 59[K] Speed Shift = 0
KSC Ctrl
    
```

- An inverse “K”(K) next to a value means that key scaling can be applied to that parameter. Position the cursor at the appropriate parameter and then press the (F7) button (“KSC”) to go directly to the key scaling page for that parameter. You can return to the vibrato parameter page by pressing the (EXIT) button.
- The (F8) button (“Ctrl”) can be used to go directly to the vibrato controller page (≥ Page 69), also available from the ELEMENT CONTROLLER directory. You can then return to the vibrato parameter page by pressing (F8) (“Para”) again.
- The “Delay Time”, “Attack Rate”, and “Sustain Lvl” parameters define the vibrato effect at all times, and do not affect vibrato as controlled via a controller.

● Delay Time

≤ 0 ... 127.

Sets the delay time between the instant a note is played and the beginning of the vibrato effect. The higher the value the longer the delay.

● Attack Rate

≤ 0 ... 127.

This parameter produces a gradual increase in vibrato depth when the vibrato effect begins. The higher the value the faster the attack rate and therefore the faster the vibrato “fade in”.

● Sustain Lvl

≤ 0 ... 127.

Sets the final vibrato depth after the delay time and attack have passed. The higher the value the greater the vibrato depth. This parameter sets the vibrato depth independently of the depth applied by the controller assigned to vibrato. If you want to apply vibrato via a controller only, set this parameter to “0”.

● Vibrato Dpth

≤ 0 ... 127.

Sets the vibrato depth as applied by the controller assigned to vibrato (≥ Page 69) and the vibrato envelope generator controlled by the “Delay Time”, “Attack Rate”, and “Sustain Lvl” parameters. The higher the value the greater the vibrato depth. When set to “0” no vibrato can be applied via a controller or the vibrato envelope generator.

● Dpth to Emb $\leq 0 \dots 127.$

Determines how deeply the settings in this display page affect embouchure. The higher the value the greater the effect. When set to “0” no embouchure vibrato can be applied.

● Dpth to Ptch $\leq 0 \dots 127.$

Determines how deeply the settings in this display page affect pitch. The higher the value the greater the effect. When set to “0” no pitch vibrato can be applied.

● Offset $\leq -127 \dots 127.$

Sets the central value around which the vibrato variation occurs. For example, if the “Dpth to Ptch” parameter is set to a high value and “Offset” is set to “0”, then the vibrato will swing equally above and below the actual pitch of the note played. Higher offset values shift the central vibrato pitch upward while lower values shift the pitch downward.

● Randomness $\leq 0 \dots 10.$

The “Randomness” parameter can be used to introduce random variations in the depth and speed of the vibrato effect. The higher the value the greater the random variation.

● Speed $\leq 0 \dots 127.$

Sets the speed of the vibrato effect. The higher the value the faster the vibrato.

● Speed Shift $\leq 0 \dots 8.$

Determines the amount of speed variation which can be applied via the controller assigned to vibrato. The higher the value the greater the increase in speed. At the maximum setting of “8” the speed can be increased to a maximum of 6 times its normal setting via the controller.

3-1: Vibrato Delay Time Key Scaling

Vibrato delay time key scaling produces natural delay time variations across the range of the keyboard by allowing different delay time offset values to be applied to each of two breakpoints set at appropriate keys.



- The **F7** button (“Fpag”) can be used to go directly forward to the next Vibrato key scaling page without having to return to the main parameter page.

● DlTime

≤ 0 ... 127.

The “DlTime” parameter is linked to the main Vibrato “Delay Time” parameter, and has the same effect. This value also determines the main delay time on which all key-scaled variations are based (indicated by a dotted line on the graph).

● Breakpoint 1 & 2 Key

≤ C-2 ... G8.

Allows two separate key scaling breakpoints to be set at any notes between C-2 and G8. You can position the cursor at the appropriate breakpoint key parameter and use any of the normal data entry procedures, or use a keyboard. To use a keyboard for breakpoint entry, position the cursor at the appropriate breakpoint key parameter, press the **F8** button (“Kbd”), and then press the key at which you want to set the breakpoint while “Kbd” appears in inverse characters.

No breakpoint can be set to a key lower than the breakpoint to its left.

● Breakpoint 1 & 2 Offset

≤ -64 ... 63.

Set the amount of delay time offset for each of the breakpoints defined by the breakpoint key parameters, above. Negative values reduce the delay time, and positive values increase the delay time at the corresponding breakpoint. No matter what offset value is chosen, the actual delay time will never exceed its minimum or maximum absolute value. When different offset values are applied to adjacent breakpoints, the delay time varies smoothly between the breakpoints.

3-2: Vibrato Attack Rate Key Scaling

Vibrato attack rate key scaling produces natural attack rate variations across the range of the keyboard by allowing different rate offset values to be applied to each of two breakpoints set at appropriate keys.



- The **[F6]** and **[F7]** buttons (“Bpag” and “Fpag”) can be used to go directly backward or forward to the next Vibrato key scaling page without having to return to the main parameter page.

● AtRate

≤ 0 ... 127.

The “AtRate” parameter is linked to the main Vibrato “Attack Rate” parameter, and has the same effect. This value also determines the main attack rate on which all key-scaled variations are based (indicated by a dotted line on the graph).

● Breakpoint 1 & 2 Key

≤ C-2 ... G8.

Allows two separate key scaling breakpoints to be set at any notes between C-2 and G8. You can position the cursor at the appropriate breakpoint key parameter and use any of the normal data entry procedures, or use a keyboard. To use a keyboard for breakpoint entry, position the cursor at the appropriate breakpoint key parameter, press the **[F8]** button (“Kbd”), and then press the key at which you want to set the breakpoint while “Kbd” appears in inverse characters.

No breakpoint can be set to a key lower than the breakpoint to its left.

● Breakpoint 1 & 2 Offset

≤ -64 ... 63.

Set the amount of attack rate offset for each of the breakpoints defined by the breakpoint key parameters, above. Negative values reduce the attack rate, and positive values increase the attack rate at the corresponding breakpoint. No matter what offset value is chosen, the actual attack rate will never exceed its minimum or maximum absolute value. When different offset values are applied to adjacent breakpoints, the attack rate varies smoothly between the breakpoints.

3-3: Vibrato Depth Key Scaling

Vibrato depth key scaling produces natural vibrato depth variations across the range of the keyboard by allowing different depth offset values to be applied to each of two breakpoints set at appropriate keys.



- The **F6** and **F7** buttons (“Bpag” and “Fpag”) can be used to go directly backward or forward to the next Vibrato key scaling page without having to return to the main parameter page.

● Depth

≤ 0 ... 127.

The “Depth” parameter is linked to the main Vibrato “Vibrato Dpth” parameter, and has the same effect. This value also determines the main depth on which all key-scaled variations are based (indicated by a dotted line on the graph).

● Breakpoint 1 & 2 Key

≤ C-2 ... G8.

Allows two separate key scaling breakpoints to be set at any notes between C-2 and G8. You can position the cursor at the appropriate breakpoint key parameter and use any of the normal data entry procedures, or use a keyboard. To use a keyboard for breakpoint entry, position the cursor at the appropriate breakpoint key parameter, press the **F8** button (“Kbd”), and then press the key at which you want to set the breakpoint while “Kbd” appears in inverse characters.

No breakpoint can be set to a key lower than the breakpoint to its left.

● Breakpoint 1 & 2 Offset

≤ -64 ... 63.

Set the amount of depth offset for each of the breakpoints defined by the breakpoint key parameters, above. Negative values reduce the vibrato depth, and positive values increase the vibrato depth at the corresponding breakpoint. No matter what offset value is chosen, the actual depth will never exceed its minimum or maximum absolute value. When different offset values are applied to adjacent breakpoints, the vibrato depth varies smoothly between the breakpoints.

3-4: Vibrato Speed Key Scaling

Vibrato speed key scaling produces natural vibrato speed variations across the range of the keyboard by allowing different speed offset values to be applied to each of two breakpoints set at appropriate keys.



- The **[F6]** button (“Bpag”) can be used to go directly backward to the next Vibrato key scaling page without having to return to the main parameter page.

● Speed

≤ 0 ... 127.

The “Speed” parameter is linked to the main Vibrato “Speed” parameter, and has the same effect. This value also determines the main speed setting on which all key-scaled variations are based (indicated by a dotted line on the graph).

● Breakpoint 1 & 2 Key

≤ C-2 ... G8.

Allows two separate key scaling breakpoints to be set at any notes between C-2 and G8. You can position the cursor at the appropriate breakpoint key parameter and use any of the normal data entry procedures, or use a keyboard. To use a keyboard for breakpoint entry, position the cursor at the appropriate breakpoint key parameter, press the **[F8]** button (“Kbd”), and then press the key at which you want to set the breakpoint while “Kbd” appears in inverse characters.

No breakpoint can be set to a key lower than the breakpoint to its left.

● Breakpoint 1 & 2 Offset

≤ -64 ... 63.

Set the amount of speed offset for each of the breakpoints defined by the breakpoint key parameters, above. Negative values reduce the vibrato speed, and positive values increase the vibrato speed at the corresponding breakpoint. No matter what offset value is chosen, the actual speed will never exceed its minimum or maximum absolute value. When different offset values are applied to adjacent breakpoints, the vibrato speed varies smoothly between the breakpoints.

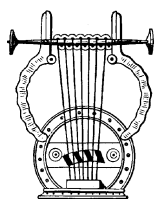

4: Growl

```

EDIT/E1/ENU/GROWL
B007(007):Tull Flute/E1:Tull Flute
Dpth To Pres = 127 Dpth to BNois = 127
Offset       = 0
Vibrato Sync = off
Speed       = 86
Randomness  = 6
                                                    Ctrl
    
```

- An inverse “K”(Ⓚ) next to a value means that key scaling can be applied to that parameter. Position the cursor at the appropriate parameter and then press the (F7) button (“KSC”) to go directly to the key scaling page for that parameter. You can return to the growl parameter page by pressing the (EXIT) button.
- The (F8) button (“Ctrl”) can be used to go directly to the growl controller page (≥ Page 74), also available from the ELEMENT CONTROLLER directory. You can then return to the growl parameter page by pressing (F8) (“Para”) again.

● Dpth to Pres

≤ 0 ... 127.

Determines how deeply the settings in this display page affect pressure. The higher the value the greater the effect. No growl effect will be produced if this and the “Dpth to BNoise” parameter, below, are set to “0”.

● Dpth to BNoise

≤ 0 ... 127.

Determines how deeply the settings in this display page affect breath noise. The higher the value the greater the effect. No growl effect will be produced if this and the “Dpth to Pres” parameter, above, are set to “0”.

● Offset

≤ -127 ... 127.

Sets the central value around which the growl variation occurs. For example, if the “Dpth to Pres” parameter is set to a high value and “Offset” is set to “0”, then the growl variation will swing equally above and below the the actual pressure of the note played. Higher offset values shift the central pressure value upward while lower values shift the pressure downward. No growl effect will be produced when this parameter is set to “127”.

● Vibrato Sync

≤ off, on.

Allows the growl variation to be synchronized to vibrato.

off	The growl variation is independent from the vibrato variation.
on	Growl speed and randomness are synchronized to the same vibrato parameters. In this case the speed and randomness parameters, listed below, will not appear.

● Speed

≤ 0 ... 127.

Sets the speed of the growl effect. The higher the value the faster the growl.

● Randomness

≤ 0 ... 10.

The “Randomness” parameter can be used to introduce random variations in the speed of the growl effect. The higher the value the greater the random variation.

4-1: Growl Speed Key Scaling

Growl speed key scaling produces natural growl speed variations across the range of the keyboard by allowing different speed offset values to be applied to each of two breakpoints set at appropriate keys.

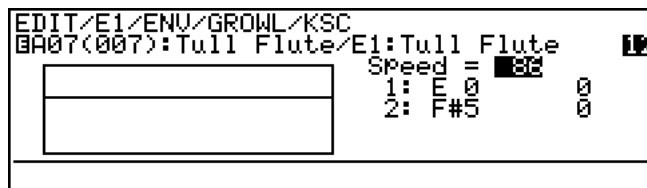

● Speed

≤ 0 ... 127.

The “Speed” parameter is linked to the main Growl “Speed” parameter, and has the same effect. This value also determines the main speed setting on which all key-scaled variations are based (indicated by a dotted line on the graph).

● Breakpoint 1 & 2 Key

≤ C-2 ... G8.

Allows two separate key scaling breakpoints to be set at any notes between C-2 and G8. You can position the cursor at the appropriate breakpoint key parameter and use any of the normal data entry procedures, or use a keyboard. To use a keyboard for breakpoint entry, position the cursor at the appropriate breakpoint key parameter, press the **[F8]** button (“Kbd”), and then press the key at which you want to set the breakpoint while “Kbd” appears in inverse characters.

No breakpoint can be set to a key lower than the breakpoint to its left.

● Breakpoint 1 & 2 Offset

≤ -64 ... 63.

Set the amount of speed offset for each of the breakpoints defined by the breakpoint key parameters, above. Negative values reduce the growl speed, and positive values increase the growl speed at the corresponding breakpoint. No matter what offset value is chosen, the actual speed will never exceed its minimum or maximum absolute value. When different offset values are applied to adjacent breakpoints, the growl speed varies smoothly between the breakpoints.

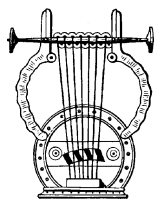

5: Amplitude & Filter

```

EDIT/E1/ENV/AMPLITUDE & FILTER
BA07(007):Tull Flute/E1:Tull Flute
Velocity Sens To Level = 10
                    To Rate = 12
Depth To Amplitude = 127
                    To Filter = 0
Sens EG
    
```

```

EDIT/E1/ENV/AMPLITUDE & FILTER
BA07(007):Tull Flute/E1:Tull Flute
Rate Level
Attack1 = 127[K] Attack1 = 1270
Attack2 = 1270
Decay = 1270 Sustain = 1270
Release = 900
Sens EG KSC
    
```

- Two display pages are provided for Amplitude & Filter control. One contains parameters pertaining to keyboard velocity sensitivity (“Sens”), while the other contains the envelope generator parameters (“EG”). The **[F1]** and **[F2]** buttons select these two display pages, respectively.
- An inverse “K”(**[K]**) next to a value in the “EG” page means that key scaling can be applied to that parameter. Position the cursor at the appropriate parameter and then press the **[F7]** button (“KSC”) to go directly to the key scaling page for that parameter. You can return to the growl parameter page by pressing the **[EXIT]** button.

The Sensitivity Parameters

The parameters in the “Sens” page determine how the envelope settings in the “Env” are affected by keyboard velocity.

● Velocity Sens To Level

≤ 0 ... 16.

Determines the relationship between the Amplitude & Filter envelope level and keyboard velocity. When set to “0”, keyboard velocity (i.e. how fast or hard the keyboard is played) has no effect on the envelope level. At values higher than “1”, however, high keyboard velocities will increase the envelope level and low keyboard velocities will decrease the envelope level. The higher the value the greater the effect of keyboard velocity on the envelope level.

● Velocity Sens To Rate

≤ 0 ... 16.

Determines the relationship between the Amplitude & Filter envelope rates and keyboard velocity. When set to “0”, keyboard velocity (i.e. how fast or hard the keyboard is played) has no effect on the envelope rates. At values higher than “1”, however, high keyboard velocities will increase the envelope rates and low keyboard velocities will

decrease the rates. The higher the value the greater the effect of keyboard velocity on the envelope rates.

● Depth To Amplitude

$\leq 0 \dots 127.$

Determines how deeply the Amplitude & Filter envelope will affect amplitude. The higher the value the greater the effect.

● Depth To Filter

$\leq -127 \dots 127.$

Determines how deeply the Amplitude & Filter envelope will affect the cutoff frequency of the Dynamic Filter. The higher the value the greater the effect. Negative values invert the effect of the envelope on the filter.

The Envelope Parameters

The parameters in this page set the actual “shape” of the envelope used for amplitude and filter control. The parameters correspond to the envelope as shown in the diagram below.

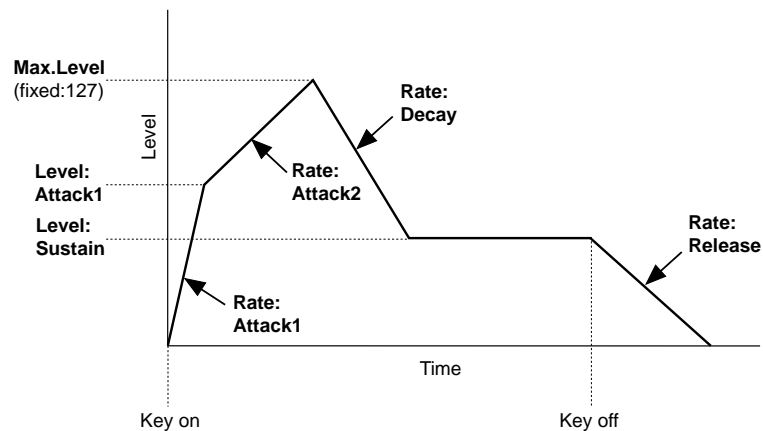

● Rate: Attack1

$\leq 0 \dots 127.$

Determines the rate at which the envelope level goes from “0” to the level set by the “Level: Attack1” parameter. The higher the value the faster the attack.

● Rate: Attack2

$\leq 0 \dots 127.$

Determines the rate at which the envelope level goes from the level set by the “Level: Attack1” parameter to maximum level. The higher the value the faster the attack.



● Rate: Decay

≤ 0 ... 127.

Determines the rate at which the envelope level goes from maximum level to the sustain level set by the “Level: Sustain” parameter. The higher the value the faster the decay.

● Rate: Release

≤ 0 ... 127.

Determines the rate at which the envelope level goes from the sustain level to “0” when the key is released. The higher the value the faster the release.

● Level: Attack1

≤ 0 ... 127.

Sets the envelope level reached by the first portion of the attack, as determined by the “Rate: Attack1” parameter. The higher the value the higher the level. When set to “127” the attack 1 level becomes the same as the maximum level, therefore the second portion of the attack (“Rate: Attack2” parameter) will not be produced.

● Level: Sustain

≤ 0 ... 127.

Sets the envelope sustain level. The higher the value the higher the level. When set to “127” the sustain level becomes the same as the maximum level, therefore the decay portion of the envelope (“Rate: Decay” parameter) will not be produced.

5-1: Amplitude & Filter Attack Rate Key Scaling

Amplitude & Filter attack rate key scaling produces natural attack rate variations across the range of the keyboard by allowing different rate offset values to be applied to each of two breakpoints set at appropriate keys.

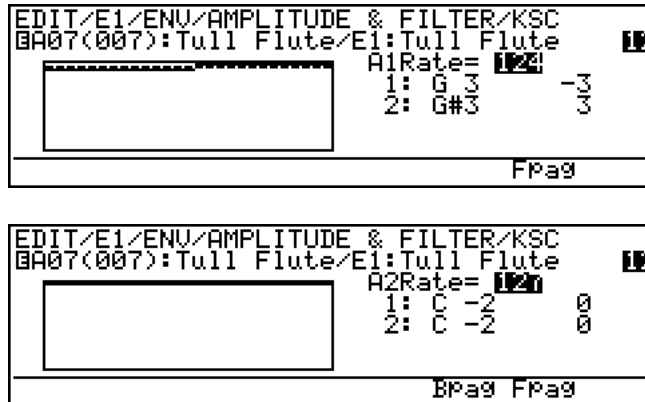

- The **[F6]** and **[F7]** buttons (“Bpag” and “Fpag”) can be used to go directly backward or forward to the next Amplitude & Filter key scaling page without having to return to the main parameter page.

● A1Rate, A2Rate

≤ 0 ... 127.

The “A1Rate” and “A2Rate” parameters are linked to the main Amplitude & Filter “Rate: Attack1” and “Rate: Attack2” parameters, and have the same effect. These values also determine the main attack rates on which all key-scaled variations are based (indicated by a dotted line on the graph).

● Breakpoint 1 & 2 Key

≤ C-2 ... G8.

Allows two separate key scaling breakpoints to be set at any notes between C-2 and G8. You can position the cursor at the appropriate breakpoint key parameter and use any of the normal data entry procedures, or use a keyboard. To use a keyboard for breakpoint entry, position the cursor at the appropriate breakpoint key parameter, press the **[F8]** button (“Kbd”), and then press the key at which you want to set the breakpoint while “Kbd” appears in inverse characters.

No breakpoint can be set to a key lower than the breakpoint to its left.

● Breakpoint 1 & 2 Offset

≤ -64 ... 63.

Set the amount of attack rate offset for each of the breakpoints defined by the breakpoint key parameters, above. Negative values reduce the attack rate, and positive values increase the attack rate at the corresponding breakpoint. No matter what offset value is chosen, the actual attack rate will never exceed its minimum or maximum absolute value. When different offset values are applied to adjacent breakpoints, the attack rate varies smoothly between the breakpoints.

5-2: Amplitude & Filter Attack 1 Level Key Scaling

Amplitude & Filter attack level key scaling produces natural attack level variations across the range of the keyboard by allowing different level offset values to be applied to each of two breakpoints set at appropriate keys.



- The **[F6]** and **[F7]** buttons (“Bpag” and “Fpag”) can be used to go directly backward or forward to the next Amplitude & Filter key scaling page without having to return to the main parameter page.

● A1Lvl

≤ 0 ... 127.

The “A1Lvl” parameter is linked to the main Amplitude & Filter “Level: Attack1” parameter, and has the same effect. This value also determines the main attack 1 level on which all key-scaled variations are based (indicated by a dotted line on the graph).

● Breakpoint 1 & 2 Key

≤ C-2 ... G8.

Allows two separate key scaling breakpoints to be set at any notes between C-2 and G8. You can position the cursor at the appropriate breakpoint key parameter and use any of the normal data entry procedures, or use a keyboard. To use a keyboard for breakpoint entry, position the cursor at the appropriate breakpoint key parameter, press the **[F8]** button (“Kbd”), and then press the key at which you want to set the breakpoint while “Kbd” appears in inverse characters.

No breakpoint can be set to a key lower than the breakpoint to its left.

● Breakpoint 1 & 2 Offset

≤ -64 ... 63.

Set the amount of attack 1 level offset for each of the breakpoints defined by the breakpoint key parameters, above. Negative values reduce the attack 1 level, and positive values increase the attack 1 level at the corresponding breakpoint. No matter what offset value is chosen, the actual attack 1 level will never exceed its minimum or maximum absolute value. When different offset values are applied to adjacent breakpoints, the attack 1 level varies smoothly between the breakpoints.

5-3: Amplitude & Filter Decay Rate Key Scaling

Amplitude & Filter decay rate key scaling produces natural decay rate variations across the range of the keyboard by allowing different rate offset values to be applied to each of two breakpoints set at appropriate keys.

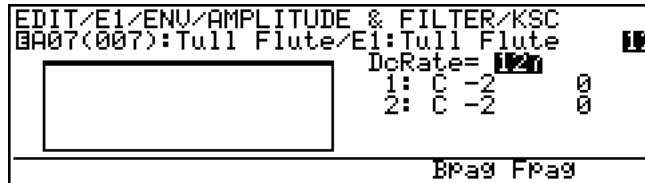

- The **[F6]** and **[F7]** buttons (“Bpa9” and “Fpa9”) can be used to go directly backward or forward to the next Amplitude & Filter key scaling page without having to return to the main parameter page.

● DcRate

≤ 0 ... 127.

The “DcRate” parameter is linked to the main Amplitude & Filter “Rate: Decay” parameter, and has the same effect. This value also determines the main decay rate on which all key-scaled variations are based (indicated by a dotted line on the graph).

● Breakpoint 1 & 2 Key

≤ C-2 ... G8.

Allows two separate key scaling breakpoints to be set at any notes between C-2 and G8. You can position the cursor at the appropriate breakpoint key parameter and use any of the normal data entry procedures, or use a keyboard. To use a keyboard for breakpoint entry, position the cursor at the appropriate breakpoint key parameter, press the **[F8]** button (“Kbd”), and then press the key at which you want to set the breakpoint while “Kbd” appears in inverse characters.

No breakpoint can be set to a key lower than the breakpoint to its left.

● Breakpoint 1 & 2 Offset

≤ -64 ... 63.

Set the amount of decay rate offset for each of the breakpoints defined by the breakpoint key parameters, above. Negative values reduce the decay rate, and positive values increase the decay rate at the corresponding breakpoint. No matter what offset value is chosen, the actual decay rate will never exceed its minimum or maximum absolute value. When different offset values are applied to adjacent breakpoints, the decay rate varies smoothly between the breakpoints.

5-4: Amplitude & Filter Sustain Level Key Scaling

Amplitude & Filter sustain level key scaling produces natural sustain level variations across the range of the keyboard by allowing different level offset values to be applied to each of two breakpoints set at appropriate keys.

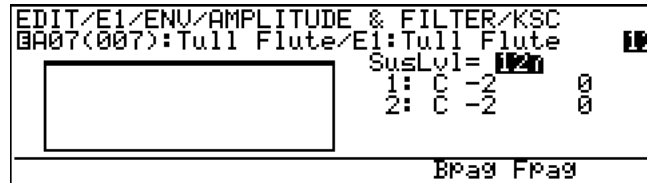

- The **[F6]** and **[F7]** buttons (“Bpa9” and “Fpa9”) can be used to go directly backward or forward to the next Amplitude & Filter key scaling page without having to return to the main parameter page.

● SusLvl

≤ 0 ... 127.

The “SusLvl” parameter is linked to the main Amplitude & Filter “Level : Sustain” parameter, and has the same effect. This value also determines the main sustain level on which all key-scaled variations are based (indicated by a dotted line on the graph).

● Breakpoint 1 & 2 Key

≤ C-2 ... G8.

Allows two separate key scaling breakpoints to be set at any notes between C-2 and G8. You can position the cursor at the appropriate breakpoint key parameter and use any of the normal data entry procedures, or use a keyboard. To use a keyboard for breakpoint entry, position the cursor at the appropriate breakpoint key parameter, press the **[F8]** button (“Kbd”), and then press the key at which you want to set the breakpoint while “Kbd” appears in inverse characters.

No breakpoint can be set to a key lower than the breakpoint to its left.

● Breakpoint 1 & 2 Offset

≤ -64 ... 63.

Set the amount of sustain level offset for each of the breakpoints defined by the breakpoint key parameters, above. Negative values reduce the sustain level, and positive values increase the sustain level at the corresponding breakpoint. No matter what offset value is chosen, the actual sustain level will never exceed its minimum or maximum absolute value. When different offset values are applied to adjacent breakpoints, the sustain level varies smoothly between the breakpoints.

5-5: Amplitude & Filter Release Rate Key Scaling

Amplitude & Filter release rate key scaling produces natural release rate variations across the range of the keyboard by allowing different rate offset values to be applied to each of two breakpoints set at appropriate keys.



- The **[F6]** button (“Bpag” and “Fpag”) can be used to go directly backward to the next Amplitude & Filter key scaling page without having to return to the main parameter page.

● RlRate

≤ 0 ... 127.

The “RlRate” parameter is linked to the main Amplitude & Filter “Rate: Release” parameter, and has the same effect. This value also determines the main release rate on which all key-scaled variations are based (indicated by a dotted line on the graph).

● Breakpoint 1 & 2 Key

≤ C-2 ... G8.

Allows two separate key scaling breakpoints to be set at any notes between C-2 and G8. You can position the cursor at the appropriate breakpoint key parameter and use any of the normal data entry procedures, or use a keyboard. To use a keyboard for breakpoint entry, position the cursor at the appropriate breakpoint key parameter, press the **[F8]** button (“Kbd”), and then press the key at which you want to set the breakpoint while “Kbd” appears in inverse characters.

No breakpoint can be set to a key lower than the breakpoint to its left.

● Breakpoint 1 & 2 Offset

≤ -64 ... 63.

Set the amount of release rate offset for each of the breakpoints defined by the breakpoint key parameters, above. Negative values reduce the release rate, and positive values increase the release rate at the corresponding breakpoint. No matter what offset value is chosen, the actual release rate will never exceed its minimum or maximum absolute value. When different offset values are applied to adjacent breakpoints, the release rate varies smoothly between the breakpoints.

Utility Mode



The UTILITY mode provides access to a range of functions that do not necessarily affect the instrument's sound or how it plays. Select the UTILITY mode from either the EDIT or PLAY mode by pressing the **UTILITY** button.

System	152
MIDI Bulk Dump	160
Disk	162
Edit Recall	172
Demo	174

System

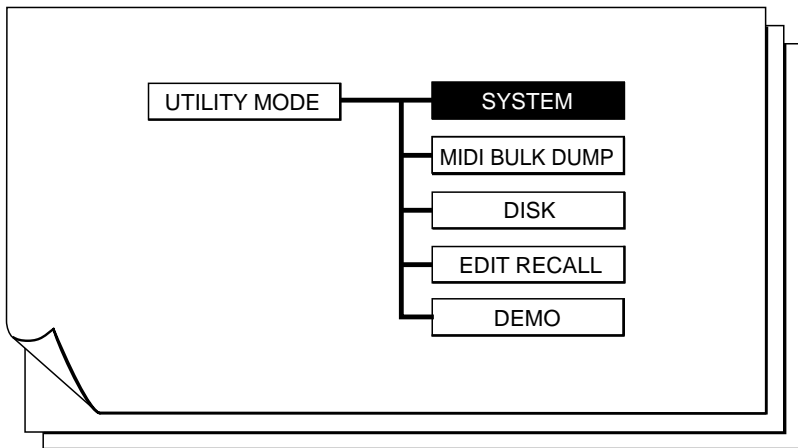

■ 1: TG Setting	153
■ 2: MIDI Setting	154
■ 3: PGM Change Table	155
■ 4: BC Curve	156
■ 5: Miscellaneous	157

```
UTIL
<System>
1: TG Setting      5: Miscellaneous
2: MIDI Setting
3: PGM Change Table
4: BC Curve
SYS Bulk Disk Recl Demo
```



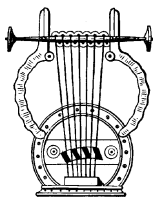

1: TG Setting

```

UTIL/SYSTEM/TG SETTING
Master Tuning = 0
Reverb       = on
Output       = Stereo
WX Lip       = Normal
Sys Bulk Disk Recl Demo
    
```

● Master Tuning

≤ -64 ... 63.

Fine tunes the overall pitch of the VL1-m in approximately 1.17-cent steps (a “cent” is 1/100th of a semitone). The maximum minus setting of “-64” produces a downward pitch shift of almost three-quarters of a semitone, and the maximum plus setting of “63” produces an upward pitch shift of the same amount. A setting of “0” produces no pitch change.

● Reverb

≤ off, on.

Turns the VL1-m’s internal reverb system off or on. This can be handy if you want to use an external signal processor for rverberation.

● Output

≤ Monaural, Stereo.

Determines whether the VL1-m output is delivered in mono or stereo. When the “Monaural” setting is selected the same signal is output via the both the L and R OUTPUT jacks. Also, in the mono mode all parameters relating to panning or positioning in the stereo sound field have no effect.

● WX Lip

≤ Normal, Expand.

This parameter can be set to “Expand” when using a WX11 or WX7 Wind Controller in the tight-lip mode to expand the normally limited lip pitch bend range of these controllers to the full range available on the VL1-m.

Set to “Normal” when using a WX11 or WX7 in the loose-lip mode, or when using a keyboard or other non-wind controller.

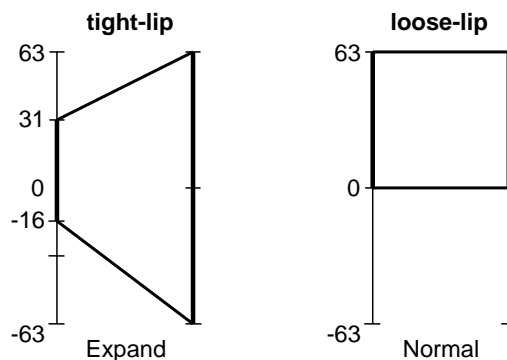

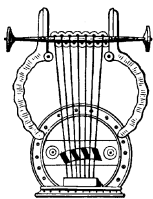

2: MIDI Setting

```

UTIL/SYSTEM/MIDI SETTING
Transmit Channel = 
Receive Channel = Omni
Local on/off     = on
Device Number    = All
-----
Sys Bulk Disk Recl Demo
    
```

● Transmit Channel

≤ 1 ... 16.

Selects the MIDI channel via which all VL1-m data will be transmitted.

● Receive Channel

≤ 1 ... 16, *Omni*.

Sets the MIDI receive channel to any channel between 1 and 16, or the “Omni” mode for reception on all channels. Make sure that the VL1-m MIDI receive channel is either set to the channel that your external controller is transmitting on, or the omni mode.

● Local on/off

≤ *off, on*.

“Local control” refers to the fact that, normally, a breath controller plugged into the BREATH jack controls the VL1-m internal tone generator. This situation is “local control on” since the internal tone generator is controlled locally by the locally-connected breath controller. Local control can be turned off, however, so that the breath controller does not affect the internal voices, but the appropriate MIDI information is still transmitted via the MIDI OUT connector. At the same time, the internal tone generator responds to MIDI information received via the MIDI IN connector.

● Device Number

≤ *off, 1 ... 16, All*.

Sets the MIDI device number — i.e. the MIDI channel on which all system exclusive data (included in MIDI bulk dump data) will be received and transmitted. When “All” is selected reception occurs on all channels and transmission occurs via Device Number 1.

The device number is important for transfer of voice data and other system exclusive data between the VL1-m and other MIDI devices — e.g. VL1, another VL1-m, a computer, or a MIDI data recorder. Make sure that the VL1-m device number is matched to that of other devices in your system with which such data transfers will take place.



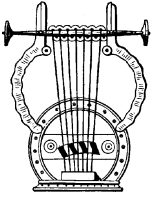

3: PGM Change Table

UTIL/SYSTEM/PROGRAM CHANGE TABLE	
001=A01(001):Moby	006=A06(006):Ossync
002=A02(002):Tenor	007=A07(007):Tull F
003=A03(003):Shakuh	008=A08(008):BagPIP
004=A04(004):Finger	009=A09(009):Guitar
005=A05(005):Trumpe	010=A10(010):Mizu H
S&S Bulk Disk Recl	Demo ▲ ▼ Init

Normally, MIDI program change numbers 001 through 128 select the correspondingly-numbered VL1-m voices. The program change table can be used to alter these assignments as required.

To change a program change assignment, move the cursor to the voice number to be changed — use the **F6** (“▲”) and **F7** (“▼”) buttons to scroll up and down through the table — then use the data dial or **DEC** and **INC** buttons to change it as required.

The initial program change assignments can be restored by pressing the **F8** (“Init”) button, and then the **INC** button in response to the “Are You Sure?” prompt. When the table has been initialized “Completed!” will appear on the display. Press **EXIT** to return to the utility mode display.

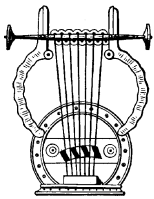

4: BC Curve

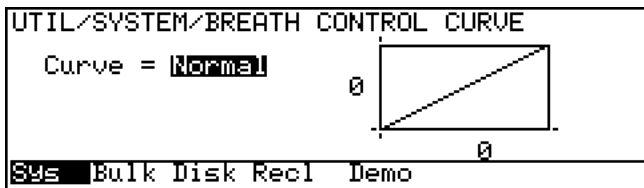

● Curve

≤ *Normal, Soft, Wide, Hard.*

Determines the relationship between breath controller input and output. Try out the various settings while using the breath controller in order to find the curve that works best for you.

Normal	The relationship between input and output is linear.
Soft	This curve makes it easy to cover a wide dynamic range with light pressure.
Wide	Subjectively, this curve produces the widest dynamic range.
Hard	Best for players who use relatively heavy pressure.

- If you play the breath controller while viewing the appropriate curve display, the instantaneous breath pressure input and output values will appear on the display both numerically and graphically in the form of markers surrounding the curve graph.



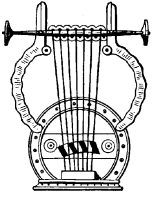

5: Miscellaneous

```

UTIL/SYSTEM/MISCELLANEOUS
Display           = Reverse
Confirm          = on
Memory Protect   = off
Greeting Message = Enter Virtuality
Sys Bulk Disk Recl Demo
  
```

● Display

≤ *Reverse, Normal.*

Determines whether the VL1-m display appears in the normal way (black characters on a white background) or reverse (white characters on a black background).

● Confirm

≤ *off, on.*

Determines whether the “Are You Sure” confirmation message will appear during the following operations:

- **Voice store.**
- **Disk save, load, rename, delete, format.**
- **Bulk data transmit.**
- **Edit recall.**
- **Demo data load.**
- **Program change table initialize.**

- Turning the confirmation function off can make operation faster and more efficient by reducing the number of steps required for some operations, but it also increases the danger of accidentally erasing important data. Use with caution.

● Memory Protect

≤ *off, on.*

Turns internal RAM memory protection on or off. When “on” no operations that alter the contents of the internal memory can be performed. Be sure to turn memory protection “off” before loading data, storing voices, receiving bulk data from external equipment, etc.

● Greeting Message

≤ Up to 20 characters.

Allows you to enter an original greeting message which will be displayed by the VL1-m when the power is initially turned on. Position the cursor at the “Greeting Message” parameter and press the **F8** button (“Name”). Then use the name entry procedure described on page 31.





MIDI Bulk Dump

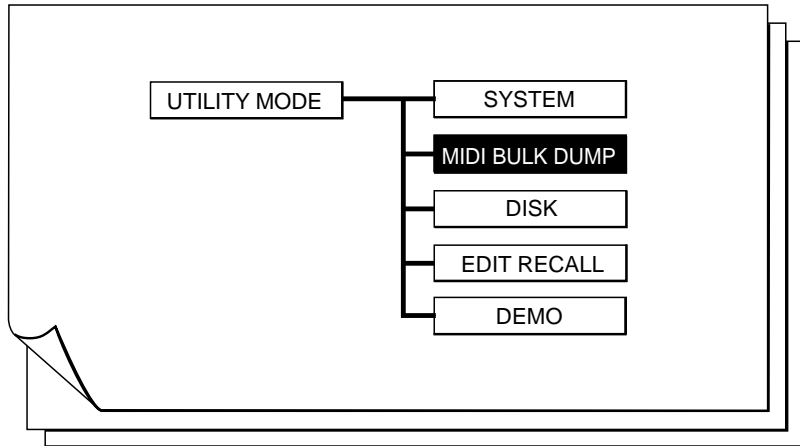

```
UTIL  
<MIDI Bulk Dump>  
1: System  
2: All Voice  
3: Current Voice  
-----  
Sys Bulk Disk Recl Demo
```



MIDI “bulk dump” transmission makes it possible to transfer system and voice data between the VL1-m and other MIDI equipment. The VL1-m is capable transmitting three types of data:

1: System	All VL1-m system Data: the settings in the Utility System page, the 2 internal Micro Tuning, and Program change table data.
2: All Voice	All 128 voices in the VL1-m memory.
3: Current Voice	The currently selected voice only.

● Bulk Data Transmission Procedure

1. Preparation

Make sure the VL1-m is properly connected to a device which is capable of receiving its bulk data: another VL1-m, a computer, a MIDI data recorder, etc. The VL1-m MIDI OUT connector should be connected to the MIDI IN connector of the receiving device via a high-quality MIDI cable. Also make sure that the VL1-m and receiving device are set to the same MIDI Device Number.

2. Select a Data Type

Position the cursor at the type of bulk data you want to send — “System”, “All Voice”, or “Current Voice”.

3. Press **ENTER**

Press the **ENTER** button. The “Are You Sure?” confirmation display will appear.

4. Press **INC** to Transmit

Press the **INC** button to transmit the selected data (or **DEC** to cancel the operation). The progress of the transmission will be indicated in bar-graph form on the display, and “Completed” will appear when all the data has been transmitted.

- “System” and “All Voice” transmissions can be cancelled between blocks by pressing the **EXIT** button.

5. Press **EXIT**

Press the **EXIT** button to clear the “Completed” display and return to the main bulk transmit display.

● Bulk Data Reception

In order for the VL1-m to receive a bulk transmission from another VL1-m or other device, the MIDI OUT of the transmitting device must be connected to the MIDI IN of the VL1-m via a MIDI cable. The VL1-m will then automatically receive and load the data as long as it is set to the same device number as the transmitting device and its Memory Protect function is turned “off”. Memory Protect does not need to be turned off in order to receive a single voice (the current voice).



Disk

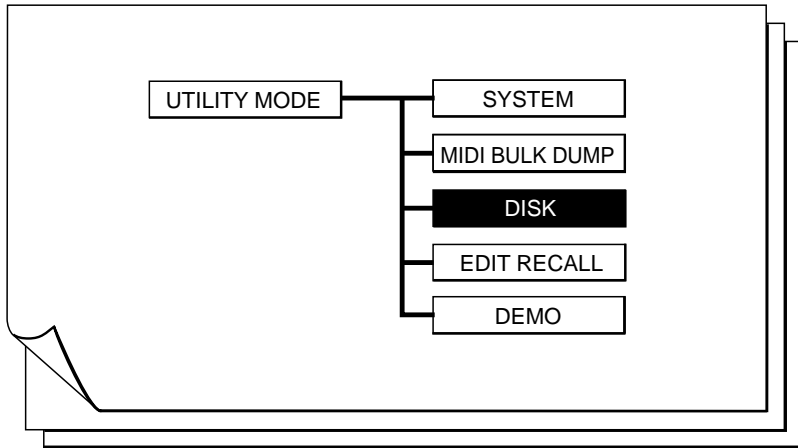

■ 1: Disk Status	163
■ 2: Load From Disk	164
■ 3: Save To Disk	166
■ 4: Rename File	168
■ 5: Delete File	170
■ 6: Format Disk	171

```

UTIL
<Disk>
1:Disk Status      5:Delete File
2:Load From Disk  6:Format Disk
3:Save To Disk
4:Rename File
Sys Bulk Disk Recl Demo
  
```



CAUTION! ■ Never attempt to remove a disk from the disk drive while the disk drive indicator is lit. Doing so can damage the data on the disk.

■ The disk write protect tab must be set to the "off" or "write enable" position in order to save data to the disk, rename a file, delete a file, or format the disk.



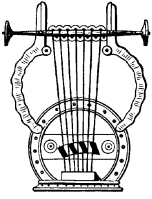

1: Disk Status

```

UTIL/DISK/DISK STATUS
Total = 5file      System = 0file
Used = 1281KB     All Voice = 0file
Free = 142KB      1 Bank = 0file
All = 5file       1 Voice = 0file
Others = 0file
Sys Bulk Disk Recl Demo
    
```

This function displays a range of information about the currently loaded floppy disk.

Total	The total number of files on the disk.
Used	The amount of disk space currently used, in kilobytes.
Free	The amount of disk space currently free, in kilobytes.
System	The number of "System" files on the disk.
All Voice	The number of "All Voice" files on the disk.
1 Bank	The number of "1 Bank" files on the disk.
1 Voice	The number of "1 Voice" files on the disk.
All	The number of "All" files on the disk.
Others	The number of files on the disk that do not match any of the above categories.

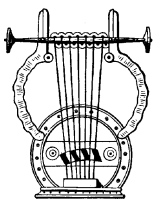

2: Load From Disk

```

UTIL/DISK/LOAD FROM DISK
<Load From Disk>

[5:1] 5:1 Voice
2: System
3: All Voice
4: 1 Bank
Sys Bulk Disk Recl Demo
    
```

This function loads a specified data file from a floppy disk inserted in the VL1-m floppy disk drive. Five types of data files can be selected.

All	All system and voice data.
System	All Utility System page settings and internal Microtuning data.
All Voice	All 128 voices in the VL1-m memory.
1 Bank	16 voices from 1 VL1-m memory bank (A ... H).
1 Voice	1 voice.

● Disk Load Procedure

1. Insert the Floppy Disk

Make sure the floppy disk containing the data you want to load is properly inserted in the VL1-m floppy disk drive.

- Also make sure that the VL1-m Memory Protect function is turned “off” (≥ Page 157).

2. Select a File Type and press **ENTER**

Position the cursor at the type of file you want to load, then press the **ENTER** button.

3. Select a File and Press **ENTER**

When the file window appears, select the file you want to load and press **ENTER** again.

Depending on the type of data you have selected, an additional selection window may appear after you have selected the file you want to load. You may have to select an individual bank or voice, or specify a destination for the data to be loaded (“SRC” in the selection window title indicates that you are selecting a source file, while “DST” indicates that you are selecting a destination). Continue making the required selections and pressing **ENTER** until the confirmation prompt appears.

- When selecting a voice to load from a long list, you can use the **F6** (“123”) and **F7** (“ABC”) buttons to display the voices in numeric or alphabetic order, as required. Sometimes it may take a few seconds to sort the data as specified — the “Now Sorting!” message will appear during the sort operation.

4. Press **INC** to Load

When the “Are You Sure?” confirmation prompt appears, press the **INC** button to load the selected data (or **DEC** to cancel the operation). The progress of the load operation will be indicated in bar-graph form on the display, and “Completed” will appear when all the data has been loaded.

- A load operation in progress cannot be cancelled.

5. Press **EXIT**

Press the **EXIT** button to clear the “Completed” display.



CAUTION! ■ Whenever a load operation is performed any previous data in the memory location to which the new data is loaded to will be erased and replaced by the new data! Be sure to save important data to disk to minimize the possibility of accidental erasure.



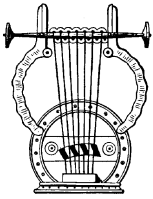

3: Save To Disk

```

UTIL/DISK/SAVE TO DISK
<Save To Disk>
1:All
2: System
3: All Voice
4: 1 Bank
Sys Bulk Disk Recl Demo
    
```

This function saves a specified data file from the VL1-m memory to a floppy disk inserted in the VL1-m floppy disk drive. Five types of data files can be selected.

All	All system and voice data.
System	All Utility System page settings and internal Microtuning data.
All Voice	All 128 voices in the VL1-m memory.
1 Bank	16 voices from 1 VL1-m memory bank (A ... H).
1 Voice	1 voice.

● Disk Save Procedure

1. Insert the Floppy Disk

Make sure the floppy disk to which you want to save the data is properly inserted in the VL1-m floppy disk drive.

- Also make sure that the floppy disk's write protect tab is set to the "off" or "write enable" position.
- Only floppy disks which have been formatted using the "Format Disk" function (≥ Page 171) can be used to save VL1-m data.

2. Select a File Type and press **ENTER**

Position the cursor at the type of file you want to save, then press the **ENTER** button.

If you select "All", "System" or "All Voice" a list of the files on disk will appear. In this case skip step 3, below, and go directly to step 4. If you select "1 Bank" or "1 Voice" continue with step 3.

3. Select a Bank or Voice and Press **ENTER**

When the source window appears, select the bank or voice you want to save and press **ENTER**.

4. Select the Destination File

If you want to save the selected data to a new file, position the cursor at a file name with the "NewFile" extension. To save the data to an existing file, position the cursor at the appropriate file name. In the latter case there is no need to enter a new file name, so you can skip ahead to step 7.



5. Enter a File Name

Press ∞ (“Name”) and enter a name (maximum 8 characters) for the file to be saved (\geq Page 31).

- File names which begin with or contain a space are not allowed.

6. Press **EXIT** or **ENTER**

Press the **EXIT** or **ENTER** button to close the name window.

7. Press **ENTER** and Confirm

Press the **ENTER** button. When the “Are You Sure?” confirmation prompt appears, press the **INC** button to save the selected data (or **DEC** to cancel the operation). The progress of the save operation will be indicated in bar-graph form on the display, and “Completed” will appear when all the data has been saved.

- A save operation in progress cannot be cancelled.
- Files are automatically saved with an extension (a period followed by three characters) which indicates the file type: .ALL = All Data; .SYS = System; .AVC = All Voice; .1BK = 1 Bank; .1VC = 1 Voice.

8. Press **EXIT**

Press the **EXIT** button to clear the “Completed” display.



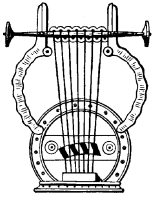

4: Rename File

```

UTIL/DISK/RENAME FILE
<Rename File>

1:All 5:1 Voice
2: System
3: All Voice
4: 1 Bank
Sys Bulk Disk Recl Demo
    
```

This function can be used to rename a specified data file on a floppy disk inserted in the VL1-m floppy disk drive. Five types of data files can be selected.

All	All system and voice data.
System	All Utility System page settings and internal Microtuning data.
All Voice	All 128 voices in the VL1-m memory.
1 Bank	16 voices from 1 VL1-m memory bank (A ... H).
1 Voice	1 voice.

● File Rename Procedure

1. Insert the Floppy Disk

Make sure the floppy disk containing the file you want to rename is properly inserted in the VL1-m floppy disk drive.

- Also make sure that the floppy disk's write protect tab is set to the "off" or "write enable" position.

2. Select a File Type and press **ENTER**

Position the cursor at the type of file you want to rename, then press the **ENTER** button.

3. Select a File and Press **∞**

When the file window appears, select the file you want to rename and press the **∞** button ("Rnam").

4. Enter a File Name

Enter a new name (maximum 8 characters) for the selected file (≥ Page 31).

- File names which begin with or contain a space are not allowed.

5. Press **EXIT** or **ENTER**

Press the **EXIT** or **ENTER** button to close the name window.



6. Press `ENTER` and Confirm

Press the `ENTER` button. When the “Are You Sure?” confirmation prompt appears, press the `INC` button to rename the file (or `DEC` to cancel the operation). “Now Executing” will appear while the file name is being rewritten, and “Completed” will appear when the rename operation is finished.

7. Press `EXIT`

Press the `EXIT` button to clear the “Completed” display.



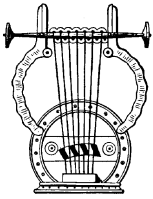

5: Delete File

```

UTIL/DISK/DELETE FILE
<Delete File>
5:1 Voice
2: System      6: Others
3: All Voice
4: 1 Bank
Sys Bulk Disk Recl Demo
    
```

This function can be used to delete a specified data file on a floppy disk inserted in the VL1-m floppy disk drive. Six types of data files can be selected.

All	All system and voice data.
System	All Utility System page settings and internal Microtuning data.
All Voice	All 128 voices in the VL1-m memory.
1 Bank	16 voices from 1 VL1-m memory bank (A ... H).
1 Voice	1 voice.
Others	Any files not included in the above categories.

● File Delete Procedure

1. Insert the Floppy Disk

Make sure the floppy disk containing the file you want to delete is properly inserted in the VL1-m floppy disk drive.

- Also make sure that the floppy disk's write protect tab is set to the "off" or "write enable" position.

2. Select a File Type and press **ENTER**

Position the cursor at the type of file you want to delete, then press the **ENTER** button.

3. Select a File and Press **ENTER**

When the file window appears, select the file you want to delete and press **ENTER**.

4. Press **INC** To Delete

When the "Are You Sure?" confirmation prompt appears, press the **INC** button to delete the file (or **DEC** to cancel the operation). "Now Executing" will appear while the file is being deleted, and "Completed" will appear when the delete operation is finished.

5. Press **EXIT**

Press the **EXIT** button to clear the "Completed" display.



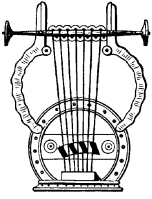

6: Format Disk

```

UTIL/DISK/FORMAT DISK
<Format Disk>

      Please insert a blank disk.
      Push ENTER, if OK.

Sys  Bulk Disk Recl Demo
  
```

This function formats new 2DD or 2HD type floppy disks for use with the VL1-m.

- 2DD type disks provide 720 kilobytes of storage capacity when formatted (MS-DOS 9-sector format), and 2HD disks have 1.44 megabytes of storage capacity when formatted (MS-DOS 18-sector format).

● Disk Format Procedure

1. Insert the Floppy Disk

Make sure the floppy disk you want to format is properly inserted in the VL1-m floppy disk drive.

- Also make sure that the floppy disk's write protect tab is set to the "off" or "write enable" position.

2. Press **ENTER** and Confirm

Press the **ENTER** button. When the "Are You Sure?" confirmation prompt appears, press the **INC** button to begin formatting the disk (or **DEC** to cancel the operation). The progress of the format operation will be indicated on the display in bar graph form, and "Completed" will appear when the format operation is finished.

3. Press **EXIT**

Press the **EXIT** button to clear the "Completed" display.



CAUTION! ■ Formatting a disk that contains data will erase all data on the disk!

Edit Recall

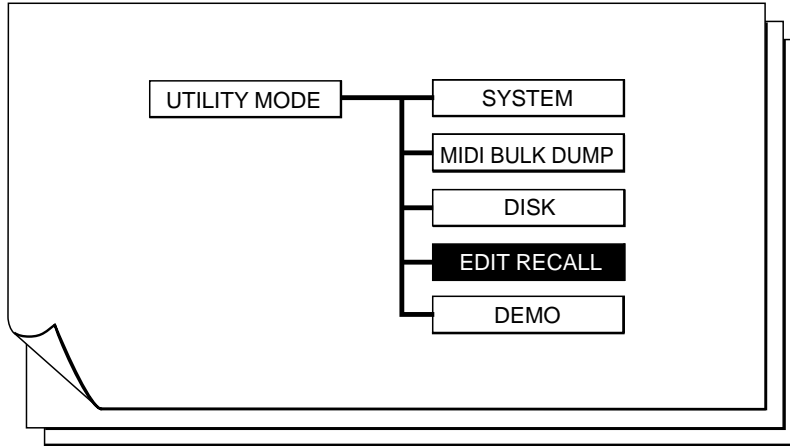

```
UTIL
<Edit Recall>
  Recall Memory Voice = Tull Flute
  Push ENTER, if OK.
SYS Bulk Disk Rec. Demo
```



If you've accidentally "lost" an edited voice by selecting a different voice in the PLAY mode before storing your edited data, the Edit Recall function can be used to recall the edited data.

- If you've made no further edits to any other voice since losing the data, only the name of the last voice edited (the "Recall Memory Voice") will appear on the display. If you've already made at least one edit to the newly selected voice both the name of the recall memory voice and the current voice will appear on the display — with the warning that the current voice will be overwritten by the recall memory voice if you proceed with the recall operation!

● Edit Recall Procedure

1. Press **ENTER** and Confirm

Press the **ENTER** button. When the "Are You Sure?" confirmation prompt appears, press the **INC** button to recall the edit data (or **DEC** to cancel the operation). "Completed" will appear when the recall operation is finished.

2. Press **PLAY**

Press the **PLAY** button to return to the PLAY mode. "E"() will appear to the left of the voice name.



Demo

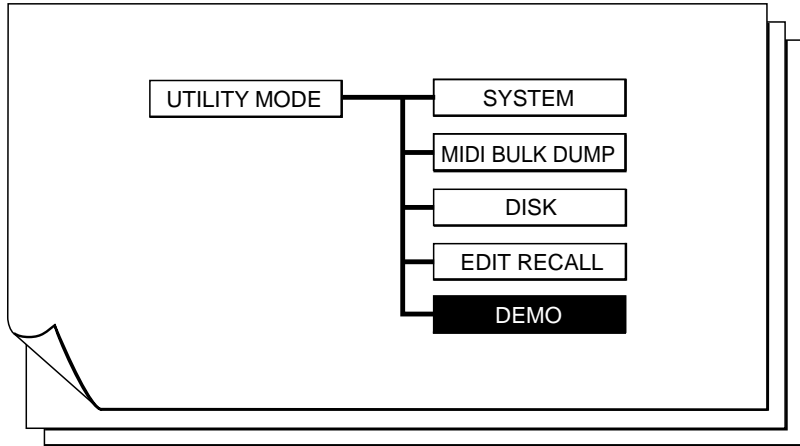

```
UTIL
<Demo>
Current Voice data will be erased!
Push ENTER,if OK.
-----
Sys Bulk Disk Recl Demo
```



The VL1-m includes a built-in demonstration which can be played as follows.

● Demo Playback Procedure

1. Press **ENTER**

Press the **ENTER** button. The demo selection, start, and stop control display should appear.

2. Select a Demo

Select the demo you want to play (“Top Song” parameter).

3. Press **F8** To Run

Press the **F8** button to run the demo. The various demo songs will play in sequence until stopped.

4. Press **F7** To Stop

Press the **F7** button to stop demo playback.

NOTES ■ *If you run the demo while editing a voice, the edited data will be lost. Be sure to store the edited voice before running the demo.*





Appendix



VL1 & VL1-m Compatibility	178
Troubleshooting	179
Error Messages	182
Specifications	184
Index	186

VL1 & VL1-m Compatibility



Although the VL1 Virtual Acoustic Synthesizer and VL1-m Virtual Acoustic Tone generator are basically data-compatible, there are a few small differences which should be noted by the user who will be dealing with both instruments.

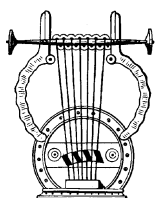

Differences Between the VL1 and VL1-m

● VL1-m Features Not Available On the VL1

- Program Change Table (page 155).
- Sound Function (Getting Started manual, page 36).
- WX Lip Parameter (page 153).
- Monitor Display (page 20).

● Functional Differences

The VL1 Continuous Sliders are not provided on the VL1-m, but control change numbers 16 and 17 can be used for the same purpose via the Quick Edit function (page 43). While bank selection is carried out on the VL1 via the BANK SELECT buttons, bank selection on the VL1-m is carried out via the **DEC** and **INC** buttons (Getting Started manual, page 35).

● VL1 Features Not Available On the VL1-m

- Keyboard Transpose.
- Octave Buttons.
- Assignable Controllers.
- Velocity/Aftertouch Curve.

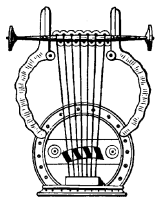

VL1-m/VL1 Data Compatibility

● System Exclusive Message Compatibility

- VL1 and VL1-m system exclusive data are compatible except for differences in the physical configurations of the two instruments (i.e. keyboard vs. tone generator module).
- The VL1-m Quick Edit function will accept control change numbers 16 and 17 as well as parameter change data from the VL1 CS1 and CS2 continuous sliders.

● Supplied Disk Compatibility

- Except for the VL1-m “NOBREATH.ALL”, “EXAMPLE.ALL” and “WXSELECT.ALL” files and some system data, the VL1 “CUSTOMER.ALL” and “FACTORY.ALL” files are the same as the “FULLCTRL.ALL” and “STANDARD.ALL” files provided with the VL1-m.



Troubleshooting



The VL1-m is a very versatile instrument with many features and functions that affect operation. In many cases, what appears to be a fault with the VL1-m can actually be traced to an improperly set parameter or, at the most fundamental level, to something as simple as a bad connection.

Here's how to determine if the problem is internal (e.g. parameter settings) or external (e.g. connections, amplifier, etc.):

- Listen via Headphones. Plug a pair of headphones into the VL1-m and play. If the headphone sound is OK, then the problem is most likely in the amplifier or mixer you are using, or the audio connection cables.
- Try moving all controllers — modulation wheels, foot controllers, etc. In some cases extreme controller settings can cause unexpected sound or pitch ... or even no sound at all.
- Try selecting different voices. If the problem occurs only on one voice then the voice parameters are most likely at fault. If the problem occurs on all voices then a utility parameter should be suspected.

The following are some common problems and probable causes:



● Amplifier, Mixer, Connection Problems

Symptom	Possible Cause
No sound.	<ul style="list-style-type: none"> • Is the amplifier/mixer power turned on? • Is the amplifier/mixer volume set to an appropriate level? • Are the VL1-m outputs properly connected to the amplifier/mixer inputs? • Are the connection cables shorted, open, or otherwise faulty?
Distorted sound.	<ul style="list-style-type: none"> • Is the VL1-m connected to a high-sensitivity microphone or instrument input on your amplifier or mixer? Try turning the VL1-m DOWN controls down to avoid overloading the amplifier/mixer inputs.
Improper stereo positioning.	<ul style="list-style-type: none"> • Check the level and pan controls on the sound system/mixing console being used with the VL1-m.

● Utility Setting Problems

Symptom	Possible Cause
No Sound	<ul style="list-style-type: none"> • Is the local off mode selected (page 154)? • Are the MIDI transmit channel and receive channels matched to those of the external MIDI device used (page 154)?
Wrong pitch.	<ul style="list-style-type: none"> • Is the master tune parameter set properly (page 153)?.
No reverb.	<ul style="list-style-type: none"> • Is the TG Setting Reverb parameter turned “on” (page 153)?.
Improper controller operation.	<ul style="list-style-type: none"> • Are the controllers on your MIDI keyboard or other instrument assigned to the appropriate control change numbers?



● Voice Setting Problems

Symptom	Possible Cause
No sound.	<ul style="list-style-type: none"> • Is the appropriate element selected (page 25)?. • Make sure that the element level is not set to “0” (page 38)?. • Make sure that the amplitude level is not set to “0” (page 104)?. • Make sure that the driver, pipe/strings, and tap output mixing parameters are not all set to “0” (page 98)?. • Make sure that the amplitude & filter sustain level is not set to “0” (page 145). • Check the pressure controller (page 65)?. • Check the amplitude controller (page 71)?. • Check the embouchure controller (page 66)?. • Check the damping controller (page 80)?. • Check the absorption controller (page 81)?. • Some voices will not produce sound when played at extremely high or low pitches.
Sound won't stop.	<ul style="list-style-type: none"> • Make sure that the pressure EG mode parameters is not set to “Disable” (page 129)?.
Wrong pitch.	<ul style="list-style-type: none"> • Check the element detune, note shift, and random pitch parameters (page 37)?. • Microtuning may be set to a tuning other than equal temperament (page 42)?. • Check the effect pitch change parameters (page 50)?. • Check the pitch controller (page 67)?. • Some voices will change pitch when pressure or embouchure control is applied.
Distorted sound.	<ul style="list-style-type: none"> • Check the effect distortion settings (page 51)?. • Check the scream controller (page 72)?. • Check the growl controller (page 74)?. • Check the throat formant controller (page 75)?.
Improper stereo positioning.	<ul style="list-style-type: none"> • Are the element pan L and R parameters set to values other than “-64” and “63”, respectively (page 38)?. • Check the effect feedback delay settings (page 53)?.
Can't play two notes simultaneously.	<ul style="list-style-type: none"> • Make sure that the key mode and voice mode parameters are set properly (page 31,32)?. • Check the controller assigned to polyphony control.



Error Messages



When an operational error or other problem occurs, the VL1-m will display one of the following error messages to inform you of the problem.

Display	Comments
Bad disk!	The loaded floppy disk is damaged. Try a different disk.
Change battery!	The voice backup battery needs to be replaced. Have the battery replaced by qualified Yamaha service personnel.
Data not found!	The specified data cannot be found on the currently selected file. Make sure the appropriate disk is loaded.
Device number is off!	MIDI bulk data could not be transmitted or received because the device number parameter is turned off. Check the device number setting.
Device number mismatch!	MIDI bulk data could not be transmitted or received because the device number of the VL1-m is not matched to that of the second device. Check the device number settings.
Disk full!	Data cannot be saved to floppy disk because the currently loaded disk is full. Delete unwanted files to make more space on the disk, or use a different disk.
Disk not formatted!	The currently loaded floppy disk has not been formatted for use with the VL1-m. Format the disk before performing any disk operations.
Disk not ready!	You have attempted to perform a disk operation while no floppy disk is loaded. Insert an appropriate floppy disk in the disk drive.
File not found!	The specified file cannot be found on the currently loaded floppy disk. Check the file name or use the appropriate disk.



Display	Comments
Illegal disk!	The currently loaded disk has a non-VL1-m format. Either use a different disk or, if the data on the disk is not needed, re-format the disk.
Illegal file!	The specified file is not a VL1-m file. Check the disk and files.
Memory protected!	You have attempted to perform a function which will change the contents of the internal memory, but the memory protect function is "on". Turn memory protect "off" and try again.
MIDI buffer full!	The MIDI receive buffer is full. Reduce the amount of data being transmitted to the VL1-m.
MIDI checksum error!	An error has been detected in the received MIDI data. Check the transmitting device and MIDI cables, and try again.
MIDI data error!	An error has been detected in the received MIDI data. Check the transmitting device and MIDI cables, and try again.
Same file name exists!	You have attempted to save a file with the same name as a file that already exists on the disk. Change the file name and try again.
Write protected!	You have attempted a save, rename, or delete operation to a disk which is write protected. Set the disk's write protect tab to the "off" or "enable" position and try again.



Specifications



● Tone Generator

Type	SVA (Self-oscillating Virtual Acoustic Synthesis).
Modifiers	Harmonic Enhancer. Dynamic Filter (LPF, HPF, BPF, BEF, with resonance). Equalizer (5 bands with frequency, resonance, and boost/cut control). Impulse Expander. Resonator.
Effects	32-bit digital signal processor, stereo in/stereo out. Modulation effects (flanger, pitch change, distortion). Feed back delay. Reverberation.
Play Mode	Voice mode only. Smallest tone generator units: elements. Voices use 1 or 2 elements. Voices are composed on "common data" and "element data".
Polyphony	2 notes max.
Assign Modes	Mono, Poly, Unison

● Memory

Internal	128 voices.
Disk	3.5" 2DD or 2HD floppy disk.

● Controls

	Master volume. Data entry dial.	LCD contrast control.
--	------------------------------------	-----------------------



● Panel Switches

	Play (with LED). Utility (with LED). Copy. Data entry x 2. Function x 8. Exit.	Edit (with LED). Store. Cursor x 4. Enter/Sound.
--	---	---

● Display

	240 x 64 dot backlit liquid crystal display.
--	--

● Connectors

Front Panel	Stereo headphones.	Breath controller.
Rear Panel	Output x 2 (L and R). MIDI OUT.	MIDI IN. MIDI THRU.

● Output Level

Line	2.5 ±2 dBm into 10 kΩ.
Headphones	2.0 ±2 dBm into 33 Ω.

● Power Requirements

	UL/CSA: 120V, 16W Europe: 220-240V, 16W
--	--

● General

Dimensions	480 (W) x 361 (D) x 132 (H) mm.
Weight	7.5 kg

● Accessories

	Power cable. Owners manuals x 2.	Floppy disk. MIDI cable
--	-------------------------------------	----------------------------



Index



This index covers both the VL1-m *Getting Started* and *Feature Reference* manuals for easy cross-referencing. Page numbers in the *Getting Started* manual are preceded by “GS”, and page numbers in the *Feature Reference* manual are preceded by “FR”.

A

Absorption	FR 81
Amplitude & filter envelope	FR 143
Amplitude & filter key scaling	FR 146-150
Amplitude	FR 71
Assign mode	FR 35

B

Backup battery	GS 4
BC Curve	FR 156
Breath attack gain	FR 36
Breath attack time	FR 36
Breath controller calibration	GS 28
Breath controller	GS 23
Breath controller jack	GS 19
Breath noise	FR 73, 86
Breath noise key scaling	FR 88-90
Bulk dump, MIDI	FR 161

C

Common miscellaneous	FR 34
Confirm mode	FR 157
Controller envelopes	GS 46
Controller search & replace	FR 82
Controller parameters	GS 40
Controller views	GS 41, 47. FR 17
Controllers	GS 12, 38
Conventions	GS 7
Copy button	GS 17
Copy function	FR 24
Crossfade speed	FR 85
Cursor buttons	GS 18

D

Damping	FR 80
Data dial	GS 18, 35. FR 15
Decrement & increment buttons	GS 18, 35. FR 15
Demo playback	GS 26. FR 175
Device number	FR 154
Disk format	FR 171
Disk status	FR 163
Disk, delete file	FR 170
Disk, load from	FR 164
Disk, rename file	FR 168
Disk, save to	FR 166
Display mode	FR 157
Distortion	FR 51
Dynamic filter	GS 54. FR 77, 115
Dynamic filter key scaling	FR 117-118

E

Edit compare function	FR 23
Edit recall	FR 173
Effect control	FR 45
Effects	GS 58
Element detune	FR 37
Element level	FR 38
Element names	FR 31
Element note shift	FR 37
Element on/off	FR 22
Element pan	FR 38
Element random pitch	FR 37
Element select	FR 22
Embouchure & pitch envelope	FR 130
Embouchure & pitch envelope key scaling	FR 132-134
Embouchure	FR 66



Enter/Sound button **GS** 18
 Equalizer auxiliary **FR** 119
 Equalizer band **FR** 122
 Equalizer **GS** 55
 Equalizer key scaling **FR** 120-121
 Error messages **FR** 182
 Exit button **GS** 18

F

Feedback delay effects **GS** 59
 Feedback delay **FR** 53
 Feedback delay/reverb mode **FR** 45
 Flanger **FR** 47
 Floppy disk drive **GS** 19
 Floppy disks & drive, handling **GS** 5
 Function buttons **GS** 18
 Functions & parameters, finding **FR** 9

G

Greeting message **FR** 158
 Growl envelope **FR** 141
 Growl **FR** 74
 Growl speed key scaling **FR** 142

H

Harmonic enhancer **GS** 51. **FR** 78, 107
 Harmonic enhancer key scaling **FR** 110-115
 Headphones **GS** 24

I

Impulse expander & resonator setting **FR** 123
 Impulse expander **GS** 56. **FR** 125
 Initial edit page **FR** 30
 Interpolate speed **FR** 85

K

Key mode **FR** 31

L

L,C,R delay **FR** 57
 L,R delay **FR** 55
 LCD display **GS** 18
 Local on/off **FR** 154

M

Manuals, about the **GS** 6. **FR** 4
 Master tuning **FR** 153
 Memory protect **FR** 157
 Micro tuning **FR** 42
 MIDI connections **GS** 23
 MIDI connectors **GS** 20
 MIDI Indicator **GS** 17
 MIDI settings **FR** 154
 Mixing **GS** 48. **FR** 98
 Mixing key scaling **FR** 100-105
 Mode buttons **GS** 17
 Modes, the 3 main **FR** 8
 Modifiers **GS** 51
 Modulation effect type **FR** 46
 Modulation effects **GS** 59
 Monitor **FR** 20
 Mono delay **FR** 53

N

Navigation aids **FR** 11

O

Output jacks **GS** 20

P

Program Change Table **FR** 155
 Phones jack **GS** 19
 Pitch bend mode **FR** 35
 Pitch change **FR** 49
 Pitch **FR** 67
 Play-mode display **GS** 34. **FR** 14
 Polyphony control **FR** 36
 Portamento **FR** 40
 Power cord socket **GS** 20
 Power supply **GS** 22
 Power switch **GS** 17
 Power-on procedure **GS** 25
 Pre-programmed voices, loading **GS** 30
 Pressure envelope **FR** 129
 Pressure **FR** 65

Q

QED1, 2 **FR** 43
 Quick editing **FR** 19

R

Receive channel	FR 154
Resonator	GS 57. FR 126
Reverb effects	GS 60
Reverberation	FR 60

S

Scream	FR 72
Selecting & editing parameters	FR 12
Sound Function	GS 36
Sound system	GS 24
Specifications	FR 184
Store button	GS 18
Store function	FR 27
Sustain	FR 35

T

Throat formant	FR 75, 91
Throat formant key scaling	FR 93-97
Time calculation, musical	FR 59
Tonguing	FR 70
Touch EG time	FR 36
Transmit channel	FR 154
Trigger mode	FR 85
Troubleshooting	FR 179

V

Vibrato envelope	FR 135
Vibrato envelope key scaling	FR 137-140
Vibrato	FR 69
VL1 & VLI-m Compatibility	FR 178
Voice directory	GS 36
Voice list, abbreviated	GS 37
Voice mode	FR 32
Voice name	FR 31
Voice selection	GS 34. FR 15
Volume control	GS 18

W

WX Lip	FR 153
--------------	---------------





For details of products, please contact your nearest Yamaha or the authorized distributor listed below.

Pour plus de détails sur les produits, veuillez-vous adresser à Yamaha ou au distributeur le plus proche de vous figurant dans la liste suivante.

Die Einzelheiten zu Produkten sind bei Ihrer unten aufgeführten Niederlassung und bei Yamaha Vertragshändlern in den jeweiligen Bestimmungsländern erhältlich.

Para detalles sobre productos, contacte su tienda Yamaha más cercana o el distribuidor autorizado que se lista debajo.

NORTH AMERICA

CANADA

Yamaha Canada Music Ltd.
135 Milner Avenue, Scarborough, Ontario,
M1S 3R1, Canada
Tel: 416-298-1311

U.S.A.

Yamaha Corporation of America
6600 Orangethorpe Ave., Buena Park, Calif. 90620,
U.S.A.
Tel: 714-522-9011

MIDDLE & SOUTH AMERICA

MEXICO

Yamaha De Mexico S.A. De C.V.,
Departamento de ventas
Javier Rojo Gomez No.1149, Col. Gpe Del
Moral, Deleg. Iztapalapa, 09300 Mexico, D.F.
Tel: 686-00-33

BRASIL

Yamaha Musical Do Brasil LTDA.
Ave. Reboucas 2636, São Paulo, Brasil
Tel: 55-11 853-1377

PANAMA

Yamaha De Panama S.A.
Edificio Interseco, Calle Elvira Mendez no.10,
Piso 3, Oficina #105, Ciudad de Panama, Panama
Tel: 507-69-5311

OTHER LATIN AMERICAN COUNTRIES AND CARIBBEAN COUNTRIES

Yamaha Music Latin America Corp.
6101 Blue Lagoon Drive, Miami, Florida 33126,
U.S.A.
Tel: 305-261-4111

EUROPE

THE UNITED KINGDOM

Yamaha-Kemble Music (U.K.) Ltd.
Sherbourne Drive, Tilbrook, Milton Keynes,
MK7 8BL, England
Tel: 0908-366700

IRELAND

Danfay Limited
61D, Sallynoggin Road, Dun Laoghaire, Co. Dublin
Tel: 01-2859177

GERMANY/SWITZERLAND

Yamaha Europa GmbH.
Siemensstraße 22-34, D-2084 Rellingen, F.R. of
Germany
Tel: 04101-3030

AUSTRIA/HUNGARY/SLOVENIA/ ROMANIA/BULGARIA

Yamaha Music Austria GesmbH.
Schleiergasse 20, A-1100 Wien Austria
Tel: 0222-60203900

THE NETHERLANDS

Yamaha Music Benelux B.V.,
Verkoop Administratie
Kanaalweg 18G, 3526KL, Utrecht, The Netherlands
Tel: 030-828411

BELGIUM/LUXEMBOURG

Yamaha Music Benelux B.V.,
Brussels-office
Keiberg Imperiastraat 8, 1930 Zaventem, Belgium
Tel: 02-7258220

FRANCE

Yamaha Musique France,
Division Instruments Electroniques et de Scène
BP 70-77312 Marne-la-Valée Cedex 2, France
Tel: 01-64-61-4000

ITALY

Yamaha Musica Italia S.P.A.,
Combo Division
Viale Italia 88, 20020 Lainate (Milano), Italy
Tel: 02-935-771

SPAIN

Yamaha-Hazen Electronica Musical, S.A.
Jorge Juan 30, 28001, Madrid, Spain
Tel: 91-577-7270

PORTUGAL

Valentim de Carvalho CI SA
Estrada de Porto Salvo, Paço de Arcos 2780 Oeiras,
Portugal
Tel: 01-443-3398/4030/1823

GREECE

Philippe Nakas S.A.
Navarinou Street 13, P.Code 10680, Athens, Greece
Tel: 01-364-7111

SWEDEN

Yamaha Scandinavia AB
J.A. Wettergrens gata 1, Box 30053, 400 43
Göteborg, Sweden
Tel: 031-496090

DENMARK

Yamaha Scandinavia Filial Denmark
Generatorvej 8B 2730 Herlev, Denmark
Tel: 44 92 49 00

FINLAND

Fazer Music Inc.
Aleksanterinkatu 11, SF 00100 Helsinki, Finland
Tel: 0435 011

NORWAY

Narud Yamaha AS
Østerdalen 29, 1345 Østerås
Tel: 02-24 47 90

ICELAND

Páll H. Pálsson
P.O. Box 85, 121 Reykjavik, Iceland
Tel: 01-19440

EAST EUROPEAN COUNTRIES (Except HUNGARY)

Yamaha Europa GmbH.
Siemensstraße 22-34, D-2084 Rellingen, F.R. of
Germany
Tel: 04101-3030

AFRICA

Yamaha Corporation,
International Marketing Division
Nakazawa-cho 10-1, Hamamatsu, Japan 430
Tel: 053-460-2311

MIDDLE EAST

TURKEY/CYPRUS

Yamaha Musique France, Division Export
BP 70-77312 Marne-la-Valée Cedex 2, France
Tel: 01-64-61-4000

OTHER COUNTRIES

Yamaha Corporation,
International Marketing Division
Nakazawa-cho 10-1, Hamamatsu, Japan 430
Tel: 053-460-2311

ASIA

HONG KONG

Tom Lee Music Co., Ltd.
11/F., Silvercord Tower 1, 30 Canton Road,
Tsimshatsui, Kowloon, Hong Kong
Tel: 730-1098

INDONESIA

PT. Yamaha Music Indonesia(Distributor)
PT. Nusantik
Gedung Yamaha Music Center, Jalan Jend. Gatot
Subroto Kav. 4, Jakarta 12930, Indonesia
Tel: 21-520-2577

KOREA

Cosmos Corporation
#131-31, Neung-Dong, Sungdong-Ku, Seoul
Korea
Tel: 02-466-0021~5

MALAYSIA

Yamaha Music Malaysia, Sdn., Bhd.
16-28, Jalan SS 2/72, Petaling Jaya, Selangor,
Malaysia
Tel: 3-717-8977

PHILIPPINES

Yupangco Music Corporation
339 Gil J. Puyat Avenue, P.O. BOX 885 MCPO,
Makati, Metro Manila, Philippines
Tel: 819-7551

SINGAPORE

Yamaha Music Asia Pte., Ltd.
Blk 17A Toa Payoh #01-190 Lorong 7
Singapore 1231
Tel: 354-0133

TAIWAN

Kung Hsue She Trading Co., Ltd.
No. 322, Section 1, FuHsing S. Road,
Taipei 106, Taiwan. R.O.C.
Tel: 02-709-1266

THAILAND

Siam Music Yamaha Co., Ltd.
865 Phornprapha Building, Rama I Road,
Patumwan, Bangkok 10330, Thailand
Tel: 2-215-3443

THE PEOPLE'S REPUBLIC OF CHINA AND OTHER ASIAN COUNTRIES

Yamaha Corporation,
International Marketing Division
Nakazawa-cho 10-1, Hamamatsu, Japan 430
Tel: 053-460-2311

OCEANIA

AUSTRALIA

Yamaha Music Australia Pty. Ltd.
17-33 Market Street, South Melbourne, Vic. 3205,
Australia
Tel: 3-699-2388

NEW ZEALAND

Music Houses of N.Z. Ltd.
146/148 Captain Springs Road, Te Papapa, Auckland,
New Zealand
Tel: 9-634-0099

COUNTRIES AND TRUST TERRITORIES IN PACIFIC OCEAN

Yamaha Corporation,
International Marketing Division
Nakazawa-cho 10-1, Hamamatsu, Japan 430
Tel: 053-460-2311

HEAD OFFICE Yamaha Corporation, Electronic Musical Instrument Division
Nakazawa-cho 10-1, Hamamatsu, Japan 430
Tel: 053-460-2445

YAMAHA

YAMAHA CORPORATION
P.O.Box 1, Hamamatsu, Japan