



MUSIC PRODUCTION SYNTHESIZER

MOX6

MOX8

Owner's Manual

SPECIAL MESSAGE SECTION

This product utilizes batteries or an external power supply (adapter). DO NOT connect this product to any power supply or adapter other than one described in the manual, on the name plate, or specifically recommended by Yamaha.

WARNING: Do not place this product in a position where anyone could walk on, trip over, or roll anything over power or connecting cords of any kind. The use of an extension cord is not recommended! If you must use an extension cord, the minimum wire size for a 25' cord (or less) is 18 AWG. NOTE: The smaller the AWG number, the larger the current handling capacity. For longer extension cords, consult a local electrician.

This product should be used only with the components supplied or; a cart, rack, or stand that is recommended by Yamaha. If a cart, etc., is used, please observe all safety markings and instructions that accompany the accessory product.

SPECIFICATIONS SUBJECT TO CHANGE:

The information contained in this manual is believed to be correct at the time of printing. However, Yamaha reserves the right to change or modify any of the specifications without notice or obligation to update existing units.

This product, either alone or in combination with an amplifier and headphones or speaker/s, may be capable of producing sound levels that could cause permanent hearing loss. DO NOT operate for long periods of time at a high volume level or at a level that is uncomfortable. If you experience any hearing loss or ringing in the ears, you should consult an audiologist.

IMPORTANT: The louder the sound, the shorter the time period before damage occurs.

Some Yamaha products may have benches and / or accessory mounting fixtures that are either supplied with the product or as optional accessories. Some of these items are designed to be dealer assembled or installed. Please make sure that benches are stable and any optional fixtures (where applicable) are well secured BEFORE using. Benches supplied by Yamaha are designed for seating only. No other uses are recommended.

NOTICE:

Service charges incurred due to a lack of knowledge relating to how a function or effect works (when the unit is operating as designed) are not covered by the manufacturer's warranty, and are therefore the owners responsibility. Please study this manual carefully and consult your dealer before requesting service.

ENVIRONMENTAL ISSUES:

Yamaha strives to produce products that are both user safe and environmentally friendly. We sincerely believe that our products and the production methods used to produce them, meet these goals. In keeping with both the letter and the spirit of the law, we want you to be aware of the following:

Battery Notice:

This product MAY contain a small non-rechargeable battery which (if applicable) is soldered in place. The average life span of this type of battery is approximately five years. When replacement becomes necessary, contact a qualified service representative to perform the replacement.

This product may also use "household" type batteries. Some of these may be rechargeable. Make sure that the battery being charged is a rechargeable type and that the charger is intended for the battery being charged.

When installing batteries, never mix old batteries with new ones, and never mix different types of batteries. Batteries MUST be installed correctly. Mismatches or incorrect installation may result in overheating and battery case rupture.

Warning:

Do not attempt to disassemble, or incinerate any battery. Keep all batteries away from children. Dispose of used batteries promptly and as regulated by the laws in your area. Note: Check with any retailer of household type batteries in your area for battery disposal information.

Disposal Notice:

Should this product become damaged beyond repair, or for some reason its useful life is considered to be at an end, please observe all local, state, and federal regulations that relate to the disposal of products that contain lead, batteries, plastics, etc. If your dealer is unable to assist you, please contact Yamaha directly.

NAME PLATE LOCATION:

The name plate is located on the bottom of the product. The model number, serial number, power requirements, etc., are located on this plate. You should record the model number, serial number, and the date of purchase in the spaces provided below and retain this manual as a permanent record of your purchase.

Model

Serial No.

Purchase Date

PLEASE KEEP THIS MANUAL

92-BP (bottom)

FCC INFORMATION (U.S.A.)

1. IMPORTANT NOTICE: DO NOT MODIFY THIS UNIT!

This product, when installed as indicated in the instructions contained in this manual, meets FCC requirements. Modifications not expressly approved by Yamaha may void your authority, granted by the FCC, to use the product.

2. IMPORTANT:

When connecting this product to accessories and/or another product use only high quality shielded cables. Cable/s supplied with this product MUST be used. Follow all installation instructions. Failure to follow instructions could void your FCC authorization to use this product in the USA.

3. NOTE:

This product has been tested and found to comply with the requirements listed in FCC Regulations, Part 15 for Class "B" digital devices. Compliance with these requirements provides a reasonable level of assurance that your use of this product in a residential environment will not result in harmful interference with other electronic devices. This equipment generates/uses radio frequencies and, if not installed and used according to the instructions found in the users manual, may cause interference harmful to the operation of other electronic devices. Compliance with FCC regulations does

not guarantee that interference will not occur in all installations. If this product is found to be the source of interference, which can be determined by turning the unit "OFF" and "ON", please try to eliminate the problem by using one of the following measures:

Relocate either this product or the device that is being affected by the interference.

Utilize power outlets that are on different branch (circuit breaker or fuse) circuits or install AC line filter/s.

In the case of radio or TV interference, relocate/reorient the antenna. If the antenna lead-in is 300 ohm ribbon lead, change the lead-in to co-axial type cable.

If these corrective measures do not produce satisfactory results, please contact the local retailer authorized to distribute this type of product. If you can not locate the appropriate retailer, please contact Yamaha Corporation of America, Electronic Service Division, 6600 Orangethorpe Ave, Buena Park, CA90620

The above statements apply ONLY to those products distributed by Yamaha Corporation of America or its subsidiaries.

* This applies only to products distributed by YAMAHA CORPORATION OF AMERICA.

(class B)

COMPLIANCE INFORMATION STATEMENT (DECLARATION OF CONFORMITY PROCEDURE)

Responsible Party : Yamaha Corporation of America
Address : 6600 Orangethorpe Ave., Buena Park, Calif.
90620
Telephone : 714-522-9011
Type of Equipment : MUSIC PRODUCTION SYNTHESIZER
Model Name : MOX6, MOX8

This device complies with Part 15 of the FCC Rules.

Operation is subject to the following two conditions:

- 1) this device may not cause harmful interference, and
- 2) this device must accept any interference received including interference that may cause undesired operation.

See user manual instructions if interference to radio reception is suspected.

* This applies only to products distributed by
YAMAHA CORPORATION OF AMERICA.

(FCC DoC)

The name plate of this product may be found on the bottom of the unit. The serial number of this product may be found on or near the name plate. You should note this serial number in the space provided below and retain this manual as a permanent record of your purchase to aid identification in the event of theft.

Model No.

Serial No.

(bottom)

OBSERVERA!

Apparaten kopplas inte ur växelströmskällan (nätet) så länge som den är ansluten till vägguttaget, även om själva apparaten har stängts av.

ADVARSSEL: Netspændingen til dette apparat er IKKE afbrudt, så længe netledningen sidder i en stikkontakt, som er tændt — også selvom der er slukket på apparatets afbryder.

VAROITUS: Laitteen toisiopiiriin kytketty käyttökytin ei irroita koko laitetta verkosta.

(standby)

Information for Users on Collection and Disposal of Old Equipment



This symbol on the products, packaging, and/or accompanying documents means that used electrical and electronic products should not be mixed with general household waste.

For proper treatment, recovery and recycling of old products, please take them to applicable collection points, in accordance with your national legislation and the Directives 2002/96/EC.

By disposing of these products correctly, you will help to save valuable resources and prevent any potential negative effects on human health and the environment which could otherwise arise from inappropriate waste handling.

For more information about collection and recycling of old products, please contact your local municipality, your waste disposal service or the point of sale where you purchased the items.

[For business users in the European Union]

If you wish to discard electrical and electronic equipment, please contact your dealer or supplier for further information.

[Information on Disposal in other Countries outside the European Union]

This symbol is only valid in the European Union. If you wish to discard these items, please contact your local authorities or dealer and ask for the correct method of disposal.

(weee_eu)

PRECAUTIONS

PLEASE READ CAREFULLY BEFORE PROCEEDING

* Please keep this manual in a safe place for future reference.



WARNING

Always follow the basic precautions listed below to avoid the possibility of serious injury or even death from electrical shock, short-circuiting, damages, fire or other hazards. These precautions include, but are not limited to, the following:

Power supply/AC power adaptor

- Do not place the power cord near heat sources such as heaters or radiators, and do not excessively bend or otherwise damage the cord, place heavy objects on it, or place it in a position where anyone could walk on, trip over, or roll anything over it.
- Only use the voltage specified as correct for the instrument. The required voltage is printed on the name plate of the instrument.
- Use the specified adaptor (page 68) only. Using the wrong adaptor can result in damage to the instrument or overheating.
- Check the electric plug periodically and remove any dirt or dust which may have accumulated on it.

Do not open

- This instrument contains no user-serviceable parts. Do not open the instrument or attempt to disassemble or modify the internal components in any way. If it should appear to be malfunctioning, discontinue use immediately and have it inspected by qualified Yamaha service personnel.

Water warning

- Do not expose the instrument to rain, use it near water or in damp or wet conditions, place on it any containers (such as vases, bottles or

glasses) containing liquids which might spill into any openings. If any liquid such as water seeps into the instrument, turn off the power immediately and unplug the power cord from the AC outlet. Then have the instrument inspected by qualified Yamaha service personnel.

- Never insert or remove an electric plug with wet hands.

Fire warning

- Do not put burning items, such as candles, on the unit. A burning item may fall over and cause a fire.

If you notice any abnormality

- When one of the following problems occur, immediately turn off the power switch and disconnect the electric plug from the outlet. (If you are using batteries, remove all batteries from the instrument.) Then have the device inspected by Yamaha service personnel.
 - The power cord or plug becomes frayed or damaged.
 - It emits unusual smells or smoke.
 - Some object has been dropped into the instrument.
 - There is a sudden loss of sound during use of the instrument.



CAUTION

Always follow the basic precautions listed below to avoid the possibility of physical injury to you or others, or damage to the instrument or other property. These precautions include, but are not limited to, the following:

Power supply/AC power adaptor

- Do not connect the instrument to an electrical outlet using a multiple-connector. Doing so can result in lower sound quality, or possibly cause overheating in the outlet.
- When removing the electric plug from the instrument or an outlet, always hold the plug itself and not the cord. Pulling by the cord can damage it.
- Remove the electric plug from the outlet when the instrument is not to be used for extended periods of time, or during electrical storms.

Location

- Do not place the instrument in an unstable position where it might accidentally fall over.
- Before moving the instrument, remove all connected cables.

- When setting up the product, make sure that the AC outlet you are using is easily accessible. If some trouble or malfunction occurs, immediately turn off the power switch and disconnect the plug from the outlet. Even when the power switch is turned off, electricity is still flowing to the product at the minimum level. When you are not using the product for a long time, make sure to unplug the power cord from the wall AC outlet.

Connections

- Before connecting the instrument to other electronic components, turn off the power for all components. Before turning the power on or off for all components, set all volume levels to minimum.
- Be sure to set the volumes of all components at their minimum levels and gradually raise the volume controls while playing the instrument to set the desired listening level.

Handling caution

- Never insert or drop paper, metallic, or other objects into the gaps on the panel or keyboard. This could cause physical injury to you or others, damage to the instrument or other property, or operational failure.
- Do not rest your weight on, or place heavy objects on the instrument, and do not use excessive force on the buttons, switches or connectors.
- Do not use the instrument/device or headphones for a long period of time at a high or uncomfortable volume level, since this can cause permanent hearing loss. If you experience any hearing loss or ringing in the ears, consult a physician.

Yamaha cannot be held responsible for damage caused by improper use or modifications to the instrument, or data that is lost or destroyed.

Always turn the power off when the instrument is not in use. Even when the power switch is in standby status, electricity is still flowing to the instrument at the minimum level. When you are not using the instrument for a long time, make sure you unplug the power cord from the wall AC outlet.

NOTICE

To avoid the possibility of malfunction/ damage to the product, damage to data, or damage to other property, follow the notices below.

■ Handling and Maintenance

- Do not use the instrument in the vicinity of a TV, radio, stereo equipment, mobile phone, or other electric devices. Otherwise, the instrument, TV, or radio may generate noise.
- Do not expose the instrument to excessive dust or vibrations, or extreme cold or heat (such as in direct sunlight, near a heater, or in a car during the day) to prevent the possibility of panel disfiguration, damage to the internal components or unstable operation.
- Do not place vinyl, plastic or rubber objects on the instrument, since this might discolor the panel or keyboard.
- When cleaning the instrument, use a soft, dry cloth. Do not use paint thinners, solvents, cleaning fluids, or chemical-impregnated wiping cloths.

■ Saving data

- The data in the instrument's Edit Buffer (memory location for edited data) will be lost when it is turned off. Save your important data to the user memory, a USB flash memory device or external device such as a computer. Keep in mind that saved data may be lost due to malfunction or incorrect operation.
- To protect against data loss due to media damage, we recommend that you save your important data onto two USB flash memory devices/external media.

Information

■ About copyrights

- Copying of the commercially available musical data including but not limited to MIDI data and/or audio data is strictly prohibited except for your personal use.
- This product incorporates and bundles computer programs and contents in which Yamaha owns copyrights or with respect to which it has license to use others' copyrights. Such copyrighted materials include, without limitation, all computer software, style files, MIDI files, WAVE data, musical scores and sound recordings. Any unauthorized use of such programs and contents outside of personal use is not permitted under relevant laws. Any violation of copyright has legal consequences. DON'T MAKE, DISTRIBUTE OR USE ILLEGAL COPIES.

■ About functions/data bundled with the instrument

- This device is capable of using various types/formats of music data by optimizing them to the proper format music data for use with the device in advance. As a result, this device may not play them back precisely as their producers or composers originally intended.

■ About this manual

- The illustrations and LCD screens as shown in this manual are for instructional purposes only, and may appear somewhat different from those on your instrument.
- Windows is a registered trademark of Microsoft® Corporation in the United States and other countries.
- Apple, Mac and Macintosh are trademarks of Apple Inc., registered in the U.S. and other countries.
- The company names and product names in this manual are the trademarks or registered trademarks of their respective companies.

About the latest Firmware Version

Yamaha may from time to time update firmware of the product and the other associated software without notice for improvement. We recommend that you check our web site for the latest releases and upgrade your firmware of the MOX6/MOX8 or the associated software.
<http://www.yamahasynt.com/>

Note that the explanations in this Owner's Manual apply to the version of firmware when this Owner's Manual was produced. For details about additional functions included in later releases, refer to the above website.

A message from the MOX6/MOX8 Development Team

Thank you for purchasing the Yamaha MOX6/MOX8 Music Production Synthesizer.

We, as the development team, have designed this instrument so that players of every genre and level can easily enjoy truly high-quality sounds and advanced functions in creating and performing music.

SOUND

■ ■ Extraordinarily high-quality sound for a variety of applications ■ ■

The MOX6/MOX8 draws on the high-quality sound of the famed MOTIF XS, used extensively by artists worldwide, and is equipped with a wide range of dynamic sounds for use in virtually any music application.

FUNCTIONS

■ ■ Instant, smooth translation from inspiration to final music composition ■ ■

The MOX6/MOX8 features a powerful Performance Creator function which lets you combine your favorite Voice with other Voices and drum parts, and perform with full rhythmic and chordal backing. You can also record your performances as a Song or Pattern, simply by pressing the [REC] button from Performance mode—and then, after recording, automatically move to the Song/Pattern mode for further editing, refining and completing the Song or Pattern. This workflow is exceptionally smooth and transparent, and lets you create music quickly and easily as the inspiration hits.

■ ■ Seamless music production with Cubase ■ ■

The MOX6/MOX8 were developed giving maximum consideration to integration with the Cubase series DAW software made by Steinberg (see page 8). We've enhanced and strengthened the remote control function in connection with Cubase, letting you easily and conveniently control optional parameters on Cubase with the AI KNOB, or by using control templates compatible with various VST instruments to easily control multiple parameters and complex operations on software synthesizers directly from your hardware synthesizer keyboard.

DESIGN

■ ■ Stylish design and professional look ■ ■

We also designed the stylish exterior to reflect the professional-level sounds and sophisticated features of the MOX6/MOX8, making it an instrument you'll love to play, and one you'll feel proud in showing off onstage. Moreover, its value as a live performance instrument is made even greater by its portability. We also took particular care in designing the size and external appearance to make it easy to use, even when combined in a computer music system.

Accessories

- AC adaptor*
- USB cable
- Owner's Manual (this book)
- Online Manual CD-ROM x 1 (Reference Manual, Synthesizer Parameter Manual, and Data List)
- DVD-ROM x 1 (containing DAW software)

* May not be included in your area. Please check with your Yamaha dealer.

Using the MOX6/MOX8 Manuals

Your MOX6/MOX8 synthesizer comes with four different reference guides—the Owner's Manual (this book), the Reference Manual, the Synthesizer Parameter Manual, and the Data List. While the Owner's Manual is packaged together with the synthesizer as a hardcopy booklet, this Reference Manual, Synthesizer Parameter Manual, and the Data List are provided as PDF documents on the bundled CD-ROM.

- **Owner's Manual (this book)**

Describes how to set up your MOX6/MOX8 and how to perform basic operations.

- **Reference Manual (this PDF document)**

Describes the internal design of your MOX6/MOX8 and the various parameters that can be adjusted and set. It also describes how to use the instrument in specific applications and provides the following reference materials.

- Category lists for the Voices and Performances
- Setting examples of the Controller Destination
- Functions of Knobs 1 – 8 in Voice mode and Mixing mode
- Song playback types
- Song Track Loop—setting example
- Punch In/Out recording in Song mode
- Pattern playback types
- Pattern Loop recording
- Creating an Arpeggio
- Storing the Mixing settings as a Mixing Template
- Remote control assignments
- File/Folder selection in File mode
- Playing back SMF (Standard MIDI file) data from USB flash memory device
- Formatting a USB flash memory device

- **Synthesizer Parameter Manual (PDF document)**

This general, cross-product document explains the Voice parameters, effect types, effect parameters, and MIDI messages that are used for all synthesizers incorporating the Yamaha AWM2 tone generators. Read the Owner's Manual and Reference Manual first and then use this parameter manual if necessary to learn more about parameters and terms that relate to Yamaha synthesizers in general.

- **Data List (PDF document)**

Provides lists such as the Voice List, Waveform List, Performance List, Effect Type List, Arpeggio Type List, as well as reference materials such as the MIDI Implementation Chart and Remote Control Function List.

How to use the PDF manuals

The Reference Manual, the Synthesizer Parameter Manual, and the Data List are provided as data documents in PDF format. These PDF files can be viewed and read on a computer. When using Adobe® Reader® to view a PDF file, you can search for specific words, print a specific page or link to open a desired section in the manual. The term search and link functions are especially convenient methods of navigating through a PDF file, and we recommend that you use them. The latest version of Adobe Reader can be downloaded from the following URL.
<http://www.adobe.com/products/reader>

MOX6/MOX8 Main Features

■ MOTIF XS Sound Engine feature

The wide range of dynamic and authentic MOTIF XS waveforms (such as the realistic sounds of acoustic piano, electric piano, synthesizer, strings, wind instruments, drums) are all included in this instrument. The sophisticated XA (Expanded Articulation) function has also been included, providing greater performance flexibility and acoustic realism. It allows you to more effectively recreate realistic sound and natural performance techniques—such as legato and trills—and provides other unique modes for random and alternate sound changes as you play. Moreover, the instrument features new Arpeggio types for Drum Voices, as well as the existing MOTIF XS Arpeggio types, plus an extensive effect system—including VCM (Virtual Circuitry Modeling) Effects, Master Effect, and Master EQ. In a wide variety of ways, the MOX6/MOX8 truly enhances your music performance and creation.

■ Easy-to-use user interface

You can select a desired Voice or Performance directly by using the sixteen number buttons. You can also call up desired Voices or Performances according to the instrument type by using the Category Search function. This instrument also provides a powerful, easy-to-use Performance Creator function, which lets you quickly and smoothly create fully realized music, whenever the inspiration strikes you. Use it to easily create new Performances by using favorite Voices you've found in the Voice mode.

■ Comprehensive sequencer for creating Songs and Patterns

This instrument features a built-in sequencer which enables you to produce high-quality music, without the need of a computer or any other devices. The sequencer features both Realtime recording, which records your performance data as you play it, and Step recording, which is suitable for recording precise, mechanical phrases or other difficult-to-execute passages. Moreover, you can record the Performance as a Song/Pattern simply by pressing the [REC] button, and easily edit and refine your song to completion.

■ Responsive, expressive keyboard

The MOX8 features an 88-key GHS keyboard. This feature provides authentic, realistic keyboard response—much like the playing feel of an acoustic piano—with the lower keys being heavy in touch, the higher keys light, and all the natural gradations in between. The MOX6 features a newly developed, 61-key, semi-weighted keyboard. The keyboard has been designed and adjusted so that you easily and expressively play the rich variety of sounds of the instrument.

■ Stereo A/D INPUT [L]/[R] jacks

You can also connect various devices, such as microphone, guitar, or audio equipment, to the Input jacks of the instrument, and have that audio input signal sound as a separate A/D input Part in the Voice/Performance/Song/Pattern mode. Various parameters such as volume, pan, and effect can be set for this Part, and the sound is output together with all the other Parts, letting you play and output the sound MOX6/MOX8 together with the external sound. Also, you can create a vocoder sound by using the input signal from these jacks and the internal effect.

■ USB Audio/MIDI interface

The USB terminal of the instrument serves as both a MIDI and audio interface—letting you record digitally the instrument sound and the audio signal from the A/D INPUT [L]/[R] jacks to DAW software on a computer. You can also output both the instrument sound and the DAW software input signal from the MOX6/MOX8.

■ Integration with Cubase

This instrument is specially designed to work seamlessly with a version 5 or later of Cubase series^{*1}, Steinberg's full-featured DAW software—giving you a comprehensive, all-in-one music production system, in which hardware and software are fully integrated. Using the MOX6/MOX8 Editor, the MOX6/MOX8 Remote Editor, or the MOX6/MOX8 Extension enables you to use this instrument as a software synthesizer on Cubase or as a remote controller, for greater ease in using Cubase. Download the software from the following Yamaha website.
<http://www.yamahasynth.com/download/>

^{*1} The following Cubase software and versions are compatible with the MOX6/MOX8. In this manual, the following Cubase series are called "Cubase."
Cubase 5.5 or later; Cubase Studio 5.5 or later; Cubase Essential 5.1.1 or later; Cubase AI5.1.1 or later

■ Master Keyboard function

This convenient function lets you use this instrument as a master keyboard controller (with independent Zones), and for easily reconfiguring the instrument between Voice/Performance play and Song/Pattern play in live applications.

Contents

A message from the MOX6/MOX8 Development Team.....	6	Playing the keyboard in the Performance Mode.....	32
Accessories	7	Selecting a Performance	32
Using the MOX6/MOX8 Manuals	7	Changing the timbre of the Voice	34
MOX6/MOX8 Main Features	8	Recording in the Performance mode	34
Control and Functions	10	Song and Pattern	34
Top Panel	10	Recording the melody and Arpeggio playback to the Song	34
Rear Panel.....	16	Recording Arpeggio playback to a Pattern	35
Setting Up	17	Connecting a microphone or audio equipment	36
Power supply	17	Playing the keyboard along with the sound input from	
Connecting speakers or headphones.....	17	the A/D INPUT [L]/[R] jacks	36
Powering up the system	17	Playing the keyboard along with Vocoder	37
Adjusting the volume and the brightness of the display	18	Creating an original Song	38
Starting up	18	Song playback	38
Selecting programs.....	18	Creating a Drum part via Step Recording.....	39
Playing the Demo Songs	18	Creating a bass part via Realtime Recording	40
Resetting User Memory to the initial factory settings	19	Creating a synthesizer part by using Arpeggio	41
Basic Operation	20	Correcting wrong notes.....	42
Moving the cursor	20	Completing the Song by editing the Mixing.....	43
Changing (editing) parameter values	20	Storing the created Song	43
Functions and Sub-Functions.....	20	Creating an original Pattern	44
Inputting a number directly	20	Listening to the Demo Patterns.....	44
Naming (inputting characters)	21	Creating a Pattern (Section A) by using Arpeggio.....	45
Selecting a note type.....	21	Creating another Pattern (Section B) by	
Note (Key) and Velocity settings	21	using already recorded data.....	46
Quick Guide	22	Creating a Pattern Chain for converting to a Song	47
Modes.....	22	Connecting external MIDI instruments.....	49
Basic Instructions	23	Using a Connected Computer	50
Playing the keyboard in the Voice mode	24	Connecting to a computer	50
Selecting a Preset Voice	24	Creating a Song with a computer	52
Using the Category Search function	25	Remote-controlling the software from the MOX6/MOX8	
Grouping your most-used Voices together—		(Remote mode)	53
Favorite Category	25	Using the MOX6/MOX8 Editor.....	54
Using the Arpeggio function	26	Using as a Master Keyboard	55
Turning the Arpeggio On/Off.....	26	Registering the Edited Voice/Performance/Song/Pattern	55
Changing the Arpeggio type	26	Making settings for use as a master keyboard	55
Keyboard Octave/Transpose setting	26	Making Global System Settings (Utility Mode).....	56
Changing the tonal qualities of the Voice	27	Setting the default mode when turning the power on	56
Editing a Voice	27	Reversing the LCD status	56
Enhancing the sound with Effects.....	28	Click (metronome) settings	56
Changing the Arpeggio Type assignment	29	Effect settings applied to the signal input from	
Creating a new Performance by using your favorite Voice		the A/D INPUT jack	56
(Performance Creator).....	30	Master Effect/Master EQ settings in the Voice mode.....	56
Layer—Playing different Voices together.....	30	Saving/Loading Data (File Mode)	57
Split—Playing two different Voices with your left and		Saving the settings to a USB flash memory device	57
right hands	30	Loading the settings from a USB flash memory device.....	57
Drum Assign—Layering a drum Part with the current Voice.....	31	Precautions when using the USB [TO DEVICE] terminal	58
Changing the drum pattern (Arpeggio Type).....	32	Appendix	59
		Shift Function List	59
		Display Messages.....	60
		Troubleshooting	62
		About the accessory disk.....	67
		Specifications.....	68
		Index	69

Control and Functions

Top Panel

MOX8

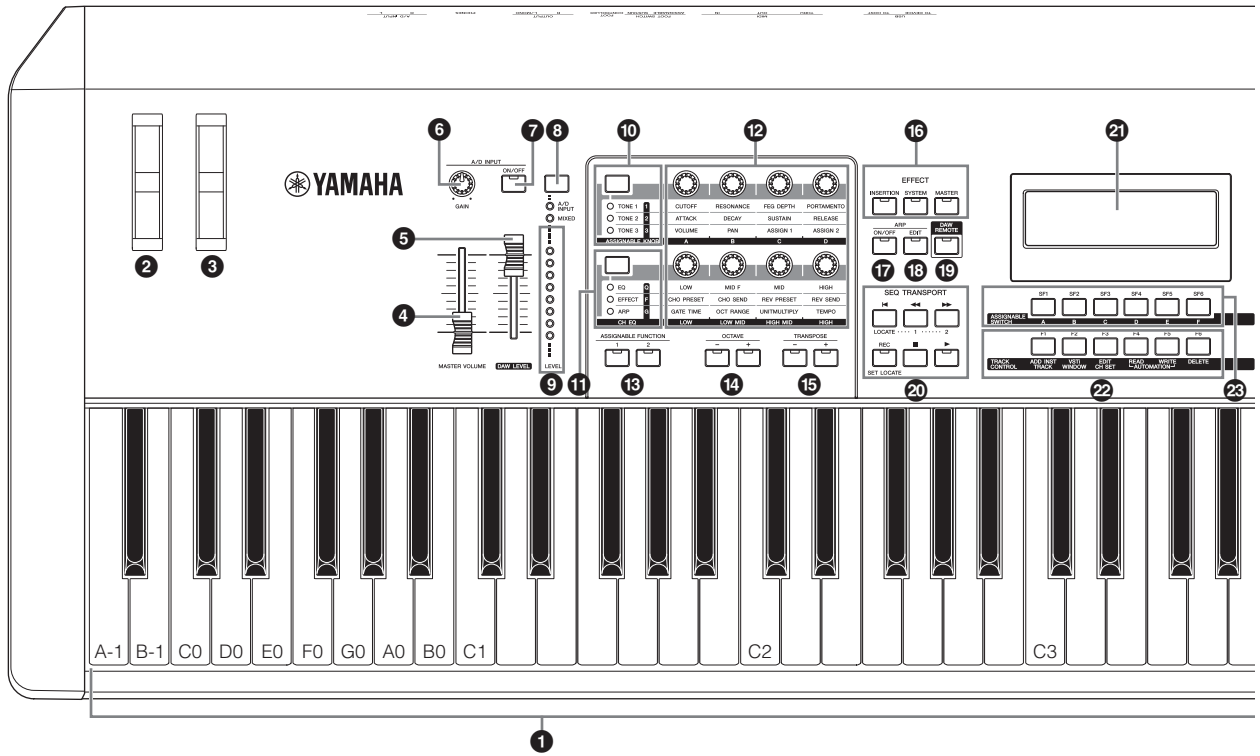

MOX6

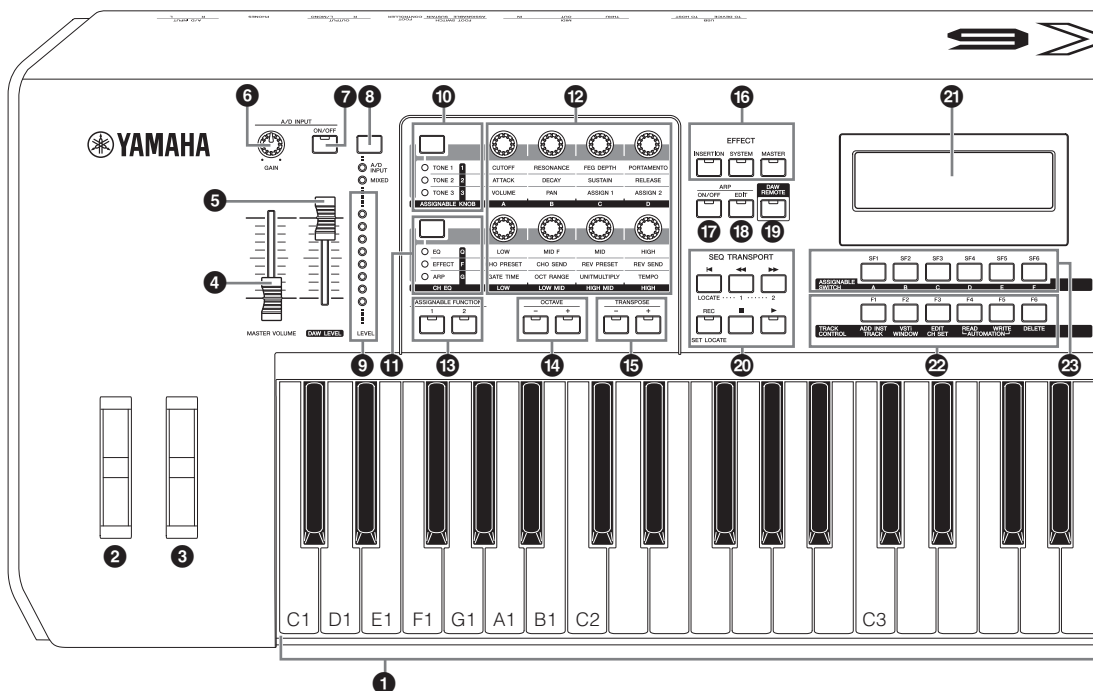

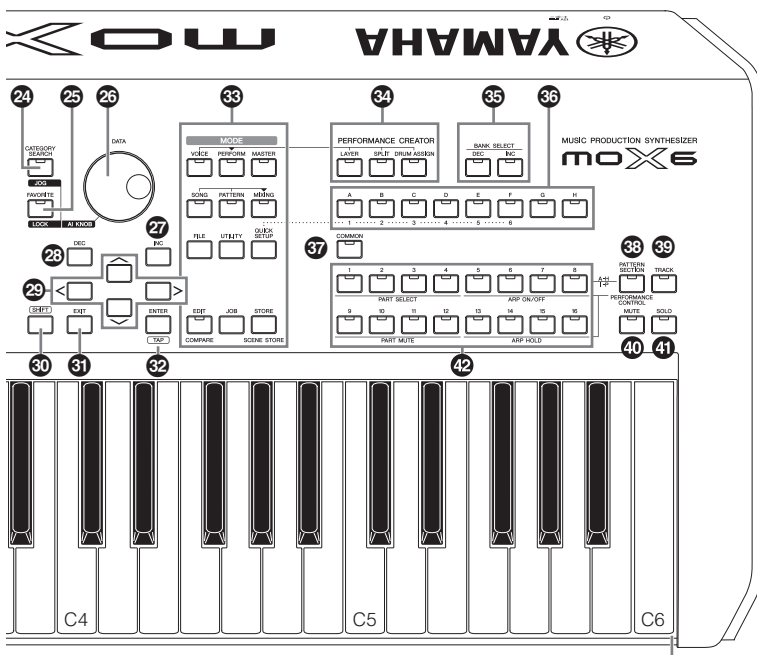
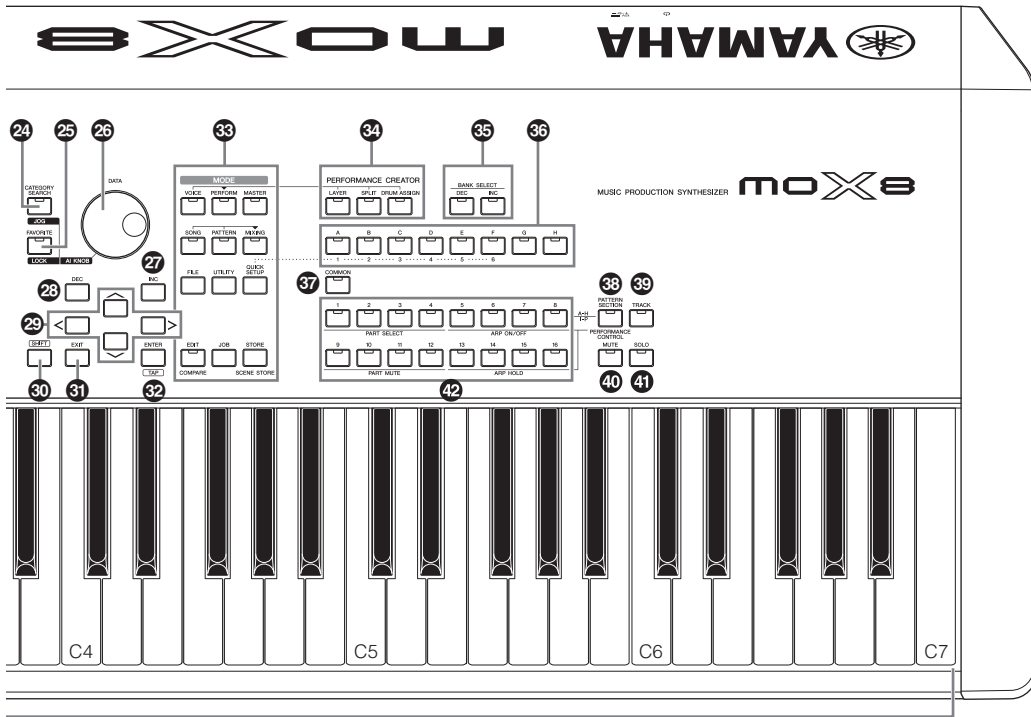

1 Keyboard

The MOX8 features an 88-key keyboard, while the MOX6 has 61 keys. All are equipped with a touch response feature, initial touch. With initial touch, the instrument senses how strongly or softly you play the keys, and uses that playing strength to affect the sound in various ways, depending on the selected Voice.

2 Pitch Bend wheel

Controls the pitch bend effect. You can also assign other functions to this controller.

3 Modulation wheel

Controls the modulation effect. You can also assign other functions to this controller.

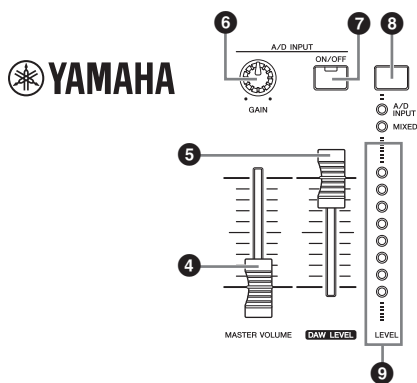

4 [MASTER VOLUME] slider (page 18)

Adjusts the volume of the overall sound. Move the slider upwards to raise the output level from the OUTPUT [L/MONO]/[R] jacks and the [PHONES] jack.

5 [DAW LEVEL] slider

Adjusts the volume of the audio signal input from the USB [TO HOST] terminal.

6 A/D INPUT [GAIN] knob

Use this to adjust the input gain of the audio signals at the A/D INPUT [L]/[R] jacks. Depending on the connected microphone, you may need to adjust this for optimum level. The volume level is increased as the knob is rotated to the right and decreased as it is rotated to the left.

NOTE Depending on the output level of the equipment connected to the A/D INPUT [L]/[R] jacks, you should change the value of the Mic/Line parameter in the [F1] GENERAL display of the Utility mode. When the output level of the connected equipment (such as a microphone, guitar, bass) is low, set this parameter to "mic." When the output level of the connected equipment (such as a synthesizer keyboard, CD player) is high, set this parameter to "line."

7 A/D INPUT [ON/OFF] button

Switches whether or not this instrument accepts the audio signal input via the A/D INPUT [L]/[R] jack.

8 [LEVEL] meter button

Selects the destination signal controlled via the [LEVEL] meter, input signal via the A/D INPUT [L]/[R] jacks or output signal via the OUTPUT [L/MONO]/[R] jack.

9 [LEVEL] meter

Indicates the level of the signal specified via the [LEVEL] meter switch button.

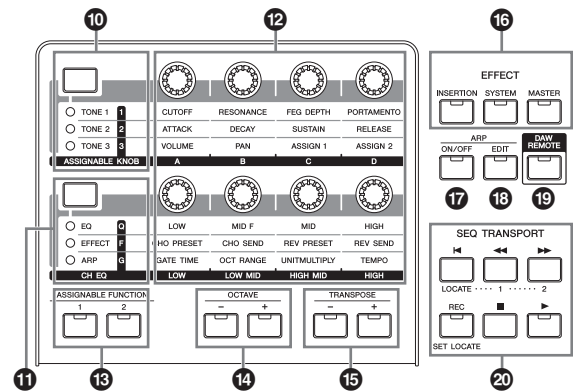

10 Knob Function 1 button

Pressing this button changes the functions assigned to Knobs 1 – 4 (on the upper row). The lamp next to the currently active parameters will light. In the Voice mode, the function of each knob is applied to the current Voice; in the Performance/Mixing mode, the function of each knob is applied only to the currently selected Part or to all Parts (depending on the setting via the [COMMON] and [PART SELECT] buttons).

NOTE When you press the Knob Function 1 button while holding the [SHIFT] button, the lamp next to the [TONE 1] button will light and the TONE 1 parameters are assigned to Knobs 1 – 4.

11 Knob Function 2 button

Pressing this button changes the functions assigned to Knobs 5 – 8 (on the lower row). The lamp next to the currently active parameters will light.

NOTE When you press the Knob Function 2 button while holding the [SHIFT] button, the lamp next to the [EQ] button will light and the EQ parameters are assigned to Knobs 5 – 8.

12 Knobs 1 – 8 (page 27)

These eight highly versatile knobs let you adjust various aspects or parameters of the current Voice. In this manual, the knobs on the upper row are called "Knob 1" – "Knob 4" and the knobs on the lower row are called "Knob 5" – "Knob 8." Pressing the Knob Function 1 button will change the functions of Knobs 1 – 4 while pressing the Knob Function 2 button will change the functions of Knobs 5 – 8.

13 ASSIGNABLE FUNCTION [1]/[2] buttons

Depending on the XA (Expanded Articulation) settings in the Voice Element Edit mode, you can call up the specific Element of the selected Voice by pressing each of these buttons during your keyboard performance. In addition, you can assign other functions to these buttons.

14 OCTAVE [-] and [+] buttons (page 26)

Use these buttons to change the note range of the keyboard. To restore the normal octave setting, press both buttons simultaneously.

15 TRANSPOSE [-] and [+] buttons (page 26)

Use these buttons to raise or lower the pitch of the note in semitone steps. To restore the normal octave setting, press both buttons simultaneously.

16 EFFECT buttons

The extensive effect block of the instrument provides Insertion Effects (three sets), System Effects (Reverb and Chorus), and Master Effects. The effects can be applied to the keyboard played Voices and to Song/Pattern playback. When the lamp of the [INSERTION], [SYSTEM] or [MASTER] button is turned on, the corresponding Effect is available.

NOTE When the Reverb/Chorus of the "SystemFXOn/OffBtn" parameter is set to off (not checkmarked) in the [UTILITY] → [F1] GENERAL → [SF1] TG display, the Reverb/Chorus will not function even if the EFFECT [SYSTEM] button is turned on.

17 ARP [ON/OFF] button (page 26)

Press this button to enable or disable playback of the Arpeggio for each Voice, Performance, Song, or Pattern. If the Arpeggio Switch of the selected Part is set to off in the Performance/Song/Pattern mode, however, pressing this button has no effect.

18 ARP [EDIT] button (page 29)

Press this button to call up the Arpeggio Edit display of the Voice/Performance /Song/Pattern mode. When the Arpeggio Edit display is shown with the [E] (Edit indicator) called up by editing a parameter, press the ARP [EDIT] button (the lamp flashes) to call up the Compare status. This restores the original, unedited setting. In the Compare status, the [E] indication is replaced by [C]. Press the ARP [EDIT] button again to exit from the Compare status.

19 [DAW REMOTE] button (page 53)

Turn on this button to enter the Remote mode. The Remote mode lets you control DAW software on your computer from the panel controls of the instrument.

20 SEQ TRANSPORT button (page 18)

These buttons control recording and playback of the Song/Pattern sequence data.

[⏪] (Top) button

Instantly returns to the beginning of the current Song or Pattern (i.e., the first beat of the first measure).

[⏮] (Reverse) button

Press briefly to move back one measure at a time, or hold to continuously rewind.

[⏭] (Forward) button

Press briefly to move forward one measure at a time, or hold to continuously fast-forward.

[REC] (Record) button

Press this to enable recording (Song or Pattern phrase). (The indicator lights.)

[■] (Stop) button

Press to stop recording or playback.

[▶] (Play) button

Press to start playback/recording from the current point in the Song or Pattern. During recording and playback, the indicator flashes at the current tempo.

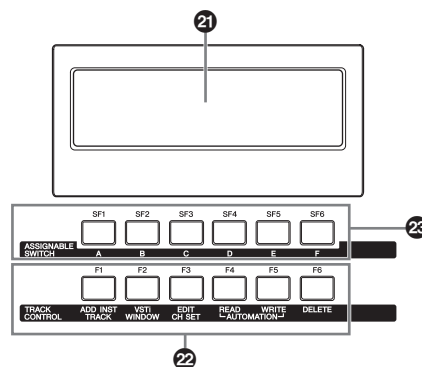
**21 LCD (Liquid Crystal Display)**

The backlit LCD indicates the parameters and values related to the currently selected operation or mode.

22 [F1] – [F6] (Function) buttons (page 20)

These buttons located directly below the LCD call up the corresponding functions indicated in the display.

23 [SF1] – [SF6] (Sub Function) buttons (page 20)

These buttons located directly below the display call up the corresponding sub functions indicated in the display. These buttons can be also used to call up different Arpeggio types in some displays of the Play mode and Record mode (page 26). These buttons can be also used as Song Scene buttons in Song Play/Song Record (see the "Reference Manual" PDF document).

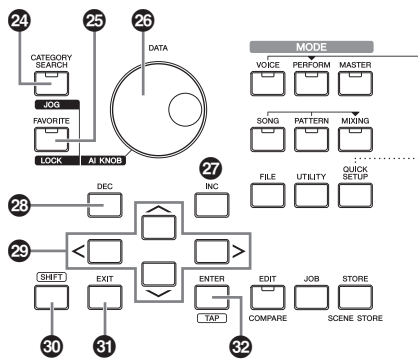

24 [CATEGORY SEARCH] button (page 25)

In the Voice/Performance Part Edit/Song/Pattern mode, turn this button on to call up the Category Search display of the Voice assigned to the current Part. In this status, the [A] – [H] buttons can be used for selecting the Main Category of the Voice.

In the Performance mode (except for the Part Edit mode), turn on this button to call up the Category Search display of the current Performance. In this status, the [A] – [H] buttons can be used for selecting the Main Category of the Performance.

25 [FAVORITE] button

Use this convenient function to store all your favorite, often-used Voices/Performances in a single, easy-to-access location and call them up by pressing the [FAVORITE] button. You can add the current program to a favorite category by simultaneously holding down the [SHIFT] button and pressing this button. This is one more useful way you can quickly select the Voices/Performances you need from the huge number available on the instrument.

26 [DATA] dial

For editing the currently selected parameter. To increase the value, turn the dial right (clockwise); to decrease the value, turn the dial left (counter-clockwise). If a parameter with a wide value range is selected, you can change the value in broader strokes by quickly turning the dial.

27 [INC] button

For increasing the value of the currently selected parameter.

28 [DEC] button

For decreasing the value of the currently selected parameter.

NOTE Simultaneously hold down the [SHIFT] button and press the [INC] button to quickly increase the parameter value in 10-step jumps. Simultaneously hold down the [SHIFT] button and press the [DEC] button to quickly decrease the parameter value in 10-step jumps.

29 Cursor buttons

The cursor buttons move the “cursor” around the display, highlighting and selecting the various parameters.

30 [SHIFT] button

Pressing this button along with another button enables you to execute various commands. For details, refer to the “Shift Function List” (page 59).

31 [EXIT] button

The menus and displays of the MOX6/MOX8 are organized

according to a hierarchical structure. Press this button to exit from the current display and return to the previous level in the hierarchy. Also use it to cancel a Job or a Store operation.

32 [ENTER] button

Use this button to call up the display of the selected menu. Also use this button to execute a Job or a Store operation.

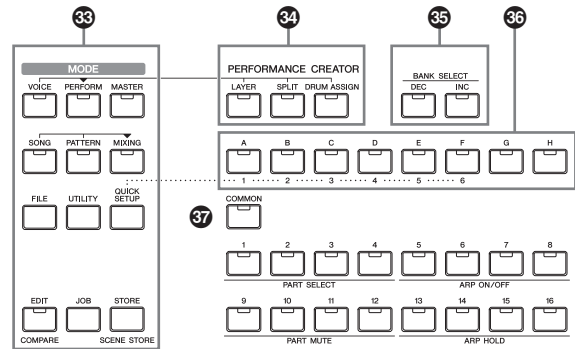

33 [MODE] buttons

These buttons select the MOX6/MOX8 operating modes (e.g., Voice mode).

34 PERFORMANCE CREATOR

This function is for quickly editing/creating a new Performance based on the current Voice. This would come in handy when a certain Voice has effect settings that you want to use in your Performance program.

[LAYER] button

This button is for editing a layer Performance based on the current Voice. When pressing this button, the Category Search display appears and you can select the Voices for use in a layer.

[SPLIT] button

This button is for editing a split Performance based on the current Voice. When pressing this button, the Category Search display appears and you can select the Voices for use in a split.

[DRUM ASSIGN] button

This button is for editing a Performance with a Drum Voice based on the current Voice. When pressing this button, the Category Search display appears and you can select the desired Drum Voice. Also, Arpeggio will be set to on automatically.

35 BANK SELECT [DEC]/[INC] buttons

Use these buttons to select the desired Voice or Performance Bank.

36 Group [A] – [H] buttons

Use these buttons to select the desired Group of Voices/Performances. When the [CATEGORY SEARCH] button is turned on, these buttons can be used to select a category. When the [QUICK SETUP] button is turned on, these buttons can be used to select a Quick Setup.

37 [COMMON] button

Turning this button on enters Common Edit, which lets you

edit the parameters commonly applied to all Elements, Parts or Zones in the following modes: Voice Edit, Performance, Song/Pattern Mixing Edit, Mixing Voice Edit and Master Edit.

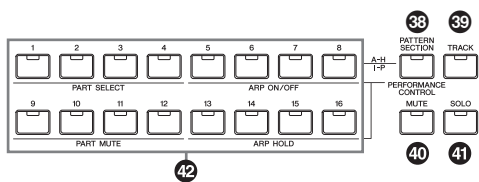

38 [PATTERN SECTION/PERFORMANCE CONTROL] button

This button is available only in the Performance mode and Pattern mode. In the Performance mode, turning on this button will assign the following functions to the Number [1] – [16] buttons.

Number button	Function
[1] – [4]	Selecting Performance Parts 1 – 4.
[5] – [8]	Setting the Arpeggio Switch to on/off for Performance Parts 1 – 4.
[9] – [12]	Setting the mute status for Performance Parts 1 – 4.
[13] – [16]	Setting the Arpeggio Hold for Performance Parts 1 – 4.

In the Pattern mode, turning on this button will assign Sections A – H to the Number [1] – [16] buttons.

42 Number [1] – [16] buttons

Use of these buttons differs depending on the on/off status of the [PATTERN SECTION/PERFORMANCE CONTROL], [TRACK], [MUTE] and [SOLO] buttons.

Functions of the Number [1] – [16] buttons

Mode	When the [PATTERN SECTION/PERFORMANCE CONTROL] button is turned on:	When the [TRACK] button is turned on:	When the [MUTE] button is turned on:	When the [SOLO] button is turned on:	When all the buttons are turned off:
Voice Play	–	Keyboard transmit channel setting	–	–	Voice selection
Normal Voice Edit	–	Changes the Edit mode from Common Edit to Element Edit and Element selection ([1]–[8]).	Element Mute setting ([9] – [16])	Solo Element selection ([9] – [16])	–
Drum Voice Edit	–	Changes the Edit mode from Common Edit to Drum Key Edit	–	–	–
Performance Play	Performance Control (38)	Keyboard transmit channel setting	Part Mute setting ([1] – [4])	Solo Part selection ([1] – [4])	Performance selection
Performance Edit	Performance Control (38)	Performance Part selection ([1] – [4])	Part Mute setting ([1] – [4])	Solo Part selection ([1] – [4])	–
Master Play	–	Keyboard transmit channel setting (when memorizing the Voice mode or Performance mode to the current Master) or Song/Pattern Track selection (when memorizing the Song mode or Pattern mode to the current Master)	–	–	Master program selection
Master Edit	–	Changes the Edit mode from Common Edit to Zone Edit and Zone selection ([1] – [8])	–	–	–
Song/Pattern Play	Section selection in the Pattern mode	Song/Pattern Track selection	Song/Pattern Track Mute setting	Solo Track selection	Song/Pattern selection
Song/Pattern Mixing	Section selection in the Pattern mode	Song/Pattern Part selection	Song/Pattern Part Mute setting	Solo Part selection	Voice selection of the current Part
Mixing Voice Edit	–	Element selection ([1] – [8])	Element Mute setting ([9] – [16])	Solo Element selection ([9] – [16])	–

39 [TRACK] button

Turning this button on in the Song/Pattern mode enables the Number [1] – [16] buttons for selecting corresponding Song/Pattern Tracks.

40 [MUTE] button (page 38)

Turning this button on in Normal Voice Edit and Mixing Voice Edit enables the Number [1] – [8] buttons for muting Voice Elements (1 – 8). Turning this button on in the other modes enables the Number [1] – [16] buttons for muting Performance Parts (1 – 4), Song Tracks/Parts (1 – 16), and Pattern Tracks/Parts (1 – 16).

41 [SOLO] button (page 38)

Turning this button on in Normal Voice Edit and Mixing Voice Edit enables the Number [1] – [8] buttons for soloing a Voice Element (1 – 8). Turning this button on in the other modes enables the Number [1] – [16] buttons for soloing a Performance Part (1 – 4), a Song Track/Part (1 – 16), and a Pattern Track/Part (1 – 16).

NOTE The on/off status of buttons 39 – 41 affects the Number [1] – [16] buttons in different ways, depending on the currently selected mode. Refer to the table below.

Rear Panel

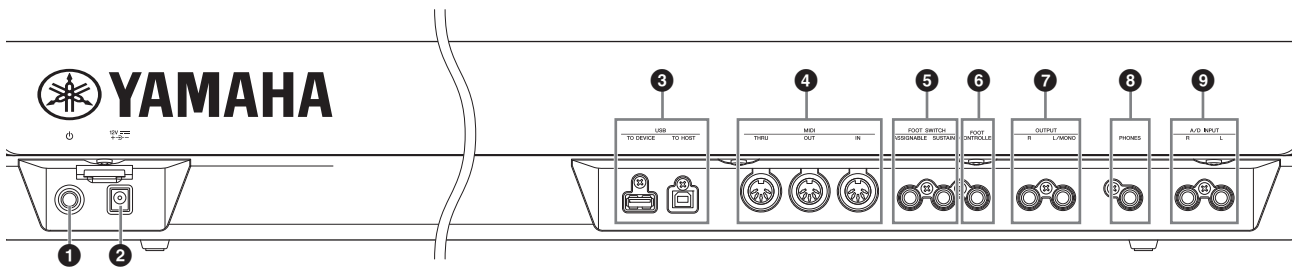

1 ⏻ Standby/On switch (page 17)

Press to turn the power On (⏻) or Standby (⏻).

2 DC IN connector (page 17)

Connect the supplied power adaptor to this connector.

3 USB terminals

There are two different types of USB terminals, and the rear panel of the instrument features both.

The USB [TO HOST] terminal is used to connect this instrument to the computer via the USB cable and allows you to transfer MIDI data and audio data between the devices. Unlike MIDI, USB can handle multiple ports via a single cable. For information about the Port handled by the MOX6/MOX8, see page 51.

The USB [TO DEVICE] terminal is used to connect this instrument to a USB flash memory device via the USB cable. This lets you save data created on this instrument to an external USB flash memory device and load data from a USB flash memory device to the instrument. Save/Load operations can be performed in the File mode (page 57).

NOTE Only USB flash memory device can be recognized by this instrument. Any other USB storage devices (such as hard disk drive, CD-ROM drive and USB hub) cannot be used.

NOTE Though the instrument supports the USB 1.1 standard, you can connect and use a USB 2.0 storage device with the instrument. However, note that the transfer speed is that of USB 1.1.

4 MIDI [IN] / [OUT] / [THRU] terminals

MIDI [IN] is for receiving control or performance data from another MIDI device, such as an external sequencer, letting you control this instrument from the connected separate MIDI device.

MIDI [OUT] is for transmitting all control, performance and playback data from this instrument to another MIDI device, such as an external sequencer.

MIDI [THRU] is simply for redirecting any received MIDI data (via MIDI [IN]) to connected devices, allowing convenient chaining of additional MIDI instruments.

5 FOOT SWITCH [ASSIGNABLE]/[SUSTAIN] jacks

For connection of an optional FC3/FC4/FC5 Footswitch to the [SUSTAIN] jack and a FC4/FC5 Footswitch to the [ASSIGNABLE] jack. When connected to the [SUSTAIN] jack, the Footswitch controls sustain. When connected to

[ASSIGNABLE], it can control one of various different assignable functions.

6 [FOOT CONTROLLER] jack

For connection of an optional foot controller (FC7, etc.). This jack lets you continuously control one of various different assignable functions—such as volume, tone, pitch, or other aspects of the sound.

7 OUTPUT [L/MONO] and [R] jacks

Line level audio signals are output via these phone jacks. For monophonic output, use only the [L/MONO] jack.

8 [PHONES] (Headphone) jack

This standard stereo phones jack is for connection to a set of stereo headphones. This jack outputs audio signals identical to those from the OUTPUT [L/MONO] and [R] jacks

9 A/D INPUT [L] and [R] jacks

External audio signals can be input via these phone jacks (mono phone plug).

Various devices such as microphone, guitar, bass, CD player, synthesizer can be connected to these jacks and their audio input signal can be sounded as the Audio Part of the Voice, Performance, Song, or Pattern. In addition, you can use the special Vocoder feature (page 37) by connecting a microphone to one of these jacks and inputting your Voice to the microphone.

Use mono phone plugs. For stereo signals (such as from audio equipment), use both jacks. For mono signals (such as from a microphone or guitar), use only one of these jacks according to the “Mono/Stereo” parameter setting.

NOTE When using these jacks, make sure to confirm the “Mono/Stereo” parameter setting which can be set in the following displays for each mode:

- For the Voice mode: the VCE A/D display in the Utility mode
- For the Performance mode: the A/D IN display in Common Edit
- For the Song/Pattern mode: the A/D IN display in Mixing Common Edit

Setting Up

Power supply

Make connections for the supplied power adaptor (page 68) in the following order. Before you connect the power adaptor, make sure that the power of this instrument is set to the Standby status.

- 1 Connect the plug of the power adaptor to the DC IN terminal on the rear panel.
- 2 Connect the other end of the power adaptor to an AC outlet.

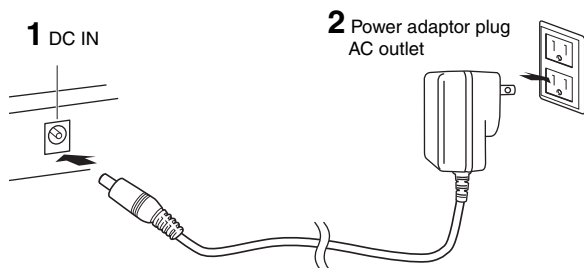

NOTE Follow this procedure in reverse order when disconnecting the power adaptor.

WARNING

Use the specified adaptor (page 68). The use of other adaptors may result in irreparable damage to both the adaptor and the instrument.

CAUTION

- Make sure your MOX6/MOX8 is rated for the AC voltage supplied in the area in which it is to be used (as listed on the rear panel). Connecting the unit to the wrong AC supply can cause serious damage to the internal circuitry and may even pose a shock hazard!
- Even when the power of this instrument is in the Standby status, electricity is still flowing to the instrument at the minimum level. When you are not using the instrument for a long time, make sure you unplug the power adaptor from the wall AC outlet.

Connecting speakers or headphones

Since this instrument has no built-in speakers, you will need to monitor the sound of the instrument by using external equipment. Connect a set of headphones, powered speakers, or other playback equipment as illustrated below. When making connections, be sure that your cables have the appropriate ratings.

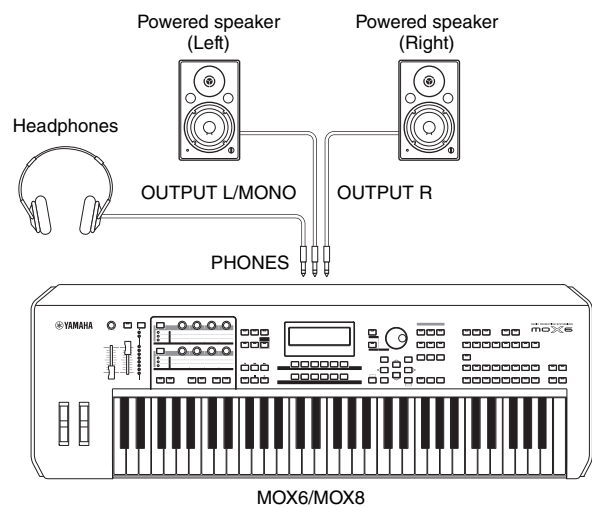

Powering up the system

Make sure the volume settings of this instrument and external devices such as powered speakers are turned down to the minimum before turning the power on. When connecting this instrument to the powered speakers, turn on the power switch of each device in the following order.

When turning the power on:

First, the MOX6/MOX8, then the connected powered speakers.

When turning the power off:

First, the connected powered speakers, then the MOX6/MOX8.

Please keep in mind that the Standby/On switch is located at the right end (from the view of the keyboard) on the rear panel of the MOX6/MOX8.

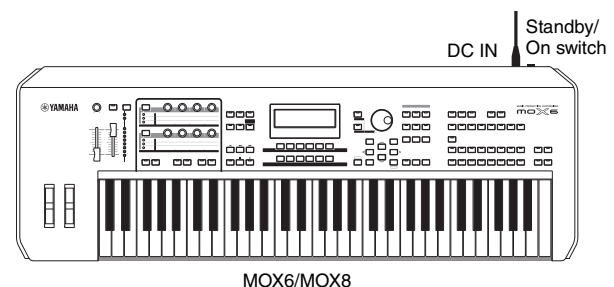

Adjusting the volume and the brightness of the display

Adjust the volume levels of this instrument and the connected amplifier/speaker system.

NOTE When connecting to a set of powered speakers or PA equipment, set the MASTER VOLUME to about 70%, then raise the volume of the powered speakers or PA equipment to the appropriate level.

If the display is not easily visible, press the [INC]/[DEC] button while holding the [UTILITY] button to adjust for optimum visibility.

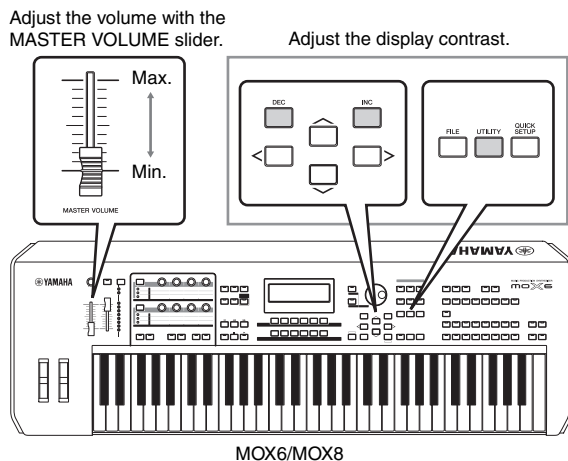

CAUTION

Do not listen with the headphones at high volume for long periods of time. Doing so may cause hearing loss.

Starting up

Try playing some of the realistic and dynamic MOX6/MOX8 sounds from the keyboard now. When you turn the power on, the display below appears.

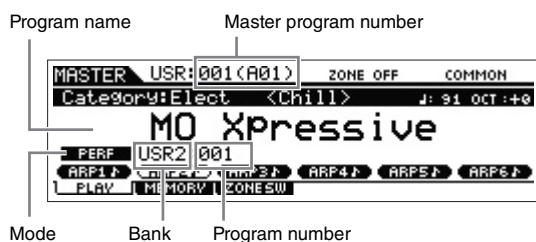

NOTE In the default settings, the Master mode is selected. See page 22 for details about the modes.

NOTE Keep in mind that the example displays shown in this manual are for instruction purposes only, and may appear somewhat different from those on your instrument.

In this condition you can play the keyboard and hear the sounds of the selected program. In the default setting, the Master mode provides a total of 128 programs each of which includes the mode (Voice, Performance, Song, Pattern) and its program number. The top of the Master Play display indicates the Master program number and the status (Mode,

Bank, Program number and its name) registered to the current Master program.

NOTE For details about Banks, see pages 24 and 32.

Selecting programs

In the default setting, the Master mode provides a total of 128 programs each of which includes the mode (Voice, Performance, Song and Pattern) and its program number. Try out the different Master programs to play various Voices and Performances. You can change the Master program number by using the [INC] button, [DEC] button, or [DATA] dial.

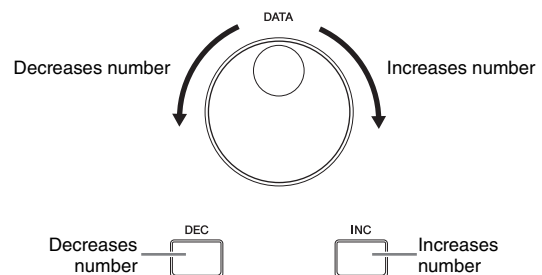

Playing the Demo Songs

The MOX6/MOX8 features a variety of Demo Songs, showcasing its dynamic sound and sophisticated functions. Here's how to play them back.

1 Press the [SONG] button to enter the Song Play mode.

The PLAY display appears.

2 Press the SEQ TRANSPORT [▶] (Play) button to start the Demo Song.

The Song currently shown on the display starts.

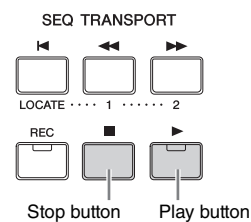

NOTE To adjust the volume level of the Demo Songs, use the [MASTER VOLUME] slider.

3 Press the SEQ TRANSPORT [■] (Stop) button to stop the Demo Song.

4 Select another Demo Song by using the [INC] button or [DATA] dial.

5 Play the selected Demo Song by performing Steps 2 and 3.

Resetting User Memory to the initial factory settings

The original factory settings of this synthesizer's User Memory can be restored as follows.

■ NOTICE ■

When the factory settings are restored, all the Voice, Performance, Song, Pattern, and system settings in the Utility mode you created will be erased. Make sure you are not overwriting any important data. Be sure to save all important data to your USB flash memory device before executing this procedure (page 57).

- 1 Press the [UTILITY] button then the [JOB] button to call up the Factory Set display.

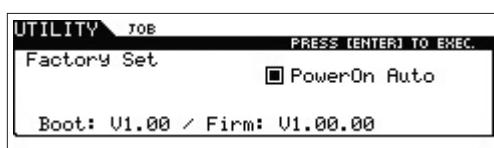

- 2 Press the [ENTER] button.

The display prompts you for confirmation. To cancel this operation, press the [EXIT] button here.

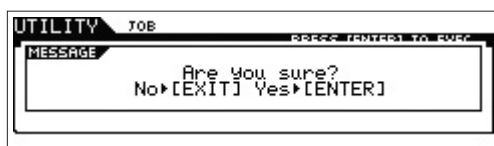

■ NOTICE ■

When entering a checkmark to the box of Power On Auto Factory Set and executing Factory Set, the Factory Set operation will automatically be executed each time you turn the power on. Keep in mind that this also means that your original data in Flash ROM will be erased each time you turn on the power. Therefore, the checkmark of this box should normally be removed. If you remove the checkmark of this box and execute Factory Set, the Factory Set operation will not be executed when turning the power on the next time.

- 3 Press the [ENTER] button to execute Factory Set.

After Factory Set has been completed, a "Completed" message appears and operation returns to the original display.

■ NOTICE ■

For Factory Set operations that take longer to process, you will see the message "Now executing Factory Set..." during processing. While such a message is shown on the display, never attempt to turn off the power. Turning the power off in this state results in loss of all user data and may cause the system to freeze (due to corruption of data in the Flash ROM). This means that this synthesizer may not be able to start up properly, even when turning the power on next time.

Basic Operation

Moving the cursor

Use these four buttons to navigate the display, moving the cursor around the various selectable items and parameters in the screen. When selected, the relevant item is highlighted (the cursor appears as a dark block with inverse characters). You can change the value of the item (parameter) at which the cursor is located by using the [DATA] dial, [INC] and [DEC] buttons.

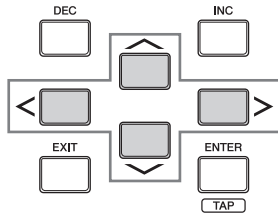

Changing (editing) parameter values

Rotating the [DATA] dial to the right (clockwise) increases the value, while rotating it to the left (counter-clockwise) decreases it.

Pressing the [INC] button increases a parameter value by one step, and pressing [DEC] decreases it. Pressing and holding either button continuously increases or decreases the value.

For parameters with large value ranges, you can increase the value by 10 by simultaneously holding down the [SHIFT] button and pressing the [INC] button. To decrease by 10, simultaneously hold down the [SHIFT] button and press the [DEC] button.

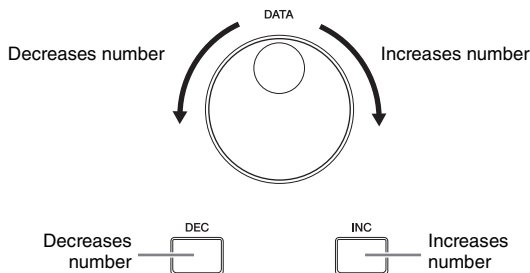

Functions and Sub-Functions

Each mode described above contains various displays, with various functions and parameters. To navigate your way through these displays and select a desired function, use the [F1] – [F6] buttons and the [SF1] – [SF6] buttons. When you select a mode, the available displays or menus appear directly above the buttons at the bottom of the display (as shown below).

Depending on the currently selected mode, up to six functions are available and can be called up with the [F1] – [F6] buttons. Keep in mind that the available functions differ depending on the selected mode. Depending on the currently selected function, up to six sub-functions are available and can be

called up with the [SF1] – [SF6] buttons. Keep in mind that the available sub-functions differ depending on the selected function.

The example display below is called up by pressing the [F5] LFO button then pressing the [SF1] Wave button. In this example display, no sub-function is assigned to the [SF6] button.

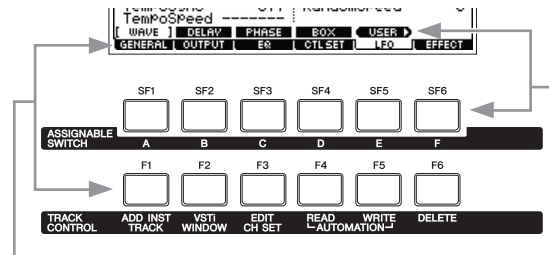

These functions can be selected via the corresponding button ([F1] – [F6]).

These functions can be selected via the corresponding button ([SF1] – [SF6]).

Inputting a number directly

For parameters having large value ranges, you can also enter the value directly, using the buttons below the LCD as a numeric keypad. When the cursor is located on such a parameter, the [NUM] icon appears at the lower right corner of the LCD. When the [SF6] NUM button is pressed in this status, each digit (1 – 9, 0) is assigned to the [SF1] – [SF5] and [F1] – [F5] buttons as shown below, allowing you to input a number directly by using these buttons. Depending on the selected parameter, a negative value can be input. When such a parameter is selected and you wish to input a negative value, press the [F6] button (to which “-” is assigned) then use the [SF1] – [SF5] and [F1] – [F5] buttons. After completing the number input, press the [ENTER] button to actually enter the number and exit from this status.

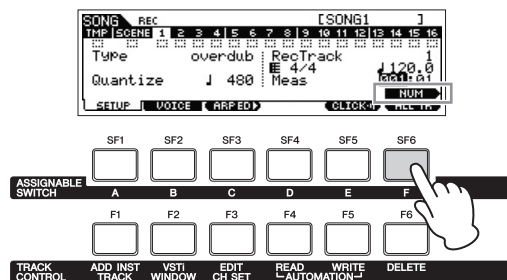

You can use these buttons as a numeric keypad.

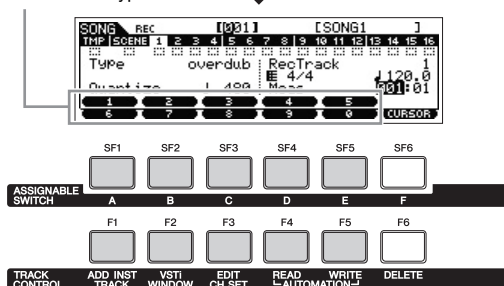

Naming (inputting characters)

You can freely name the data you've created, such as Voices, Performances, Songs, Patterns and files saved to a USB flash memory device. When the cursor is located on such a naming parameter, the "CHAR" icon appears at the lower right corner of the display. When pressing the [SF6] button in this status, the Input Character window appears as shown below.

In the Edit area, you can move the cursor to determine the location at which the character is to be input by pressing the [<] or [>] button while holding the [SF6] button.

In the Character List, you can move the cursor to determine the character to be input by rotating the [DATA] dial or pressing the [INC] or [DEC] button while holding the [SHIFT] button. After completing the character input, press the [ENTER] button to actually enter the currently edited name and exit from this status.

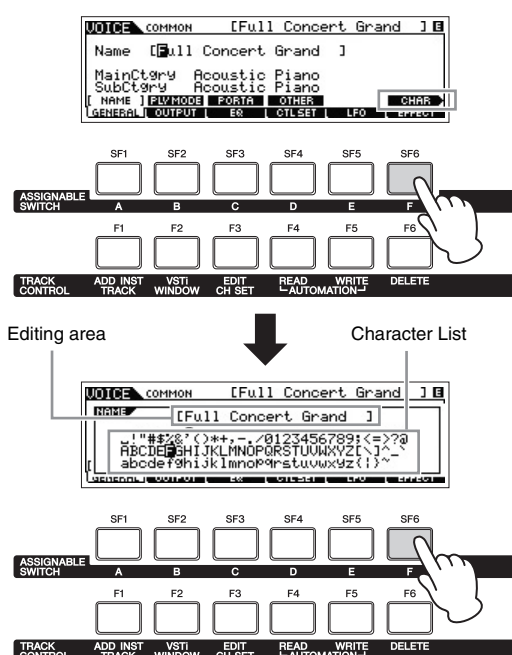

Selecting a note type

When the cursor is located on a parameter for which note types are to be set, the note icon appears at the lower right corner indicating that you can call up the Note Type selection window by pressing the [SF6] button. You can specify the note type by pressing the [F1] – [F6] buttons and the [SF1] – [SF5] buttons.

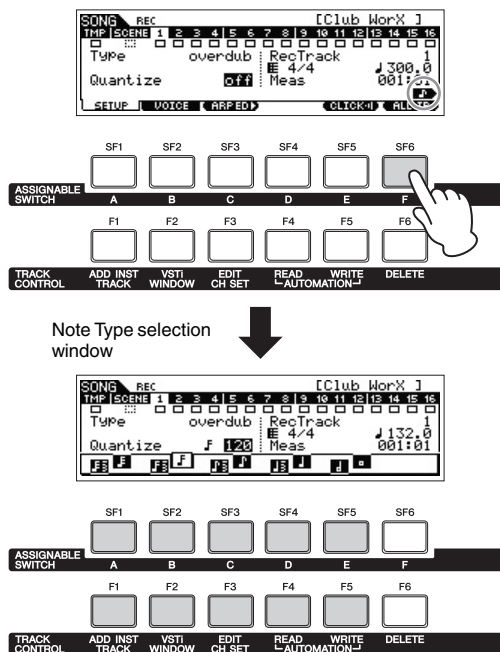

Note (Key) and Velocity settings

Several parameters let you set a key range or velocity range for a function—for example, in setting up a keyboard split—by specifying certain note values. You can use the [INC] and [DEC] buttons or [DATA] dial to set these parameters, or you can directly enter the values from the keyboard by pressing the appropriate keys. When the cursor is located on such a parameter, the "KBD" icon appears at the lower right corner of the display. You can set the note or velocity directly from the keyboard by holding down the [SF6] button and pressing the desired key.

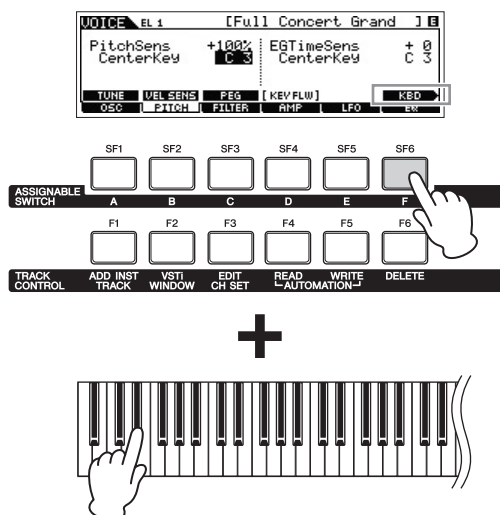

Quick Guide

Modes

There are several operation modes in this instrument, and they can be selected by using the ten Mode buttons, **1** – **10**. In addition, there are three “global” modes (Edit, Job and Store) common to all of these modes, and they can be selected by using buttons **11** – **13**.

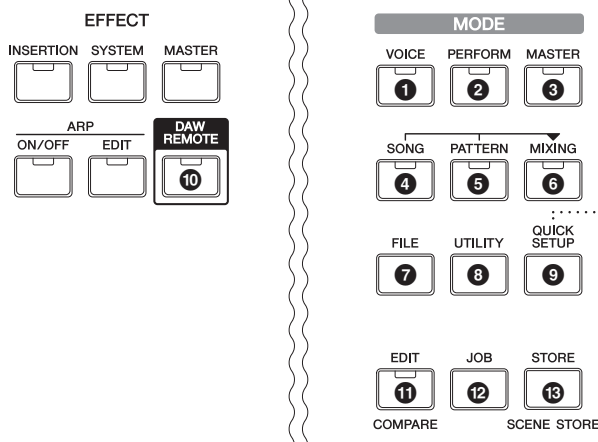

No.	Button	Mode	Description
1	[VOICE]	Voice mode	This synthesizer has a wealth of high quality, dynamic sounds—also referred to as “Voices.” You can play these Voices—one Voice at a time—from the keyboard in the Voice mode. This mode also lets you create your own original Voices.
2	[PERFORM]	Performance mode	This mode lets you play and create Performances. A Performance lets you put several different Voices together in layers or play different two Voices in a keyboard split.
3	[MASTER]	Master mode	This mode lets you register settings that you often use in the Voice, Performance, Song or Pattern mode, and instantly recall the relevant mode and custom settings together in a single button press—without having to first select a mode. In addition, this mode lets you divide the keyboard into four separate sections—just as if you were playing four different MIDI keyboards.
4	[SONG]	Song mode	This mode lets you record, edit and play your own original Songs.
5	[PATTERN]	Pattern mode	This mode lets you play, record, edit and play your own original rhythm patterns, which can be used to make up a Song.
6	[MIXING]	Song Mixing mode/ Pattern Mixing mode	This mode lets you set up detailed parameters of the multi-timbral tone generator for use with Song/Pattern playback.
7	[FILE]	File mode	This mode lets you save data you've created on this instrument to a USB flash memory device, and allows you to load data from the USB flash memory device to the MOX6/MOX8.
8	[UTILITY]	Utility mode	This mode lets you set parameters that apply to the entire system of this instrument.
9	[QUICK SETUP]	Quick Setup mode	This mode lets you register up to six settings for MIDI connection and Audio connection between this instrument and the computer as “Quick Setups,” and instantly recall the custom settings with a single button press.
10	[DAW REMOTE]	Remote mode	This mode lets you control DAW software on your computer from the panel controls of the instrument.
11	[EDIT]	Edit	This mode lets you edit various parameters in each of the Voice, Performance, Song, Pattern and Master modes.
12	[JOB]	Job	This mode lets you execute various commands such as Initialize, Copy, and MIDI data conversion—useful for creating your original programs.
13	[STORE]	Store	This mode lets you store the edited program to internal memory.

Basic Instructions

Voices—the basic building blocks of the MOX6/MOX8

Selecting a Preset Voice	page 24
Editing a Voice	page 27

Combining several Voices to create a Performance

Creating a new Performance in the Voice mode by using your favorite Voices (Performance Creator)	page 30
Selecting a Performance.....	page 32
Editing a Performance	page 32

Connecting a microphone or audio equipment

Playing the keyboard along with the sound input from the A/D INPUT [L]/[R] jacks	page 36
--	---------

Song/Pattern—created by recording your keyboard performance and assembling Pattern sections

Creating an original Song	page 38
Creating an original Pattern	page 44

Master mode—create a master keyboard setup or instantly call up your desired programs

Using as a Master Keyboard (Master Mode)	page 55
--	---------

Music creation by using a computer

Recording your performance on the MOX6/MOX8 to DAW	page 52
Using the MOX6/MOX8 as a tone generator for DAW playback	page 52
Remote-controlling the DAW (Remote mode).....	page 53
Using the MOX6/MOX8 Editor VST as a software synthesizer	page 54

Global settings and data backup

Making global system settings (Utility mode/Quick Setup)	page 56
Saving / loading data in the File mode.....	page 57

Playing the keyboard in the Voice mode

In the Voice Play display (the top display of the Voice mode), you can select and play a single Voice. The Voices of this instrument are divided into the following two types:

Normal Voice

Normal Voices are mainly pitched musical instrument type sounds (piano, organ, guitar, etc.) that can be played over the range of the keyboard.

Drum Voice

Drum Voices are mainly percussion/drum sounds that are assigned to individual notes. These Voices are used to perform rhythm parts.

This instrument features Banks for memorizing Voices. There are basically three different types of Banks: Preset, User, and GM. The contained Voices and features depend on the Bank as described below.

Preset Banks

The Preset Banks contain a full set of specially programmed Voices. Voices you've edited yourself cannot be saved in the Preset Banks.

User Banks

The User Banks contain the Voices you have edited and stored. By default, these are comprised of Preset Voices.

NOTICE

If a Voice in a User Bank (User Voice) is overwritten or replaced, that User Voice will be lost. When you store an edited Voice, be careful not to overwrite any important User Voices.

GM Bank

The GM Bank contains the Voices allocated according to the GM standard.

GM Voice

GM (General MIDI) is a worldwide standard for Voice organization and MIDI functions of synthesizers and tone generators. It was designed primarily to ensure that any Song data created with a specific GM device would sound virtually the same on any other GM device—no matter the manufacturer or the model. The GM Voice bank on this synthesizer is designed to appropriately play back GM Song data. However, keep in mind that the sound may not be exactly the same as played by the original tone generator.

In the Voice mode, a total of 15 Banks (Preset Bank 1 – 8, User Bank 1 – 3, GM Bank, Preset Drum Bank, User Drum, GM Drum Bank) are available. Each of these Banks includes the Voices according to the Voice type. In the Voice Play display, you can select the desired Voice from various Voice Banks and play it.

NOTE For details about Voices, refer to "Basic Structure." For a list of the Preset Voices, refer to the separate Data List PDF file.

Selecting a Preset Voice

1 Press the [VOICE] button.

This calls up the Voice Play display. (The [VOICE] button lamp lights.)

2 Select a Voice Bank with the BANK SELECT [DEC]/[INC] buttons.

In this condition, playing the keyboard sounds the Voice indicated in the display. The parameters shown in the Voice Play display are briefly explained below.

● Voice Play display

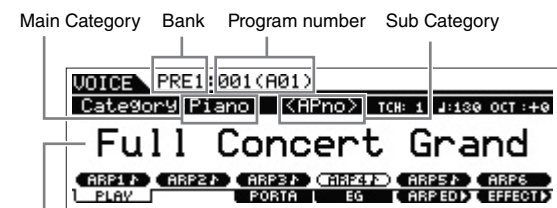

Voice name

● Normal Voice Banks

There are 12 different banks for the Normal Voices: PRE1 – 8 (Preset Banks), USR1 – 3 (User Banks), GM (GM Bank).

● Drum Voice Banks

There are 3 different banks for the Drum Voices: PDR (Preset Drum Bank), UDR (User Drum Bank), GMDR (GM Drum Bank).

3 Select a Voice with the [DATA] dial or [INC]/[DEC] buttons.

NOTE You can use the [DATA] dial or [INC]/[DEC] buttons to select the Voice number. This operation lets you call up Voices in subsequent or previous Banks.

NOTE To quickly move forward through the program (Voice) numbers in 10-step jumps, simultaneously hold down the [SHIFT] button and press the [INC] button in the Play display. To decrease by 10, do the opposite; simultaneously hold down the [SHIFT] button and press the [DEC] button.

4 Play the keyboard.

Using the Category Search function

The Voices are conveniently divided into specific Categories, irrespective of their bank locations. The categories are divided based on the general instrument type or sound characteristics. The Category Search function gives you quick access to the sounds you want.

1 Press the [CATEGORY SEARCH] button in the Voice Play display.

The Category Search display appears.

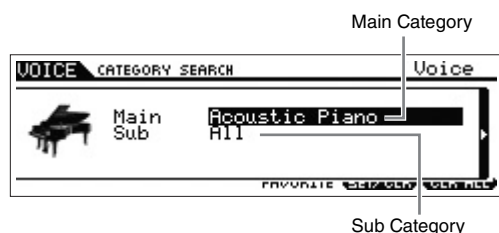

2 Move the cursor position to “Main” (Main Category) with the Cursor [^] button, and use the [DATA] dial to select the Main Category.

3 Move the cursor position to “Sub” (Sub Category) with the Cursor [v] button, and use the [DATA] dial to select the Sub Category.

4 Press the [ENTER] button, or Cursor [>] button to actually call up the selected Category.

The Voice List of the selected category is shown.

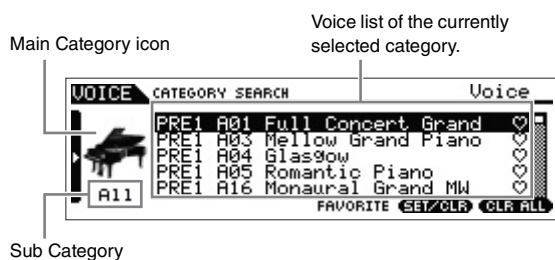

5 Select the Voice with the Cursor [^]/[v] buttons or [DATA] dial.

If you want to change the Category, press the Cursor [←] button or [EXIT] button and go back to step 2.

6 Press the [ENTER] button to actually call up the Voice.

This closes the Category Search display.

Grouping your most-used Voices together—Favorite Category

Category Search also has a convenient Favorite Category that lets you collect your most often used and favorite Voices for easy selection. This is one more useful way you can quickly select the Voices you need from the huge number available on the instrument.

Registering your favorite Voices to the Favorite Category

1 Perform steps 1 through 4 of the “Using the Category Search function” instructions to call up the Voice List of the selected Category.

2 Select the desired Voice with the Cursor [^]/[v] buttons or [DATA] dial.

3 Press the [F5] SET/CLR button to turn on the Favorite mark.

This operation will turn on the Favorite mark, making it solid (♥), and the selected Voice will be registered to the Favorite Category. Pressing the [F5] SET/CLR button again will turn off or “ghost” the Favorite mark (♡).

To register other Voices, repeat steps 2 through 3.

To remove all the Voices from the Favorite Category, press the [F6] CLR ALL button.



4 When you complete registering Voices to the Favorite Category, press the [ENTER] button to return to the Voice Play display.

This operation will exit from the Category Search display and store the Favorite Category settings to internal Flash ROM.

To register/remove the current Voice to/from the Favorite Category, simply hold the [SHIFT] button then press the [FAVORITE] button.

Selecting a Voice from the Favorite Category

- 1 Press the [FAVORITE] button in the Voice Play display.
The list of Voices registered to the Favorite Category will be shown.
- 2 Select the Voice with the Cursor [^]/[v] buttons or [DATA] dial.
- 3 Press the [ENTER] button to actually call up the Voice.

Using the Arpeggio function

The Arpeggio function automatically triggers preset arpeggio phrases, riffs, and rhythmic patterns according to the notes you play.

It not only provides inspiration and full rhythmic passages over which you can perform, it gives you quality MIDI data you can use in creating Songs, or fully formed backing parts to be used in your live performances. You can assign the desired six Arpeggio Types to each Voice. You can also assign the desired six Arpeggio Types to each Part of each Performance/Song/Pattern and play back the Arpeggios of up to four Parts simultaneously.

You can also set the Arpeggio playback method, Note range, Velocity range and Play Effects to create your own original grooves. What's more, Arpeggio playback can be transmitted through MIDI Out, letting you record the Arpeggio data to a sequencer.

NOTE For details about Arpeggio, see the "Reference Manual" PDF document.

Turning the Arpeggio On/Off

To turn Arpeggio playback on or off, press the ARP [ON/OFF] button on the panel.

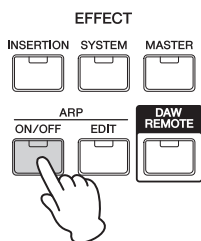

Changing the Arpeggio type

Arpeggio types are assigned to each of the [SF1] – [SF6] buttons, the corresponding tabs of which are indicated by 8th note icons (♪) at the right of "ARP1" – "ARP6." This means that you can change the Arpeggio type by pressing the [SF1] – [SF6] buttons as desired.

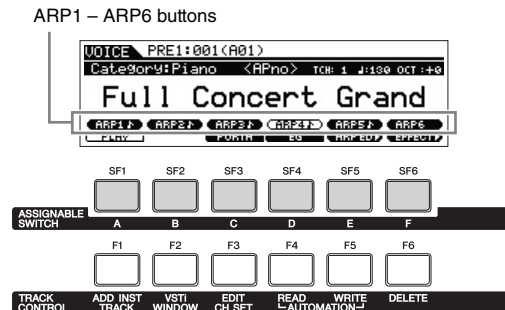

NOTE For information on setting the Arpeggio Type, refer to "Changing the Arpeggio Type assignment" on page 29.

Keyboard Octave/Transpose setting

To shift the pitch range in playing the keyboard, use the OCTAVE [-]/[+] buttons and TRANSPOSE [-]/[+] buttons.

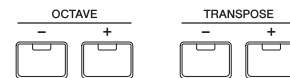

● Octave

The OCTAVE [-]/[+] button lets you shift the pitch of the keyboard in octaves, up to a maximum of three. For example, you may want to shift the pitch down lower to get extra bass notes, or shift up to get higher notes for leads and solos. The OCTAVE [-]/[+] controls let you do this quickly and easily. The range is from -3 to +3, with 0 being standard pitch. Pressing the [-] and the [+] buttons together at the same time will return the setting to the initial value (0).

The current octave range can be confirmed via the status of the lamp of the OCTAVE [-]/[+] buttons. When set to one octave down or up, the corresponding lamp lights. When set to two octaves down or up, the corresponding lamp flashes slowly. When set to three octaves down or up, the corresponding lamp flashes quickly.

● Transpose

The TRANSPOSE [-]/[+] button lets you shift the pitch of the keyboard in semitones (up to 11 semitones). This function allows you to play in the same position and with the same fingering, even if the Song data or another instrument player is playing in a different key. The Transpose Up/Down controls let you do this quickly and easily. Pressing the [-] and the [+] buttons together at the same time will return the setting to the initial value (0). When set to one semitone down or up, the corresponding lamp lights.

NOTE This parameter is same as “Octave” and “Transpose” in the GENERAL display of the Utility mode. Making a setting here automatically changes the setting of that parameter as well.

Changing the tonal qualities of the Voice

Knobs 1 – 8 let you adjust a variety of parameters for the current Voice, such as effect depth, attack/release characteristics, timbre, and others. Three functions can be assigned to each Knob, alternatively selected via the Knob Function buttons.

- 1 Press the Knob Function 1 button (at the left of Knobs 1 – 4) and Knob Function 2 button (at the left of Knobs 5 – 8) repeatedly if necessary, so that the lamp corresponding to the desired functions lights.**

The KNOB FUNCTION pop-up window will appear. In the pop-up display, the function currently assigned to the knob and the current value of the function are shown. To close the pop-up window, press the [EXIT] button.

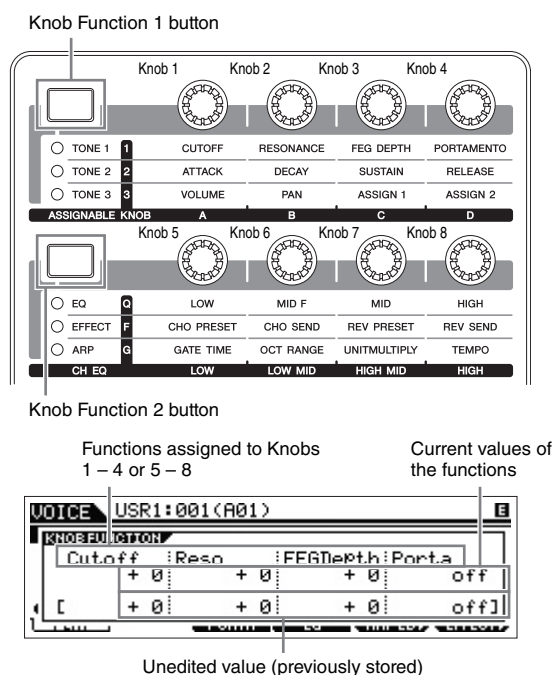

NOTE When the “Knob FuncDispSw” is set to “off” in the Utility GENERAL display, the KNOB FUNCTION pop-up window will not be shown.

- 2 Turn a desired knob while playing the keyboard.**
- The KNOB FUNCTION pop-up window will appear, and the function assigned to the knob you’re currently operating will affect the sound of the current Voice. The KNOB FUNCTION pop-up window shows the function assigned to the knob you’re currently operating, the function value, and the “Original” value. The “Original” value indicates the unedited value (previously stored value) of the function assigned to the knob.

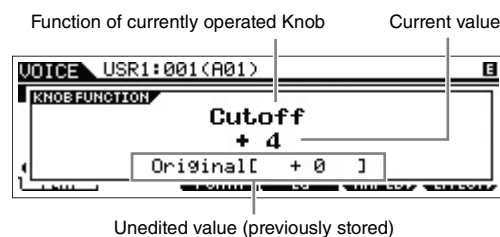

HINT

The Edit Indicator

When changing the value of the parameter, the Edit Indicator **E** will appear on the top right corner of the LCD. This gives a quick confirmation that the current program (such as Voice and Performance) has been modified but not yet stored. To store the current edited status, execute the Store operation (below).

Editing a Voice

“Editing” refers to the process of creating a Voice by changing the parameters that make up the Voice. This can be done in Voice Edit, a sub mode within the Voice mode. The actual parameters that are available differ depending on the Voice type.

Normal Voice Edit

A Normal Voice (pitched musical instrument-type sounds) can consist of up to eight Elements. There are two types of Voice Edit displays: Common Edit, for editing the settings common to all eight Elements; and Element Edit, for editing individual Elements.

NOTE An Element is the basic and the smallest unit for a Voice, and is created by applying various parameters (Effect, EG, etc.) to the waveform of the instrument sound. Each Voice of this instrument consists of several Elements.

Drum Voice Edit

There are two types of Drum Voice Edit displays: Common Edit, for editing the settings that apply to all Drum keys in the Voice; and Key Edit, for editing individual keys.

Basic Procedure for Voice Edit

1 Press the [EDIT] button in the Voice mode.

2 Edit the current Voice.

- When a Normal Voice is selected:

To edit Common parameters, press the [COMMON] button.

To edit Element parameters, press the desired Element number button from [1] – [8].

- When a Drum Voice is selected:

To edit Common parameters, press the [COMMON] button.

To edit Key parameters, press the [1] button then press the desired note on the keyboard.

NOTE For details about the Voice parameters, refer to the Voice mode chapter in the Reference Manual.

Common Edit display

Indicates the Common Edit display.

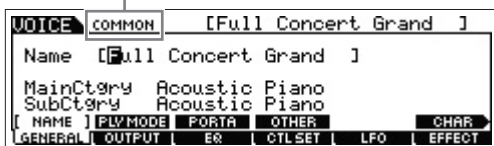

Element Edit display

Indicates the display for editing Element 1.

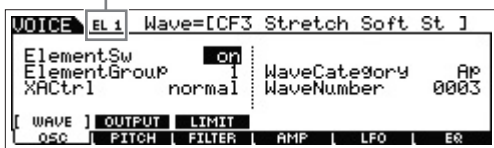

Key Edit display

Indicates the Key Edit display.

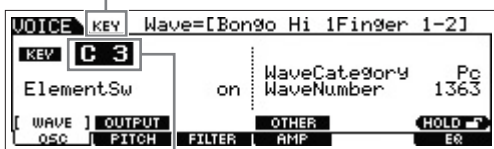

Select a Key here.

3 Assign the name to the edited Voice.

On the display called via [COMMON] → [F1] GENERAL → [SF1] NAME, enter the desired name.

4 Store your edits as a User Voice.

Press the [STORE] button to call up the Store display. Set the destination memory then press the [ENTER] button to execute the Store operation.

Store display

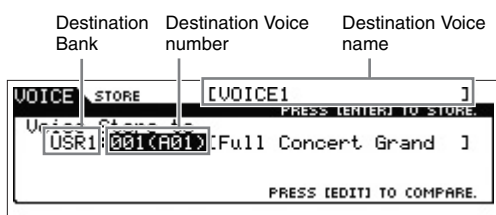

NOTE To cancel the Store operation, press the [EXIT] button before pressing the [ENTER] button.

NOTICE

Never attempt to turn off the power while data is being written to Flash ROM (while an “Executing...” or “Please keep power on” message is shown). Turning the power off in this state results in loss of all user data and may cause the system to freeze (due to corruption of data in the Flash ROM).

HINT

Compare function

The Compare function lets you switch between the just-edited Voice and its original, unedited condition, allowing you to hear how your edits affect the sound.

- In the Voice Edit mode (with the [EDIT] lamp lit):

Press the [EDIT] button so that its lamp flashes. In this status, the Voice settings prior to editing will temporarily be reinstated for comparison purposes. Press the [EDIT] button again to return to the original status.

- In the Voice Store mode:

Press the [EDIT] button so that its lamp flashes. In this status, you can hear the sound of the Voice at the storing destination. Press the [EDIT] button again to return to the original status.

Enhancing the sound with Effects

This instrument features a wide variety of Effects, letting you add reverb and chorus processing to the selected Voice for your keyboard performance. Simply changing the Effect type applied to the preset Voice lets you instantly come up with different sounds. The instructions below explain how to set the Effect type and the related parameters applied to the Preset Voice then store the settings as a User Voice.

1 In the Voice Play display, select a Voice then press the [F6] EFFECT button.

The EFFECT display of Voice Common Edit appears.

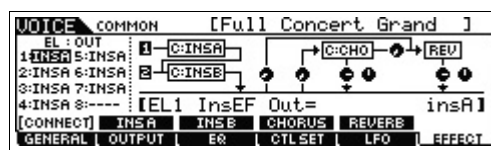

2 Select the Effect Category and Type of Insertion Effect A.

Move the cursor to the corresponding position as shown below then use the [INC]/[DEC] buttons or [DATA] dial.

Insertion Effect A Category Insertion Effect A Type

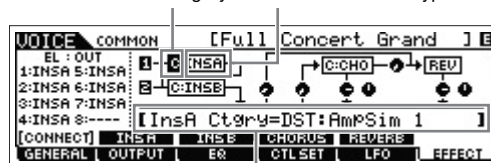

The current parameter and its value

- 3 Select the Effect Category and Type of Insertion Effect B with the same instruction as step 2.
- 4 Select the Effect connection of Insertion A and B. Move the cursor to the position shown below then use the [INC]/[DEC] buttons or [DATA] dial.

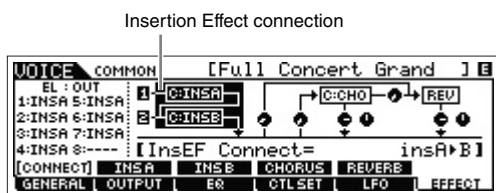

- 5 Set the output destination of each Element/Key. Move the cursor to "EL:OUT" (for the Normal Voice) or "KEY:OUT" (For the Drum Voice) then use the [INC]/[DEC] buttons or [DATA] dial.

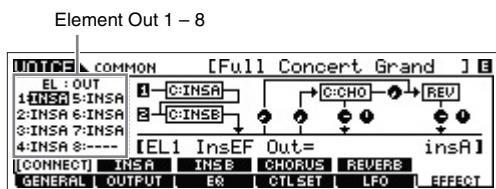

- 6 If necessary, edit the Effect parameters on the display called up via the [SF2] INS A/[SF3] INS B buttons. Try narrowing in on your desired sound by finely editing the parameters provided for each Effect Type.

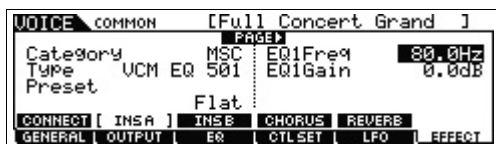

- 7 After setting the parameters, press the [STORE] button to store your settings as a User Voice.

Changing the Arpeggio Type assignment

Try changing the Arpeggio Types assigned to the [SF1] – [SF6] buttons of the Preset Voice.

- 1 Press the ARP [EDIT] button. The Arpeggio Edit display appears.

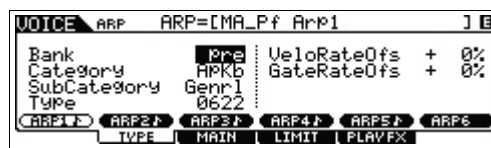

- 2 Press the desired Arpeggio button, [SF1] ARP1 – [SF6] ARP6.
- 3 Press the [F2] TYPE button to call up the TYPE display.
- 4 Select the desired Arpeggio Type you want to assign. Edit the "Bank," "Category," "SubCategory," and "Type" by using the [DATA] dial.
- 5 Edit the other parameters if necessary.
- 6 Turn on the ARP [ON/OFF] button then play the keyboard.

HINT

Copying the Arpeggio Type to another button

To copy the ARP 1 button's Arpeggio Type to one of the ARP 2 – 6 buttons, hold the [STORE] button and press the desired button, [SF2] – [SF6], in the Arpeggio Edit display.

HINT

Using Controllers

Multiple controllers are assigned to each preset Voice, allowing you to apply various changes and effects to the Voice in real time. For convenience, abbreviations of the important or characteristic controllers for that Voice are shown following the Voice name in the display. However, some Voices may have indications for controllers that are not actually available on the instrument itself. These can be used, though, by transmitting the corresponding MIDI control number from an internal sequencer, an external sequencer, or an external MIDI controller.

Controller Indication	Controller Name	MIDI Control Number (default setting)
AS1	ASSIGN 1 knob	16
AS2	ASSIGN 2 knob	17
AF1	ASSIGNABLE FUNCTION [1] button	86
AF2	ASSIGNABLE FUNCTION [2] button	87
FC2	not included on panel	4
MW	Modulation Wheel	1
RB	not included on panel	22

Creating a new Performance by using your favorite Voice (Performance Creator)

A program in which multiple Voices (parts) are combined in a layer, or in other configurations is referred to as a "Performance." Each Performance can contain up to four different parts (Voices).

This instrument features a convenient Performance Creator function which lets you create a new Performance by using favorite Voices you've found in the Voice mode. This function lets you copy parameter settings associated with the Voice (such as Effects) to the Performance—allowing you to quickly and easily come up with precisely the sound you want.

Performance Creator provides three convenient features: Layer, Split, and Drum Assign.

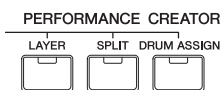

Layer—Playing different Voices together

This section explains how to create a Performance in which different Voices are layered together across the keyboard. By creating such a Performance, you can play a rich, thick sound of a layered piano and strings, for example.

1 Select a Voice in the Voice mode.



2 Press the [LAYER] button on the panel.

The Category Search display appears.

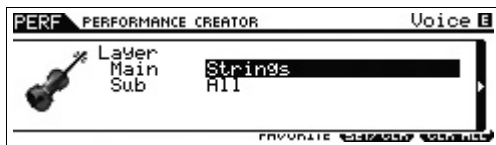

3 Select the Category including the Voice you want to layer then press the Cursor [>] button.

The Voice list is shown.

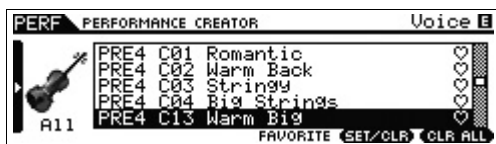

4 Select the desired Voice from the list, then press the [ENTER] button.

The Performance Play display will appear.



The Voice selected in the Voice mode will be assigned to Part 1, and the Voice selected after pressing the [LAYER] button will be assigned to Part 2. These two Voices are sounded simultaneously in a layer as a "Performance."

You can confirm what Voices are layered on the display called up via the [F2] VOICE button.

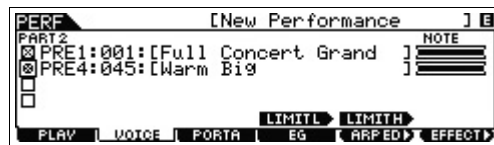

5 Press the [STORE] button to store the settings as a Performance.



NOTE When you press the [EDIT] button in the Store display, you can check the sound of the Performance at the storing destination.

Split—Playing two different Voices with your left and right hands

This section shows you how to create a Performance in which the keyboard is divided (or split) into two sections—the left-hand section and the right-hand. The lowest note of the right-hand section is referred to as the "Split Point." By creating such a Performance, you can play a bass part with your left hand, and a piano part with your right hand, for example.

1 Select a Voice in the Voice mode.



2 Press the [SPLIT] button on the panel.

The Category Search display appears.

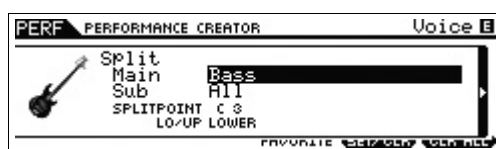

3 Move the cursor to “SPLITPOINT” then set the Split Point.

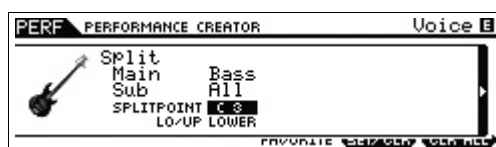

You can determine the Split Point by holding the [SHIFT] button then pressing the desired note on the keyboard.

NOTE The note set to the Split Point is included in the upper section of the keyboard.

4 Move the cursor to “LO/UP” then select whether the desired Voice is assigned to the lower section or the upper section of the keyboard.



NOTE When the original Voice is a Drum Voice, Split is not applied to the part assigned the Drum Voice. In this case, only the desired Voice is assigned to the keyboard range according to the “SPLITPOINT” and “LO/UP” settings.

5 Move the cursor to “Main”/“Sub” then select the Category that includes your desired Voice.



6 Press the Cursor [>] button.

The Voice list is shown.



7 Select the desired Voice from the list, then press the [ENTER] button.

The Performance Play display will appear.



The Voice selected in the Voice mode will be assigned to Part 1, and the Voice selected after pressing the [SPLIT] button will be assigned to Part 2. These two Voices are sounded in different areas of the divided keyboard as a “Performance.”

You can confirm what Voices are assigned on the display called up via the [F2] VOICE button.



8 Press the [STORE] button to store the settings as a Performance.

Drum Assign—Layering a drum Part with the current Voice

This section explains how to create a Performance in which you can trigger a drum pattern (via the Arpeggio function) in addition to the current Voice.

1 Select a Voice in the Voice mode.



2 Press the [DRUM ASSIGN] button on the panel.

The Category Search display appears. Drum/Percussion is automatically assigned as the Category. The Drum Voice is assigned to Part 4 then the Arpeggio is automatically turned on. Play the keyboard to trigger the Arpeggio.



3 Press the Cursor [>] button.

The Voice list is shown.



- 4 Select the desired Drum Voice from the list, then press the [ENTER] button.

The Performance Play display will appear.



NOTE To stop Arpeggio playback, press the ARP [ON/OFF] button so that its lamp is turned off. To start or enable Arpeggio playback again, press the ARP [ON/OFF] button so that its lamp lights.

Changing the drum pattern (Arpeggio Type)

Executing the Drum Assign function will assign a Drum Voice to Part 4 and set the Arpeggio of Part 4 to on. If you want to change the drum pattern, select a different Arpeggio Type in the Arpeggio Edit of the Performance mode.

- 5 Press the ARP [EDIT] button in the Performance Play display.

The Arpeggio Edit display appears.

- 6 Press the [F2] TYPE button then the Number [4] button.

The TYPE display for Part 4 appears.

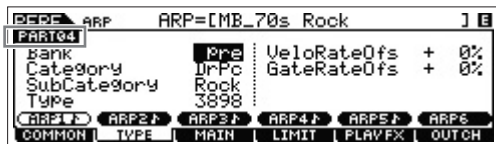

- 7 Select the Arpeggio Type with "Bank," "Category," "Sub Category" and "Type."

- 8 Press the [PERFORM] button to return to the Performance Play display.

- 9 Press the [STORE] button to store the edited Performance.

Playing the keyboard in the Performance Mode

A program in which multiple Voices (parts) are combined in a layer, or in other configurations is referred to as a "Performance." This instrument contains 128 Performances in each of the User Banks 1 – 2 and you can play them by pressing the [PERFORM] button.

Selecting a Performance

Selecting a Performance is done in basically the same way as selecting a Voice (see page 24). As in the Voice Play mode, you can use the Category Search (page 25) and Favorite Category (page 25) functions in the Performance Play mode.

Switching a Part on/off

The Performance Play mode lets you turn the four Parts of the current Performance on or off as desired.

Turning specific Parts on/off (Mute function)

You can turn individual Parts on/off by using the Mute function.

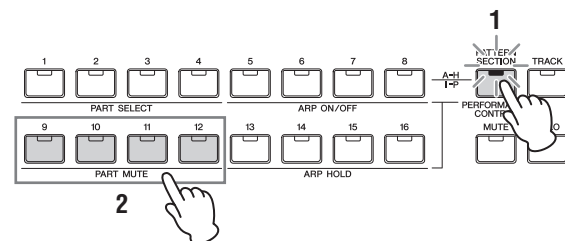

- 1 Press the [PERFORMANCE CONTROL] button.

The button lamp lights, indicating that each Part can be turned on/off.

- 2 Press any of the Number [9] – [12] buttons.

The lamp of the pressed button will be turned off and the corresponding Part will be muted. Press the same button again to turn the lamp on and disengage the mute function for that Part. You can turn multiple Parts on/off by pressing their buttons.

NOTE Parts can be muted also by pressing the [MUTE] button then the Number [1] – [4] buttons.

Soloing a specific Part

The Solo function is the opposite of Mute, and lets you instantly solo a specific Part and mute all others.

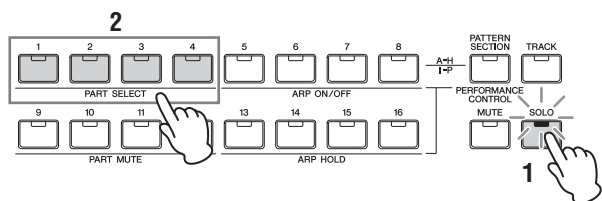

1 Press the [SOLO] button.

The SOLO lamp lights, indicating that Solo is enabled.

2 Press any of the Number [1] – [4] buttons.

The lamp of the pressed button will flash and only the corresponding Part will be sounded. Press any other Number button to change the solo Part.

NOTE You can exit from this status by pressing the [TRACK] button or [PERFORMANCE CONTROL] button.

Using the Arpeggio function

The Arpeggio function lets you trigger rhythm patterns, riffs and phrases using the current Voice by simply playing notes on the keyboard. In the Performance mode, each of four Arpeggio types is assigned to each of four Parts. This means four Arpeggio types can be played back simultaneously. Try selecting different Performances and check out the various Arpeggio types.

NOTE For details about Arpeggio, see the "Reference Manual" PDF document.

Since the preset Performances already have their own Arpeggio types pre-assigned, you can play the Arpeggio by selecting the desired Performance, turning on the ARP [ON/OFF] button, then pressing any note. Instructions on using Arpeggio are basically the same as in the Voice mode.

Turning Arpeggio playback on/off for each Part

You can turn Arpeggio playback on or off for each Part of the Performance as described below.

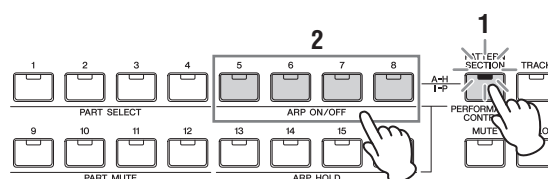

1 Press the [PERFORMANCE CONTROL] button.

The [PERFORMANCE CONTROL] lamp lights, indicating that Arpeggio playback for each Part can be turned on/off.

2 Pressing each of the Number [5] – [8] buttons toggles Arpeggio playback on and off for each Part.

If any of the [5] – [8] lamps is turned off, the Arpeggio playback of the corresponding Part is muted.

Turning the Arpeggio Hold parameter on/off for each Part

You can turn the Arpeggio Hold parameter on /off or on/sync-off for each Part of the Performance as described below. When the Arpeggio Hold parameter is set to "on," Arpeggio playback continues even if the note is released.

NOTE The Arpeggio Hold parameter is in the [F3] MAIN display of the Arpeggio Edit display. For details on this parameter, see the Reference Manual.

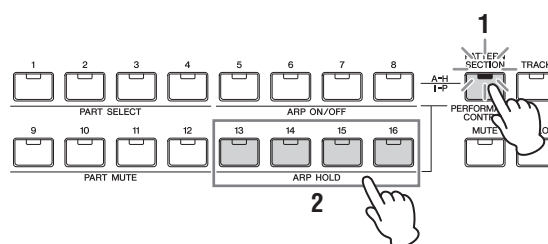

1 Press the [PERFORMANCE CONTROL] button.

The [PERFORMANCE CONTROL] lamp lights, indicating that Arpeggio Hold for each Part can be turned on/off or on/sync-off.

2 Pressing each of the Number [13] – [16] buttons toggles the Arpeggio Hold parameter on and off for each Part.

If any of the [13] – [16] lamps is turned on, the Arpeggio Hold parameter of the corresponding Part is turned on.

Changing the timbre of the Voice

Just as in the Voice mode, the sound of the Performance (consisting of a maximum of four Parts or Voices) can be edited via the Knobs in the Performance mode. There are two ways to edit the Performance: editing the entire Performance, and editing only one specific Part (Voice) assigned to the Performance.

● To edit the entire Performance:

Turn the Knob in the Performance Play mode (called up via only the [PERFORM] button) or Performance Common Edit mode (called up via [PERFORM] → [EDIT] → [COMMON]).

● To edit a specific Voice of the current Performance:

Turn the Knob in the Performance Part Edit mode (called up via [PERFORM] → [EDIT] → [1] – [4]).

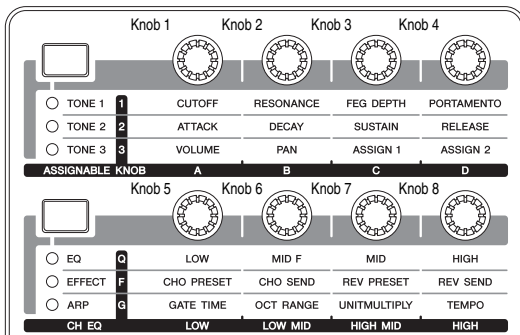

Recording in the Performance mode

While experimenting and playing around with Arpeggios in the Performance mode, you may find some rhythm patterns and phrases that you like, and you may want to store them for future recall. The best and easiest way to capture these is to record your keyboard playing to a Song or Pattern.

Song and Pattern

Songs and Patterns are MIDI sequence data consisting of up to 16 Tracks.

● Song

A Song on this instrument is effectively the same as a song on a MIDI sequencer, and playback automatically stops at the end of the recorded data.

● Pattern

In this instrument, the term “Pattern” refers to a relatively short musical or rhythmic phrase — 1 to 256 measures — which is used for looped playback. Therefore, once Pattern playback starts, it continues until you press the [■] (Stop) button.

Recording the melody and Arpeggio playback to the Song

When a Song is selected as the destination of Performance recording, you can record your keyboard playing with the Arpeggio without having to worry about measure limits or running out of recording space. It is a good idea, for example, to record your keyboard playing, freely calling up various Arpeggio types, then editing the Song later as necessary. You may even want to keep the recorder ‘running’ as you improvise, then listen back later and pick out the best parts to create your final Song. Try recording as shown in the instructions below.

1 In the Performance Play mode, select a Performance for recording.

2 Press the ARP [ON/OFF] button so that the lamp lights.

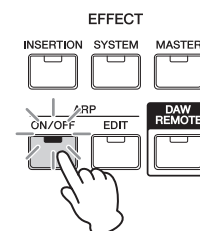

3 Press the [REC] button to call up the Performance Record mode.

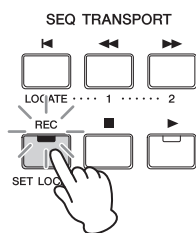

4 Set the following parameters on each of the Performance Record displays.

[F1] SETUP display

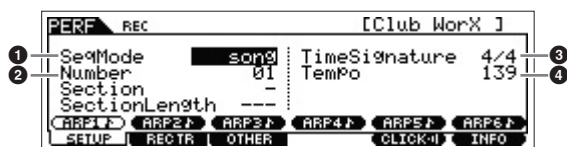

1 "SeqMode" = "song"

This setting lets you record your keyboard performance to the Song.

2 "Number"

Select a destination Song. Executing Performance recording overwrites and erases all the previously recorded data of the specified Song. Make sure to select a Song which contains no data.

3 "TimeSignature" = "4/4"

Set the same value here as that of the Arpeggio type. Normally, set this to "4/4."

4 "Tempo"

Set the desired tempo of the metronome and Arpeggio for recording.

[F2] REC TR display

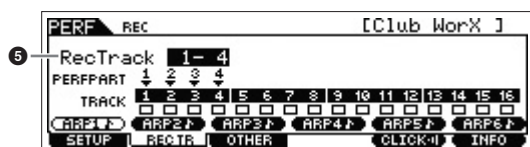

5 "RecTrack"

Select the destination Tracks from "1 - 4," "5 - 8," "9 - 12," and "13 - 16."

[F3] OTHER display

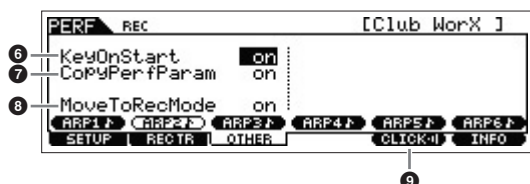

6 "KeyOnStart" = "on"

When set to "on," recording starts immediately when you press any note on the keyboard. Set this parameter to "on" when using the Arpeggio.

7 "CopyPerfParam" = "on"

Set this to "on" when you wish to copy the parameter settings for the Performance Parts 1 - 4 to the destination Parts of the Song.

8 "MoveToRecMode" = "on"

Set this to "on" when you wish to move to the Song mode (specified via the SeqMode) after recording ends.

[F5] CLICK

9 [CLICK] (click on)

Press the [F5] button to turn the metronome on if you wish to use the metronome.

5 Press any note to start recording.

Play the keyboard in time with the metronome. You can change the Arpeggio type and settings by pressing any of the [SF1] - [SF6] buttons while recording.

6 Press the [■] (Stop) button to stop recording.

Recording stops and the instrument enters the Song mode. After recording, the created data will be automatically stored to internal Song/Pattern memory. Press the [▶] button to hear your newly recorded performance.

Record your keyboard performance to additional Tracks in Song Record as desired, and edit the recorded data in the Song Edit or Song Job to finalize the Song data.

NOTE Regarding Arpeggios, not only the played notes but also all note events of Arpeggio playback will be recorded.

7 After completing, press the [STORE] button to store the Song.

Recording Arpeggio playback to a Pattern

If you record your keyboard playing along with Arpeggio playback in the Performance mode to a Pattern, you can quickly create full and complete rhythm patterns lasting just a few measures. These short Patterns of MIDI sequence data can be played back repeatedly in a loop and then conveniently used as 'building blocks' for your original Songs.

The Performance Recording to a Pattern operation is the almost same as that of Recording to a Song, with the exception of the settings below.

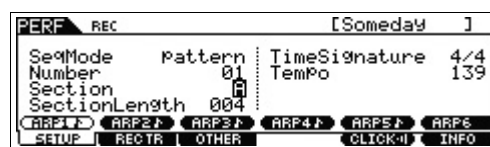

In the Performance Record display, set the "Section" and "SectionLength" as well as the same settings as in "Recording the melody and Arpeggio playback to the Song."

Section

From A - P, select the Section which comprises the Pattern. If you create several Sections, you can use them as rhythm variations within a single Song.

Section Length

Set the length of the selected Section. Set the value to 1 - 4 according to the length of the current Arpeggio types.

After creating the Pattern Sections, program their playback order to create a Pattern Chain. For details, see page 47.

Connecting a microphone or audio equipment

Playing the keyboard along with the sound input from the A/D INPUT [L]/[R] jacks

You can have the A/D input sound—such as your voice through a microphone, a guitar, bass, or CD player—assigned as an Audio Input Part. Various parameters such as volume, pan, and effect can be set to this Part and the sound is output together with the sound of your keyboard performance. In these example instructions, you'll learn how to use the A/D input sound in the Voice mode.

- 1 Make sure to turn off the power of this instrument and set the A/D INPUT [GAIN] knob to the minimum.
- 2 Connect the audio equipment or the microphone to the A/D INPUT [L]/[R] jack on the rear panel.

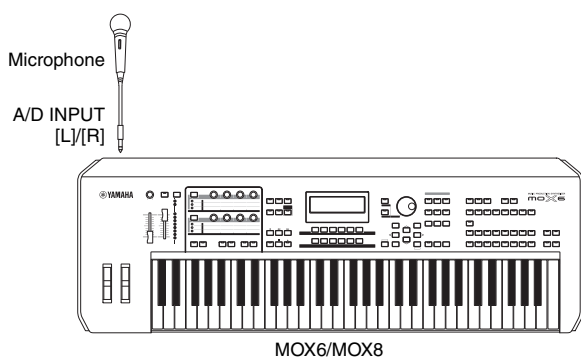
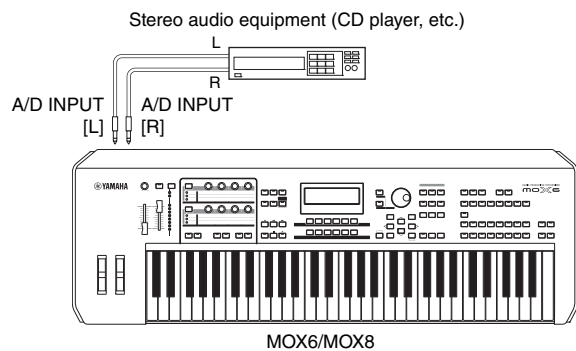

NOTE A standard dynamic microphone is recommended. (This instrument does not support phantom-powered condenser microphones.)

- 3 Turn on the connected audio equipment, then turn on the MOX6/MOX8.
- 4 Press the [VOICE] button to enter the Voice Play mode.

- 5 Press [UTILITY] → [F3] VCE A/D → [SF1] OUTPUT, then set the “Mono/Stereo” parameter.

This parameter determines the signal configuration for the audio signal via the A/D INPUT [L]/[R] jacks, or how the signal or signals are routed (stereo or mono).

When connecting the audio device as shown in step 2, set this parameter to “stereo” or “LRMono.” When connecting the microphone as shown in step 2, set this parameter to “LMono.”

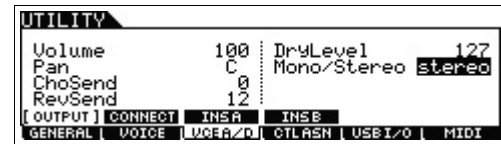

If necessary, set the other parameters.

NOTE For details about the parameters including Mono/Stereo, see the “Reference Manual” PDF document.

NOTE The above parameter settings including Mono/Stereo are applied to the entire Voice mode. If necessary, press the [STORE] button to store these with the Utility settings.

NOTE The above parameter settings including Mono/Stereo differ depending on the selected mode.

NOTE For the Performance mode, set the above parameters on the display called up via [PERFORM] → [EDIT] → [COMMON] → [F5] A/D IN → [SF1] OUTPUT. The settings will be stored for each Performance.

For the Song/Pattern mode, set this parameter on the display called up via [SONG] or [PATTERN] → [MIXING] → [EDIT] → [COMMON] → [F5] A/D IN → [SF1] OUTPUT. The settings will be stored for each Song/Pattern.

- 6 Press [UTILITY] → [F1] GENERAL → [SF6] OTHER, then set the “Mic/Line” parameter according to the equipment connected to the A/D INPUT [L]/[R] jacks.

When connecting equipment of low output level (such as a microphone, guitar, bass), set this parameter to “mic.” When connecting equipment of high output level (such as a synthesizer keyboard, CD player), set this parameter to “line.”

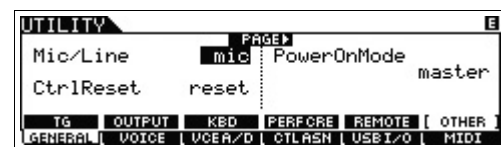

NOTE This setting is available for all modes. If necessary, press the [STORE] button to store this with the Utility settings.

- 7 Press the A/D INPUT [ON/OFF] button so that its lamp lights.

This setting enables audio signals to be input from the connected audio device.

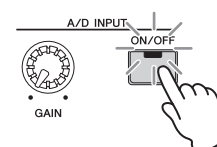

- 8** Press the **[LEVEL]** meter button so that the **[A/D INPUT]** lamp lights, then adjust the input level by using the **[GAIN]** knob.

NOTE Adjust the **[GAIN]** knob to raise the input level as far as possible without allowing distortion to occur.

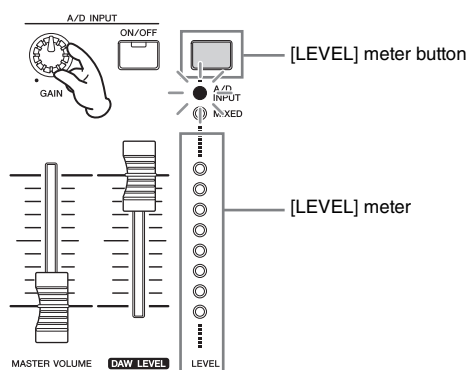

- 9** Press the **[VOICE]** button, then select the desired Voice.

Play the keyboard while you sing into the microphone or play back the audio equipment.

- 10** If necessary, press the **[STORE]** button to store the Voice.

Playing the keyboard along with Vocoder

This instrument features a Vocoder function. This is a distinctive, “robot voice” effect which extracts the characteristic of the microphone sound and adds it to the sound of your keyboard performance. In these example instructions, you’ll learn how to use the Vocoder in the Voice mode.

NOTE For details about the Vocoder, see the “Reference Manual” PDF document.

- 1** Connect the microphone by following steps 1 – 8 on the previous page.

- 2** Press the **[VOICE]** button, then select the desired Voice to which the Vocoder is applied.

This instrument features special Voices specifically designed for use with the Vocoder. Call up the Category Search display then select the desired Voice from the “Vocoder” Main Category.

NOTE If you use the Vocoder effect in the Performance/Song/Pattern mode, assign the Voice for the Vocoder to Part 1. Vocoder cannot be applied to any of the other Parts.

- 3** Press **[EDIT]** → **[COMMON]** → **[F6] EFFECT** → **[SF1] CONNECT**, then set the “InsEF Connect” parameter to “vocoder.”

NOTE The “InsEF Connect” parameter is automatically set to “vocoder” if you select a Voice from the Vocoder Category in step 2.

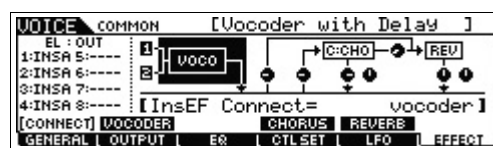

- 4** From the **[SF2] VOCODER** display, set the Vocoder related parameters if necessary.

Speak or sing into the microphone while pressing the note(s) to generate the machine-like Vocoder sound. Set the related parameters as desired while listening to the Vocoder sound. For details about each parameter, see the “Reference Manual” PDF document.

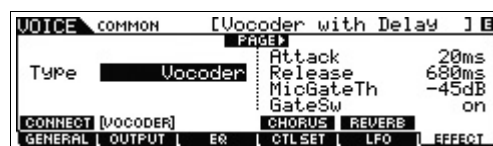

- 5** Press the **[STORE]** button to call up the Store display then store the settings as a User Voice.

Creating an original Song

This instrument features a built-in multi Track sequencer for recording your keyboard performance as MIDI data. This function by itself is enough to create full, complex multi-instrument arrangements and complete Songs.

Terminology

Song and Pattern

See page 34.

Track

This is a memory location on the sequencer where your musical performances (made up of MIDI events) are stored. The MOX6/MOX8 provides 16 Tracks, which correspond to the 16 Parts of the Mixing.

Mixing

This is a program in which multiple Voices are assigned to Parts for multi-timbral play in the Song and Pattern modes. Each Mixing can contain up to 16 parts and a separate Mixing can be created for each Song.

Realtime Recording

With Realtime recording, the instrument functions in the same way as a MD recorder, recording the performance data as it is played. This allows you to capture all the nuances of an actual performance. Realtime Record features three available methods: Replace, Overdub and Punch In/Out. Replace lets you overwrite an already recorded Track with new data. Overdub lets you add more data to a Track that already contains data. Punch In/Out lets you re-record only over a specific area of the Track.

Step Recording

With Step recording, you can compose your performance by “writing” it down one event at a time. This is a non-realtime, step recording method — similar to writing music notation onto paper.

Song playback

You have already learned how to play back Songs on page 18. In this section, you'll learn how to use convenient mute/solo functions during playback.

Track mute

This lets you mute a specific Track or Tracks of the Song.

1 Press the [MUTE] button so that its lamp lights.

The lamps of the Number buttons light, indicating that the corresponding Tracks are on.

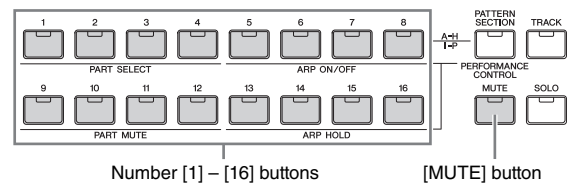

2 To mute a Track, press the corresponding Number [1] - [16] buttons (the lamp turns off).

Multiple Tracks can be muted simultaneously.

3 To sound a muted Track, press the corresponding button (lamp is off) so that its lamp lights.

For future recording purposes, make sure all buttons are lit and Mute is turned off for all Tracks.

Track solo

This lets you solo a specific Track of the Song.

1 Press the [SOLO] button so that its lamp lights.

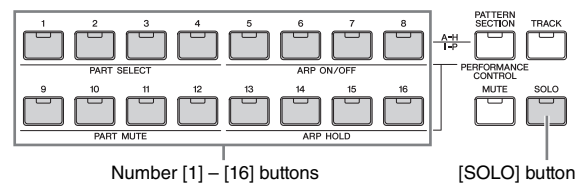

2 To solo a Track, press the corresponding Number [1] - [16] buttons (the lamp flashes).

Press another number button to change the soloed Track.

3 Press the [TRACK] or [MUTE] button to return to the original status.

Creating a Drum part via Step Recording

Now, try creating a Song.

First, record a 4-measure drum phrase as shown below to Track 1 by using Step Recording.



- 1 Press the [SONG] button to call up the Song Play display then select an empty Song.
- 2 On the [F1] PLAY display, set the time signature to "4/4."

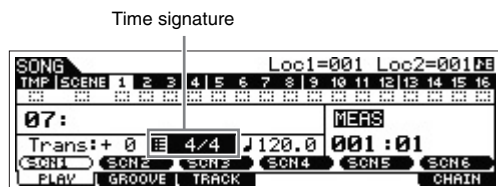

- 3 Press the [REC] button, followed by the [F1] SETUP button, then set the parameters as below.

- Type = step
- Event = note
- Rec Track = 1

If necessary, set the tempo to the desired value.



- 4 Press the [F2] VOICE button, followed by the [CATEGORY SEARCH] button, then select the Drum Voice.

Set the Main Category to "Drum/Percussion" then set the Sub Category to "Drums." Move the Cursor [>] button to call up the Drum Voice List. From this list, select "PDR B09 Analog" then press the [ENTER] button.

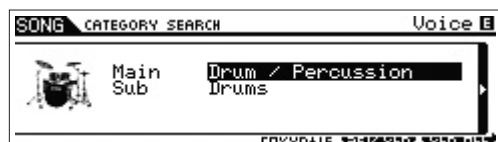

- 5 Press the [▶] (Play) button to enter the Step Record mode.

The [▶] button lamp lights and the Step Record display appears.

- 6 Set the "Step Time" to "480."

The "Step Time" parameter determines to what position the pointer will advance after a note has been entered. Here, the pointer will advance in quarter-note steps.

- 7 Press the [⏪] (Top) button to return to the top of the Song, then press the B0 key four times.

The Bass Drum Kick sound (assigned to the B0 key) is recorded to the timing of each beat.

NOTE If you are using the MOX6, use the [OCTAVE] buttons to make sure that the Bass Drum Kick sounds when you play the B0 key. This is necessary since the MOX6 has a shorter keyboard and doesn't have a B0 key.

- 8 Press the [■] (Stop) button to stop recording.

This returns to the Song Play display.

- 9 To record another percussion sound, press the [REC] button then the [▶] (Play) button to enter the Step Record mode again.

The [▶] button lamp lights and the Step Record display appears.

- 10 Set the "Step Time" to "♪ 240."

The Step Time parameter determines to what position the pointer will advance after a note has been entered. Here, the pointer will advance in eighth-note steps.

- 11 Press the [⏪] (Top) button to return to the top of the Song, then press the [F3] REST button and G#1 key four times.

An eighth-note rest is recorded to each down beat and the Hi-Hat Cymbal sound (assigned to the G#1 key) is recorded to each up beat.

NOTE If you are using the MOX6, use the [OCTAVE] buttons to make sure that the Hi-Hat Cymbal sounds when you play the G#1 key. This is necessary since the MOX6 has a shorter keyboard and doesn't have a G#1 key.

- 12 Press the [■] (Stop) button to stop recording.

This returns to the Song Play display.

After executing the above operations (steps 1 – 12), you should now have a 1-measure drum phrase as shown below.



- 13 Press the [⏪] (Top) button, then press the [▶] (Play) button to hear the recorded data.

To stop playback, press the [■] (Stop) button.

14 Press the [JOB] button, followed by the [F3] EVENT button to call up the EVENT JOB SELECT display.

To create a four-measure drum pattern (which repeats the recorded drum phrase), use the Copy Event Job.

15 Select “02: Copy Event” then press the [ENTER] button.



16 Make the settings as listed below then press the [ENTER] button to execute the Copy Event Job.

- Source Track = “01”, Source range = “001:1:000” – “002:1:000”
- Destination Track = “01”, Top measure of the destination = “002”
- “NumberOfTimes” = “x 03”

Executing this Job will copy the drum phrase (recorded to the first measure) to the 2nd, 3rd, and 4th measures respectively.



17 Press in order the [SONG] button, [◀] (Top) button, and [▶] (Play) button to hear the recorded data.

To stop playback, press the [■] (Stop) button.

HINT

Tips in Step Recording

- In Step recording, you can also enter chords. Because notes are actually entered when the keys are released, make sure to press all correct keys you want to enter then release the keys.
- In Step Recording, press the [▶] (Play) button to start playback from the current position. In this status, pressing the [■] (Stop) button will stop playback and return to the Step Record mode.
- In Step recording, you can create the legato phrases by setting the GateTime to “100%.”
- In Step Recording, you can enter tied notes. For example, first set the Step Time to “480” (quarter note) then press and release the key. Next, change the Step Time to “240” (8th note) then press the [F4] TIE button, resulting in a dotted quarter note.

Creating a bass part via Realtime Recording

Next, record the bass line via Realtime Recording to Track 2.

1 In the Song Play mode, select the same Song (created above) to which the Drum part has already been recorded.

2 Press the [REC] button, followed by the [F1] SETUP button, then set the parameters as below.

- “Type” = “replace”
- “Quantize” = “240”
- “Rec Track” = “2”

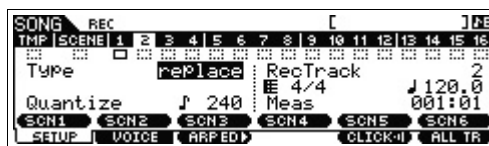

3 Press the [F2] VOICE button, followed by the [CATEGORY SEARCH] button then select the Bass Voice.

Set the “Main” (Main Category) to “Bass” then set the “Sub” (Sub Category) to “Synth Bass.” Move the Cursor [>] button to call up the Voice List. From this list, select “PRE3 E01 Uni Punch” then press the [ENTER] button.

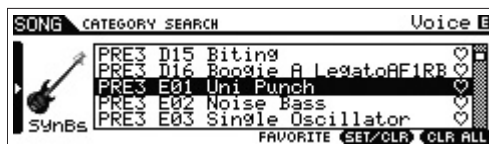
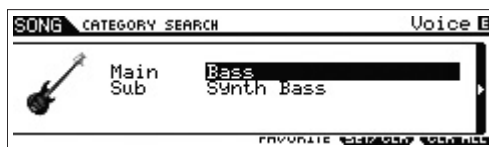

4 Press the [F5] CLICK button to turn the Click (CLICK) on.

5 Press [UTILITY] → [F2] SEQ → [SF1] CLICK, then set the Click related parameters as below.

- “Mode” = “rec”
- “Beat” = “04”
- “RecCount” = “1meas”

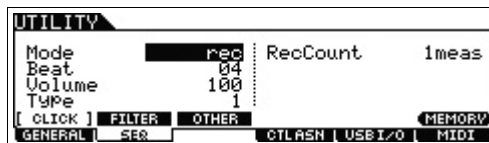

With this setting, there will be a one-measure lead-in count before recording begins and the Click will play back only while recording.

- 6** Press the [REC] button to return to the Song Record display.
- 7** Press the [⏮] (Top) button to return to the top of the Song, then press the [▶] (Play) button to start recording.

As soon as the lead-in count (1-measure) is finished, play the following notation.



- 8** After playing the above notation, press the [■] (Stop) button to stop recording.

If you play any wrong notes, press the [■] (Stop) button, then try recording again. Repeat as often as necessary until you get it right.

- 9** Press the [⏮] (Top) button followed by the [▶] (Play) button to hear the recorded data.

The recorded data of the Tracks 1 and 2 will be played back. To stop playback, press the [■] (Stop) button. If you are not satisfied with the recorded data, try this operation again.

HINT

Re-recording a specific part of a Song (Punch In/Out)

Use the Punch In/Out recording method to record over only a specific portion of the Track. If you set the start point (Punch In) and end point (Punch Out), and then start recording from the top of the Song, the actual recording will be done only between the Punch In and Punch Out points. In the eight-measure example below, only the third through the fifth measures are re-recorded.

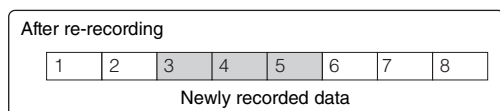
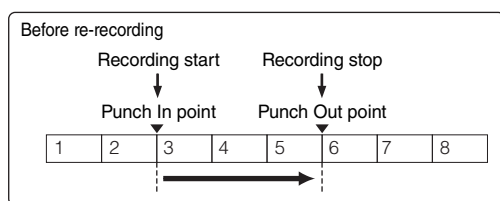

NOTE Punch In/Out Recording can only be used with Realtime recording.

NOTE Note that the Punch In/Out method always replaces (destroys) the original data over the specified area.

To execute Punch In/Punch Out recording in the above condition, set the following parameters beforehand on the [F1] SETUP display in the Song Record mode.

- "Type" = "punch"
- Punch In = 003:01
- Punch Out = 006:01

Punch In point

Playback of the recording Track is turned off from this point, and your keyboard performance will be recorded to the Track.



Punch Out point

Recording ends at this point and normal playback of the recording Track starts.

[SF1] COPYLOC button

Press the [SF1] COPY LOC to assign the measure numbers registered to the Locations (Loc1 and Loc2) to the Punch In and Punch Out points.

NOTE For instructions on using the Location settings, see the "Reference Manual" PDF document.

Creating a synthesizer part by using Arpeggio

Next, record Arpeggio playback via Realtime Recording to Track 3.

- 1** In the Song Play mode, select the same Song to which the Drum and Bass parts have already been recorded.
- 2** Press the ARP [ON/OFF] button so that its lamp lights.
- 3** Press the [REC] button, followed by the [F1] SETUP button, then set the parameters as below.
 - "Type" = "replace"
 - "Quantize" = "off"
 - "Rec Track" = "3"
- 4** Press the [F2] VOICE button, followed by the [CATEGORY SEARCH] button then select the Synthesizer Voice.

Set the Main Category to "Synth Pad" then set the Sub Category to "Analog." Move the Cursor [>] button to call up the Voice List. From this list, select "PRE5 H04 Saw Pad" then press the [ENTER] button.

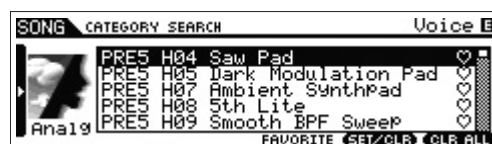
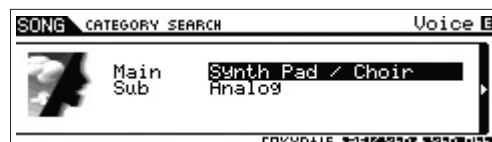

- 5** Press ARP [EDIT] or [F3] ARP ED → [F3] MAIN, then set the Switch parameter to “on” and set the “VoiceWithARP” parameter to “off.”

With the “Switch” parameter “on,” the Arpeggio of Track 3 can be played back.

If the “VoiceWithARP” parameter is set to “on,” selecting the Arpeggio Type will change the Voice from the one selected in step 4. This is why you should set the “VoiceWithARP” parameter to “off” here.

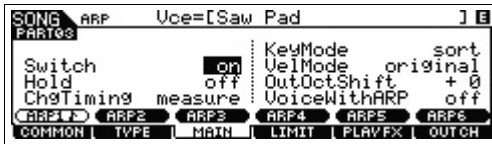

- 6** Press [F2] TYPE → [SF1] ARP1, then assign the Arpeggio Type to the [SF1] ARP1 button.

On this display, set the parameters as below:

- “Bank” = “Pre”
- “Category” = “Seq”
- “SubCategory” = “Genrl”
- “Type” = “6223”



If desired, assign different Arpeggio Types to the [SF2] – [SF6] buttons.

- 7** Press the [REC] button to return to the Song Record display.
- 8** Press the [⏪] (Top) button to move to the top of the Song then press the [▶] (Play) button to start recording.

The [▶] (Play) button lamp lights and “RECORDING” appears at the top of the display, indicating that the Recording has already started. After the one-measure lead-in count is finished, play the following notation.



NOTE All the notes generated via Arpeggio playback will be recorded.

- 9** After playing the above notation, press the [■] (Stop) button to stop recording.
- If you play any wrong notes, press the [■] (Stop) button, then try recording again. Repeat as often as necessary until you get it right.

- 10** Press the [⏪] (Top) button, followed by the [▶] (Play) button to hear the recorded data.

The recorded data of Tracks 1, 2 and 3 will be played back. To stop playback, press the [■] (Stop) button. If you are not satisfied with the recorded data, try this operation again.

Correcting wrong notes

If you’ve played any wrong notes while recording and wish to correct them, press the [EDIT] button from the Song Play mode to go to the Song Edit mode. Song Edit lets you clean up and edit data of already recorded Songs or insert new data to the Songs. Check for any mistakenly recorded or wrong events on the event list display of the Song Edit mode, then correct them as needed.

- 1** With the recorded Song selected, press the [EDIT] button to enter Song Edit, then press the [F1] CHANGE button.

The CHANGE display appears.

- 2** Press the desired Track number button (from [1] – [3]).

The list of the MIDI events recorded to the selected Track in the previous section appears on the display.

Location	Notes	Gate time	Velocity
SONG EDIT	TR 03	MERS	046
001:1-000	mB-3	003:198	055
001:1-000	mG-3	003:164	064
001:1-000	mC-3	003:142	061
002:1-000	mB-2	003:154	055

NOTE The Song location at which you edit or input the event is indicated by measure, beat and clock. A quarter note (one beat when the time signature is set to “4/4”) consists of 480 divisions. The length of each note (gate time) is indicated by Beat and Clock. For example, 001:000 is equivalent to a quarter note and 000:240 is equivalent to an eighth note.

- 3** Use the Cursor buttons to move the cursor to the location to be edited, then turn the [DATA] dial to edit the value.

When you change the value at the current line, the entire line starts flashing.

- 4** Before moving the cursor to another line, press the [ENTER] button to fix the value.

The edited event line stops flashing.

- 5** As necessary, correct the other data.

If you find unnecessary notes (not described on the notation), move the cursor to the corresponding position then press the [F6] DELETE button.

- 6** After completing editing, press the [EXIT] button to return to the Song Play display.

To confirm the recorded data, press the [⏪] (Top) button, followed by the [▶] (Play) button to start playback. To stop playback, press the [■] button.

Completing the Song by editing the Mixing

In this final step (other than storing your precious work, which we'll cover next), you can mix down your Tracks with the Song Mixing function – adjusting the volume balance and pan setting of all the parts and tweaking the effect levels.

NOTE The explanations here also apply to the Pattern mode.

1 Press the [SONG] button to enter the Song Play mode, then select the desired Song.

2 Press the [MIXING] button to enter the Mixing mode, then set various parameters.

The [MIXING] button lamp lights and the Mixing display will appear. Select the menu you wish to edit by pressing the [F1] – [F4] buttons, then edit the parameters in each display.

Mixing Play display

Indicates that the Mixing parameter is modified but not stored yet.

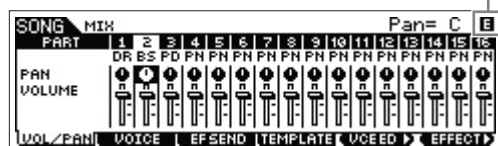

For details about each parameter, see the “Reference Manual” PDF document.

3 Press the [EDIT] button to enter the Mixing Edit mode.

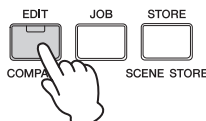

4 Call up the Common Edit display or Part Edit display.

Use Part Edit to edit the parameters for each Part. Use Common Edit to edit the parameters for all of the Parts.

5 Select the menu you wish to edit by pressing the [F1] – [F6] buttons and [SF1] – [SF6] buttons, then edit the parameters in each display.

For details on each parameter, see the “Reference Manual” PDF document.

6 Repeat steps 4 – 5 as desired.

7 Press [STORE] → [F1] SEQ → [ENTER] to store the settings as Song data.

This operation will store all the Songs and Patterns at the same time.

NOTICE

If you are editing Mixing parameters and you select a different Song without storing the one being edited, all the edits you've made will be erased.

HINT

Storing Mixing settings as a template

The Mixing settings you make can be stored as a Template—letting you create your own custom Mixing/Voice configurations for future use in recording Songs. This operation can be done on the display called up via [SONG] → [STORE] → [F2] TEMPLATE. For detailed instructions, see the “Reference Manual” PDF document.

Storing the created Song

After creating a Song, assign a name to the Song then execute the Store operation.

1 Press [SONG] → [JOB] → [F6] SONG to call up the Song Job List.



2 Select “04: Song Name,” press the [ENTER] button to call up the Song Name display, then enter the Song name.

Move the Cursor to the desired position then enter the character by holding the [SF6] CHAR button. Repeat this operation as often as necessary to create the name.

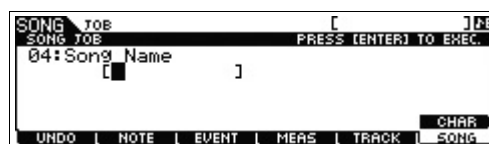

NOTE For specific instructions on naming, see Basic Operation on page 21.

3 After naming, press the [ENTER] button to actually enter the name.



4 Press the [STORE] button, followed by the [F1] SEQ button.

The Store display appears.



5 Press the [ENTER] button to store the Song.

This operation will store all the Songs and Patterns at the same time.

After storing, press the [EXIT] button to exit from the Store display.

NOTE Song/Pattern data consists of MIDI sequence data and Mixing data. MIDI sequence data is recorded by playing the keyboard while Mixing data is created by editing the parameters.

Creating an original Pattern

The Pattern mode also lets you record your rhythm patterns or riffs to the different Sections as you wish—and as the inspiration hits—then combine the Sections into a Pattern Chain to create a complete Song. Along with the Arpeggio feature and Performance recording, you have a wide range of easy-to-use tools to quickly create fully arranged, professional sounding Songs.

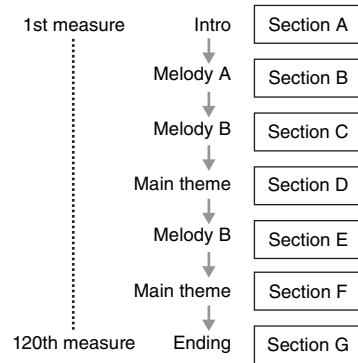

Listening to the Demo Patterns

Before creating your own original pattern, you should give a listen to some of the preset Demo Patterns. These specially recorded Patterns cover a wide range of musical genres and are full of great hints and ideas on how you can create and use Patterns in your own music.

1 Press the [PATTERN] button to enter the Pattern mode.

The Pattern Play display will appear.

2 Select a Pattern by turning the [DATA] dial.

3 Press the [▶] (Play) button to start playback of the Pattern.

The Pattern will play back repeatedly until you press the [■] (Stop) button.

4 Press the [PATTERN SECTION] button then change Sections, selecting from A – P.

Pressing the [1] – [8] buttons calls up Sections A – H and pressing the [9] – [16] buttons calls up Sections I – P.

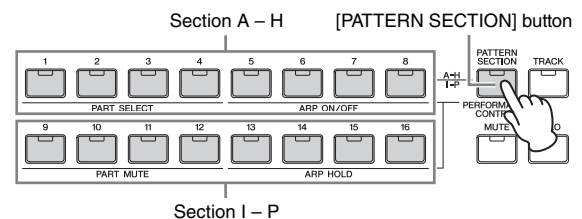

NOTE By changing the Sections, you can create rhythmic variations, and easily improvise arrangements (such as intro, verse, chorus, verse, chorus, ending) in real time.

Creating a Pattern (Section A) by using Arpeggio

In addition to creating a Pattern by recording your keyboard performance conventionally, you can also use the powerful Arpeggio playback features of this instrument.

Here, create data for Section A by recording Arpeggio playback to Track 1 as the drum part, Track 2 as the guitar part and Track 3 as the bass part.

- 1 Press the [PATTERN] button to enter Pattern Play then select a Pattern.
- 2 Press the [PATTERN SECTION] so that its lamp lights then press the Number [1] button to select Section A.
- 3 On the Pattern Play display, set the Pattern Length, Time Signature and Tempo.

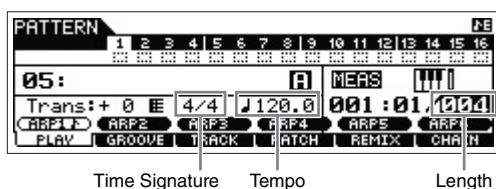

- 4 Press the [TRACK] so that its lamp lights then press the Number [1] button to select Track 1.
- 5 Press ARP [EDIT] → [F3] MAIN, then set the “Switch” parameter to “on” and set the “VoiceWithARP” parameter to “on.”

With the “Switch” parameter “on,” the Arpeggio of Track 1 can be played back. When the Arpeggio Type is selected with the “VoiceWithARP” parameter “on,” the Voice appropriate for the selected Arpeggio Type will be automatically called up.

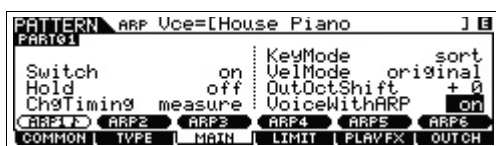

- 6 Press the ARP [ON/OFF] button so that its lamp lights.

- 7 Press the [F2] TYPE button then select the desired Arpeggio Type assigned to the [SF1] – [SF6] buttons.

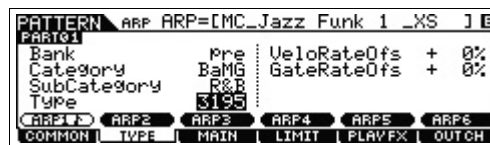

Changing the Arpeggio Type will call up a different Voice since the “VoiceWithARP” parameter is set to “on.” If you want to record a drum pattern, for example, set the Category to a drum/percussion-like name then find the desired Arpeggio Type.

- 8 Press the [REC] button then set the parameters for recording on the [F1] SETUP display as below.
 - “Type” = “replace”
 - “Loop” = “off”
 - “Quantize” = “off”

Set the other parameters if necessary.

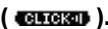

- 9 Press the [F5] CLICK button to set the click to on ().
- 10 Press the [▶] (Play) button to start recording.

Play the keyboard to trigger Arpeggio playback. Since the “Loop” parameter is set to “off,” recording will be finished automatically when the end of the Pattern Length is reached.

NOTE All the notes generated via Arpeggio playback will be recorded.

Recorded Data as a User Phrase

The MIDI note sequence data (except for the Voice setting, etc.) recorded in the Pattern mode will be stored as a User Phrase. The stored User Phrase can be assigned to a different Section/Track from the [F4] PATCH display in the Pattern Play mode. This allows you to use already recorded User Phrases for the other different Sections/Tracks. A single Pattern provides memory space for 256 of your own original User Phrases.

- 11 After recording is completed, press the ARP [EDIT] and [F3] MAIN buttons then set the “Switch” parameter of Track 1 to “off.”

Since all the notes generated via Arpeggio playback are recorded in this example, it is not necessary to trigger the Arpeggio during playback. This is why the “Switch” parameter is set to “off” here.

- 12 Press the [▶] (Play) button to hear the recorded Phrase.

13 Record Phrases to the other Tracks of Section A as desired using the same operation.

Record a bass line to Track 2, then record guitar backing to Track 3 by repeating steps 4 – 13 above.

14 Press [STORE] → [F1] SEQ → [ENTER] to store the recorded Phrases as a Pattern.

This operation will store all the Song/Patterns.

Now that you've recorded Section A, go on to the following instructions and create Section B by using the Pattern Copy Job with the already recorded User Phrases.

Creating another Pattern (Section B) by using already recorded data

Here, you'll learn how to create a Section B by using recorded data copied from Section A. For example, the drum part and bass part will be copied from Section A, and the guitar part will be created via the same note data as that of the bass part.

Copying the Pattern data

First, copy all the recorded data from the Section A to Section B by using the Pattern Copy Job.

1 Press [PATTERN] → [JOB] to enter the Pattern Job.

2 Press the [F6] PATTERN button, select "01: Copy Pattern" then press the [ENTER] button.

The Copy Pattern Job display appears.



3 Select the Pattern number and Section to be copied.

For the copy source, select the Pattern number and Section which you have already recorded in the previous section. For the copy destination, select the same Pattern number and "Section B."

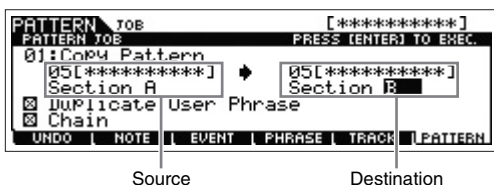

Source

Destination

4 Press the [ENTER] button to execute the Pattern Copy Job.

All the data of Section A will be copied to Section B.

5 Press the [EXIT] button a few times to return to Pattern Play.

6 Press the [PATTERN SECTION] button so that its lamp lights then press the Number [2] button.

Section B is now selected. Press the [▶] (Play) button to hear Section B and confirm that the Section B data has been copied from Section A.

Assign the already recorded data (User Phrase)

Have the guitar and bass play together by using the user phrase of the bass recorded in Section A.

7 Press the [F4] PATCH button to call up the PATCH display.

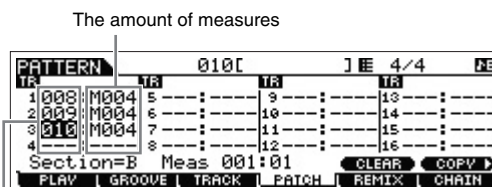

Phrase number

8 To Track 3 (guitar part), assign the same Phrase as that of Track 2 (bass part).

This operation will have the guitar (Track 3) and bass (Track 2) play the same Phrase in unison.

Assign the same Phrase as that of Track 2.

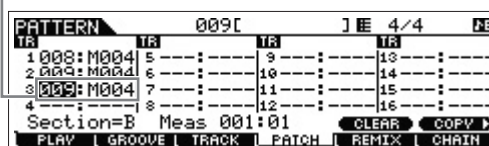

HINT

Pattern Patch display

On the Pattern Patch display, only the User Phrase contained in the current Pattern can be assigned to any Track. If you wish to use Phrases belonging to other Patterns, follow the instructions below:

- 1 Press the [SF6] COPY button.
- 2 Select the desired Phrase as the copy source.
- 3 Select the User Phrase number and Track number as the copy destination.
- 4 Press the [ENTER] button to execute the Copy operation.

9 Press the [▶] (Play) button to hear the recorded Phrase.

If necessary, adjust the octave setting or velocity setting of the guitar part by using the [F2] NOTE Jobs. For details about the available parameters, see the "Reference Manual" PDF document.

NOTICE

If a specific Phrase is assigned to various Sections/Tracks, keep in mind that editing the Phrase will change the playback sound of all Sections/Tracks that use this Phrase.

10 Press [STORE] → [F1] SEQ → [ENTER] to store the recorded Phrases as a Pattern.

This operation will store all the Song/Patterns.

After recording Section B, create other Sections as desired. As in the Song mode, you can also use Step Recording to create Patterns.

Creating a Pattern Chain for converting to a Song

In these instructions you'll learn how to assign each of the created Pattern Phrases to the Section, arrange the Sections in your favorite order to create the Pattern Chain, and convert the Pattern Chain to a Song. This converted Song data can be used as backing accompaniment for melody recording.

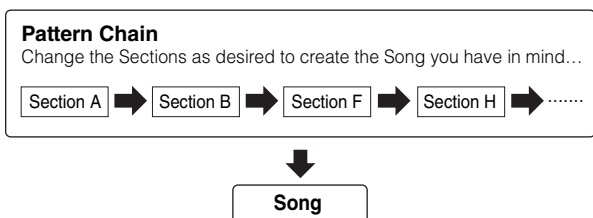

Creating a Pattern Chain

This section explains how to create a Pattern Chain by arranging the Sections in order as shown in the example above.

- 1 In the PLAY display of the Pattern Play mode, select the Pattern created in the previous section.**
- 2 Press the [F6] CHAIN button.**
- 3 Press the [REC] button to enter the Pattern Chain Record mode then set the Recording Track and Pattern tempo.**

Three Pattern Chain Track types are available. The Tempo Track lets you record tempo changes for the Chain, and the Scene Track lets you record Track on/off changes. The Pattern

("patt") Track lets you record Section changes at the desired measure points in the Song. Here, set "RecTrack" to "patt."

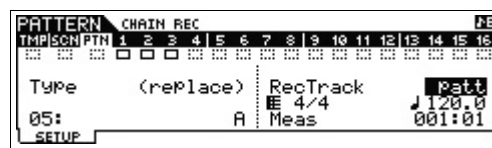

4 Press the [▶] (Play) button to start recording then play the Pattern.

Change the Sections as desired. You can "play" the Section buttons as the Pattern plays back to create a new Song.

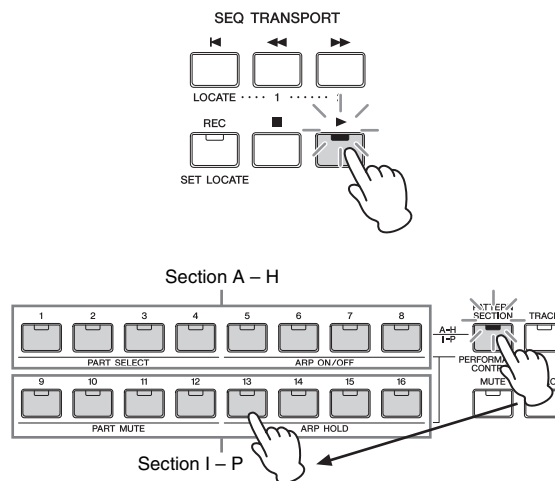

- 5 Press the [■] (Stop) button to stop recording.**
The instrument returns to the CHAIN display of Pattern Play.
- 6 Press the [▶] (Play) button to play the recorded Pattern Chain.**
- 7 Press [STORE] → [F1] SEQ → [ENTER] to store the recorded Pattern Chain.**
This operation will store all the Song/Patterns.
- 8 After pressing the [EXIT] button, record the Tempo Track then Scene Track by repeating steps 3 - 7 above.**

●When you record the Tempo Track:
In step 3, set the RecTrack to "tempo." In step 4, move the cursor to the tempo column (♩) then change the tempo as desired by using the [DATA] dial or [INC]/[DEC] buttons. Tempo change timing will be recorded in real time to the Tempo Track.

●When you record the Scene Track:
In Step 3, set the RecTrack to "scene." In step 4, press the [MUTE] button so that its lamp lights then turn on/off the desired Number buttons. The change timing of the on/off status will be recorded in real time to the Scene Track.

Editing the Pattern Chain

The Pattern Chain Edit mode makes it possible to edit the order of the Sections in a chain as well as inserting tempo, and scene/mute event data.

1 In the Pattern Play mode, select the Pattern created in the previous section.

2 Press [F6] CHAIN → [EDIT] to enter the Pattern Chain mode, then edit each of the Tracks.

To select each Track, press the [F4] TR SEL button.

Pattern Track Edit

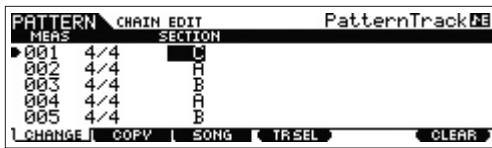

[F4] button

Scene Track Edit



[F4] button

Tempo Track Edit

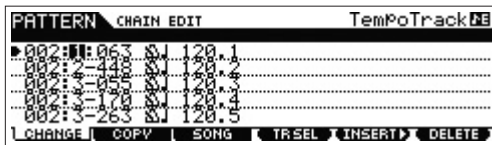

3 Press the [EXIT] button to return to the Pattern Play display then press the [▶] (Play) button to start the Pattern Chain.

4 Press [STORE] → [F1] SEQ → [ENTER] to store the recorded Pattern Chain.

This operation will store all the Song/Patterns.

Converting a Pattern Chain to a Song

1 In Pattern Play, select the Pattern created in the previous section.

2 Press [F6] CHAIN → [EDIT] to enter the Pattern Chain mode.

3 Press the [F3] Song button to call up the “Convert to Song” display, then select an empty Song and the top measure for the destination.

For the destination, select the Song and the top measure.

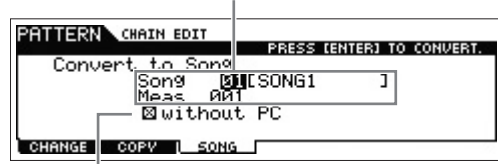

If the “without PC” is checkmarked, executing this operation will ignore the Program Change events in the Pattern data.

4 Press the [ENTER] button to execute the conversion.

The Pattern Chain data will be converted to Song data, and the converted data will be copied to the top measure specified in step 3.

NOTICE

This operation overwrites any data already existing at the destination Song.

5 Press the [SONG] button, select the Song specified in step 3, then press the [▶] (Play) button to hear the newly created Song data.

6 Press [STORE] → [F1] SEQ → [ENTER] to store the created Song.

This operation will store all the Song/Patterns.

Connecting external MIDI instruments

With a standard MIDI cable (available separately), you can connect an external MIDI instrument, and control it from the MOX6/MOX8. Likewise, you can use an external MIDI device (such as a keyboard or sequencer) to control the sounds on the MOX6/MOX8. Below are several different MIDI connection examples; use the one most similar to your intended setup.

NOTE Any one of these interfaces can be used for MIDI data transmission/reception: the MIDI connectors, or the USB [TO HOST] connector. However, they cannot be used at the same time. Select which connector is to be used for MIDI data transfer in the "MIDI IN/OUT" parameter of the [UTILITY] → [F6] MIDI → [SF4] OTHER display. As you work through the explanations in this chapter, set "MIDI IN/OUT" to "MIDI" since MIDI is used as the example connection here.

Controlling MOX6/MOX8 from an external MIDI keyboard or synthesizer

Use an external keyboard or synthesizer to remotely select and play the Voices of the MOX6/MOX8.

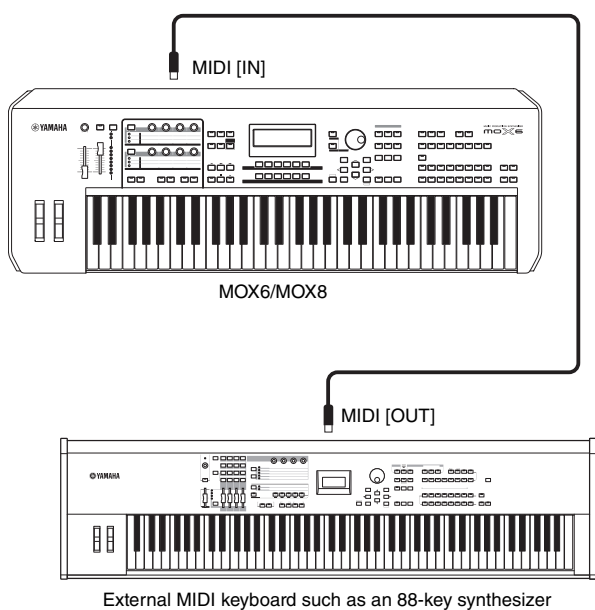

HINT

MIDI Transmit Channel and Receive Channel.

Make sure to match the MIDI Transmit Channel of the external MIDI instrument with the MIDI Receive Channel of the MOX6/MOX8. For details on setting the MIDI Transmit Channel of the external MIDI instrument, refer to the owner's manual of that instrument. For details on setting the MIDI Receive Channel of the MOX6/MOX8, check the following points.

In the Voice mode/Performance mode (using the MOX6/MOX8 as a single timbre tone generator):

Check the MIDI Basic Receive Channel with the following operation: [UTILITY] → [F6] MIDI → [SF1] CH (channel) → "BasicRcvCh." If necessary, change this parameter to the same number as the MIDI Transmit Channel of the external MIDI instrument.

In the Song mode/Pattern mode (using the MOX6/MOX8 as a multi-timbral tone generator):

Check the MIDI Receive Channel for each Part of the Multi with the following operation. [SONG]/[PATTERN] → [MIXING] → [EDIT] → selection parts → [F1] VOICE → [SF2] MODE → "ReceiveCh." If necessary, change this parameter to the same number as the MIDI Transmit Channel of the external MIDI instrument. Please note that all parts whose MIDI Receive Channels are the same as the MIDI Transmit Channel of the external MIDI instrument are sounded by your keyboard performance. Change the settings of the desired parts to match the MIDI Transmit Channel settings on the external MIDI instrument.

Controlling an external MIDI keyboard or synthesizer from the MOX6/MOX8

This connection lets you sound an external MIDI tone generator (synthesizer, tone generator module, etc.) by playing the MOX6/MOX8 or playing back the Song/Pattern of the MOX6/MOX8. Use this connection when you wish to sound the other instrument as well as the MOX6/MOX8.

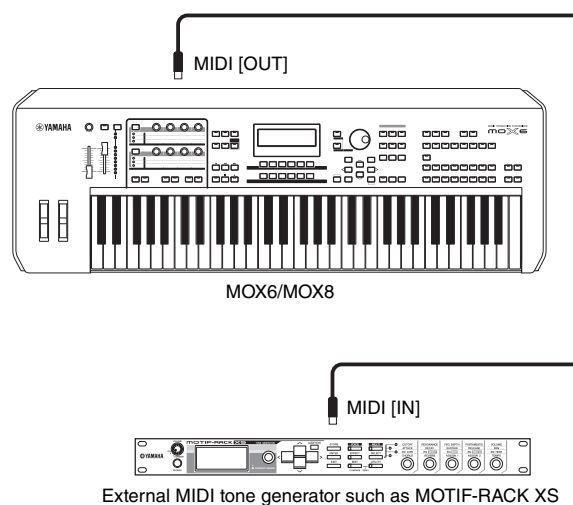

HINT**Splitting the sound between the MOX6/MOX8 and an external tone generator by MIDI channel**

Using the connection example shown above, you can play both instruments and have them separately sound different parts—for example, having your keyboard performance sound the external instrument while the Song/Pattern plays the sounds of the MOX6/MOX8. To use this feature, you must set the MOX6/MOX8's output channel and the external tone generator's receive channel to the same channel number. Check the following points after turning the power on.

When playing the keyboard in the Voice mode or Performance mode:

Check the MIDI transmit channel with the following operation: [UTILITY] → [F6] MIDI → [SF1] CH (channel) → "KBDTransCh." If necessary, change this parameter to the same number as the MIDI Receive Channel of the external MIDI instrument. In the Voice play or Performance play, pressing the [TRACK] button (so that the lamp lights) can also change the MIDI Transmit Channel of the MOX6/MOX8. When you wish to sound only the external tone generator, set the [Master Volume] control to "0" or set Local Control to "off" with the following operation: [UTILITY] → [F6] MIDI → [SF2] SWITCH → "LocalCtrl" = "off." For information on how to set the MIDI Receive Channel of the external MIDI instrument, refer to the owner's manual of the external MIDI instrument.

When playing back a Song/Pattern or playing the keyboard in the Song mode or Pattern mode:

Check the MIDI transmit channel for each Track with the following operation: [SONG]/[PATTERN] → [F3] TRACK → [SF1] CHANNEL → "OUT CH." If necessary, change this parameter to the same number as the MIDI Receive Channel of the external MIDI instrument. Alternately, you can set the output destination (Internal or external MIDI tone generator) for each Track from the following display: [SONG]/[PATTERN] → [F3] TRACK → [SF2] OUT SW. In this case, you'll need to set the external MIDI tone generator to multi-timbral operation and set the MIDI Receive Channel for each part. For details, see the owner's manual of the external MIDI tone generator. Alternately, you can have your keyboard performance split and assigned to different MIDI channels by using the Zone settings in the Master mode (page 55).

Using a Connected Computer

By connecting the MOX6/MOX8 to your computer via USB, you can use DAW software on the computer to create your own original songs.

NOTE The acronym DAW (digital audio workstation) refers to music software for recording, editing and mixing audio and MIDI data. The main DAW applications are Cubase, Logic, SONAR and Digital Performer. Though all of these can be effectively used with the MOX6/MOX8, we recommend using Cubase when creating songs together with the instrument.

By connecting this instrument to a computer, you can take advantage of the following functions and applications.

- External tone generator for DAW software and MIDI keyboard
- Remote Controller of the DAW software
- Editing parameters from the computer (MOX6/MOX8 Editor)

Connecting to a computer

A USB cable and the Yamaha Steinberg USB Driver are necessary to connect the MOX6/MOX8 to the computer. Follow the instructions below. Note that both audio data and MIDI data can be transmitted through a USB cable.

1 Download the latest Yamaha Steinberg USB Driver from our website.

After clicking the Download button, extract the compressed file.

<http://www.global.yamaha.com/download/>

NOTE Information on system requirements is also available at the above web site.

NOTE The Yamaha Steinberg USB Driver may be revised and updated without prior notice. Make sure to check and download the latest version from the above site.

2 Install the Yamaha Steinberg USB Driver to the computer.

For instructions on installing, refer to the online Installation Guide included in the downloaded file package. When connecting this instrument to a computer, connect the USB cable to the USB TO HOST of this instrument and the USB terminal of the computer as shown below.

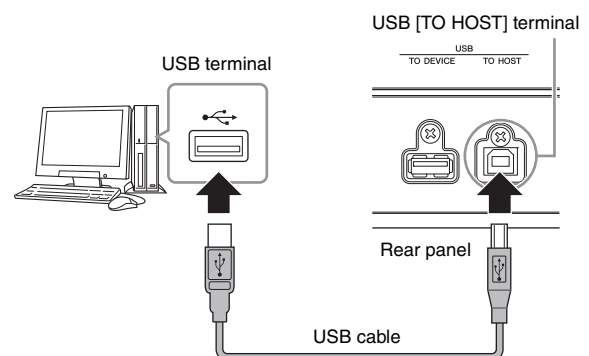

3 Make sure that the USB [TO HOST] terminal of this instrument is enabled.

Press the [UTILITY] button to call up the Utility mode, then press the [F6] MIDI button followed by the [SF4] OTHER button to call up the OTHER display. Set the "MIDI IN/OUT" parameter to "USB."

4 Set the input and output settings for audio data and MIDI data as desired to suit your personal preferences.

These settings can be set in the [F5] USB I/O display and [F6] MIDI display of the Utility mode. Setting the parameters related to the Audio data and MIDI data by using the Quick Setup lets you instantly reconfigure the MOX6/MOX8 for different computer/sequencer related applications by calling up specially programmed presets. In this case, press the [QUICK SETUP] button and then set the "SETUP." After making the settings, press the [ENTER] button to apply them to the MOX6/MOX8.

NOTE For details on the parameters set by the Quick Setup function, see the "Reference Manual" PDF document.

5 Press the [STORE] button to store the settings to internal memory.

Precautions when using the USB [TO HOST] terminal

When connecting the computer to the USB [TO HOST] terminal, make sure to observe the following points. Failing to do so risks freezing the computer and corrupting or losing the data. If the computer or the instrument freezes, restart the application software or the computer OS, or turn the power to the instrument off then on again.

■ NOTICE ■

- Use an AB type USB cable
- Before connecting the computer to the USB [TO HOST] terminal, exit from any power-saving mode of the computer (such as suspend, sleep, standby).
- Before turning on the power to the instrument, connect the computer to the USB [TO HOST] terminal.
- Execute the following before turning the power to the instrument on/off or plugging/unplugging the USB cable to/from the USB [TO HOST] terminal.
 - Quit any open application software on the computer.
 - Make sure that data is not being transmitted from the instrument. (Data is transmitted only by playing notes on the keyboard or playing back a song.)
- While the computer is connected to the instrument, you should wait for six seconds or more between these operations: (1) when turning the power of the instrument off then on again, or (2) when alternately connecting/disconnecting the USB cable.

MIDI channels and MIDI ports

MIDI data is assigned to one of sixteen channels, and this synthesizer is capable of simultaneously playing sixteen separate Parts, via the sixteen MIDI channels. However, the sixteen-channel limit can be overcome by using separate MIDI

"ports," each supporting sixteen channels. While a single MIDI cable is equipped to handle data over up to sixteen channels simultaneously, a USB connection is capable of handling far more—thanks to the use of MIDI ports. Each MIDI port can handle sixteen channels, and the USB connection allows up to eight ports, letting you use up to 128 channels (8 ports x 16 channels) on your computer. When connecting this instrument to a computer using a USB cable, the MIDI ports are defined as follows:

Port 1

The tone generator block in this instrument can recognize and use only this port. When playing the MOX6/MOX8 as a tone generator from the external MIDI instrument or computer, you should set the MIDI Port to 1 on the connected MIDI device or computer.

Port 2

This port is used to control the DAW software on the computer from the MOX6/MOX8 by using the Remote Control feature.

Port 3

This port is used as the MIDI Thru Port. The MIDI data received over Port 3 via the USB [TO HOST] terminal will be re-transmitted to an external MIDI device via the MIDI [OUT] terminal. The MIDI data received over Port 3 via the MIDI [IN] terminal will be re-transmitted to an external device (computer, etc.) via the USB [TO HOST] terminal.

Port 4

This port is used only for data communication of the MOX6/MOX8 Editor. No other software or device can use this port.

Port 5

This port is used only for data communication of the MOX6/MOX8 Remote Editor.

No other software or device can use this port. When using a USB connection, make sure to match the MIDI transmit port and the MIDI receive port as well as the MIDI transmit channel and the MIDI receive channel. Make sure to set the MIDI port of the external device connected to this instrument according to the above information.

Audio channels

The audio signals of the MOX6/MOX8 can be output to the USB [TO HOST] terminal and the OUTPUT [L/MONO]/[R] jacks. When connecting to a computer, use the USB [TO HOST] terminal. In this case, up to four audio channels (USB 1 – USB 4) are available. The output-to-channel assignments are made in the [F5] USB I/O display of the Utility mode.

The audio signals of the MOX6/MOX8 can be input from the USB [TO HOST] terminal and the A/D INPUT [L]/[R] jacks. Up to two channels of audio can be input to the USB [TO HOST] terminal. Set the output level by using the [DAW LEVEL] slider on the MOX6/MOX8. The signals are output to the OUTPUT [L/MONO]/[R] jack. Also, up to two audio channels can be input to the A/D INPUT [L]/[R] jacks. The signal is sent to the A/D input part of the MOX6/MOX8. For more details, see the "Reference Manual" PDF document.

Creating a Song with a computer

By using the MOX6/MOX8 with the DAW software on the computer connected to the MOX6/MOX8, you can take advantage of the following functions and applications.

- MIDI recording and Audio recording of the MOX6/MOX8 performance to the DAW software on the computer.
- Playing back a song of the DAW software by using the MOX6/MOX8 tone generator

This section contains an overview on how to use DAW software on the computer with the MOX6/MOX8 after connecting.

Recording your performance on the MOX6/MOX8 to computer

Setting up the MOX6/MOX8

- 1 If Quick Setup 1 is set to the default settings, simultaneously hold the [QUICK SETUP] button and press the Group [A] button.**

This should be selected when recording your keyboard performance to the DAW software on the computer. If Quick Setup 1 is not set to the default settings, set as follows.

Audio settings

Use this setting when recording the signals from the tone generator and the A/D INPUT [L]/[R] jacks separately to DAW software, and playing the signals from the OUTPUT [L/MONO]/[R] jacks directly.

Mode	Direct Monitor SW	
	A/D In & Part	Part
2StereoRec	on	on

MIDI settings

Use this setting when recording this instrument's performance (not including Arpeggio data) to the DAW software.

Local Control	off
MIDI Sync	auto
Clock Out	off
ARPOUTSw	all off
KBDTxCh	1
TrIntSw	all on
TrExtSw	all on

NOTE For more details regarding these parameters, see the "Reference Manual" PDF document.

- 2 Press the [STORE] button to store the settings to internal memory.**
- 3 Press the desired mode button for playing, and then select the desired program for recording.**

- 4 In the Performance/Song/Pattern mode, set the output channel of the Audio signal for each part.**

When the output setting for the audio signal ("Mode" parameter) is set to "2StereoRec" in Step 1, you can change the audio output channel for each part. In the Performance mode, this parameter can be set in the [F4] USB I/O display of Common Edit. In the Song/Pattern mode, this parameter can be set in the [F4] USB I/O display of Mixing Common Edit.

NOTE In the Voice mode, the audio output channel is fixed to USB 3/4.

Setting up the DAW software on the computer

- 1 Set MIDI Thru to "on" on the DAW software.**

By setting MIDI Thru to "on," the MIDI data generated by playing the keyboard and transmitted to the computer will be returned back to the MOX6/MOX8. As shown in the example below, the MIDI data transmitted from the MOX6/MOX8 then recorded to the computer via MIDI channel 1 will be returned back from the computer to the MOX6/MOX8 via MIDI channel 3 according to the setting of the recording Track. As a result, the tone generator of the MOX6/MOX8 will sound the MIDI data generated by playing the keyboard as MIDI data from channel 3.

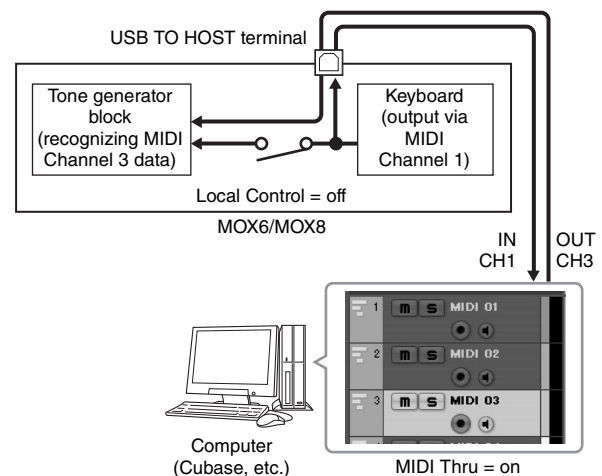

Song playback from a computer using the MOX6/MOX8 as a tone generator

The instructions below show how to use this instrument as a MIDI tone generator. In this case, actual MIDI sequence data is transmitted from DAW software on the computer, allowing you to avoid using software synths and save processing power on your computer.

Setting up the MOX6/MOX8

- 1 Press the [SONG] or [PATTERN] button to enter the Song mode or Pattern mode.**

- 2 **Select the Song or Pattern to be edited.**
- 3 **Press the [MIXING] button to call up the Mixing display.**

4 **Set up the Mixing for parts 1 – 16 as necessary.**

From the Mixing display, you can select Voices and set various parameters such as pan, volume, balance between the Chorus/Reverb and dry sound, Insertion effect on/off and Arpeggio on/off.

Setting up the DAW software on the computer

1 **Set the MIDI output port of the Tracks for playing the MOX6/MOX8 to Port 1 of the “MOX6/MOX8”**

2 **Enter the MIDI data to each Track of the DAW software on the computer.**

The tone generator settings of the part corresponding to the MIDI Track will be set in the Mixing mode on the MOX6/MOX8.

NOTE When using Cubase as the DAW, you can create an original Mixing setup of the MOX6/MOX8 from the MOX6/MOX8 Editor on your computer. The created Mixing setup can be saved as a Cubase Project file for future recall.

Remote-controlling the software from the MOX6/MOX8 (Remote mode)

The MOX6/MOX8 features a highly convenient Remote mode which lets you control the DAW software and software synthesizer on your computer via the panel operations of the MOX6/MOX8. For example, you can start/stop playback of the DAW software on the computer by using the Function buttons and control the song position on the DAW software by using the [DATA] dial, [INC] and [DEC] buttons instead of using the mouse or computer keyboard.

Remote-controlling the software synthesizer

Up to 50 Control Templates of VST Instruments can be stored to internal memory of this instrument. With these, you can use the MOX6/MOX8 to control various software synthesizers. Use the MOX6/MOX8 Remote Editor for editing the Control Template.

NOTE To use the MOX6/MOX8 Remote Editor, you need to install the MOX6/MOX8 Remote Tools. The MOX6/MOX8 Remote Tools consists of two components: MOX6/MOX8 Remote Editor and MOX6/MOX8 Extension, which enables you to use the MOX6/MOX8 along with Cubase series 5.

MOX6/MOX8 Remote Tools can be downloaded from the following Yamaha web site. For details on operating the MOX6/MOX8 Remote Editor, see the PDF manual supplied with the MOX6/MOX8 Remote Editor.
<http://www.yamahasyth.com/download/>

Remote-controlling the DAW software

The DAW applications Cubase, Logic Pro, SONAR and Digital Performer can be controlled via the Remote Control mode of the MOX6/MOX8.

For the most recent information on DAW software that can be controlled from the MOX6/MOX8, see the following URL:
<http://www.yamahasyth.com/>

Before you can use the Remote Control function, you'll need to follow the setup instructions below.

NOTE Before making the setup of DAW Remote, make sure to properly install the Yamaha Steinberg USB Driver and the MOX6/MOX8 Remote Tools.

Setting up the MOX6/MOX8

- 1 **Connect this instrument to the computer via a USB cable (page 50).**
- 2 **Press the [DAW REMOTE] button to enter the Remote mode.**
- 3 **Press the [UTILITY] button to call up the REMOTE display of the Utility mode. Then set the “DAW Select” to the desired DAW software.**

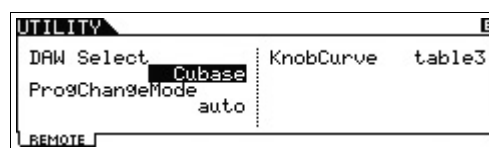

- 4 **Press the [STORE] button to store the settings to internal memory.**
- 5 **Start the DAW software on the connected computer.**

Setting up the DAW software on the computer

This section explains how to set up after starting each application.

NOTE When the cable between the MOX6/MOX8 and the Windows computer is disconnected or the MOX6/MOX8 is turned off accidentally, the DAW will not recognize the MOX6/MOX8 again even if you connect the cable again or turn the MOX6/MOX8 on. If this occurs, exit the DAW software, then restart it after setting up the MOX6/MOX8 and making sure the connection is secure.

■ Cubase

The settings will be completed by installing MOX6/MOX8 Remote Tools.

■ SONAR

- 1 Pull down the [Options] menu and select [MIDI Devices] to call up the "MIDI Devices" window.
- 2 Add "Yamaha MOX6/MOX8-2" to the Input Device, then add "Yamaha MOX6/MOX8-2" to the Output Device.
- 3 Pull down the [Options] menu and select [Control Surfaces] to call up the Control Surface window.
- 4 Click the [+] button, select "Mackie Control," then set the Input Port to "Yamaha MOX6/MOX8-2" and set the Output Port to "Yamaha MOX6/MOX8-2."

■ Digital Performer

- 1 In the Audio/MIDI setup of a Macintosh computer, connect Port 2 of the interface of the MOX6/MOX8 to Port 2 of the tone generator. When there is only one Port for the tone generator, add the new Port, then connect it to the interface.
- 2 Pull down the [Setup] menu and select [ControlSurface Setup] to call up the Control Surface window.
- 3 Click the [+] button.
- 4 Select "Mackie Control" in the Driver section.
- 5 In the box for setting "Unit" and "MIDI," select "Mackie Control" in the "Unit" section and select "MOX6/MOX8 New Port 2" in the "MIDI" section.

■ Logic Pro

- 1 Select the [Preference] menu → [Control Surfaces] → [Settings] to call up the Settings window.
- 2 Select the [New] menu → [Install].
- 3 Select "Mackie Control" in the model list, then add it as a control surface.
- 4 Set the MIDI Output Port to "Yamaha MOX6/MOX8 Port2."
- 5 Set the MIDI Input Port to "Yamaha MOX6/MOX8 Port2."

NOTE Mackie Control is the trademark of Mackie Designs, Inc.

For details about the button operations and functions, see the "Reference Manual" PDF document.

Using the MOX6/MOX8 Editor

About the MOX6/MOX8 Editor

The MOX6/MOX8 Editor lets you edit Voice and Mixing setups from your computer, giving you even greater editing convenience. Furthermore, the data edited on the MOX6/MOX8 is always synchronized with the data on the computer (MOX6/MOX8 Editor) and vice versa. This provides a smooth, seamless interface, making it exceptionally easy to create and edit data.

Using the MOX6/MOX8 Editor

Using the MOX6/MOX8 Editor VST on Cubase

The MOX6/MOX8 Editor VST works as a VST3 plug-in software on Cubase. In this case, you can launch the MOX6/MOX8 Editor via the same operations as that of any other VST Instrument.

Using with the Studio Manager V2 as a host application

In addition, Yamaha provides a stand-alone version of the MOX6/MOX8 Editor which works as a client of the host Studio Manager. Studio Manager V2 is a cross-platform application that enables you to start multiple Editors for controlling Yamaha hardware products remotely, and lets you save multiple Editor settings. To use the MOX6/MOX8 Editor, start Studio Manager V2 then start the MOX6/MOX8 Editor as a plug-in software within Studio Manager V2.

The Studio Manager V2 and MOX6/MOX8 Editor can be downloaded from the following URL:

<http://www.yamahasynt.com/download/>

For instructions on using the Studio Manager and MOX6/MOX8 Editor, refer to the respective PDF manuals included with the software.

HINT

Integration between MOX6/MOX8 and Cubase

When producing music by using the MOX6/MOX8 together with Cubase, the MOX6/MOX8 Extension contained in the MOX6/MOX8 Remote Tools provides useful and convenient functions. For example, the necessary settings for connection will be made automatically. For more details, including the latest information, see the following URL.

<http://www.yamahasynt.com/download/>

NOTE The following Cubase software and versions are compatible with the MOX6/MOX8. Cubase 5/Cubase Studio 5: version 5.5 or later, Cubase Essential 5/Cubase AI 5: version 5.1.1 or later

Using as a Master Keyboard

The Master mode lets you:

- Create and store up to 128 programs, each containing a Voice, a Performance, a Song, or a Pattern, and each of which can be instantly called up for use.
- Assign up to four separate Zones in each Master program for use as a master keyboard.

You can use the Master mode to memorize the settings you use most often including the information on which mode is used, and call up these settings instantly anytime you need them with a single button press. Furthermore, you can memorize the settings for controlling an external MIDI device by the Master, allowing you to change and control the connected external MIDI tone generator in sequence while performing live.

Registering the Edited Voice/Performance/Song/Pattern

The Master mode is ideal for live performance situations since it lets you instantly switch among needed Voices, Songs, Patterns and Performances without having to change modes. One convenient way of using the Master mode is to save your needed programs (Voices, Performances, etc.) to Masters in number order, according to the songs you intend to perform. Follow the instructions below to store programs.

- 1 Press the [MASTER] button to enter the Master mode.**

- 2 Select a Master to be edited.**

The Master Play display appears.

- 3 Press the [F2] MEMORY button.**

The MEMORY display appears.

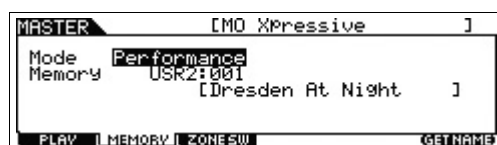

- 4 At the "Mode" parameter and "Memory" parameter, select the desired mode and program.**

- 5 Press the [STORE] button to store the set the Master program in the store display.**

Making settings for use as a master keyboard

It is a good idea to memorize master keyboard functions to the Master when using external multiple MIDI tone generators. Simply by selecting a different Master, you can change the programs in your connected external MIDI tone generators. Here's how to do it:

- 1 Press the [MASTER] button to enter the Master mode.**

- 2 Select a Master to be edited.**

- 3 Press the [F3] ZONE SW button.**

The ZONE SW display appears.

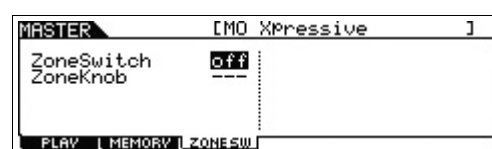

- 4 Set "ZoneSwitch" to "on."**

The "ZoneKnob" parameter also will be set to on automatically.

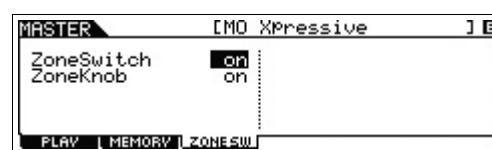

NOTE When the "ZoneKnob" is set to "on," the Zone Edit settings are assigned to Knobs 1 – 8. If you want to assign the settings in the memorized mode to Knobs 1 – 8 yourself, set "ZoneKnob" to "off."

- 5 Press the [EDIT] button, and then press the Number [1] button.**

This calls up the Master Edit displays for Zone 1.

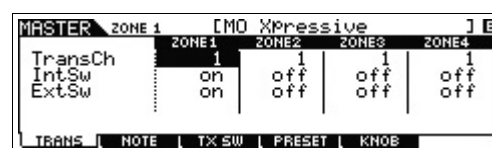

- 6 Set the parameters for Zone 1 in the [F1] – [F5] displays.**

- 7 Use the Number [2] – [4] buttons to set the parameters for other Zones as well as Zone 1.**

- 8 After setting all the desired parameters, press the [STORE] button to store your settings as a Master program.**

After completing these settings, assign a name to the Master in the [F1] Name display of the Master Common Edit. After naming, press the [STORE] button to store the Master. For more information on the parameters which are edited in the Master mode, see the "Reference Manual" PDF document.

Making Global System Settings (Utility Mode)

In the Utility mode, you can set parameters that apply to the entire system of this instrument. To enter the Utility mode, press the [UTILITY] button. Pressing the [EXIT] button returns to the original display.

This section describes some useful functions in the Utility mode.

Setting the default mode when turning the power on

[F1] GENERAL → [SF6] OTHER → Cursor [←] button → “PowerOnMode”

From the Voice, Performance, or Master, the mode specified here is called up when turning the power on.

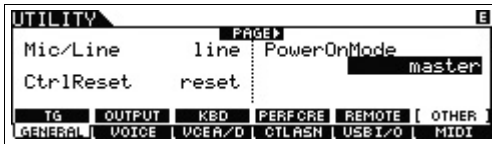

Reversing the LCD status

[F1] GENERAL → [SF6] OTHER → Cursor [←] button → “LCD Mode”

This parameter determines the LCD status.

When “normal” is selected:

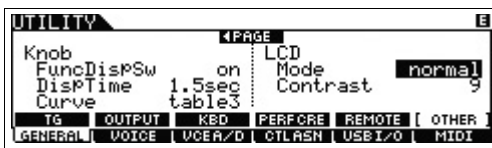

When “reverse” is selected:

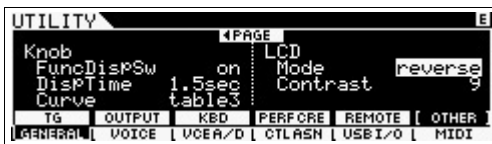

You can use the Master mode to memorize the settings you use most often.

Click (metronome) settings

[F2] SEQ → [SF1] CLICK

Determines the tempo, volume and output destination of the click (metronome).

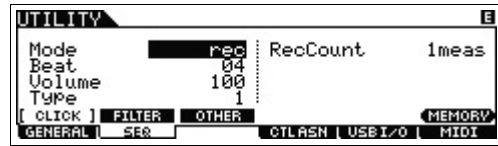

Effect settings applied to the signal input from the A/D INPUT jack

[F3] VCE A/D

Determines the settings for the effects applied to the incoming audio signal from the A/D INPUT [L]/[R] jacks in the Voice mode.

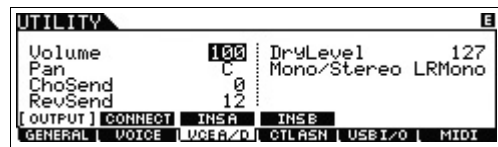

Master Effect/Master EQ settings in the Voice mode

[F2] VOICE → [SF1] MFX, [SF2] MEQ

Determines how much of the Effect and EQ processing is applied to the master output.

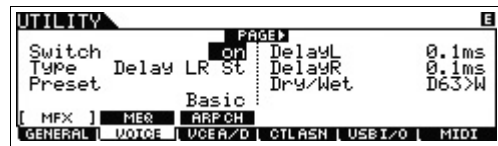

Saving/Loading Data (File Mode)

The File mode provides tools for transferring data (such as Voice, Performance, Song, and Pattern) between the MOX6/MOX8 and external USB flash memory device connected to the USB [TO DEVICE] terminal. To enter the File mode, press the [FILE] button.

This section explains how to save/load all the data on the user memory of this instrument as an "All" file (extension: X4A).

Saving the settings to a USB flash memory device

- 1 Connect a USB flash memory device to the USB [TO DEVICE] terminal of this instrument.
- 2 Press the [FILE] button, and then press the [F2] SAVE button.

The SAVE display appears in the File mode.



- 3 Set "TYPE" to "All," and then select the desired directory of the device. After that, press the [ENTER] button.

If storing the root directory, keep the directory set to "root" without pressing the [ENTER] button. If you want to make a new directory, press the [SF3] NEW button.

Set the desired file type for saving

The current determined directory as the save destination of the USB flash memory device

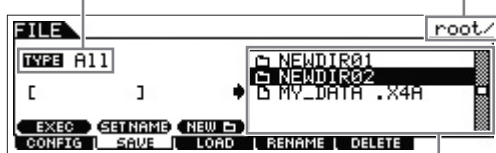

File/Directory Selection box
Select the desired directory of the USB flash memory device, and then press the [ENTER] button.

- 4 Use the Cursor [←]/[→] buttons to move the cursor to the file name field, assign a name to the file, and then press the [ENTER] button.

Move to the desired location in the file name field by using the Cursor [←]/[→] buttons, and then select the desired characters by using the [DATA] dial or the [INC]/[DEC] button to enter the selected character. By pressing the [SF6]

button, you can assign the name in the Character List display. By pressing the [SF2] SET NAME button, the file/directory name which selected in the file/directory selection box is copied to the file name field.

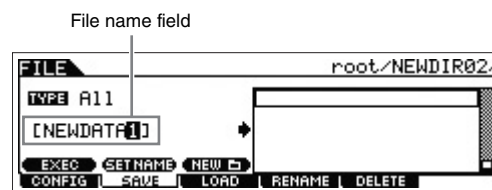

- 5 Press the [SF1] EXEC button to save the file.

Loading the settings from a USB flash memory device

- 1 Connect a USB flash memory device to the USB [TO DEVICE] terminal of this instrument.
- 2 Press the [FILE] button, and then press the [F3] LOAD button.

The LOAD display appears in the File mode.

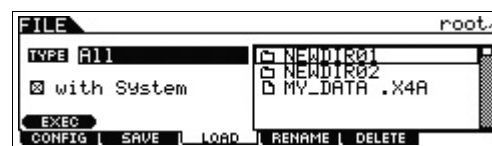

- 3 Set "TYPE" to "All," and then select the file (extension: X4A) of the memory.

Select the directory which has desired file in the file/directory selection box, and then press the [ENTER] button. After that, select the desired file.

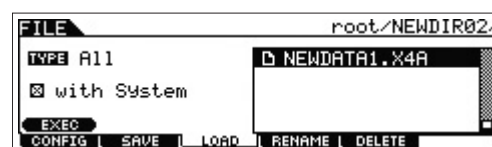
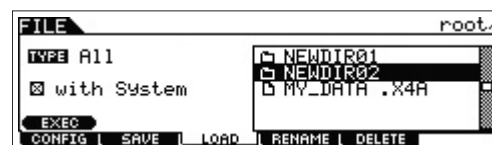

4 Press the [SF1] EXEC button to load the file.

■ NOTICE ■

The Load operation overwrites any data previously existing in the specified destination internal memory. Important data should always be saved to a USB flash memory device connected to the USB [TO DEVICE] terminal.

Precautions when using the USB [TO DEVICE] terminal

This instrument features a built-in USB [TO DEVICE] terminal. When connecting a USB device to the terminal, be sure to handle the USB device with care. Follow the important precautions below.

NOTE For more information about the handling of USB devices, refer to the owner's manual of the USB device.

■ Compatible USB devices

Only USB memory devices of the flash-memory variety can be used with the MOX6/MOX8. Furthermore, the instrument does not necessarily support all commercially available USB flash memory devices, nor can Yamaha guarantee operation such USB devices that you purchase. Before purchasing a USB flash memory device for use with this instrument, please visit the following web page:
<http://download.yamaha.com/>

■ Connecting a USB flash memory device

When connecting a USB flash memory device to the USB [TO DEVICE] terminal, make sure that the connector on the memory is appropriate and that it is connected in the proper direction.

NOTE Though the instrument supports the USB 1.1 standard, you can connect and use a USB 2.0 storage device with the instrument. However, note that the transfer speed is that of USB 1.1.

■ Formatting a USB flash memory device

When a USB flash memory device is connected, a message may appear prompting you to format the memory. If so, execute the Format operation (see the "Reference Manual" PDF document).

■ NOTICE ■

The format operation overwrites any previously existing data. Make sure that the device you are formatting does not contain important data.

■ To protect your data (write-protect)

To prevent important data from being inadvertently erased, apply the write-protect provided on the USB flash memory device. If you are saving data to the device, make sure to disable write-protect.

■ Connecting/removing the USB flash memory device

Before removing the memory from the instrument, make sure that the instrument is not accessing data (such as in the Save, Copy and Delete operations).

■ NOTICE ■

Avoid frequently turning the power on/off to the USB flash memory device, or connecting/disconnecting the memory too often. Doing so may result in the operation of the instrument "freezing" or hanging up. While the instrument is accessing data (such as during Save, Copy, Delete, Load and Format operations) or is mounting the USB flash memory device (shortly after the connection), do NOT unplug the USB connector, do NOT remove the device from the instrument, and do NOT turn the power off to either the instrument or the USB flash memory device. Doing so may corrupt the data on either or both.

Appendix

Shift Function List

Some of the important functions and operations on the instrument can be executed with convenient panel control shortcuts. Simply hold down the [SHIFT] button and press the indicated button (as described below).

Mode	Operation	Function
All modes	[SHIFT] + [INC]/[DEC]	Increases/decreases the value by 10. (Program number in the Play mode; parameter value in the Edit mode)
All modes	[SHIFT] + [DATA] dial	Increases/decreases the value by 10. (Same as [SHIFT] + [INC]/[DEC])
Voice Play	[SHIFT] + BANK SELECT [DEC]/[INC]	Changes the Voice Bank in the order listed below. PRE1 ⇄ USR1 ⇄ PDR ⇄ UDR ⇄ GM ⇄ GMDR (PERF) USR1 ⇄ USR2
All modes other than the File mode	[SHIFT] + Knob 1 – 8	Changes the parameter value quickly in 10-digit jumps (while normally in 1-digit increments).
All modes other than the File mode	[SHIFT] + Knob Function 1 button	Sets the Knob Function to TONE 1.
All modes other than the File mode	[SHIFT] + Knob Function 2 button	Sets the Knob Function to EQ.
All modes	[SHIFT] + [Level] Meter button	Sets the [LEVEL] meter to the A/D INPUT level.
Voice/Performance/ Song Mixing/Pattern Mixing/Master mode	[SHIFT] + the current mode button	Executes the BULK Job of the current mode.
Voice Play/ Performance Play/ Category Search display	[SHIFT] + [FAVORITE]	<p>Favorite indicator</p> <p>Turns on/off the Favorite indicator of the current Voice or Performance.</p> 
Voice/Performance/ Song/Pattern mode	[SHIFT] + ARP [ON/OFF]	<ul style="list-style-type: none"> In the Voice mode, this operation will call up the [F3] MAIN display of Arpeggio Edit. In the Performance/Song/Pattern mode, this operation will call up the [F1] COMMON display of Arpeggio Edit.
Voice/Performance/ Song/Pattern mode	[SHIFT] + A/D INPUT [ON/OFF]	<ul style="list-style-type: none"> In the Voice mode, this operation will call up the [F3] VCE A/D – [SF1] OUTPUT display of the Utility mode. In the Performance mode, this operation will call up the [F5] A/D IN – [SF1] OUTPUT display of Common Edit. In the Song/Pattern mode, this operation will call up the [F5] A/D IN – [SF1] OUTPUT display of Mixing Common Edit.
Voice/Performance/ Song/Pattern mode	[SHIFT] + EFFECT [INSERTION]	Calls up the [F6] EFFECT – [SF1] CONNECT display of Common Edit.
Voice/Performance/ Song/Pattern mode	[SHIFT] + EFFECT [SYSTEM]	Calls up the [F6] EFFECT – [SF1] CONNECT display of Common Edit.
Voice/Performance/ Song/Pattern mode	[SHIFT] + EFFECT [MASTER]	<ul style="list-style-type: none"> In the Voice mode, this operation will call up the [F2] VOICE – [SF1] MFX display of the Utility mode. In the Performance mode, this operation will call up the [F2] OUT MFX – [SF2] MFX display of Common Edit. In the Song/Pattern mode, this operation will call up the [F2] MFX display of Mixing Common Edit.
Voice/Performance/ Song/Pattern mode	[SHIFT] + ASSIGNABLE FUNCTION [1]/[2]	<ul style="list-style-type: none"> In the Voice mode, this operation will call up the [F1] GENERAL – [SF4] OTHER display of Common Edit. In the Performance mode, this operation will call up the [F1] GENERAL – [SF5] OTHER display of Common Edit. In the Song/Pattern mode, this operation will call up the [F1] GENERAL display of Mixing Common Edit.
Voice/Performance/ Song/Pattern mode	[SHIFT] + OCTAVE [-]/[+]	Calls up the [F1] GENERAL – [SF3] KBD display of the Utility mode.
Voice/Performance/ Song/Pattern mode	[SHIFT] + TRANSPOSE [-]/[+]	Calls up the [F1] GENERAL – [SF3] KBD display of the Utility mode.

Display Messages

LCD indication	Description
All remote templates stored.	Appears when you store the Control Template in the Remote mode.
Are you sure?	Confirms whether you want to execute a specified operation or not.
Arpeggio memory full.	The internal memory for Arpeggio data is full, preventing storing the recorded sequence data as an Arpeggio.
Arpeggio type copied.	The Arpeggio Types are copied to the [SF1] – [SF6] buttons.
Bad USB device.	The USB flash memory device connected to this instrument is unusable. Format the USB flash memory device and try again.
Bulk protected.	Bulk data cannot be received because of the setting in the Utility mode.
Can't undo. OK?	When certain Song/Pattern Jobs are executed, internal memory becomes too full for use of the Undo operation.
Completed.	The specified load, save, format, or other Job has been completed.
Device number is off.	Bulk data cannot be transmitted/received since the device number is off.
Device number mismatch.	Bulk data cannot be transmitted/received since the device numbers don't match.
Edited data will be discarded.	Prompts you to confirm whether or not to erase the edited data.
Edits will be stored by loading.	Confirms whether or not you want to continue the Load operation. If you select yes, the current edits will be stored.
Edits will be stored by saving.	Confirms whether or not you want to continue the Save operation. If you select yes, the current edits will be stored.
Empty Favorite! [SHIFT]+[FAVORITE] to add.	Appears when you press the [FAVORITE] button with no program registered to the Favorite Category.
Executing...	A format operation or Job is being executed. Please wait.
File already exists.	A file having the same name as the one you are about to save already exists.
File not found.	The file of the specified type cannot be found.
Folder is too deep.	Directories below this level cannot be accessed.
Illegal file name.	The specified file name is invalid. Try entering a different name.
Illegal file.	The file specified for loading is unusable by this instrument or cannot be loaded in the current mode.
Illegal input.	An invalid input or value has been specified. Check the input method or value.
Illegal measure.	An invalid measure number has been specified in the Song/Pattern mode. Select the measure again.
Illegal phrase number.	An invalid phrase number has been specified in the Pattern mode. Select the phrase again.
Illegal Track number.	An invalid Track number has been specified in the Song/Pattern mode. Select the Track again.
Incompatible USB device	A USB device which cannot be used with this instrument has been connected to the USB [TO DEVICE] terminal.
MIDI buffer full.	Failed to process the MIDI data because too much data was received at one time.
MIDI checksum error.	An error occurred when receiving bulk data.
MIDI data error.	An error occurred when receiving MIDI data.
Mixing Voice full.	The Mixing Voice cannot be stored because the number of Voices already stored has exceeded the maximum capacity.
No data.	When a Song/Pattern Job is executed, the selected Track or range contains no data. Select an appropriate Track or range. In addition, this message appears when a Job related to a Mixing Voice cannot be executed because the specified Mixing Voice is not available.
No F7 (End of Exc.)	Exclusive data has been entered or changed without the necessary "End of Exclusive" byte (F7). Make sure the F7 message is included.
No response from USB device	There is no response from the USB device connected to the USB [TO DEVICE] terminal.
Not empty folder	You have attempted to delete a folder that contains data.
Now loading...	Indicates that a file is being loaded.
Now saving...	Indicates that a file is being saved.
Now working...	Canceling the Load/Save operation, after the [EXIT] button has been pressed.
Overwrite?	A save operation will overwrite data on the USB flash memory device, and this message confirms whether it is OK to continue or not.
Part ** is used for Drum Assign.	This message appears when the Part switches of all Parts are set to on, and the Drum Assign function uses Part ** for the Drum Part in Performance mode. The ** mark indicates the Part number.
Part ** is used for Layer.	This message appears when the Part switches of all Parts are set to on, and the Layer function uses Part ** for the Layer Part in the Performance mode. The ** mark indicates the Part number.

LCD indication	Description
Part ** is used for Split.	This message appears when the Part switches of all Parts are set to on, and the Split function uses Part ** for the Split Part in the Performance mode. The ** mark indicates the Part number.
Phrase limit exceeded.	The maximum number of Phrases (256) has been exceeded when recording, executing a Pattern Job, or editing.
Please keep power on.	The data is being written to Flash ROM. Never attempt to turn off the power while data is being written to Flash ROM. Turning the power off while this message is shown results in loss of all user data and may cause the system to freeze (due to corruption of data in the Flash ROM). This may also result in this instrument being unable to properly start up the next time the power is turned on.
Please reboot.	Please restart this instrument.
Please stop sequencer.	The operation you have attempted to execute cannot be done during Song/Pattern playback.
Quick Setup ** applied.	Quick Setup ** has just been applied to this instrument. The ** mark indicates the Quick Setup number.
Read only file.	You have attempted to delete, rename, or overwrite a read-only file.
Receiving MIDI bulk	This instrument is receiving MIDI bulk data.
Scene & Arpeggio type stored	The Song Scene and current Arpeggio type have been stored to one of the [SF1] – [SF6] buttons.
Sequence memory full.	The internal memory for Sequence data is full, preventing any further operation (such as recording, editing, Job execution, MIDI reception/transmission, or loading from the external storage device). Try again after erasing unwanted Song, Pattern, or User Phrase data.
Too many fixed notes	When converting the Song or Pattern data to the Arpeggio data, the amount of different notes in the data to be converted has exceeded sixteen.
Transmitting MIDI bulk	This instrument is transmitting MIDI bulk data.
USB connection terminated.	A break in the connection with the USB flash memory device has occurred because of an abnormal electric current. Disconnect the device from the USB [TO DEVICE] terminal, then press the [ENTER] button.
USB device connecting	Currently recognizing the USB flash memory device connected to the USB [TO DEVICE] terminal.
USB device full.	The USB flash memory device is full and no more data can be saved. Use a new USB flash memory device, or make space by erasing unwanted data from the USB flash memory device.
USB device not ready.	A USB flash memory device is not properly inserted in or connected to the USB [TO DEVICE] terminal.
USB device read/write error.	An error occurred while reading or writing to/from a USB flash memory device.
USB device write protected.	The USB flash memory device is write protected, or you have attempted to write to read-only media.
Utility stored	The settings in the Utility mode have been stored.

Troubleshooting

No sound? Wrong sound? When a problem like this occurs, please check the following points before assuming that the product is faulty. Many problems can be solved by executing the Factory Set operation (page 19), after backing up your data to a USB flash memory device (page 57). If the problem persists, consult your Yamaha dealer.

No Sound.

- Is this instrument properly connected to related external equipment (e.g., amplifier, speaker, headphone) via audio cables?
Since this instrument has no built-in speakers, you will need an external audio system or a set of stereo headphones to properly monitor it (page 17).
- Is the power of this synthesizer and any external equipment connected to it turned on?
- Have you made all the appropriate level settings—including the Master Volume on this instrument and the volume settings on any connected external equipment?
If the Foot Controller is connected to the [FOOT CONTROLLER] jack, operate the Foot Controller and check the sound volume.
- Check the Local Control parameter in the Utility mode.
When this instrument is used by itself and this parameter is set to off, no sound is produced even if you play the keyboard.
[UTILITY] → [F6] MIDI → [SF2] SWITCH → “LocalCtrl”
- Check the Direct Monitor Switch parameter in the Utility mode.
When this instrument is used by itself and this parameter is set to off, no sound is produced even if you play the keyboard.
[UTILITY] → [F5] USB I/O → “DirectMonitorSw Part”
- When the Performance/Song/Pattern produces no sound, is the “ArpPlyOnly” parameter of each Part turned on?
When this parameter is turned on, the corresponding Part produces sound only via Arpeggio playback.
[PERFORM] → [EDIT] → Number [1] – [4] → [F1] VOICE → [SF2] MODE → “ArpPlyOnly?”
[SONG]/[PATTERN] → [MIXING] → [EDIT] → Number [1] – [16] → [F1] VOICE → [SF2] MODE → “ArpPlyOnly”
- Are the MIDI volume or MIDI expression settings too low when using the external controller?
- Are the effect and filter settings appropriate?
If you are using the filter, try changing the cutoff frequency. Some cutoff settings may filter out all of the sound.
[VOICE] → [F6] EFFECT
[PERFORM] → [F6] EFFECT
[SONG]/[PATTERN] → [MIXING] → [F6] EFFECT
[VOICE] → [EDIT] → Element/Key selection → [F3] FILTER
[PERFORM] → [EDIT] → Part selection → [F4] TONE → [SF1] FILTER
[SONG]/[PATTERN] → [MIXING] → [EDIT] → Part selection → [F4] TONE → [SF1] FILTER
[SONG]/[PATTERN] → [UTILITY] → [F2] SEQ → [SF2] FILTER
- Is “Vocoder” selected as the Insertion Effect Type of the Voice?
If so, set the parameters related to the AD Part and A/D INPUT connector to the appropriate values then play the keyboard while speaking into the connected microphone. Check whether or not the A/D INPUT [GAIN] Knob on the rear panel is set to the minimum position.
[VOICE] → [F6] EFFECT → [SF1] CONNECT → “InsEF Connect”
- Are the volume or expression settings too low?
[UTILITY] → [F1] GENERAL → [SF1] TG → “Volume”
[VOICE] → [EDIT] → [COMMON] → [F2] OUTPUT → “Volume”
[VOICE] → [EDIT] → Element/Key selection → [F4] AMP → [SF1] LVL/PAN → “Level”
[PERFORM] → [EDIT] → [COMMON] → [F2] OUT/MFX → [SF1] OUT → “Volume”
[PERFORM] → [EDIT] → Part selection → [F2] OUTPUT → [SF1] VOL/PAN → “Volume”
[SONG]/[PATTERN] → [MIXING] → [EDIT] → Part selection → [F2] OUTPUT → [SF1] VOL/PAN → “Volume”
- Are the parameter settings such as Element Switch, Part Switch, Note Limit and Velocity Limit appropriate?
[VOICE] → [EDIT] → Element/Key selection → [F1] OSC → [SF1] WAVE → “ElementSw”
[VOICE] → [EDIT] → Element/Key selection → [F1] OSC → [SF3] LIMIT
[PERFORM] → [F2] VOICE
[PERFORM] → [EDIT] → Part selection → [F1] VOICE → [SF1] VOICE → “PartSw”
[PERFORM] → [EDIT] → Part selection → [F1] VOICE → [SF3] LIMIT

- When playing the keyboard in the Performance/Song/Pattern mode produces no sound, has a Voice been properly assigned to each Part?

[PERFORM] → [F2] VOICE

[SONG]/[PATTERN] → [MIXING] → [F2] VOICE

- When Song/Pattern playback produces no sound, are the output channel of each Track in the play mode and the receive channel of each Part in the Mixing mode set appropriately?

[SONG]/[PATTERN] → [F3] TRACK

[SONG]/[PATTERN] → [MIXING] → [EDIT] → Part selection → [F1] VOICE → [SF2] MODE → "ReceiveCh"

- When Song/Pattern playback produces no sound, is the Velocity Offset setting of the Groove appropriate?

[SONG]/[PATTERN] → [F2] GROOVE → "VELO OFST"

No sound from the A/D INPUT jack

- Is the switch of the microphone turned on?
- Check the microphone type. Make sure to use a dynamic microphone.
- Is the cable between the microphone or audio equipment and this instrument properly connected?
- Is the A/D INPUT [GAIN] knob turned fully counter-clockwise (to the minimum)?
- Is the A/D INPUT [ON/OFF] button turned on?
- Check whether or not the connection status of the A/D INPUT [L]/[R] matches the "Mono/Stereo" parameter.

[VOICE] → [UTILITY] → [F3] VCE A/D → "Mono/Stereo"

[PERFORM] → [EDIT] → [COMMON] → [F5] A/D IN → "Mono/Stereo"

[SONG]/[PATTERN] → [MIXING] → [EDIT] → [COMMON] → [F5] A/D IN → "Mono/Stereo"

- Check whether or not the "Mic/Line" parameter is set to the appropriate value.
When the output level of the connected equipment (such as a microphone, guitar, bass) is low, set this parameter to "mic." When the output level of the connected equipment (such as a synthesizer keyboard, CD player) is high, set this parameter to "line."

[UTILITY] → [F1] GENERAL → [SF6] OTHER → Press [<] several times to call up the first page. → "Mic/Line"

- Are the volume settings of the A/D Input Part too low?

[VOICE] → [UTILITY] → [F3] VCE A/D → [SF1] OUTPUT → "Volume"

[PERFORM] → [EDIT] → [COMMON] → [F5] A/D IN → [SF1] OUTPUT → "Volume"

[SONG]/[PATTERN] → [MIXING] → [EDIT] → [COMMON] → [F5] A/D IN → [SF1] OUTPUT → "Volume"

- Are the effect settings appropriate?

[VOICE] → [UTILITY] → [F3] VCE A/D

[PERFORM] → [EDIT] → [COMMON] → [F5] A/D IN

[SONG]/[PATTERN] → [MIXING] → [EDIT] → [COMMON] → [F5] A/D IN

- Is the output setting of the A/D Input Part set appropriately?

[UTILITY] → [F4] USB I/O

- Check whether or not the Vocoder Effect is selected.

When Vocoder is selected as the Insertion Effect for the current Voice or for Part 1 of the current Performance/Song/Pattern, the audio signal input from the A/D INPUT jacks may produce no sound depending on the parameter settings.

[VOICE] → [F6] EFFECT → "Ins EF Connect"

Playback continues without stopping.

- When the ARP [ON/OFF] button is turned on, press it so that its lamp is turned off.
- When in the Song mode or Pattern mode, press the [■] (Stop) button.
- When the click sound continues, check the following parameter setting. Set this parameter to something other than "all" because this setting always plays back the click sound regardless of the sequencer status.

[SONG]/[PATTERN] → [UTILITY] → [F2] SEQ → [SF1] CLICK → "Mode"

Distorted sound.

- Are the effect settings appropriate?

Use of an effect at certain settings may produce distortion.

[VOICE] → [F6] EFFECT

[PERFORM] → [F6] EFFECT

[SONG]/[PATTERN] → [MIXING] → [F6] EFFECT

- Are the filter settings appropriate?

Excessively high filter resonance settings can cause distortion.

[VOICE] → [EDIT] → Element/Key selection → [F3] FILTER

[PERFORM] → [EDIT] → Part selection → [F4] TONE → [SF1] FILTER

[SONG]/[PATTERN] → [MIXING] → [EDIT] → Part selection → [F4] TONE → [SF1] FILTER

[SONG]/[PATTERN] → [UTILITY] → [F2] SEQ → [SF2] FILTER

- Are any of the following volume parameters set so high that clipping is occurring?

[UTILITY] → [F1] GENERAL → [SF1] TG → "Volume"

[VOICE] → [EDIT] → [COMMON] → [F2] OUTPUT → Volume

[VOICE] → [EDIT] → Element/Key selection → [F4] AMP → [SF1] LVL/PAN → "Level"

[PERFORM] → [EDIT] → [COMMON] → [F2] OUT/MFX → [SF1] OUT → "Volume"

[PERFORM] → [EDIT] → Part selection → [F2] OUTPUT → [SF1] VOL/PAN → "Volume"

[SONG]/[PATTERN] → [MIXING] → [EDIT] → Part selection → [F2] OUTPUT → [SF1] VOL/PAN → "Volume"

Sound is cut off.

- Is the entire amount of notes played (via your keyboard playback and Song/Pattern/Arpeggio playback) exceeding the maximum polyphony of this instrument?

Only one note sounds at a time.

- When this situation occurs, the Mono/Poly parameter in the current mode is set to "mono." If you wish to play chords, set this parameter to "poly."

[VOICE] → [F4] PORTA → "Mono/Poly"

[PERFORM] → [EDIT] → Part selection → [F1] VOICE → [SF2] MODE → "Mono/Poly"

[SONG]/[PATTERN] → [MIXING] → [EDIT] → Part selection → [F1] VOICE → [SF2] MODE → "Mono/Poly"

Pitch or intervals are wrong.

- Is the Master Tune parameter in the Utility mode set to a value other than "0"?

[UTILITY] → [F1] GENERAL → [SF1] TG → "Tune"

- Is the Note Shift parameter in the Utility mode set to a value other than "0"?

[UTILITY] → [F1] GENERAL → [SF1] TG → "NoteShift"

- When the Voice produces a wrong pitch, is the appropriate tuning system selected from Micro Tuning parameter in the Voice Edit mode?

[VOICE] → [EDIT] → [COMMON] → [F1] GENERAL → [SF2] PLY MODE → "M. Tuning No."

- When the Voice produces a wrong pitch, is the LFO Pitch Modulation Depth in the Voice Edit mode set too high?

[VOICE] → [EDIT] → Element/Key selection → [F5] LFO → "PMod"

- When the Performance/Song/Pattern produces a wrong pitch, are the Note Shift and Detune parameters of each Part set to a value other than "0"?

[PERFORM] → [EDIT] → Part selection → [F4] TONE → [SF1] TUNE

[SONG]/[PATTERN] → [MIXING] → [EDIT] → Part selection → [F4] TONE → [SF1] TUNE

- When the Song/Pattern playback produces a wrong pitch, is the Note Offset parameter in the Groove display set to a value other than "0"?

[SONG]/[PATTERN] → [F2] GROOVE → "NOTE OFST"

No effect is applied.

- Check the on/off status of the EFFECT [INSERTION]/[SYSTEM]/[MASTER] button.

- Is the Reverb Send or Chorus Send set to a value other than "0"?

[VOICE] → [EDIT] → [COMMON] → [F2] OUTPUT → "ChoSend" / "RevSend"

[PERFORM] → [EDIT] → [COMMON] → [F2] OUT/MFX → [SF1] OUT → "ChoSend" / "RevSend"

[SONG]/[PATTERN] → [MIXING] → [EDIT] → Part selection → [F2] OUTPUT → [SF1] VOL/PAN → "ChoSend" / "RevSend"

- Have any or all of the Elements' Insertion Effect Output parameters been set to "thru" in the effect setting display in the Voice Edit mode?

[VOICE] → [F6] EFFECT → [SF1] CONNECT → "EL: OUT 1-8"

- Have any or all of the effect types been set to “thru” or “off”?
- When this occurs in the Performance mode/Song mode/Pattern mode, check whether the Insertion Switch (INS SW) parameters are set properly or not.

[PERFORM] → [F6] EFFECT → [SF2] INS SW

[SONG]/[PATTERN] → [MIXING] → [F3] EFFECT → [SF2] INS SW

The Edit Indicator appears, even when parameters are not being edited.

- Keep in mind that even though the Edit mode is not active, simply moving a Knob/Slider or playing back the Song/Pattern changes the current Voice, Performance, or Mixing, causing the Edit Indicator to appear.

Cannot start the Arpeggio.

- Check whether the ARP [ON/OFF] button is turned on or off.
- When a User Arpeggio type is selected, does the currently selected Arpeggio actually contain data?
- Are the Arpeggio related parameters such as Note Limit and Velocity Limit set appropriately?

[VOICE] → ARP [EDIT] → [F4] LIMIT

[PERFORM] → ARP [EDIT] → [F4] LIMIT

[SONG]/[PATTERN] → ARP [EDIT] → [F4] LIMIT

- When this situation occurs in the Performance/Song/Pattern mode, check the Arpeggio Switch parameter. If this parameter for the current Part is set to off, Arpeggio playback will not be triggered by your keyboard performance even if the ARP [ON/OFF] button is turned on.

[PERFORM] → ARP [EDIT] → [F3] MAIN → Part selection → “Switch”

[SONG]/[PATTERN] → ARP [EDIT] → [F3] MAIN → Part selection → “Switch”

- Is the MIDI Sync parameter set to “internal” or “auto” (using internal clock)?

[UTILITY] → [F5] MIDI → [SF3] SYNC → “MIDI Sync” = “auto” or “internal”

Cannot stop the Arpeggio.

- When Arpeggio playback does not stop even if you release the key, set the Arpeggio Hold parameter to “off.”

[VOICE] → ARP [EDIT] → [F3] MAIN → “Hold”

[PERFORM] → ARP [EDIT] → [F3] MAIN → Part selection → “Hold”

[SONG]/[PATTERN] → ARP [EDIT] → [F3] MAIN → Part selection → “Hold”

The Voice assigned to the Performance produces a different sound from the one in the Voice mode.

- This is normal because the Voice sound is determined by the parameter settings in the Performance mode. To solve this problem, you will need to apply the same parameter settings as those used in the Voice mode via the following three steps.

1. Set the “P.WithVce” (Parameter With Voice) parameter to “on” for a certain Part then reselect the same Voice. The settings of some Voice Common parameters will be applied to the Performance Part.

[PERFORM] → [EDIT] → Number [1] – [4] → [F1] VOICE → [SF1] VOICE → “P.WithVce”

2. Execute the Voice Copy Job in the Performance Job mode.

This Job copies the System Effect, Master Effect and Master EQ settings in the Voice mode to the Performance Common parameters.

[PERFORM] → [JOB] → [F3] COPY → [SF2] VOICE

3. Set the Reverb Send Level and Chorus Send Level to the desired value (same as in the Voice mode) manually.

[PERFORM] → [EDIT] → Part selection → [F2] OUTPUT → [SF2] EF SEND

The Song/Pattern cannot be started even when pressing the [▶] (Play) button.

- Does the selected Song or Pattern (phrase) actually contain data?
- Is the [DAW REMOTE] button turned on?
- Is the MIDI Sync parameter set to “internal” or “auto” (using internal clock)?

[UTILITY] → [F5] MIDI → [SF3] SYNC → “MIDI Sync” = “auto” or “internal”

Song/Pattern (Phrase) cannot be recorded.

- Is there enough free memory for recording?

The total memory capacity determines the number of Songs/Patterns (phrases) that can be recorded. For example, if the memory contains Songs/Patterns (phrases) that use up a large amount of memory, the memory may become full even though the available Pattern or Song numbers are not all used.

Cannot enter the Pattern Job mode/Pattern Mixing mode even when pressing the [JOB] button in the Pattern mode.

- Check whether the instrument is in the Pattern Chain mode or not.
If so, exit from the Pattern Chain mode, then press the [JOB] button or [MIXING] button.

The drum sound is wrong or unexpected when changing the transpose value in the Song/Pattern Play mode.

- This is normal. Changing the transpose setting while playing a Drum Voice will produce different sounds for the same keys played.

Data communication between the computer and this instrument does not work properly.

- Check whether the Port settings on the computer are appropriate or not.
- Check whether or not the MIDI IN/OUT parameter is set to the appropriate value.

[UTILITY] → [F6] MIDI → [SF4] OTHER → "MIDI IN/OUT"

- This problem may be solved by reducing the computer load. To do this, set the USB Audio Output Channel to "2ch" in the following display. If the setting is changed in the display, press the [ENTER] button and then restart the instrument.

[UTILITY] → [F5] USB I/O → [SF1] OUT CH

The sound is not produced properly even when playing back the Song data on the computer or the MIDI instrument connected to this instrument.

- Make sure to set this instrument to the Song mode or Pattern mode.
The Voice mode or Performance mode may not produce the proper sound even when playing back Song data on the MIDI instrument or the computer connected to this instrument.

MIDI bulk data transmission/reception does not work properly.

- Is the Receive Bulk parameter set to on?

[UTILITY] → [F6] MIDI → [SF2] SWITCH → "RcvBulk"

- When receiving MIDI bulk data transmitted via the Bulk Dump function and recorded to the external MIDI device, you need to set the MIDI Device Number to the same value as when transmitting.

[UTILITY] → [F5] MIDI → [SF1] CH → "DeviceNo"

- When transmission does not work properly, is the device number of the MIDI instrument connected to this instrument set to match the Device Number Parameter in the Utility mode?

[UTILITY] → [F5] MIDI → [SF1] CH → "DeviceNo"

Cannot save data to the external USB flash memory device

- Is the USB flash memory device being used write protected? (Write-protect should be set to off for saving data.)
- Is the USB flash memory device being used properly formatted?

[FILE] → [F1] CONFIG → [SF2] FORMAT

Cannot enter the Edit mode

- Is Category Search turned on?
Turn off Category Search then press the [EDIT] button.

About the accessory disk

SPECIAL NOTICE

- The software included in the accessory disk and the copyrights thereof are under exclusive ownership by Steinberg Media Technologies GmbH.
- Copying of the software or reproduction of this manual in whole or in part by any means is expressly forbidden without the written consent of the manufacturer.
- Yamaha makes no representations or warranties with regard to the use of the software and documentation and cannot be held responsible for the results of the use of this manual and the software.
- This disk is NOT for audio/visual purposes. Do not attempt to play the disk on an audio/visual CD/DVD player. Doing so may result in irreparable damage to your player.
- **Note that Yamaha does not offer technical support for the DAW software in the accessory disk.**

About the DAW software in the accessory disk

The accessory disk contains DAW software both for Windows and Macintosh.

NOTE

- Make sure to install DAW software under the "Administrator" account.
- In order to have continuous use of the DAW software in the accessory disk, including support and other benefits, you will need to register the software and activate your software license by starting the software while the computer is connected to the Internet. Click the "Register Now" button shown when the software is started, then fill in all required fields for registration. If you do not register the software, you will be unable to use it after a limited period of time expires.
- If you are using a Macintosh computer, double-click the "****.mpkg" file to start installation.

For information about the minimum system requirements and latest information on the software in the disk, check the web site below.

<http://www.yamahasyth.com/>

About software support

Support for the DAW software in the accessory disk is provided by Steinberg on its website at the following address.

<http://www.steinberg.net>

You can visit the Steinberg site also via the Help menu of the included DAW software. (The Help menu also includes the PDF manual and other information on the software.)

Specifications

Keyboards	MOX8	88 keys, GHS keyboard (Initial Touch)
	MOX6	61 keys, semi-weighted keyboard (Initial Touch)
Tone Generator block	Tone Generator	AWM2, with Expanded Articulation
	Polyphony	64 notes
	Multi-timbral Capacity	16 parts (Internal), A/D input part
	Wave	355MB (when converted to 16-bit linear format), 2,670 waveforms
	Voice	Preset: 1,024 Normal Voices + 64 Drum Kits GM: 128 Normal Voices + 1 Drum Kit User: 128 x 3 (selected and copied from Preset bank), Normal Voice + 32 Drum Kits
	Performance	User: 128 x 2 (up to 4 parts)
	Filter	18 types
	Effect System	Reverb x 9 types, Chorus x 22 types, Insertion (A, B) x 54 types x 3 parts, Vocoder x 1 (uses both Insertion Effect A and B blocks), Master Effect x 9 types, Master EQ (5 bands), Part EQ (3 bands, stereo)
Sequencer block	Note Capacity	Approx. 226,000 notes
	Note Resolution	480 ppq (parts per quarter note)
	Maximum Polyphony	124 notes
	Tempo (BPM)	5 – 300
	Recording type	Real time replace, Real time overdub (with the exception of the Pattern Chain), Real time punch in/out (Song only), Step (with the exception of the Pattern Chain)
	Tracks	Pattern: 16 Phrase Tracks Pattern Chain: Pattern Track, Tempo Track, Scene Track Song: 16 sequence Tracks (Loop on/off can be set for each Track), Tempo Track, Scene Track
	Patterns	64 Patterns (x 16 sections) Measures: 256 maximum
	Phrases	User Phrases: 256 per Pattern
	Songs	64 Songs Mixing Voices: 16 Voices per Song and up to 256 Voices for all Patterns Mixing Templates: 32 for all Songs and Patterns
	Arpeggio	Preset: 6,720 types User: 256 types (MIDI Sync, MIDI transmit/receive channel, Velocity Limit, and Note Limit can be set.)
	Scene Memory	5 per Song
	Sequence Format	Original format, SMF format 0, 1 (Format 1 load only)
	Others	Master
Sequence Software compatible with the Remote Control function		For Windows®: Cubase 5.5, SONAR 8 For Macintosh®: Cubase 5.5, Logic 9, Digital Performer 6, 7 (Functions to be controlled differ depending on the software.)
Controllers		Pitch Bend wheel, Modulation wheel, Assignable Knob x 8, [DATA] dial x 1, Assignable Function buttons x 2
Display		240 x 64 dot, backlit LCD
Connectors		OUTPUT [L/MONO]/[R] (standard phone jack), A/D INPUT [L]/[R] (standard phone jack), [PHONES] (standard stereo phone jack), [FOOT CONTROLLER], FOOT SWITCH [ASSIGNABLE]/[SUSTAIN], MIDI [IN]/[OUT]/[THRU], USB [TO HOST]/[TO DEVICE], DC IN
Power Consumption		10W
Dimensions, Weight		MOX6: 1030 (W) x 358 (D) x 125 (H) mm, 7.0 kg MOX8: 1320 (W) x 405 (D) x 168 (H) mm, 14.8 kg
Accessories	AC adaptor (PA-150 or an equivalent recommended by Yamaha), USB cable, Owner's Manual (this book), Online Manual CD-ROM x 1 (containing Reference Manual, Synthesizer Parameter Manual, and Data List), DVD-ROM x 1 (containing DAW software)	

Specifications and descriptions in this owner's manual are for information purposes only. Yamaha Corp. reserves the right to change or modify products or specifications at any time without prior notice. Since specifications, equipment or options may not be the same in every locale, please check with your Yamaha dealer.

Index

A

A/D INPUT [GAIN] knob	12
A/D INPUT [L] and [R] jacks	16, 36
A/D INPUT [ON/OFF] button	12
accessory disk	67
ARP [EDIT] button	13, 29
ARP [ON/OFF] button	13, 26
Arpeggio	26, 33
ASSIGNABLE FUNCTION [1]/[2] buttons	12
Audio channels	51
audio equipment	36

B

BANK SELECT [DEC]/[INC] buttons	14
---------------------------------	----

C

[CATEGORY SEARCH] button	14, 25
CHAR	21
Click	56
[COMMON] button	14
Common Edit	28
Compare function	28
Connect (Computer)	50
Connect (External MIDI Instrument)	49
Cubase	8, 53, 54, 68
Cursor buttons	14, 20

D

[DATA] dial	14, 20
[DAW LEVEL] slider	12
[DAW REMOTE] button	13, 53
DAW software	52
DC IN connector	16
[DEC] button	14, 20
Demo Pattern	44
Demo Song	18
Digital Performer	53, 68
Display Messages	60
Drum Assign	31
[DRUM ASSIGN] button	14
Drum Voice	24

E

Edit Indicator	27
Effect	28, 56
EFFECT buttons	13
Element Edit	28
[ENTER] button	14
[EXIT] button	14

F

[F1] – [F6] (Function) buttons	13, 20
Factory Settings	19
[FAVORITE] button	14, 25
Favorite Category	25
File Mode	57

[FOOT CONTROLLER] jack	16
FOOT SWITCH [ASSIGNABLE]/[SUSTAIN] jacks	16
Format	58

G

GM Bank	24
GM Voice	24
Group [A] – [H] buttons	14

H

Headphones	17
------------	----

I

[INC] button	14, 20
--------------	--------

K

Key Edit	28
Keyboard	12
Knob Function button	12, 27
KNOB FUNCTION pop-up window	27
Knobs	12, 27

L

Layer	30
[LAYER] button	14
LCD	13
LCD status	56
[LEVEL] meter	12
[LEVEL] meter button	12
Load	57
Logic Pro	53, 68

M

Master Effect	56
Master EQ	56
Master mode	55
MASTER VOLUME	12, 18
microphone	36
MIDI [IN] / [OUT] / [THRU] terminals	16
MIDI channels	51
MIDI ports	51
MIDI Receive Channel	49
MIDI Transmit Channel	49
Mixing	38, 43
Mixing template	43
[MODE] buttons	14
Modes	22
Modulation wheel	12
MOX6/MOX8 Editor	54
Mute	32, 38
[MUTE] button	15

N

Naming	21
Normal Voice	24
NUM	20
Number [1] – [16] buttons	15

O

OCTAVE [-] and [+] buttons	12, 26
OUTPUT [L/MONO] and [R] jacks	16

P

Part	32
Pattern	34
Pattern Chain	47
Pattern mode	44
Pattern Patch display	46
Pattern Play	44
[PATTERN SECTION/PERFORMANCE CONTROL] button	15
Performance Creator	14, 30
Performance Edit	34
Performance Mode	32
Performance Play	32
[PHONES] (Headphone) jack	16
Pitch Bend wheel	12
Power On Mode	56
Power supply	17
Preset Banks	24
Punch In/Out	41

Q

Quick Setup	52
-------------------	----

R

Realtime Recording	38, 40
Record (Pattern)	45
Record (Performance)	34
Record (Song)	39
Remote Control	53

S

Save	57
Section	35
Section Length	35
SEQ TRANSPORT button	13, 18
[SF1] – [SF6] (Sub Function) buttons	13, 20
[SHIFT] button	14
Shift Function List	59
Solo	33, 38
[SOLO] button	15
SONAR	53, 68
Song	34
Song mode	38
Speaker	17
Split	30
[SPLIT] button	14
Standby/On switch	16
Step Recording	38, 39
Store	28, 43

T

Track	38
[TRACK] button	15
TRANSPOSE [-] and [+] buttons	13, 26
Troubleshooting	62

U

USB [TO DEVICE] terminal	58
USB [TO HOST] terminal	51
USB flash memory device	57, 58
USB terminals	16
User Banks	24
User Phrase	45, 46
Utility mode	56

V

Vocoder	37
Voice Edit	27
Voice mode	24
Voice Play	24

Y

Yamaha Steinberg USB Driver	50
-----------------------------------	----

Memo

Memo

Important Notice: Guarantee Information for customers in EEA* and Switzerland (EEA) and Switzerland

Important Notice: Guarantee Information for customers in EEA* and Switzerland For detailed guarantee information about this Yamaha product, and Pan-EEA* and Switzerland warranty service, please either visit the website address below (Printable file is available at our website) or contact the Yamaha representative office for your country (next page). * EEA: European Economic Area	English
Wichtiger Hinweis: Garantie-Information für Kunden in der EWR* und der Schweiz Für nähere Garantie-Information über dieses Produkt von Yamaha, sowie über den Pan-EWR*- und Schweizer Garantieservice, besuchen Sie bitte entweder die folgende angegebene Internetadresse (eine druckfähige Version befindet sich auch auf unserer Webseite), oder wenden Sie sich an den für Ihr Land zuständigen Yamaha-Vertrieb (nächste Seite). *EWR: Europäischer Wirtschaftsraum	Deutsch
Remarque importante: informations de garantie pour les clients de l'EEE et la Suisse Pour des informations plus détaillées sur la garantie de ce produit Yamaha et sur le service de garantie applicable dans l'ensemble de l'EEE ainsi qu'en Suisse, consultez notre site Web à l'adresse ci-dessous (le fichier imprimable est disponible sur notre site Web) ou contactez directement Yamaha dans votre pays de résidence (page suivante). * EEE : Espace Economique Européen	Français
Belangrijke mededeling: Garantie-informatie voor klanten in de EER* en Zwitserland Voor gedetailleerde garantie-informatie over dit Yamaha-product en de garantieservice in heel de EER* en Zwitserland, gaat u naar de onderstaande website (u vind een afdrukbaar bestand op onze website) of neemt u contact op met de vertegenwoordiging van Yamaha in uw land (volgende pagina). * EER: Europese Economische Ruimte	Nederlands
Aviso importante: información sobre la garantía para los clientes del EEE* y Suiza Para una información detallada sobre este producto Yamaha y sobre el soporte de garantía en la zona EEE* y Suiza, visite la dirección web que se incluye más abajo (la versión del archivo para imprimir está disponible en nuestro sitio web) o póngase en contacto con el representante de Yamaha en su país (página siguiente). * EEE: Espacio Económico Europeo	Español
Aviso importante: informazioni sulla garanzia per i clienti residenti nell'EEA* e in Svizzera Per informazioni dettagliate sulla garanzia relativa a questo prodotto Yamaha e l'assistenza in garanzia nei paesi EEA* e in Svizzera, potete consultare il sito Web all'indirizzo riportato di seguito (è disponibile il file in formato stampabile) oppure contattate l'ufficio di rappresentanza locale della Yamaha (pagina seguente). * EEA: Area Economica Europea	Italiano
Aviso importante: informações sobre as garantias para clientes da AEE* e da Suíça Para obter uma informação pormenorizada sobre este produto da Yamaha e sobre o serviço de garantia na AEE* e na Suíça, visite o site a seguir (o arquivo para impressão está disponível no nosso site) ou entre em contato com o escritório de representação da Yamaha no seu país (próxima página). * AEE: Área Económica Europeia	Português
Σημαντική σημείωση: Πληροφορίες εγγύησης για τους πελάτες στον ΕΟΧ* και Ελβετία Για λεπτομερείς πληροφορίες εγγύησης σχετικά με το προϊόν της Yamaha και την κάλυψη εγγύησης σε όλες τις χώρες του ΕΟΧ* και την Ελβετία, επισκεφτείτε την παρακάτω ιστοσελίδα (Εκτυπώσιμη μορφή είναι διαθέσιμη στην ιστοσελίδα μας) ή απευθυνθείτε στην αντιπροσωπεία της Yamaha στη χώρα σας (επόμενη σελίδα). * ΕΟΧ: Ευρωπαϊκός Οικονομικός Χώρος	Ελληνικά
Viktigt: Garantinformasjon for kunder i EES-området* och Schweiz För detaljerad information om denna Yamaha-produkt samt garantireservice i hela EES-området* och Schweiz kan du antingen besöka nedanstående webbadress (en utskriftsvänlig fil finns på webbplatsen) eller kontakta Yamahas officiella representant i ditt land (nästa sida). * EES: Europeiska Ekonomiska Samarbetsområdet	Svenska
Viktig merknad: Garantinformasjon for kunder i EØS* og Sveits Detaljert garantinformasjon om dette Yamaha-produktet og garantireservice for hele EØS-området* og Sveits kan fås enten ved å besøke nettstedene nedenfor (utskriftsversjon finnes på våre nettsider) eller kontakte kontakte Yamaha-kontoret i landet der du bor (neste side). *EØS: Det europeiske økonomiske samarbeidsområdet	Norsk
Vigtig oplysning: Garantiplysninger til kunder i EØO* og Schweiz De kan finde detaljerede garantiplysninger om dette Yamaha-produkt og den fælles garantireserviceordning for EØO* (og Schweiz) ved at besøge det websted, der er angivet nedenfor (der findes en fil, som kan udskrives, på vores websted), eller ved at kontakte Yamahas nationale repræsentationskontor i det land, hvor De bor (næste side). * EØO: Det Europæiske Økonomiske Område	Dansk

Tärkeä ilmoitus: Taku tiedot Euroopan talousalueen (ETA)* ja Sveitsin asiakkaille Tämän Yamaha-tuotteen sekä ETA-alueen ja Sveitsin takuuta koskevat yksityiskohdat tiedot saatte alla olevasta nettiosoitteesta. (Tuotetietoa tiedosto saatavana sivustollamme.) Voitte myös ottaa yhteyttä paikalliseen Yamaha-edustajaan (seuraavalla sivulla). *ETA: Euroopan talousalue	Suomi
Ważne: Warunki gwarancyjne obowiązujące w EOG* i Szwajcarii Aby dowiedzieć się więcej na temat warunków gwarancyjnych tego produktu firmy Yamaha i serwisu gwarancyjnego w całym EOG* i Szwajcarii, należy odwiedzić wskazaną poniżej stronę internetową (plik gotowy do wydruku znajduje się na naszej stronie internetowej) lub skontaktować się z przedstawicielstwem firmy Yamaha w swoim kraju (następna strona). * EOG — Europejski Obszar Gospodarczy	Polski
Důležité oznámení: Záruční informace pro zákazníky v EHS* a ve Švýcarsku Podrobné záruční informace o tomto produktu Yamaha a záručním servisu v celém EHS* a ve Švýcarsku naleznete na níže uvedené webové adrese (soubor k tisku je dostupný na našich webových stránkách) nebo se můžete obrátit na zastoupení firmy Yamaha ve své zemi (další stránka). * EHS: Evropský hospodářský prostor	Česky
Fontos figyelmeztetés: Garancia-információk az EGT* területén és Svájcban élő vásárlók számára A jelen Yamaha termékre vonatkozó részletes garancia-információk, valamint az EGT*-re és Svájcra kiterjedő garanciális szolgáltatás tekintetében keresse fel webhelyünket az alábbi címen (a webhelyen nyomtatható fájl is található), vagy pedig lépjen kapcsolatba az országában működő Yamaha képviselői irodával (következő oldal). * EGT: Európai Gazdasági Térség	Magyar
Oluline märkus: Garantiteave Euroopa Majanduspiirkonna (EMP)* ja Šveitsi klientidele Täpsema teabe saamiseks selle Yamaha toote garantii ning kogu Euroopa Majanduspiirkonna ja Šveitsi garantiteeninduse kohta, külastage palun veebisaiti alljärgneval aadressil (meie saidil on saadaval printitav fail) või pöörduge Teie regiooni Yamaha esinduse poole (järgmine lehekülg). * EMP: Euroopa Majanduspiirkond	Eesti keel
Svarigs paziņojums: garantijas informācija klientiem EEZ* un Šveicē Lai saņemtu detalizētu garantijas informāciju par šo Yamaha produktu, kā arī garantijas apkalpošanu EEZ* un Šveicē, lūdzam apskatīties zemāk norādīto tīmekļa vietnes adresē (tīmekļa vietnē ir pieejams drukājams fails) vai sazināties ar jūsu valsti apkalpojošo Yamaha pārstāvniecību (nākamā lappuse). * EEZ: Eiropas Ekonomikas zona	Latviešu
Dėmesio: informacija dėl garantijos priekšams EEE* ir Šveicarijoje Jei reikia išsamios informacijos apie šį „Yamaha“ produktą ir jo techninę priežiūrą visoje EEE* ir Šveicarijoje, apsilankykite mūsų svetainėje toliau nurodytu adresu (svetainėje yra spausdinamas failas) arba kreipkitės į „Yamaha“ atstovybę savo šaliai (kitas puslapis). *EEE – Europos ekonominė erdvė	Lietuvių kalba
Dôležité upozornenie: Informácie o záruke pre zákazníkov v EHP* a Švajčiarsku Podrobné informácie o záruke týkajúce sa tohto produktu od spoločnosti Yamaha a garancnom servise v EHP* a Švajčiarsku nájdete na webovej stránke uvedenej nižšie (na našej webovej stránke je k dispozícii súbor na tlač) alebo sa obráťte na zástupcu spoločnosti Yamaha vo svojej krajine (nasledujúca strana). * EHP: Európsky hospodársky priestor	Slovenčina
Pomembno obvestilo: Informacije o garanciji za kupce v EGP* in Švici Za podrobnejše informacije o tem Yamahinem izdelku ter garancijskem servisu v celotnem EGP in Švici, obiščite spletno mesto, ki je navedeno spodaj (natisljiva datoteka je na voljo na našem spletnem mestu), ali se obrnite na Yamahinega predstavnikva v svoji državi (naslednja stran). * EGP: Evropski gospodarski prostor	Slovenščina
Важно съобщение: Информация за гаранцията за клиенти в ЕИПТ* и Швейцария За подробна информация за гаранцията за този продукт на Yamaha и гаранционното обслужване в паневропейската зона на ЕИПТ* и Швейцария или посетете посочения по-долу уеб сайт (на нашия уеб сайт има файл за печат), или се свържете с представителния офис на Yamaha във вашата страна (следваща страница). * ЕИПТ: Европейско икономическо пространство	Български език
Notificare importantă: Informații despre garanție pentru clienții din SEE* și Elveția Pentru informații detaliate privind acest produs Yamaha și serviciul de garanție Pan-SEE* și Elveția, vizitați site-ul la adresa de mai jos (fișierul imprimabil este disponibil pe site-ul nostru) sau contactați biroul reprezentanței Yamaha din țara dumneavoastră (pagina următoare). * SEE: Spațiul Economic European	Limba română

<http://europe.yamaha.com/warranty/>

Yamaha Representative Offices in Europe

AUSTRIA

Yamaha Music Europe GmbH
Branch Austria
Schleiergasse 20, A-1100 Wien Austria
Tel: +43 (0)1 602 03900
Fax: +43 (0)1 602 039051

BELGIUM

Yamaha Music Europe
Branch Benelux
Clarissenhof 5b NL, 4133 AB. Vianen
The Netherlands
Tel: +31 (0)347 358040
Fax: +31 (0)347 358060

BULGARIA

Yamaha Music Europe GmbH
Branch Austria (Central and Eastern Europe)
Schleiergasse 20, A-1100 Wien Austria
Tel: +43 (0)1 602 03900
Fax: +43 (0)1 602 039051

CYPRUS

NAKAS Music Cyprus Ltd.
31C Nikis Ave., 1086 Nicosia
Tel: +357 (0)22 510 477
Fax: +357 (0)22 511 080

CZECH REPUBLIC

Yamaha Music Europe GmbH
Branch Austria (Central and Eastern Europe)
Schleiergasse 20, A-1100 Wien Austria
Tel: +43 (0)1 602 03900
Fax: +43 (0)1 602 039051

DENMARK

YS Copenhagen Liaison Office
(Yamaha Scandinavia AB Filial Denmark)
Generatorvej 6A, 2730 Herlev, Denmark
Tel: +45 44 92 49 00
Fax: +45 44 54 47 09

ESTONIA

Yamaha Music Europe GmbH
Sp. z o.o. Oddział w Polsce
(Branch Poland)
ul. 17 Stycznia 56
PL-02-146 Warszawa Poland
Tel: +48 (0)22 500 29 25
Fax: +48 (0)22 500 29 30

FINLAND

(For Musical Instrument)
F - Musiikki OY
Kaisaniemenkatu 7, PL260
00101 Helsinki, Finland
Tel: +358 (0)9 618511
Fax: +358 (0)9 61851385

(For Pro Audio)

Yamaha Scandinavia AB
J.A. Wettergrens gata 1
Västra Frölunda, Sweden
(Box 300 53, 400 43 Göteborg
Sweden - Postal Address)
Tel: +46 (0)31 893400
Fax: +46 (0)31 454026

FRANCE

Yamaha Musique France
Zone d'activité de Pariest
7, rue Ambroise Croizat
77183 Croissy-Beaubourg, France
(B.P. 70, 77312 Mame la Vallée Cedex 2
France-Adresse postale)
Tel: +33 (0)1 64 61 4000
Fax: +33 (0)1 64 61 4079

GERMANY

Yamaha Music Europe GmbH
Siemensstr. 22-34
D-25462 Rellingen, b. Hamburg, Germany
Tel: +49 (0)4101 3030
Fax: +49 (0)4101 303 77702

GREECE

PH. Nakas S.A. Music House/Service
19 KM Leoforos Lavriou
19002 Peania / Attiki, Greece
Tel: +30 (0)210 6686260
Fax: +30 (0)210 6686269

HUNGARY

Yamaha Music Europe GmbH
Branch Austria (Central and Eastern Europe)
Schleiergasse 20, A-1100 Wien Austria
Tel: +43 (0)1 602 03900
Fax: +43 (0)1 602 039051

ICELAND

(For Musical Instrument)
HLJODFAERAHUSID EHF
Sidumula 20
108 Reykjavik, Iceland
Tel: +354 525 50 50
Fax: +354 568 65 14

(For Pro Audio)

Yamaha Scandinavia AB
J.A. Wettergrens gata 1
Västra Frölunda, Sweden
(Box 300 53, 400 43 Göteborg
Sweden - Postal Address)
Tel: +46 (0)31 893400
Fax: +46 (0)31 454026

IRELAND (REPUBLIC OF IRELAND)

Yamaha Music UK Ltd.
Sherbourne Drive
Tilbrook, Milton Keynes MK7 8BL
United Kingdom
Tel: +353 (0) 1526 2449
Fax: +44 (0) 1908 369278

ITALY

Yamaha Musica Italia s.p.a.
Viale Italia 88
20020, Lainate (Milano), Italy
Tel: +39 (0)02 93577 1
Fax: +39 (0)02 937 0956

LATVIA

Yamaha Music Europe GmbH
Sp. z o.o. Oddział w Polsce
(Branch Poland)
ul. 17 Stycznia 56
PL-02-146 Warszawa Poland
Tel: +48 (0)22 500 29 25
Fax: +48 (0)22 500 29 30

LIECHTENSTEIN

Yamaha Music Europe GmbH, Rellingen,
Branch Switzerland in Zurich
Seefeldstrasse 94, CH-8008
Zürich, Switzerland
Tel: +41 (0)44 3878080
Fax: +41 (0)44 3833918

LITHUANIA

Yamaha Music Europe GmbH
Sp. z o.o. Oddział w Polsce
(Branch Poland)
ul. 17 Stycznia 56
PL-02-146 Warszawa Poland
Tel: +48 (0)22 500 29 25
Fax: +48 (0)22 500 29 30

LUXEMBOURG

Yamaha Music Europe
Branch Benelux
Clarissenhof 5b NL, 4133 AB. Vianen
The Netherlands
Tel: +31 (0)347 358040
Fax: +31 (0)347 358060

MALTA

Olimpus Music Ltd.
The Emporium, Level 3, St. Louis Street
Msida MSD06
Tel: +356 (0)2133 2093
Fax: +356 (0)2133 2144

NETHERLANDS

Yamaha Music Europe
Branch Benelux
Clarissenhof 5b NL, 4133 AB. Vianen
The Netherlands
Tel: +31 (0)347 358040
Fax: +31 (0)347 358060

NORWAY

YS Oslo Liaison Office
(Yamaha Scandinavia AB Filial Norway)
Grini Naeringspark 1
1361 Osteras, Norway
Tel: +47 67 16 77 70
Fax: +47 67 16 77 79

POLAND

YAMAHA Music Europe GmbH
Sp. z o.o. Oddział w Polsce
ul. 17 Stycznia 56
02-146 WARSZAWA/POLSKA
Tel: +48 (0)22 500 29 25
Fax: +48 (0)22 500 29 30

PORTUGAL

Yamaha Música Ibérica, S.A.U.
Sucursal Portuguesa
Rua Alfredo da Silva
2610-016 Amadora, Portugal
Tel: +351 214 704 330
Fax: +351 214 718 220

ROMANIA

Yamaha Music Europe GmbH
Branch Austria (Central and Eastern Europe)
Schleiergasse 20, A-1100 Wien Austria
Tel: +43 (0)1 602 03900
Fax: +43 (0)1 602 039051

SLOVAKIA

Yamaha Music Europe GmbH
Branch Austria (Central and Eastern Europe)
Schleiergasse 20, A-1100 Wien Austria
Tel: +43 (0)1 602 03900
Fax: +43 (0)1 602 039051

SLOVENIA

Yamaha Music Europe GmbH
Branch Austria (Central and Eastern Europe)
Schleiergasse 20, A-1100 Wien Austria
Tel: +43 (0)1 602 03900
Fax: +43 (0)1 602 039051

SPAIN

Yamaha Musica Ibérica, S.A.U.
Ctra. de la Coruna km.17, 200
28230 Las Rozas de Madrid, Spain
Tel: +34 902 39 8888
Fax: +34 91 638 4660

SWEDEN

Yamaha Scandinavia AB
J.A. Wettergrens gata 1
Västra Frölunda, Sweden
(Box 300 53, 400 43 Göteborg
Sweden - Postal Address)
Tel: +46 (0)31 893400
Fax: +46 (0)31 454026

SWITZERLAND

Yamaha Music Europe GmbH, Rellingen,
Branch Switzerland in Zurich
Seefeldstrasse 94, CH-8008
Zürich, Switzerland
Tel: +41 (0)44 3878080
Fax: +41 (0)44 3833918

UNITED KINGDOM

Yamaha Music UK Ltd.
Sherbourne Drive
Tilbrook, Milton Keynes MK7 8BL
United Kingdom
Tel: +44 (0) 870 4445575
Fax: +44 (0) 1908 369278

For details of products, please contact your nearest Yamaha representative or the authorized distributor listed below.

Pour plus de détails sur les produits, veuillez-vous adresser à Yamaha ou au distributeur le plus proche de vous figurant dans la liste suivante.

Die Einzelheiten zu Produkten sind bei Ihrer unten aufgeführten Niederlassung und bei Yamaha Vertragshändlern in den jeweiligen Bestimmungsländern erhältlich.

Para detalles sobre productos, contacte su tienda Yamaha más cercana o el distribuidor autorizado que se lista debajo.

NORTH AMERICA

CANADA

Yamaha Canada Music Ltd.
135 Milner Avenue, Scarborough, Ontario,
M1S 3R1, Canada
Tel: 416-298-1311

U.S.A.

Yamaha Corporation of America
6600 Orangethorpe Ave., Buena Park, Calif. 90620,
U.S.A.
Tel: 714-522-9011

CENTRAL & SOUTH AMERICA

MEXICO

Yamaha de México S.A. de C.V.
Calz. Javier Rojo Gómez #1149,
Col. Guadalupe del Moral
C.P. 09300, México, D.F., México
Tel: 55-5804-0600

BRAZIL

Yamaha Musical do Brasil Ltda.
Rua Joaquim Floriano, 913 - 4º andar, Itaim Bibi,
CEP 04534-013 Sao Paulo, SP. BRAZIL
Tel: 011-3704-1377

ARGENTINA

Yamaha Music Latin America, S.A.
Sucursal de Argentina
Olga Cossettini 1553, Piso 4 Norte
Madero Este-C1107CEK
Buenos Aires, Argentina
Tel: 011-4119-7000

PANAMA AND OTHER LATIN AMERICAN COUNTRIES/ CARIBBEAN COUNTRIES

Yamaha Music Latin America, S.A.
Torre Banco General, Piso 7, Urbanización Marbella,
Calle 47 y Aquilino de la Guardia,
Ciudad de Panamá, Panamá
Tel: +507-269-5311

EUROPE

THE UNITED KINGDOM/IRELAND

Yamaha Music Europe GmbH (UK)
Sherbourne Drive, Tilbrook, Milton Keynes,
MK7 8BL, England
Tel: 01908-366700

GERMANY

Yamaha Music Europe GmbH
Siemensstraße 22-34, 25462 Rellingen, Germany
Tel: 04101-3030

SWITZERLAND/LIECHTENSTEIN

Yamaha Music Europe GmbH
Branch Switzerland in Zürich
Seefeldstrasse 94, 8008 Zürich, Switzerland
Tel: 044-387-8080

AUSTRIA

Yamaha Music Europe GmbH Branch Austria
Schleiergasse 20, A-1100 Wien, Austria
Tel: 01-60203900

CZECH REPUBLIC/HUNGARY/ ROMANIA/SLOVAKIA/SLOVENIA

Yamaha Music Europe GmbH
Branch Austria (Central Eastern Europe Office)
Schleiergasse 20, A-1100 Wien, Austria
Tel: 01-602039025

POLAND/LITHUANIA/LATVIA/ESTONIA

Yamaha Music Europe GmbH
Branch Sp.z o.o. Oddział w Polsce
ul. 17 Stycznia 56, PL-02-146 Warszawa, Poland
Tel: 022-500-2925

BULGARIA

Dinacord Bulgaria LTD.
Bul. Iskarsko Schose 7 Targowski Zentar Ewropa
1528 Sofia, Bulgaria
Tel: 02-978-20-25

MARTA

Olimpus Music Ltd.
The Emporium, Level 3, St. Louis Street Msida
MSD06
Tel: 02133-2144

THE NETHERLANDS/ BELGIUM/LUXEMBOURG

Yamaha Music Europe Branch Benelux
Clarissenhof 5-b, 4133 AB Vianen, The Netherlands
Tel: 0347-358 040

FRANCE

Yamaha Music Europe
7 rue Ambroise Croizat, Zone d'activités Pariest,
77183 Croissy-Beaubourg, France
Tel: 01-64-61-4000

ITALY

Yamaha Music Europe GmbH, Branch Italy
Viale Italia 88, 20020 Lainate (Milano), Italy
Tel: 02-935-771

SPAIN/PORTUGAL

**Yamaha Music Europe GmbH Ibérica, Sucursal
en España**
Ctra. de la Coruna km. 17, 200, 28230
Las Rozas (Madrid), Spain
Tel: 91-639-8888

GREECE

Philippos Nakas S.A. The Music House
147 Skiathou Street, 112-55 Athens, Greece
Tel: 01-228 2160

SWEDEN

**Yamaha Music Europe GmbH Germany filial
Scandinavia**
J. A. Wettergrens Gata 1, Box 30053
S-400 43 Göteborg, Sweden
Tel: 031 89 34 00

DENMARK

**Yamaha Music Europe GmbH, Tyskland – filial
Denmark**
Generatorvej 6A, DK-2730 Herlev, Denmark
Tel: 44 92 49 00

FINLAND

F-Musiikki Oy
Kluuvikatu 6, P.O. Box 260,
SF-00101 Helsinki, Finland
Tel: 09 618511

NORWAY

**Yamaha Music Europe GmbH Germany -
Norwegian Branch**
Grini Næringspark 1, N-1345 Østerås, Norway
Tel: 67 16 77 70

ICELAND

Skifan HF
Skeifan 17 P.O. Box 8120, IS-128 Reykjavik, Iceland
Tel: 525 5000

RUSSIA

Yamaha Music (Russia)
Room 37, bld. 7, Kievskaya street, Moscow,
121059, Russia
Tel: 495 626 5005

OTHER EUROPEAN COUNTRIES

Yamaha Music Europe GmbH
Siemensstraße 22-34, 25462 Rellingen, Germany
Tel: +49-4101-3030

AFRICA

**Yamaha Corporation,
Asia-Pacific Sales & Marketing Group**
Nakazawa-cho 10-1, Naka-ku, Hamamatsu,
Japan 430-8650
Tel: +81-53-460-2313

MIDDLE EAST

TURKEY/CYPRUS

Yamaha Music Europe GmbH
Siemensstraße 22-34, 25462 Rellingen, Germany
Tel: 04101-3030

OTHER COUNTRIES

Yamaha Music Gulf FZE
LOB 16-513, P.O.Box 17328, Jubel Ali,
Dubai, United Arab Emirates
Tel: +971-4-881-5868

ASIA

THE PEOPLE'S REPUBLIC OF CHINA

Yamaha Music & Electronics (China) Co., Ltd.
2F, Yunhedasha, 1818 Xinzha-lu, Jingan-qu,
Shanghai, China
Tel: 021-6247-2211

HONG KONG

Tom Lee Music Co., Ltd.
11/F., Silvercord Tower 1, 30 Canton Road,
Tsimshatsui, Kowloon, Hong Kong
Tel: 2737-7688

INDIA

Yamaha Music India Pvt. Ltd.
Spazedge building, Ground Floor, Tower A, Sector
47, Gurgaon- Sohna Road, Gurgaon, Haryana, India
Tel: 0124-485-3300

INDONESIA

**PT. Yamaha Musik Indonesia (Distributor)
PT. Nusantara**
Gedung Yamaha Music Center, Jalan Jend. Gatot
Subroto Kav. 4, Jakarta 12930, Indonesia
Tel: 021-520-2577

KOREA

Yamaha Music Korea Ltd.
8F, 9F, Dongsung Bldg. 158-9 Samsung-Dong,
Kangnam-Gu, Seoul, Korea
Tel: 02-3467-3300

MALAYSIA

Yamaha Music (Malaysia) Sdn., Bhd.
Lot 8, Jalan Perbandaran, 47301 Kelana Jaya,
Petaling Jaya, Selangor, Malaysia
Tel: 03-78030900

PHILIPPINES

Yupangco Music Corporation
339 Gil J. Puyat Avenue, P.O. Box 885 MCPO,
Makati, Metro Manila, Philippines
Tel: 819-7551

SINGAPORE

Yamaha Music (Asia) PRIVATE LIMITED
Blk 202 Hougang Street 21, #02-00,
Singapore 530202, Singapore
Tel: 6747-4374

TAIWAN

Yamaha KHS Music Co., Ltd.
3F, #6, Sec.2, Nan Jing E. Rd. Taipei.
Taiwan 104, R.O.C.
Tel: 02-2511-8688

THAILAND

Siam Music Yamaha Co., Ltd.
4, 6, 15 and 16th floor, Siam Motors Building,
891/1 Rama 1 Road, Wangmai,
Pathumwan, Bangkok 10330, Thailand
Tel: 02-215-2622

OTHER ASIAN COUNTRIES

**Yamaha Corporation,
Asia-Pacific Sales & Marketing Group**
Nakazawa-cho 10-1, Naka-ku, Hamamatsu,
Japan 430-8650
Tel: +81-53-460-2313

OCEANIA

AUSTRALIA

Yamaha Music Australia Pty. Ltd.
Level 1, 99 Queensbridge Street, Southbank,
Victoria 3006, Australia
Tel: 3-9693-5111

NEW ZEALAND

Music Works LTD
P.O. BOX 6246 Wellesley, Auckland 4680,
New Zealand
Tel: 9-634-0099

COUNTRIES AND TRUST

TERRITORIES IN PACIFIC OCEAN

**Yamaha Corporation,
Asia-Pacific Sales & Marketing Group**
Nakazawa-cho 10-1, Naka-ku, Hamamatsu,
Japan 430-8650
Tel: +81-53-460-2313



Yamaha Web Site (English)
<http://www.yamahasyth.com/>
Yamaha Manual Library
<http://www.yamaha.co.jp/manual/>

U.R.G., Digital Musical Instruments Division
© 2011 Yamaha Corporation

111MWXX*-* **B0
Printed in China

WV67970