

# Clavinova<sup>®</sup>

## CLP-110

### Owner's Manual Bedienungsanleitung Mode d'emploi Manual de instrucciones

Before using the Clavinova, be sure to read "PRECAUTIONS," on pages 6-7.  
Achten Sie darauf, vor Einsatz des Clavinova die "VORSICHTSMASSNAHMEN," auf Seite 6-7 durchzulesen.  
Avant d'utiliser le Clavinova, lire attentivement la section «PRECAUTIONS D'USAGE» aux pages 6-7.  
Antes de utilizar el Clavinova, lea las "PRECAUCIONES," que debe tener en cuenta en las páginas 6-7.

#### **IMPORTANT**

##### **Check your power supply**

Make sure that your local AC mains voltage matches the voltage specified on the name plate on the bottom panel. In some areas a voltage selector may be provided on the bottom panel of the main keyboard unit near the power cord. Make sure that the voltage selector is set for the voltage in your area. The voltage selector is set at 240V when the unit is initially shipped. To change the setting use a "minus" screwdriver to rotate the selector dial so that the correct voltage appears next to the pointer on the panel.

#### **WICHTIG**

##### **Überprüfung der Stromversorgung**

Vergewissern Sie sich vor dem Anschließen an das Stromnetz, daß die örtliche Netzspannung den Betriebsspannungswerten auf dem Typenschild an der Unterseite des Instruments entspricht. In bestimmten Verkaufsgebieten ist das Instrument mit einem Spannungswähler an der Unterseite neben der Netzkabeldurchführung ausgestattet. Falls vorhanden, muß der Spannungswähler auf die örtliche Netzspannung eingestellt werden. Der Spannungswähler wurde werkseitig auf 240 V voreingestellt. Zum Verstellen drehen Sie den Spannungsregler mit einem Schlitzschraubendreher, bis der Zeiger auf den korrekten Spannungswert weist.

#### **IMPORTANT**

##### **Contrôler la source d'alimentation**

Vérifiez que la tension spécifiée sur le panneau inférieur correspond à la tension du secteur. Dans certaines régions, l'instrument peut être équipé d'un sélecteur de tension situé sur le panneau inférieur du clavier à proximité du cordon d'alimentation.

Vérifiez que ce sélecteur est bien réglé en fonction de la tension secteur de votre région. Le sélecteur de tension est réglé sur 240 V au départ d'usine. Pour modifier ce réglage, utilisez un tournevis à lame plate pour tourner le sélecteur afin de mettre l'indication correspondant à la tension de votre région vis à vis du repère triangulaire situé sur le panneau.

#### **IMPORTANTE**

##### **Verifique la alimentación de corriente**

Asegúrese de que tensión de alimentación de CA de su área corresponde con la tensión especificada en la placa de características del panel inferior. En algunas zonas puede haberse incorporado un selector de tensión en el panel inferior de la unidad del teclado principal, cerca del cable de alimentación. Asegúrese de que el selector de tensión esté ajustado a la tensión de su área. El selector de tensión se ajusta a 240V cuando la unidad sale de fábrica. Para cambiar el ajuste, emplee un destornillador de cabeza "recta" para girar el selector de modo que aparezca la tensión correcta al lado del indicador del panel.



# SPECIAL MESSAGE SECTION

**PRODUCT SAFETY MARKINGS:** Yamaha electronic products may have either labels similar to the graphics shown below or molded/stamped facsimiles of these graphics on the enclosure. The explanation of these graphics appears on this page. Please observe all cautions indicated on this page and those indicated in the safety instruction section.

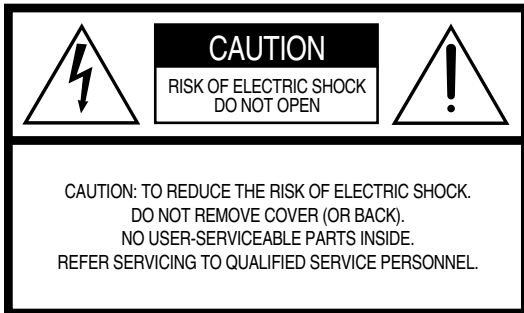

See bottom of Keyboard enclosure for graphic symbol markings.



The exclamation point within the equilateral triangle is intended to alert the user to the presence of important operating and maintenance (servicing) instructions in the literature accompanying the product.

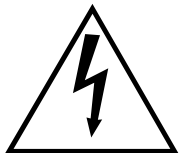

The lightning flash with arrowhead symbol, within the equilateral triangle, is intended to alert the user to the presence of uninsulated “dangerous voltage” within the product’s enclosure that may be of sufficient magnitude to constitute a risk of electrical shock.

**IMPORTANT NOTICE:** All Yamaha electronic products are tested and approved by an independent safety testing laboratory in order that you may be sure that when it is properly installed and used in its normal and customary manner, all foreseeable risks have been eliminated. DO NOT modify this unit or commission others to do so unless specifically authorized by Yamaha. Product performance and/or safety standards may be diminished. Claims filed under the expressed warranty may be denied if the unit is/has been modified. Implied warranties may also be affected.

**SPECIFICATIONS SUBJECT TO CHANGE:** The information contained in this manual is believed to be correct at the time of printing. However, Yamaha reserves the right to change or modify any of the specifications without notice or obligation to update existing units.

**ENVIRONMENTAL ISSUES:** Yamaha strives to produce products that are both user safe and environmentally friendly. We sincerely believe that our products and the production methods used to produce them, meet these goals. In keeping with both the letter and the spirit of the law, we want you to be aware of the following:

**Battery Notice:** This product MAY contain a small non-rechargeable battery which (if applicable) is soldered in place. The average life span of this type of battery is approximately five years. When replacement becomes necessary, contact a qualified service representative to perform the replacement.

**Warning:** Do not attempt to recharge, disassemble, or incinerate this type of battery. Keep all batteries away from children. Dispose of used batteries promptly and as regulated by applicable laws. Note: In some areas, the servicer is required by law to return the defective parts. However, you do have the option of having the servicer dispose of these parts for you.

**Disposal Notice:** Should this product become damaged beyond repair, or for some reason its useful life is considered to be at an end, please observe all local, state, and federal regulations that relate to the disposal of products that contain lead, batteries, plastics, etc.

**NOTICE:** Service charges incurred due to lack of knowledge relating to how a function or effect works (when the unit is operating as designed) are not covered by the manufacturer’s warranty, and are therefore the owners responsibility. Please study this manual carefully and consult your dealer before requesting service.

**NAME PLATE LOCATION:** The graphic below indicates the location of the name plate. The model number, serial number, power requirements, etc., are located on this plate. You should record the model number, serial number, and the date of purchase in the spaces provided below and retain this manual as a permanent record of your purchase.

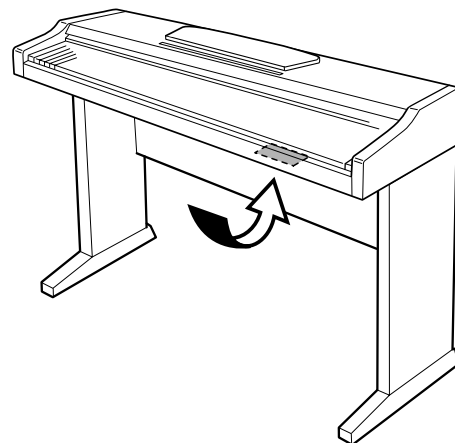

**Model** \_\_\_\_\_

**Serial No.** \_\_\_\_\_

**Purchase Date** \_\_\_\_\_

# Clavinova®



Thank you for purchasing the Yamaha Clavinova! We recommend that you read this manual carefully so that you can fully take advantage of the advanced and convenient functions of the Clavinova.

We also recommend that you keep this manual in a safe and handy place for future reference.

## About this Owner's Manual

---

This manual consists of three main sections: "Introduction," "Reference" and "Appendix."

### ■ Introduction (page 2):

Please read this section first.

### ■ Reference (page 13):

This section explains how to make detailed settings for the Clavinova's various functions.

### ■ Appendix (page 33):

This section introduces reference material.

- \* The model CLP-110 will be referred to as the CLP/Clavinova in this Owner's Manual.
- \* The illustrations of the controls in this owner's manual are for instructional purposes only and actual appearance of the controls may be somewhat different on your instrument.

### COPYRIGHT NOTICE

This product incorporates and bundles computer programs and contents in which Yamaha owns copyrights or with respect to which it has license to use others' copyrights. Such copyrighted materials include, without limitation, all computer software, MIDI files and WAVE data. Any unauthorized use of such programs and contents outside of personal use is not permitted under relevant laws. Any violation of copyright has legal consequences. DON'T MAKE, DISTRIBUTE OR USE ILLEGAL COPIES.

### Trademarks:

- Apple and Macintosh are trademarks of Apple Computer, Inc.
- Windows is a registered trademark of Microsoft® Corporation.
- All other trademarks are the property of their respective holders.

"The Clavinova-Computer Connection," is a supplementary guidebook that describes, for beginners, what you can do with your Clavinova and a personal computer and how to set up a Clavinova-Computer system (the manual is not written for any specific models). The document is available as a PDF file (in English) at the following Internet address:

#### Clavinova Web site (English only):

<http://www.yamahaclavinova.com/>

#### Yamaha Manual Library:

<http://www2.yamaha.co.jp/manual/english/>

# Table of Contents

---

## Introduction

SPECIAL MESSAGE SECTION .....	2
About this Owner's Manual .....	3
Application Index.....	5
PRECAUTIONS.....	6
Accessories .....	8
Maintenance .....	8
Features.....	9
Before Using the Clavinova .....	10
Key Cover .....	10
Music Rest .....	10
Turning the Power On.....	11
Setting the Volume.....	11
Using Headphones.....	12

## Reference

Part Names.....	14
Listening to the Demo Songs .....	15
Listening to 50 Piano Preset Songs .....	16
Selecting & Playing Voices.....	17
Selecting Voices.....	17
Using the Damper Pedal.....	17
Adding Variations to the Sound – Reverb.....	18
Combining Two Voices (Dual mode).....	19
Transposition .....	20
Fine-tuning the Pitch .....	20
Using the Metronome.....	21
About MIDI .....	23
Connecting a Personal Computer .....	24
MIDI Functions.....	26
MIDI Transmit/Receive Channel Selection.....	26
Local Control ON/OFF.....	26
Program Change ON/OFF.....	27
Control Change ON/OFF .....	27
Troubleshooting .....	28
Options.....	28
Keyboard Stand Assembly .....	29
Index .....	31

## Appendix

MIDI Data Format / MIDI-Datenformat / Format des données MIDI / Formato de datos MIDI .....	34
MIDI Implementation Chart .....	38
Specifications / Technische Daten / Caractéristiques techniques / Especificaciones .....	39

# Application Index

---

Use this index to find reference pages that may be helpful for your particular application and situation.

## Listening

---

- Listening to demo songs with different voices..... “Listening to the Demo Songs” on page 15  
Listening to songs from “50 Greats for the Piano” ..... “Listening to 50 Piano Preset Songs” on page 16

## Playing

---

- Using the damper pedal ..... “Using the Damper Pedal” on page 17  
Playing an accompaniment that matches pitch ..... “Transposition” on page 20  
Fine-tuning the pitch of the entire instrument when you play the Clavinova  
along with other instruments or CD music..... “Fine-tuning the Pitch” on page 20

## Changing voices

---

- Viewing the list of voices..... “Selecting Voices” on page 17  
Simulating a concert hall ..... “Adding Variations to the Sound – Reverb” on page 18  
Combining two voices..... “Combining Two Voices (Dual mode)” on page 19

## Practicing

---

- Practicing with an accurate and steady tempo ..... “Using the Metronome” on page 21

## Connecting the Clavinova to other devices

---

- What is MIDI? ..... “About MIDI” on page 23  
Connecting the computer ..... “Connecting a Personal Computer” on page 24

## Assembling

---

- Assembling and disassembling the Clavinova ..... “Keyboard Stand Assembly” on pages 29–30

# PRECAUTIONS

## PLEASE READ CAREFULLY BEFORE PROCEEDING

\* Please keep this manual in a safe place for future reference.



### WARNING

Always follow the basic precautions listed below to avoid the possibility of serious injury or even death from electrical shock, short-circuiting, damages, fire or other hazards. These precautions include, but are not limited to, the following:

#### Power supply/Power cord

- Only use the voltage specified as correct for the instrument. The required voltage is printed on the name plate of the instrument.
- Check the electric plug periodically and remove any dirt or dust which may have accumulated on it.
- Use only the supplied power cord/plug.
- Do not place the power cord near heat sources such as heaters or radiators, and do not excessively bend or otherwise damage the cord, place heavy objects on it, or place it in a position where anyone could walk on, trip over, or roll anything over it.

#### Do not open

- Do not open the instrument or attempt to disassemble the internal parts or modify them in any way. The instrument contains no user-serviceable parts. If it should appear to be malfunctioning, discontinue use immediately and have it inspected by qualified Yamaha service personnel.

#### Water warning

- Do not expose the instrument to rain, use it near water or in damp or wet conditions, or place containers on it containing liquids which might spill into any openings.
- Never insert or remove an electric plug with wet hands.

#### Fire warning

- Do not put burning items, such as candles, on the unit. A burning item may fall over and cause a fire.

#### If you notice any abnormality

- If the power cord or plug becomes frayed or damaged, or if there is a sudden loss of sound during use of the instrument, or if any unusual smells or smoke should appear to be caused by it, immediately turn off the power switch, disconnect the electric plug from the outlet, and have the instrument inspected by qualified Yamaha service personnel.



### CAUTION

Always follow the basic precautions listed below to avoid the possibility of physical injury to you or others, or damage to the instrument or other property. These precautions include, but are not limited to, the following:

#### Power supply/Power cord

- When removing the electric plug from the instrument or an outlet, always hold the plug itself and not the cord. Pulling by the cord can damage it.
- Remove the electric plug from the outlet when the instrument is not to be used for extended periods of time, or during electrical storms.
- Do not connect the instrument to an electrical outlet using a multiple-connector. Doing so can result in lower sound quality, or possibly cause overheating in the outlet.

#### Assembly

- Read carefully the attached documentation explaining the assembly process. Failure to assemble the instrument in the proper sequence might result in damage to the instrument or even injury.

#### Location

- Do not expose the instrument to excessive dust or vibrations, or extreme cold or heat (such as in direct sunlight, near a heater, or in a car during the day) to prevent the possibility of panel disfiguration or damage to the internal components.
- Do not use the instrument in the vicinity of a TV, radio, stereo equipment, mobile phone, or other electric devices. Otherwise, the instrument, TV, or radio may generate noise.
- Do not place the instrument in an unstable position where it might accidentally fall over.
- Before moving the instrument, remove all connected cables.
- Do not place the instrument against a wall (allow at least 3 cm/ one-inch from the wall), since this can cause inadequate air circulation, and possibly result in the instrument overheating.

## Connections

- Before connecting the instrument to other electronic components, turn off the power for all components. Before turning the power on or off for all components, set all volume levels to minimum. Also, be sure to set the volumes of all components at their minimum levels and gradually raise the volume controls while playing the instrument to set the desired listening level.

## Maintenance

- When cleaning the instrument, use a soft, dry or slightly damp cloth. Do not use paint thinners, solvents, cleaning fluids, or chemical-impregnated wiping cloths.

## Handling caution

- Take care that the key cover does not pinch your fingers, and do not insert a finger or hand in any gaps on the key cover or instrument.
- Never insert or drop paper, metallic, or other objects into the gaps on the key cover, panel or keyboard. If this happens, turn off the power immediately and unplug the power cord from the AC outlet. Then have the instrument inspected by qualified Yamaha service personnel.
- Do not place vinyl, plastic or rubber objects on the instrument, since this might discolor the panel or keyboard.
- Do not rest your weight on, or place heavy objects on the instrument, and do not use excessive force on the buttons, switches or connectors.
- Do not operate the instrument for a long period of time at a high or uncomfortable volume level, since this can cause permanent hearing loss. If you experience any hearing loss or ringing in the ears, consult a physician.

## Using the bench (If included)

- Do not place the bench in an unstable position where it might accidentally fall over.
- Do not play carelessly with or stand on the bench. Using it as a tool or step-ladder or for any other purpose might result in accident or injury.
- Only one person should sit on the bench at a time, in order to prevent the possibility of accident or injury.
- If the bench screws become loose due to extensive long-term use, tighten them periodically using the included tool.

Yamaha cannot be held responsible for damage caused by improper use or modifications to the instrument, or data that is lost or destroyed.

Always turn the power off when the instrument is not in use.

# Accessories

---

- “50 Greats for the Piano” (Music Book)
- Owner’s Manual  
This manual contains complete instructions for operating your Clavinova.
- Quick Operation Guide
- Bench  
A bench may be included or optional, depending on your locale.
- Damper pedal

# Maintenance

---

Clean the instrument using a dry or slightly damp soft cloth (wring well).

## **CAUTION**

Do not use benzene, thinner, detergent, or chemically-treated cloth for cleaning. Do not place vinyl, plastic or rubber products on the instrument.

Otherwise, the panel or keys may become discolored or degraded.

## **CAUTION**

Before using the Clavinova, be sure to read “Precautions” on pages 6 – 7.

## ■ **Tuning**

Unlike an acoustic piano, the Clavinova does not need to be tuned. It always stays perfectly in tune.

## ■ **Transporting**

If you move to another location, you can transport the Clavinova along with your other belongings. You can move the unit as it is (assembled) or you can disassemble the unit before moving.

Transport the keyboard horizontally. Do not lean it up against a wall or stand it up on its side. Do not subject the instrument to excessive vibration or shock.



# Features

The Yamaha Clavinova CLP-110 digital piano offers unmatched sonic realism and natural grand-piano type playability as well as Yamaha's original "AWM Stereo Sampling" tone-generation technology for rich, musical voices, and a special "Graded Hammer" keyboard that provides graded key weight and response throughout the keyboard range.

The Grand Piano 1 and 2 voices feature totally new samples painstakingly recorded from a full concert grand piano. The E. Piano 1 voice features a single velocity-switched sample (Dynamic Sampling) and E. Piano 2 voice features two velocity-switched sample.

The CLP-110 sounds much closer to a true acoustic piano.

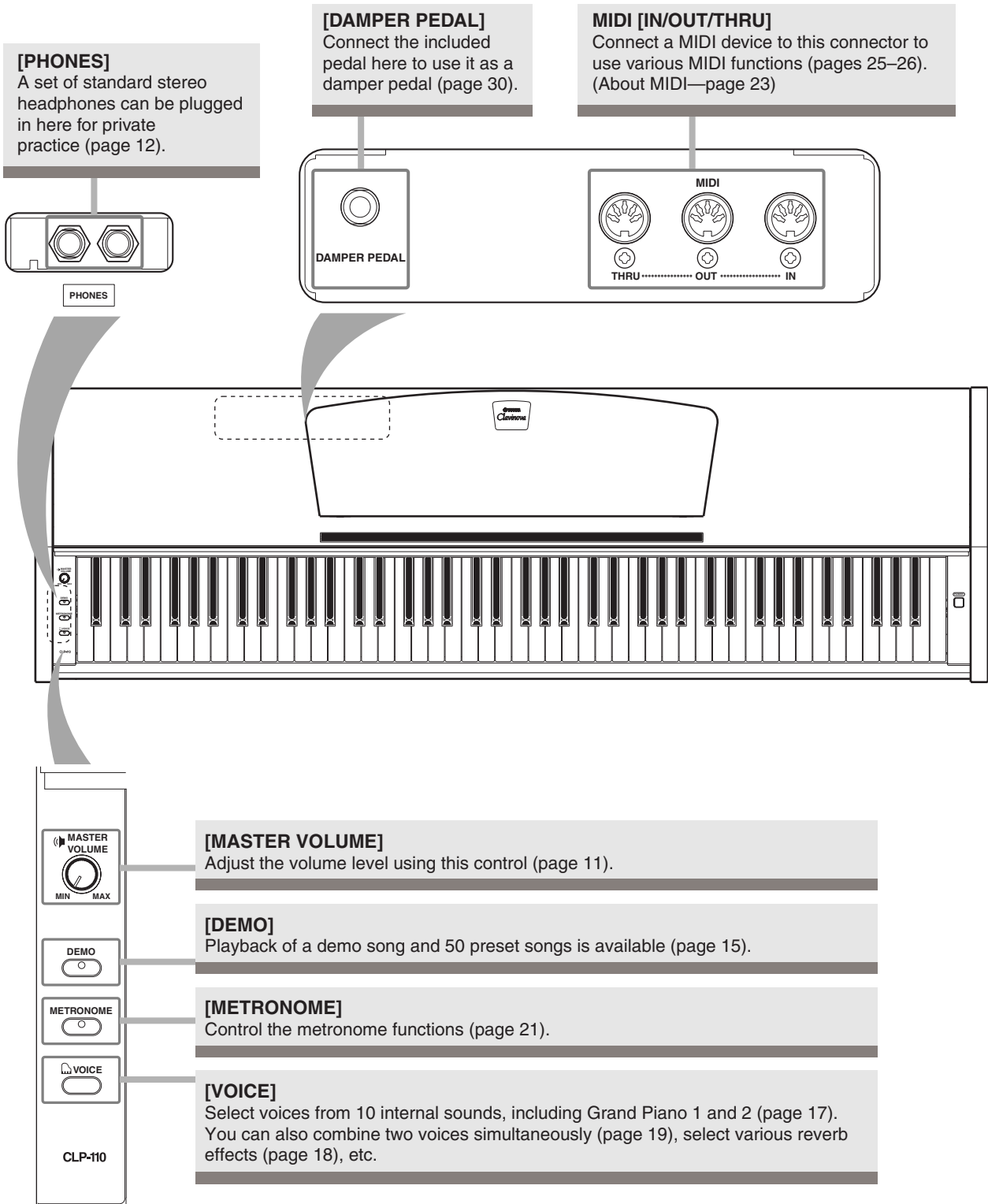

# Before Using the Clavinova

## Key Cover

### To open the key cover:

Lift the cover slightly, then push and slide it open.

### To close the key cover:

Slide the cover toward you and gently lower the cover over the keys.



### ⚠ CAUTION

Hold the cover with both hands when opening or closing it. Do not release it until it is fully opened or closed. Be careful to avoid catching fingers (yours or others, especially children's) between the cover and main unit.

### ⚠ CAUTION

Do not place objects, such as a piece of metal or paper, on top of the key cover. Small objects placed on the key cover may fall inside the unit when the cover is opened and may be nearly impossible to remove. This could cause electric shock, short circuit, fire or other serious damage to the instrument.

## Music Rest

### To raise the music rest:

1. Pull the music rest up and toward yourself as far as it will go.
2. Flip down the two metal supports at the left and right on the rear of the music rest.
3. Lower the music rest so that it rests on the metal supports.

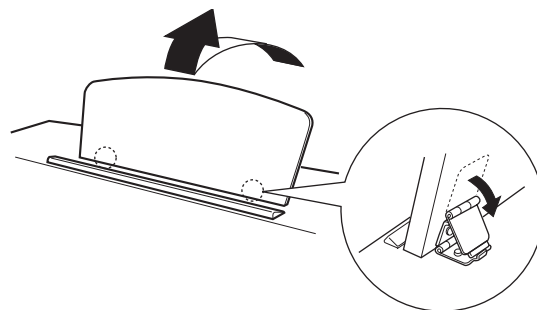

### To lower the music rest:

1. Pull the music rest toward yourself as far as it will go.
2. Raise the two metal supports (at the rear of the music rest).
3. Gently lower the music rest backward until it is all the way down.

### ⚠ CAUTION

Do not try to use the music rest in a half-raised position. When lowering the music rest, do not release your hands from the music rest until it is all the way down.

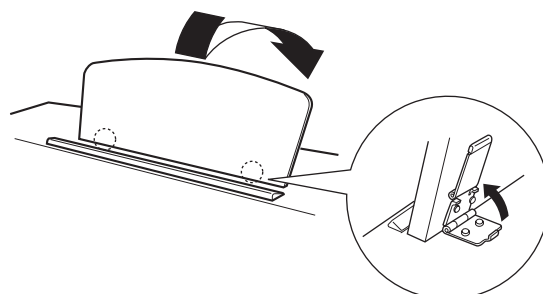

# Turning the Power On

## 1. Connect the power cord.

Insert the plugs at the ends of the cord: one into the AC INLET on the Clavinova, and the other into a standard AC outlet.

In some areas, a plug adaptor may be provided to match the pin configuration of AC wall outlets in your area.

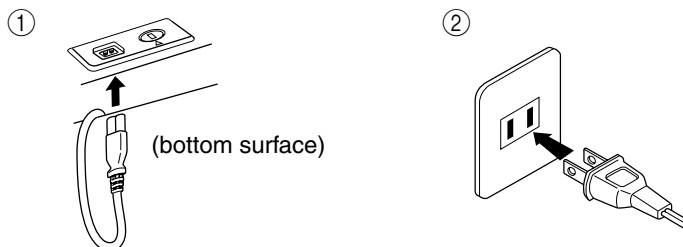

(The shape of the plug differs depending on locale.)

## 2. Turn the power on.

Press the **[POWER]** button.

- The power indicator located below the left end of the keyboard lights up.

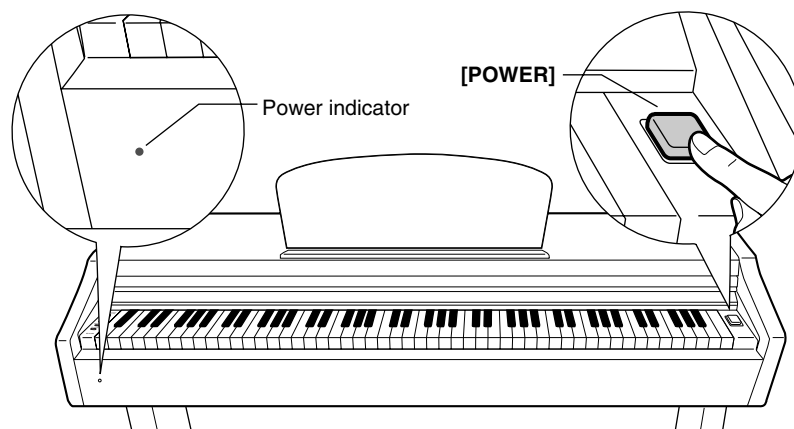

When you're ready to turn off the power, press the **[POWER]** button again.

- The power indicator turns off.

### TIP

#### Power indicator

If you close the key cover without turning the power off, the power indicator remains lit, indicating that the power is still on.

# Setting the Volume

When you start playing, adjust the **[MASTER VOLUME]** control to the most comfortable listening level.

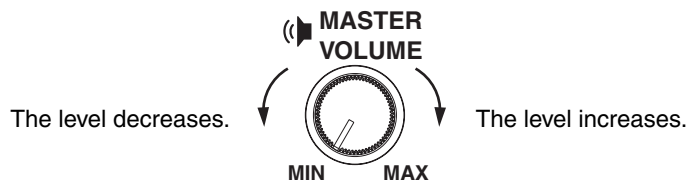

### CAUTION

Do not use the Clavinova at a high volume level for a long period of time, or your hearing may be damaged.

### TERMINOLOGY

#### MASTER VOLUME:

The volume level of the entire keyboard sound

### TIP

You can also adjust the **[PHONES]** output level using the **[MASTER VOLUME]** control.

# Using Headphones

Connect a pair of headphones to one of the **[PHONES]** jacks.

Two **[PHONES]** jacks are provided.

You can connect two sets of standard stereo headphones. (If you are using only one pair of headphones, you can plug them into either jack.)

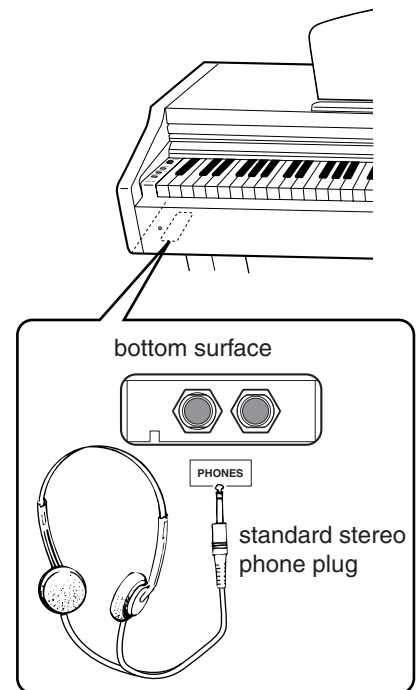

## Using the Headphone Hanger

A headphone hanger is included in the CLP-110 package so that you can hang the headphones on the Clavinova. Install the headphone hanger using the included two screws ( $4 \times 10\text{mm}$ ) as shown in the figure.

### CAUTION

Do not hang anything other than the headphones on the hanger. Otherwise, the Clavinova or the hanger may be damaged.

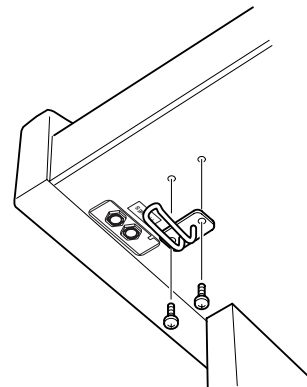

# Reference

This section explains how to make detailed settings for the Clavinova's various functions.

---

Part Names.....	14
Listening to the Demo Songs.....	15
Listening to 50 Piano Preset Songs.....	16
Selecting & Playing Voices .....	17
Selecting Voices .....	17
Using the Damper Pedal .....	17
Adding Variations to the Sound – Reverb.....	18
Combining Two Voices (Dual mode).....	19
Transposition.....	20
Fine-tuning the Pitch .....	20
Using the Metronome.....	21
About MIDI.....	23
Connecting a Personal Computer .....	24
MIDI Functions.....	26
MIDI Transmit/Receive Channel Selection .....	26
Local Control ON/OFF.....	26
Program Change ON/OFF .....	27
Control Change ON/OFF .....	27
Troubleshooting .....	28
Options .....	28
Keyboard Stand Assembly.....	29
Index .....	31

# Part Names

## Top panel (CLP-110)

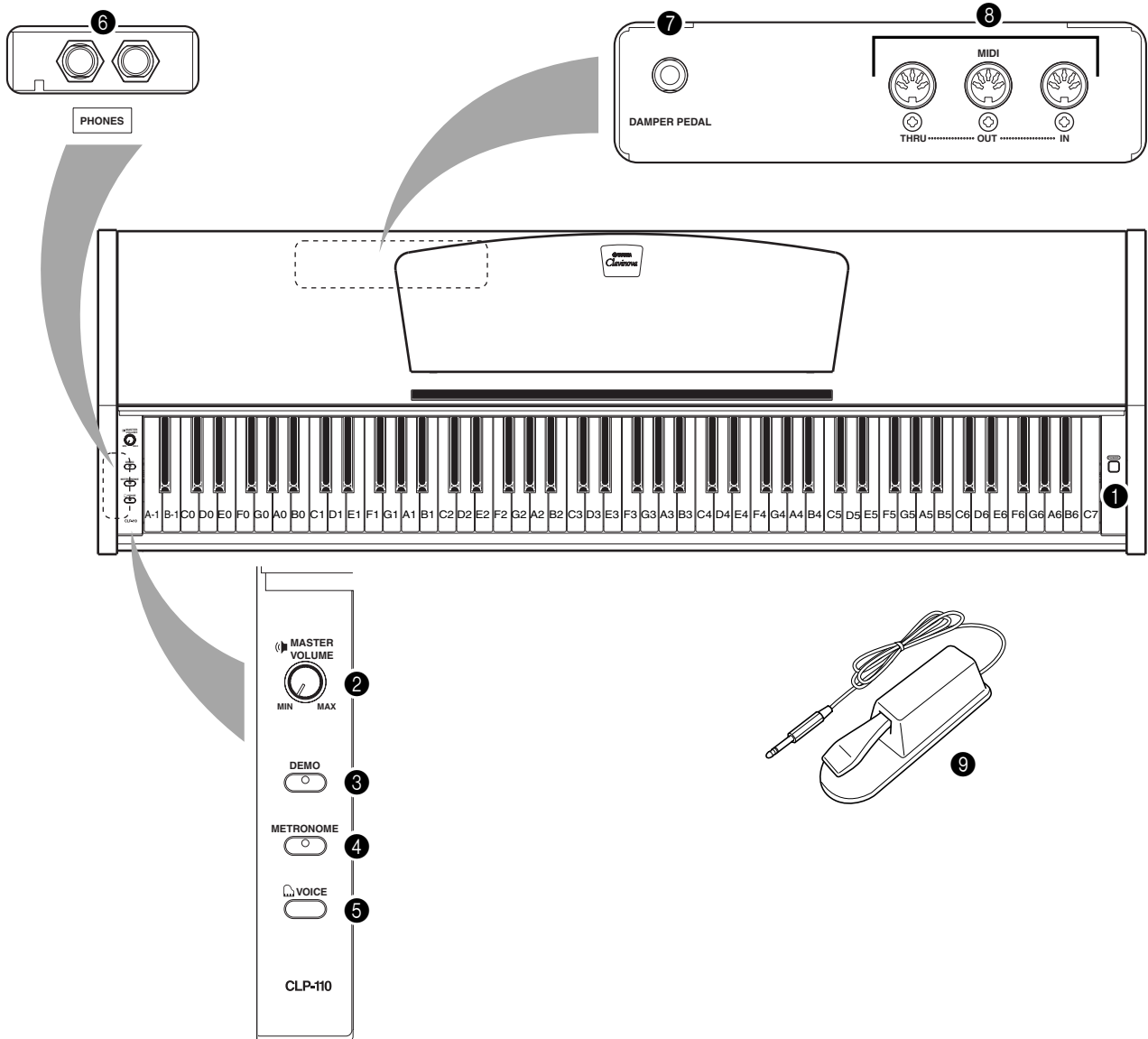

- ❶ [POWER] ..... P11
- ❷ [MASTER VOLUME] ..... P11
- ❸ [DEMO] ..... P15
- ❹ [METRONOME]..... P21
- ❺ [VOICE].....P17-19

- ❻ [PHONES] ..... P12
- ❼ [DAMPER PEDAL] ..... P17, 30
- ❽ MIDI [IN] [OUT] [THRU]..... P23
- ❾ Damper pedal..... P17, 30

# Listening to the Demo Songs

Demo songs are provided that effectively demonstrate each of the CLP-110's voices.

## Procedure

### 1. Turn on the power.

(In case the power is not turned ON) Press the [POWER] button.

When you start playing, adjust the [MASTER VOLUME] control to the most comfortable listening level.

### 2. Engage Demo mode.

Press the [DEMO] button to engage Demo mode. The [DEMO] button indicator will light.

### 3. Play a Voice demo.

While holding down the [DEMO] button, press one of the C1–A1 keys to select and start the corresponding demo song. Starting with the selected tune, the demo songs will play in sequence until stopped.

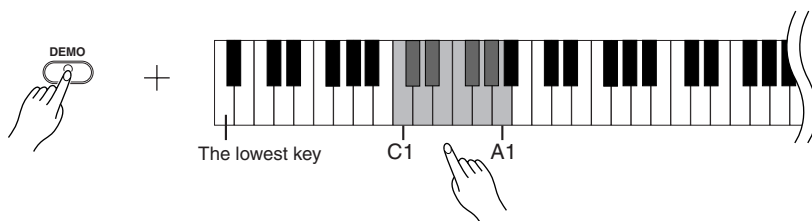

#### Demo Song List

Demo songs are original (©2002 Yamaha Corporation) except for the three songs listed below.

Refer to the voice list on page 17 for voice key assignments.

The demo songs listed below are short re-arranged excerpts from the original compositions.

Key	Voice Name	Title	Composer
C1	GrandPiano1	Consolation No.3	F. Liszt
E1	Harpsichord1	Gavotte	J.S. Bach
F1	Harpsichord2	Invention No.1	J.S. Bach

#### Adjusting the Volume

Use the [MASTER VOLUME] control to adjust the volume.

### 4. Stop the Voice demo.

Press the [DEMO] button to stop playback.

#### NOTE

Refer to the voice list on page 17 for more information on the characteristics of each pre-set voice.

#### TERMINOLOGY

##### Mode:

A mode is a condition or status under which you can execute a certain function. In Demo mode, you can play back demo songs.

#### NOTE

You cannot adjust the tempo of demo songs.

# Listening to 50 Piano Preset Songs

The Clavinova provides performance data for 50 piano songs. You can simply listen to these songs. You can also refer to the included "50 Greats for the Piano" that contains scores for 50 piano preset songs.

## Procedure

### 1. Engage Preset Song mode.

Press the [DEMO] button to engage Preset Song mode. The [DEMO] button indicator will light.

### 2. Play a preset song.

While holding down the [DEMO] button, press one of the C2–C#6 keys to select and start the corresponding tune. To play all preset songs in sequence, while holding down the [DEMO] button, press the D6 key.

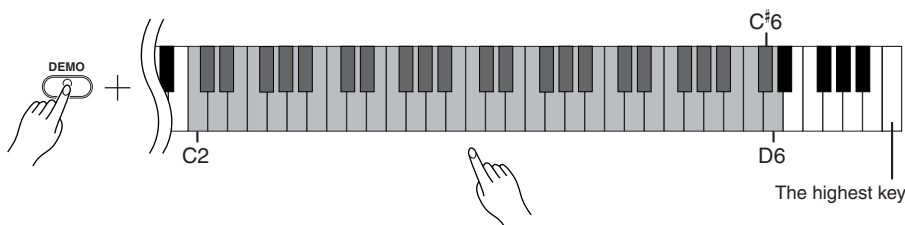

#### Adjusting the Volume

Use the [MASTER VOLUME] control to adjust the volume.

### 3. Stop playback.

Playback will stop automatically when the selected preset song has finished. To stop the song during playback (or continuous playback), press the [DEMO] button.

- To continue playing other songs, see procedure 2 above.

#### TERMINOLOGY

##### Song:

On the CLP-110, performance data is called a "Song." This includes demo songs and piano preset tunes.

#### TIP

You can play the keyboard along with the preset song. You can change the voice playing on the keyboard.

#### TIP

You can adjust the Reverb type (page 18) that is applied to the voice you play on the keyboard and to the preset song playback.

#### NOTE

The default tempo is automatically selected whenever a new preset song is selected, and when a new preset song begins playback.

#### NOTE

To adjust the tempo of the preset song playback, see page 21.

#### NOTE

When you select a different song (or a different song is selected during chained playback), an appropriate reverb type will be selected accordingly.

#### NOTE

MIDI reception is not possible in Piano Song mode. Piano song data is not transmitted via the MIDI connectors.



# Selecting & Playing Voices

## Selecting Voices

### Procedure

While holding down the [VOICE] button, press one of the C1–A1 keys to select and start the corresponding voice.

Then, when you start playing, adjust the [MASTER VOLUME] control to the most comfortable listening level.

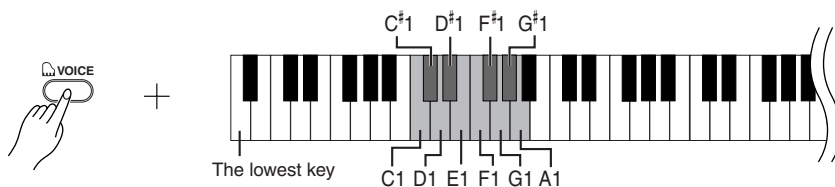

Key	Voice Name	Description
C1	Grand Piano 1	Recorded samples from a full concert grand piano. Perfect for classical compositions as well as any other style that requires acoustic piano.
C <sup>♯</sup> 1	Grand Piano 2	Spacious and clear piano with bright reverb. Good for popular music.
D1	E.Piano 1	An electronic piano sound created by FM synthesis. Good for popular music.
D <sup>♯</sup> 1	E.Piano 2	The sound of an electric piano using hammer-struck metallic “tines.” Soft tone when played lightly, and an aggressive tone when played hard.
E1	Harpsichord 1	The definitive instrument for baroque music. Since harpsichord uses plucked strings, there is no touch response.
F1	Harpsichord 2	Mixes the same voice an octave higher for a more brilliant tone.
F <sup>♯</sup> 1	Vibraphone	Vibraphone played with relatively soft mallets. It has a tremolo effect that is typical for vibraphone.
G1	Church Organ 1	This is a typical pipe organ sound (8 feet + 4 feet + 2 feet). Good for sacred music from the Baroque period.
G <sup>♯</sup> 1	Church Organ 2	This is the organ’s full coupler sound, often associated with Bach’s “Toccatina and Fugue”.
A1	Strings	Spacious and large-scale string ensemble. Try combining this voice with piano in DUAL mode.

## Using the Damper Pedal

You can connect the damper pedal to the Clavinova (page 30).

The damper pedal functions in the same way as a damper pedal on an acoustic piano. When the damper pedal is pressed, notes sustain longer. Releasing the pedal immediately stops (damps) any sustained notes.

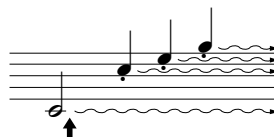

When you press the damper pedal here, the notes you play before you release the pedal sustain longer.

### TIP

To understand the characteristics of various voices, listen to demo songs for each voice (page 15).

### TERMINOLOGY

#### Voice:

On the Clavinova, a voice means a “tone” or “tonal color.”

### NOTE

Selecting a voice automatically engages the best-suited reverb type and depth (page 18) for that particular voice.

### NOTE

If the damper pedal doesn’t work, make sure that the pedal cord is properly plugged into the main unit (page 30).

### NOTE

Make sure that the damper pedal is not pressed when you turn on the power to the unit, connect or disconnect the pedal.

### NOTE

Make sure that power is OFF when connecting or disconnecting the pedal.

# Adding Variations to the Sound – Reverb

This control enables you to select various digital reverb effects that add extra depth and expression to the sound to create a realistic acoustic ambience.

## Procedure

When you select a reverb, the reverb is automatically turned on. While holding down the **[VOICE]** button, press one of the C2–E2 keys to select a reverb type.

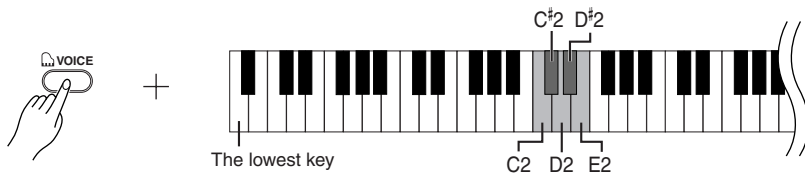

Key	Reverb Type	Description
C2	Room	This setting adds a continuous reverb effect to the sound, similar to the acoustic reverberation you would hear in a room.
C#2	Hall1	For a “bigger” reverb sound, use the HALL 1 setting. This effect simulates the natural reverberation of a small-size concert hall.
D2	Hall2	For a truly spacious reverb sound, use the HALL 2 setting. This effect simulates the natural reverberation of a large concert hall.
D#2	Stage	Simulates the reverb of a stage environment.
E2	Off	No effect is applied.

## Adjusting Reverb Depth

Adjust the reverb depth for the selected voice by pressing one of the C3–G#4 keys while holding down the **[VOICE]** button. The depth range is from 0 through 20.

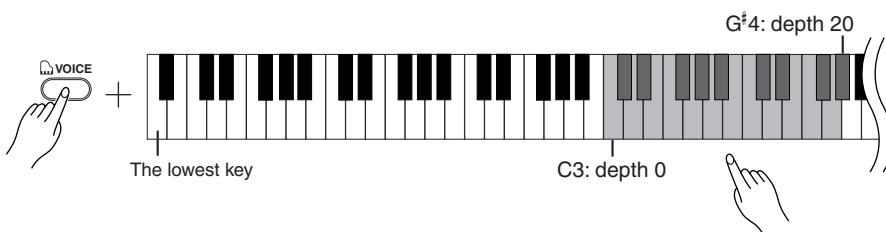

The depth value increases as you press higher keys.

### TIP

The default reverb type (including OFF) and depth settings are different for each voice.

### TIP

depth 0: no effect  
depth 20: maximum reverb depth

# Combining Two Voices (Dual mode)

You can play two voices simultaneously across the entire range of the keyboard. In this way, you can simulate a melody duet or combine two similar voices to create a thicker sound.

## Procedure

### 1. Engage Dual mode.

While holding down the [VOICE] button, press two of the C1–A1 keys at simultaneously (or press one key while holding another). Refer to the voice list on page 17 for available voices.

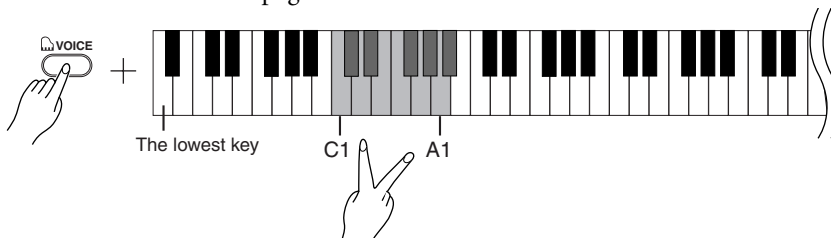

According to the voice priority shown in the voice list (page 17), the voice assigned to the lower keyboard will be designated as Voice 1 (the other voice will be designated as Voice 2).

You can make the following settings only in Dual mode:

#### Setting the Octave

You can shift the pitch up and down in octave steps for Voice 1 and Voice 2 independently. Depending on which voices you combine in Dual mode, the combination may sound better if one of the voices is shifted up or down an octave.

While holding down the [VOICE] button, press one of the C5–F5 keys.

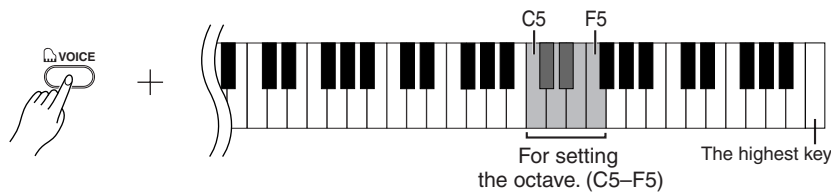

C5 key: -1 (Voice 1), C#5 key: 0 (Voice 1), D5 key: +1 (Voice 1),  
D#5 key: -1 (Voice 2), E5 key: 0 (Voice 2), F5 key: +1 (Voice 2)

#### Setting the Balance

You can set one voice as the main voice, and another voice as a softer, mixed voice.

While holding down the [VOICE] button, press one of the F#5–F#6 keys. A setting of “0” produces an equal balance between the two Dual mode voices. Settings below “0” increases the volume of Voice 2 in relation to Voice 1, and settings above “0” increases the volume of Voice 1 in relation to Voice 2.

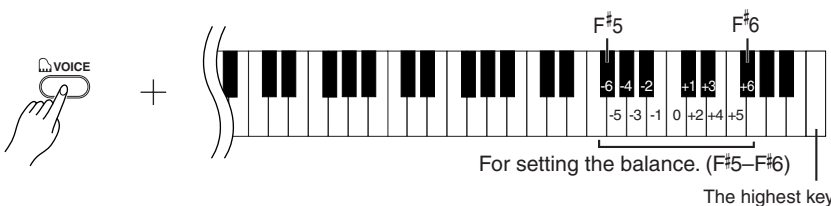

#### NOTE

You cannot assign the same voice to Voice 1 and Voice 2 simultaneously in Dual mode.

#### TIP

##### Reverb in Dual Mode

The reverb type assigned to Voice 1 will take priority over the other. (If the reverb is set to OFF, Voice 2 reverb type will be in effect.) Reverb depth setting (page 18) will be applied only to Voice 1.

### 2. Exit Dual mode and return to normal play mode.

While holding down the [VOICE] button, press one of the C1–A1 keys.

# Transposition

The Clavinova's Transpose function makes it possible to shift the pitch of the entire keyboard up or down in semitone intervals up to a maximum of six semitones, and lets you easily match the pitch of the keyboard to the range of a singer or other instruments.

For example, if you set the transposition amount to "5," playing key C produces pitch F. In this way, you can play a song as though it were in C major, and the Clavinova will transpose it to the key of F.

## Procedure

While holding down the A-1 and C#0 keys, press one of the F#2-F#3 keys to set the desired amount of transposition.

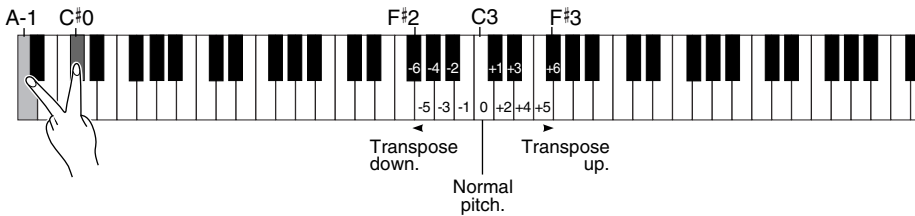

Pressing the C3 key produces normal keyboard pitch. Pressing the key to the left of C3 (=B2) transposes the pitch of the keyboard down a semitone, the next key to the left (=Bb2) transposes down a whole tone (two semitones), etc., down to the F#2 key, which transposes down six semitones. Upward transposition is accomplished in the same way using the keys to the right of C3, up to F#3, which transposes up six semitones.

## Fine-tuning the Pitch

You can fine-tune the pitch of the entire instrument. This function is useful when you play the Clavinova along with other instruments or CD music.

## Procedure

### To tune up (in about 0.2Hz steps):

Hold down the A-1 and B-1 keys simultaneously and press any key between C3 and B3.

### To tune down (in about 0.2Hz steps):

Hold down the A-1 and A#-1 keys simultaneously and press any key between C3 and B3.

### To restore standard pitch:

Hold down the A-1, A#-1 and B-1 simultaneously and press any key between C3 and B3.

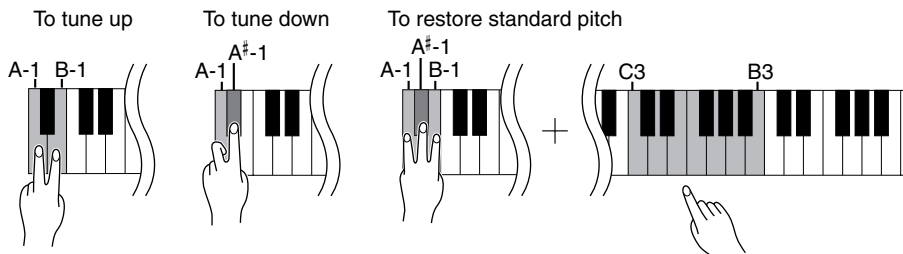

Setting range: 427.0-453.0 Hz

Standard pitch: 440.0 Hz

## TERMINOLOGY

### Transpose:

Changing the key signature of a song. On the Clavinova, transposing shifts the pitch of the entire keyboard.

## TIP

Notes below and above the A-1 .... C7 range of the CLP-110 sound one octave higher and lower, respectively.

## TERMINOLOGY

### Hz (Hertz):

This unit of measurement refers to the frequency of a sound and represents the number of times a sound wave vibrates in a second.

# Using the Metronome

The Clavinova features a built-in metronome (a device that keeps an accurate tempo) that is convenient for practicing.

## Procedure

### 1. Start the metronome.

Press the [METRONOME] button to turn on the metronome.

#### Determines the time signature

While holding down the [METRONOME] button, press one of the C3–F3 keys.



C3 key: No downbeat, C#3 key: 2/4, D3 key: 3/4, D#3 key: 4/4, E3 key: 5/4, F3 key: 6/4

#### Adjusting the tempo

The tempo of the metronome and preset song playback can be set from 32 to 280 beats per minute.

While holding down the [METRONOME] button, press a sequence of C4–A4 keys to specify a three-digit number.

Select a number starting from the left-most digit. For example, to set the tempo “95,” press the C4 (0), A4 (9) and F4 (5) keys in sequence.

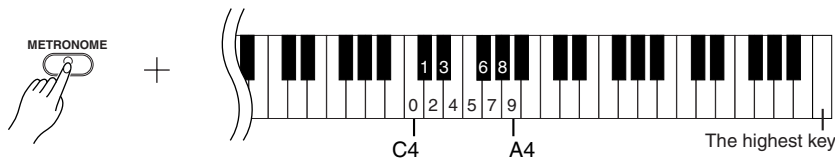

To increase the tempo value in steps of one, while holding down the [METRONOME] button, press the C#5 key. To decrease the tempo value in steps of one, while holding down the [METRONOME] button, press the B4 key.

To increase the tempo value in steps of ten, while holding down the [METRONOME] button, press the D5 key. To decrease the tempo value in steps of ten, while holding down the [METRONOME] button, press the A#4 key.

To set the default tempo (the metronome’s original tempo or the song’s original tempo), while holding down the [METRONOME] button, press the C5 key.



#### NOTE

During preset song playback, you can set the tempo from 20 to 400 beats per minute, depending on the song data.

### Adjusting the volume

You can change the volume of the metronome sound.

While holding down the **[METRONOME]** button, press one of the C1–G2 keys to determine the volume.

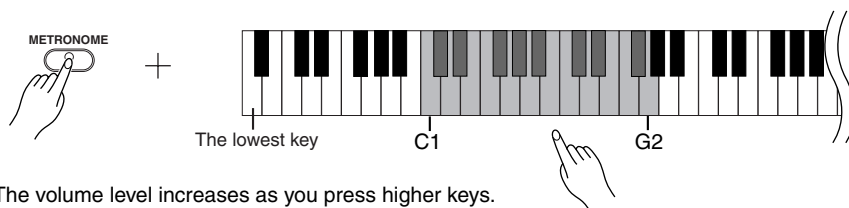

The volume level increases as you press higher keys.

## 2. Stop the metronome.

Turn off the metronome by pressing the **[METRONOME]** button.

# About MIDI

MIDI (Musical Instrument Digital Interface) is a standard format for data transmission and reception. It enables the transfer of performance data and commands between MIDI devices and personal computers. Using MIDI, you can control a connected MIDI device from the Clavinova, or control the Clavinova from a connected MIDI device or computer.

## MIDI connectors

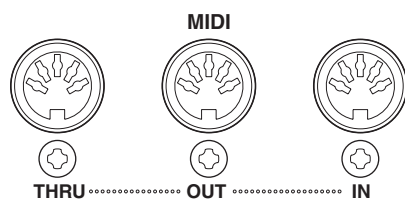

**MIDI [IN]:** Receives MIDI data.

**MIDI [OUT]:** Transmits MIDI data.

**MIDI [THRU]:** Transmits data received at the MIDI [IN] connector, passing it through the unit unmodified.

## MIDI cables

Prepare dedicated MIDI cables.

### **TIP**

MIDI performance data and commands are transferred in the form of numeric values.

### **TIP**

Since MIDI data that can be transmitted or received varies depending on the type of MIDI device, check the "MIDI Implementation Chart" to find out what MIDI data and commands your devices can transmit or receive. The Clavinova's MIDI Implementation Chart appears on page 38.

### **TIP**

You can also obtain detailed information about MIDI from various music books and other publications.

# Connecting a Personal Computer

---

You can enjoy computer music data on the Clavinova by connecting a computer to the MIDI jack.

**NOTE**

When the Clavinova is used as a tone module, performance data with voices that are not found on the Clavinova will not be played correctly.

**“The Clavinova-Computer Connection,”** is a supplementary guidebook that describes, for beginners, what you can do with your Clavinova and a personal computer and how to set up a Clavinova-Computer system (the manual is not written for a specific model). The document is available as a PDF file (in English) at the following Internet address:

**Clavinova Web site (English only):**

<http://www.yamahaclavinova.com/>

**Yamaha Manual Library:**

<http://www2.yamaha.co.jp/manual/english/>

**There are two methods by which to connect the Clavinova to a personal computer:**

1. Use a MIDI interface and the Clavinova’s MIDI connectors (page 25).
2. Use the USB port on the computer and a USB interface (model UX256, UX96, or UX16) (page 25).

**NOTE**

Before you connect the Clavinova to a personal computer, first turn off the power to both the Clavinova and the computer. After you make the connections, turn on the power to the computer first, then turn on the power to the Clavinova.



# 1. Using a MIDI interface and the Clavinova's MIDI connectors

## Connection

Use a MIDI interface to connect a computer to the Clavinova using special MIDI cables.

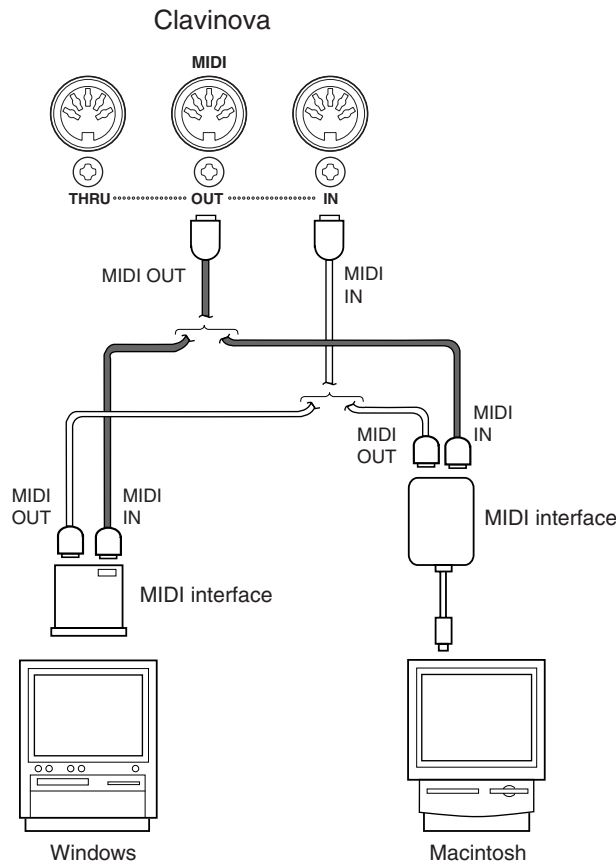

# 2. Connecting the computer's USB port to the Clavinova via a USB interface, such as the UX256, UX96, or UX16

Connect the computer's USB port to the USB interface (such as the UX256, UX96, or UX16) using a USB cable. Install the driver (that came with the USB interface) on the computer, and connect the USB interface to the Clavinova using a serial cable or MIDI cables.

For more information, refer to the instruction manual for the USB interface.

## An example of connecting the USB interface to the Clavinova using MIDI cables

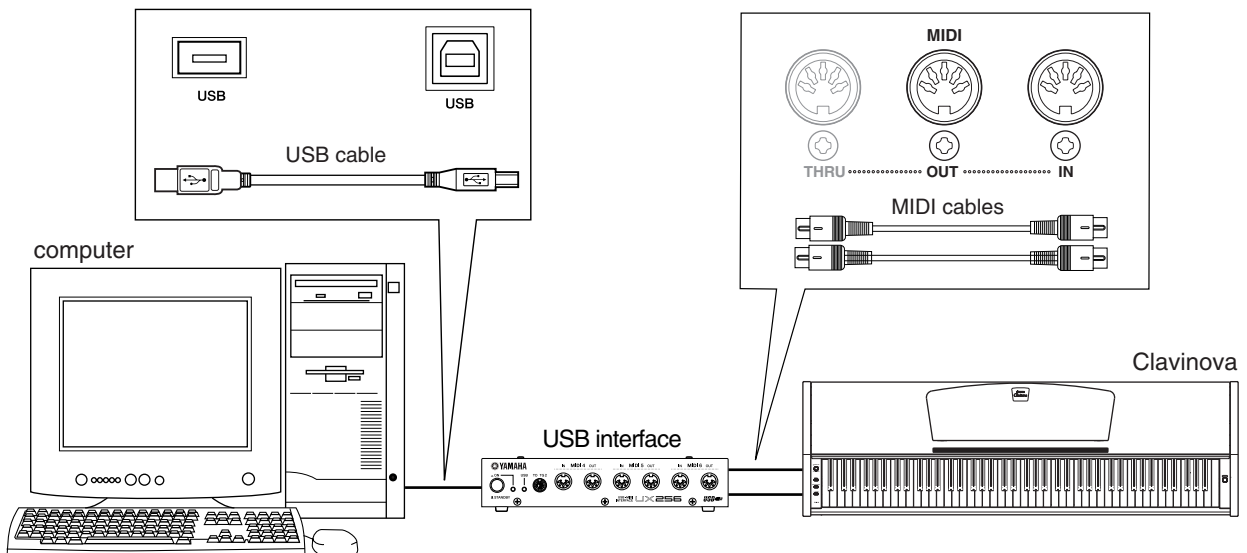

# MIDI Functions

You can make detailed adjustments to MIDI settings.

For more information about MIDI, see the “About MIDI” section (page 23).

## MIDI Transmit/Receive Channel Selection

In any MIDI control setup, the MIDI channels of the transmitting and receiving equipment must be matched for proper data transfer.

This parameter enables you to specify the channel on which the Clavinova transmits or receives MIDI data.

### Procedure

#### Setting the transmit channel

While holding down the A-1 and C<sup>#</sup>0 keys, press one of the C1–E2 keys.

#### Setting the receive channel

While holding down the A-1 and C<sup>#</sup>0 keys, press one of the C4–F5 keys.

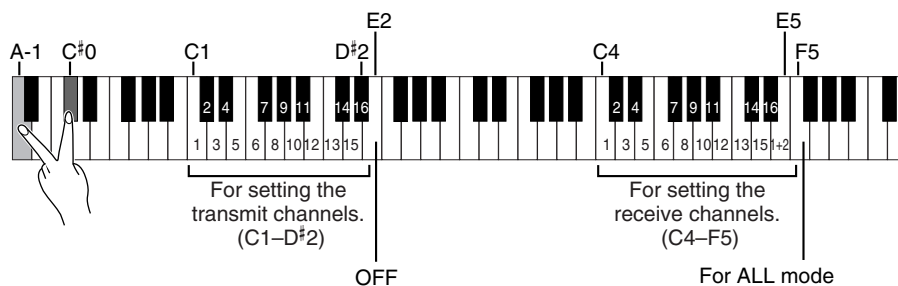

## Local Control ON/OFF

“Local Control” refers to the fact that, normally, the CLP-110 keyboard controls its internal tone generator, allowing the internal voices to be played directly from the keyboard. This situation is “Local Control On,” since the internal tone generator is controlled locally by its own keyboard.

Local control can be turned OFF, however, so that the CLP-110 keyboard does not play the internal voices, but the appropriate MIDI information is still transmitted via the MIDI OUT connector when notes are played on the keyboard. At the same time, the internal tone generator responds to MIDI information received via the MIDI IN connector.

### Procedure

While holding down the A-1 and C<sup>#</sup>0 keys, press the C6 key.

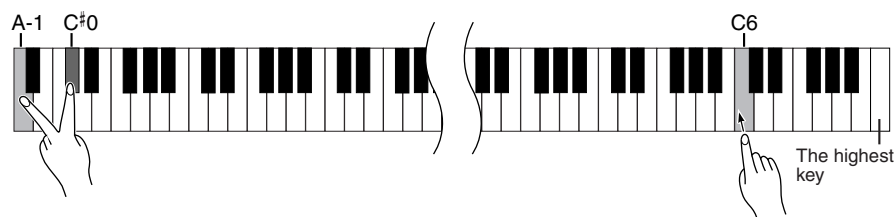

### NOTE

Demo and preset song data are not transmitted via MIDI.

### NOTE

In Dual mode, Voice 1 data is transmitted on its specified channel and Voice 2 data is transmitted on the next greater channel number relative to the specified channel. In this mode, no data is transmitted if the transmit channel is set to “OFF.”

### TIP

#### ALL:

A “Multi-timbre” Receive mode is available. It allows simultaneous reception of different parts on all 16 MIDI channels, enabling the Clavinova to play multi-channel song data received from a music computer or sequencer.

#### 1+2:

A “1+2” Receive mode is available. It allows simultaneous reception on channels 1 and 2 only, enabling the Clavinova to play 1 and 2 channel song data received from a music computer or sequencer.

### TIP

Program change and other like channel messages received will not affect the CLP-110’s panel settings or the notes you play on the keyboard.

### NOTE

The Clavinova does not receive MIDI data when it is in Demo or Preset Song mode.

## Program Change ON/OFF

Normally the CLP-110 will respond to MIDI program change numbers received from an external keyboard or other MIDI device, causing the correspondingly-numbered voice to be selected on the corresponding channel (the keyboard voice does not change). The CLP-110 will normally also send a MIDI program change number whenever one of its voices is selected, causing the correspondingly-numbered voice or program to be selected on the external MIDI device if the device is set up to receive and respond to MIDI program change numbers.

This function makes it possible to cancel program change number reception and transmission so that voices can be selected on the CLP-110 without affecting the external MIDI device.

### Procedure

While holding down the A-1 and C#0 keys, press the C#6 key.

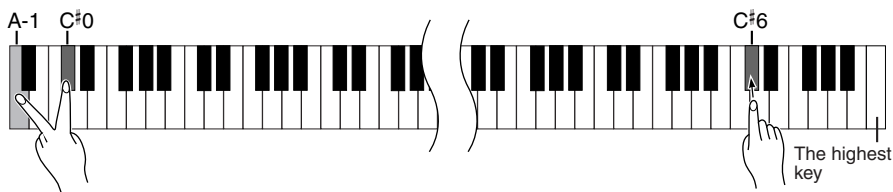

## Control Change ON/OFF

Normally the CLP-110 will respond to MIDI control change data received from an external MIDI device or keyboard, causing the voice on the corresponding channel to be affected by pedal and other “control” settings received from the controlling device (the keyboard voice is not affected). The CLP-110 also transmits MIDI control change information when the pedal or other appropriate controls are operated.

This function makes it possible to cancel control change data reception and transmission so that, for example, the CLP-110's pedal and other controls can be operated without affecting an external MIDI device.

### Procedure

While holding down the A-1 and C#0 keys, press the D6 key.

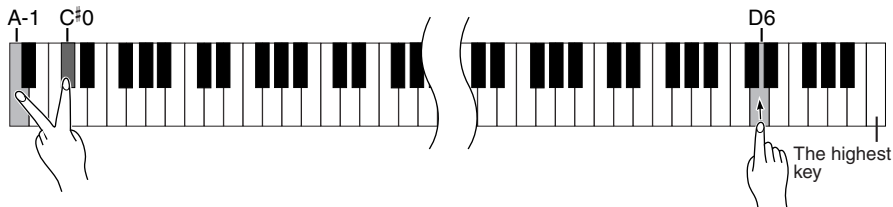

#### TIP

For information on program change numbers for each of the CLP-110's voices, refer to page 34 in the MIDI Data Format section.

#### TIP

For information on control changes that can be used with the CLP-110, refer to the MIDI Data Format on page 34.

# Troubleshooting

---

Problem	Possible Cause and Solution
The Clavinova does not turn on.	The Clavinova has not been plugged in properly. Securely insert the female plug into the socket on the Clavinova, and the male plug into a proper AC outlet (page 11).
A click or pop is heard when the power is turned on or off.	This is normal when electrical current is being applied to the instrument.
Noise from the speakers or headphones is audible.	The noise may be due to interference caused by the use of a mobile phone in close proximity to the Clavinova. Turn off the mobile phone, or move it further away from the Clavinova.
The overall volume is low, or no sound is heard.	<ul style="list-style-type: none"><li>• The Master Volume is set too low. Set it to an appropriate level using the [MASTER VOLUME] control.</li><li>• Make sure a pair of headphones is not connected to the headphones jack.</li><li>• Make sure that Local Control (page 26) is ON.</li></ul>
The damper pedal has no effect, or the sound continuously sustains even when the damper pedal is not pressed.	The pedal cord may not be properly connected. Make sure to securely insert the pedal cord into the [DAMPER PEDAL] jack (page 30).

## Options

---

### BC-100 Bench

A comfortable bench styled to match your Yamaha Clavinova.

### HPE-160 Stereo Headphones

High-performance lightweight dynamic headphones with extra-soft ear pads.

# Keyboard Stand Assembly

## ⚠ CAUTION

Be careful not to confuse parts, and be sure to install all parts in the correct direction. Please assemble in accordance with the sequence given below.

- Assembly should be carried out by at least two persons.
- Be sure to use the correct screw size, as indicated below. Use of incorrect screws can cause damage.
- Be sure to tighten up all screws upon completing assembly of each unit.
- To disassemble, reverse the assembly sequence given below.

Have a Phillips-head (+) screwdriver ready

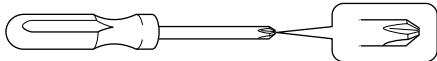

Remove the following parts from the package.

### Assembly Parts

6 × 16 mm flat-head screws × 8



AC power cord

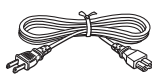

Damper pedal



Cord holders × 2

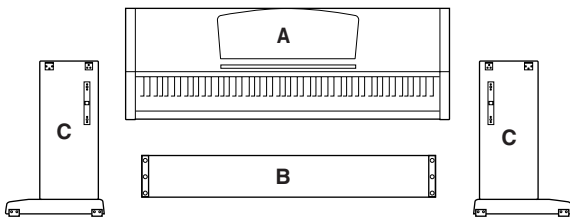

## 1. Attach the center panel (B) to the side panels (C).

The center panel (B) is installed between the side panels (C). The brackets on each end of the center panel should face the rear of the stand assembly. Place the square holes in the center-panel brackets over the lugs extending from the side panels, then slide down the center panel. Each side of the center panel is attached using two 6 × 16 mm flat-head screws.

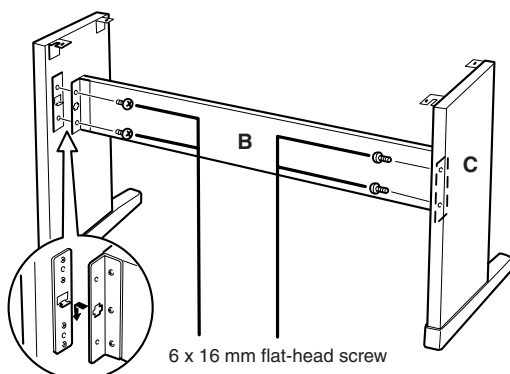

## 2. Install the main unit (A).

### ⚠ CAUTION

- Fingers can become pinched between the main unit and the rear or side panels, be extra careful so as not to drop the main unit.
- Do not hold the keyboard in any position other than the position shown in the illustration.

Place the main unit (A) on the side panels (C) with the screws on its bottom panel (toward the rear of the main unit) just behind the grooves in the brackets located at the top of the side panels. Then slide the main unit forward until it stops.

Align the holes in the bottom panel of the main unit with the holes in the brackets on the side panels. (Center the main unit to produce equal clearance on the left and right sides, as shown in the illustration.) Then use the four 6 × 16 mm flat-head screws to attach the main unit. Two screws can be attached from the front side and two screws from the rear.

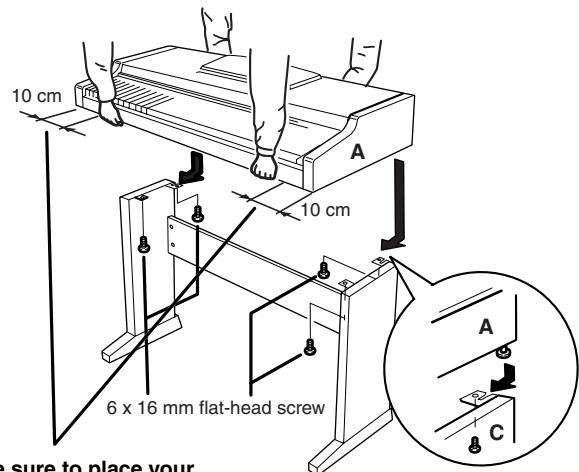

Be sure to place your hands at least 10 cm from either end of the main unit when positioning it.

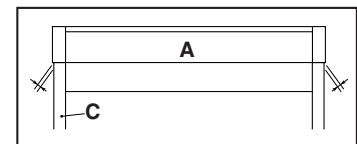

### NOTE

If the holes of the front side brackets are not aligned with the screw hole, position the sides of the side panels so that they are parallel with the side of the unit.

### 3. Set the voltage selector and connect the power cord.

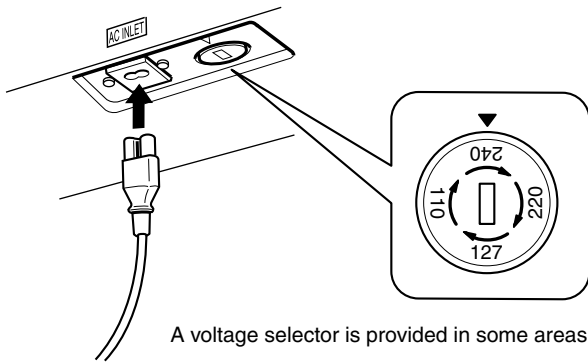

Before connecting the AC power cord, check the setting of the voltage selector which is provided in some areas. To set the selector for 110V, 127V, 220V or 240V main voltages, use a “minus” screwdriver to rotate the selector dial so that the correct voltage for your region appears next to the pointer on the panel. The voltage selector is set at 240V when the unit is initially shipped. After the proper voltage has been selected, connect the AC power cord to the AC INLET and an AC wall outlet. A plug adaptor may be also provided in some areas to match the pin configuration of the AC wall outlets in your area.

#### **! WARNING**

**An improper voltage setting can cause serious damage to the Clavinova or result in improper operation.**

#### • Connecting the damper pedal

To use the pedal functions, connect the included damper pedal to the Clavinova.

Connect the pedal cord to the [DAMPER PEDAL] jack on the bottom of the Clavinova.

Attach two cord holders on the Clavinova as shown in the illustration, then clip the cord into the holders.

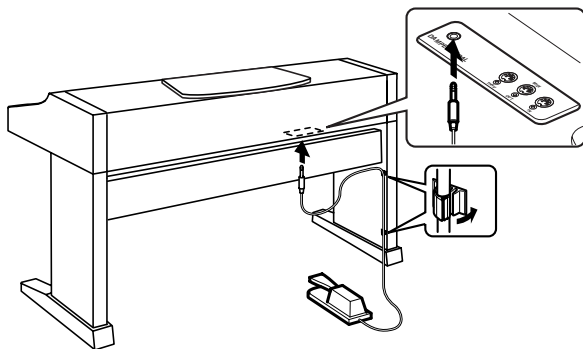

After completing the assembly, please check the following.

- Are there any parts left over?  
→ Review the assembly procedure and correct any errors.
- Is the Clavinova clear of doors and other movable fixtures?  
→ Move the Clavinova to an appropriate location.
- Does the Clavinova make a rattling noise when you shake it?  
→ Tighten all screws.
- Are the pedal and power cords inserted securely into the sockets?  
→ Check the connection.
- If the main unit creaks or is otherwise unsteady when you play the keyboard, refer to the assembly diagrams and re-tighten all screws.

When moving the instrument after assembly, always hold the bottom of the main unit.

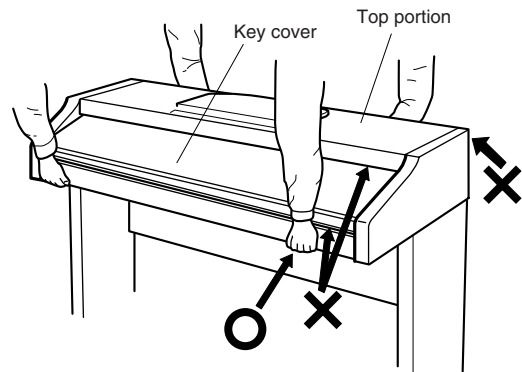

#### **! CAUTION**

- Do not hold the key cover or top portion. Improper handling can result in damage to the instrument or personal injury.

# Index

---

## Numerics

---

- 50 Greats for the Piano .....16
- 50 Piano Preset Songs .....16

## A

---

- Accessories .....8
- Adjust
  - Reverb Depth .....18
  - Tempo (metronome) .....21
  - Volume (50 Piano Preset Songs) .....16
  - Volume (Demo) .....15
  - Volume (metronome) .....22
- Assembly .....29–30

## C

---

- Combining Two Voices (Dual mode) .....19
- Connecting a Personal Computer .....24

## D

---

- DAMPER PEDAL .....14, 17, 30
- DEMO .....14, 15
- Dual mode .....19

## K

---

- Key Cover .....10

## M

---

- MASTER VOLUME .....11, 14
- METRONOME .....14, 21
- MIDI .....23
- MIDI [IN] [OUT] [THRU] .....14
- MIDI cables .....23, 25
- MIDI connectors .....23, 25
- MIDI Data Format .....34
- MIDI Implementation Chart .....38
- Music Rest .....10

## P

---

- PHONES .....12, 14
- POWER .....11, 14
- Precautions .....6–7
- Preset songs → 50 Piano Preset Songs .....16

## R

---

- Reverb .....18

## S

---

- Song .....16
- Specifications .....39
- Start/Stop playback
  - 50 Piano Preset Songs .....16
  - Demo Songs .....15

## T

---

- Transporting .....8
- Transposition .....20
- Troubleshooting .....28

## V

---

- VOICE .....14, 17–19

**MEMO**

ENGLISH



# Appendix

---

This section introduces reference material.  
In diesem Abschnitt finden Sie Referenzmaterial.  
Cette section présente le matériel de référence.  
En esta sección se incluye material de referencia.

MIDI Data Format / MIDI-Datenformat / Format des données MIDI / Formato de datos MIDI .....	34
MIDI Implementation Chart / MIDI Implementierung stabelle / Feuille d'implantation MIDI / Gráfica de implementación MIDI .....	38
Specifications / Technische Daten / Caractéristiques techniques / Especificaciones .....	39

# MIDI Data Format / MIDI-Datenformat / Format des données MIDI / Formato de datos MIDI

If you're already very familiar with MIDI, or are using a computer to control your music hardware with computer-generated MIDI messages, the data provided in this section can help you to control the CLP-110.

Falls Sie bereits mit MIDI vertraut sind oder einen Computer zur Erzeugung von MIDI-Steuermeldungen für die Instrumente verwenden, können Sie sich zur Steuerung des CLP-110 nach den im folgenden Abschnitt aufgeführten Spezifikationen richten.

## 1. NOTE ON/OFF

Data format: [9nH] -> [kk] -> [vv]

9nH = Note ON/OFF event (n = channel number)  
kk = Note number (Transmit: 09H ~ 78H = A-2 ~ C8 /  
Receive: 00H ~ 7FH = C-2 ~ G8)\*  
vv = Velocity (Key ON = 01H ~ 7FH, Key OFF = 00H)

Data format: [8nH] -> [kk] -> [vv] (reception only)

8nH = Note OFF event (n = channel number)  
kk = Note number: 00H ~ 7FH = C-2 ~ G8  
vv = Velocity

\* If received value exceeds the supported range for the selected voice, the note is adjusted by the necessary number of octaves.

## 2. CONTROL CHANGE

Data format: [BnH] -> [cc] -> [vv]

BnH = Control change (n = channel number)  
cc = Control number  
vv = Data Range

### (1) Bank Select

ccH	Parameter	Data Range (vvH)
00H	Bank Select MSB	00H:Normal
20H	Bank Select LSB	00H...7FH

Bank selection processing does not occur until receipt of next Program Change message.

### (2) Main Volume (reception only)

ccH	Parameter	Data Range (vvH)
07H	Volume MSB	00H...7FH

### (3) Expression (reception only)

ccH	Parameter	Data Range (vvH)
0BH	Expression MSB	00H...7FH

### (4) Damper

ccH	Parameter	Data Range (vvH)
40H	Damper MSB	00H...7FH

### (5) Sostenuto (reception only)

ccH	Parameter	Data Range (vvH)
42H	Sostenuto	00H-3FH:off, 40H-7FH:on

### (6) Soft Pedal (reception only)

ccH	Parameter	Data Range (vvH)
43H	Soft Pedal	00H-3FH:off, 40H-7FH:on

### (7) Effect1 Depth (Reverb Send Level)

ccH	Parameter	Data Range (vvH)
5BH	Effect1 Depth	00H...7FH

Adjusts the reverb send level.

### (8) Effect4 Depth (Variation Effect Send Level) (reception only)

ccH	Parameter	Data Range (vvH)
5EH	Effect4 Depth	00H...7FH

Si vous êtes très familier avec l'interface MIDI ou si vous utilisez un ordinateur pour commander votre matériel de musique au moyen de messages MIDI générés par ordinateur, les données suivantes vous seront utiles et vous aideront à commander le CLP-110.

Si usted está ya familiarizado con MIDI, o si emplea una computadora para controlar sus aparatos musicales con mensajes MIDI generados por computadora, los datos proporcionados en esta sección le ayudarán a controlar la CLP-110.

## 3. MODE MESSAGES

Data format: [BnH] -> [cc] -> [vv]

BnH = Control event (n = channel number)  
cc = Control number  
vv = Data Range

### (1) All Sound Off

ccH	Parameter	Data Range (vvH)
78H	All Sound Off	00H

Switches off all sound from the channel. Does not reset Note On and Hold On conditions established by Channel Messages.

### (2) Reset All Controllers

ccH	Parameter	Data Range (vvH)
79H	Reset All Controllers	00H

Resets controllers as follows.

Controller	Value
Expression	127 (max)
Damper Pedal	0 (off)
Sostenuto	0 (off)
Soft Pedal	0 (off)

### (3) Local Control (reception only)

ccH	Parameter	Data Range (vvH)
7AH	Local Control	00H (off), 7FH (on)

### (4) All Notes Off

ccH	Parameter	Data Range (vvH)
7BH	All Notes Off	00H

Switches OFF all the notes that are currently ON on the specified channel. Any notes being held by the damper or sostenuto pedal will continue to sound until the pedal is released.

### (5) Omni Off (reception only)

ccH	Parameter	Data Range (vvH)
7CH	Omni Off	00H

Same processing as for All Notes Off.

### (6) Omni On (reception only)

ccH	Parameter	Data Range (vvH)
7DH	Omni On	00H

Same processing as for All Notes Off.

### (7) Mono (reception only)

ccH	Parameter	Data Range (vvH)
7EH	Mono	00H

Same processing as for All Sound Off.

### (8) Poly (reception only)

ccH	Parameter	Data Range (vvH)
7FH	Poly	00H

Same processing as for All Sound Off.

- When control change reception is turned OFF, control change data will not be transmitted or received except for Bank Select and Mode messages.
- Local on/off, OMNI on/off are not transmitted. (The appropriate note off number is supplied with "All Note Off" transmission).
- When a voice bank MSB/LSB is received, the number is stored in the internal buffer regardless of the received order, then the stored value is used to select the appropriate voice when a program change message is received.
- The Multi-timbre and Poly modes are always active. No change occurs when OMNI ON, OMNI OFF, MONO, or POLY mode messages are received.

#### 4. PROGRAM CHANGE

Data format: [CnH] -> [ppH]

CnH = Program event (n = channel number)

ppH = Program change number

P.C.#=Program Change number

CLP-110	MSB	LSB	P.C.#
Grand Piano 1	0	122	0
Grand Piano 2	0	112	0
E.Piano 1	0	122	5
E.Piano 2	0	122	4
Harpsichord 1	0	122	6
Harpsichord 2	0	123	6
Vibraphone	0	122	11
Church Organ 1	0	123	19
Church Organ 2	0	122	19
Strings	0	122	48

- When program change reception is turned OFF, no program change data is transmitted or received. Also, Bank MSB/LSB is not transmitted or received.

#### 5. SYSTEM REALTIME MESSAGES

[rrH]

FEH: Active sensing

Data	Transmission	Reception
FEH	Transmitted every 200 milliseconds	If a signal is not received via MIDI for more than 400 milliseconds, the same processing will take place for All Sound Off, All Notes Off and Reset All Controllers as when those signals are received.

- Caution: If an error occurs during MIDI reception, the Damper, Sostenuto, and Soft effects for all channels are turned off and an All Note Off occurs.

#### 6. SYSTEM EXCLUSIVE MESSAGES (Universal System Exclusive)

##### (1) Universal Realtime Message

Data format: [F0H] -> [7FH] -> [XnH] -> [04H] -> [01H] -> [IH] -> [mmH] -> [F7H]

##### MIDI Master Volume

- Simultaneously changes the volume of all channels.
- When a MIDI master volume message is received, the volume only has affect on the MIDI receive channel, not the panel master volume.

F0H = Exclusive status

7FH = Universal Realtime

7FH = ID of target device

04H = Sub-ID #1=Device Control Message

01H = Sub-ID #2=Master Volume

//H = Volume LSB

mmH = Volume MSB

F7H = End of Exclusive

or

F0H = Exclusive status

7FH = Universal Realtime

XnH = When n is received n=0~F, whichever is received.

X = don't care

04H = Sub-ID #1=Device Control Message

01H = Sub-ID #2=Master Volume

//H = Volume LSB

mmH = Volume MSB

F7H = End of Exclusive

##### (2) Universal Non-Realtime Message (GM On)

##### General MIDI Mode On

Data format: [F0H] -> [7EH] -> [XnH] -> [09H] -> [01H] -> [F7H]

F0H = Exclusive status

7EH = Universal Non-Realtime

7FH = ID of target device

09H = Sub-ID #1=General MIDI Message

01H = Sub-ID #2=General MIDI On

F7H = End of Exclusive

or

F0H = Exclusive status

7EH = Universal Non-Realtime

XnH = When received, n=0~F.

X = don't care

09H = Sub-ID #1=General MIDI Message

01H = Sub-ID #2=General MIDI On

F7H = End of Exclusive

When the General MIDI mode ON message is received, the MIDI system will be reset to its default settings.

This message requires approximately 50ms to execute, so sufficient time should be allowed before the next message is sent.

## 7. SYSTEM EXCLUSIVE MESSAGES (XG Standard)

### (1) XG Native Parameter Change

Data format: [F0H] -> [43H] -> [1nH] -> [4CH] -> [hhH] -> [mmH] -> [//H] -> [ddH] -> [F7H]

F0H = Exclusive status  
 43H = YAMAHA ID  
 1nH = When received, n=0~F.  
       When transmitted, n=0.  
 4CH = Model ID of XG  
 hhH = Address High  
 mmH = Address Mid  
 //H = Address Low  
 ddH = Data  
 |  
 F7H = End of Exclusive

Data size must match parameter size (2 or 4 bytes).

When the XG System On message is received, the MIDI system will be reset to its default settings.

The message requires approximately 50ms to execute, so sufficient time should be allowed before the next message is sent.

### (2) XG Native Bulk Data (reception only)

Data format: [F0H] -> [43H] -> [0nH] -> [4CH] -> [aaH] -> [bbH] -> [hhH] -> [mmH] -> [//H] -> [ddH] -> ... -> [ccH] -> [F7H]

F0H = Exclusive status  
 43H = YAMAHA ID  
 0nH = When received, n=0~F.  
       When transmitted, n=0.  
 4CH = Model ID of XG  
 aaH = ByteCount  
 bbH = ByteCount  
 hhH = Address High  
 mmH = Address Mid  
 //H = Address Low  
 ddH = Data  
 |       |  
 |       |  
 ccH = Check sum  
 F7H = End of Exclusive

- Receipt of the XG SYSTEM ON message causes reinitialization of relevant parameters and Control Change values. Allow sufficient time for processing to execute (about 50 msec) before sending the CLP-110 another message.
- XG Native Parameter Change message may contain two or four bytes of parameter data (depending on the parameter size).
- For information about the Address and Byte Count values, refer to Table 1 below. Note that the table's Total Size value gives the size of a bulk block. Only the top address of the block (00H, 00H, 00H) is valid as a bulk data address.

## 8. SYSTEM EXCLUSIVE MESSAGES (Clavinova MIDI Format)

Data format: [F0H] -> [43H] -> [73H] -> [xxH] -> [nnH] -> [F7H]

F0H = Exclusive status  
 43H = Yamaha ID  
 73H = Clavinova ID  
 01H = Product ID (CLP common)  
**or**  
 7F= Extended Product ID  
 xxH = Product ID (CLP-110: 24H)  
 nnH = Substatus  
       nn Control  
       02H Internal MIDI clock  
       03H External MIDI clock  
       06H Bulk Data (the bulk data follows 06H)  
 F7H = End of Exclusive

- \* When nn=02H or 03H, Clavinova common ID (01H) is recognized as well as 75H.

## 9. SYSTEM EXCLUSIVE MESSAGES (Special Control)

Data format: [F0H] -> [43H] -> [73H] -> [66H] -> [11H] -> [0nH] -> [ccH] -> [vvH] -> [F7H]

F0H = Exclusive status  
 43H = Yamaha ID  
 73H = Clavinova ID  
 7FH = Extended Product ID  
 xxH = Product ID (CLP-110: 24H)  
 11H = Special control  
 0nH = Control MIDI change (n=channel number)  
 cc = Control number  
 vv = Value  
 F7H = End of Exclusive

Control	Channel	ccH	vvH
Metronome	Always 00H	1BH	00H : off
			01H : -
			02H : 2/4
			03H : 3/4
			04H : 4/4
			05H : 5/4
			06H : 6/4
			7FH : No accent
Channel Detune ch:	00H-0FH	43H	(Sets the Detune value for each channel) 00H-7FH
Voice Reserve ch:	00H-0FH	45H	00H : Reserve off 7FH : on*

- \* When Volume, Expression is received for Reserve On, they will be effective from the next Key On. Reserve Off is normal.

## 10. SYSTEM EXCLUSIVE MESSAGES (Others)

Data format: [F0H] -> [43H] -> [1nH] -> [27H] -> [30H] -> [00H] -> [00H] -> [mmH] -> [//H] -> [ccH] -> [F7H]

Master Tuning (XG and last message priority) simultaneously changes the pitch of all channels.

F0H = Exclusive Status  
 43H = Yamaha ID  
 1nH = When received, n=0~F.  
       When transmitted, n=0.  
 27H = Model ID of TG100  
 30H = Sub ID  
 00H =  
 00H =  
 mmH = Master Tune MSB  
 //H = Master Tune LSB  
 ccH = don't care (under 7FH)  
 F7H = End of Exclusive

**<Table 1>****MIDI Parameter Change table (SYSTEM)**

Address (H)	Size (H)	Data (H)	Parameter	Description	Default value (H)
00 00 00	4	020C - 05F4(*1)	MASTER TUNE	-50 - +50[cent]	00 04 00 00
01				1st bit 3 - 0 → bit 15 - 12	400
02				2nd bit 3 - 0 → bit 11 - 8	
03				3rd bit 3 - 0 → bit 7 - 4	
				4th bit 3 - 0 → bit 3 - 0	
04	1	00 - 7F	MASTER VOLUME	0 - 127	7F
05	1	—	—		
06	1	34 - 4C(*2)	TRANSPOSE	-12 - +12[semitones]	40
7E		00	XG SYSTEM ON	00=XG system ON	
7F		00	RESET ALL PARAMETERS	00=ON (receive only)	
TOTAL SIZE 07					

\*1: Values lower than 020CH select -50 cents. Values higher than 05F4H select +50 cents.

\*2: Values from 28H through 33H are interpreted as -12 through -1. Values from 4DH through 58H are interpreted as +1 through +12.

**<Table 2>****MIDI Parameter Change table (EFFECT 1)**

Refer to the "Effect MIDI Map" for a complete list of Reverb, Chorus and Variation type numbers.

Address (H)	Size (H)	Data (H)	Parameter	Description	Default value (H)
02 01 00	2	00-7F	REVERB TYPE MSB	Refer to Effect MIDI Map	01(=HALL1)
		00-7F	REVERB TYPE LSB	00 : basic type	00
02 01 40	2	00-7F	VARIATION TYPE MSB	Refer to Effect MIDI Map	00(=Effect off)
		00-7F	VARIATION TYPE LSB	00 : basic type	00

• "VARIATION" refers to the EFFECT on the panel.

**<Table 3>****MIDI Parameter Change table (MULTI PART)**

Address (H)	Size (H)	Data (H)	Parameter	Description	Default value (H)
08 nn 11	1	00 - 7F	DRY LEVEL	0 - 127	7F
nn = Part Number					

**• Effect MIDI Map****REVERB**

	MSB	LSB
ROOM	02H	10H
HALL 1	01H	10H
HALL 2	01H	11H
STAGE	03H	10H

**EFFECT**

	MSB	LSB
CHORUS	42H	10H
PHASER	48H	10H
TREMOLO	46H	10H
DELAY	05H	10H

Function...	Transmitted	Recognized	Remarks
Basic Channel Default Changed	1 1 - 16	1 1 - 16	
Mode Default Messages Altered	3 X *****	1 X X	*1  Poly Mode only
Note Number : True voice	9 - 120 *****	0 - 127 0 - 127	
Velocity Note ON Note OFF	O 9nH,v=1-127 O 9nH,v=0	O 9nH,v=1-127 O 9nH,v=0 or 8nH	
After Touch Key's Ch's	X X	X X	
Pitch Bend	X	X	
Control Change 0,32 7 11 64 66 67 91 94	O O X O X X O X	O O O O O O O O	Bank Select Volume Expression Damper Sostenuto Soft pedal Reverb Depth Effect Depth
Prog Change : True #	O *****	O	
System Exclusive	O	O	
Common : Song Pos. : Song Sel. : Tune	X X X	X X X	
System Real Time : Clock : Commands	O O	O O	
Aux : All Sound Off : Reset All Cntrls : Local ON/OFF Mes- : All Notes OFF sages: Active Sense : Reset	O O X O O X	O (120,126-127) O (121) O (122) O (123-125) O X	
Notes: *1 = Recieve Mode is always multi timbre and Poly mode.			

Mode 1 : OMNI ON , POLY                      Mode 2 : OMNI ON ,MONO                      O : Yes  
 Mode 3 : OMNI OFF, POLY                      Mode 4 : OMNI OFF,MONO                      X : No

# Specifications / Technische Daten / Caractéristiques techniques / Especificaciones

Item	CLP-110
Keyboard	88 keys (A-1 - C7)
Sound Source	AWM Stereo Sampling
Polyphony	32 Notes Max.
Voice Selection	10
Effect	Reverb
Volume	Master Volume
Controls	Dual, Metronome, Transpose
Pedal	Damper
Demo Songs	10 voice Demo Songs, 50 preset Songs
Jacks/Connectors	MIDI (IN/OUT/THRU), PHONES × 2, DAMPER PEDAL
Main Amplifiers	20W × 2
Speakers	Oval (12cm × 6cm) × 2
Dimensions (W × D × H) (with music rest)	1345mm × 426mm × 815mm [52-15/16" × 16-3/4" × 32-7/8"] (1345mm × 426mm × 968mm) [53-15/16" × 16-3/4" × 38-1/8"]
Weight	36kg (79lbs., 6oz)
Accessories	Owner's Manual, "50 greats for the Piano" (Music Book), Bench (included or optional depending on locale), Quick Operation Guide, Damper pedal

- \* Specifications and descriptions in this owner's manual are for information purposes only. Yamaha Corp. reserves the right to change or modify products or specifications at any time without prior notice. Since specifications, equipment or options may not be the same in every locale, please check with your Yamaha dealer.
- \* Die technischen Daten und Beschreibungen in dieser Bedienungsanleitung dienen nur der Information. Yamaha Corp. behält sich das Recht vor, Produkte oder deren technische Daten jederzeit ohne vorherige Ankündigung zu verändern oder zu modifizieren. Da die technischen Daten, das Gerät selbst oder Sonderzubehör nicht in jedem Land gleich sind, setzen Sie sich im Zweifel bitte mit Ihrem Yamaha-Händler in Verbindung.
- \* Les caractéristiques techniques et les descriptions du mode d'emploi ne sont données que pour information. Yamaha Corp. se réserve le droit de changer ou modifier les produits et leurs caractéristiques techniques à tout moment sans aucun avis. Du fait que les caractéristiques techniques, les équipements et les options peuvent différer d'un pays à l'autre, adressez-vous au distributeur Yamaha le plus proche.
- \* Las especificaciones y descripciones de este manual del propietario tienen sólo el propósito de servir como información. Yamaha Corp. se reserva el derecho a efectuar cambios o modificaciones en los productos o especificaciones en cualquier momento sin previo aviso. Puesto que las especificaciones, equipos u opciones pueden no ser las mismas en todos los mercados, solicite información a su distribuidor Yamaha.

**MEMO**



**MEMO**

**MEMO**

# IMPORTANT SAFETY INSTRUCTIONS

## INFORMATION RELATING TO PERSONAL INJURY, ELECTRICAL SHOCK, AND FIRE HAZARD POSSIBILITIES HAS BEEN INCLUDED IN THIS LIST.

**WARNING-** When using any electrical or electronic product, basic precautions should always be followed. These precautions include, but are not limited to, the following:

- 1.** Read all Safety Instructions, Installation Instructions, Special Message Section items, and any Assembly Instructions found in this manual **BEFORE** making any connections, including connection to the main supply.
- 2.** Main Power Supply Verification: Yamaha products are manufactured specifically for the supply voltage in the area where they are to be sold. If you should move, or if any doubt exists about the supply voltage in your area, please contact your dealer for supply voltage verification and (if applicable) instructions. The required supply voltage is printed on the name plate. For name plate location, please refer to the graphic found in the Special Message Section of this manual.
- 3.** This product may be equipped with a polarized plug (one blade wider than the other). If you are unable to insert the plug into the outlet, turn the plug over and try again. If the problem persists, contact an electrician to have the obsolete outlet replaced. Do **NOT** defeat the safety purpose of the plug.
- 4.** Some electronic products utilize external power supplies or adapters. Do **NOT** connect this type of product to any power supply or adapter other than one described in the owners manual, on the name plate, or specifically recommended by Yamaha.
- 5.** **WARNING:** Do not place this product or any other objects on the power cord or place it in a position where anyone could walk on, trip over, or roll anything over power or connecting cords of any kind. The use of an extension cord is not recommended! If you must use an extension cord, the minimum wire size for a 25' cord (or less) is 18 AWG. **NOTE:** The smaller the AWG number, the larger the current handling capacity. For longer extension cords, consult a local electrician.
- 6.** Ventilation: Electronic products, unless specifically designed for enclosed installations, should be placed in locations that do not interfere with proper ventilation. If instructions for enclosed installations are not provided, it must be assumed that unobstructed ventilation is required.
- 7.** Temperature considerations: Electronic products should be installed in locations that do not significantly contribute to their operating temperature. Placement of this product close to heat sources such as; radiators, heat registers and other devices that produce heat should be avoided.
- 8.** This product was **NOT** designed for use in wet/damp locations and should not be used near water or exposed to rain. Examples of wet/damp locations are; near a swimming pool, spa, tub, sink, or wet basement.
- 9.** This product should be used only with the components supplied or; a cart, rack, or stand that is recommended by the manufacturer. If a cart, rack, or stand is used, please observe all safety markings and instructions that accompany the accessory product.
- 10.** The power supply cord (plug) should be disconnected from the outlet when electronic products are to be left unused for extended periods of time. Cords should also be disconnected when there is a high probability of lightning and/or electrical storm activity.
- 11.** Care should be taken that objects do not fall and liquids are not spilled into the enclosure through any openings that may exist.
- 12.** Electrical/electronic products should be serviced by a qualified service person when:
  - a. The power supply cord has been damaged; or
  - b. Objects have fallen, been inserted, or liquids have been spilled into the enclosure through openings; or
  - c. The product has been exposed to rain; or
  - d. The product does not operate, exhibits a marked change in performance; or
  - e. The product has been dropped, or the enclosure of the product has been damaged.
- 13.** Do not attempt to service this product beyond that described in the user-maintenance instructions. All other servicing should be referred to qualified service personnel.
- 14.** This product, either alone or in combination with an amplifier and headphones or speaker/s, may be capable of producing sound levels that could cause permanent hearing loss. **DO NOT** operate for a long period of time at a high volume level or at a level that is uncomfortable. If you experience any hearing loss or ringing in the ears, you should consult an audiologist. **IMPORTANT:** The louder the sound, the shorter the time period before damage occurs.
- 15.** Some Yamaha products may have benches and/or accessory mounting fixtures that are either supplied as a part of the product or as optional accessories. Some of these items are designed to be dealer assembled or installed. Please make sure that benches are stable and any optional fixtures (where applicable) are well secured **BEFORE** using. Benches supplied by Yamaha are designed for seating only. No other uses are recommended.

## PLEASE KEEP THIS MANUAL

## FCC INFORMATION (U.S.A.)

### 1. **IMPORTANT NOTICE: DO NOT MODIFY THIS UNIT!**

This product, when installed as indicated in the instructions contained in this manual, meets FCC requirements. Modifications not expressly approved by Yamaha may void your authority, granted by the FCC, to use the product.

2. **IMPORTANT:** When connecting this product to accessories and/or another product use only high quality shielded cables. Cable/s supplied with this product **MUST** be used. Follow all installation instructions. Failure to follow instructions could void your FCC authorization to use this product in the USA.
3. **NOTE:** This product has been tested and found to comply with the requirements listed in FCC Regulations, Part 15 for Class "B" digital devices. Compliance with these requirements provides a reasonable level of assurance that your use of this product in a residential environment will not result in harmful interference with other electronic devices. This equipment generates/uses radio frequencies and, if not installed and used according to the instructions found in the users manual, may cause interference harmful to the operation of

other electronic devices. Compliance with FCC regulations does not guarantee that interference will not occur in all installations. If this product is found to be the source of interference, which can be determined by turning the unit "OFF" and "ON", please try to eliminate the problem by using one of the following measures:

Relocate either this product or the device that is being affected by the interference.

Utilize power outlets that are on different branch (circuit breaker or fuse) circuits or install AC line filter/s.

In the case of radio or TV interference, relocate/reorient the antenna. If the antenna lead-in is 300 ohm ribbon lead, change the lead-in to co-axial type cable.

If these corrective measures do not produce satisfactory results, please contact the local retailer authorized to distribute this type of product. If you can not locate the appropriate retailer, please contact Yamaha Corporation of America, Electronic Service Division, 6600 Orangethorpe Ave, Buena Park, CA90620

The above statements apply **ONLY** to those products distributed by Yamaha Corporation of America or its subsidiaries.

\* This applies only to products distributed by YAMAHA CORPORATION OF AMERICA.

(class B)

### IMPORTANT NOTICE FOR THE UNITED KINGDOM

#### Connecting the Plug and Cord

**IMPORTANT.** The wires in this mains lead are coloured in accordance with the following code:

BLUE : NEUTRAL  
BROWN : LIVE

As the colours of the wires in the mains lead of this apparatus may not correspond with the coloured markings identifying the terminals in your plug proceed as follows:

The wire which is coloured BLUE must be connected to the terminal which is marked with the letter N or coloured BLACK.

The wire which is coloured BROWN must be connected to the terminal which is marked with the letter L or coloured RED.

Making sure that neither core is connected to the earth terminal of the three pin plug.

(2 wires)

- This applies only to products distributed by Yamaha-Kemble Music (U.K.) Ltd.

**CAUTION:** TO PREVENT ELECTRIC SHOCK, MATCH WIDE BLADE OF PLUG TO WIDE SLOT, FULLY INSERT.

**ATTENTION:** POUR ÉVITER LES CHOCS ÉLECTRIQUES, INTRODUIRE LA LAME LA PLUS LARGE DE LA FICHE DANS LA BORNE CORRESPONDANTE DE LA PRISE ET POUSSER JUSQU' AU FOND.

(polarity)

- This applies only to products distributed by Yamaha Canada Music Ltd.
- Ceci ne s'applique qu'aux produits distribués par Yamaha Canada Musique Ltée.

For details of products, please contact your nearest Yamaha or the authorized distributor listed below.

Pour plus de détails sur les produits, veuillez-vous adresser à Yamaha ou au distributeur le plus proche de vous figurant dans la liste suivante.

Die Einzelheiten zu Produkten sind bei Ihrer unten aufgeführten Niederlassung und bei Yamaha Vertragshändlern in den jeweiligen Bestimmungsländern erhältlich.

Para detalles sobre productos, contacte su tienda Yamaha más cercana o el distribuidor autorizado que se lista debajo.

## NORTH AMERICA

### CANADA

**Yamaha Canada Music Ltd.**  
135 Milner Avenue, Scarborough, Ontario,  
M1S 3R1, Canada  
Tel: 416-298-1311

### U.S.A.

**Yamaha Corporation of America**  
6600 Orangethorpe Ave., Buena Park, Calif. 90620,  
U.S.A.  
Tel: 714-522-9011

## CENTRAL & SOUTH AMERICA

### MEXICO

**Yamaha de Mexico S.A. De C.V.,**  
Departamento de ventas  
Javier Rojo Gomez No.1149, Col. Gpe Del  
Moral, Deleg. Iztapalapa, 09300 Mexico, D.F.  
Tel: 686-00-33

### BRAZIL

**Yamaha Musical do Brasil LTDA.**  
Av. Rebouças 2636, São Paulo, Brasil  
Tel: 011-853-1377

### ARGENTINA

**Yamaha de Panamá S.A. Sucursal de Argentina**  
Viamonte 1145 Piso2-B 1053,  
Buenos Aires, Argentina  
Tel: 1-4371-7021

### PANAMA AND OTHER LATIN AMERICAN COUNTRIES/ CARIBBEAN COUNTRIES

**Yamaha de Panamá S.A.**  
Torre Banco General, Piso 7, Urbanización Marbella,  
Calle 47 y Aquilino de la Guardia,  
Ciudad de Panamá, Panamá  
Tel: +507-269-5311

## EUROPE

### THE UNITED KINGDOM

**Yamaha-Kemble Music (U.K.) Ltd.**  
Sherbourne Drive, Tilbrook, Milton Keynes,  
MK7 8BL, England  
Tel: 01908-366700

### IRELAND

**Danfay Ltd.**  
61D, Sallynoggin Road, Dun Laoghaire, Co. Dublin  
Tel: 01-2859177

### GERMANY

**Yamaha Music Central Europe GmbH**  
Siemensstraße 22-34, 25462 Rellingen, Germany  
Tel: 04101-3030

### SWITZERLAND/LIECHTENSTEIN

**Yamaha Music Central Europe GmbH,**  
Branch Switzerland  
Seefeldstrasse 94, 8008 Zürich, Switzerland  
Tel: 01-383 3990

### AUSTRIA

**Yamaha Music Central Europe GmbH,**  
Branch Austria  
Schleiergasse 20, A-1100 Wien, Austria  
Tel: 01-60203900

### THE NETHERLANDS

**Yamaha Music Central Europe GmbH,**  
Branch Nederland  
Clarissenhof 5-b, 4133 AB Vianen, The Netherlands  
Tel: 0347-358 040

### BELGIUM/LUXEMBOURG

**Yamaha Music Central Europe GmbH,**  
Branch Belgium  
Rue de Geneve (Genevastraat) 10, 1140 - Brussels,  
Belgium  
Tel: 02-726 6032

### FRANCE

**Yamaha Musique France, S.A.**  
Division Professionnelle  
BP 70-77312 Marne-la-Vallée Cedex 2, France  
Tel: 01-64-61-4000

### ITALY

**Yamaha Musica Italia S.P.A.**  
Combo Division  
Viale Italia 88, 20020 Lainate (Milano), Italy  
Tel: 02-935-771

### SPAIN/PORTUGAL

**Yamaha-Hazen Música, S.A.**  
Ctra. de la Coruna km. 17, 200, 28230  
Las Rozas (Madrid), Spain  
Tel: 91-201-0700

### GREECE

**Philippos Nakas S.A. The Music House**  
147 Skiathou Street, 112-55 Athens, Greece  
Tel: 01-228 2160

### SWEDEN

**Yamaha Scandinavia AB**  
J. A. Wettergrens Gata 1  
Box 30053  
S-400 43 Göteborg, Sweden  
Tel: 031 89 34 00

### DENMARK

**YS Copenhagen Liaison Office**  
Generatorvej 8B  
DK-2730 Herlev, Denmark  
Tel: 44 92 49 00

### FINLAND

**F-Musiikki Oy**  
Kluuvikatu 6, P.O. Box 260,  
SF-00101 Helsinki, Finland  
Tel: 09 618511

### NORWAY

**Norsk filial av Yamaha Scandinavia AB**  
Grini Næringspark 1  
N-1345 Østerås, Norway  
Tel: 67 16 77 70

### ICELAND

**Skifan HF**  
Skeifan 17 P.O. Box 8120  
IS-128 Reykjavik, Iceland  
Tel: 525 5000

### OTHER EUROPEAN COUNTRIES

**Yamaha Music Central Europe GmbH**  
Siemensstraße 22-34, 25462 Rellingen, Germany  
Tel: +49-4101-3030

## AFRICA

**Yamaha Corporation,**  
Asia-Pacific Music Marketing Group  
Nakazawa-cho 10-1, Hamamatsu, Japan 430-8650  
Tel: +81-53-460-2312

## MIDDLE EAST

### TURKEY/CYPRUS

**Yamaha Music Central Europe GmbH**  
Siemensstraße 22-34, 25462 Rellingen, Germany  
Tel: 04101-3030

### OTHER COUNTRIES

**Yamaha Music Gulf FZE**  
LB21-128 Jebel Ali Freezone  
P.O.Box 17328, Dubai, U.A.E.  
Tel: +971-4-881-5868

## ASIA

### HONG KONG

**Tom Lee Music Co., Ltd.**  
11/F., Silvercord Tower 1, 30 Canton Road,  
Tsimshatsui, Kowloon, Hong Kong  
Tel: 2737-7688

### INDONESIA

**PT. Yamaha Music Indonesia (Distributor)**  
**PT. Nusantik**  
Gedung Yamaha Music Center, Jalan Jend. Gatot  
Subroto Kav. 4, Jakarta 12930, Indonesia  
Tel: 21-520-2577

### KOREA

**Yamaha Music Korea Ltd.**  
Tong-Yang Securities Bldg. 16F 23-8 Yoido-dong,  
Youngdungpo-ku, Seoul, Korea  
Tel: 02-3770-0661

### MALAYSIA

**Yamaha Music Malaysia, Sdn., Bhd.**  
Lot 8, Jalan Perbandaran, 47301 Kelana Jaya,  
Petaling Jaya, Selangor, Malaysia  
Tel: 3-703-0900

### PHILIPPINES

**Yupango Music Corporation**  
339 Gil J. Puyat Avenue, P.O. Box 885 MCPO,  
Makati, Metro Manila, Philippines  
Tel: 819-7551

### SINGAPORE

**Yamaha Music Asia Pte., Ltd.**  
11 Ubi Road #06-00, Meiban Industrial Building,  
Singapore  
Tel: 65-747-4374

### TAIWAN

**Yamaha KHS Music Co., Ltd.**  
3F, #6, Sec.2  
Nan Jing E. Rd. Taipei.  
Taiwan 104, R.O.C.  
Tel: 02-2511-8688

### THAILAND

**Siam Music Yamaha Co., Ltd.**  
121/60-61 RS Tower 17th Floor,  
Ratchadaphisek RD., Dindaeng,  
Bangkok 10320, Thailand  
Tel: 02-641-2951

### THE PEOPLE'S REPUBLIC OF CHINA AND OTHER ASIAN COUNTRIES

**Yamaha Corporation,**  
Asia-Pacific Music Marketing Group  
Nakazawa-cho 10-1, Hamamatsu, Japan 430-8650  
Tel: +81-53-460-2317

## OCEANIA

### AUSTRALIA

**Yamaha Music Australia Pty. Ltd.**  
Level 1, 99 Queensbridge Street, Southbank,  
Victoria 3006, Australia  
Tel: 3-9693-5111

### NEW ZEALAND

**Music Houses of N.Z. Ltd.**  
146/148 Captain Springs Road, Te Papapa,  
Auckland, New Zealand  
Tel: 9-634-0099

### COUNTRIES AND TRUST TERRITORIES IN PACIFIC OCEAN

**Yamaha Corporation,**  
Asia-Pacific Music Marketing Group  
Nakazawa-cho 10-1, Hamamatsu, Japan 430-8650  
Tel: +81-53-460-2312

**HEAD OFFICE** Yamaha Corporation, Pro Audio & Digital Musical Instrument Division  
Nakazawa-cho 10-1, Hamamatsu, Japan 430-8650  
Tel: +81-53-460-2445



*Clavinova Web site (English only)*

***<http://www.yamahaclavinova.com/>***

*Yamaha Manual Library*

***<http://www2.yamaha.co.jp/manual/english/>***