



NS-P610

HOME CINEMA 5.1CH SPEAKER PACKAGE

5.1 SYSTEM D'ENCEINTES HOME CINEMA



**OWNER'S MANUAL
MODE D'EMPLOI**

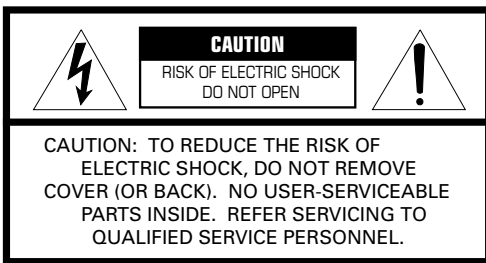

IMPORTANT
Please record the serial number of this system in the space below.

Model:

Serial No.:

The serial number is located on the rear of the main unit.
Retain this Owner's Manual in a safe place for future reference.

• Explanation of Graphical Symbols

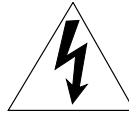

The lightning flash with arrowhead symbol, within an equilateral triangle, is intended to alert you to the presence of uninsulated "dangerous voltage" within the product's enclosure that may be of sufficient magnitude to constitute a risk of electric shock to persons.



The exclamation point within an equilateral triangle is intended to alert you to the presence of important operating and maintenance (servicing) instructions in the literature accompanying the appliance.

WARNING
TO REDUCE THE RISK OF FIRE OR ELECTRIC SHOCK, DO NOT EXPOSE THIS APPLIANCE TO RAIN OR MOISTURE.

SAFETY INSTRUCTIONS

- 1 Read Instructions – All the safety and operating instructions should be read before the unit is operated.
- 2 Retain Instructions – The safety and operating instructions should be retained for future reference.
- 3 Heed Warnings – All warnings on the unit and in the operating instructions should be adhered to.
- 4 Follow Instructions – All operating and other instructions should be followed.
- 5 Water and Moisture – The unit should not be used near water – for example, near a bathtub, washbowl, kitchen sink, laundry tub, in a wet basement, or near a swimming pool, etc.
- 6 Carts and Stands – The unit should be used only with a cart or stand that is recommended by the manufacturer.
- 6A A unit and cart combination should be moved with care. Quick stops, excessive force, and uneven surfaces may cause the unit and cart combination to overturn. 
- 7 Wall or Ceiling Mounting – The unit should be mounted to a wall or ceiling only as recommended by the manufacturer.
- 8 Ventilation – The unit should be situated so that its location or position does not interfere with its proper ventilation. For example, the unit should not be situated on a bed, sofa, rug, or similar surface, that may block the ventilation openings; or placed in a built-in installation, such as a bookcase or cabinet that may impede the flow of air through the ventilation openings.
- 9 Heat – The unit should be situated away from heat sources such as radiators, stoves, or other appliances that produce heat.
- 10 Power Sources – The unit should be connected to a power supply only of the type described in the operating instructions or as marked on the unit.
- 11 Power-Cord Protection – Power-supply cords should be routed so that they are not likely to be walked on or pinched by items placed upon or against them, paying particular attention to cords at plugs, convenience receptacles, and the point where they exit from the unit.
- 12 Cleaning – The unit should be cleaned only as recommended by the manufacturer.
- 13 Nonuse Periods – The power cord of the unit should be unplugged from the outlet when left unused for a long period of time.
- 14 Object and Liquid Entry – Care should be taken so that objects do not fall into and liquids are not spilled into the inside of the unit.
- 15 Damage Requiring Service – The unit should be serviced by qualified service personnel when:
 - A. The power-supply cord or the plug has been damaged; or
 - B. Objects have fallen, or liquid has been spilled into the unit; or
 - C. The unit has been exposed to rain; or
 - D. The unit does not appear to operate normally or exhibits a marked change in performance; or
 - E. The unit has been dropped, or the cabinet damaged.
- 16 Servicing – The user should not attempt to service the unit beyond those means described in the operating instructions. All other servicing should be referred to qualified service personnel.
- 17 Power Lines – An outdoor antenna should be located away from power lines.
- 18 Grounding or Polarization – Precautions should be taken so that the grounding or polarization is not defeated.

FCC INFORMATION (for US customers only)

1. IMPORTANT NOTICE : DO NOT MODIFY THIS UNIT!

This product, when installed as indicated in the instructions contained in this manual, meets FCC requirements. Modifications not expressly approved by Yamaha may void your authority, granted by the FCC, to use the product.

2. IMPORTANT : When connecting this product to accessories and/or another product use only high quality shielded cables. Cable/s supplied with this product **MUST** be used. Follow all installation instructions. Failure to follow instructions could void your FCC authorization to use this product in the USA.

3. NOTE : This product has been tested and found to comply with the requirements listed in FCC Regulations, Part 15 for Class "B" digital devices. Compliance with these requirements provides a reasonable level of assurance that your use of this product in a residential environment will not result in harmful interference with other electronic devices.

This equipment generates/uses radio frequencies and, if not installed and used according to the instructions found in the users manual, may cause interference harmful to the operation of other electronic devices.

Compliance with FCC regulations does not guarantee that interference will not occur in all installations. If this product is found to be the source of interference, which can be determined by turning the unit "OFF" and "ON", please try to eliminate the problem by using one of the following measures:

Relocate either this product or the device that is being affected by the interference.

Utilize power outlets that are on different branch (circuit breaker or fuse) circuits or install AC line filter/s.

In the case of radio or TV interference, relocate/reorient the antenna. If the antenna lead-in is 300 ohm ribbon lead, change the lead-in to coaxial type cable.

If these corrective measures do not produce satisfactory results, please contact the local retailer authorized to distribute this type of product. If you can not locate the appropriate retailer, please contact Yamaha Electronics Corp., U.S.A. 6660 Orangethorpe Ave, Buena Park, CA 90620.

The above statements apply **ONLY** to those products distributed by Yamaha Corporation of America or its subsidiaries.

We Want You Listening For A Lifetime

YAMAHA and the Electronic Industries Association's Consumer Electronics Group want you to get the most out of your equipment by playing it at a safe level. One that lets the sound come through loud and clear without annoying blaring or distortion – and, most importantly, without affecting your sensitive hearing.





Since hearing damage from loud sounds is often undetectable until it is too late, YAMAHA and the Electronic Industries Association's Consumer Electronics Group recommend you to avoid prolonged exposure from excessive volume levels.

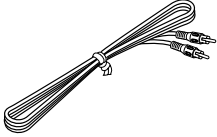

UNPACKING DEBALLAGE

After unpacking, check that the following items are contained.

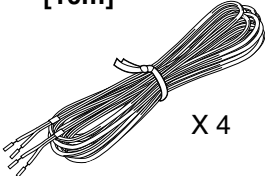
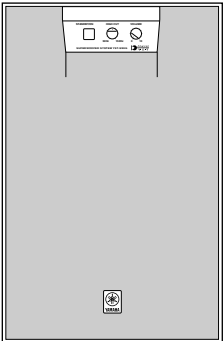
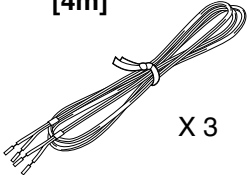
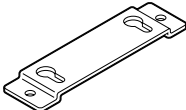
Après le déballage, vérifier que les pièces suivantes sont incluses.

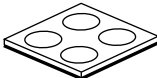
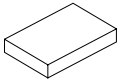
<ul style="list-style-type: none"> ● Main and rear speakers ● Enceintes principales et arrière  <p>X 4</p> <p><NS-10MMT></p>	<ul style="list-style-type: none"> ● Pin plug cord ● Câbles à fiches <p>[3m]</p> 
<ul style="list-style-type: none"> ● Center speaker ● Enceinte centrale  <p><NS-C10MM></p>	<ul style="list-style-type: none"> ● Speaker cords ● Câbles d'enceintes <p>[10m]</p>  <p>X 4</p>
<ul style="list-style-type: none"> ● Subwoofer ● Subwoofer  <p><YST-SW45></p>	<ul style="list-style-type: none"> ● Speaker cords ● Câbles d'enceintes <p>[4m]</p>  <p>X 3</p>
	<ul style="list-style-type: none"> ● Mounting brackets ● Supports de montage  <p>X 4</p>
	<ul style="list-style-type: none"> ● Screws ● Vis  <p>X 8</p>
	<ul style="list-style-type: none"> ● Pads (for NS-10MMT) ● Patins (pour NS-10MMT)  <p>X 2</p>
	<ul style="list-style-type: none"> ● Rubber pads (for YST-SW45) ● Tampons en caoutchouc (pour YST-SW45) 
	<ul style="list-style-type: none"> ● Fasteners ● Attaches  <p>X 4</p>

CAUTION: Read this before operating your unit.

- To assure the finest performance, please read this manual carefully. Keep it in a safe place for future reference.
- Install the speakers in a cool, dry, clean place – away from windows, heat sources, sources of excessive vibration, dust, moisture and cold. Avoid sources of humming (transformers, motors). To prevent fire or electric shock, do not expose the speakers to rain or water.
- To prevent the enclosure from warping or discoloring, do not place the speakers where they will be exposed to direct sunlight or excessive humidity.
- Do not place the following objects on top of the speakers:
 - Other components, as they might cause damage and/or discoloration on the surface of the speakers.
 - Burning objects (i.e. candles), as they might cause fire, damage to the speakers and/or personal injury.
 - Containers with liquid in them, as they might cause electric shock to the user and/or damage to the speakers.
- Do not place the speakers where they are liable to be knocked over or struck by falling objects. Stable placement will also ensure better sound performance.
- Placing the speakers on the same shelf or rack as the turntable can result in feedback.
- Secure placement or installation is the owner's responsibility. YAMAHA shall not be liable for any accident caused by improper placement or installation of speakers.
- Any time you note distortion, reduce the volume control on your amplifier to a lower setting. Never allow your amplifier to be driven into "clipping". Otherwise the speakers may be damaged.
- When using an amplifier with a rated output power higher than the nominal input power of the speakers, care should be taken never to exceed the speakers' maximum input.
- Do not attempt to clean the speakers with chemical solvents as this might damage the finish. Use a clean, dry cloth.
- Do not attempt to modify or fix the speakers. Contact qualified YAMAHA service personnel when any service is needed. The cabinet should never be opened for any reasons.
- Be sure to read the "TROUBLESHOOTING" section regarding common operating errors before concluding that the speakers are faulty.
- Do not cover the rear panel of this unit with a newspaper, a tablecloth, a curtain, etc. in order not to obstruct heat radiation. If the temperature inside this unit rises, it may cause fire, damage to this unit and/or personal injury.
- Do not plug in this unit to a wall outlet until all connections are completed.
- The voltage to be used must be the same as that specified on the rear panel. Using this unit with a higher voltage than specified is dangerous and may cause fire, damage to this unit, and/or personal injury. YAMAHA will not be held responsible for any damage resulting from use of this unit with a voltage other than specified.
- To prevent lightning damage, disconnect the AC power plug when there is an electric storm.
- Super-bass frequencies reproduced by this unit may cause a turntable to generate a howling sound. In such a case, move this unit away from the turntable.
- This unit may be damaged if certain sounds are continuously outputted at high volume level. For example, if 20 Hz–50 Hz sine waves from a test disc, bass sounds from electronic instruments, etc. are continuously outputted, or when the stylus of a turntable touches the surface of a disc, reduce the volume level to prevent this unit from being damaged.
- If you hear distorted noise (i.e. unnatural, intermittent "rapping" or "hammering" sounds) coming from this unit, reduce the volume level. Extremely loud playing of a movie soundtrack's low frequency, bass-heavy sounds or similarly loud popular music passages can damage this speaker system.
- Vibration generated by super-bass frequencies may distort images on a TV. In such a case, move this unit away from the TV set.
- When disconnecting the power cord from the wall outlet, grasp the plug; do not pull the cord.
- When not planning to use this unit for a long period (i.e. vacation, etc.), disconnect the AC power plug from the wall outlet.

For YST-SW45 only

- Do not operate this unit upside down. It may overheat, possibly causing damage.
- Do not use force on switches, controls or connection wires. When moving this unit, first disconnect the power plug and the wires connected to other equipments. Never pull the wires themselves.
- Since this unit has a built-in power amplifier, heat will radiate from the rear panel. Place the unit apart from the walls, allowing 20 cm above, behind and on both sides of the unit to prevent fire or damage. Furthermore, do not position with the rear panel facing down on the floor or other surfaces.
- To avoid condensation inside this unit, do not expose this unit to sudden temperature changes from cold to hot, or do not place this unit in an environment with high humidity (i.e. a room with a humidifier). Condensation may cause an electric shock, fire, and/or damage to this unit.

VOLTAGE SELECTOR (China and general models only)
The VOLTAGE SELECTOR on the rear panel of this unit must be set for your local main voltage BEFORE plugging into the AC main supply. Voltages are 110-120/220-240 V AC, 50/60 Hz.

Standby mode
When this unit is turned off by pressing the STANDBY/ON button on the front panel, it consumes a small amount of power. This state is called the standby mode. This unit's power supply is completely cut off from the AC line only when the POWER switch on the rear panel is set in the OFF position or the AC power cord is disconnected.

These speakers feature a magnetically shielded design, but there is still a chance that placing them too close to a TV set might impair picture color. Should this happen, move the speakers away from the TV set.

For U.K. customers

If the socket outlets in the home are not suitable for the plug supplied with this appliance, it should be cut off and an appropriate 3 pin plug fitted. For details, refer to the instructions described below.

Note: The plug severed from the mains lead must be destroyed, as a plug with bared flexible cord is hazardous if engaged in a live socket outlet.

For Canadian Customers

To prevent electric shock, match wide blade of plug to wide slot and fully insert.

This Class B digital apparatus complies with Canadian ICES-003.

SPECIAL INSTRUCTIONS FOR U.K. MODEL

IMPORTANT:

THE WIRES IN MAINS LEAD ARE COLOURED IN ACCORDANCE WITH THE FOLLOWING CODE:

Blue: NEUTRAL

Brown: LIVE

As the colours of the wires in the mains lead of this apparatus may not correspond with the coloured markings identifying the terminals in your plug, proceed as follows: The wire which is coloured BLUE must be connected to the terminal which is marked with the letter N or coloured BLACK. The wire which is coloured BROWN must be connected to the terminal which is marked with the letter L or coloured RED. Making sure that neither core is connected to the earth terminal of the three pin plug.

COMPONENTS OF THE PACKAGE

The speaker package "NS-P610" is designed for use in a multi-channel audio system such as a home theater system. The package includes two pairs of main/rear speakers (NS-10MMT), a center speaker (NS-C10MM) and a subwoofer system (YST-SW45).

<Main/rear speakers (NS-10MMT)>

2-way 2-speaker bass-reflex speaker system

<Center speaker (NS-C10MM)>

2-way 3-speaker bass-reflex speaker system

<Subwoofer (YST-SW45)>

Active Servo Processing Subwoofer System with a built-in power amplifier

- This subwoofer system employs Advanced YAMAHA Active Servo Technology which YAMAHA has developed for reproducing higher quality super-bass sound. (Refer to page 14 for details on Advanced YAMAHA Active Servo Technology.) This super-bass sound adds a more realistic, theater-in-the-home effect to your stereo system.
- This subwoofer can be easily added to your existing audio system by connecting to either the speaker terminals or the line output (pin jack) terminals of the amplifier.
- The HIGH CUT control enables you to adjust the tone balance between the subwoofer and the main speakers.
- The Automatic power-switching function saves you the trouble of pressing the STANDBY/ON button to turn the power on and off.

CONTENTS

SAFETY INSTRUCTIONS	II	Various ways of connecting the subwoofer	8
UNPACKING	IV	Connecting the subwoofer to line output (pin jack) terminals of the amplifier (The basic way)	8
CAUTION	1	Connecting the subwoofer to speaker output terminals of the amplifier	9
COMPONENTS OF THE PACKAGE	2	USING THE SUBWOOFER (YST-SW45)	10
SETTING UP THE SPEAKERS	3	Controls and their functions	10
Placing the subwoofer	3	Automatic power-switching function	11
Mounting the rear speakers	4	Adjusting the subwoofer before use	12
Mounting the center speaker	5	Frequency characteristics	13
CONNECTIONS	6	ADVANCED YAMAHA ACTIVE SERVO TECHNOLOGY (for YST-SW45)	14
General information for connections	6	TROUBLESHOOTING	15
An example of basic connections	6	SPECIFICATIONS	16
How to connect speaker cords	7		

SETTING UP THE SPEAKERS

Before making connections, place all speakers in their respective positions. The positioning of the speakers is important because it controls the whole sound quality of this system.

Place the speakers depending on your listening position by following the instructions below.

Speaker configuration

This speaker package employs a 6 speaker configuration: 2 main speakers, 2 rear speakers, a center speaker and a subwoofer.

The main speakers are used for main source sound. The rear speakers are used for surround sounds, and the center speaker is for center sounds (dialog etc.). The subwoofer is for reinforcing low frequencies on your audio system.

Note

In this speaker package, the same speakers (NS-10MMT) are used for the main and rear speakers.

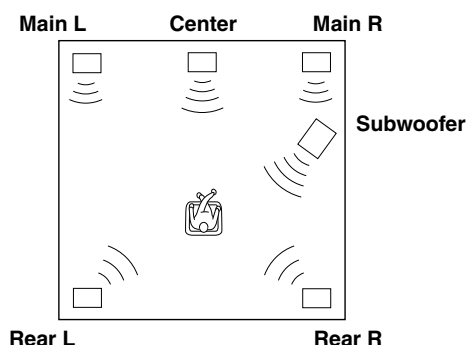

Placing speakers

Main speakers: On both sides of and at approximately the same height as the TV set.

Rear speakers: Behind your listening position, facing slightly inward. About 1.8 m (approx. 6 feet) from the floor.

Center speaker: Precisely between the main speakers.

Subwoofer: The position of the subwoofer is not so critical because low bass tones are not highly directional. Refer to "Placing the subwoofer" below for a recommended positioning of the subwoofer.

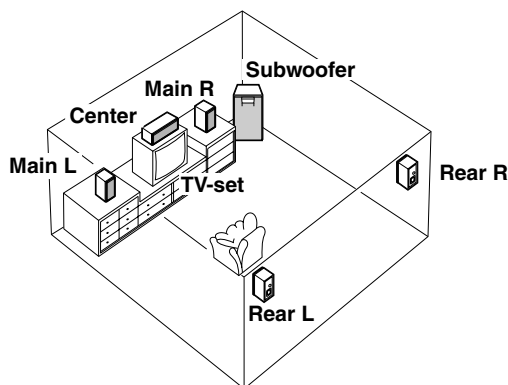

■ Placing the subwoofer

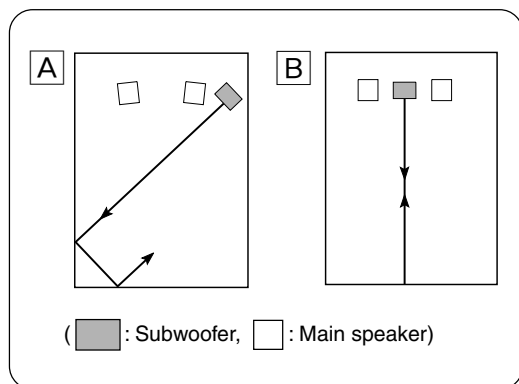

It is recommended to place the subwoofer on the outside of either the right or the left main speaker. (See fig. [A](#).) The placement shown in fig. [B](#) is also possible, however, if the subwoofer system is placed directly facing the wall, the bass effect may die because the sound from it and the sound reflected by the wall may cancel out each other. To prevent this from happening, face the subwoofer system at an angle as shown in fig. [A](#).

Note

There may be a case that you cannot obtain enough super-bass sounds from the subwoofer when listening in the center of the room. This is because "standing waves" have been developed between two parallel walls and they cancel the bass sounds.

In such a case, face the subwoofer obliquely to the wall. It also may be necessary to break up the parallel surfaces by placing bookshelves etc. along the walls.

Use the rubber pads

Put the provided rubber pads at the four corners on the bottom of the subwoofer to prevent the subwoofer moving due to vibrations etc.

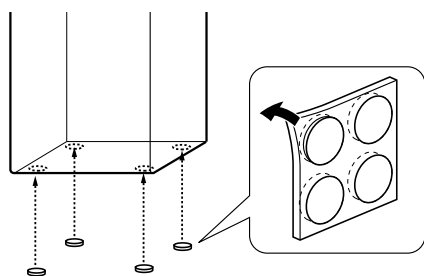

■ Mounting the rear speakers

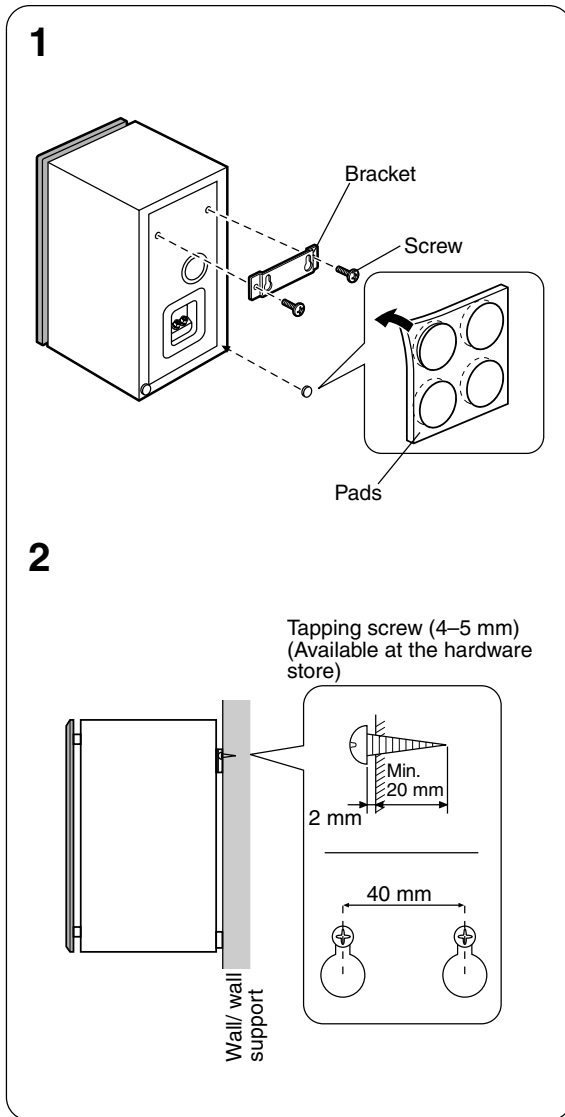

Mount the rear speakers on a shelf, rack or directly on the floor, or hang them on the wall.

To mount the rear speakers on a wall by using the provided mounting brackets

- 1** Attach the bracket to the rear of the speaker by using the provided screws. Remove the provided pads from the backing sheet and put them at the lower corners of the speakers.
- 2** Fasten screws into a firm wall or wall support as shown in the figure, and hang the holes of the mounting bracket on the protruding screws.
 - * Make sure that the screws are securely caught by the narrow parts of the holes.

WARNING

- Each speaker weighs 1.5 kg (3 lbs. 5 oz.). Do not mount them on thin plywood or a wall with soft surface material. If mounted, the screws may come out of the flimsy surface and the speakers may fall. This damages the speakers or causes personal injury.
- Do not install the speakers to a wall with nails, adhesives, or any other unstable hardware. Long-term use and vibrations may cause them to fall.
- To avoid accidents resulting from tripping over loose speaker cords, fix them to the wall.

You can also use the screw holes on the bottom of the speaker for installing the speakers on commercially available speaker stands (if you do not use the provided mounting brackets.)

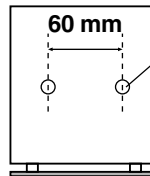

A screw with a diameter of 4 mm can be used.
(Hole depth : 8 mm)

■ Mounting the center speaker

Place the center speaker on top of the TV, on the floor under the TV or inside the TV rack so that it is stable.

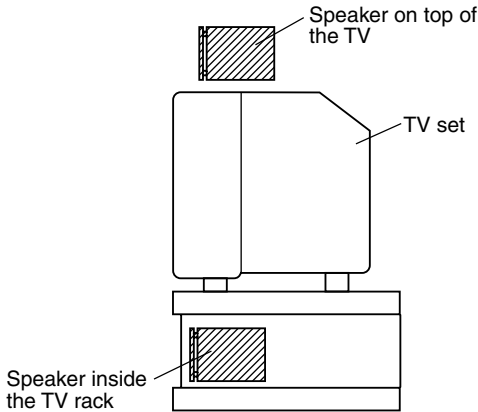

To mount the center speaker on top of the TV

When placing the speaker on top of the TV, put the provided fasteners at two points on both the bottom of the speaker and on top of the TV to prevent the speaker from falling.

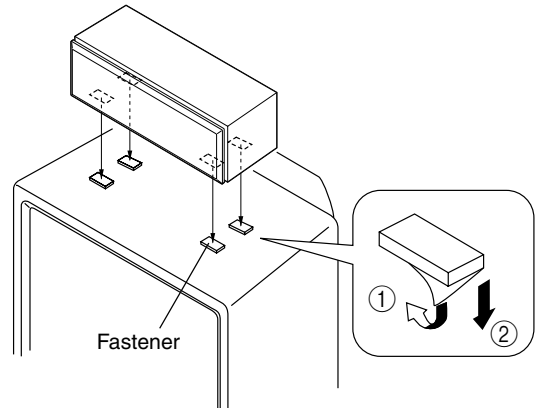

Notes

- Do not place the speaker on top of the TV whose area is smaller than the bottom area of the speaker. If placed, the speaker may fall and might cause personal injury.
- Though this speaker is a magnetically shielded type, there may be some influence on a TV picture depending on the type of TV or the placement of the speaker. In such a case, place the speaker apart from TV so that there is no influence on TV picture.

Removing the front cover

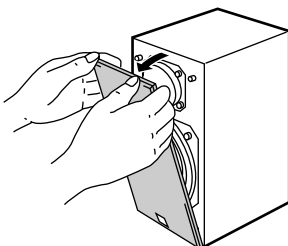

The front cover is fastened to the enclosure at four points and can be removed if desired. To remove the cover, hold on to both sides and slowly pull straight away from the speaker. To reattach, line up the four holes on the inner surface of the cover with the four corresponding pegs on the speaker and push gently.

Note

When the cover is removed, be sure not to touch the speaker units with your hands or to exert excessive force with tools.

CONNECTIONS

General information for connections

Caution: Plug in the subwoofer and other audio/video components after all connections are completed.

- Connect the main, center and rear speakers to the speaker output terminals of your amplifier with the provided speaker cords.
 - * The provided speaker cords have labels marked FRONT L, FRONT R, CENTER, REAR L or REAR R. Connect each speaker cord to the corresponding speaker by following the figure below.
 - * Connect each speaker making sure not to reverse the polarity (+, -). If the speaker is connected with reversed polarity, the sound will be unnatural and lack bass.
- * For the main and rear speakers only, connect one speaker to the left (marked L) terminals of your amplifier, and another speaker to the right (marked R) terminals.
- The subwoofer can be connected to either the line output (pin jack) terminals or the speaker output terminals of the amplifier. Choose one of the ways shown in this section that is more suitable for your audio system. Also, refer to the owner's manual of your component to be connected to the subwoofer.

■ An example of basic connections

Basically, connect the subwoofer to the line output (pin jack) terminal(s) of the amplifier. (Refer to page 8 for details.) If your amplifier does not have any line output terminal, connect the subwoofer to the speaker output terminals of the amplifier. (Refer to page 9 for details.)

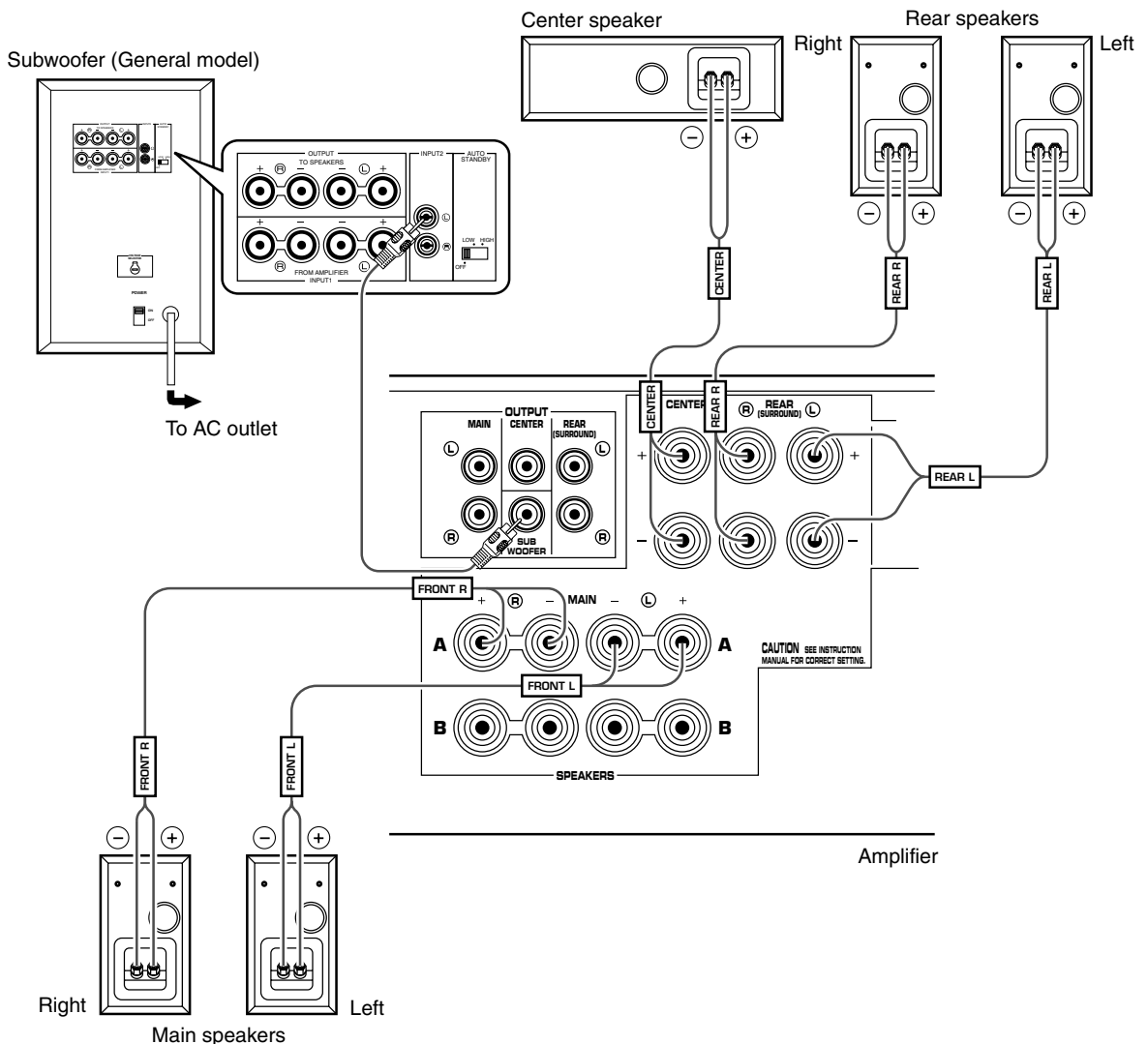

How to connect speaker cords

Main/center/rear speakers

Red: positive (+)

Black: negative (-)

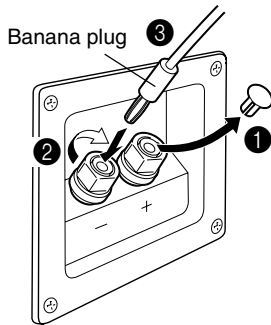
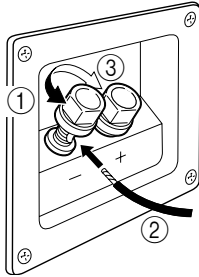

Subwoofer (INPUT1/OUTPUT terminals)

Red: positive (+)

Black: negative (-)

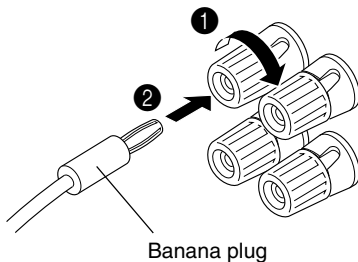
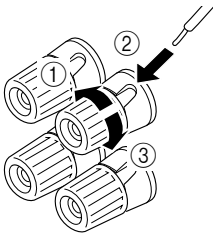

For connections, keep the speaker cords as short as possible. Do not bundle or roll up the excess part of the cords. If the connections are faulty, no sound will be heard from the speakers. Make sure that the + and - polarity markings of the speaker cords are observed and set correctly. If these cords are reversed, the sound will be unnatural and lack bass.

How to Connect:

- ① Loosen the knob.
- ② Insert the bare wire. [Remove approx. 10 mm (3/8") insulation from the speaker cords.]

Good No Good

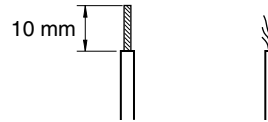

- ③ Tighten the knob and secure the cord.
Test the firmness of the connection by pulling lightly on the cord at the terminal.

Note

Do not let the bare speaker wires touch each other as this could damage the speaker or the amplifier, or both of them.

When using a banana plug (main/center/rear speakers)

<U.S.A., Canada, Australia, China and General models only>

- ① Remove the cover by pulling it toward you.
- ② Tighten the terminal knob.
- ③ Simply insert the banana plug into the terminal.

Various ways of connecting the subwoofer

■ Connecting the subwoofer to line output (pin jack) terminals of the amplifier (The basic way)

Connect the main speakers to the speaker output terminals of the amplifier.

- To connect with a YAMAHA DSP amplifier (or AV receiver), connect the SUBWOOFER (or LOW PASS etc.) terminal on the rear of the DSP amplifier (or AV receiver) to the (L) INPUT2 terminal of the subwoofer.
- To connect the subwoofer to the SPLIT SUBWOOFER terminals on the rear of the DSP amplifier, connect them to both the left (L) and right (R) INPUT2 terminals of the subwoofer.

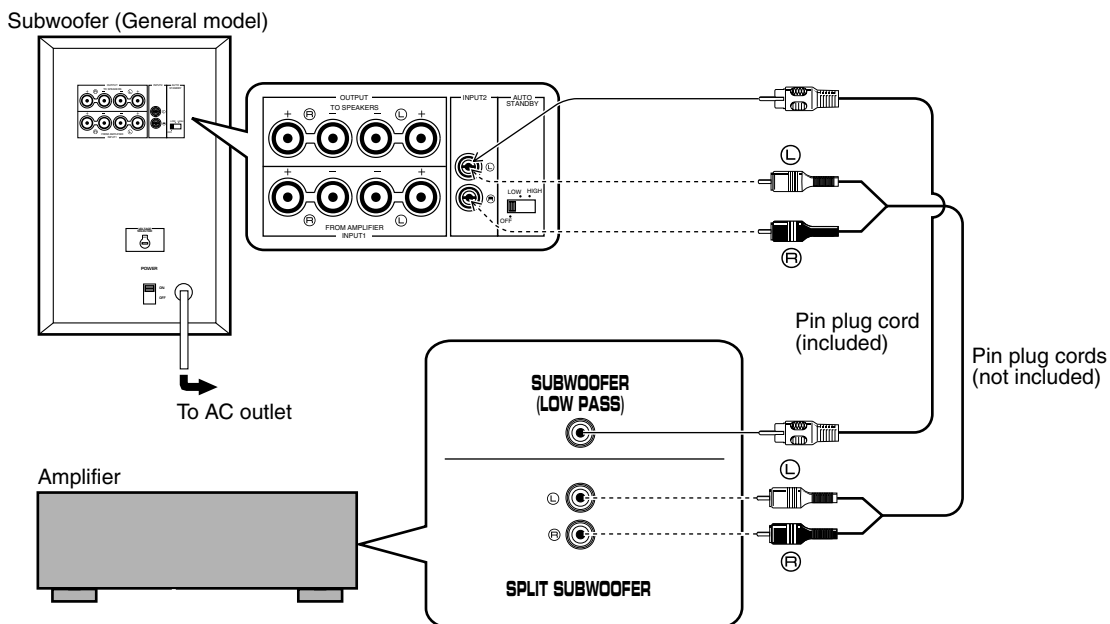

Notes

- Some amplifiers have line output terminals labeled PRE OUT. When you connect the subwoofer to the PRE OUT terminals of the amplifier, make sure that the amplifier has at least two sets of PRE OUT terminals. If the amplifier has only one set of PRE OUT terminals, do not connect the subwoofer to the PRE OUT terminals. Instead, connect the subwoofer to the speaker output terminals of the amplifier. (Refer to pages 6 and 7.)
- When connecting to a monaural line output terminal of the amplifier, connect the (L) INPUT2 terminal.
- When connecting to line output terminals of the amplifier, other speakers should not be connected to the OUTPUT terminals on the rear panel of the subwoofer. If connected, they will not produce sound.

■ Connecting the subwoofer to speaker output terminals of the amplifier

If your amplifier has only one set of main speaker output terminals

Connect the speaker output terminals of the amplifier to the INPUT1 terminals of the subwoofer, and connect the OUTPUT terminals of the subwoofer to the main speakers.

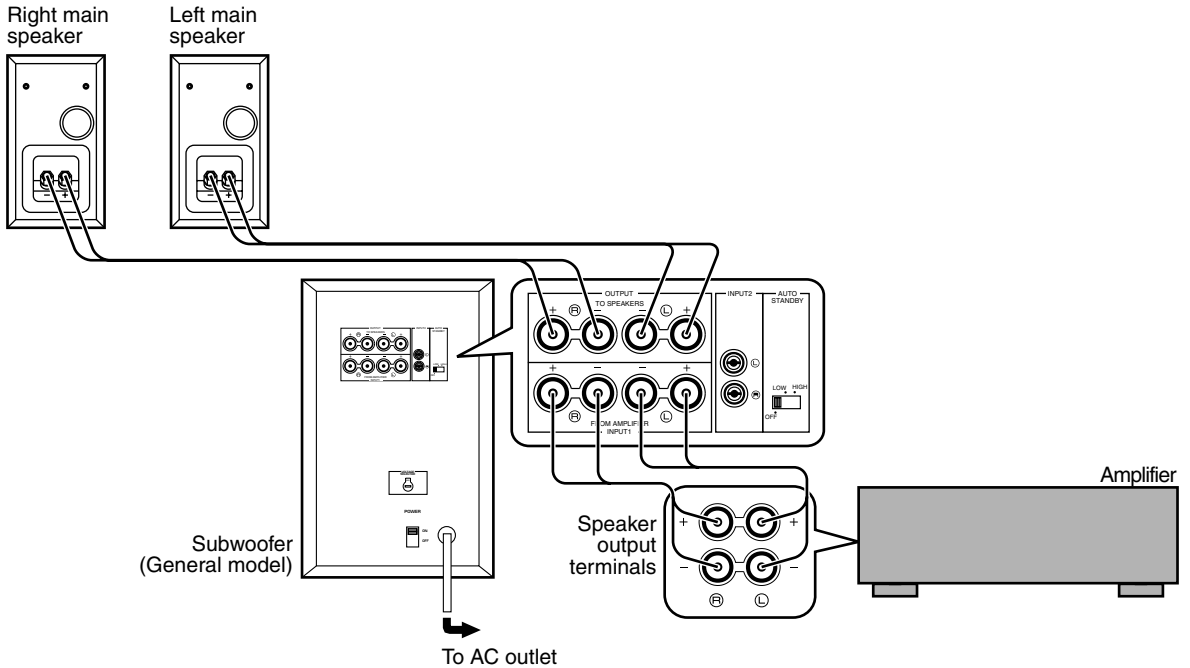

If your amplifier has two sets of speaker output terminals

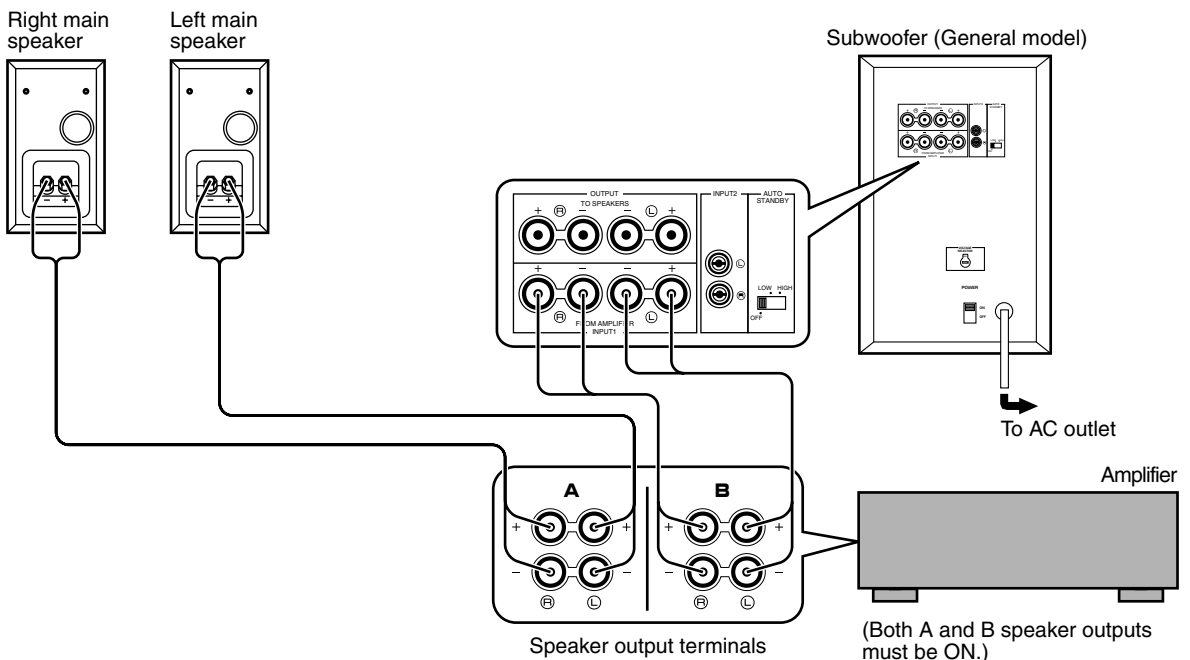

USING THE SUBWOOFER (YST-SW45)

■ Controls and their functions

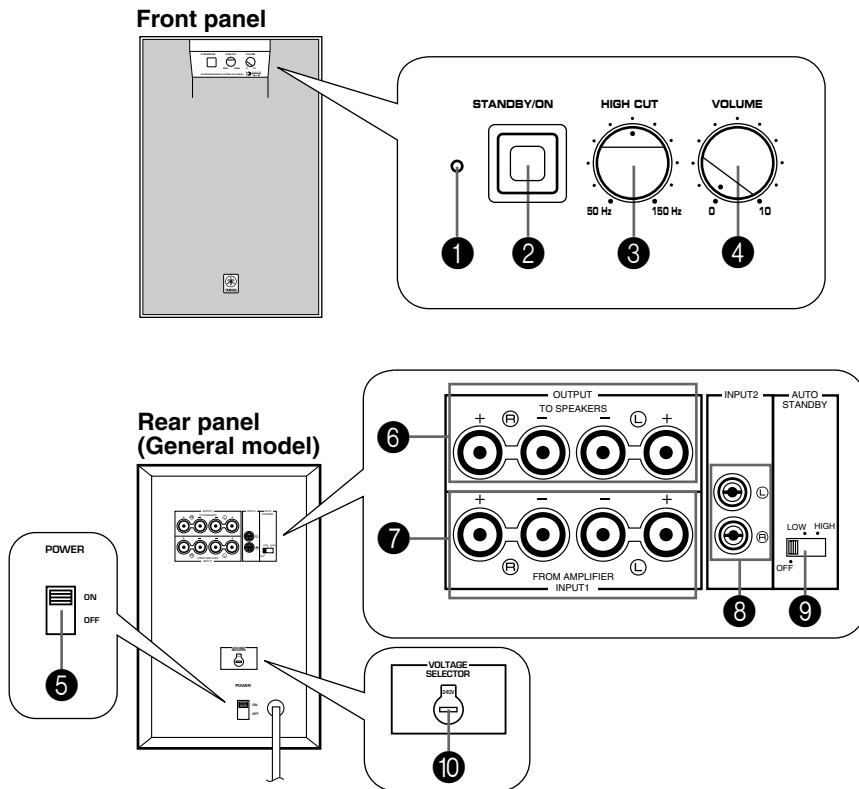

- 1** **Power indicator**
Lights up while the subwoofer is turned on.
* If the **STANDBY/ON** (2) button is pressed in and the **AUTO STANDBY** (9) switch is set to the HIGH or LOW position, this indicator lights up dimly when no signal is inputted to the subwoofer.
- 2** **STANDBY/ON** button
Press this button to turn on the power. Press again to set the subwoofer in the standby mode.
* This button can be used only when the **POWER** (5) switch is set in the ON position.

Standby mode

The subwoofer is still using a small amount of power in this mode.

- 3** **HIGH CUT** control
Adjusts the high frequency cut off point.
Frequencies higher than the frequency selected by this control are all cut off (and no output).
* One graduation of this control represents 10 Hz.

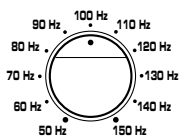

- 4** **VOLUME** control
Adjusts the volume level. Turn the control clockwise to increase the volume, and counterclockwise to decrease the volume.
- 5** **POWER** switch
Normally, set this switch to the ON position to use the subwoofer. In this state, you can turn on the subwoofer or turn the subwoofer into the standby mode by pressing the **STANDBY/ON** (2) button. Set this switch to the OFF position to completely cut off the subwoofer's power supply from the AC line.
- 6** **OUTPUT (TO SPEAKERS)** terminals
Can be used for connecting to the main speakers. Signals are sent directly from the amplifier to the main speakers by way of these terminals. (Refer to "**CONNECTIONS**" for details.)
- 7** **INPUT1 (FROM AMPLIFIER)** terminals
Used to connect the subwoofer with the speaker terminals of the amplifier. (Refer to "**CONNECTIONS**" for details.)

- 8 INPUT2 terminals**
Used to input line level signals from the amplifier. (Refer to "CONNECTIONS" for details.)
- 9 AUTO STANDBY (HIGH/LOW/OFF) switch**
This switch is originally set to the OFF position. By setting this switch to the HIGH or LOW position, the subwoofer's automatic power-switching function operates as described below. If you do not need this function, leave this switch in the OFF position.
* Make sure to change the setting of this switch only when the **STANDBY/ON (2)** button is not pressed in.
- 10 VOLTAGE SELECTOR switch (China and general models only)**
If the preset setting of the switch is incorrect, set the switch to the proper voltage range (220V-240V or 110V-120V) of your area.
Consult your dealer if you are unsure of the correct setting.
WARNING
Be sure to unplug the subwoofer before setting the VOLTAGE SELECTOR switch correctly.

■ Automatic power-switching function

If the source being played is stopped and the input signal is cut off for 7 to 8 minutes, the subwoofer automatically switches to the standby mode. (When the subwoofer switches to the standby mode, the power indicator (1) becomes dim.)

When you play a source again, the power of the subwoofer turns on automatically by sensing audio signals input to the subwoofer.

This function operates by sensing a certain level of low frequency input signal. Usually set the **AUTO STANDBY (9)** switch to the LOW position. However, if the power is not switched to ON or STANDBY smoothly, set the switch to the HIGH position. In the HIGH position, the power will turn on even with a low level of input signal. But please be aware that the subwoofer may not switch to the standby mode when there is an extremely low input signal.

- * The power might turn on unexpectedly by sensing noise from other appliances. If that occurs, set the **AUTO STANDBY (9)** switch to the OFF position and use the **POWER (5)** switch to switch the power between ON and OFF manually.
- * This function detects the low-frequency components below 200 Hz of the input signals (i.e., the explosion in the action movie, the sound of the bass guitar or the bass drum, etc.).
- * The minutes required to switch the subwoofer to the standby mode might change by sensing noise from other appliances.

This function is available only when the power of the subwoofer is on (by pressing the STANDBY/ON (2) button).

■ Adjusting the subwoofer before use

Before using the subwoofer, adjust the subwoofer to obtain the optimum volume and tone balance between the subwoofer and the main speakers by following the procedures described below.

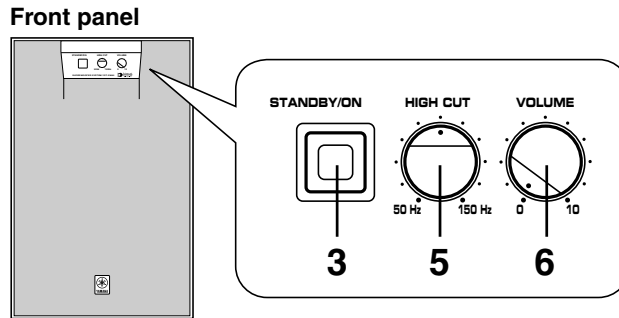

- 1 Set the **VOLUME** control of the amplifier to minimum (0).
- 2 Turn on the power of all the other components.
- 3 Press the **STANDBY/ON** button to turn on the subwoofer.
- 4 Play a source and adjust the amplifier's volume control to the desired listening level.
- 5 Adjust the **HIGH CUT** control to the position where the desired response can be obtained.
- 6 Increase the volume gradually to adjust the volume balance between the subwoofer and the main speakers.

Once the volume balance between the subwoofer and the main speakers is adjusted, you can adjust the volume of your whole sound system by using the amplifier's volume control. However, if you change the main speakers NS-10MMT to others, you must make this adjustment again.

This system is designed so that the optimum tone balance between the subwoofer and the main speakers (NS-10MMT) is obtained when this control is set at 110 Hz. However, the tone balance may change depending on the room size, the distance from the subwoofer to the main speakers, etc. So, if you prefer, turn the **HIGH CUT** control and set it to a position where a better tone balance is obtained.

■ Frequency characteristics

Adjustment of the **VOLUME** control and the **HIGH CUT** control should be changed depending on the room size, the distance from the subwoofer to the main speakers, sources, etc.

Following figures show the optimum adjustment of each control and the frequency characteristics when this subwoofer is combined with NS-10MMT.

Frequency characteristics of this subwoofer (YST-SW45)

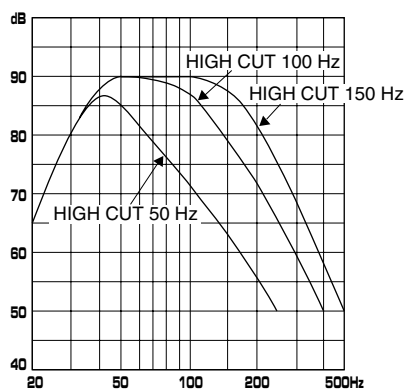

• When combined with NS-10MMT

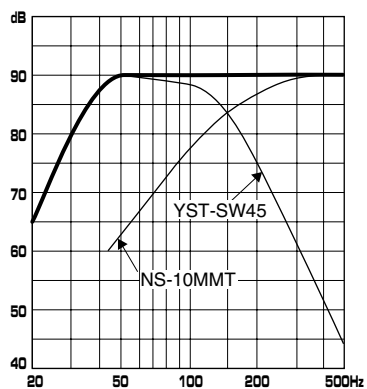
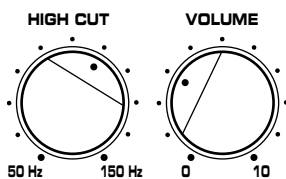

ADVANCED YAMAHA ACTIVE SERVO TECHNOLOGY (for YST-SW45)

The theory of Yamaha Active Servo Technology has been based upon two major factors, the Helmholtz resonator and negative-impedance drive. Active Servo Processing speakers reproduce the bass frequencies through an “air woofer”, which is a port or opening in the speaker’s cabinet. This opening is used instead of, and performs the functions of, a woofer in a conventionally designed speaker system. Thus, signals of low amplitude within the cabinet can, according to the Helmholtz resonance theory, be outputted from this opening as waves of great amplitude if the size of the opening and the volume of the cabinet are in the correct proportion to satisfy a certain ratio.

In order to accomplish this, moreover, the amplitudes within the cabinet must be both precise and of sufficient power because these amplitudes must overcome the “load” presented by the air that exists within the cabinet.

Thus it is this problem that is resolved through the employment of a new design in which the amplifier supplies special signals. If the electrical resistance of the voice coil could be reduced to zero, the movement of the speaker unit would become linear with respect to signal voltage. To accomplish this, a special negative-impedance output-drive amplifier for subtracting output impedance of the amplifier is used.

By employing negative-impedance drive circuits, the amplifier is able to generate precise, low-amplitude, low-frequency waves with superior damping characteristics. These waves are then radiated from the cabinet opening as high-amplitude signals. The system can, therefore, by employing the negative-impedance output drive amplifier and a speaker cabinet with the Helmholtz resonator, reproduce an extremely wide range of frequencies with amazing sound quality and less distortion.

The features described above, then, are combined to be the fundamental structure of the conventional Yamaha Active Servo Technology.

Our new Active Servo Technology — Advanced Yamaha Active Servo Technology — adopted Advanced Negative Impedance Converter (ANIC) circuits, which allows the conventional negative impedance converter to dynamically vary in order to select an optimum value for speaker impedance variation. With this new ANIC circuits, Advanced Yamaha Active Servo Technology can provide more stable performance and improved sound pressure compared with the conventional Yamaha Active Servo Technology, resulting in more natural and dynamic bass reproduction.

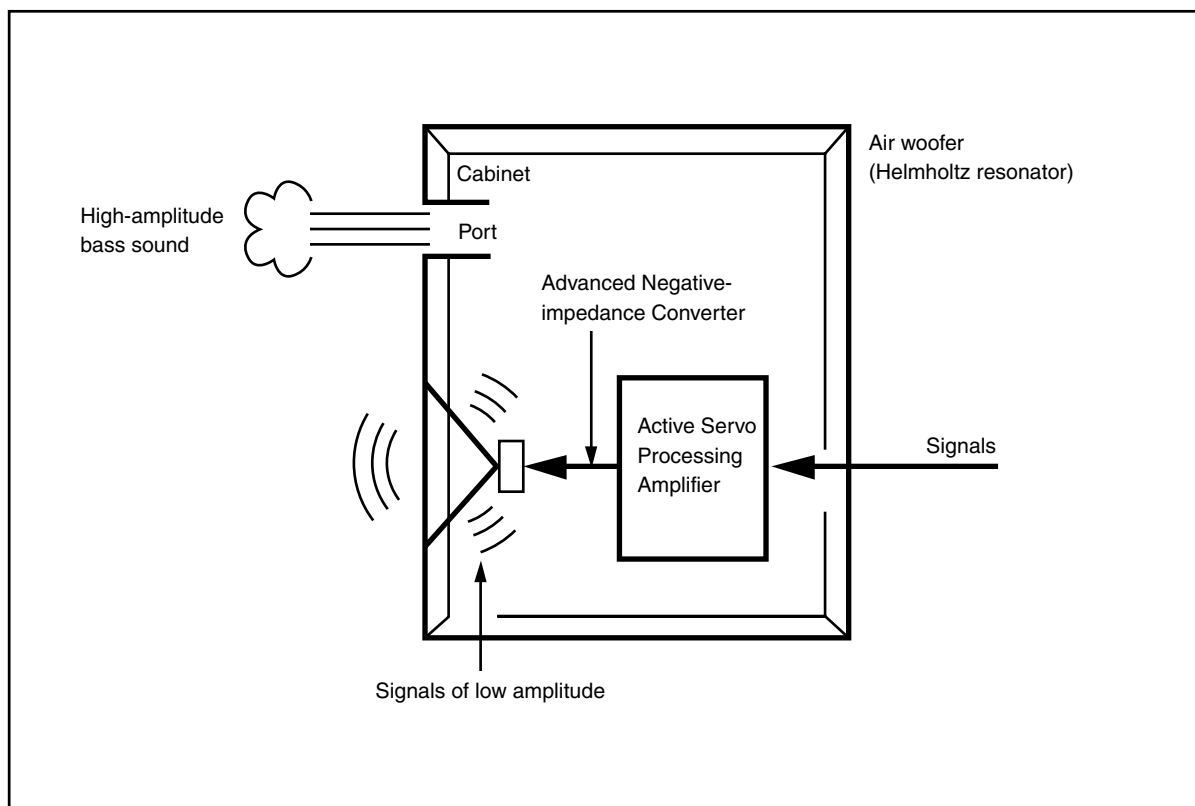

TROUBLESHOOTING

Refer to the chart below when this unit does not function properly. If the problem you are experiencing is not listed below or if the instructions given below do not help, disconnect the power cord and contact your authorized YAMAHA dealer or service center.

Problem	Cause	What to Do
No sound.	Speaker cords are not connected securely.	Connect them securely.
Sound level is too low.	Speaker cords are not connected correctly.	Connect them correctly, that is L (left) to L, R (right) to R, "+" to "+" and "-" to "-".

For YST-SW45

Power is not supplied even though the STANDBY/ON button is pressed in.	The power cord is not plugged in, or the POWER switch is set to the OFF position.	Plug the power cord into an AC outlet and/or set the POWER switch to the ON position.
No sound.	The VOLUME control is set to 0.	Turn the VOLUME control to the right.
Sound level is too low.	A source sound with few bass frequencies is played.	Play a source sound with bass frequencies. Set the HIGH CUT control to a higher position.
	It is influenced by standing waves.	Reposition the subwoofer or break up the parallel surface by placing bookshelves etc. along the walls.
The subwoofer will not turn on automatically.	The POWER switch is set to the OFF position.	Set the POWER switch to the ON position.
	The STANDBY/ON button is set to OFF.	Set the STANDBY/ON button to ON.
	The AUTO STANDBY switch is set to the OFF position.	Set the AUTO STANDBY switch to the "HIGH" or "LOW" position.
	The level of input signal is too low.	Set the AUTO STANDBY switch to the "HIGH" position.
The subwoofer turns into the standby mode unexpectedly.	The level of input signal is too low.	Set the AUTO STANDBY switch to the "HIGH" position.
The subwoofer turns on unexpectedly.	There is an influence of noise generated from external appliances etc.	Move the subwoofer farther away from such appliances and/or reposition the connected speaker cables. Otherwise, set the AUTO STANDBY switch to the "OFF" position.

SPECIFICATIONS

NS-10MMT

Type 2-way 2-speaker bass-reflex speaker system
Magnetically shielded type

Driver

Woofers 9 cm (3-9/16") cone type

Tweeter 2.5 cm (1") balanced dome type

Nominal Input Power 40W

Maximum Input Power 100W

Impedance 6Ω

Frequency Response 75 Hz – 33 kHz

Sensitivity 88 dB/2.83V/m

Crossover Frequency 7 kHz

Dimensions (W x H x D) 107 mm x 191 mm x 141 mm
(4-3/16" x 7-1/2" x 5-9/16")

Weight 1.5 kg (3 lbs. 5 oz.) x 4

NS-C10MM

Type 2-way 3-speaker bass-reflex speaker system
Magnetically shielded type

Driver

Woofers 9 cm (3-9/16") cone type x 2

Tweeter 2.5 cm (1") balanced dome type

Nominal Input Power 50W

Maximum Input Power 125W

Impedance 6Ω

Frequency Response 100 Hz – 33 kHz

Sensitivity 91 dB/2.83V/m

Crossover Frequency 7 kHz

Dimensions (W x H x D) 312 mm x 101 mm x 141 mm
(12-5/16" x 4" x 5-9/16")

Weight 2.3 kg (5 lbs. 1 oz.)

YST-SW45

Type Active Servo Processing Subwoofer System

Driver 20 cm (8") cone woofer (JA2162)
Magnetically shielded type

Amplifier Output 70W/5Ω

High-Cut Filter 50 Hz – 150 Hz (–24 dB/oct.)

Frequency Response 30 Hz – 200 Hz (–10 dB)

Power Supply

U.S.A. and Canada models AC 120V, 60 Hz

U.K. and Europe models AC 230V, 50 Hz

Australia model AC 240V, 50 Hz

China and General models
..... AC 110-120/220-240V, 50/60 Hz

Power Consumption 55W

Dimensions (W x H x D) 235 mm x 365 mm x 318 mm
(9-5/16" x 14-7/20" x 12-1/2")

Weight 9 kg (19 lbs. 13 oz.)

Accessories

Pin plug cord [3 m (9.8 feet)] x 1
Speaker cord [10 m (32.8 feet)] x 4
Speaker cord [4 m (13.1 feet)] x 3
Mounting bracket x 4
Screw x 8
Pad (for NS-10MMT) x 8
Fastener x 4
Rubber pad (for YST-SW45) x 4

* Please note that all specifications are subject to change without notice.



YAMAHA ELECTRONICS CORPORATION, USA 6660 ORANGETHORPE AVE., BUENA PARK, CALIF. 90620, U.S.A.
YAMAHA CANADA MUSIC LTD. 135 MILNER AVE., SCARBOROUGH, ONTARIO M1S 3R1, CANADA
YAMAHA ELECTRONIK EUROPA G.m.b.H. SIEMENSSTR, 22-34, 25462 RELLINGEN, BEI HAMBURG, F.R. OF GERMANY
YAMAHA ELECTRONIQUE FRANCE S.A. RUE AMBROISE CROIZAT BP70 CROISSY-BEAUBOURG 77312 MARNE-LA-VALLEE CEDEX02, FRANCE
YAMAHA ELECTRONICS (UK) LTD. YAMAHA HOUSE, 200 RICKMANSWORTH ROAD WATFORD, HERTS WD1 7JS, ENGLAND
YAMAHA SCANDINAVIA A.B. J A WETTERGRENS GATA 1, BOX 30053, 400 43 VASTRA FROLUNDA, SWEDEN
YAMAHA MUSIC AUSTRALIA PTY, LTD. 17-33 MARKET ST., SOUTH MELBOURNE, 3205 VIC., AUSTRALIA

YAMAHA CORPORATION
Printed in Indonesia  V635230-2