

IMPORTANT**Check your power supply**

Make sure that your local AC mains voltage matches the voltage specified on the name plate on the bottom panel. In some areas a voltage selector may be provided on the rear of the main unit near the power cord. Make sure that the voltage selector is set for the voltage in your area. The voltage selector is set at 240V when the unit is initially shipped. To change the setting use a "minus" screwdriver to rotate the selector dial so that the correct voltage appears next to the pointer on the panel.

WICHTIG**Überprüfung der Stromversorgung**

Vergewissern Sie sich vor dem Anschließen an das Stromnetz, daß die örtliche Netzspannung den Betriebsspannungswerten auf dem Typenschild an der Unterseite des Instruments entspricht. In bestimmten Regionen ist auf der Rückseite des Instruments in der Nähe des Netzkabels ein Spannungswähler angebracht. Falls vorhanden, muß der Spannungswähler auf die örtliche Netzspannung eingestellt werden. Der Spannungswähler wurde werkseitig auf 240 V voreingestellt. Zum Verstellen drehen Sie den Spannungsregler mit einem Schlitzschraubendreher, bis der Zeiger auf den korrekten Spannungswert weist.

IMPORTANT**Contrôler la source d'alimentation**

Vérifiez que la tension spécifiée sur le panneau inférieur correspond à la tension du secteur. Dans certaines régions, l'instrument peut être équipé d'un sélecteur de tension à l'arrière de l'unité principale, à côté du cordon d'alimentation.

Vérifiez que ce sélecteur est bien réglé en fonction de la tension secteur de votre région. Le sélecteur de tension est réglé sur 240 V au départ d'usine. Pour modifier ce réglage, utilisez un tournevis à lame plate pour tourner le sélecteur afin de mettre l'indication correspondant à la tension de votre région vis à vis du repère triangulaire situé sur le panneau.

IMPORTANTE**Verifique la alimentación de corriente**

Asegúrese de que tensión de alimentación de CA de su área corresponde con la tensión especificada en la placa de características del panel inferior. Es posible que en algunas zonas se suministre un selector de tensión en la parte posterior de la unidad principal, junto al cable de alimentación.

Asegúrese de que el selector de tensión esté ajustado a la tensión de su área. El selector de tensión se ajusta a 240V cuando la unidad sale de fábrica. Para cambiar el ajuste, emplee un destornillador de cabeza "recta" para girar el selector de modo que aparezca la tensión correcta al lado del indicador del panel.

CLP-F01

Owner's Manual Bedienungsanleitung Mode d'emploi Manual de instrucciones

For information on assembling the keyboard stand, refer to the instructions at the end of this manual.

Weitere Informationen über die Montage des Keyboard-Ständers erhalten Sie in den Anweisungen am Ende dieses Handbuchs.

Pour obtenir les détails sur l'assemblage du pupitre du clavier, reportez-vous aux instructions figurant à la fin de ce manuel.

Para información sobre el montaje del soporte del teclado, consulte las instrucciones al final de este manual.

ENGLISH

DEUTSCH

FRANÇAIS

ESPAÑOL

Clavinova®

EN
DE
FR
ES

SPECIAL MESSAGE SECTION

PRODUCT SAFETY MARKINGS: Yamaha electronic products may have either labels similar to the graphics shown below or molded/stamped facsimiles of these graphics on the enclosure. The explanation of these graphics appears on this page. Please observe all cautions indicated on this page and those indicated in the safety instruction section.

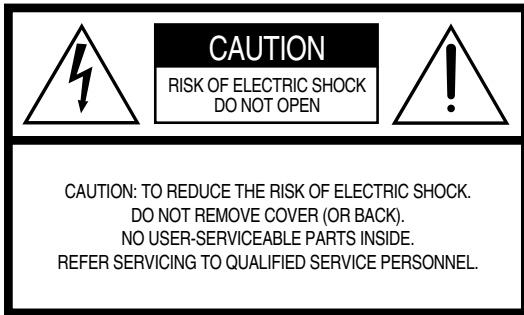

See bottom of Keyboard enclosure for graphic symbol markings.



The exclamation point within the equilateral triangle is intended to alert the user to the presence of important operating and maintenance (servicing) instructions in the literature accompanying the product.

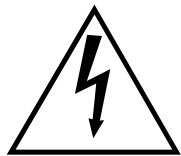

The lightning flash with arrowhead symbol, within the equilateral triangle, is intended to alert the user to the presence of uninsulated “dangerous voltage” within the product’s enclosure that may be of sufficient magnitude to constitute a risk of electrical shock.

IMPORTANT NOTICE: All Yamaha electronic products are tested and approved by an independent safety testing laboratory in order that you may be sure that when it is properly installed and used in its normal and customary manner, all foreseeable risks have been eliminated. **DO NOT** modify this unit or commission others to do so unless specifically authorized by Yamaha. Product performance and/or safety standards may be diminished. Claims filed under the expressed warranty may be denied if the unit is/has been modified. Implied warranties may also be affected.

SPECIFICATIONS SUBJECT TO CHANGE: The information contained in this manual is believed to be correct at the time of printing. However, Yamaha reserves the right to change or modify any of the specifications without notice or obligation to update existing units.

ENVIRONMENTAL ISSUES: Yamaha strives to produce products that are both user safe and environmentally friendly. We sincerely believe that our products and the production methods used to produce them, meet these goals. In keeping with both the letter and the spirit of the law, we want you to be aware of the following:

Battery Notice: This product MAY contain a small non-rechargeable battery which (if applicable) is soldered in place. The average life span of this type of battery is approximately five years. When replacement becomes necessary, contact a qualified service representative to perform the replacement.

Warning: Do not attempt to recharge, disassemble, or incinerate this type of battery. Keep all batteries away from children. Dispose of used batteries promptly and as regulated by applicable laws. Note: In some areas, the servicer is required by law to return the defective parts. However, you do have the option of having the servicer dispose of these parts for you.

Disposal Notice: Should this product become damaged beyond repair, or for some reason its useful life is considered to be at an end, please observe all local, state, and federal regulations that relate to the disposal of products that contain lead, batteries, plastics, etc.

NOTICE: Service charges incurred due to lack of knowledge relating to how a function or effect works (when the unit is operating as designed) are not covered by the manufacturer’s warranty, and are therefore the owners responsibility. Please study this manual carefully and consult your dealer before requesting service.

NAME PLATE LOCATION: The graphic below indicates the location of the name plate. The model number, serial number, power requirements, etc., are located on this plate. You should record the model number, serial number, and the date of purchase in the spaces provided below and retain this manual as a permanent record of your purchase.

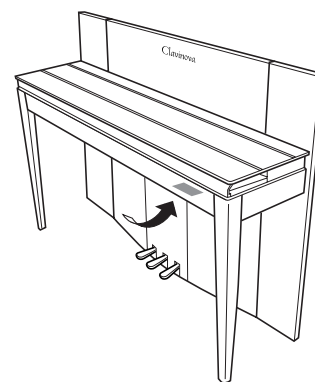

Model _____

Serial No. _____

Purchase Date _____

PRECAUTIONS

PLEASE READ CAREFULLY BEFORE PROCEEDING

* Please keep this manual in a safe place for future reference.



WARNING

Always follow the basic precautions listed below to avoid the possibility of serious injury or even death from electrical shock, short-circuiting, damages, fire or other hazards. These precautions include, but are not limited to, the following:

Power supply/Power cord

- Only use the voltage specified as correct for the instrument. The required voltage is printed on the name plate of the instrument.
- Check the electric plug periodically and remove any dirt or dust which may have accumulated on it.
- Use only the supplied power cord/plug.
- Do not place the power cord near heat sources such as heaters or radiators, and do not excessively bend or otherwise damage the cord, place heavy objects on it, or place it in a position where anyone could walk on, trip over, or roll anything over it.

Do not open

- Do not open the instrument or attempt to disassemble the internal parts or modify them in any way. The instrument contains no user-serviceable parts. If it should appear to be malfunctioning, discontinue use immediately and have it inspected by qualified Yamaha service personnel.

Water warning

- Do not expose the instrument to rain, use it near water or in damp or wet conditions, or place containers on it containing liquids which might spill into any openings.
- Never insert or remove an electric plug with wet hands.

Fire warning

- Do not put burning items, such as candles, on the unit. A burning item may fall over and cause a fire.

If you notice any abnormality

- If the power cord or plug becomes frayed or damaged, or if there is a sudden loss of sound during use of the instrument, or if any unusual smells or smoke should appear to be caused by it, immediately turn off the power switch, disconnect the electric plug from the outlet, and have the instrument inspected by qualified Yamaha service personnel.



CAUTION

Always follow the basic precautions listed below to avoid the possibility of physical injury to you or others, or damage to the instrument or other property. These precautions include, but are not limited to, the following:

Power supply/Power cord

- When removing the electric plug from the instrument or an outlet, always hold the plug itself and not the cord. Pulling by the cord can damage it.
- Remove the electric plug from the outlet when the instrument is not to be used for extended periods of time, or during electrical storms.
- Do not connect the instrument to an electrical outlet using a multiple-connector. Doing so can result in lower sound quality, or possibly cause overheating in the outlet.

Assembly

- Read carefully the attached documentation explaining the assembly process. Failure to assemble the instrument in the proper sequence might result in damage to the instrument or even injury.

Location

- Do not expose the instrument to excessive dust or vibrations, or extreme cold or heat (such as in direct sunlight, near a heater, or in a car during the day) to prevent the possibility of panel disfiguration or damage to the internal components.
- Do not use the instrument in the vicinity of a TV, radio, stereo equipment, mobile phone, or other electric devices. Otherwise, the instrument, TV, or radio may generate noise.
- Do not place the instrument in an unstable position where it might accidentally fall over.
- Before moving the instrument, remove all connected cables.

Connections

- Before connecting the instrument to other electronic components, turn off the power for all components. Before turning the power on or off for all components, set all volume levels to minimum. Also, be sure to set the volumes of all components at their minimum levels and gradually raise the volume controls while playing the instrument to set the desired listening level.

Maintenance

- Gently remove dust and dirt with a soft cloth. Do not wipe too hard since small particles of dirt can scratch the instrument's finish.
- When cleaning the instrument, use a soft, dry or slightly damp cloth. Do not use paint thinners, solvents, cleaning fluids, or chemical-impregnated wiping cloths.

Handling caution

- Take care that the key cover does not pinch your fingers, and do not insert a finger or hand in any gaps on the key cover or instrument.
- Never insert or drop paper, metallic, or other objects into the gaps on the key cover, panel or keyboard. If this happens, turn off the power immediately and unplug the power cord from the AC outlet. Then have the instrument inspected by qualified Yamaha service personnel.
- Do not place vinyl, plastic or rubber objects on the instrument, since this might discolor the panel or keyboard.
- Bumping the surface of the instrument with metal, porcelain, or other hard objects can cause the finish to crack or peel. Use caution.
- Do not rest your weight on, or place heavy objects on the instrument, and do not use excessive force on the buttons, switches or connectors.
- Do not operate the instrument for a long period of time at a high or uncomfortable volume level, since this can cause permanent hearing loss. If you experience any hearing loss or ringing in the ears, consult a physician.

Using the bench (if included)

- Do not place the bench in an unstable position where it might accidentally fall over.
- Do not play carelessly with or stand on the bench. Using it as a tool or step-ladder or for any other purpose might result in accident or injury.
- Only one person should sit on the bench at a time, in order to prevent the possibility of accident or injury.
- If the bench screws become loose due to extensive long-term use, tighten them periodically using the included tool.

Yamaha cannot be held responsible for damage caused by improper use or modifications to the instrument, or data that is lost or destroyed.

Always turn the power off when the instrument is not in use.

Saving data

Saving and backing up your data

- Depending upon the Backup Settings (page 50), internal data is retained for about 1 week after the power is turned off. If the period is exceeded, the data will be lost. Be sure to turn the power switch on for a few minutes at least once a week. The data could be lost due to malfunction or incorrect operation. Save important data to external media such as the Yamaha MDF3 MIDI data filer.

Backing up the external media

- To protect against data loss through media damage, we recommend that you save your important data onto two external media.

Thank you for purchasing the Yamaha Clavinova! We recommend that you read this manual carefully so that you can fully take advantage of the advanced and convenient functions of the Clavinova.
We also recommend that you keep this manual in a safe and handy place for future reference.

About this Owner's Manual

This manual consists of three main sections: "Introduction," "Reference" and "Appendix."

■ Introduction (page 2):

Please read this section first.

■ Reference (page 15):

This section explains how to make detailed settings for the Clavinova's various functions.

■ Appendix (page 67):

This section introduces reference material.

- * The models CLP-F01 will be referred to as the CLP/Clavinova in this Owner's Manual.
- * The illustrations and LED displays shown in this owner's manual are for instructional purposes only and may appear somewhat different from those on your instrument.

COPYRIGHT NOTICE

This product incorporates and bundles computer programs and contents in which Yamaha owns copyrights or with respect to which it has license to use others' copyrights. Such copyrighted materials include, without limitation, all computer software, MIDI files, WAVE data. Any unauthorized use of such programs and contents outside of personal use is not permitted under relevant laws. Any violation of copyright has legal consequences. DON'T MAKE, DISTRIBUTE OR USE ILLEGAL COPIES.

Trademarks:

- Apple and Macintosh are trademarks of Apple Computer, Inc.
- Windows is a registered trademark of Microsoft® Corporation.
- All other trademarks are the property of their respective holders.

"The Clavinova-Computer Connection," is a supplementary guidebook that describes, for beginners, what you can do with your Clavinova and a personal computer and how to set up a Clavinova-Computer system (the manual is not written for any specific models). The document is available as a PDF file (in English) at the following Internet address.

Yamaha Manual Library:

<http://www2.yamaha.co.jp/manual/english/>

Table of Contents

Introduction

Application Index	7
Accessories	8
Features	9
Before Using the Clavinova	10
Key Cover	10
Music Rest	11
Turning the Power On.....	12
Setting the Volume.....	13
Using Headphones (option).....	13
Using the Speaker Switch.....	13

Reference

Panel Controls and Terminals	16
Listening to the Demonstration Tunes	18
Listening to 50 Piano Preset Songs	19
Practicing a One-Hand Part Using 50 Preset Songs (Part Cancel Function)	20
A-B Repeat for 50 Preset Songs	22
Selecting & Playing Voices	23
Selecting Voices	23
Using the Pedals	23
Adding Variations to the Sound – [VARIATION]/[BRILLIANCE]/ [REVERB]/[EFFECT].....	24
Touch Sensitivity – [TOUCH]	26
Transposition – [TRANSCOPE].....	27
Combining Two Voices (Dual mode).....	28
Splitting the Keyboard Range and Playing Two Different Voices (Split mode).....	29
Using the Metronome.....	31
Recording Your Performance	32
Recording to [TRACK 1]	32
Re-recording TRACK 1.....	34
Recording to [TRACK 2].....	34
Changing the Initial Settings (Data recorded at the beginning of a song)	36

Playing Back Recorded Songs	37
Playing Back a Song.....	37
Useful Playback Functions	38
Detailed Settings – [FUNCTION]	39
Basic Procedure in Function Mode	40
About Each Function.....	42
F1. Fine Tuning of the Pitch.....	42
F2. Selecting a Scale.....	43
F3. Dual Mode Functions	44
F4. Split Mode Functions.....	45
F5. Other Functions	46
F6. Metronome Volume	47
F7. Preset Song Part Cancel Volume.....	47
F8. MIDI Functions.....	47
F9. Backup Functions.....	50
About MIDI	51
Connections	52
Connectors.....	52
Connecting a Personal Computer	54
Troubleshooting	58
Keyboard Stand Assembly	59
Preset Voice List	62
Demo Song List	64
Index	65

Appendix

Factory Setting List	68
MIDI Data Format	69
MIDI Implementation Chart	73
Specifications	74

Application Index

Use this index to find reference pages that may be helpful for your particular application and situation.

Listening

- Listening to demo songs with different voices..... “Listening to the Demonstration Tunes” on page 18
- Listening to songs from “50 Greats for the Piano” “Listening to 50 Piano Preset Songs” on page 19
- Listening to my recorded performance “Playing Back Recorded Songs” on page 37

Playing

- Using the three performance control pedals..... “Using the Pedals” on page 23
- Playing an accompaniment that matches pitch “Transposition – [TRANSCOPE]” on page 27
- Selecting a touch sensitivity type..... “Touch Sensitivity – [TOUCH]” on page 26
- Fine tuning the pitch of the entire instrument when you play the Clavinova along with other instruments or CD music “Fine tuning of the pitch” on page 42

Changing voices

- Viewing the list of voices..... “Preset Voice List” on page 62
- Simulating a concert hall “[REVERB]” on page 24
- Combining two voices..... “Combining Two Voices (Dual mode)” on page 28
- Playing different sounds with left and right hands “Splitting the Keyboard Range and Playing Two Different Voices (Split mode)” on page 29
- Making the sound more brilliant or mellower “[BRILLIANCE]” on page 24
- Adding spread or swell to the sound “[EFFECT]” on page 25
- Enhancing the sound with effects..... “[VARIATION]” on page 24

Practicing

- Muting the right- or left-hand part “Practicing a One-Hand Part Using 50 Preset Songs (Part Cancel Function)” on page 20
- Practicing a specified phrase repeatedly..... “A-B Repeat for 50 Preset Songs” on page 22
- Practicing with an accurate and steady tempo “Using the Metronome” on page 31
- Practicing using your recorded song..... “Recording Your Performance” on page 32

Recording

- Recording your performance..... “Recording Your Performance” on page 32

Settings

- Adjusting the Clavinova settings “Detailed Settings – [FUNCTION]” on page 39

Connecting the Clavinova to other devices

- What is MIDI? “About MIDI” on page 51
- Recording your performance..... “AUX OUT jacks” on page 52
- Raising the volume “AUX OUT jacks” on page 52
- Outputting other instruments’ sound from the Clavinova..... “AUX IN jacks” on page 53
- Connecting a computer “Connecting a Personal Computer” on page 54

Assembling

- Assembling and disassembling the Clavinova “Keyboard Stand Assembly” on pages page 59–61

Accessories

- “50 Greats for the Piano” (Music Book)
- Owner’s Manual
This manual contains complete instructions for operating your Clavinova.
- Bench
A bench may be included or optional, depending on your locale.

■ Tuning

Unlike an acoustic piano, the Clavinova does not need to be tuned. It always stays perfectly in tune.

■ Transporting

If you move to another location, you can transport the Clavinova along with your other belongings. You can move the unit as it is (assembled) or you can disassemble the unit.

Transport the keyboard horizontally. Do not lean it up against a wall or stand it up on its side. Do not subject the instrument to excessive vibration or shock.

Features

The Yamaha Clavinova CLP-F01 digital piano offers unmatched sonic realism and natural grand-piano type playability as well as Yamaha's original "AWM Dynamic Stereo Sampling" tone-generation technology for rich, musical voices, and a newly wooden keyboard that provides graded key weight and response throughout the keyboard range.

The Grand Piano 1, 2 and 3 voices feature totally samples painstakingly recorded from a full concert grand piano. The Grand Piano 1 and 3 voices feature three velocity-switched samples (Dynamic Sampling), special "Sustain Sampling" (page 88) that samples the unique resonance of an acoustic grand piano's soundboard and strings when the damper pedal is pressed, and "Keyoff Samples" that add the subtle sound produced when the keys are released. The CLP-F01 comes much closer to the sound of a true acoustic piano.

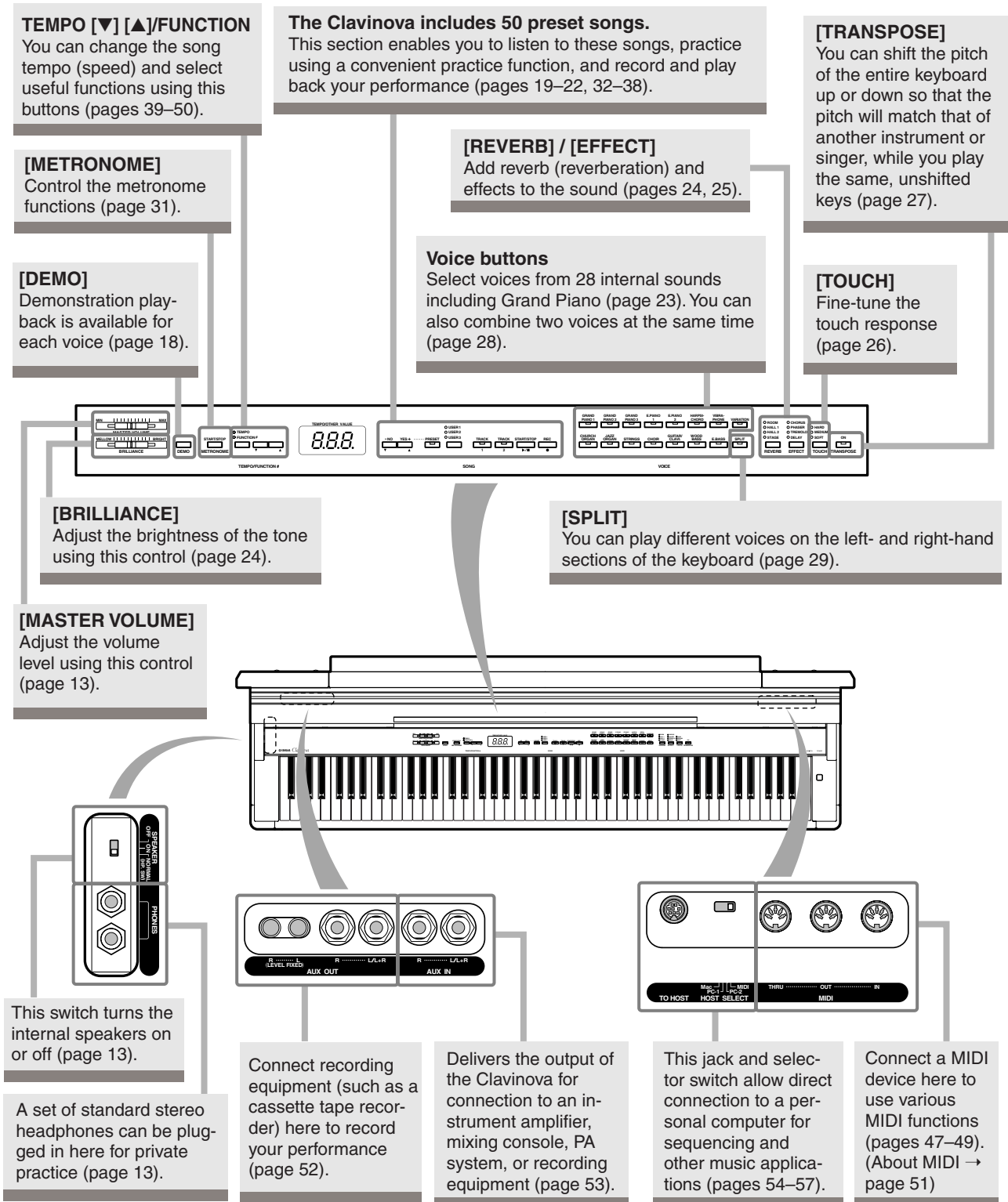

ENGLISH

Before Using the Clavinova

Key Cover

To open the key cover:

1. To open the cover, insert your fingers in the indentations on its front, lift the cover gently and fold it back.

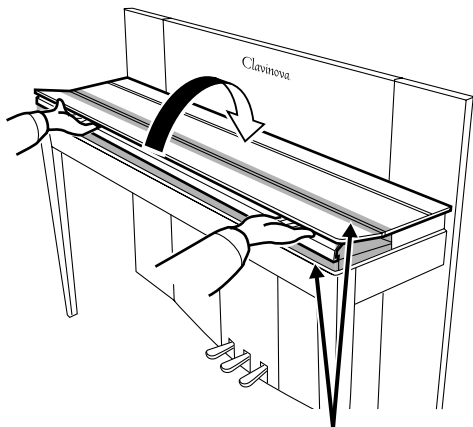

CAUTION
Be careful to avoid catching your fingers when opening or closing the cover.

2. Raise the folded cover and lean it against the front panel.

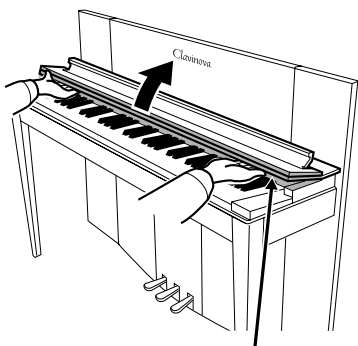

CAUTION
Be careful to avoid catching your fingers when opening or closing the cover.

To close the key cover:

1. If the music rest (page 11) is raised, lift it up and against the cover.
2. Pull the cover down and toward yourself gently.

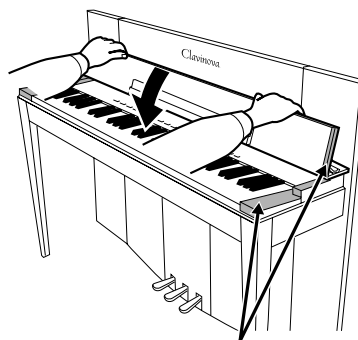

CAUTION
Be careful to avoid catching your fingers when opening or closing the cover.

3. Unfold the cover and gently lower its front half.

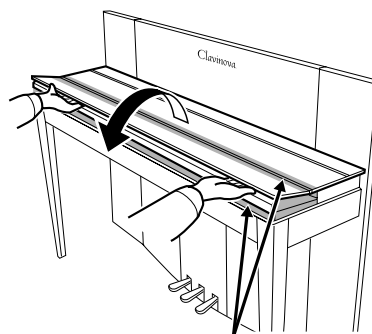

CAUTION
Be careful to avoid catching your fingers when opening or closing the cover.

CAUTION

Hold the key cover with both hands when opening or closing it, and do not release it until it is fully opened or closed. Be careful to avoid catching fingers (yours or others, and especially those of children) in folding portion or between the cover and main unit.

Music Rest

The music rest is attached to the inside of the key cover.

To position the music rest for use:

Pull the music rest on the cover down and toward yourself.

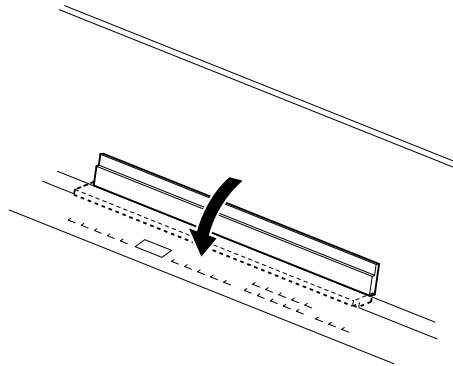

To replace the music rest:

Lift the music rest up and against the cover.

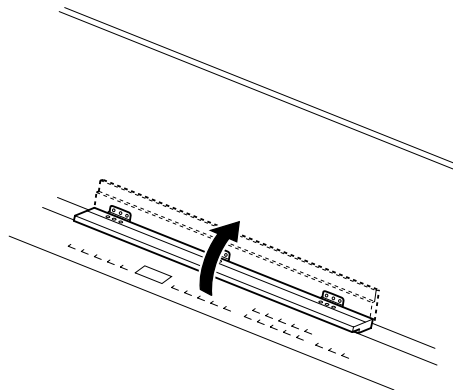

Turning the Power On

1. Connect the power cord.

Insert the plugs at the ends of the cord, one into the AC INLET on the Clavinova, and the other into a standard AC outlet.

In some areas, a plug adaptor may be provided to match the pin configuration of the AC wall outlets in your area.

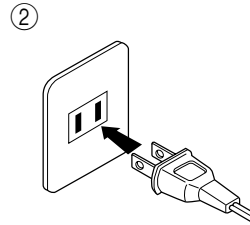
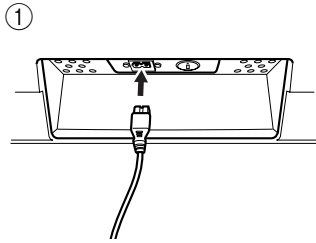

(The shape of plug differs depending on locale.)

2. Turn the power on.

Press the **[POWER]** button.

- The display located in the center of the front panel and the power indicator located below the left end of the keyboard lights up.

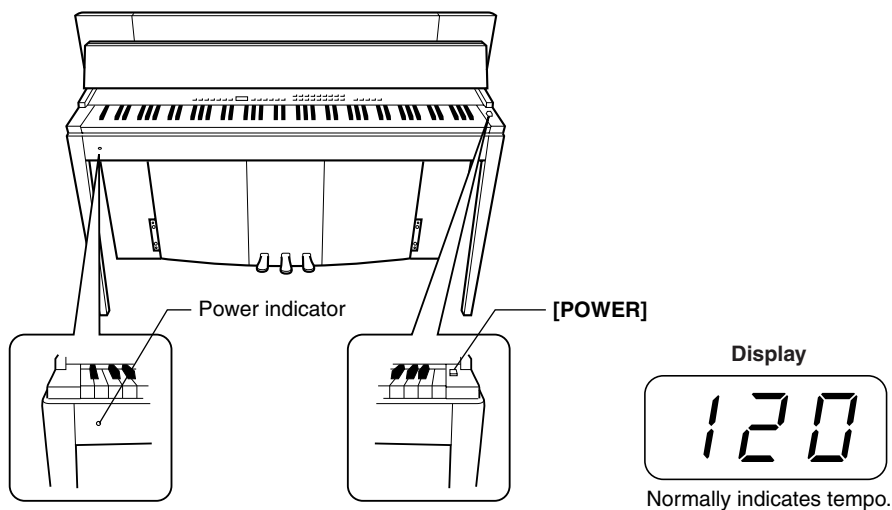

When you're ready to turn off the power, press the **[POWER]** button again.

- The display and the power indicator turn off.

TIP

Power indicator

If you close the key cover without turning the power off, the power indicator remains lit, indicating that the power is still on.

Setting the Volume

Initially set the [MASTER VOLUME] control about halfway between the “MIN” and “MAX” settings. Then, when you start playing, re-adjust the [MASTER VOLUME] control to the most comfortable listening level.

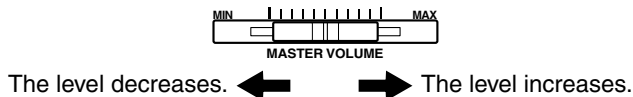

CAUTION

Do not use the Clavinova at a high volume level for a long period of time, or your hearing may be damaged.

TERMINOLOGY

MASTER VOLUME:
The volume level of the entire keyboard sound.

TIP

You can also adjust the [PHONES] output level and the AUX IN input level using the [MASTER VOLUME] control.

Using Headphones (option)

Connect a pair of headphones to one of the [PHONES] jacks.

Two [PHONES] jacks are provided.

You can connect two sets of standard stereo headphones. (If you are using only one pair of headphones, you can plug them into either jack.)

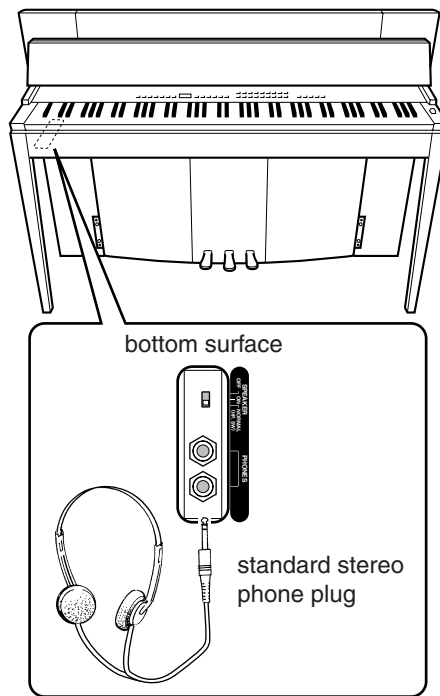

Using the Speaker Switch

This switch turns the internal speakers on or off.

NORMAL (HP. SW) The speakers produce sound as long as a pair of headphones is not connected.

ON The speakers always produce sound.

OFF The speakers produce no sound.

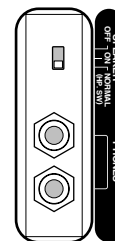

MEMO

Reference

This section explains how to make detailed settings for the Clavinova's various functions.

Panel Controls and Terminals	16	F6. Metronome Volume	47
Listening to the Demonstration Tunes	18	F7. Preset Song Part Cancel Volume	47
Listening to 50 Piano Preset Songs.....	19	F8. MIDI Functions.....	47
Practicing a One-Hand Part Using 50 Preset Songs (Part Cancel Function).....	20	F9. Backup Functions.....	50
A-B Repeat for 50 Preset Songs	22	About MIDI.....	51
Selecting & Playing Voices	23	Connections	52
Selecting Voices	23	Connectors	52
Using the Pedals	23	Connecting a Personal Computer	54
Adding Variations to the Sound – [VARIATION]/ [BRILLIANCE]/[REVERB]/[EFFECT]	24	Troubleshooting.....	58
Touch Sensitivity – [TOUCH].....	26	Keyboard Stand Assembly	59
Transposition – [TRANPOSE]	27	Preset Voice List.....	62
Combining Two Voices (Dual mode).....	28	Demo Song List.....	64
Splitting the Keyboard Range and Playing Two Different Voices (Split mode)	29	Index.....	65
Using the Metronome	31		
Recording Your Performance.....	32		
Recording to [TRACK 1]	32		
Re-recording TRACK 1.....	34		
Recording to [TRACK 2]	34		
Changing the Initial Settings (Data recorded at the beginning of a song).....	36		
Playing Back Recorded Songs	37		
Playing Back a Song	37		
Useful Playback Functions.....	38		
Detailed Settings – [FUNCTION].....	39		
Basic Procedure in Function Mode.....	40		
About Each Function	42		
F1. Fine Tuning of the Pitch	42		
F2. Selecting a Scale.....	43		
F3. Dual Mode Functions	44		
F4. Split Mode Functions	45		
F5. Other Functions.....	46		

Panel Controls and Terminals

Top panel

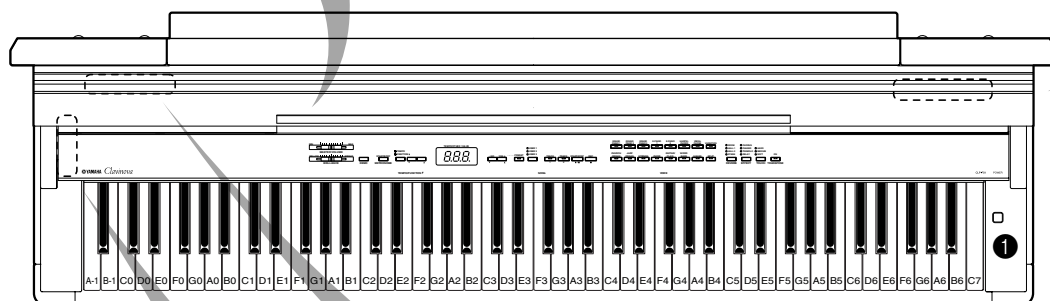
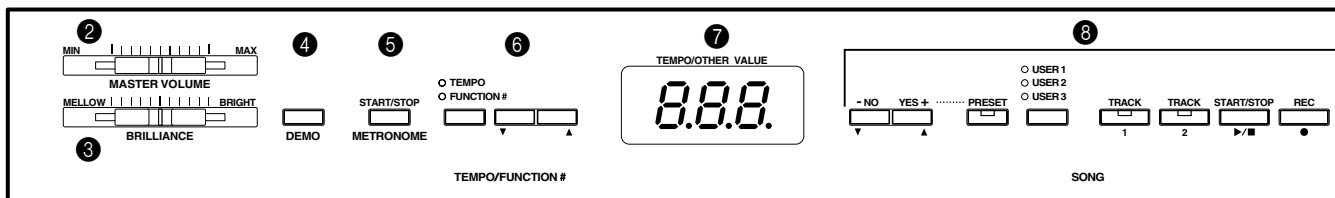

Connectors

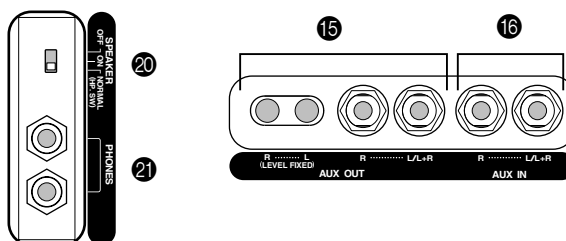

- | | | | |
|--------------------------------|----------------|----------------------------------|--------|
| ① [POWER] | P12 | ⑫ [EFFECT] | P25 |
| ② [MASTER VOLUME] | P13 | ⑬ [TOUCH] | P26 |
| ③ [BRILLIANCE] | P24 | ⑭ [TRANSPOSE] | P27 |
| ④ [DEMO] | P18 | ⑮ AUX OUT | P52 |
| ⑤ METRONOME [START/STOP] | P31 | ⑯ AUX IN | P53 |
| ⑥ [TEMPO/FUNCTION # ▲▼] | P31, 40 | ⑰ [TO HOST] | P51–57 |
| ⑦ LED display | P17 | ⑱ HOST SELECT | P51–57 |
| ⑧ [-/NO] / [+ /YES] | | ⑲ MIDI [IN] [OUT] [THRU] | P51–57 |
| [PRESET] | | ⑳ [SPEAKER] | P13 |
| [USER 1] [USER 2] [USER 3] | | ㉑ [PHONES] | P13 |
| [TRACK 1] [TRACK 2] | | ㉒ Soft (Left) Pedal | P24 |
| SONG [START/STOP] | | ㉓ Sostenuto (Center) Pedal | P24 |
| [REC] | P19–22, P32–38 | ㉔ Damper (Right) Pedal | P23 |
| ⑨ Voice buttons | P23 | | |
| ⑩ [SPLIT] | P29 | | |
| ⑪ [REVERB] | P24 | | |

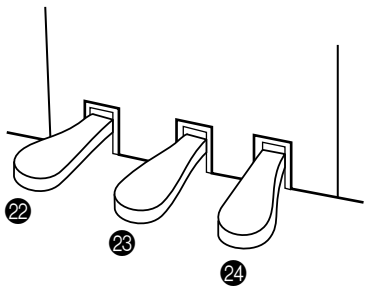
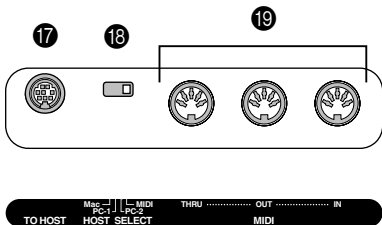
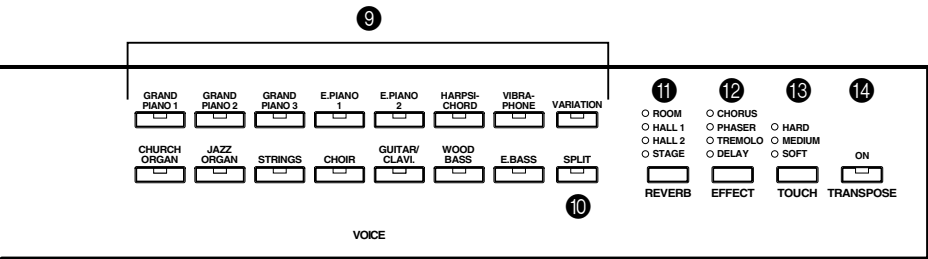

Display

- Check the operation on the display in the center of the top panel as you proceed.
- The display indicates different values, as shown below, depending on the operation.

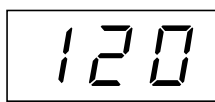

Tempo
(Normal indication)



A song number of
"50 Greats for the Piano"

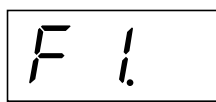

Function number

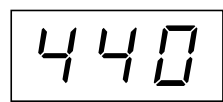

Parameter value

Listening to the Demonstration Tunes

Demonstration tunes are provided that effectively demonstrate each of the CLP-F01's voices.

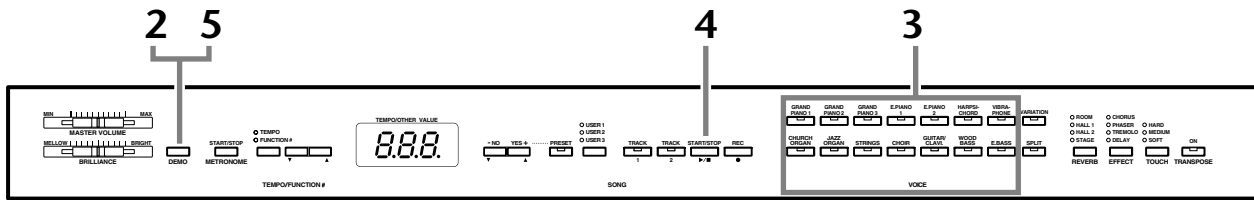

Procedure

1 Turn the power on.

(In case the power is not turned ON) Press the **[POWER]** button. When the power is turned ON, one of the voice button LEDs will light. Initially set the **[MASTER VOLUME]** control about half way between the “MIN” and “MAX” settings. Then, when you start playing, re-adjust the **[MASTER VOLUME]** control to the most comfortable listening level.

2 Engage Demo mode.

Press the **[DEMO]** button to engage Demo mode. The voice button indicators will flash in sequence.

3 Play a Voice demo.

Press one of the voice buttons to start playback of all songs starting from the corresponding voice demo tune — featuring the voice normally selected by that voice button. (If you press the **SONG [START/STOP]** button instead of a voice button, the GRAND PIANO 1 demo tune will begin playback.)

Adjust the volume/brilliance

Use the **[MASTER VOLUME]** control to adjust the volume and the **[BRILLIANCE]** control to adjust the brilliance (page 24).

4 Stop the Voice demo.

Press the **SONG [START/STOP]** button or the voice button of the currently-playing demo to stop playback.

5 Exit from Demo mode.

Press the **[DEMO]** button to exit from Demo mode and return to normal play mode.

The voice button indicators will stop flashing in sequence.

TIP

For a list of the demo songs, see page 64.

NOTE

MIDI reception is not possible in Demo Song mode. Demo song data is not transmitted via the MIDI connectors.

NOTE

Demo mode cannot be engaged while a user song recorder (page 32) or user song playback (page 37) is in use.

TERMINOLOGY

Mode:

A mode is a status under which you can execute a certain function. In Demo mode, you can play back demonstration tunes.

NOTE

You cannot adjust the tempo of demo songs. You cannot use the part cancel function (page 47) or the song A–B repeat function (page 22) in Demo mode.

NOTE

You can demo the piano voices with various effects by pressing the **[VARIATION]** button, then pressing the desired voice button. Refer to the “Piano Voice Demo Description” on page 64 for the complete list of demo sounds for the piano voices with various effects.

Listening to 50 Piano Preset Songs

The Clavinova provides performance data of 50 piano songs. You can simply listen to these songs (page 19) or use them for practice (page 20). You can also refer to the included “50 Greats for the Piano” that contains scores for 50 piano preset songs.

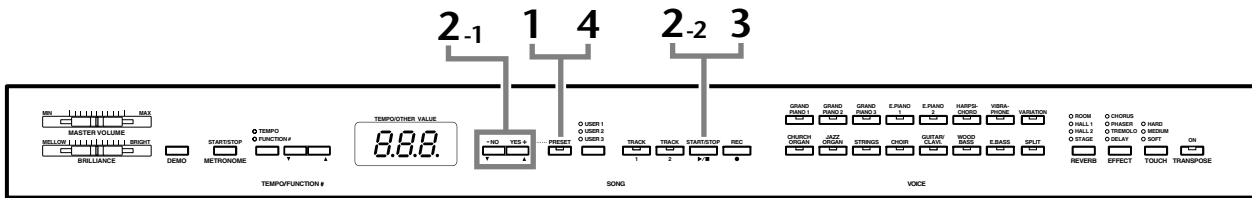

Procedure

1 Engage Preset Song mode.

Press the [PRESET] button to engage Preset Song mode. The [PRESET], [TRACK 1] and [TRACK 2] indicators will light.

2 Play any of the 50 preset songs.

2-1 Press the [-/NO], [+ /YES] buttons to select the number of the tune you want to play (the number will appear on the LED display).

1 – 50: Select a preset song number and play only the song.

ALL: Play all preset songs in sequence.

rnd: Play all preset songs continuously in random order.

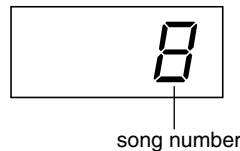

2-2 Press the SONG [START/STOP] button to start playback.

Adjust the Volume

Use the [MASTER VOLUME] control to adjust the volume.

Adjust the tempo

You can use the [TEMPO/FUNCTION# ▼

▲] buttons to adjust the playback tempo as required. The default tempo can be recalled by simultaneously pressing the [▼] and [▲] buttons.

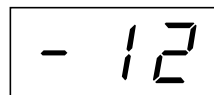

This produces a relative tempo variation, with a range from “-50” through “---” to “50” at maximum; the range will differ depending on the selected song.

3 Stop playback.

Playback will stop automatically when the selected preset song has finished. To stop the song during playback (or continuous playback), press the SONG [START/STOP] button.

- To play back another song continuously, see procedure 2 above.

NOTE

Preset Song mode cannot be engaged while the unit is in Demo Song mode (page 18), while a song is playing back (page 37), or when the user song recorder (page 32) is in use.

TERMINOLOGY

Song:

On the CLP-F01, performance data is called a “Song.” This includes demonstration tunes and piano preset tunes.

TIP

You can play the keyboard along with the preset song. You can change the voice playing on the keyboard.

TIP

You can adjust the Brilliance control (page 24) and Reverb type (page 24) that is applied to the voice you play on the keyboard and for the preset song playback. You can change the Effect type (page 25) and Touch sensitivity (page 26) for the keyboard voice.

NOTE

The default tempo “---” is automatically selected whenever a new preset song is selected, or when playback of a new preset song begins during “ALL” or “rnd” playback.

NOTE

When you select a different song (or a different song is selected during chained playback), an appropriate reverb type will be selected accordingly.

4 Exit from Preset Song mode.

Press the [PRESET] button to exit Preset Song mode. The indicator turns off, and the unit returns to normal play mode.

How to use the practice functions

You can turn the left- and right-hand parts on or off as required so you can practice the corresponding part (part cancel function) and continuously repeat a specified phrase within a song (song A-B repeat function). For more information, see pages 20–22.

NOTE

MIDI reception is not possible in Piano Song mode.
Piano song data is not transmitted via the MIDI connectors.

Practicing a One-Hand Part Using 50 Preset Songs (Part Cancel Function)

The 50 preset songs have separate left- and right-hand parts on individual tracks. You can turn the left- and right-hand parts on or off as required so you can practice the corresponding part (the part that is turned off) on the keyboard. The right-hand part is played by [TRACK 1] and the left-hand part is played by [TRACK 2].

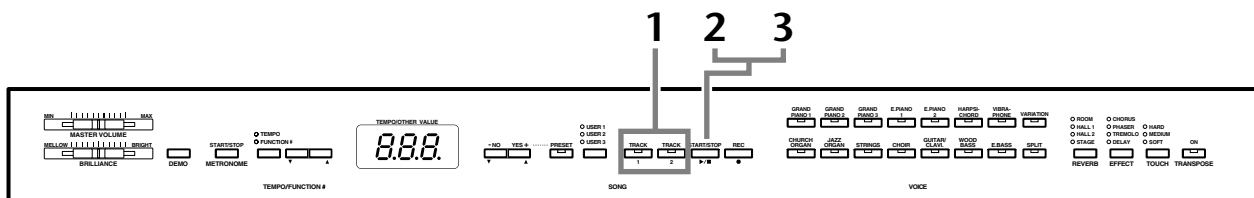

Procedure

1 Turn off the playback part you wish to practice.

After you select a song to practice, press the [TRACK 1] or [TRACK 2] button to turn off the corresponding part.

When you first select a song, both [TRACK 1] and [TRACK 2] indicators light up, indicating that you can play back both parts. When you press one of the buttons to turn off playback, the corresponding button indicator turns off and the corresponding part playback is muted.

- Pressing the buttons repeatedly toggles playback between on and off.

2 Start playback and playing.

Press the SONG [START/STOP] button to start playback. Play the part you just turned off.

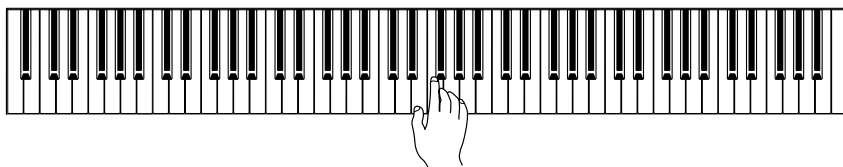

NOTE

The Preset Song Part Cancel function cannot be used during “ALL” or “rnd” (page 19) playback.

TIP

The parts can be turned on or off even during playback.

TIP

The “Preset Song Part Cancel Volume” function described on page 47 can be used to set the canceled part so that it plays at a volume from “0” (no sound) to “20”. The normal setting is “5”.

Starting playback automatically as you start playing the keyboard (Synchro Start)

When the Synchro Start function is engaged, playback of the selected preset song will begin automatically as soon as you start playing on the keyboard.

To engage the Synchro Start function press the **SONG [START/STOP]** button while holding the part button for the ON part. A dot will appear in the lower right corner of the display.

(Repeat the previous operation to disengage the Synchro Start function.)

Playback will then start as soon as you begin playing on the keyboard.

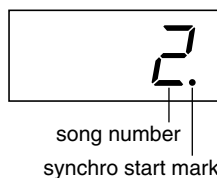

NOTE

If you hold a track button that is OFF while pressing the **SONG [START/STOP]** button, that track will be turned ON and the unit will engage Synchro Start mode.

Left Pedal Start/Stop

The left pedal can be assigned to start and stop preset song playback via the “Left Pedal Mode” function described on page 46.

3 Stop playback.

When playback is complete, it automatically stops and the Clavinova locates the top of the song. If you wish to stop playback in the middle of a song, press the **SONG[START/STOP]** button.

NOTE

Both parts are automatically turned ON whenever a new song is selected.

A-B Repeat for 50 Preset Songs

The A-B Repeat function can be used to continuously repeat a specified phrase within a preset song. Combined with the Part Cancel function described below, this provides an excellent way to practice difficult phrases.

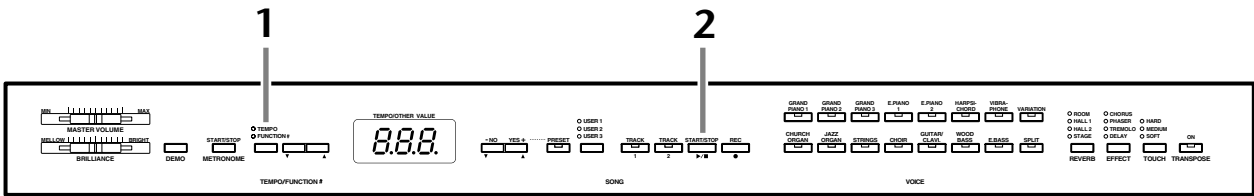

Procedure

1 Specify the beginning (A) and the end (B) of the phrase, and start practicing.

Select and play a preset song, then press the [TEMPO/FUNCTION#] button at the beginning of the phrase you want to repeat.

This sets the “A” point (A - will appear on the display).

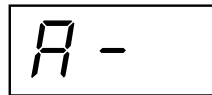

To specify the end (B) of the phrase, press the [TEMPO/FUNCTION#] button a second time at the end of the phrase.

This sets the “B” point (A - b will appear on the display).

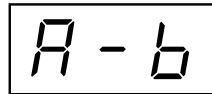

At this point, repeat playback will begin between the specified A and B points.

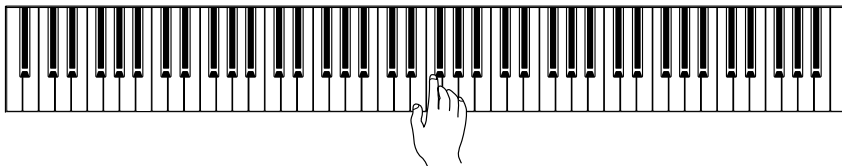

2 Stop playback.

Press the SONG [START/STOP] button to stop playback while retaining the specified A and B points. A-B repeat playback will resume if you press the SONG [START/STOP] button again.

To cancel the A and B points, press the [TEMPO/FUNCTION#] button once.

NOTE

The A-B Repeat function cannot be used during “ALL” or “rnd” (page 19) playback.

NOTE

- To set the “A” point at the very beginning of the song, press the [TEMPO/FUNCTION#] button before starting playback.
- To set the B point at the song’s end, press the [TEMPO/FUNCTION#] button after song playback is complete and before A - disappears from the display.

TIP

An automatic lead-in (to help guide you into the phrase) starts at the A point of the song. However, when the A point is set at the beginning of the song, the automatic lead-in is not played.

NOTE

The A and B points are automatically canceled when a new song is selected.

Selecting & Playing Voices

Selecting Voices

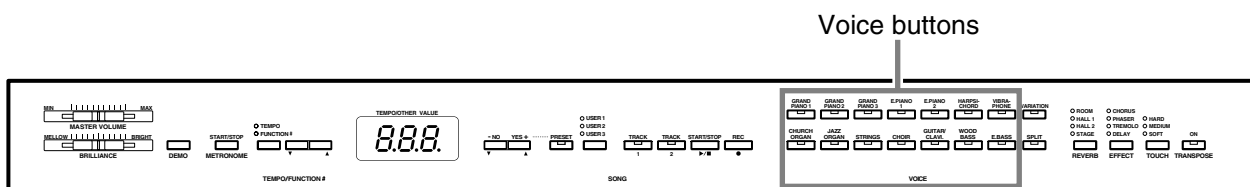

Procedure

Select the desired voice by pressing one of the [VOICE] buttons.

Then, when you start playing, re-adjust the [MASTER VOLUME] control for the most comfortable listening level.

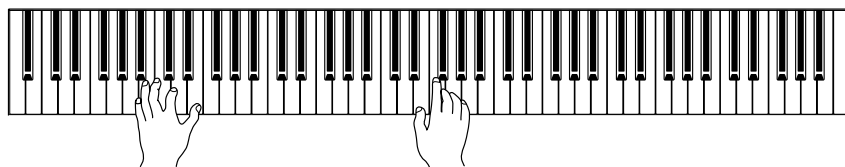

TIP

To learn characteristics of the voices, listen to demo songs for each voice (page 18). Refer to “Preset Voice List” on page 62 for more information on the characteristics of each preset voice.

TERMINOLOGY

Voice:

On the Clavinova, a voice means a “tone” or “tonal color.”

TIP

You can control the loudness of a voice by adjusting the force with which you strike the keys, although different playing styles (touch sensitivities) have little or no effect with certain musical instruments.

Refer to “Preset Voice List” on page 62.

Using the Pedals

The Clavinova has three foot pedals that produce a range of expressive effects similar to those produced by the pedals on an acoustic piano.

Damper (Right) Pedal

The damper pedal functions in the same way as a damper pedal on an acoustic piano. When the damper pedal is pressed, notes sustain longer. Releasing the pedal immediately stops (damps) any sustained notes.

When you select the **GRAND PIANO 1 or 3** voice on the CLP-F01, pressing the damper pedal activates the instrument’s special “Sustain Samples” to accurately recreate the unique resonance of an acoustic grand piano’s soundboard and strings.

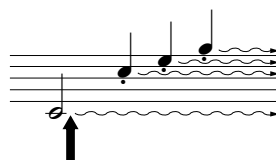
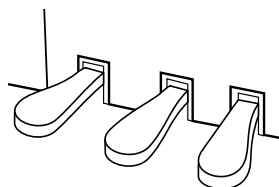

When you press the damper pedal here, the notes you play before you release the pedal have a longer sustain.

TIP

The depth of the effect produced by the “Sustain Samples” can be adjusted via the “Pedal Functions” (page 46) in Function mode.

Sostenuto (Center) Pedal

If you play a note or chord on the keyboard and press the sostenuto pedal while the note(s) are held, those notes will sustain as long as you hold the pedal (as if the damper pedal had been pressed) but all subsequently played notes will not be sustained. This makes it possible to sustain a chord, for example, while other notes are played “staccato.”

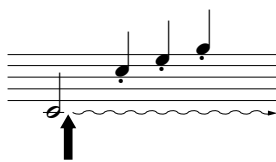

When you press the sostenuto pedal here while holding the note, the note will sustain as long as you hold the pedal.

TIP

Organ, string and choir voices will continue to sound for as long as the sostenuto pedal is depressed.

TIP

The left pedal can be assigned to song start/stop operation or variation function via the “Left Pedal Mode” described on page 46.

Adding Variations to the Sound – [VARIATION]/[BRILLIANCE]/[REVERB]/[EFFECT]

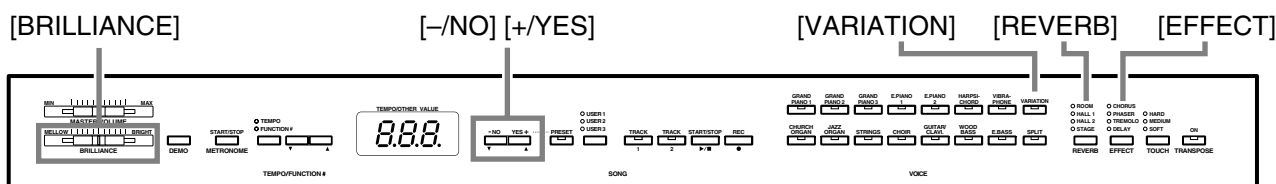

[VARIATION]

Lets you alter another aspect of the effect, depending on the selected type. Refer to “Preset Voice List” on page 62 for more information on the characteristics of each variation.

TIP

Normal setting = OFF

Procedure

Pressing the [VARIATION] or selected voice button toggles the variation on and off. The indicator lights (ON) each time the [VARIATION] button is pressed.

TERMINOLOGY

Normal setting: The “Normal setting” refers to the default setting (factory setting) obtained when you first turn on the power to the Clavinova.

[BRILLIANCE]

This control can be used to change the tonality or “timbre” of the sound output. The control range is from MELLOW to BRIGHT.

TIP

The left pedal can be assigned to ON or OFF the variation via the “Left Pedal Mode” function described on page 46.

[REVERB]

This control enables you to select various digital reverb effects that would add extra depth and expression to the sound to create a realistic acoustic ambience.

NOTE

When the BRILLIANCE is set to BRIGHT, the overall sound will be slightly louder. If the MASTER VOLUME is set at a high level the sound may become distorted. If so, lower the MASTER VOLUME level.

- OFF:** When no reverb effect is selected, no REVERB indicator is lit.
- ROOM:** This setting adds a continuous reverb effect to the sound, similar to the acoustic reverberation you would hear in a room.
- HALL 1:** For a “bigger” reverb sound, use the HALL 1 setting. This effect simulates the natural reverberation of a small-size concert hall.
- HALL 2:** For a truly spacious reverb sound, use the HALL 2 setting. This effect simulates the natural reverberation of a large concert hall.
- STAGE:** Simulates the reverb of a stage environment.

TIP

The default reverb type (including OFF) and depth settings are different for each voice.

Procedure

Pressing the **[REVERB]** button repeatedly toggles the reverb on and off. The indicators light in sequence each time the **[REVERB]** button is pressed. No effect is produced when all indicators are off.

Even if the REVERB effect is OFF, a “Soundboard Reverb” effect will be applied when the **GRAND PIANO 1, 2, or 3** voice is selected.

Adjusting Reverb Depth

Adjust the reverb depth for the selected voice by using the **[-/NO]** **[+/YES]** buttons while holding the **[REVERB]** button. The depth range is from 0 through 20. The current depth setting appears on the LED display while the **[REVERB]** button is held.

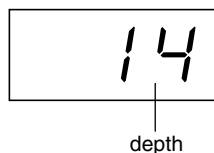

[EFFECT]

The **[EFFECT]** button allows you to select an effect to give your sound greater depth and animation.

- OFF:** When no effect is selected, no EFFECT indicator is lit.
- CHORUS:** A shimmering, broadening effect
- PHASER:** Adds a sweeping effect to the sound.
- TREMOLO:** Tremolo effect
- DELAY:** Echo effect

Procedure

To select an effect type press the **[EFFECT]** button a few times until the indicator corresponding to the desired type lights (the indicators light in sequence each time you press the **[EFFECT]** button). No effect is produced when all indicators are off.

Adjusting Effect Depth

You can adjust the effect depth for the selected voice by using the **[-/NO]** and **[+/YES]** buttons while holding the **[EFFECT]** button.

The depth range is from 0 through 20. The current depth setting appears on the LED display while the **[EFFECT]** button is held.

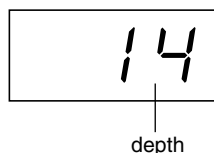

TIP

Releasing the **[REVERB]** button changes the reverb type. If you are changing the reverb depth by holding the **[REVERB]** button, pressing the **[REVERB]** button will not change the reverb type.

TIP

depth 0: no effect
depth 20: maximum reverb depth

TIP

Default depth settings are different for each voice.

TIP

The default effect type (including OFF) and depth settings are different for each voice.

TIP

Releasing the **[EFFECT]** button changes the effect type. If you are changing the depth settings by holding the **[EFFECT]** button, pressing the **[EFFECT]** button will not change the effect type.

TIP

depth 0: no effect
depth 20: maximum effect depth

TIP

Default depth settings are different for each voice.

Touch Sensitivity – [TOUCH]

You can select four different types of keyboard touch sensitivity — HARD, MEDIUM, SOFT or FIXED — to match different playing styles and preferences.

- HARD:** Requires that the keys be played quite hard to produce maximum loudness.
- MEDIUM:** Produces a fairly “standard” keyboard response.
- SOFT:** Allows maximum loudness to be produced with relatively light key pressure.
- FIXED:** All notes are produced at the same volume no matter how hard the keyboard is played.
You can adjust the volume.

TIP

This setting does not change the weight of the keyboard.

TIP

Normal setting = MEDIUM

TIP

The touch sensitivity type will become the common setting for all voices. However, the touch sensitivity settings may have little or no effect with certain voices that are not normally responsive to keyboard dynamics. (Refer to the “Preset Voice List” on page 62.)

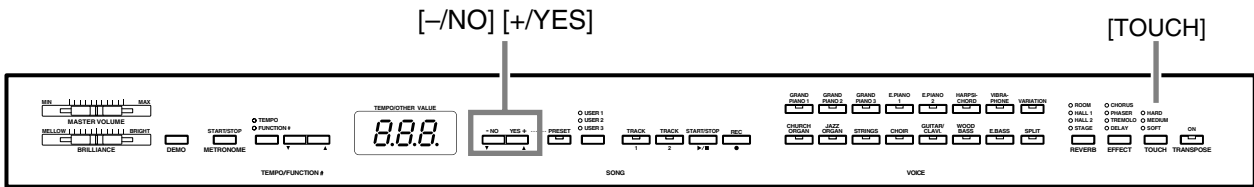

Procedure

To select a touch sensitivity type press the [TOUCH] button a few times until the indicator corresponding to the desired type lights (the indicators light in sequence each time the [TOUCH] button is pressed). No indicator is lit when “FIXED” is selected.

Changing the volume when FIXED is selected

When you select FIXED, you can set the volume for notes played in FIXED mode by using the [-/NO] and [+YES] buttons while you hold the [TOUCH] button. The current volume level appears on the display. The volume range is from 1 through 127. The default setting is 64.

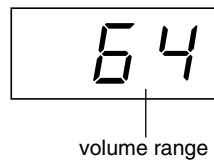

TIP

1: minimum volume
127: maximum volume

TIP

The touch volume set in FIXED mode will become the common setting for all voices.

TIP

Releasing the [TOUCH] button changes the touch type. If you are changing the volume by holding the [TOUCH] button, pressing the [TOUCH] button will not change the touch sensitivity type. (FIXED mode will remain selected.)

Transposition – [TRANPOSE]

The Clavinova’s Transpose function makes it possible to shift the pitch of the entire keyboard up or down in semitone intervals to facilitate playing in difficult key signatures, and to let you easily match the pitch of the keyboard to the range of a singer or other instruments. For example, if you set the transposition amount to “5,” playing key C produces pitch F. In this way, you can play a song as though it were in C major, and the Clavinova will transpose it to the key of F.

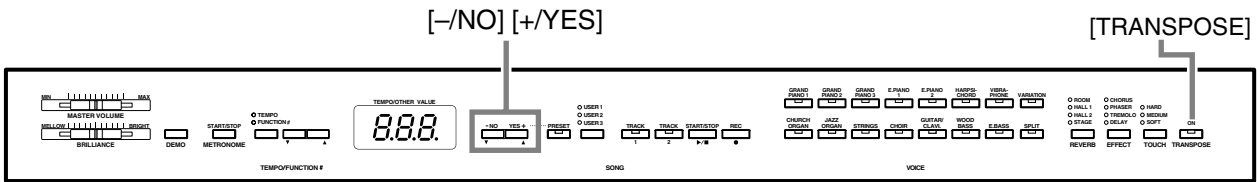

Procedure

Use the [-/NO] and [+/YES] button while holding the [TRANPOSE] button to transpose down or up as required. The amount of transposition appears on the LED display while the [TRANPOSE] button is held. The default transposition setting is “0”.

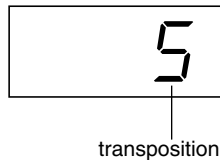

The [TRANPOSE] button indicator remains lit when a transposition other than “0” is selected. Every time the [TRANPOSE] button is pressed after that switches the transposition function ON or OFF.

TERMINOLOGY

Transpose: Changing the key signature of a song. On the Clavinova, transposing shifts the pitch of the entire keyboard.

TIP

The transposition range:

- 12: -12 semitones (down one octave)
- 0: normal pitch
- 12: 12 semitones (up one octave)

TIP

Notes below and above the A-1 ... C7 range of the CLP-F01 sound one octave higher and lower, respectively.

Combining Two Voices (Dual mode)

You can play two voices simultaneously across the entire range of the keyboard. In this way, you can simulate a melody duet or combine two similar voices to create a thicker sound.

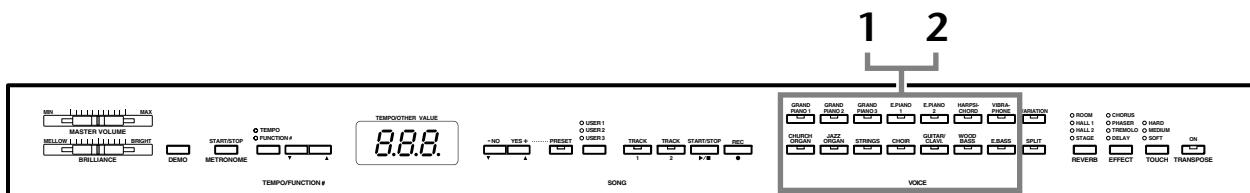

Procedure

1 Engage Dual mode.

Press two voice buttons at the same time (or press one voice button while holding another). The voice indicators of both selected voices will light when Dual mode is active.

- According to the voice numbering priority shown in the diagram on the right, the lower value voice number will be designated as Voice 1 (the other voice will be designated as Voice 2).

Voice numbering priority

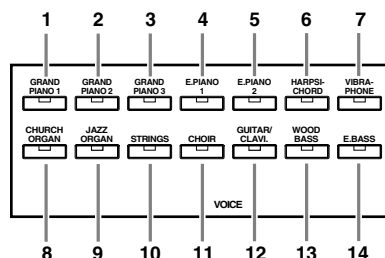

The CLP-F01 Function mode provides access to a number of other Dual mode functions, such as volume balance setting or octave setting (page 44). (If you do not set Dual mode functions, the appropriate setting will be set in each voice by default.)

2 Exit Dual mode and return to normal play mode.

To return to the normal single-voice play mode, press any single voice button.

NOTE

Dual and Split (page 29) modes cannot be engaged at the same time.

TIP

[VARIATION] in Dual Mode

The **[VARIATION]** button's indicator will light if the variation is engaged for either or both of the Dual mode voices. While Dual mode is engaged, the **[VARIATION]** button can be used to turn the variation for both voices on or off.

To turn the variation on or off for only one of the voices, hold the voice button for the other voice and press the button of the voice for which you want to change the variation.

TIP

[REVERB] in Dual Mode

The reverb type assigned to Voice 1 will take priority over the other. (If the reverb is set to OFF, Voice 2 reverb type will be in effect.) Reverb depth setting via the panel controls (i.e., pressing the **[-/NO]** or **[+/YES]** buttons while holding the **[REVERB]** button — see page 24) will be applied only to Voice 1.

TIP

[EFFECT] in Dual Mode

Depending on the conditions, one effect type may take priority over the other. Depth will be decided according to the depth default value of the voice combination. However, using function F3 (page 44) you can adjust the depth value for each voice to your liking.

Effect depth setting via the panel controls (i.e., pressing the **[-/NO]** or **[+/YES]** buttons while holding the **[EFFECT]** button — see page 25) will be applied only to Voice 1.

Splitting the Keyboard Range and Playing Two Different Voices (Split mode)

Split mode enables you to play two different voices on the keyboard — one with the left hand and another with the right hand. For example, you can play a bass part using the Wood Bass or Electric Bass voice with the left hand, and a melody with the right hand.

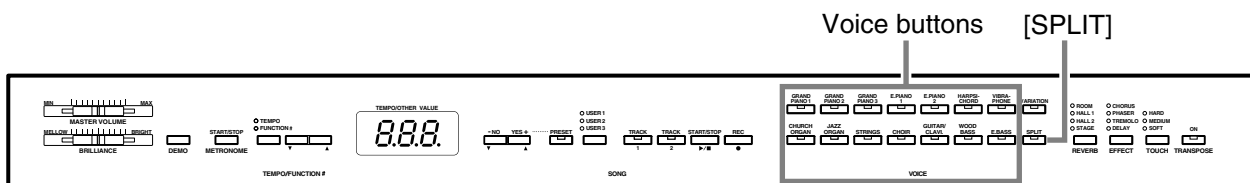

Procedure

1 Engage Split mode.

Press the [SPLIT] button so that its indicator lights. The default setting (WOOD BASE) will be selected for the left-hand voice at first.

The Function mode provides access to a number of other Split mode functions (page 45). (If you make no settings for Split mode functions, the appropriate setting will be set in each voice by default.)

2 Specify the split point (the border between the right-and left-hand range).

You can change the split point to any other key by pressing the key while holding the [SPLIT] button (the name of the current split-point key appears on the LED display while the [SPLIT] button is held).

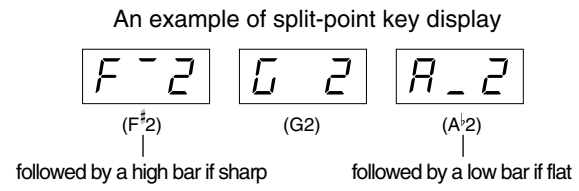

The split point is initially set at the F#2 key by default. If you do not need to change the split point, skip this procedure.

NOTE
Dual (page 28) and Split modes cannot be engaged simultaneously.

TIP
A specified “split point” key is included in the left-hand range.

TIP
The split point can also be set via Function 4 (page 45).

3 Select a voice for the right hand.

Press a voice button.

4 Select a voice for the left hand.

Press the corresponding voice button while holding the **[SPLIT]** button. (The indicator of the Left Voice button will light while the **[SPLIT]** button is pressed.)

To turn the variation on or off for the split voice, hold the **[SPLIT]** button and press the **[VARIATION]** button or the currently-selected voice button.

5 Exit Split mode and return to normal play mode.

Press the **[SPLIT]** button again so that its indicator goes out.

TIP

[VARIATION] in Split Mode

You can turn the variation on or off for Split mode voices. Normally, the voice indicator of the right voice lights in Split mode. The **[VARIATION]** can be used to turn the variation for the right voice on or off as required. While the **[SPLIT]** button is held, however, the voice indicator of the left voice lights. In this state the **[VARIATION]** button turns the variation for the left voice on or off.

TIP

[REVERB] in Split Mode

The reverb type assigned to the right voice will take priority over the other. (If the reverb is set to OFF, the left voice's reverb type will be in effect.) Reverb depth setting via the panel controls (i.e. pressing the **[-/NO]** or **[+/YES]** buttons while holding the **[REVERB]** button — see page 24) will be applied to the right voice only.

TIP

[EFFECT] in Split Mode

Depending on the conditions, one effect type will take priority over the other. The depth will be decided according to the depth default value of the voice combination. However, using function F4 (page 45) you can change the depth value for each voice as you like. Effect depth setting via the panel controls (i.e. pressing the **[-/NO]** or **[+/YES]** buttons while holding the **[EFFECT]** button — see page 25) will be applied to the right voice only.

Using the Metronome

The Clavinova features a built-in metronome (a device that keeps an accurate tempo) that is convenient for practicing.

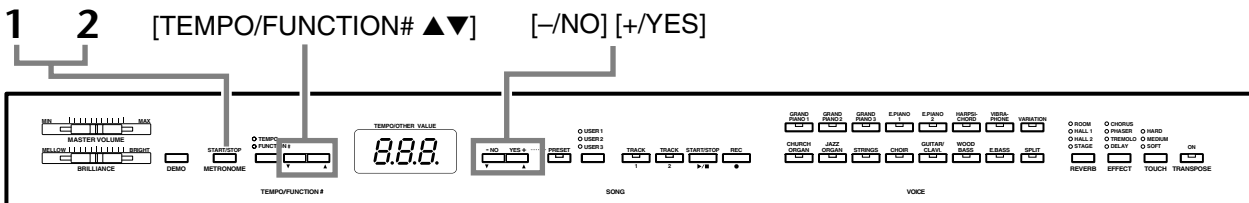

Procedure

1 Start the metronome.

The metronome sound is turned on by pressing the **METRONOME [START/STOP]** button.

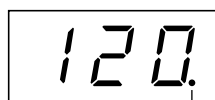

The beat indicator flashes at the current tempo.

Adjusting the tempo

The tempo of the metronome and user song recorder playback (the recorder is described in the next section) can be set from 32 to 280 beats per minute by using the **[TEMPO/FUNCTION# ▼ ▲]** buttons (when the **[TEMPO/FUNCTION# ▼ ▲]** button's **[TEMPO]** indicator is lit).

Adjusting the time signature

The time signature (beat) of the metronome can be set by using the **[-/NO]** and **[+ /YES]** buttons while holding the **METRONOME [START/STOP]** button. You can set the beat to 0, 2, 3, 4, 5 or 6. The current setting appears on the LED display while you are holding the **METRONOME [START/STOP]** button.



beat

2 Stop the metronome.

Turn off the metronome by pressing the **METRONOME [START/STOP]** button.

TIP

If the **[TEMPO/FUNCTION#]** button's **[FUNCTION#]** indicator is lit, press the **[TEMPO/FUNCTION#]** button to light the **[TEMPO]** indicator.

TIP

The volume of the metronome can be adjusted via the **Metronome Volume** function in **Function mode** (page 47).

Recording Your Performance

The ability to record and play back what you've played on the CLP-F01 keyboard can be an effective practice aid. You can, for example, record just the left-hand part, and then practice the right-hand part while playing back the recorded left-hand part. Or, since you can record up to two tracks separately, you could record the left- and right-hand parts separately, or record both parts of a duet and hear how they sound when played back. The CLP-F01's two-track Song Recorder allows the recording of up to three User Songs.

TIP

You can record your performance (audio data) to a cassette tape recorder or other recording device via the AUX OUT connector (page 52).

TERMINOLOGY

Recording vs. Saving:

The format of performance data recorded on a cassette tape differs from that of data recorded on the Clavinova. A cassette tape records audio signals. The Clavinova "saves" information regarding note timing, voices, and a tempo value, but not audio signals. When you play back recorded songs, the Clavinova produces sound based on the saved information. Therefore, recording on the Clavinova may be more accurately called "saving information." However, this book often uses the word "recording" because it seems to make more sense.

Recording to [TRACK 1]

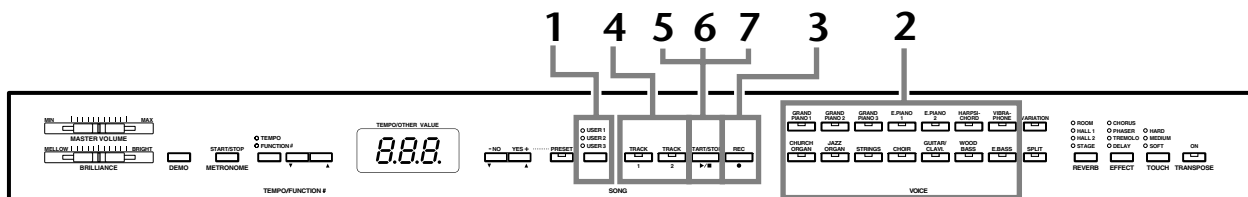

Procedure

CAUTION

Notes on recording

All user song recorder data will be retained in memory for about one week after the power is turned off. If you want to keep your recorded data for longer periods of time, turn the power on for a few minutes at least once a week.

It is also possible to store the data to an external MIDI storage device such as the Yamaha MIDI Data Filer MDF3 by using the Bulk Data Dump function described on page 49.

1 Select a song for recording.

Press the [USER 1/2/3] button to select a song for recording.

The indicator of the selected song will light. (No song is selected if none of the indicators are lit.)

2 Make all the initial settings.

Before you begin to record, select the voice you want to record (or voices if you will be using Dual or Split mode). Make any other desired settings (tempo, reverb, etc.) as well. You might also want to set the volume.

You can also adjust the playback volume using [MASTER VOLUME].

NOTE

When the unit is in Demo Song mode, the [USER 1/2/3] button cannot be used to select a song.

NOTE

When the unit is in Demo Song or Preset Song mode, Record mode cannot be engaged.

NOTE

To avoid erasing data from the track:

If the track contains data, the track indicator lights up green when you press the [USER 1/2/3] button. Note that recording new data on this track will erase the existing data.

3 Engage Record mode.

Press the [REC] button to engage Record mode.

Recording does not actually start yet.

The [TRACK 1] or the [TRACK 2] indicator flashes in red.

The amount of memory available for recording will be shown on the LED display in approximate kilobytes, and the right-most dot on the LED display will flash at the current METRONOME tempo setting.

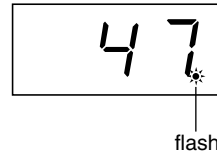

Record mode can be disengaged before recording by pressing the [REC] button a second time.

4 Select the record track.

When Record mode is engaged in the previous step, the last-recorded track will automatically be selected for recording and its indicator — i.e. the [TRACK 1] or [TRACK 2] button indicator — will glow red. If you want to record on a different track, press the appropriate track button so that its indicator glows red.

5 Start recording.

Recording will begin automatically as soon as you play a note on the keyboard or press the SONG [START/STOP] button. The current measure number will appear on the display while recording.



6 Stop recording.

Press either the [REC] or SONG [START/STOP] button to stop recording.

The indicator of the recorded track will glow green to indicate that it now contains data. (Record mode is disengaged automatically.)

7 Play back the recorded performance.

Press the SONG [START/STOP] button to play back the recorded performance. To stop playback in the middle of a song, press the SONG [START/STOP] button.

NOTE

The amount of memory available for recording:

This value in KiloBytes (a unit used of measurement for data) indicates how much space remains available for recording on the Clavinova. You can record up to a maximum of about 9,400 notes on the CLP-F01 depending on pedal usage and other factors.

TIP

If a user song ([USER 1/2/3]) is not selected (the lamp is not lit), pressing the [REC] button will result in the [USER 1] song's [TRACK 1] being selected and Record mode engaged. At this time, [TRACK 2] playback will be turned off if the track contains data.

TIP

If the metronome was on when you started recording, you'll be able to keep time with the metronome while recording, but the metronome sound will not be recorded.

TIP

For more recording information, see page 35.

TIP

The left pedal can be assigned to start and stop recording via the "Left Pedal Mode" function described on page 46.

NOTE

The record track indicator will begin to flash when the recorder memory is almost full. If the memory becomes full during recording, "FUL" will appear on the display and recording will stop automatically. (All recorded data up to that point will be retained.)

NOTE

Pressing the SONG [START/STOP] button to start recording, then pressing it again to stop recording will erase all previously-recorded data on the selected track.

Re-recording TRACK 1

This section explains how to record again in case your performance was not satisfactory.

1. Select a voice or voices (and other settings) for recording, if necessary.

Repeat Step 1 on page 32 if you wish to change the previous settings.

2. Re-engage Record mode.

Press the [REC] button, again.

The selected track's indicator flashes in red.

Follow the procedure from Step 5 on page 33 to re-record.

Recording to [TRACK 2]

This section explains how to record another part on the second track.

1. Select a voice or voices (and other settings) for the recording.

Select a voice (or voices) for recording. Select other settings, if necessary.

2. Re-engage Record mode.

Press the [REC] button again.

The selected track's indicator flashes in red.

3. Select a recording track.

Select a track that you have not already used for recording. The selected track's indicator lights up red. (The indicator of a track that contains previously-recorded data will glow green.)

You can record new sounds and notes on each pass while listening to the recorded track.

Follow the procedure from Step 5 on page 33 to record.

TIP

If you want to change the tempo, time signature, reverb type, or effect type when re-recording a track or when recording to another track, do so after you engage Record mode (step 3).

NOTE

You cannot re-record in the middle of a song.

TIP

If you want to change the tempo, time signature, reverb type, or effect type when re-recording a track or when recording to another track, do so after entering Record mode (step 3).

NOTE

If you don't want to hear the previously-recorded track while you record (for example, when you want to record a song different from what you recorded on the previous track), press the playback track button before pressing the [REC] button (step 2, above) so that its indicator is turned off.

The user song recorder records the following data:

Data in addition to the notes and voices you play is recorded.

This data includes “Individual Tracks” and “Entire Song.” See below.

Individual Tracks

- Notes played
- Voice selection
- [VARIATION] ON/OFF
- Pedal (Damper/Soft/Sostenuto)
- [REVERB] depth
- [EFFECT] depth
- Dual mode voices
- Dual balance (F3)
- Dual detune (F3)
- Dual octave shift (F3)
- Split mode voices
- Split balance (F4)
- Split octave shift (F4)

Entire Song

- Tempo
- Time signature (beat)
- [REVERB] type (including OFF)
- [EFFECT] type (including OFF)

Changing the Initial Settings (Data recorded at the beginning of a song)

The initial settings (data recorded at the beginning of a song) can be changed after the recording. For example, after recording, you can change the voice to create a different ambience or adjust the song tempo to your taste.

You can change the following initial settings.

Individual Tracks

- Voice selection
- [VARIATION] ON/OFF
- [REVERB] depth
- [EFFECT] depth
- Dual mode voices
- Split mode voices

Entire Song

- Tempo
- Time signature (beat)
- [REVERB] type (including OFF)
- [EFFECT] type (including OFF)

1. Engage Record mode (page 33) and select a track to change the initial settings.

The indicator glows red. (Data shared by two tracks can be changed via either track.)

2. Change the settings via the panel controls.

For example, if you wish to change the recorded voice from [E. PIANO 1] to [E. PIANO 2], press the [E. PIANO 2] button.

Be careful not to press the **SONG [START/STOP]** button or a key on the keyboard, either of which will start recording and erase all previously-recorded data on the selected track.

3. Press the [REC] button to exit Record mode.

Be careful not to press the **SONG [START/STOP]** button or a key on the keyboard, either of which will start recording and erase all previously-recorded data on the selected track.

NOTE

You can cancel changes made to the initial settings by selecting a different track after Step 2, then exiting Record mode during Step 3 without pressing the [REC] button. (Changes made to the data shared by two tracks are also canceled.)

Playing Back Recorded Songs

You can play back songs recorded using the Record function (pages 32–36). You can also play the keyboard along with the playback.

NOTE

Song data is not transmitted via the MIDI connectors.

Playing Back a Song

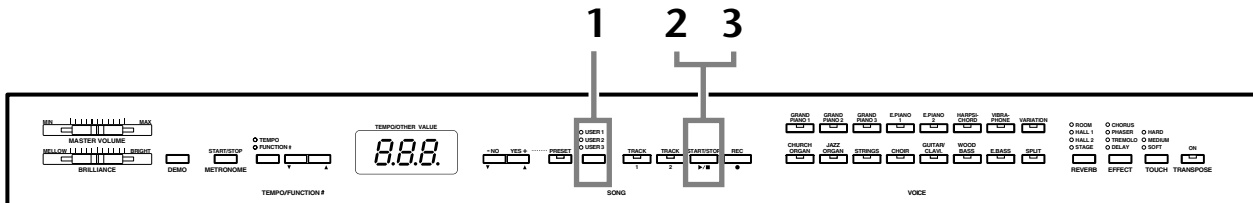

Procedure

1 Select the desired song.

Press the [USER 1/2/3] button to select a song for recording.

The indicator of the selected song will light. (No song is selected if none of the indicators are lit.)

2 Start playback.

Press the SONG [START/STOP] button.

The current measure number appears on the display during playback.



- You can play the keyboard while the Clavinova is playing back a song. You can also play the notes in a voice different from the playback voice by selecting a voice from the panel.

Adjust the volume

Use the [MASTER VOLUME] control to adjust the volume.

Adjust the tempo

You can use the [TEMPO/FUNCTION# ▼ ▲] buttons to adjust the playback tempo as required before or during playback. The default tempo (the song's original tempo) is set when you press the [▼] and [▲] buttons simultaneously.

3 Stop playback.

When playback is complete, the Clavinova automatically stops and locates the top of the song. To stop playback in the middle of a song, press the SONG [START/STOP] button.

NOTE

When the unit is in Demo Song mode, you cannot use the [USER 1/2/3] button to select a song.

NOTE

When the unit is in Demo Song or Preset Song mode, you cannot play back recorded songs.

NOTE

Playback cannot be started when the recorder contains no data.

TIP

You can also enjoy playing duets with yourself by recording one part of a duet or a song for two pianos, then playing the other part while the recorded part plays back.

TIP

If the metronome is being used during playback, the metronome will automatically stop when playback is stopped.

TIP

If the REVERB type is changed via the panel controls during playback, both the playback and keyboard reverb effects will be changed.

TIP

If the EFFECT type is changed via the panel controls during playback, the playback effect may be switched off in some cases.

Useful Playback Functions

Turning track playback on and off

When you select a song on the Clavinova, the indicators for tracks that contain data (one of [TRACK 1] [TRACK 2] or both) are lit in green. While the Clavinova is playing or stopped, pressing these track buttons turns off the indicators, and the data on those tracks is not played. Pressing the track buttons toggles track playback on and off.

Starting playback automatically when you start playing the keyboard (Synchro Start)

You can start playback as soon as you start playing the keyboard. This is called the “Synchro Start” function.

To engage the Synchro Start function, press the **SONG [START/STOP]** button while holding a track button that is ON.

The right-most dot on the display will flash at the current tempo.

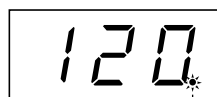

Flash

(Repeat the previous operation to disengage the Synchro Start function.)

Playback will then start as soon as you begin playing on the keyboard.

This function is useful when you wish to match the timing of the beginning of the playback sound and the start of your own performance.

Assigning the START/STOP function to the left pedal

The left pedal can also be assigned to song start/stop operation via the “Pedal Start/Stop” (page 46).

This is convenient for starting playback of the recorded part anytime after you have started playing.

TIP

Tracks can be turned on or off before or during playback.

TIP

You can adjust the volume of a part of a song from “50 Greats for the Piano” for which playback is turned off (pages 20, 47).

During recorder playback, the volume of a track that is turned off will always be “0.”

NOTE

If you press the **SONG [START/STOP]** button while holding down a track button that is OFF, track playback is turned on and the Synchro Start function is placed on stand-by.

TERMINOLOGY

Synchro:

Synchronous; occurring at the same time.

Detailed Settings – [FUNCTION]

You can set various parameters to make the best use of Clavinova functions, such as fine tuning the pitch, selecting a voice for the metronome, repeating playback, etc.

The following parameters are available.

The CLP-F01 has nine main functions.

Some of these main functions consist of a set of sub-modes.

Parameter List

Function	Sub-Mode	Function number	Reference page
Fine tuning of the pitch	—	F1	42
Selecting a scale	Scale	F2.1	43
	Base Note	F2.2	43
Dual mode functions	Dual Balance	F3.1	44
	Dual Detune	F3.2	44
	Voice 1 Octave Shift	F3.3	44
	Voice 2 Octave Shift	F3.4	44
	Voice 1 Effect Depth	F3.5	44
	Voice 2 Effect Depth	F3.6	44
	Reset	F3.7	44
Split mode functions	Split Point	F4.1	45
	Split Balance	F4.2	45
	Right Voice Octave Shift	F4.3	45
	Left Voice Octave Shift	F4.4	45
	Right Voice Effect Depth	F4.5	45
	Left Voice Effect Depth	F4.6	45
	Damper Pedal Range	F4.7	45
	Reset	F4.8	45
Other Functions	Left Pedal Mode	F5.1	46
	Soft Pedal Effect Depth	F5.2	46
	Sustain Sample Depth	F5.3	46
	Keyoff Sample Volume	F5.4	46
Metronome volume	—	F6	47
Preset Song Part Cancel Volume	—	F7	47
MIDI Functions	MIDI Transmit Channel Selection	F8.1	47
	MIDI Receive Channel Selection	F8.2	48
	Local Control ON/OFF	F8.3	48
	Program Change ON/OFF	F8.4	48
	Control Change ON/OFF	F8.5	48
	MIDI Transmit Transpose	F8.6	49
	Panel/Status Transmit	F8.7	49
	Bulk Data Dump	F8.8	49
Backup Functions	Voice	F9.1	50
	MIDI	F9.2	50
	Tuning	F9.3	50
	Others	F9.4	50

Basic Procedure in Function Mode

Follow the steps below to use the functions.

(If you become lost while using a function, return to this page and read the basic procedure.)

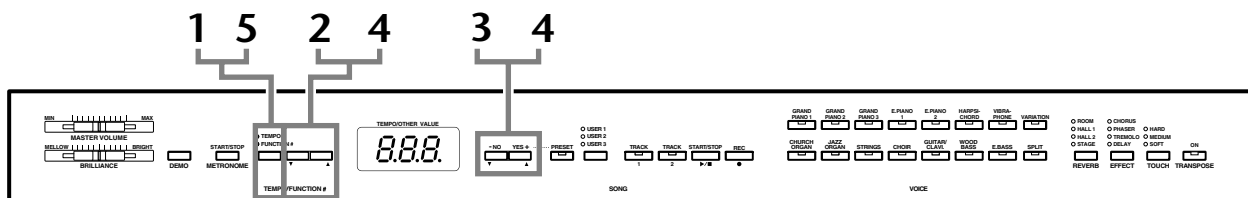

Procedure

1 Engage Function mode.

Press the [TEMPO/FUNCTION#] button so that its [FUNCTION#] indicator lights.

[F * . *] will appear on the display. (The indication of “* . *” varies depending on the status of the unit and usage.)

2 Select a function.

Use the [TEMPO/FUNCTION# ▼ ▲] buttons to select the desired function from F1–F9.

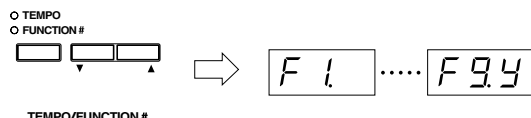

3 Use the [-/NO] [+ /YES] buttons.

If the function does not include sub-modes, start setting the parameters.

If the function includes sub-modes, press the [+ /YES] button once to enter the respective sub-mode.

4 Operate the desired function using the following two buttons.

- ① [TEMPO/FUNCTION# ▼ ▲]
Selects the desired function/sub-mode.
- ② [-/NO] or [+ /YES]
After you select the desired function or sub-mode, set the ON/OFF, select the type, or change the value, accordingly.
Depending on the setting, the default setting (which is used when you first turn on the power to the Clavinova) is recalled by pressing the [-/NO] and [+ /YES] buttons simultaneously.

NOTE

Functions cannot be selected during Demo/Preset Song mode or when the user song recorder is in operation.

NOTE

To cancel the function in Step 2, 3, or 4, press the [TEMPO/FUNCTION# ▼ ▲] button any time to exit Function mode.

TIP

After you select the function, the current setting will be displayed when the [-/NO] or [+ /YES] button is pressed for the first time.

Operation Example 1 (F1. Fine tuning of the pitch)

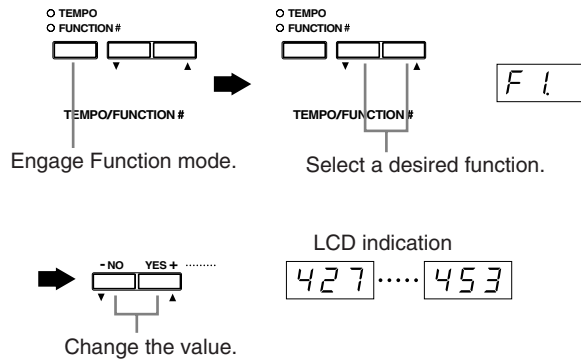

Operation Example 2 (F3.1 "Dual Balance")

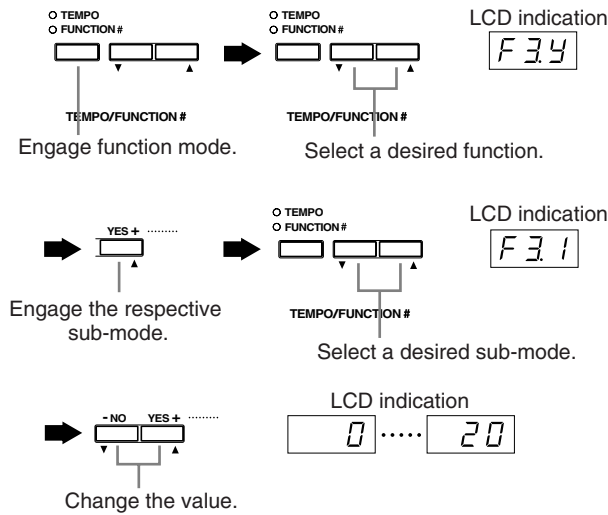

5 Do the following when you finish using the function.

To exit Function mode, press the [TEMPO/FUNCTION#] button so that its [TEMPO] indicator lights.

About Each Function

F1. Fine Tuning of the Pitch

You can fine tune the pitch of the entire instrument. This function is useful when you play the Clavinova along with other instruments or CD music.

1. Engage Function mode and select **[F1]**.
2. Use the **[-/NO]** and **[+/YES]** buttons to lower or raise the pitch of the A3 key in approximately 0.2 Hz increments.

[427].....[440].....[453]

Tenths of a hertz are indicated on the LED display by the appearance and position of one or two dots, as in the following example:

Display	Value
[440]	440.0
[4.40]	440.2
[44.0]	440.4
[440.]	440.6
[4.40.]	440.8

Setting range:
427.0–453.0 (Hz)

Normal setting:
440.0 (Hz)

TERMINOLOGY

Hz (Hertz):

This unit of measurement refers to the frequency of a sound and represents the number of times a sound wave vibrates in a second.

TIP

You can also use the keyboard to set the pitch (in any mode other than Function mode).

To tune up (in about 0.2Hz steps): Hold the A-1 and B-1 keys (two white keys at the left end) simultaneously and press any key between C3 and B3.

To tune down (in about 0.2Hz steps): Hold the A-1 and A[♯]-1 keys (a white and a black key at the left end) simultaneously and press any key between C3 and B3.

To restore standard pitch: Hold the A-1, A[♯]-1 and B-1 (two white keys and one black key at the left end) simultaneously and press any key between C3 and B3.

- Refer to “Panel Controls and Terminals” on page 16 for information on the key and key name assignment.

(During the procedure described above, the display indicates a value in Hz <**[427]...[453]**>. After the procedure, the display returns to the previous indication.)

TIP

You can also tune in about 1Hz steps (in any mode other than Function mode).

To tune down or up, respectively, in approximately 1 Hz increments: Hold the A-1 and A[♯]-1 keys (a white and a black key at the left end) or A-1 and B-1 keys (two white keys at the left end) simultaneously and press the **[-/NO]** or **[+/YES]** button.

To restore standard pitch: Hold the A-1 and A[♯]-1 keys (a white and a black key at the left end) or A-1 and B-1 keys (two white keys at the left end) simultaneously and press the **[-/NO]** **[+/YES]** buttons simultaneously.

(During the procedure described above, the display indicates a value in Hz <**[427]...[453]**>. After the procedure, the display returns to the previous indication.)

F2. Selecting a Scale

You can select various scales.

Equal Temperament is the most common contemporary piano tuning scale. However, history has known numerous other scales, many of which serve as the basis for certain genres of music. You can experience these tunings with the Clavinova.

Equal

One octave is divided into twelve equal intervals. Currently the most popular piano tuning scale.

PureMajor/PureMinor

Based on natural overtones, three major chords using these scales produce a beautiful, pure sound. They are sometimes used for chorus parts.

Pythagorean

This scale, designed by Pythagoras, a Greek philosopher, is based on the interval of a perfect 5th.

The 3rd produces swells, but the 4th and 5th are beautiful and suitable for some leads.

MeanTone

This scale is an improvement of the Pythagorean in that the swell of the 3rd has been eliminated. The scale became popular during the late 16th century through the late 18th century, and was used by Handel.

WerckMeister/KirnBerger

These scales combine Mean Tone and Pythagorean in different ways. With these scales, modulation changes the impression and feel of the songs. They were often used in the era of Bach and Beethoven. They are often used today to reproduce the music of that era on harpsichords.

1. Engage Function mode and select **[F24]**.

2. Press the **[+ / YES]** button to engage the scale function's sub-mode, then use the **[TEMPO / FUNCTION# ▼ ▲]** buttons to select the desired sub-mode.

Press the **[- / NO]** and **[+ / YES]** buttons to select the number of the desired tuning.

Sub-mode

[F21] Scale

Setting range: 1: Equal Temperament
2: Pure Major
3: Pure Minor
4: Pythagorean
5: Mean Tone
6: Werckmeister
7: Kirnberger

Normal setting: 1: Equal Temperament

[F22] Base Note

If you select a scale other than Equal Temperament, you need to specify the root. (You can specify the root note with Equal Temperament selected, but it is not effective. The base note setting is effective for tunings other than the Equal Temperament tuning.)

Setting range: C, C[#], D, E^b, E, F, F[#], G, A^b, A, B^b, B

Normal setting: C

- Root indication example

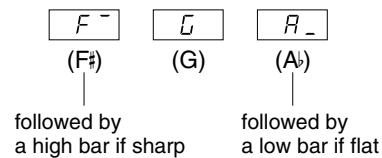

F3. Dual Mode Functions

You can set various parameters for Dual mode to optimize the settings for the songs you play, such as adjusting the volume balance between two voices.

Dual mode function settings are set individually for each voice combination.

1. Select the voices in Dual mode and engage Function mode and select **F34**.
2. Press the [+ / YES] button to engage the Dual mode function's sub-mode, then use the [TEMPO / FUNCTION# ▼ ▲] buttons to select the desired sub-mode. Press the [- / NO] [+ / YES] button to assign values.

NOTE

If Dual mode is not engaged, **F3-** will appear instead of **F34** and you will be unable to select Dual mode functions. You can switch from Function mode to Dual mode.

Sub-mode

F31 Dual Balance

Setting range: 0 – 20 (A setting of “10” produces an equal balance between the two Dual mode voices. Settings below “10” increase the volume of Voice 2 in relation to Voice 1, and settings above “10” increase the volume of Voice 1 in relation to Voice 2.)

Normal setting: Different for each voice combination.

You can set one voice as the main voice, and another voice as a softer, mixed voice.

F32 Dual Detune

Setting range: -10 – 0 – 10 (With positive values, the pitch of Voice 1 is raised and the pitch of Voice 2 is lowered. With negative values, the pitch of Voice 1 is lowered and the pitch of Voice 2 is raised.)

TIP

The available setting range is wider in the lower range (± 60 cents for A-1), and narrower in the higher range (± 5 cents for C7). (100 cents equal one semitone.)

Normal setting: Different for each voice combination.

Detune Voice 1 and Voice 2 for Dual mode to create a thicker sound.

F33 Voice 1 Octave Shift

F34 Voice 2 Octave Shift

Setting range: -1, 0, 1

Normal setting: Different for each voice combination.

You can shift the pitch up and down in octave steps for Voice 1 and Voice 2 independently. Depending on which voices you combine in Dual mode, the combination may sound better if one of the voices is shifted up or down an octave.

F35 Voice 1 Effect Depth

F36 Voice 2 Effect Depth

Setting range: 0 – 20

Normal setting: Different for each voice combination.

These functions make it possible to individually set the depth of the effect for Voices 1 and 2 for Dual mode. (The effect depth settings cannot be changed unless the [EFFECT] is ON. Function mode must be exited before the [EFFECT] can be turned ON.)

- “Voice 1” and “Voice 2” are explained on page 28.

F37 Reset

This function resets all Dual mode functions to their default values. Press the [+ / YES] button to reset the values.

TIP

SHORTCUT:

You can jump directly to the Dual mode functions **F3*** by pressing the [TEMPO / FUNCTION#] button while holding the two Dual mode voice buttons.

To exit Function mode, you still need to press the [TEMPO / FUNCTION#] button so that the TEMPO indicator lights up.

F4. Split Mode Functions

This menu enables you to make various detailed settings for Split mode.

By changing the split point or other setting, you can optimize the settings for the songs you play.

You can make these settings for each combination of voices individually.

1. Select the voices in Split mode and engage Function mode and select **[F44]**.
2. Press the **[+/YES]** button to engage the Split mode function's sub-mode, then use the **[TEMPO/FUNCTION# ▼ ▲]** buttons to select the desired sub-mode. Press the **[-/NO] [+ /YES]** button to assign values.

NOTE

If Split mode is not engaged, **[F4-]** will appear instead of **[F44]** and you will be unable to select Split mode functions. Also note that you must exit Function mode before you can engage Split mode.

Sub-mode

[F41] Split Point

Setting range: The entire keyboard

Normal setting: F#2

Set the point on the keyboard that separates the right and left-hand sections (split point). The pressed key is included in the left-hand range.

- Instead of pressing the **[-/NO] [+ /YES]** buttons, you can engage the split point by pressing the appropriate key on the keyboard.
- If Function mode is not engaged, you can change the split point to any other key by pressing the key while holding the **[SPLIT]** button (page 29).
- An example of a key name indication for a split point

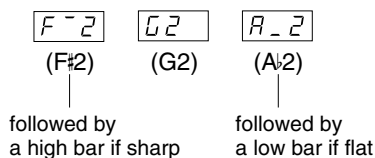

[F42] Split Balance

Setting range: 0 – 20 (A setting of “10” produces an equal balance between the two Split mode voices. Settings below “10” increase the volume of the left voice in relation to the right voice, and settings above “10” increase the volume of the right voice in relation to the left voice.)

Normal setting: Different for each voice combination.

The volume level of the two voices combined in Split mode can be adjusted as required.

[F43] Right Voice Octave Shift

[F44] Left Voice Octave Shift

Setting range: –1, 0, 1

Normal setting: Different for each voice combination
You can shift the pitch up and down in octave steps for the Right Voice and Left Voice independently. Make a setting depending on the note range of the songs you play.

[F45] Right Voice Effect Depth

[F46] Left Voice Effect Depth

Setting range: 0 – 20

Normal setting: Different for each voice combination
These functions make it possible to individually set the depth of the effect for the left and right Split mode voices.

The effect depth settings cannot be changed unless the **[EFFECT]** is ON. You must exit Function mode before you can turn on an **[EFFECT]**.

[F47] Damper Pedal Range

Setting range: ALL (for both voices)
1 (for the right Voice)
2 (for the left Voice)

Normal setting: ALL

The Damper Pedal Range function determines whether the damper pedal affects the right voice, the left voice, or both the left and right voices in Split mode.

[F48] Reset

This function resets all Split mode functions to their default values. Press the **[+/YES]** button to reset the values.

TIP

SHORTCUT:

You can jump directly to Split mode functions **[F4*]** by pressing the **[TEMPO/FUNCTION#]** button while holding the **[SPLIT]** button.

To exit Function mode, you still need to press the **[TEMPO/FUNCTION#]** button so that the TEMPO indicator lights up.

F5. Other Functions

This function conveniently lets you set operation of the left pedal to one of the modes listed below.

1. Engage Function mode and select **F5.4**.
2. Press the [+ / YES] button to engage the other functions' sub-mode, then use the [TEMPO / FUNCTION# ▼ ▲] buttons to select the desired sub-mode.
Press the [- / NO] or [+ / YES] button to select the desired pedal function or assign the values.

Sub-mode

F5.1 Left Pedal Mode

Setting range:

1. Soft Pedal
The soft pedal reduces the volume and slightly changes the timbre of notes played while the pedal is pressed. The soft pedal will not affect notes that are already playing.
2. Song Start/Stop
This mode allows you to start or stop song playback. In this mode, the Left Pedal functions in the same manner as the **SONG [START/STOP]** button on the panel.
3. Variation
This mode enables you to switch the Voice's variation on or off. In this mode, the left pedal functions in the same manner as the **[VARIATION]** button on the panel.

Normal setting: 1 (Soft Pedal)

F5.2 Soft Pedal Effect Depth

Setting range: 1 – 15

Normal setting: 3

This function sets the depth of the soft pedal effect.

F5.3 Sustain Sample Depth

Setting range: 0 – 20

Normal setting: 12

The **GRAND PIANO 1 and 3** voice features special "Sustain Samples" that recreate the unique resonance of an acoustic grand piano's soundboard and strings when the damper pedal is pressed. This function lets you adjust the depth of this effect.

F5.4 Keyoff Sample Volume

Setting range: 0 – 20

Normal setting: 10

You can adjust the volume of the keyoff sound (the subtle sound produced when the keys are released) for voices **[GRAND PIANO 1, 3]**, **[HARPSICHORD]** (including their variations) and variation of **[GUITAR/CLAVI.]**.

F6. Metronome Volume

You can change the volume of the metronome sound.

Use this function to adjust the metronome volume.

1. Engage Function mode and select **F6**.
2. Use the [–/NO] and [+ /YES] buttons to set the metronome volume as required.

Setting range: 1 – 20

Normal setting: 10

TIP

SHORTCUT:

You can jump directly to the metronome functions **F6** by pressing the [TEMPO/FUNCTION#] button while holding the METRONOME [START/STOP] button.

To exit Function mode, you still need to press the [TEMPO/FUNCTION#] button so that the TEMPO indicator lights up.

F7. Preset Song Part Cancel Volume

This function sets the volume at which a “canceled” part is played during preset song playback. Adjust the part volume to a comfortable level and use the “canceled” part as a guide with which to play along.

1. Engage Function mode and select **F7**.
2. Use the [–/NO] and [+ /YES] buttons to set the volume as required.

Setting range: 0 – 20

Normal setting: 5

F8. MIDI Functions

You can make detailed adjustments to MIDI settings.

For more information about MIDI, see the “About MIDI” section (page 51).

TIP

The HOST SELECT switch on the bottom surface must be set to “MIDI” to enable the MIDI connectors. When you use the TO HOST connector, set the HOST SELECT switch to the appropriate position for the type of computer you are using (pages 51–57). In this situation, all MIDI settings described below will affect the MIDI signal in and out of the TO HOST connector.

1. Engage Function mode and select **F8.4**.
2. Press the [+ /YES] button to engage the MIDI function’s sub-mode, then use the [TEMPO/FUNCTION# ▼ ▲] buttons to select the desired sub-mode.
Press the [–/NO] or [+ /YES] button to set a selected parameter.

Sub-mode

F8.1 MIDI Transmit Channel Selection

In any MIDI control setup, the MIDI channels of the transmitting and receiving equipment must be matched for proper data transfer.

This parameter enables you to specify the channel on which the Clavinova transmits MIDI data.

Setting range: 1 – 16, OFF (not transmitted)

Normal setting: 1

NOTE

In Dual mode, Voice 1 data is transmitted on its specified channel. In Split mode, right voice data is transmitted on its specified channel. In Dual mode, Voice 2 data is transmitted on the next greater channel number relative to the specified channel. In Split mode, left voice data is transmitted on the next greater channel number relative to the specified channel. In either mode, no data is transmitted if the transmit channel is set to “OFF”.

NOTE

Demo/preset song data and recorder playback data are not transmitted via MIDI.

F82 MIDI Receive Channel Selection

In any MIDI control setup, the MIDI channels of the transmitting and receiving equipment must be matched for proper data transfer. This parameter enables you to specify the channel on which the Clavinova receives MIDI data.

Setting range: ALL, 1&2, 1 – 16

Normal setting: ALL

TIP**ALL:**

A “Multi-timbre” Receive mode is available. It allows simultaneous reception of different parts on all 16 MIDI channels, enabling the Clavinova to play multi-channel song data received from a music computer or sequencer.

1&2:

A “1&2” Receive mode is available. It allows simultaneous reception on channels 1 and 2 only, enabling the Clavinova to play 1 and 2 channel song data received from a music computer or sequencer.

TIP

Program change and other like channel messages received will not affect the CLP-F01’s panel settings or the notes you play on the keyboard.

NOTE

No MIDI reception occurs when Demo/Preset Song mode is engaged.

F83 Local Control ON/OFF

“Local Control” refers to the fact that, normally, the CLP-F01 keyboard controls its internal tone generator, allowing the internal voices to be played directly from the keyboard. This situation is “Local Control On,” since the internal tone generator is controlled locally by its own keyboard.

Local control can be turned OFF, however, so that the CLP-F01 keyboard does not play the internal voices, but the appropriate MIDI information is still transmitted via the MIDI OUT connector when notes are played on the keyboard. At the same time, the internal tone generator responds to MIDI information received via the MIDI IN connector.

Setting range: ON/OFF

Normal setting: ON

F84 Program Change ON/OFF

Normally the CLP-F01 will respond to MIDI program change numbers received from an external keyboard or other MIDI device, causing the correspondingly-numbered voice to be selected on the corresponding channel (the keyboard voice does not change). The CLP-F01 will normally also send a MIDI program change number whenever one of its voices is selected, causing the correspondingly-numbered voice or program to be selected on the external MIDI device if the device is set up to receive and respond to MIDI program change numbers. This function makes it possible to cancel program change number reception and transmission so that voices can be selected on the CLP-F01 without affecting the external MIDI device.

TIP

For information on program change numbers for each of the CLP-F01’s voices, refer to page 69 in the MIDI Data Format section.

Setting range: ON/OFF

Normal setting: ON

F85 Control Change ON/OFF

Normally the CLP-F01 will respond to MIDI control change data received from an external MIDI device or keyboard, causing the voice on the corresponding channel to be affected by pedal and other “control” settings received from the controlling device (the keyboard voice is not affected).

The CLP-F01 also transmits MIDI control change information when the pedal or other appropriate controls are operated.

This function makes it possible to cancel control change data reception and transmission so that, for example, the CLP-F01’s pedal and other controls can be operated without affecting an external MIDI device.

TIP

For information on control changes that can be used with the CLP-F01, refer to the MIDI Data Format on page 69.

Setting range: ON/OFF

Normal setting: ON

F85 MIDI Transmit Transpose

This function allows the MIDI note data transmitted by the CLP-F01 to be transposed up or down in semitone increments by up to plus or minus 12 semitones. The pitch of the CLP-F01 itself is not affected.

Setting range: -12 – 0 – 12 (in semitones)

Normal setting: 0

F87 Panel/Status Transmit

This function causes all the current CLP-F01 panel settings (selected voice, etc.) to be transmitted via the MIDI OUT terminal. This is particularly useful if you will be recording performances to a MIDI sequence recorder, such as the Yamaha MIDI Data Filer MDF3, which will be used to control the CLP-F01 on playback. By transmitting the CLP-F01 panel settings and recording them on the MIDI sequence recorder prior to the actual performance data, the CLP-F01 will be automatically restored to the same settings when the performance is played back.

TERMINOLOGY

Setup Data:

Data that contains a set of panel settings for the Clavinova.

Procedure

1. Set up the panel controls as desired.
2. Connect the Clavinova to a sequencer via MIDI, and set up the sequencer so it can receive the setup data.
3. Engage Function mode and select **F87**.
4. Press the **[+ / YES]** button to transmit the panel/status data.

End will appear on the LED display when the data has been successfully transmitted.

TIP

See page 70 for a list of the "Panel Data Contents" transmitted by this function.

TIP

Receiving the transmitted data:

1. Connect the Clavinova via MIDI to the device to which the setup data was transmitted previously.
2. Start sending the setup data from the device.

The Clavinova automatically receives the setup data, which will be reflected in the panel settings.

(For the data to be accepted, the Clavinova that receives the setup data should be the same model as the one that transmitted the setup data to the sequencer.)

TIP

For more information on transmitting and receiving setup data via MIDI, refer to the owner's manual for the connected MIDI device.

F88 Bulk Data Dump

You can save current song data on the Clavinova as MIDI bulk data by transferring it to a connected MIDI data filer (such as an MDF3) or a sequencer. To play back the saved song data, send the bulk data back from the storage device to the Clavinova and follow the usual playback procedure.

TERMINOLOGY

bulk data:

A complete set or extended sequence of data.

Procedure

1. Record your performance on the Clavinova.
2. Connect the Clavinova to MDF3, a MIDI data filer via MIDI, and set up the MDF3 so it will receive bulk data.
3. Engage Function mode and select **F88**.
4. Press the **[+ / YES]** button to begin bulk transmission.

End will appear on the LED display when the data has been successfully transmitted.

NOTE

No MIDI note/panel data transmission or data reception occurs during a bulk data dump transmit operation.

TIP

Receiving (returning) the transmitted data:

1. Connect the CLP-F01 via MIDI to the device to which the data was previously transmitted.
2. Start sending the data from the device.

The CLP-F01 automatically receives the data from the unit. (At this time, any data previously stored in the Clavinova will be erased.)

Then, follow the usual playback procedure.

(For the data to be accepted, the Clavinova that receives the data should be the same model as the one from which the data was once transmitted to the MIDI data filer.)

NOTE

The reload operation cannot be executed when Demo/Preset Song mode or the user song recorder is in operation, or when Function mode is engaged.

TIP

For more information on transmitting and receiving bulk data via MIDI, refer to the owner's manual for the connected MIDI device.

F9. Backup Functions

TERMINOLOGY

Backup:

You can back up some settings, such as voice selection and reverb type, so that they will not be lost when you turn off the power to the Clavinova.

If the backup function is turned on, the settings at power off are effective. If the backup function is turned off, the settings in memory are erased when you turn off the power. In this case, when you turn on the power to the unit, the default settings (the initial settings) will be used. (The factory setting default list is found on page 68.)

However, the backup settings themselves, and the contents of the user song recorder memory, are always backed up.

⚠ CAUTION

Even if the backup function is turned on via one of the functions described below, the data will be retained in memory for only about one week if the power is not turned on during this time. If the backup period is exceeded, all settings will be reset to their default values. If you want to retain the backup settings for longer periods, be sure to turn the power on for a few minutes at least once a week.

You can turn the backup function on or off for each function group (each of the following sub-mode functions).

1. Engage Function mode and select **[F94]**.
2. Press the **[+ / YES]** button to engage the backup function's sub-mode, then use the **[TEMPO / FUNCTION# ▼ ▲]** buttons to select the desired sub-mode.
Press the **[- / NO]** or **[+ / YES]** button to turn the backup function on or off.

Sub-mode

[F91] Voice

[F92] MIDI

[F93] Tuning

[F94] Others

Setting range: ON/OFF

Normal setting: OFF (all groups)

Description of sub-modes

[F91] Voice

- Voice (Keyboard, Dual, and Split)
- Dual (ON/OFF, Voice, and Dual Functions for each voice combination)
- Split (ON/OFF, Voice, and Split Functions for each voice combination)
- Reverb (ON/OFF, Type, and Depth for each voice)
- Effect (ON/OFF, Type, and Depth for each voice)
- Variation (for each voice)
- Touch Sensitivity (including the FIXED volume)
- Metronome (Beat, Volume < **[F5]** settings >)
- Preset Song Part Cancel Volume (**[F7]** settings)

[F92] MIDI

The MIDI functions (**[FB*]** settings)

(expect for the **[FB7]** **[FB8]**)

[F93] Tuning

- Transpose
- Tuning (**[F1]** settings)
- Scale (including base note) (**[F2*]** settings)

[F94] Others

Other functions (**[F5*]** settings)

Factory Preset Recall

All Dual mode, Split mode, reverb, effect, touch sensitivity, tuning settings, and the settings affected by the Backup Functions can be restored to their original factory preset values by holding the C7 key (right-most key on the keyboard) while turning the **[POWER]** button ON. This also erases all user song recorder data, and sets all backup on/off settings (F9) to "OFF". (The factory setting list is found on page 68.)

About MIDI

MIDI (Musical Instrument Digital Interface) is a standard format for data transmission/reception. It enables the transfer of performance data and commands between MIDI devices and personal computers.

Using MIDI, you can control a connected MIDI device from the Clavinova, or control the Clavinova from a connected MIDI device or computer.

MIDI connectors

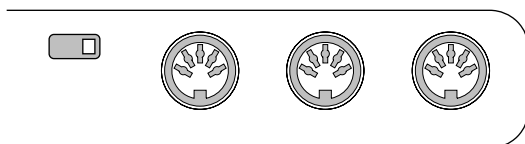

MIDI [IN]: Receives MIDI data.

MIDI [OUT]: Transmits MIDI data.

MIDI [THRU]: Transmits data received at the MIDI [IN] connector as it is.

MIDI cables

Prepare dedicated MIDI cables.

[TO HOST] connector

Use this connector to connect the Clavinova to a computer.

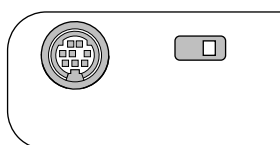

TIP

MIDI performance data and commands are transferred in the form of numeric values.

TIP

Since MIDI data that can be transmitted or received varies depending on the type of MIDI device, check the "MIDI Implementation Chart" to find out what MIDI data and commands your devices can transmit or receive. The Clavinova's MIDI Implementation Chart appears on page 73.

NOTE

When you are using the MIDI connectors, set the **[HOST SELECT]** switch to "MIDI" (page 56).

NOTE

When you are using the **[TO HOST]** connector, set the **[HOST SELECT]** switch, according to the type of computer you are using (page 56).

TIP

You can also obtain detailed information about MIDI from various music books and other publications.

Connections

Connectors

⚠ CAUTION

Before connecting the Clavinova to other electronic components, turn off the power to all the components. Before turning the power on or off to all components, set all volume levels to minimum (0). Otherwise, electrical shock or damage to the components may result.

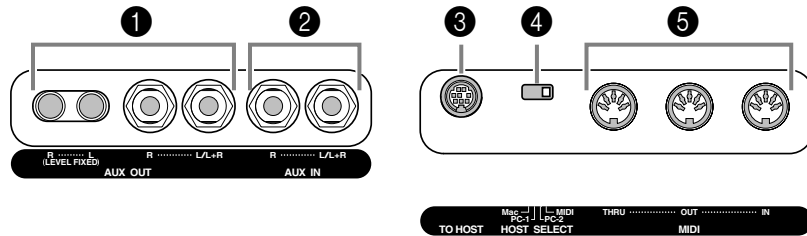

1 AUX OUT [R] [L] Pin jacks (LEVEL FIXED), [R] [L/L+R] Phone jacks

You can connect these jacks to a stereo system to amplify the Clavinova or to a cassette tape recorder to record your performance. Refer to the diagram below and use audio cables to make the connections.

⚠ CAUTION

Do not route the output from the AUX OUT jacks to the AUX IN jacks. That is, when you connect an external audio device to the AUX OUT jacks, do not connect the audio device to the Clavinova's AUX IN jacks. If you make this connection, the signal input at the AUX IN jacks will be output from AUX OUT. This creates an audio loop, causing audio oscillation and abnormal playback, and leading to malfunction of both pieces of equipment.

⚠ CAUTION

When the Clavinova's AUX OUT jacks are connected to an external audio system, first turn on the power to the Clavinova, then to the external audio system. Reverse this order when you turn the power off.

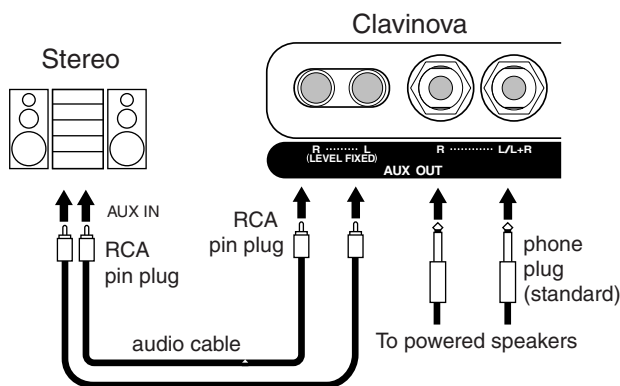

When these are connected (with RCA pin plug; LEVEL FIXED), the sound is output to the external device at a fixed level, regardless of the [MASTER VOLUME] control setting.

When these are connected (with standard phone plugs), you can use the [MASTER VOLUME] control to adjust the volume of the sound output to the external device.

NOTE

Use audio cables and adaptor plugs with no resistance.

NOTE

The Clavinova's [MASTER VOLUME] and [BRILLIANCE] control setting does not affect the signal output from the AUX OUT (LEVEL FIXED) jacks.

2 AUX IN [R], [L/L+R] jacks

The stereo outputs from another instrument can be connected to these jacks, allowing the sound of an external instrument to be reproduced via the Clavinova's speakers. Refer to the diagram below and use audio cables to make the connections.

⚠ CAUTION

When the Clavinova's AUX IN jacks are connected to an external device, first turn on the power to the external device, then to the Clavinova. Reverse this order when you turn the power off.

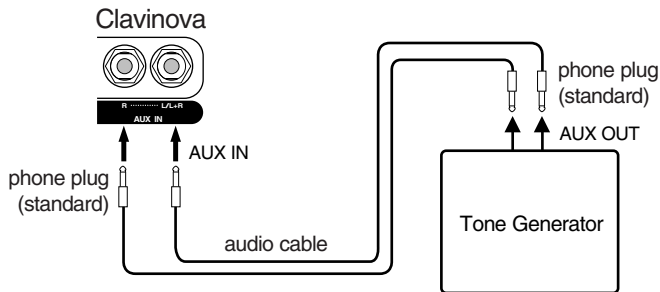

3 TO HOST jack

This jack allows direct connection to a personal computer. (Refer to “Connecting a personal computer” on page 54 for more information.)

4 HOST SELECT switch

This switch should be set according to the type of connected MIDI device or personal computer. (Refer to “Connecting a personal computer” on page 54 for more information.)

5 MIDI [IN], [OUT], [THRU] connectors

Use MIDI cables to connect external MIDI devices to these connectors. Make sure you set the HOST SELECT switch to MIDI when you use these connectors. (Refer to “About MIDI” on page 51 for more information.)

NOTE

The Clavinova's [MASTER VOLUME] and [BRILLIANCE] control settings affect the input signal from the AUX IN jacks, but the [REVERB] and [EFFECT] settings do not.

NOTE

If you connect the Clavinova to a monaural device, use only the AUX IN [L/L+R] jack or AUX OUT [L/L+R] jack.

Connecting a Personal Computer

You can enjoy computer music data on the Clavinova by connecting a computer to the TO HOST (or MIDI) jack.

NOTE When the Clavinova is used as a tone module, performance data with voices that are not found on the Clavinova will not be played correctly.

“The Clavinova-Computer Connection,” is a supplementary guidebook that describes, for beginners, what you can do with your Clavinova and a personal computer and how to set up a Clavinova-Computer system (the manual is not written for any specific models). The document is available as a PDF file (in English) at the following Internet address.

Yamaha Manual Library:

<http://www2.yamaha.co.jp/manual/english/>

There are three methods by which to connect the Clavinova to a personal computer:

1. Connect the serial port on the computer to the Clavinova's TO HOST jack (page 55).
2. Use a MIDI interface and the Clavinova's MIDI connectors (page 56).
3. Use the USB port on the computer and the UX16, UX96, or UX256, a USB interface (page 57).

For more information, refer to the specified pages.

NOTE When connecting the Clavinova to a personal computer, first turn off the power to both the Clavinova and the computer before you connect any cables or set the HOST SELECT switch. After making the connections and switch settings, turn on the power to the computer first, then to the Clavinova.

NOTE If you do not use the [TO HOST] jack of the Clavinova, make sure you disconnect the cable from the jack. If the cable is left connected, the Clavinova may not function properly.

NOTE [H5F] will appear in the display if the host computer is not turned on, the connecting cable is not properly connected, the HOST SELECT switch is not in the proper position, or the MIDI driver or MIDI application is not active. In this situation, turn the power off to both the Clavinova and the computer, and check the cable connection and the position of the HOST SELECT switch. Once the connection and HOST SELECT switch position is verified, turn the power of the computer on first, then the Clavinova, and check whether the MIDI driver and MIDI application function properly.

NOTE When the [HOST SELECT] switch is set to “PC-1,” “PC-2,” or “Mac,” you can use the [TO HOST] jack, but the MIDI connectors are disabled since no data transfer occurs via the MIDI connectors. On the other hand, when the [HOST SELECT] switch is set to “MIDI,” you can use the MIDI connectors, but not the [TO HOST] jack since no data is transferred via the [TO HOST] jack.

1. Connecting the serial port on the computer to the Clavinova's TO HOST jack

Connect the computer's serial port (RS-232C or RS-422) to the Clavinova's TO HOST jack.

With this connection, the Clavinova functions as a MIDI interface. Therefore, you do not need a special MIDI interface.

Connection

Use a special serial cable (page 55) to connect the computer's serial port (RS-232C or RS-422) to the Clavinova's TO HOST jack.

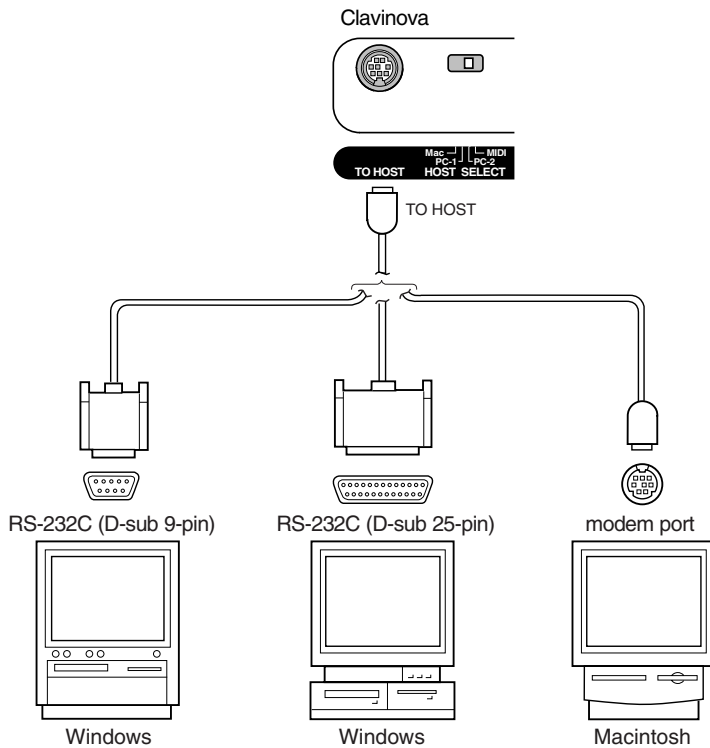

Note for Windows users (regarding the MIDI driver)
 To transfer data via the computer's serial port and the Clavinova's TO HOST jack, you need to install a specific MIDI driver (the Yamaha CBX-MIDI driver for Windows). You can download this driver from the following Yamaha web site:
<http://music.yamaha.com/download/>

Type of serial cables and connection pin assignments

Depending on the type of computer you connect, use one of the following serial cables.

Windows (with a serial port of D-sub 9-pin)

8-pin mini DIN plug → D-sub 9-pin plug
 (Yamaha CCJ-PC2 or equivalent)

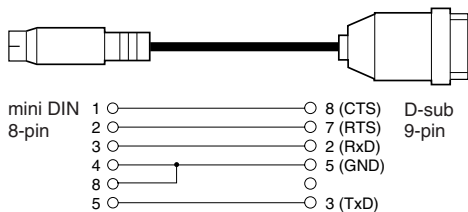

Macintosh

System peripheral plug → 8-pin plug
 (Yamaha CCJ-MAC or equivalent)

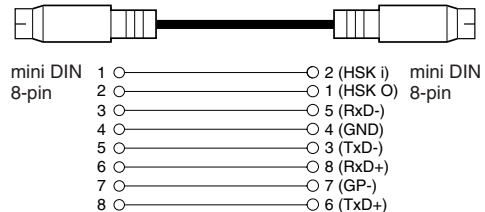

Windows (with a serial port of D-sub 25-pin)

8-pin mini DIN plug → D-sub 25-pin plug
 (Yamaha CCJ-PC1NF or equivalent)

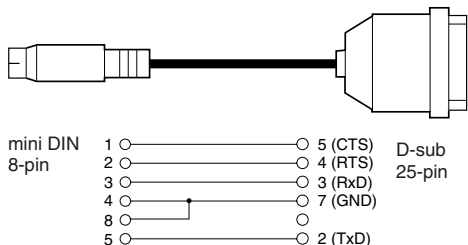

Pin assignment

The following diagram shows the pin assignments for each cable.

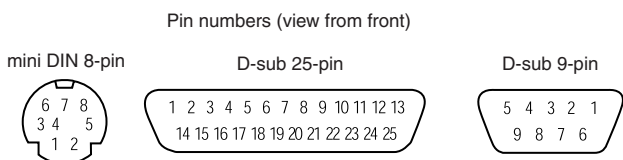

Clavinova HOST SELECT switch setting

Set the Clavinova HOST SELECT switch properly according to the type of connected computer.

- **Macintosh:** “Mac” (data transfer rate: 31,250bps, 1MHz clock)
- **Windows:** “PC-2” (data transfer rate: 38,400bps)

TIP

If your system does not work properly with the connections and settings listed above, your software may require different settings. Check your software operation manual and set the HOST SELECT switch to the proper data transfer rate. (Data transfer rate of “PC-1” is 31,250bps.)

2. Using a MIDI interface and the Clavinova’s MIDI connectors

Connection

Use a MIDI interface device to connect a computer to the Clavinova using special MIDI cables.

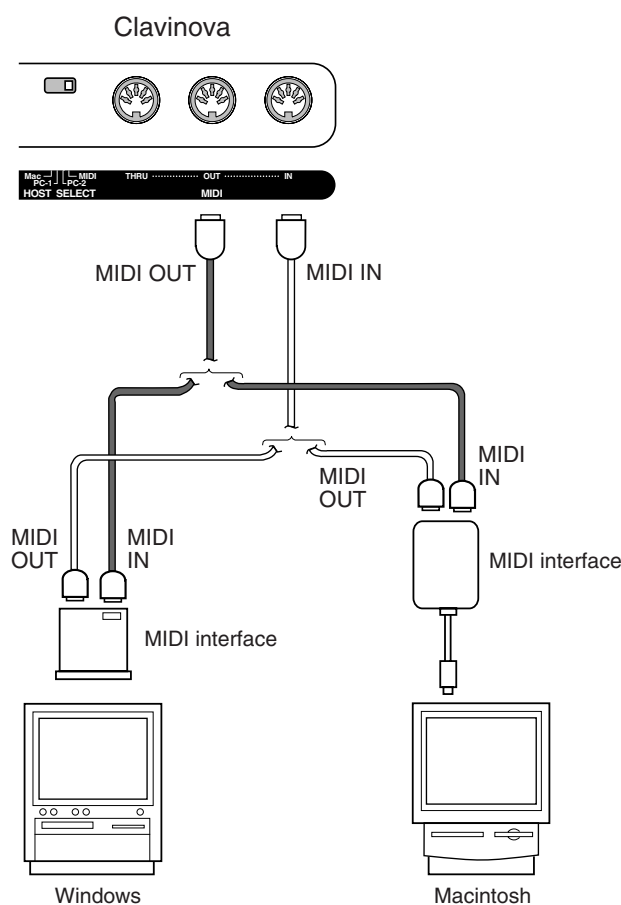

Clavinova HOST SELECT switch setting

Set the Clavinova HOST SELECT switch to “MIDI.”

3. Connecting the computer's USB port to the Clavinova via a USB interface, such as the UX16, UX96, or UX256

Connect the computer's USB port to the USB interface (such as the UX16, UX96 or UX256) using a USB cable. Install the driver (that came with the USB interface) on the computer, and connect the USB interface to the Clavinova using a serial cable or MIDI cables.

For more information, refer to the instruction manual for the USB interface.

An example of connecting the USB interface to the Clavinova using a serial cable

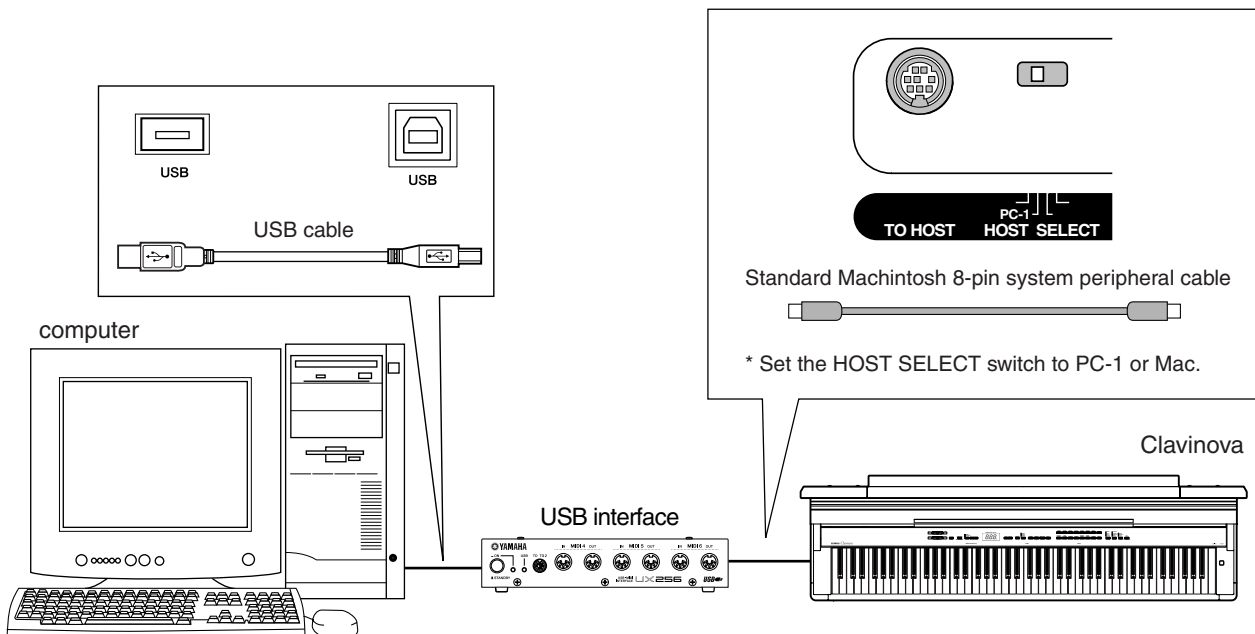

An example of connecting the USB interface to the Clavinova using MIDI cables

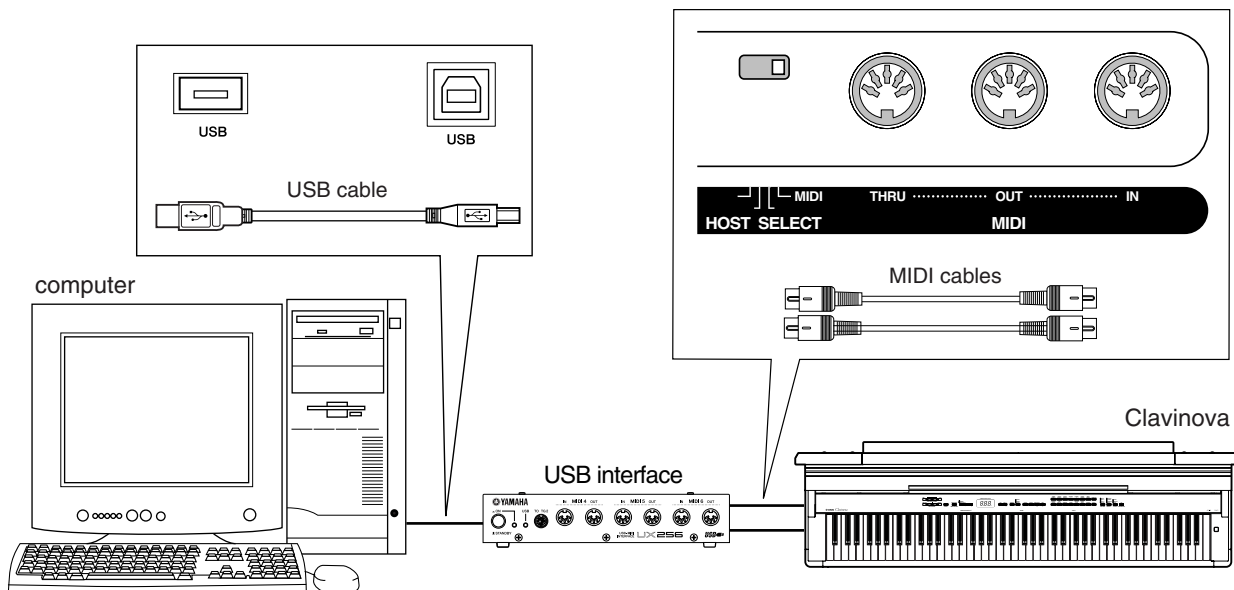

Troubleshooting

Problem	Possible Cause and Solution
The Clavinova does not turn on.	The Clavinova has not been plugged in properly. Securely insert the female plug into the socket on the Clavinova, and the male plug into a proper AC outlet (page 12).
A click or pop is heard when the power is turned on or off.	This is normal when electrical current is being applied to the instrument.
Noise is heard from the speakers or headphones.	The noise may be due to interference caused by the use of a mobile phone in close proximity to the Clavinova. Turn off the mobile phone, or use it further away from the Clavinova.
The overall volume is low, or no sound is heard.	<ul style="list-style-type: none"> • The Master Volume is set too low; set it to an appropriate level using the [MASTER VOLUME] control. • Make sure a pair of headphones is not connected to the headphones jack (when the SPEAKER switch is set to the "NORMAL" position). If the SPEAKER switch is set to the "OFF" position, set it to "NORMAL" or "ON" (page 13). • Make sure that Local Control (page 48) is ON.
The speakers do not switch off when a pair of headphones is connected.	The SPEAKER switch may be switched "ON." Set the SPEAKER switch to the "NORMAL" position (page 13).

TIP

If 5 c n appears on the display, an internal malfunction has occurred. In this case, contact your Yamaha dealer.

Keyboard Stand Assembly

⚠ CAUTION

- Be careful not to confuse parts, and be sure to install all parts in the correct direction. Please assemble in accordance with the sequence given below.
- Assembly should be carried out by at least two persons.
- Be sure to use the correct screw size, as indicated below. Use of incorrect screws can cause damage.
- Be sure to tighten up all screws upon completing assembly of each unit.
- To disassemble, reverse the assembly sequence given below.

Have a Phillips-head (+) screwdriver ready.

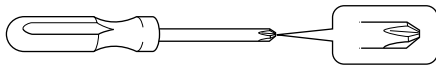

Remove the following parts from the package.

Assembly Parts

6 × 45 mm long screws × 4 ①



6 × 14 mm short screws × 12 ②



Cord holders × 2



Rear panel (left) Rear panel (center) Rear panel (right)

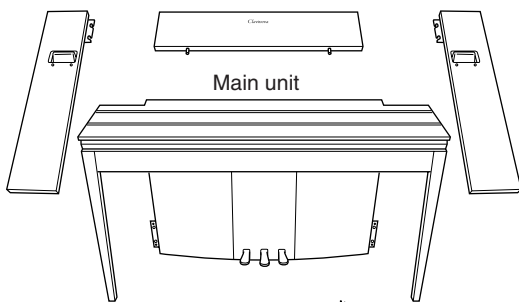

AC power cord

keyboard stand stabilizers: 2 pieces

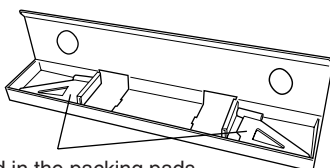

Included in the packing pads.

Preparing the rear panels

When the package is shipped from the factory, the rear panels are secured to the wooden fixing pads with screws. Before you can start assembling the rear panels, you must first remove them from the fixing pads.

Removing the panels:

Stack two packing pads (included in the packing box with the rear panels) under the rear panels, then remove the screws as shown in the illustrations.

⚠ CAUTION

- Do not use screws fixing rear panels to assemble the Clavinova.

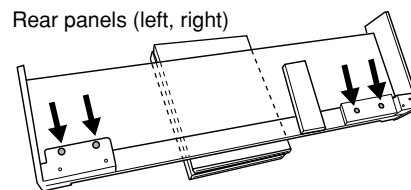
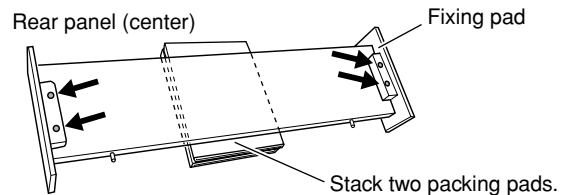

1 Insert the rear panel (center).

Position the rear panel (center) so that the word “Clavinova” faces the front (keyboard side). Then insert the projections on the panel into the holes on top of the unit, as shown in the illustration.

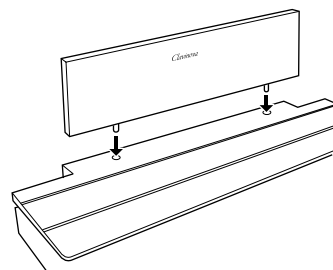

⚠ CAUTION

- When the rear panel (center) is inserted in the main unit, do not apply pressure to the rear panel (center) from the front or rear. Doing so may damage the projections of the rear panel (center), allowing it to fall or be damaged.

2 Install the rear panels (left and right).

- Attach two short screws (6 × 14mm) to each edge of the rear panel (center) using your fingers so that the screw threads project about 10mm from the surface. Make sure that the screws will not loosen and fall out of the holes.

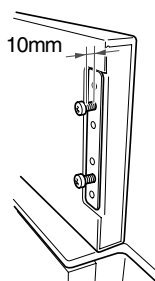

- Make sure that the screws you finger-tightened in Step ① have not loosened. Then position the handhold of the rear (left) panel toward the rear, and hook the bracket of the rear (left) panel onto the projecting screws as shown in the illustration ②. When doing so, be careful that the bracket does not scratch the rear panel (center).
- Align the holes located under the handhold on the rear panel (left) with the holes on the main unit, then tighten two long screws (6 × 45mm) to secure the panel to the unit.
- Lightly tighten two short screws (6 × 14mm) into the bracket on the bottom of the unit to secure the panel to the unit.

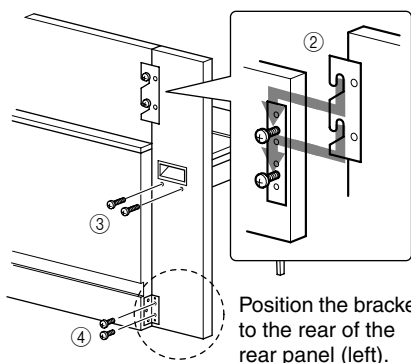

- Follow the same steps to install the rear panel (right).

3 Fasten the rear panels securely.

Tighten the screws securely in the order shown in the illustration. Be careful not to permit misaligned levels on the front surface, or a gap on the top surface of rear panels (center, left, and right).

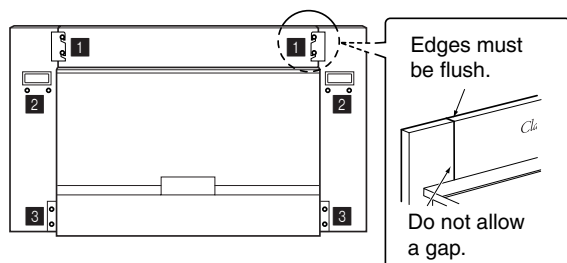

4 Attach the fall-prevention bracket.

Align the second and fourth holes on the fall-prevention bracket with the bracket holes on the bottom of the unit, then secure the bracket using two short screws (6 × 14mm).

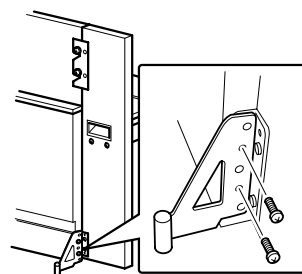

5 Set the voltage selector and connect the power cord.

- Insert the AC power cord plug into the AC INLET connector on the rear of the unit.
- Attach the cord holders in the locations along the path of the power cord on the rear panel, then clip the cord into the holders.

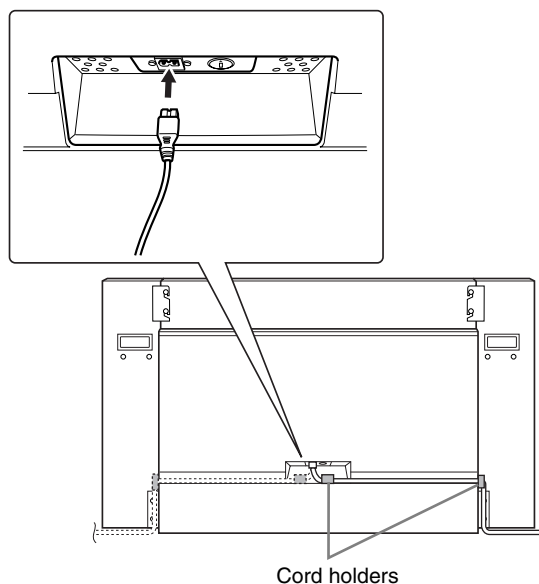

Voltage Selector

Before connecting the AC power cord, check the setting of the voltage selector which is provided in some areas. To set the selector for 110V, 127V, 220V or 240V main voltages, use a “minus” screwdriver to rotate the selector dial so that the correct voltage for your region appears next to the pointer on the panel. The voltage selector is set at 240V when the unit is initially shipped. After the proper voltage has been selected, connect the AC power cord to the AC INLET and an AC wall outlet. A plug adaptor may be also provided in some areas to match the pin configuration of the AC wall outlets in your area.

⚠ WARNING

An improper voltage setting can cause serious damage to the Clavinova or result in improper operation.

After completing the assembly, please check the following.

- **Are there any parts left over?**
→ Review the assembly procedure and correct any errors.
- **Is the Clavinova clear of doors and other movable fixtures?**
→ Move the Clavinova to an appropriate location.
- **Does the Clavinova make a rattling noise when you shake it?**
→ Tighten all screws.
→ Be sure to install the fall-prevention brackets securely.
- **Is the power cord inserted securely into the sockets?**
→ Check the connection.
- **If the main unit creaks or is otherwise unsteady when you play on the keyboard, refer to the assembly diagrams and retighten all screws.**

When you move the assembled instrument, be sure to grasp the handles and the bottom of the keyboard.

⚠ CAUTION

Do not hold the key cover. Improper handling can result in damage to the instrument or personal injury.

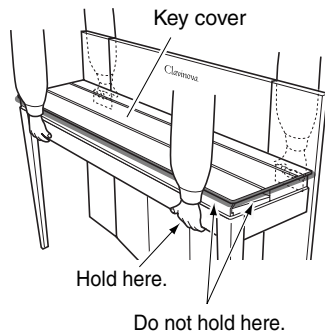

Preset Voice List

Voice Name	Stereo Sampling	Touch Response	Dynamic Sampling ¹	Key-Off Sampling ²	Voice Descriptions
GRANDPIANO 1	○	○	○	○	Recorded samples from a full concert grand piano. Also includes three levels of dynamic sampling, sustain samples, and key-off samples for exceptionally realistic acoustic grand piano sound. Perfect for classical compositions as well as any other style that requires acoustic piano.
VARIATION	○	○	○	○	Warm and mellow piano. Good for classical compositions.
GRANDPIANO 2	○	○	—	—	Spacious and clear piano with bright reverb. Good for popular music.
VARIATION	○	○	—	—	Bright, spacious piano. Good for popular or rock music.
GRANDPIANO 3	○	○	○	○	A very bright piano sound good for rock music.
VARIATION	○	○	○	○	A honky-tonk piano sound that is an enjoyable variation from the grand piano voices.
E.PIANO 1	—	○	○	—	An electronic piano sound created by FM synthesis. Extremely “musical” response with varying timbre according to keyboard dynamics. Good for standard popular music.
VARIATION	—	○	—	—	A synth-generated type electronic piano sound often heard in popular music. Used in the DUAL mode it blends well with an acoustic piano voice.
E.PIANO 2	—	○	○	—	The sound of an electric piano using hammer-struck metallic “tines”. Soft tone when played lightly, and an aggressive tone when played hard.
VARIATION	—	○	○	—	A slightly different electric piano sound often heard in rock and popular music.
HARPSICHORD	○	—	—	○	The definitive instrument for baroque music. Since harpsichord uses plucked strings, there is no touch response. There is, however, a characteristic additional sound when the keys are released.
VARIATION	○	—	—	○	Mixes the same voice an octave higher for a more brilliant tone.
VIBRAPHONE	○	○	○	—	Vibraphone played with relatively soft mallets. The tone becomes more metallic the harder you play.
VARIATION	○	○	—	—	Stereo-sampled, spacious, and realistic marimba.
CHURCH ORGAN	○	—	—	—	This is a typical pipe organ sound (8 feet + 4 feet + 2 feet). Good for sacred music from the Baroque period.
VARIATION	○	—	—	—	This is the organ's full coupler sound often associated with Beach's “Toccata and Fugue”.
JAZZ ORGAN	—	—	—	—	The sound of a “tonewheel” type electric organ. Often heard in jazz and rock idioms.
VARIATION	—	—	—	—	Uses a rotary speaker effect with a different speed. The variations speed is faster. If the variation is selected while holding a chord, the speed of the effect will gradually change.
STRINGS	○	○	—	—	Stereo-sampled, large-scale strings ensemble with realistic reverb. Try combining this voice with piano in the DUAL mode.
VARIATION	○	○	—	—	Spacious strings ensemble with a slow attack. Try combining this voice with a piano or electric piano in the DUAL mode.
CHOIR	—	○	—	—	A big, spacious choir voice. Perfect for creating rich harmonies in slow pieces.
VARIATION	—	○	—	—	A choir voice with a slow attack. Try combining this voice with a piano or electric piano in the DUAL mode.

Voice Name	Stereo Sampling	Touch Response	Dynamic Sampling ^{*1}	Key-Off Sampling ^{*2}	Voice Descriptions
GUITAR/CLAVI.	—	○	—	—	Warm and natural-sounding nylon guitar. Enjoy the quiet ambience of nylon strings.
VARIATION	—	○	—	○	A hammer-struck keyboard instrument that utilizes an electric pickup that is often heard in funk and soul music. Its tone is noted for the unique sound produced when the keys are released.
WOOD BASS	—	○	—	—	An upright bass played fingerstyle. Ideal for jazz and Latin music.
VARIATION	—	○	—	—	Adds a cymbal voice to the bass sound. Ideal for walking bass lines in jazz tunes.
E.BASS	—	○	—	—	Electric bass for a wide range of music styles, jazz, rock, popular, and more.
VARIATION	—	○	—	—	A fretless bass good for styles such as jazz, fusion, etc.

*1. Dynamic Sampling provides multiple velocity-switched samples to accurately simulate the timbral response of an acoustic instrument.

*2. Contains a very subtle sample that is produced when the keys are released.

Demo Song List

Voice Name	Title	Composer
GRAND PIANO 1	Consolation No.3	F. Liszt
HARPSICHORD	Gavotte	J.S. Bach

The demonstration pieces listed above are short rearranged excerpts the original compositions. All other songs are original (©2004 Yamaha Corporation).

Piano Voice Demo Description

Voice Name	Piano Voice Demo
GRAND PIANO 1	Stereo sampling
GRAND PIANO 2	Monaural sampling
GRAND PIANO 3	Dynamic sampling; mezzo piano
E.PIANO 1	Dynamic sampling; mezzo forte
E.PIANO 2	Dynamic sampling; forte
HARPSICHORD	With sustain sampling
VIBRAPHONE	Without sustain sampling
CHURCH ORGAN	With key-off sampling
JAZZ ORGAN	Without key-off sampling

Index

Numerics

- 50 Greats for the Piano 19
- 50 Piano Preset Songs 19

A

- A-B Repeat for 50 Preset Songs 22
- Accessories 8
- Adding Variations 24
- Adjust
 - Brilliance 18, 24
 - Tempo (50 Piano Preset Songs) 19
 - Tempo (Recorded Songs) 37
 - Volume (50 Piano Preset Songs) 19
 - Volume (Demo) 18
 - Volume (Metronome) 47
- ALL (LED display) 19
- Assembly 59–61
- AUX IN 16, 53
- AUX OUT 16, 52

B

- Backup Functions 50
- BRILLIANCE 16, 24

C

- Center Pedal 16, 24
- Combining Two Voices (Dual mode) 28
- Connecting a Personal Computer 54
- Connections 52
- Connectors 52

D

- Damper Pedal 16, 23, 45
- DEMO 16, 18
- Demo Song List 64
- Detailed Settings (FUNCTION) 39
- Dual mode 28, 44

E

- EFFECT 16, 25

F

- Factory Setting List 68
- Fine Tuning of the Pitch 42
- FUL (LED display) 33
- FUNCTION 16, 42–50
 - Basic Procedure 40
- Function Parameter List 68

H

- HOST SELECT 16, 53, 56
- HST (LED display) 54

K

- Key Cover 10

L

- LED display 16
- Left Pedal 16, 24, 46
- List
 - Demo Song 64
 - Factory Setting 68
 - Functions 39
 - Preset Voice 62

M

- MASTER VOLUME 13, 16
- METRONOME 16, 31
- Metronome Volume 47
- MIDI 51
- MIDI [IN] [OUT] [THRU] 16, 53
- MIDI cables 51, 56, 57
- MIDI connectors 51, 56
- MIDI Data Format 69
- MIDI driver 55
- MIDI Functions 47
- Music Rest 11

N

- Normal setting 24

P

PHONES.....	13, 16
Piano Voice Demo Description.....	64
Pitch → Fine Tuning of the Pitch.....	42
POWER.....	12, 16
Practicing a One-Hand Part Using 50 Preset Songs.....	20
Precautions	3–4
PRESET	16, 19
Preset Song Part.....	47
Preset songs → 50 Piano Preset Songs	19
Preset Voice List	62

R

REC → Recording.....	16, 33
Recording.....	32
Initial Settings.....	36
Re-recording.....	34
REVERB.....	16, 24
Right Pedal.....	16, 23
rnd (LED display).....	19

S

Scale.....	43
Scn (LED display).....	58
Serial cable	55, 57
Soft Pedal	16, 24, 46
Sostenuto Pedal	16, 24
SPEAKER.....	13, 16
Specifications.....	74
SPLIT	16, 29, 45
START/STOP (Demo).....	18
START/STOP (METRONOME).....	16, 31
Start/Stop (Pedal).....	38
START/STOP (SONG)	16
Start/Stop playback	
50 Piano Preset Songs.....	19
Demonstration Tunes	18
Recorded Songs	37
Useful Playback Functions.....	38
Start/Stop recording.....	33
Sustain Pedal.....	46
Synchro Start	
50 Piano Preset Songs.....	21
Recorded Songs	38

T

TEMPO.....	16, 19, 37
TEMPO (METRONOME)	31
TO HOST	16, 51
TOUCH.....	16, 26
Touch Sensitivity.....	26
TRACK 1/2 (50 Piano Preset Songs)	20
TRACK 1/2 (Recording).....	33
Track Playback On and Off.....	38
Transporting	8
TRANSPOSE.....	16, 27
Troubleshooting.....	58
Tuning → Fine Tuning of the Pitch.....	42

U

USB	57
USER 1/2/3	32

V

VARIATION	24
VOICE	16, 23

Appendix

This section introduces reference material.

In diesem Abschnitt finden Sie Referenzmaterial.

Cette section présente le matériel de référence.

En esta sección se incluye material de referencia.

Factory Setting List / Liste der Vorgabeeinstellungen / Liste des réglages / Lista de ajustes de fábrica.....	68
MIDI Data Format / MIDI-Datenformat / Format des données MIDI / Formato de datos MIDI.....	69
MIDI Implementation Chart / MIDI Implementierung stabelle / Feuille d'implantation MIDI / Gráfica de implementación MIDI.....	73
Specifications / Technische Daten / Caractéristiques techniques / Especificaciones	74

Factory Setting List / Liste der Vorgabeeinstellungen / Liste des réglages / Lista de ajustes de fábrica

		Backup Group
Voice	GRAND PIANO 1	F9.1
Variation	OFF	
Dual Mode	OFF	
Split Mode	OFF	
Split Mode Left Voice	WOOD BASS	
Reverb Type	Preset for each voice	
Reverb Depth	Preset for each voice	
Effect Type	Preset for each voice	
Effect Depth	Preset for each voice	
Touch Sensitivity	MEDIUM	
Volume in the FIXED Mode	64	
Metronome	OFF	—
Metronome Time Signature	0 (no accent)	F9.1
Tempo	120	—
Transpose	0	F9.3

Function

Function number	Function	Default	Backup Group
F1	Tuning	A3=440Hz	F9.3
F2.1	Scale	1 (Equal Temperament)	
F2.2	Base Note	C	
F3.1	Dual Balance	Preset for each voice combination	F9.1
F3.2	Dual Detune	Preset for each voice combination	
F3.3, F3.4	Dual Octave Shift	Preset for each voice combination	
F3.5, F3.6	Dual Effect Depth	Preset for each voice combination	
F4.1	Split Point	F#2	
F4.2	Split Balance	Preset for each voice combination	
F4.3, F4.4	Split Octave Shift	Preset for each voice combination	
F4.5, F4.6	Split Effect Depth	Preset for each voice combination	
F4.7	Damper Pedal Range	ALL	F9.4
F5.1	Left Pedal Mode	1 (Soft Pedal)	
F5.2	Soft Pedal Effect Depth	3	
F5.3	Sustain Sample Depth	12	
F5.4	Keyoff Sample Volume	10	F9.1
F6	Metronome Volume	10	
F7	Preset Song Part Cancel Volume	5	F9.2
F8.1	MIDI Transmit Channel	1	
F8.2	MIDI Receive Channel	ALL	
F8.3	Local Control	ON	
F8.4	Program Change Send & Receive	ON	
F8.5	Control Change Send & Receive	ON	
F8.6	MIDI Transmit Transpose	0	
F9	Backup	All OFF	Always backed up

MIDI Data Format / MIDI-Datenformat / Format des données MIDI / Formato de datos MIDI

If you're already very familiar with MIDI, or are using a computer to control your music hardware with computer-generated MIDI messages, the data provided in this section can help you to control the CLP-F01.

Falls Sie bereits mit MIDI vertraut sind oder einen Computer zur Erzeugung von MIDI-Steuermeldungen für die Instrumente verwenden, können Sie sich zur Steuerung des CLP-F01 nach den im folgenden Abschnitt aufgeführten Spezifikationen richten.

1. NOTE ON/OFF

Data format: [9nH] -> [kk] -> [vv]

9nH = Note ON/OFF event (n = channel number)
kk = Note number (Transmit: 09H ~ 78H = A-2 ~ C8 /
Receive: 00H ~ 7FH = C-2 ~ G8)*
vv = Velocity (Key ON = 01H ~ 7FH, Key OFF = 00H)

Data format: [8nH] -> [kk] -> [vv] (reception only)

8nH = Note OFF event (n = channel number)
kk = Note number: 00H ~ 7FH = C-2 ~ G8
vv = Velocity

* If received value exceeds the supported range for the selected voice, the note is adjusted by the necessary number of octaves.

2. CONTROL CHANGE

Data format: [BnH] -> [cc] -> [vv]

BnH = Control change (n = channel number)
cc = Control number
vv = Data Range

(1) Bank Select

ccH	Parameter	Data Range (vvH)
00H	Bank Select MSB	00H:Normal
20H	Bank Select LSB	00H...7FH

Bank selection processing does not occur until receipt of next Program Change message.

(2) Main Volume (reception only)

ccH	Parameter	Data Range (vvH)
07H	Volume MSB	00H...7FH

(3) Expression

ccH	Parameter	Data Range (vvH)
0BH	Expression MSB	00H...7FH

(4) Damper

ccH	Parameter	Data Range (vvH)
40H	Damper MSB	00H...7FH

(5) Sostenuto

ccH	Parameter	Data Range (vvH)
42H	Sostenuto	00H-3FH:off, 40H-7FH:on

(6) Soft Pedal

ccH	Parameter	Data Range (vvH)
43H	Soft Pedal	00H-3FH:off, 40H-7FH:on

(7) Effect1 Depth (Reverb Send Level)

ccH	Parameter	Data Range (vvH)
5BH	Effect1 Depth	00H...7FH

Adjusts the reverb send level.

(8) Effect4 Depth (Variation Effect Send Level)

ccH	Parameter	Data Range (vvH)
5EH	Effect4 Depth	00H...7FH

Si vous êtes très familier avec l'interface MIDI ou si vous utilisez un ordinateur pour commander votre matériel de musique au moyen de messages MIDI générés par ordinateur, les données suivantes vous seront utiles et vous aideront à commander le CLP-F01.

Si usted está ya familiarizado con MIDI, o si emplea una computadora para controlar sus aparatos musicales con mensajes MIDI generados por computadora, los datos proporcionados en esta sección le ayudarán a controlar la CLP-F01.

3. MODE MESSAGES

Data format: [BnH] -> [cc] -> [vv]

BnH = Control event (n = channel number)
cc = Control number
vv = Data Range

(1) All Sound Off

ccH	Parameter	Data Range (vvH)
78H	All Sound Off	00H

Switches off all sound from the channel. Does not reset Note On and Hold On conditions established by Channel Messages.

(2) Reset All Controllers

ccH	Parameter	Data Range (vvH)
79H	Reset All Controllers	00H

Resets controllers as follows.

Controller	Value
Expression	127 (max)
Damper Pedal	0 (off)
Sostenuto	0 (off)
Soft Pedal	0 (off)

(3) Local Control (reception only)

ccH	Parameter	Data Range (vvH)
7AH	Local Control	00H (off), 7FH (on)

(4) All Notes Off

ccH	Parameter	Data Range (vvH)
7BH	All Notes Off	00H

Switches OFF all the notes that are currently ON on the specified channel. Any notes being held by the damper or sostenuto pedal will continue to sound until the pedal is released.

(5) Omni Off (reception only)

ccH	Parameter	Data Range (vvH)
7CH	Omni Off	00H

Same processing as for All Notes Off.

(6) Omni On (reception only)

ccH	Parameter	Data Range (vvH)
7DH	Omni On	00H

Same processing as for All Notes Off.

(7) Mono (reception only)

ccH	Parameter	Data Range (vvH)
7EH	Mono	00H

Same processing as for All Sound Off.

(8) Poly (reception only)

ccH	Parameter	Data Range (vvH)
7FH	Poly	00H

Same processing as for All Sound Off.

- When control change reception is turned OFF in the Function mode, control change data will not be transmitted or received except for Bank Select and Mode messages.
- Local on/off, OMNI on/off are not transmitted. (The appropriate note off number is supplied with "All Note Off" transmission).
- When a voice bank MSB/LSB is received, the number is stored in the internal buffer regardless of the received order, then the stored value is used to select the appropriate voice when a program change message is received.
- The Multi-timbre and Poly modes are always active. No change occurs when OMNI ON, OMNI OFF, MONO, or POLY mode messages are received.

4. PROGRAM CHANGE

Data format: [CnH] -> [ppH]

CnH = Program event (n = channel number)

ppH = Program change number

P.C.#=Program Change number

Voice Name	MSB	LSB	P.C.# (1-128)
GRANDPIANO 1	0	122	1
VARIATION	0	123	1
GRANDPIANO 2	0	112	1
VARIATION	0	112	2
GRANDPIANO 3	0	122	2
VARIATION	0	122	4
E.PIANO 1	0	122	6
VARIATION	0	122	89
E.PIANO 2	0	122	5
VARIATION	0	123	5
HARPSICHORD	0	122	7
VARIATION	0	123	7
VIBRAPHONE	0	122	12
VARIATION	0	122	13
CHURCH ORGAN	0	123	20
VARIATION	0	122	20
JAZZ ORGAN	0	122	17
VARIATION	0	123	17
STRINGS	0	122	49
VARIATION	0	122	50
CHOIR	0	122	53
VARIATION	0	123	53
GUITAR/CLAVI.	0	122	25
VARIATION	0	122	8
WOOD BASS	0	122	33
VARIATION	0	124	33
E.BASS	0	122	34
VARIATION	0	122	36

- If you assign Program Change numbers using numbers 0 through 127, subtract one (1) from a Program change number (P.C. #) listed above. For example, if you wish to change to a Program with the P.C. #1, specify number 0.
- When program change reception is turned OFF in the Function mode, no program change data is transmitted or received. Also, Bank MSB/LSB is not transmitted or received.

5. SYSTEM REALTIME MESSAGES

[rrH]

F8H: Timing clock

FAH: Start

FCH: Stop

FEH: Active sensing

Data	Transmission	Reception
F8H	Transmitted every 96 clocks	Received as 96-clock tempo timing when MIDI clock is set to External
FAH	Recorder start	Recorder start Not received when the MIDI clock is set to Internal.
FCH	Recorder stop	Recorder stop Not received when the MIDI clock is set to Internal.
FEH	Transmitted every 200 milliseconds	If a signal is not received via MIDI for more than 400 milliseconds, the same processing will take place for All Sound Off, All Notes Off and Reset All Controllers as when those signals are received.

- Caution: If an error occurs during MIDI reception, the Damper, Sostenuto, and Soft effects for all channels are turned off and an All Note Off occurs.

6. SYSTEM EXCLUSIVE MESSAGES

(Yamaha MIDI Format)

Panel Data Transmit

Data format: [F0H] -> [43H] -> [0nH] -> [7CH] -> ... -> [F7H]

F0H, 43H, 0nH, 7CH (n: channel number)

00H, 2DH (data length)

43H, 4CH, 20H, 20H (CL)

43H, 4CH, 50H, 27H, 30H, 34H (CLP'04)

30H, 30H (version x, y)

[PANEL DATA]

[CHECK SUM (1byte)] = 0-(43H+4CH+20H+.....+Data end)

F7H

• Panel Data Contents

- | | |
|--------------------------------|-------------------------------|
| (1) 1'st Voice | (18) Split Dumper Mode |
| (2) Dual On/Off | (19) Reverb Type 1 |
| (3) Dual Voice | (20) Reverb Type 2 |
| (4) Dual Balance | (21) Reverb Depth 1 |
| (5) Dual Detune | (22) Reverb Depth 2 |
| (6) Dual Voice1 Octave | (23) Effect Type 1 |
| (7) Dual Voice2 Octave | (24) Effect Type 2 |
| (8) Dual Voice1 Effect Depth | (25) Effect Depth |
| (9) Dual Voice2 Effect Depth | (26) Variation On/Off |
| (10) Split On/Off | (27) Touch Sensitivity |
| (11) Split Voice | (28) Fixed Data |
| (12) Split Point | (29) Left Pedal |
| (13) Split Balance | (30) Soft Pedal Depth |
| (14) Split Voice1 Octave | (31) Absolute tempo low byte |
| (15) Split Voice2 Octave | (32) Absolute tempo high byte |
| (16) Split Voice1 Effect Depth | (33) Key-Off Sampling Depth |
| (17) Split Voice2 Effect Depth | |

- Panel data send requests cannot be received.

7. SYSTEM EXCLUSIVE MESSAGES

(Universal System Exclusive)

(1) Universal Realtime Message

Data format: [F0H] -> [7FH] -> [XnH] -> [04H] -> [01H] -> [lIH] -> [mmH] -> [F7H]

MIDI Master Volume

- Simultaneously changes the volume of all channels.
 - When a MIDI master volume message is received, the volume only has affect on the MIDI receive channel, not the panel master vol-ume.
 - F0H = Exclusive status
 - 7FH = Universal Realtime
 - 7FH = ID of target device
 - 04H = Sub-ID #1=Device Control Message
 - 01H = Sub-ID #2=Master Volume
 - lIH = Volume LSB
 - mmH = Volume MSB
 - F7H = End of Exclusive
- or**
- F0H = Exclusive status
 - 7FH = Universal Realtime
 - XnH = When n is received n=0~F, whichever is received.
X = don't care
 - 04H = Sub-ID #1=Device Control Message
 - 01H = Sub-ID #2=Master Volume
 - lIH = Volume LSB
 - mmH = Volume MSB
 - F7H = End of Exclusive

(2) Universal Non-Realtime Message (GM On)

General MIDI Mode On

Data format: [F0H] -> [7EH] -> [XnH] -> [09H] -> [01H] -> [F7H]

F0H = Exclusive status
 7EH = Universal Non-Realtime
 7FH = ID of target device
 09H = Sub-ID #1=General MIDI Message
 01H = Sub-ID #2=General MIDI On
 F7H = End of Exclusive

or

F0H = Exclusive status
 7EH = Universal Non-Realtime
 XnH = When received, n=0~F.
 X = don't care
 09H = Sub-ID #1=General MIDI Message
 01H = Sub-ID #2=General MIDI On
 F7H = End of Exclusive

When the General MIDI mode ON message is received, the MIDI system will be reset to its default settings.

This message requires approximately 50ms to execute, so sufficient time should be allowed before the next message is sent.

8. SYSTEM EXCLUSIVE MESSAGES (XG Standard)

(1) XG Native Parameter Change

Data format: [F0H] -> [43H] -> [1nH] -> [4CH] -> [hhH] -> [mmH] -> [//H] -> [ddH] -> [F7H]

F0H = Exclusive status
 43H = YAMAHA ID
 1nH = When received, n=0~F.
 When transmitted, n=0.
 4CH = Model ID of XG
 hhH = Address High
 mmH = Address Mid
 //H = Address Low
 ddH = Data

F7H = End of Exclusive

Data size must match parameter size (2 or 4 bytes).

When the XG System On message is received, the MIDI system will be reset to its default settings.

The message requires approximately 50ms to execute, so sufficient time should be allowed before the next message is sent.

(2) XG Native Bulk Data (reception only)

Data format: [F0H] -> [43H] -> [0nH] -> [4CH] -> [aaH] -> [bbH] -> [hhH] -> [mmH] -> [//H] -> [ddH] -> ...-> [ccH] -> [F7H]

F0H = Exclusive status
 43H = YAMAHA ID
 0nH = When received, n=0~F.
 When transmitted, n=0.
 4CH = Model ID of XG
 aaH = ByteCount
 bbH = ByteCount
 hhH = Address High
 mmH = Address Mid
 //H = Address Low
 ddH = Data

ccH = Check sum
 F7H = End of Exclusive

- Receipt of the XG SYSTEM ON message causes reinitialization of relevant parameters and Control Change values. Allow sufficient time for processing to execute (about 50 msec) before sending the CLP-F01 another message.
- XG Native Parameter Change message may contain two or four bytes of parameter data (depending on the parameter size).
- For information about the Address and Byte Count values, refer to Table 1 below. Note that the table's Total Size value gives the size of a bulk block. Only the top address of the block (00H, 00H, 00H) is valid as a bulk data address.

9. SYSTEM EXCLUSIVE MESSAGES (Clavinova MIDI Format)

Data format: [F0H] -> [43H] -> [73H] -> [xxH] -> [nnH] -> [F7H]

F0H = Exclusive status
 43H = Yamaha ID
 73H = Clavinova ID

01H = Product ID (CLP common)

or

7FH = Extended Product ID
 47H = Product ID

nnH = Substatus
 nn Control
 02H Internal MIDI clock
 03H External MIDI clock
 06H Bulk Data (the bulk data follows 06H)

F7H = End of Exclusive

* When nn=02H or 03H, CLP common ID (01H) is recognized as well as 7FH, 47H.

BULK DUMP FORMAT

F0H, 43H, 73H = Product ID
 7FH, 47H = Bulk ID
 06H = Sequence data
 05H = Data length
 0nH, 0nH, 0nH, 0nH = [BULK DATA]
 [CHECK SUM (1byte)] = 0-sum (BULK DATA)
 F7H = End of Exclusive

10. SYSTEM EXCLUSIVE MESSAGES (Special Control)

Data format: [F0H] -> [43H] -> [73H] -> [7FH] -> [47H] -> [11H] -> [0nH] -> [ccH] -> [vvH] -> [F7H]

F0H = Exclusive status
 43H = Yamaha ID
 73H = Clavinova ID
 7FH = Extended Product ID
 47H = Product ID
 11H = Special control
 0nH = Control MIDI change (n=channel number)
 cc = Control number
 vv = Value
 F7H = End of Exclusive

Control	0n	ccH	vvH
Split Point	Always 00H	14H	14H : Split Key Number
Metronome	Always 00H	1BH	00H : off 01H : - 02H : 2/4 03H : 3/4 04H : 4/4 05H : 5/4 06H : 6/4 07H : No accent
Damper Level	ch: 00H-0FH	3DH	(Sets the Damper Level for each channel) 00H-7FH
Channel Detune	ch: 00H-0FH	43H	(Sets the Detune value for each channel) 00H-7FH
Voice Reserve	ch: 00H-0FH	45H	00H : Reserve off 7FH : on*

* When Volume, Expression is received for Reserve On, they will be effective from the next Key On. Reserve Off is normal.

11. SYSTEM EXCLUSIVE MESSAGES (Others)

Data format: [F0H] -> [43H] -> [1nH] -> [27H] -> [30H] -> [00H] -> [00H] -> [mmH] -> [//H] -> [ccH] -> [F7H]

Master Tuning (XG and last message priority) simultaneously changes the pitch of all channels.

F0H = Exclusive Status
 43H = Yamaha ID
 1nH = When received, n=0~F.
 When transmitted, n=0.
 27H = Model ID of TG100
 30H = Sub ID
 00H =
 00H =
 mmH = Master Tune MSB
 //H = Master Tune LSB

ccH = don't care (under 7FH)
 F7H = End of Exclusive

<Table 1>

MIDI Parameter Change table (SYSTEM)

Address (H)	Size (H)	Data (H)	Parameter	Description	Default value (H)
00 00 00	4	020C - 05F4(*1)	MASTER TUNE	-50 - +50[cent]	00 04 00 00
01				1st bit 3 - 0 → bit 15 - 12	400
02				2nd bit 3 - 0 → bit 11 - 8	
03				3rd bit 3 - 0 → bit 7 - 4	
				4th bit 3 - 0 → bit 3 - 0	
04	1	00 - 7F	MASTER VOLUME	0 - 127	7F
05	1	—	—		
06	1	34 - 4C(*2)	TRANSCOPE	-12 - +12[semitones]	40
7E		00	XG SYSTEM ON	00=XG system ON	
7F		00	RESET ALL PARAMETERS	00=ON (receive only)	

TOTAL SIZE 07

*1: Values lower than 020CH select -50 cents. Values higher than 05F4H select +50 cents.

*2: Values from 28H through 33H are interpreted as -12 through -1. Values from 4DH through 58H are interpreted as +1 through +12.

<Table 2>

MIDI Parameter Change table (EFFECT 1)

Refer to the "Effect MIDI Map" for a complete list of Reverb, Chorus and Variation type numbers.

Address (H)	Size (H)	Data (H)	Parameter	Description	Default value (H)
02 01 00	2	00-7F	REVERB TYPE MSB	Refer to Effect MIDI Map	01(=HALL1)
		00-7F	REVERB TYPE LSB	00 : basic type	00
02 01 40	2	00-7F	VARIATION TYPE MSB	Refer to Effect MIDI Map	00(=Effect off)
		00-7F	VARIATION TYPE LSB	00 : basic type	00

• "VARIATION" refers to the EFFECT on the panel.

<Table 3>

MIDI Parameter Change table (MULTI PART)

Address (H)	Size (H)	Data (H)	Parameter	Description	Default value (H)
08 nn 11	1	00 - 7F	DRY LEVEL	0 - 127	7F

nn = Part Number

• **Effect MIDI Map**

REVERB

	MSB	LSB
ROOM	02H	10H
HALL 1	01H	10H
HALL 2	01H	11H
STAGE	03H	10H
Sound board	03H	12H

EFFECT

	MSB	LSB
CHORUS	42H	10H
PHASER	48H	10H
TREMOLO	46H	10H
DELAY	05H	10H

Function...	Transmitted	Recognized	Remarks
Basic Channel Default Changed	1 1 - 16	1 1 - 16	
Mode Default Messages Altered	3 X *****	1 X X	*1 Poly Mode only
Note Number : True voice	9 - 120 *****	0 - 127 0 - 127	
Velocity Note ON Note OFF	O 9nH, v=1-127 X 9nH, v=0	O 9nH, v=1-127 X 9nH, v=0 or 8nH	
After Touch Key's Ch's	X X	X X	
Pitch Bend	X	X	
Control Change 0,32 7 11 64 66 67 91 94	O O O O O O O O	O O O O O O O O	Bank Select Volume Expression Damper Sostenuto Soft pedal Reverb Depth Effect Depth
Prog Change : True #	O *****	O	
System Exclusive	O	O	
Common : Song Pos. : Song Sel. : Tune	X X X	X X X	
System : Clock Real Time : Commands	O O	O O	
Aux : All Sound Off : Reset All Cntrls : Local ON/OFF Mes- : All Notes OFF sages: Active Sense : Reset	O O X O O X	O (120,126,127) O (121) O (122) O (123-125) O X	

Notes: *1= Recieve Mode is always multi timbre and Poly mode.

Specifications / Technische Daten / Caractéristiques techniques / Especificaciones

Keyboard	Newly wooden keyboard
Sound Source	AWM Dynamic Stereo Sampling
Polyphony	64 Notes Max.
Voice Selection	14 × 2 variations for each voice
Effect	Reverb, Effect, Brilliance
Volume	Master Volume
Controls	Dual, Split, Metronome, Transpose, Touch (Hard/Medium/Soft/Fixed), Functions, Speaker ON/OFF
Recording/Playback	2-track recording/playback (3 user songs), Tempo Adjustment, Synchro Start
Pedal	Damper (apply a half pedal), Sostenuto, Soft
Demo Songs	14 voice Demo Songs, 50 preset Songs
Jacks/Connectors	MIDI (IN/OUT/THRU), PHONES × 2, AUX IN, AUX OUT(L/L+R,R), AUX OUT (LEVEL FIXED)(L,R), TO HOST
Main Amplifiers	40W × 2
Speakers	16cm × 2, 5cm × 2
Dimensions (W × D × H)	1427mm × 400mm × 995mm [56-3/16" × 15-3/4" × 39-3/16"]
Weight	71kg (156lbs., 8oz)
Accessories	Owner's Manual, "50 greats for the Piano" (Music Book), Bench (included or optional depending on locale)

- * Specifications and descriptions in this owner's manual are for information purposes only. Yamaha Corp. reserves the right to change or modify products or specifications at any time without prior notice. Since specifications, equipment or options may not be the same in every locale, please check with your Yamaha dealer.
- * Die technischen Daten und Beschreibungen in dieser Bedienungsanleitung dienen nur der Information. Yamaha Corp. behält sich das Recht vor, Produkte oder deren technische Daten jederzeit ohne vorherige Ankündigung zu verändern oder zu modifizieren. Da die technischen Daten, das Gerät selbst oder Sonderzubehör nicht in jedem Land gleich sind, setzen Sie sich im Zweifel bitte mit Ihrem Yamaha-Händler in Verbindung.
- * Les caractéristiques techniques et les descriptions du mode d'emploi ne sont données que pour information. Yamaha Corp. se réserve le droit de changer ou modifier les produits et leurs caractéristiques techniques à tout moment sans aucun avis. Du fait que les caractéristiques techniques, les équipements et les options peuvent différer d'un pays à l'autre, adressez-vous au distributeur Yamaha le plus proche.
- * Las especificaciones y descripciones de este manual del propietario tienen sólo el propósito de servir como información. Yamaha Corp. se reserva el derecho a efectuar cambios o modificaciones en los productos o especificaciones en cualquier momento sin previo aviso. Puesto que las especificaciones, equipos u opciones pueden no ser las mismas en todos los mercados, solicite información a su distribuidor Yamaha.

MEMO

MEMO

IMPORTANT SAFETY INSTRUCTIONS

INFORMATION RELATING TO PERSONAL INJURY, ELECTRICAL SHOCK, AND FIRE HAZARD POSSIBILITIES HAS BEEN INCLUDED IN THIS LIST.

WARNING- When using any electrical or electronic product, basic precautions should always be followed. These precautions include, but are not limited to, the following:

- 1.** Read all Safety Instructions, Installation Instructions, Special Message Section items, and any Assembly Instructions found in this manual **BEFORE** making any connections, including connection to the main supply.
- 2.** Main Power Supply Verification: Yamaha products are manufactured specifically for the supply voltage in the area where they are to be sold. If you should move, or if any doubt exists about the supply voltage in your area, please contact your dealer for supply voltage verification and (if applicable) instructions. The required supply voltage is printed on the name plate. For name plate location, please refer to the graphic found in the Special Message Section of this manual.
- 3.** This product may be equipped with a polarized plug (one blade wider than the other). If you are unable to insert the plug into the outlet, turn the plug over and try again. If the problem persists, contact an electrician to have the obsolete outlet replaced. Do **NOT** defeat the safety purpose of the plug.
- 4.** Some electronic products utilize external power supplies or adapters. Do **NOT** connect this type of product to any power supply or adapter other than one described in the owners manual, on the name plate, or specifically recommended by Yamaha.
- 5.** **WARNING:** Do not place this product or any other objects on the power cord or place it in a position where anyone could walk on, trip over, or roll anything over power or connecting cords of any kind. The use of an extension cord is not recommended! If you must use an extension cord, the minimum wire size for a 25' cord (or less) is 18 AWG. **NOTE:** The smaller the AWG number, the larger the current handling capacity. For longer extension cords, consult a local electrician.
- 6.** Ventilation: Electronic products, unless specifically designed for enclosed installations, should be placed in locations that do not interfere with proper ventilation. If instructions for enclosed installations are not provided, it must be assumed that unobstructed ventilation is required.
- 7.** Temperature considerations: Electronic products should be installed in locations that do not significantly contribute to their operating temperature. Placement of this product close to heat sources such as; radiators, heat registers and other devices that produce heat should be avoided.
- 8.** This product was **NOT** designed for use in wet/damp locations and should not be used near water or exposed to rain. Examples of wet/damp locations are; near a swimming pool, spa, tub, sink, or wet basement.
- 9.** This product should be used only with the components supplied or; a cart, rack, or stand that is recommended by the manufacturer. If a cart, rack, or stand is used, please observe all safety markings and instructions that accompany the accessory product.
- 10.** The power supply cord (plug) should be disconnected from the outlet when electronic products are to be left unused for extended periods of time. Cords should also be disconnected when there is a high probability of lightning and/or electrical storm activity.
- 11.** Care should be taken that objects do not fall and liquids are not spilled into the enclosure through any openings that may exist.
- 12.** Electrical/electronic products should be serviced by a qualified service person when:
 - a. The power supply cord has been damaged; or
 - b. Objects have fallen, been inserted, or liquids have been spilled into the enclosure through openings; or
 - c. The product has been exposed to rain; or
 - d. The product does not operate, exhibits a marked change in performance; or
 - e. The product has been dropped, or the enclosure of the product has been damaged.
- 13.** Do not attempt to service this product beyond that described in the user-maintenance instructions. All other servicing should be referred to qualified service personnel.
- 14.** This product, either alone or in combination with an amplifier and headphones or speaker/s, may be capable of producing sound levels that could cause permanent hearing loss. **DO NOT** operate for a long period of time at a high volume level or at a level that is uncomfortable. If you experience any hearing loss or ringing in the ears, you should consult an audiologist. **IMPORTANT:** The louder the sound, the shorter the time period before damage occurs.
- 15.** Some Yamaha products may have benches and/or accessory mounting fixtures that are either supplied as a part of the product or as optional accessories. Some of these items are designed to be dealer assembled or installed. Please make sure that benches are stable and any optional fixtures (where applicable) are well secured **BEFORE** using. Benches supplied by Yamaha are designed for seating only. No other uses are recommended.

PLEASE KEEP THIS MANUAL

FCC INFORMATION (U.S.A.)

1. IMPORTANT NOTICE: DO NOT MODIFY THIS UNIT!

This product, when installed as indicated in the instructions contained in this manual, meets FCC requirements. Modifications not expressly approved by Yamaha may void your authority, granted by the FCC, to use the product.

2. **IMPORTANT:** When connecting this product to accessories and/or another product use only high quality shielded cables. Cable/s supplied with this product **MUST** be used. Follow all installation instructions. Failure to follow instructions could void your FCC authorization to use this product in the USA.
3. **NOTE:** This product has been tested and found to comply with the requirements listed in FCC Regulations, Part 15 for Class "B" digital devices. Compliance with these requirements provides a reasonable level of assurance that your use of this product in a residential environment will not result in harmful interference with other electronic devices. This equipment generates/uses radio frequencies and, if not installed and used according to the instructions found in the users manual, may cause interference harmful to the operation of

other electronic devices. Compliance with FCC regulations does not guarantee that interference will not occur in all installations. If this product is found to be the source of interference, which can be determined by turning the unit "OFF" and "ON", please try to eliminate the problem by using one of the following measures:

Relocate either this product or the device that is being affected by the interference.

Utilize power outlets that are on different branch (circuit breaker or fuse) circuits or install AC line filter/s.

In the case of radio or TV interference, relocate/reorient the antenna. If the antenna lead-in is 300 ohm ribbon lead, change the lead-in to co-axial type cable.

If these corrective measures do not produce satisfactory results, please contact the local retailer authorized to distribute this type of product. If you can not locate the appropriate retailer, please contact Yamaha Corporation of America, Electronic Service Division, 6600 Orangethorpe Ave, Buena Park, CA90620

The above statements apply **ONLY** to those products distributed by Yamaha Corporation of America or its subsidiaries.

* This applies only to products distributed by YAMAHA CORPORATION OF AMERICA.

(class B)

IMPORTANT NOTICE FOR THE UNITED KINGDOM

Connecting the Plug and Cord

IMPORTANT. The wires in this mains lead are coloured in accordance with the following code:

BLUE : NEUTRAL

BROWN : LIVE

As the colours of the wires in the mains lead of this apparatus may not correspond with the coloured markings identifying the terminals in your plug proceed as follows:

The wire which is coloured BLUE must be connected to the terminal which is marked with the letter N or coloured BLACK.

The wire which is coloured BROWN must be connected to the terminal which is marked with the letter L or coloured RED.

Making sure that neither core is connected to the earth terminal of the three pin plug.

(2 wires)

- This applies only to products distributed by Yamaha-Kemble Music (U.K.) Ltd.

CAUTION: TO PREVENT ELECTRIC SHOCK, MATCH WIDE BLADE OF PLUG TO WIDE SLOT, FULLY INSERT.

ATTENTION: POUR ÉVITER LES CHOCS ÉLECTRIQUES, INTRODUIRE LA LAME LA PLUS LARGE DE LA FICHE DANS LA BORNE CORRESPONDANTE DE LA PRISE ET POUSSER JUSQU'AU FOND.

(polarity)

- This applies only to products distributed by Yamaha Canada Music Ltd.
- Ceci ne s'applique qu'aux produits distribués par Yamaha Canada Musique Ltée.

For details of products, please contact your nearest Yamaha representative or the authorized distributor listed below.

Pour plus de détails sur les produits, veuillez-vous adresser à Yamaha ou au distributeur le plus proche de vous figurant dans la liste suivante.

Die Einzelheiten zu Produkten sind bei Ihrer unten aufgeführten Niederlassung und bei Yamaha Vertragshändlern in den jeweiligen Bestimmungsländern erhältlich.

Para detalles sobre productos, contacte su tienda Yamaha más cercana o el distribuidor autorizado que se lista debajo.

NORTH AMERICA

CANADA

Yamaha Canada Music Ltd.
135 Milner Avenue, Scarborough, Ontario,
M1S 3R1, Canada
Tel: 416-298-1311

U.S.A.

Yamaha Corporation of America
6600 Orangethorpe Ave., Buena Park, Calif. 90620,
U.S.A.
Tel: 714-522-9011

CENTRAL & SOUTH AMERICA

MEXICO

Yamaha de México S.A. de C.V.
Calz. Javier Rojo Gómez #1149,
Col. Guadalupe del Moral
C.P. 09300, México, D.F., México
Tel: 55-5804-0600

BRAZIL

Yamaha Musical do Brasil Ltda.
Av. Reboucas 2636-Pinheiros CEP: 05402-400
Sao Paulo-SP. Brasil
Tel: 011-3085-1377

ARGENTINA

Yamaha Music Latin America, S.A.
Sucursal de Argentina
Viamonte 1145 Piso 2-B 1053,
Buenos Aires, Argentina
Tel: 1-4371-7021

PANAMA AND OTHER LATIN AMERICAN COUNTRIES/ CARIBBEAN COUNTRIES

Yamaha Music Latin America, S.A.
Torre Banco General, Piso 7, Urbanización Marbella,
Calle 47 y Aquilino de la Guardia,
Ciudad de Panamá, Panamá
Tel: +507-269-5311

EUROPE

THE UNITED KINGDOM

Yamaha-Kemble Music (U.K.) Ltd.
Sherbourne Drive, Tilbrook, Milton Keynes,
MK7 8BL, England
Tel: 01908-366700

IRELAND

Danfay Ltd.
61D, Sallynoggin Road, Dun Laoghaire, Co. Dublin
Tel: 01-2859177

GERMANY

Yamaha Music Central Europe GmbH
Siemensstraße 22-34, 25462 Rellingen, Germany
Tel: 04101-3030

SWITZERLAND/LIECHTENSTEIN

Yamaha Music Central Europe GmbH,
Branch Switzerland
Seefeldstrasse 94, 8008 Zürich, Switzerland
Tel: 01-383 3990

AUSTRIA

Yamaha Music Central Europe GmbH,
Branch Austria
Schleiergasse 20, A-1100 Wien, Austria
Tel: 01-60203900

THE NETHERLANDS

Yamaha Music Central Europe,
Branch Nederland
Clarissenhof 5-b, 4133 AB Vianen, The Netherlands
Tel: 0347-358 040

BELGIUM/LUXEMBOURG

Yamaha Music Central Europe GmbH,
Branch Belgium
Rue de Geneve (Genevastraat) 10, 1140 - Brussels,
Belgium
Tel: 02-726 6032

FRANCE

Yamaha Musique France
BP 70-77312 Marne-la-Vallée Cedex 2, France
Tel: 01-64-61-4000

ITALY

Yamaha Musica Italia S.P.A.
Viale Italia 88, 20020 Lainate (Milano), Italy
Tel: 02-935-771

SPAIN/PORTUGAL

Yamaha-Hazen Música, S.A.
Ctra. de la Coruna km. 17, 200, 28230
Las Rozas (Madrid), Spain
Tel: 91-639-8888

GREECE

Philippos Nakas S.A. The Music House
147 Skiathou Street, 112-55 Athens, Greece
Tel: 01-228 2160

SWEDEN

Yamaha Scandinavia AB
J. A. Wettergrens Gata 1
Box 30053
S-400 43 Göteborg, Sweden
Tel: 031 89 34 00

DENMARK

YS Copenhagen Liaison Office
Generatorvej 6A
DK-2730 Herlev, Denmark
Tel: 44 92 49 00

FINLAND

F-Musiikki Oy
Kluuvikatu 6, P.O. Box 260,
SF-00101 Helsinki, Finland
Tel: 09 618511

NORWAY

Norsk filial av Yamaha Scandinavia AB
Grini Næringspark 1
N-1345 Østerås, Norway
Tel: 67 16 77 70

ICELAND

Skifan HF
Skeifan 17 P.O. Box 8120
IS-128 Reykjavik, Iceland
Tel: 525 5000

OTHER EUROPEAN COUNTRIES

Yamaha Music Central Europe GmbH
Siemensstraße 22-34, 25462 Rellingen, Germany
Tel: +49-4101-3030

AFRICA

Yamaha Corporation,
Asia-Pacific Music Marketing Group
Nakazawa-cho 10-1, Hamamatsu, Japan 430-8650
Tel: +81-53-460-2312

MIDDLE EAST

TURKEY/CYPRUS

Yamaha Music Central Europe GmbH
Siemensstraße 22-34, 25462 Rellingen, Germany
Tel: 04101-3030

OTHER COUNTRIES

Yamaha Music Gulf FZE
LB21-128 Jebel Ali Freezone
P.O.Box 17328, Dubai, U.A.E.
Tel: +971-4-881-5868

ASIA

THE PEOPLE'S REPUBLIC OF CHINA

Yamaha Music & Electronics (China) Co., Ltd.
25/F., United Plaza, 1468 Nanjing Road (West),
Jingan, Shanghai, China
Tel: 021-6247-2211

HONG KONG

Tom Lee Music Co., Ltd.
11/F., Silvercord Tower 1, 30 Canton Road,
Tsimshatsui, Kowloon, Hong Kong
Tel: 2737-7688

INDONESIA

PT. Yamaha Music Indonesia (Distributor)
PT. Nusantik
Gedung Yamaha Music Center, Jalan Jend. Gatot
Subroto Kav. 4, Jakarta 12930, Indonesia
Tel: 21-520-2577

KOREA

Yamaha Music Korea Ltd.
Tong-Yang Securities Bldg. 16F 23-8 Yoido-dong,
Yongdungpo-ku, Seoul, Korea
Tel: 02-3770-0660

MALAYSIA

Yamaha Music Malaysia, Sdn., Bhd.
Lot 8, Jalan Perbandaran, 47301 Kelana Jaya,
Petaling Jaya, Selangor, Malaysia
Tel: 3-78030900

PHILIPPINES

Yupangco Music Corporation
339 Gil J. Puyat Avenue, P.O. Box 885 MCPO,
Makati, Metro Manila, Philippines
Tel: 819-7551

SINGAPORE

Yamaha Music Asia Pte., Ltd.
#03-11 A-Z Building
140 Paya Lebar Road, Singapore 409015
Tel: 747-4374

TAIWAN

Yamaha KHS Music Co., Ltd.
3F, #6, Sec.2, Nan Jing E. Rd. Taipei.
Taiwan 104, R.O.C.
Tel: 02-2511-8688

THAILAND

Siam Music Yamaha Co., Ltd.
891/1 Siam Motors Building, 15-16 floor
Rama 1 road, Wangmai, Pathumwan
Bangkok 10330, Thailand
Tel: 02-215-2626

OTHER ASIAN COUNTRIES

Yamaha Corporation,
Asia-Pacific Music Marketing Group
Nakazawa-cho 10-1, Hamamatsu, Japan 430-8650
Tel: +81-53-460-2317

OCEANIA

AUSTRALIA

Yamaha Music Australia Pty. Ltd.
Level 1, 99 Queensbridge Street, Southbank,
Victoria 3006, Australia
Tel: 3-9693-5111

NEW ZEALAND

Music Houses of N.Z. Ltd.
146/148 Captain Springs Road, Te Papapa,
Auckland, New Zealand
Tel: 9-634-0099

COUNTRIES AND TRUST TERRITORIES IN PACIFIC OCEAN

Yamaha Corporation,
Asia-Pacific Music Marketing Group
Nakazawa-cho 10-1, Hamamatsu, Japan 430-8650
Tel: +81-53-460-2312



Clavinova Web site (English only)
<http://www.yamahaclavinova.com/>

Yamaha Manual Library
<http://www2.yamaha.co.jp/manual/english/>