



DIGITAL MIXING SYSTEM

# RIVAGE

PM SERIES

## Network Setup Guide

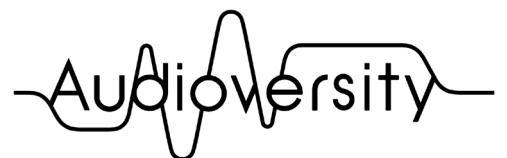

by Yamaha Pro Audio

## Table of Contents

1.	About the RIVAGE PM Network Setup Guide .....	3
2.	Control Network Setup (RIVAGE PM Editor/RIVAGE PM StageMix/MonitorMix).....	3
2.1.	Connecting to the NETWORK [PC] Connector.....	4
2.2.	Configuring the NETWORK [PC] Connector for PM Editor /StageMix/MonitorMix.....	5
2.3.	Communication Quality setting.....	9
2.4.	Connection Examples .....	10
3.	Dante Network Settings .....	16
	What is Dante?.....	16
3.1.	Connecting a Device to the Dante Connector .....	16
3.2.	Configuring HY144-D/-SRC .....	18
3.3.	Connection Examples .....	22
4.	FAQ.....	29

# 1. About the RIVAGE PM Network Setup Guide

This guide explains how to set up Control and Dante networks for the RIVAGE PM system. As the RIVAGE PM system can have multiple configurations, follow this guide to ensure the system is set up properly.

## 2. Control Network Setup (RIVAGE PM Editor/RIVAGE PM StageMix/MonitorMix)

The RIVAGE PM can be controlled from the RIVAGE PM Editor (PM Editor), RIVAGE PM StageMix (StageMix), MonitorMix, ProVisionaire Control, ProVisionaire Touch, and OSC controller via a connected computer through the NETWORK [PC] connector port designated below. Also, Immersive processors that RIVAGE PM supports can be controlled from the console through the NETWORK [PC] connector. Follow this procedure to set up the connection.

### Each component's NETWORK [PC] connectors

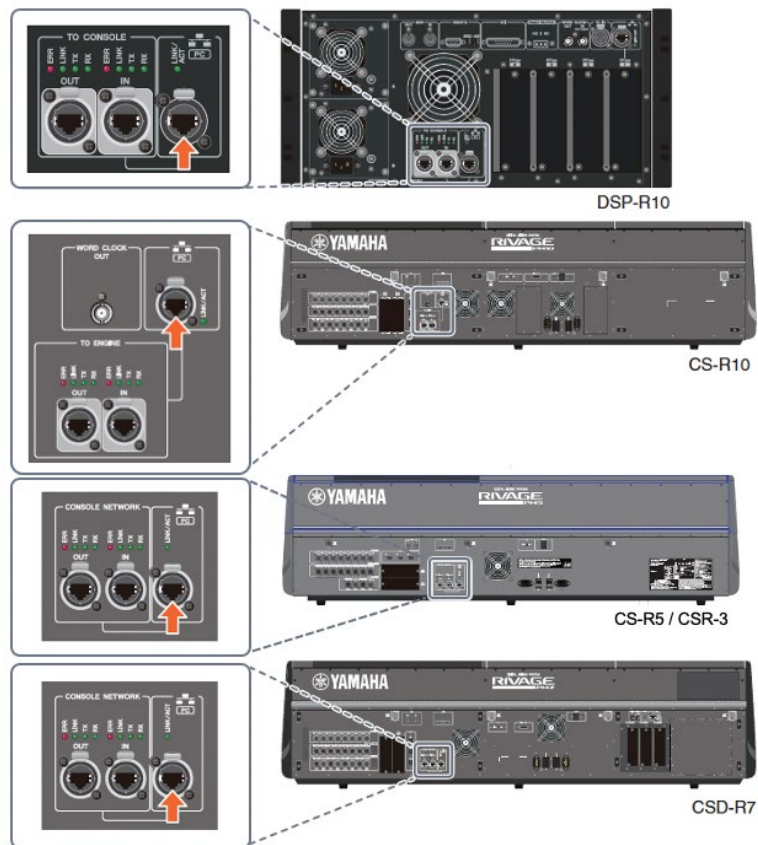

## 2.1. Connecting to the NETWORK [PC] Connector

Use an Ethernet cable (CAT5e or higher) to connect a computer or an access point to the NETWORK [PC] connector. The following devices can be connected to the NETWORK [PC] connector.

- A computer running PM Editor
- A Wi-Fi access point for connecting StageMix/MonitorMix/ProVisionaire Touch
- A computer running ProVisionaire Control
- A device that controls RIVAGE PM via OSC
- A supported immersive processor and controller

Connect only the above devices and a network switch for connection. Do not connect any other devices and networks.



Do not connect the Network [PC] ports between the console and the DSP engine, between the two consoles in Dual Console mode, or between the two DSP engines in the DSP Mirroring state.

If there is more than one RIVAGE PM system, do not connect the NETWORK [PC] connector of the RIVAGE PM systems to the same network. Or do not share one access point with multiple RIVAGE PM systems.

## 2.2. Configuring the NETWORK [PC] Connector for PM Editor/StageMix/MonitorMix

Apply the appropriate settings to the NETWORK [PC] connector to use PM Editor, StageMix, and MonitorMix.

### RIVAGE PM Editor

PM Editor does not require any specific settings between the NETWORK [PC] connector of the RIVAGE PM DSP engine and the control surface.

Simply set the computer's IP address within the following range to connect it with the installed PM Editor.

IP Address	192.168.53.1 – 192.168.53.32
Subnet Mask	255.255.255.0

### RIVAGE PM StageMix

The IP settings for StageMix can be made in the CONSOLE IP SETTING field.

1. Press the **SETUP** button on the menu bar to access the **SETUP** screen, and then press the **NETWORK** popup button.

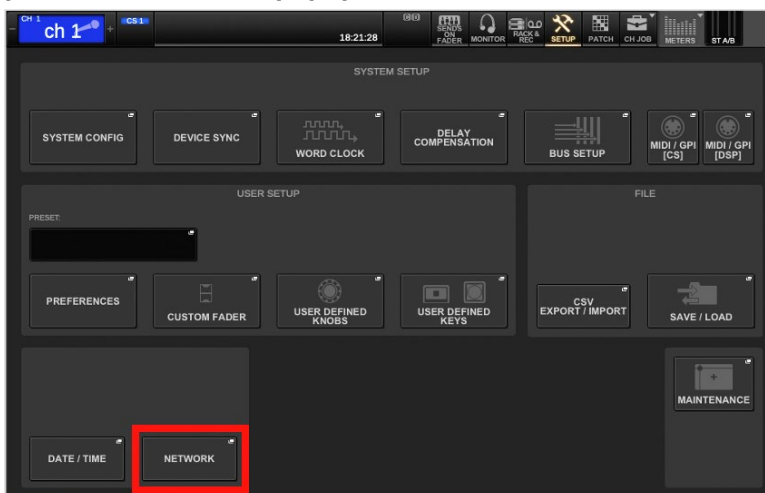

2. On the FOR MIXER CONTROL tab, press the IP ADDRESS button to open the CONSOLE IP SETTING screen. Then, specify an IP address and subnet mask.

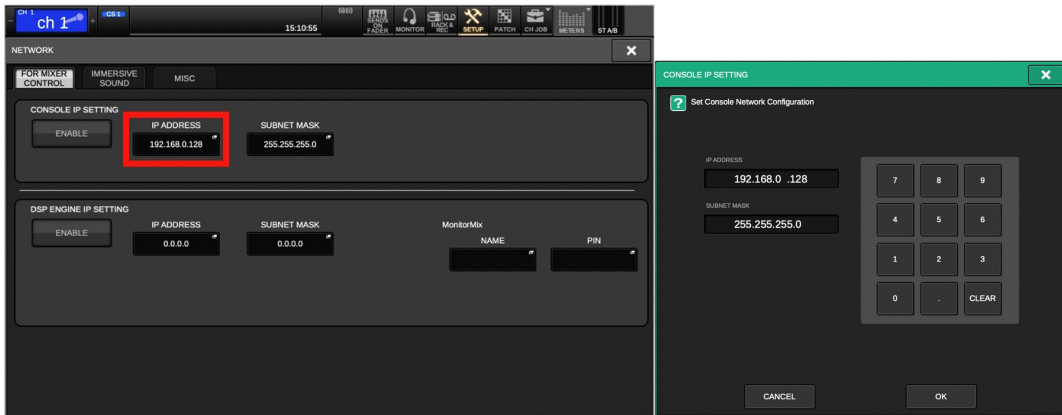

The following IP addresses cannot be used for CONSOLE IP SETTINGS.

- 192.168.53.xxx /24
- 172.17.xxx.xxx /16 - 172.26.xxx.xxx/16  
(These are reserved for RIVAGE PM systems.)
- 169.254.xxx.xxx /16 (Link-local addresses)
- Multicast addresses
- The IP address assigned to DSP ENGINE IP SETTING

3. Press the ENABLE button to turn it on.

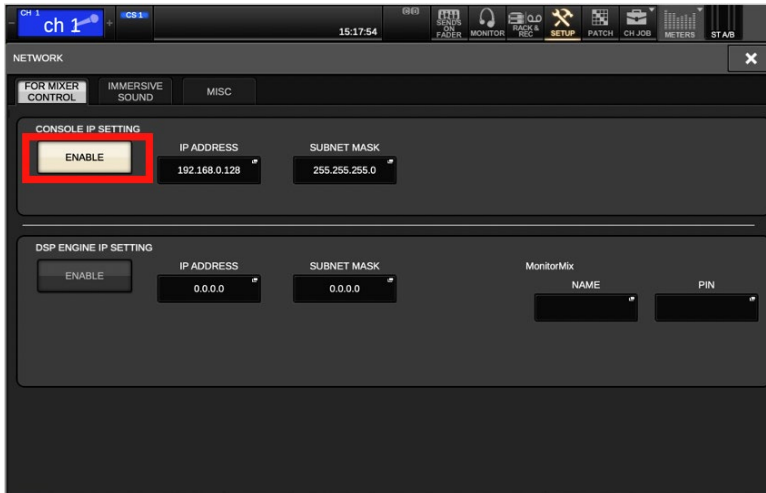

## MonitorMix/ProVisionaire Touch/ProVisionaire Control/OSC/Immersive

The IP settings for MonitorMix, ProVisionaire Touch, ProVisionaire Control, OSC, and Immersive can be made in the DSP ENGINE IP SETTING field.

1. Press the **SETUP** button on the menu bar to access the **SETUP** screen. Then, press the **NETWORK** popup button.

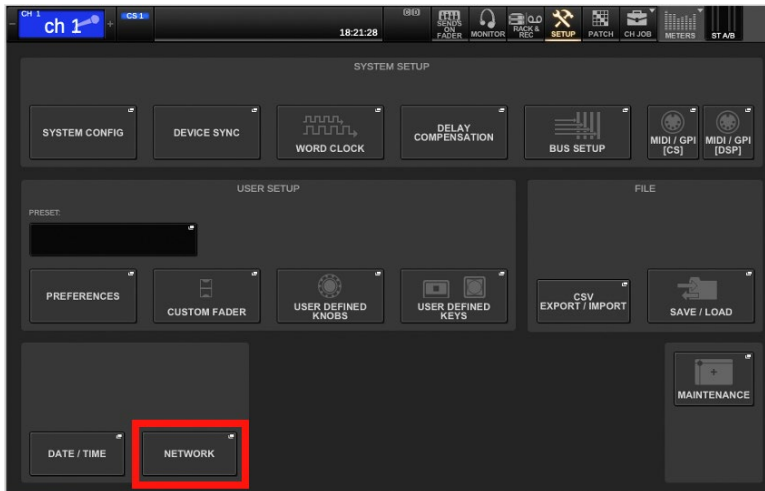

2. On the **FOR MIXER CONTROL** tab, press the **IP ADDRESS** button to open the **DSP ENGINE IP SETTING** screen. Then, specify an IP address and subnet mask.

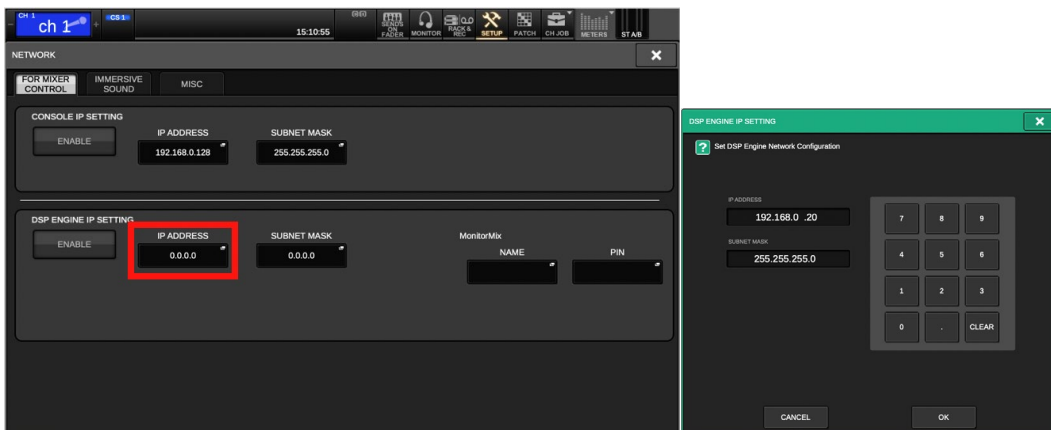

The following IP addresses cannot be used for DSP ENGINE IP SETTINGS.

- 192.168.53.xxx /24  
172.17.xxx.xxx /16 - 172.26.xxx.xxx/16  
(These are reserved for RIVAGE PM systems.)
- 169.254.xxx.xxx /16 (Link-local addresses)
- Multicast addresses
- IP address assigned to CONSOLE IP SETTINGS
- IP addresses in the same subnet as the HY144-D/-SRC's assigned Dante network

3. Press the **ENABLE** button in the **DSP ENGINE IP SETTING** field to turn it on.

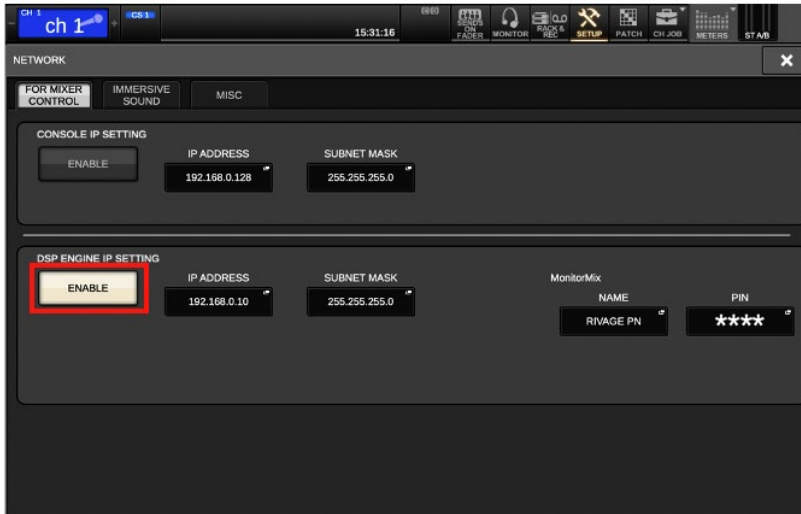

#### NOTICE

- Always apply the IP address to **CONSOLE IP SETTING** and **DSP ENGINE IP SETTING** before turning the **ENABLE** button **ON** for use with the StageMix or MonitorMix apps. Also, when you are not using the function, turn the **ENABLE** button off.



## 2.3. Communication Quality setting

Network communication can be stable by setting the COMMUNICATION QUALITY of the Network [PC] connector according to the control application used.

The COMMUNICATION QUALITY settings can be made in the MISC tab on the NETWORK window.

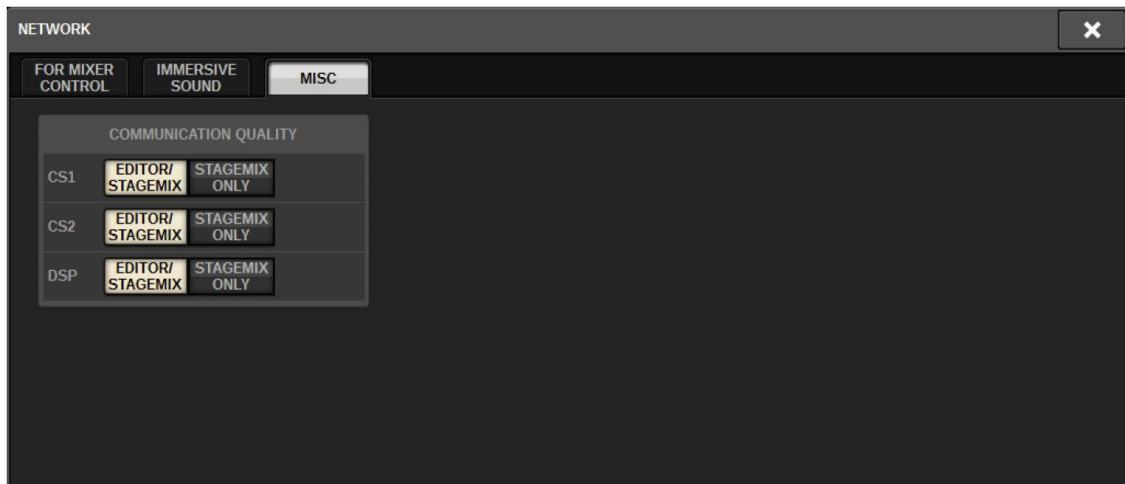

For a stable network communication, it is recommended that the PM Editor be connected separately from other devices. Select EDITOR/STAGEMIX for the port that connects PM Editor and STAGEMIX ONLY for the port that connects the StageMix.

Select either option for each connector on the console (two consoles when using the system in dual console mode) and the DSP engine.

### Note

- Selecting the STAGEMIX ONLY will lower the communication load.

## 2.4. Connection Examples

This section offers connection examples for RIVAGE PM systems using PM Editor / StageMix / MonitorMix, as well as precautions when connecting and setting up the system.

### Example 1: Connection with the RIVAGE PM Editor

A computer with PM Editor is connected to the NETWORK [PC] connector of a DSP engine or control surface using an Ethernet cable.

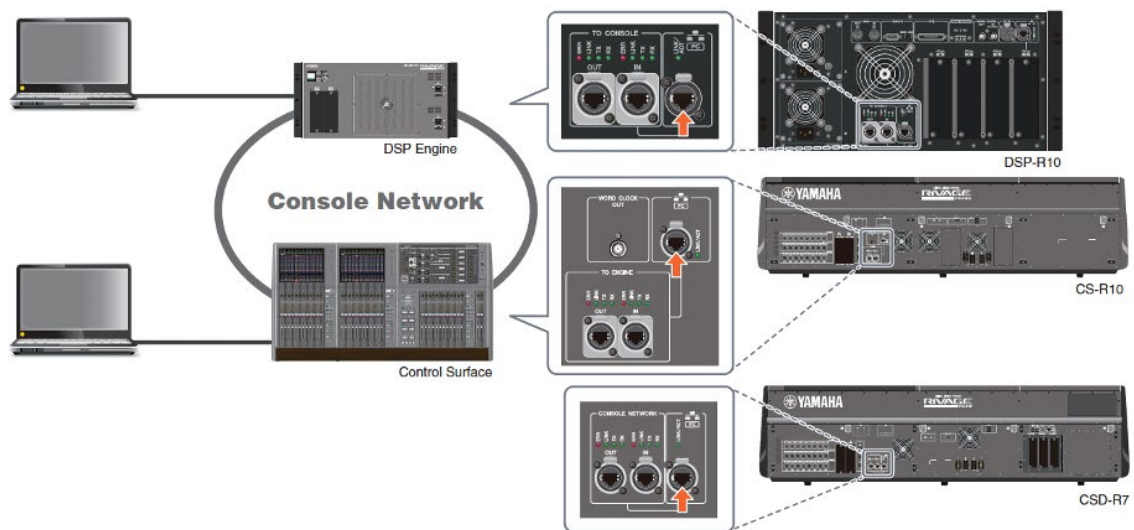

#### NOTE:

- Up to two PM Editors can be connected to one RIVAGE PM system.

## Example 2: Connection with StageMix

A Wi-Fi device (e.g., access point or router) for StageMix is connected to the NETWORK [PC] connector of a DSP engine or control surface using an Ethernet cable.

Make sure that the Ethernet cable is connected to the LAN port of the Wi-Fi device.

Please note that StageMix is only operable while the control surface is turned on.

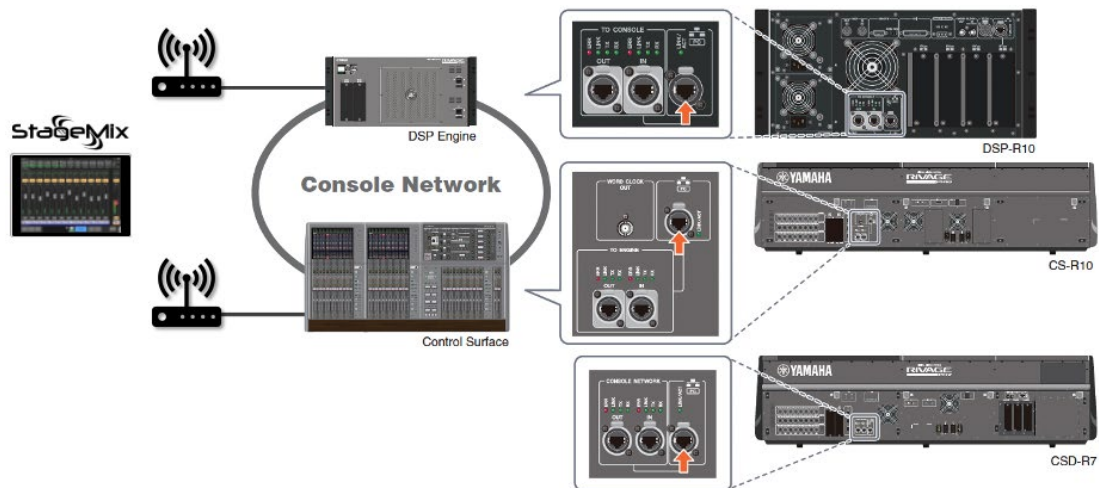

1. Open the NETWORK screen of the RIVAGE PM system to specify the IP address and subnet mask in the CONSOLE IP SETTING.
2. Press the ENABLE button in the CONSOLE IP SETTING field to turn it on.



Do not share a Wi-Fi access point with more than one RIVAGE PM system by connecting their NETWORK [PC] connectors to the access point.

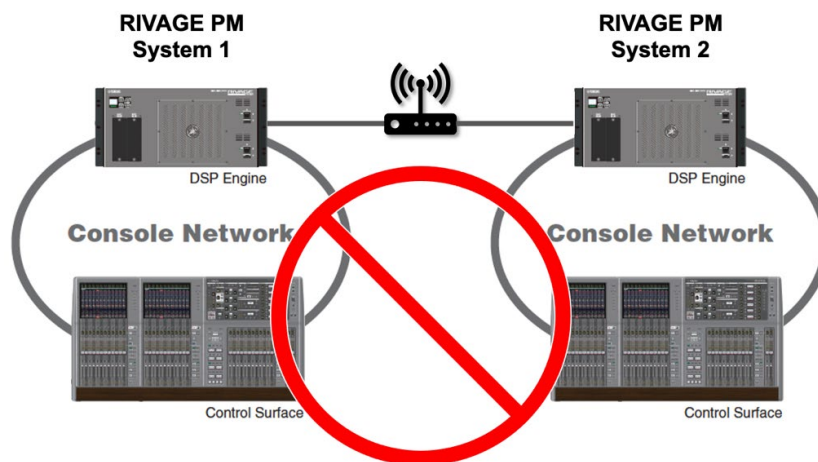

### NOTE:

- Up to two StageMix apps can be connected to one console surface.

### Example 3: Connection with MonitorMix

A Wi-Fi device (e.g., access point or router) for MonitorMix is connected to the NETWORK [PC] connector of a DSP engine or control surface using an Ethernet cable.

Make sure that the Ethernet cable is connected to the LAN port of the Wi-Fi device.

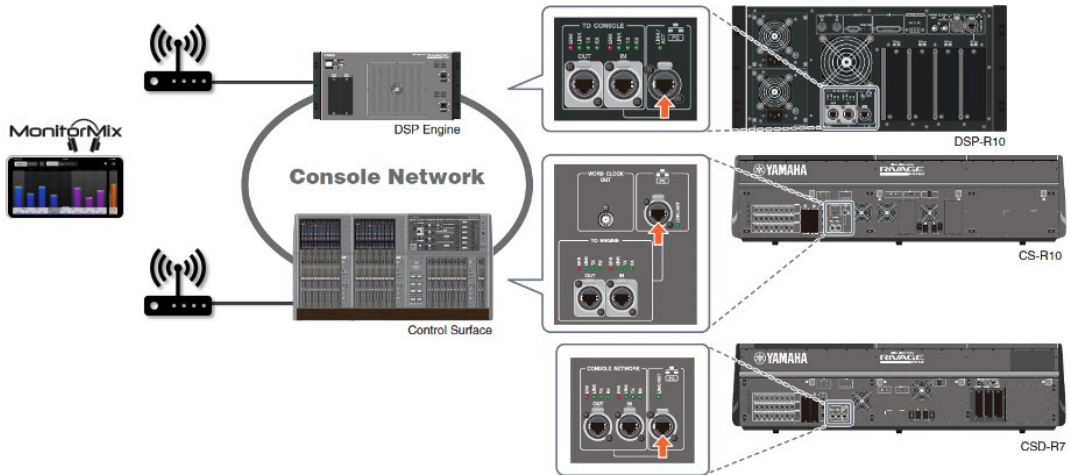

1. Open the NETWORK screen of the RIVAGE PM system and specify the IP address and subnet mask for the DSP ENGINE IP SETTING.
2. Press the ENABLE button in the DSP ENGINE IP SETTING field to turn it on.



Do not share a Wi-Fi access point with more than one RIVAGE PM system by connecting their NETWORK [PC] connectors to the access point.

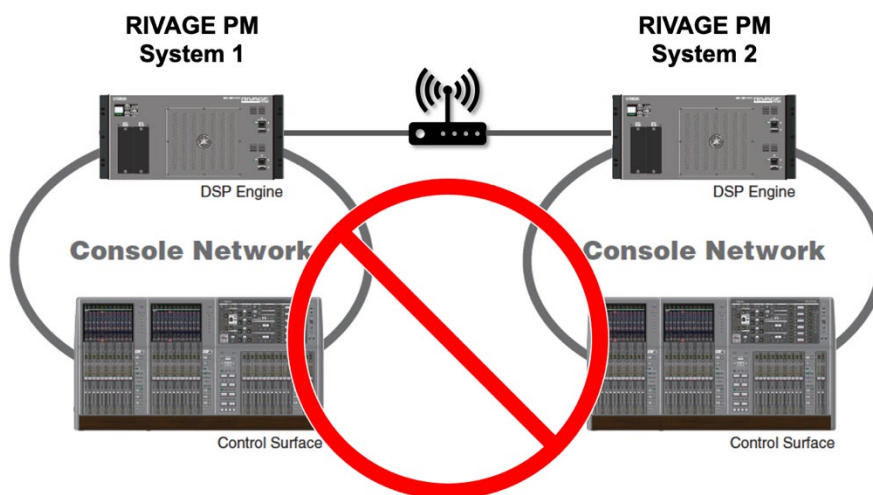

**NOTE:**

- Up to ten MonitorMix apps can be connected to one RIVAGE PM system.

#### Example 4: Connection with StageMix and MonitorMix in one system

A Wi-Fi device (e.g., access point or router) for StageMix and MonitorMix is connected to the NETWORK [PC] connector of a DSP engine or control surface using an Ethernet cable.

Make sure that the Ethernet cable is connected to the LAN port of the Wi-Fi device.

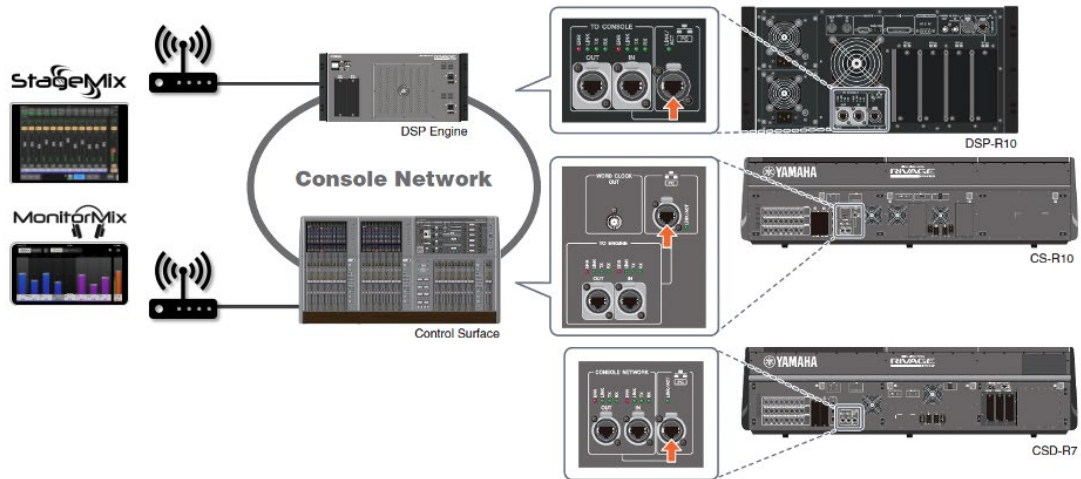

StageMix and MonitorMix can be used together by connecting them to the same access point or two different access points.

1. **Open the NETWORK screen of the RIVAGE PM system and specify the IP addresses and subnet masks for both the CONSOLE IP SETTING and DSP ENGINE IP SETTING.**  
See below to set these settings properly.

**When sharing one Wi-Fi access point:**

Specify a unique IP address in the same subnet for both the CONSOLE IP SETTING and the DSP ENGINE IP SETTING.

- Example of IP settings

	IP Address	Subnet Mask
CONSOLE IP	192.168.0.10	255.255.255.0
StageMix	192.168.0.xxx	255.255.255.0
DSP ENGINE IP	192.168.0.20	255.255.255.0
MonitorMix	192.168.0.xxx	255.255.255.0
Wi-Fi Access Point	192.168.0.1	255.255.255.0

**When using two separate Wi-Fi access points in different subnets:**

Specify an IP address in a different subnet (network address) for both the CONSOLE IP SETTING and the DSP ENGINE IP SETTING.

- Example of IP settings

	IP Address	Subnet Mask
CONSOLE IP	192.168.0.10	255.255.255.0
StageMix	192.168.0.xxx	255.255.255.0
Wi-Fi Access Point for StageMix	192.168.0.1	255.255.255.0
DSP ENGINE IP	192.168.1.10	255.255.255.0
MonitorMix	192.168.1.xxx	255.255.255.0
Wi-Fi Access Point for MonitorMix	192.168.1.1	255.255.255.0

2. Press the **ENABLE** buttons of the **CONSOLE IP SETTING** and **DSP ENGINE IP SETTING** to turn them on.



Do not share a Wi-Fi access point with more than one RIVAGE PM system by connecting their **NETWORK [PC]** connectors to the access point.

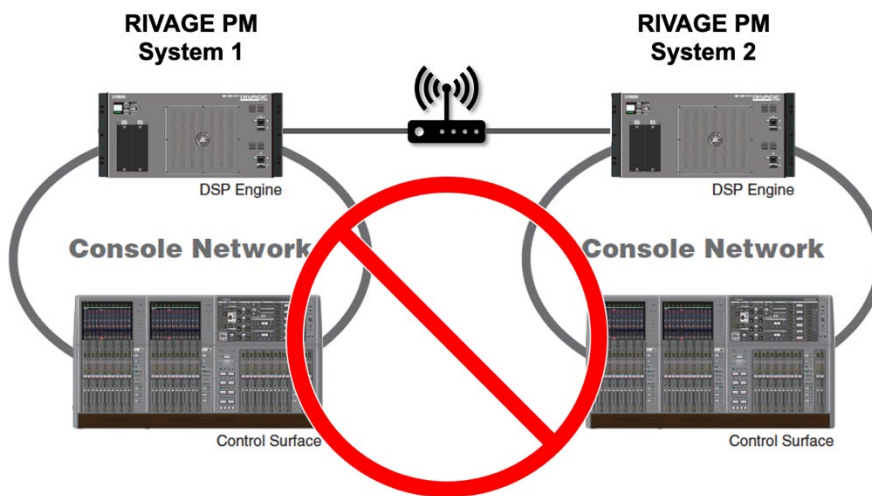

## **3. Dante Network Settings**

By installing an HY144-D/-SRC, a Dante device can be used as a RIVAGE PM system component. Up to 24 units can be mounted to a single HY144-D/-SRC and up to 48 units can be controlled for a single DSP engine. In addition, the maximum number of channels that can be controlled per mounted device is 128.

### **What is Dante?**

Dante is a network audio protocol developed by Audinate. It allows the management of device control signals and multiple audio signals at different sampling frequencies and bit rates in a network that supports Gigabit Ethernet.

For details about Dante, see the Audinate website.

<http://www.audinate.com/>

Or Yamaha also provides a variety of information regarding Dante on our website.

<http://www.yamahaproaudio.com/>

### **3.1. Connecting a Device to the Dante Connector**

See the following information to set up a network to connect and use Dante devices in a RIVAGE PM system.

Only Dante devices or a computer with Dante Controller can be connected to the Dante connector of the HY144-D/-SRC. Do not connect any other devices to the connector.

Also, make sure to establish a physically separate connection between the Dante network and the control network.



## Network Connection Example

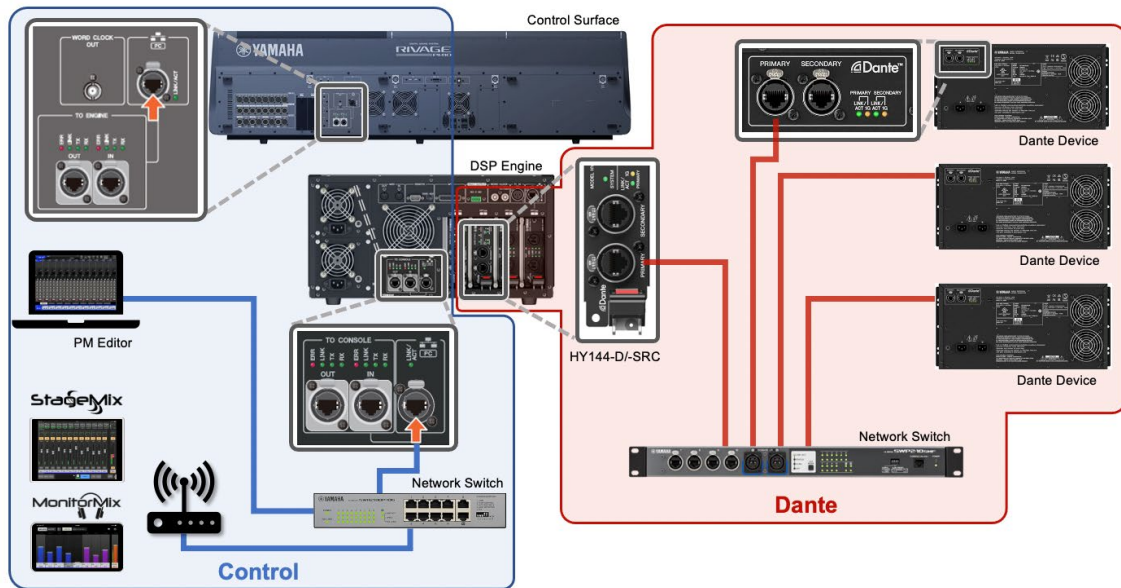

Do not connect a Dante Network switch to a Control Network switch in which the PM Editor, StageMix, or MonitorMix are connected.

## Prohibited Connection Example

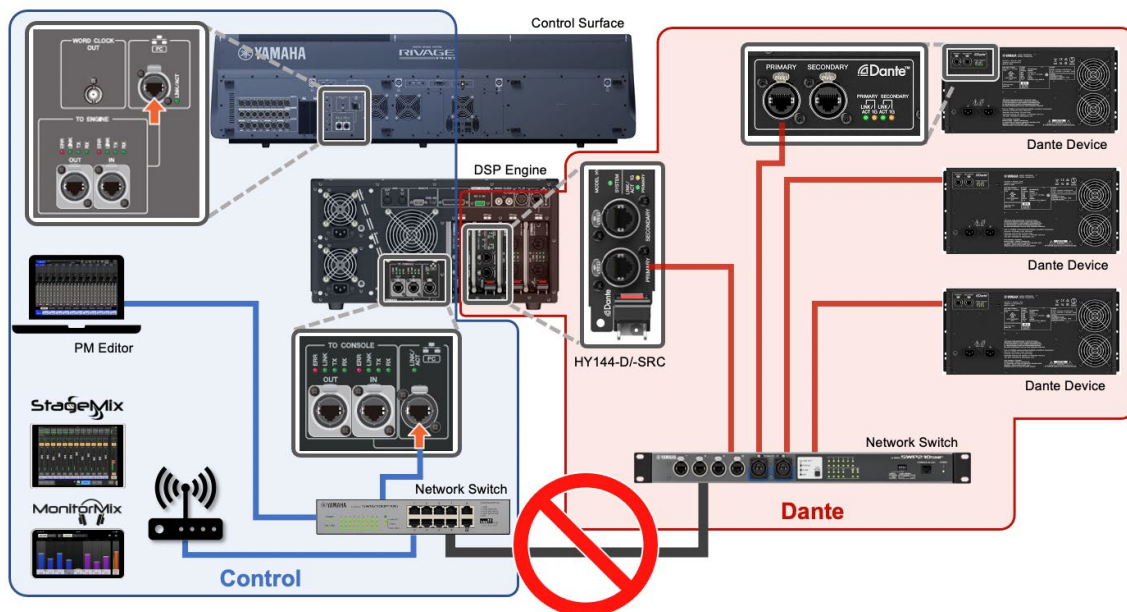

To use multiple HY144-D/-SRCs, Yamaha recommends that all the cards be used in the same Dante network. However, if you would like to connect the cards to multiple Dante networks that are physically separated, specify an IP address in a different subnet for each Dante network. See “Example 2: Multiple Dante networks” for details.

And make sure to connect all the installed HY144-D cards on the Dante network.

### 3.2. Configuring HY144-D/-SRC

Specify the Primary/Secondary IP and SLOT IP settings for Dante devices.

#### IP settings for Dante devices (Primary/Secondary)

The IP settings for Dante devices can be specified in the Dante Primary/Secondary IP settings for each HY144-D/-SRC, which can be found on the Network Config tab in the Device View window of the Dante Controller software.

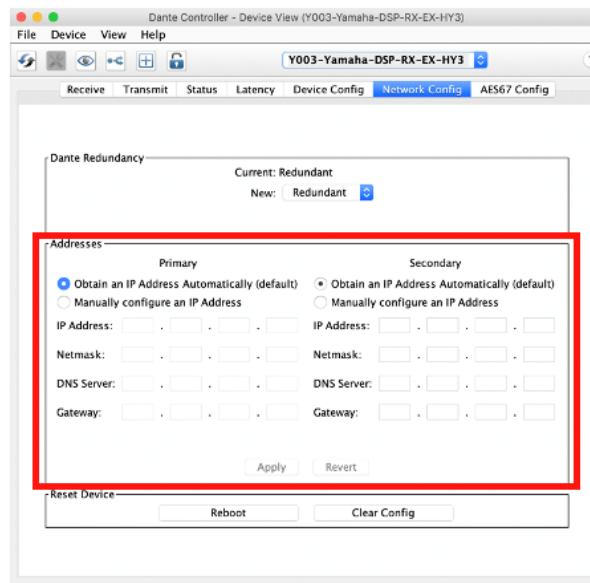

## To set up SLOT IP

The SLOT IP settings are for control communications between the HY144-D/-SRC and the DSP engine. To remotely control a supported device, adjust the SLOT IP settings.

1. Press the **SETUP** button in the menu bar to access the **SETUP** screen, and then press the **SYSTEM CONFIG** button.



2. Press the **HY SLOT** tab where an **HY144-D/-SRC** card is installed to display the **HY SLOT** window.



3. Press the NETWORK button.

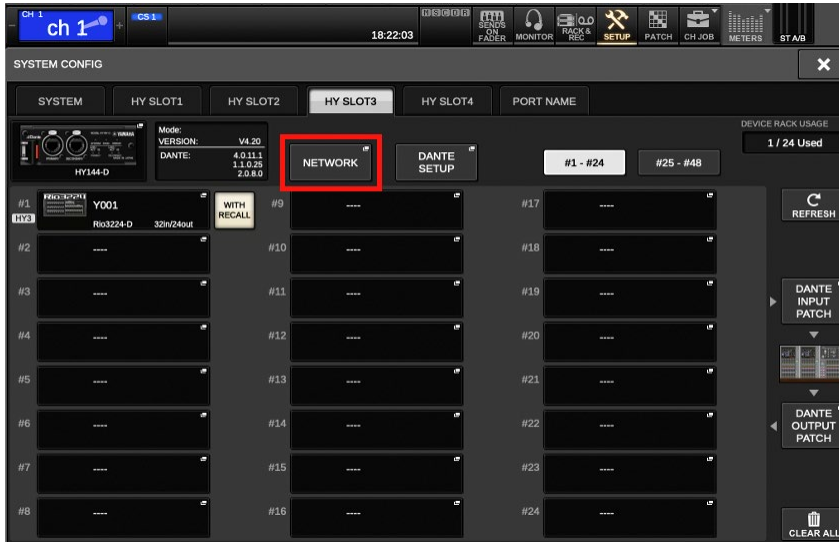

4. Input the SLOT IP SETTING.



Make sure to specify an IP address that is in the same subnet as the Dante network. The following IP addresses cannot be used for the STATIC IP of the SLOT IP SETTING.

- 192.168.53.xxx /24  
172.17.xxx.xxx /16 - 172.26.xxx.xxx/16  
(These are reserved for RIVAGE PM systems.)
- 169.254.xxx.xxx /16 (Link-local addresses) \*1
- Multicast addresses

Use an IP address in a different subnet from the IP address assigned in the DSP ENGINE IP SETTING.

\*1 To use a link-local address, use the AUTO (DHCP) to set the IP address.

## To set up DANTE CONTROL ID

The Dante Control ID needs to be set to remotely control the Rio series head amps.

To use multiple HY144-D/-SRC cards, set a unique ID for each card (except for ID OFF).

1. Open the HY SLOT window, and then press the DANTE SETUP button.

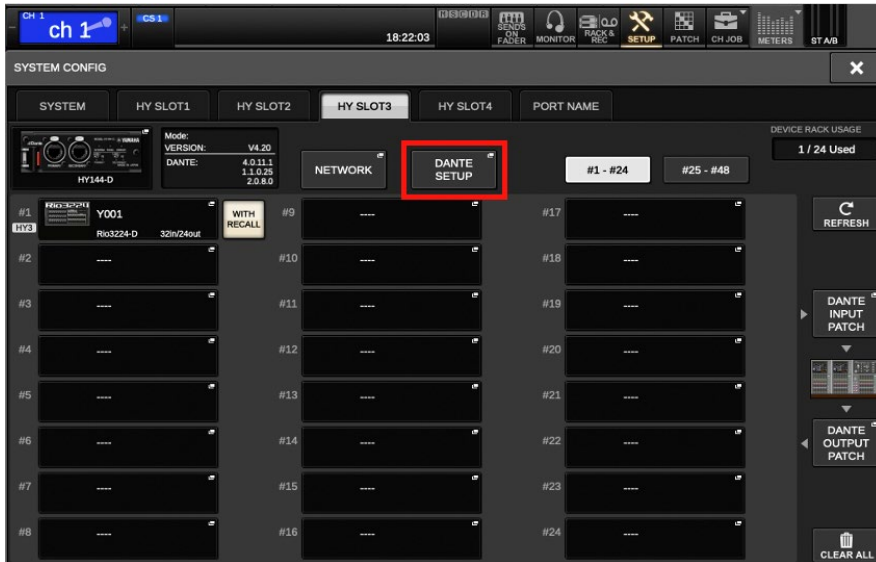

2. Choose the ID number from the DANTE CONTROL ID field.

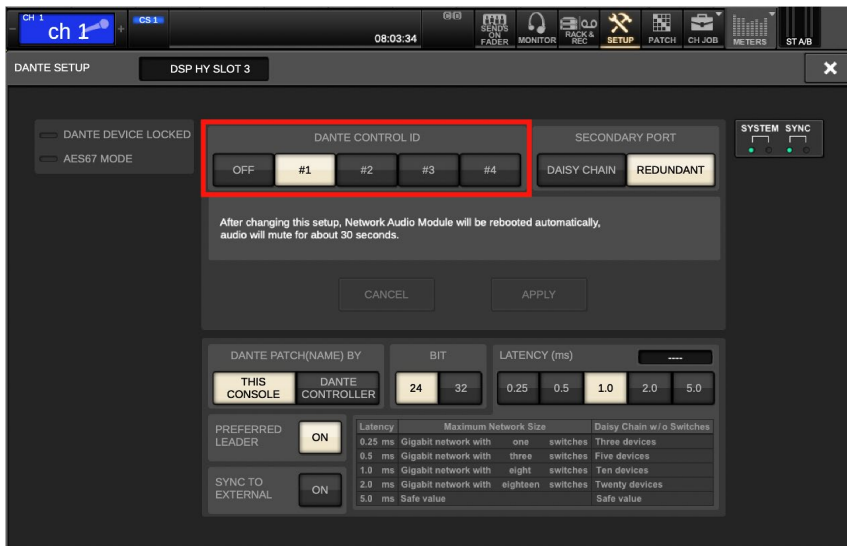

To connect more than four cards\*1 in one network, set the fifth and subsequent cards OFF. However, please note that the cards whose ID is set to off cannot remotely control the head amps.

For details about ID settings, see the RIVAGE PM Operation Manual.

\*1 This includes the cards in the multiple DSP engines and CL/QL series connected in the same Dante network.

### 3.3. Connection Examples

This section gives you connection examples of a RIVAGE PM system with Dante devices and provides precautions when connecting and setting up your system.

#### Example 1: A single Dante network

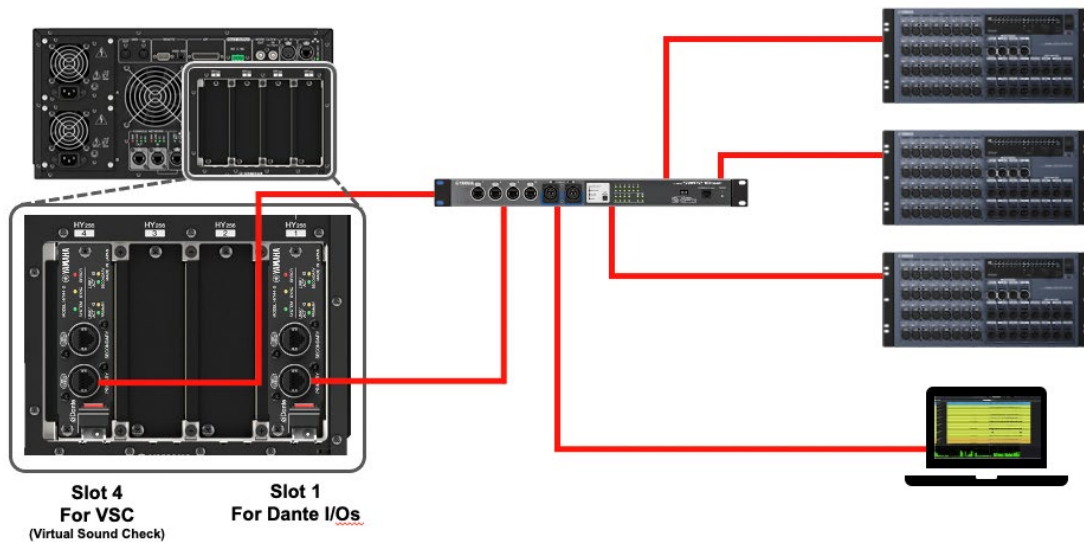

#### When using AUTO IP

The AUTO option automatically determines the Primary/Secondary IP and SLOT IP for the Dante device. Make sure that the Primary/Secondary IP and SLOT IP for each Dante device is set to AUTO (DHCP), which is the default.

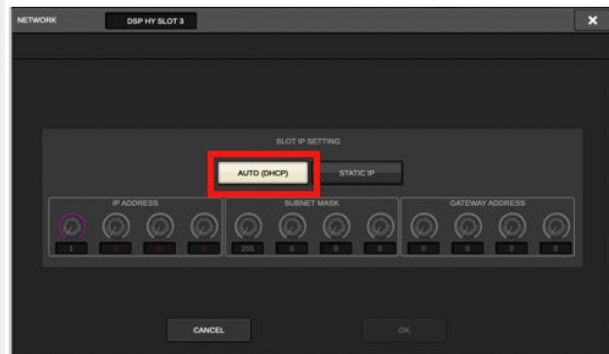
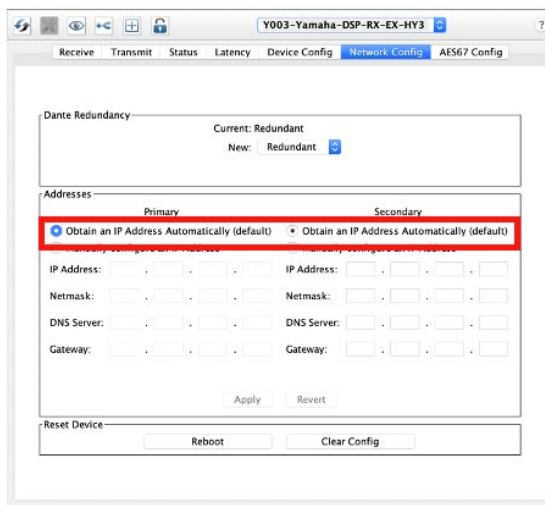

Make sure that the IP address specified for the Dante device IP address and the SLOT IP are in the same subnet.

When setting the IP address using a DHCP server, make sure that IP addresses assigned to the Dante device's Primary/Secondary IP and SLOT IP are not in the same subnet as the following IP addresses reserved for the RIVAGE PM system or the IP address assigned in the DSP ENGINE IP SETTING.

- 192.168.53.xxx /24  
172.17.xxx.xxx /16 - 172.26.xxx.xxx/16  
(These are reserved for RIVAGE PM systems.)

To use multiple HY144-D/-SRC cards, specify the Dante Control ID. Set a unique ID to each card (except for ID OFF).

### When using STATIC IP

An IP address can be manually set for the Dante device via the Primary/Secondary IP address or SLOT IP SETTING.

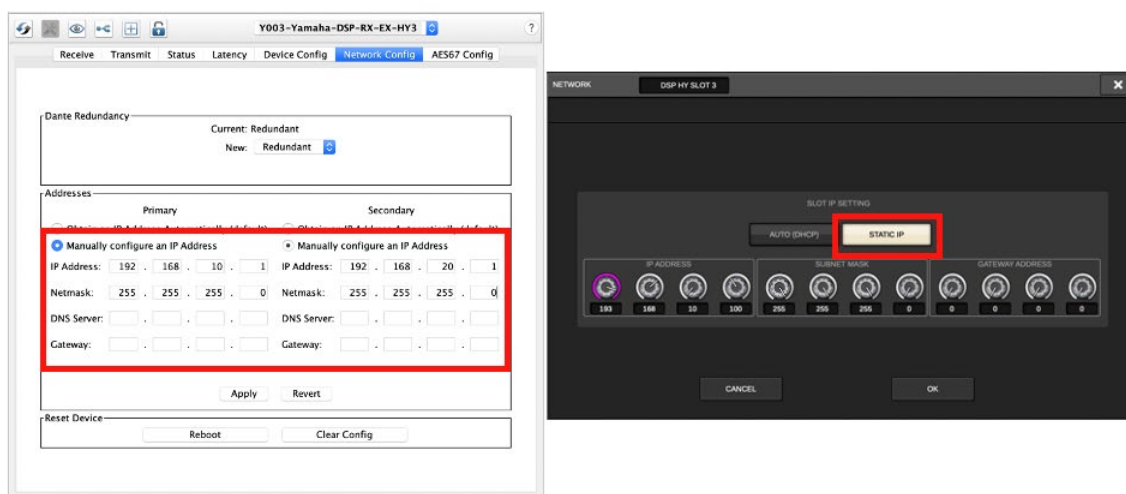



Make sure to specify an IP address that is in the same subnet as the Dante network for the SLOT IP. The following IP addresses cannot be used for the STATIC IP of the SLOT IP SETTING.

- 192.168.53.xxx /24  
172.17.xxx.xxx /16 - 172.26.xxx.xxx/16  
(These are reserved for RIVAGE PM systems.)
- 169.254.xxx.xxx /16 (Link-local addresses) \*1
- Multicast addresses

Use an IP address in a different subnet from the IP address assigned to the DSP ENGINE IP SETTING.

To use multiple HY144-D/-SRC cards, specify the Dante Control ID. Set a unique ID to each card (except for ID OFF).

## Example 2: Multiple Dante networks

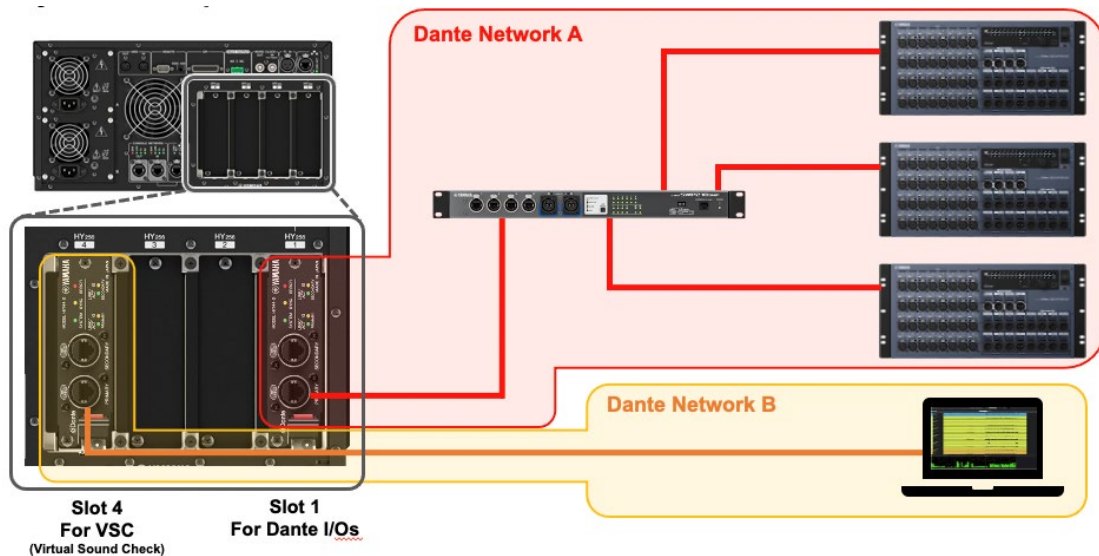



## AUTO IP Setting

The AUTO option automatically determines the Primary/Secondary IP and SLOT IP for the Dante device. Make sure that the Primary/Secondary IP and SLOT IP for each Dante device is set to AUTO (DHCP) – which is the default.

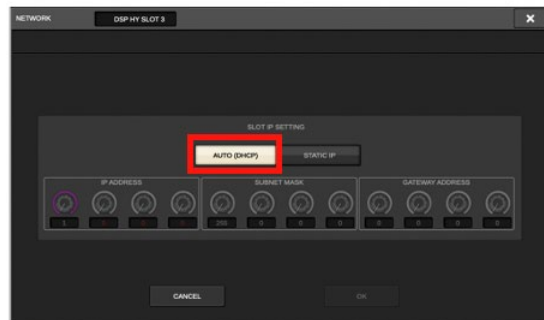
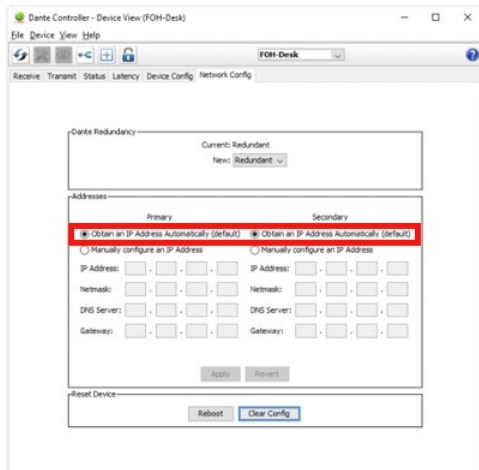

To connect two or more physically separate Dante networks using the AUTO IP setting, use a DHCP server to assign IP addresses in different subnets (network addresses) to each network.

Make sure that the IP address specified for the Dante device IP address and the SLOT IP are in the same subnet.



As shown in the following example, two or more Dante networks cannot be used if they all use link-local addresses or their IP addresses are in the same subnet.

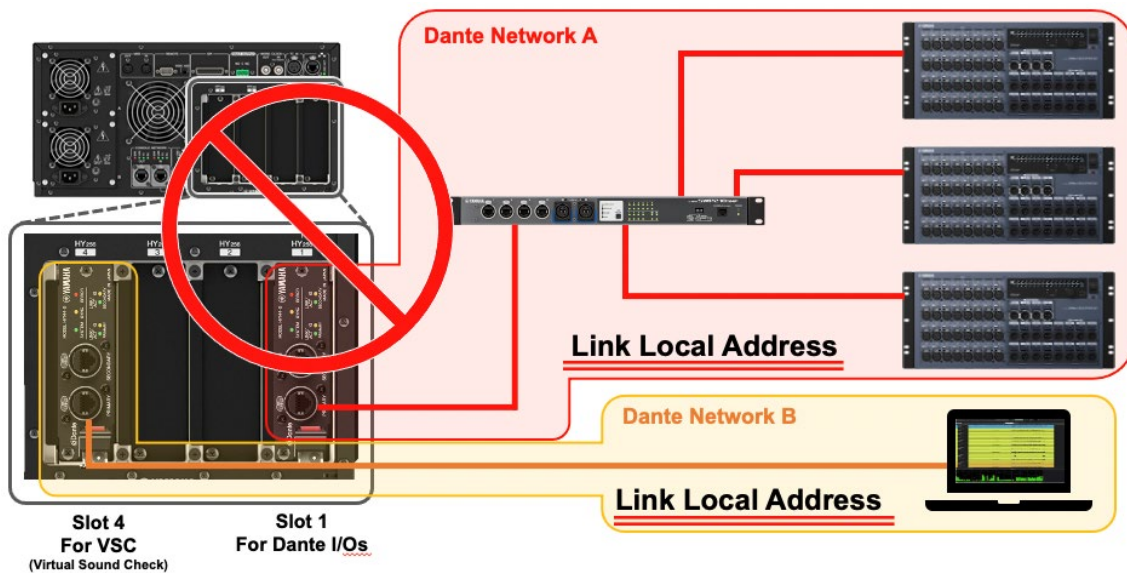

When using a DHCP server to set an IP address, make sure that the IP addresses assigned to the Dante device's Primary/Secondary IP and SLOT IP are not in the same subnet as the following IP addresses reserved for the RIVAGE PM system or the IP address of the DSP ENGINE IP SETTING.

- 192.168.53.xxx /24  
172.17.xxx.xxx /16 - 172.26.xxx.xxx/16  
(These are reserved for RIVAGE PM systems.)

To use multiple HY144-D/-SRC cards, specify the Dante Control ID. Set a unique ID to each card (except for ID OFF).

## STATIC IP Setting

An IP address can be manually set for the Dante device on the IP and SLOT IP SETTING.

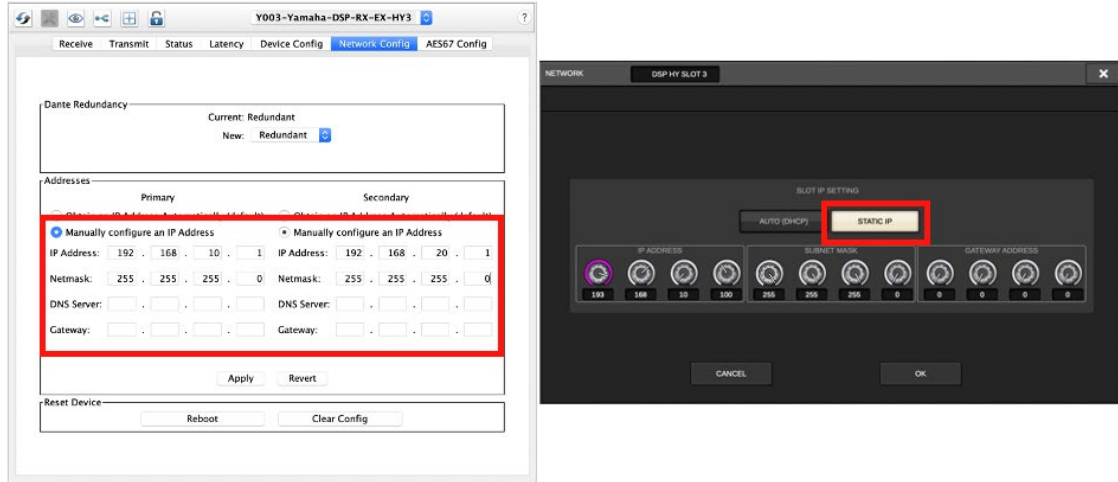

To connect two or more physically separate Dante networks, specify IP addresses in different subnets (network addresses) to each network.

Make sure that the IP address specified for the Dante device IP address and the SLOT IP are in the same subnet.

The following IP addresses cannot be used for the STATIC IP of the SLOT IP SETTING.

- 192.168.53.xxx /24  
172.17.xxx.xxx /16 - 172.26.xxx.xxx/16  
(These are reserved for RIVAGE PM systems.)
- 169.254.xxx.xxx /16 (Link-local addresses) \*1
- Multicast addresses

Use an IP address in a different subnet from the IP address used for the DSP ENGINE IP SETTING.

To use multiple HY144-D/-SRC cards, specify the Dante Control ID. Set a unique ID to each card (except for ID OFF).

## AUTO IP + STATIC IP Setting

To connect two or more physically separate Dante networks, set one network to Auto IP to create a link-local address and set the other network to Static IP by specifying a unique IP address.

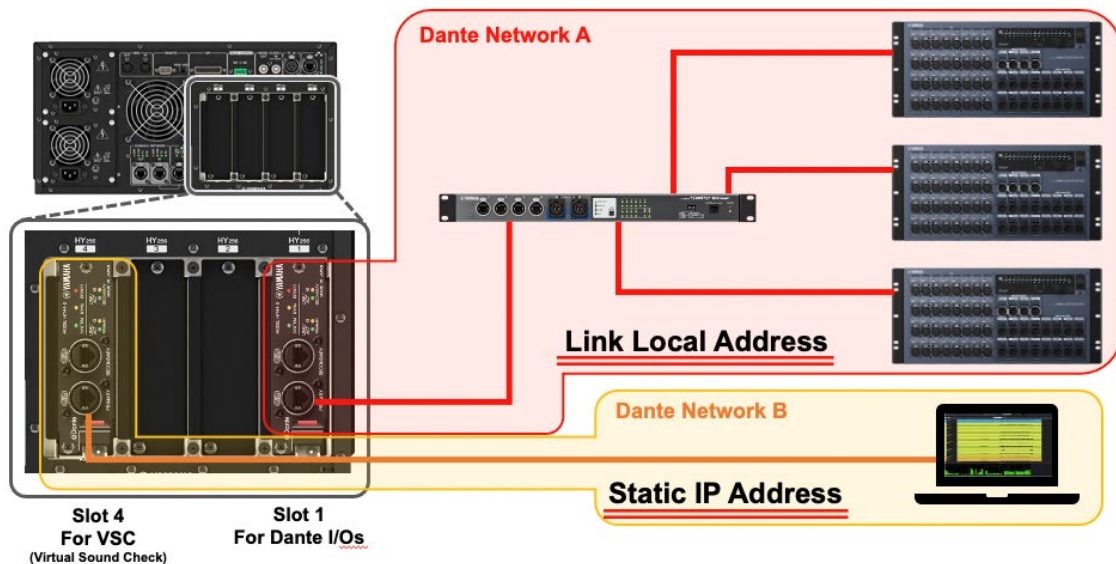

Input the Primary/Secondary IP and SLOT IP settings of each Dante device in the Dante network to either Auto IP or Static IP.

To connect two or more physically separate Dante networks, specify IP addresses in different subnets (network addresses) for each network.

### Example of IP setting

Dante network 1 (AUTO IP): 169.254.xxx.xxx / 255.255.0.0

Dante network 2 (STATIC IP): 192.168.10.xxx / 255.255.255.0

## 4. FAQ

**Q. Can two RIVAGE PM Editor apps be connected to one NETWORK [PC] connector?**

A. Yes, they can. Use a network switch to connect two computers in which RIVAGE PM Editor is installed. Please make sure to only connect devices to the network switch that are able to support the network connector.

**Q. When connecting multiple Dante networks with different physical connections to multiple HY144-D cards, can all the networks be set with their link-local address?**

A. No, they cannot. Each Dante network must have a unique subnet (network address). Please see Example 2 of the "3-3 Connection Examples" section to make the settings properly.

**Q. The DANTE SETUP options in SYSTEM CONFIG are grayed out and cannot be edited. How can I make the settings?**

A. It seems that your network is not set up properly. Please check the settings again. To connect multiple Dante networks with different physical connections, see Example 2 of the "3-3 Connection Examples " section to make the settings properly.

**Q. Is it possible to segment a switch into a Dante network and a control network using a VLAN and connect the two networks to one switch?**

A. Yes, it is. Make sure to configure the VLANs properly to prevent the two networks from accidentally connecting to each other. Also, connect the two switches via the trunk ports. Use switches with an appropriate uplink speed that's able to accommodate the bandwidth being used.

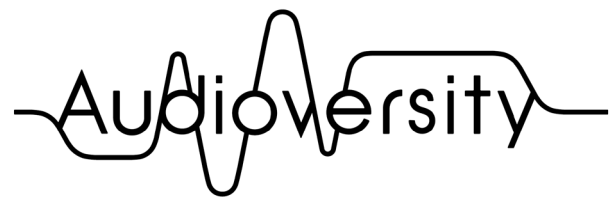

by Yamaha Pro Audio