

MUSIC SYNTHESIZER/REALTIME CONTROL/EXTENDED SYNTHESIS

EX5/EX7

TONE GENERATOR/REALTIME CONTROL/EXTENDED SYNTHESIS

EX5R

OWNER'S MANUAL

SPECIAL MESSAGE SECTION

PRODUCT SAFETY MARKINGS: Yamaha electronic products may have either labels similar to the graphics shown below or molded/stamped facsimiles of these graphics on the enclosure. The explanation of these graphics appears on this page. Please observe all cautions indicated on this page and those indicated in the safety instruction section.

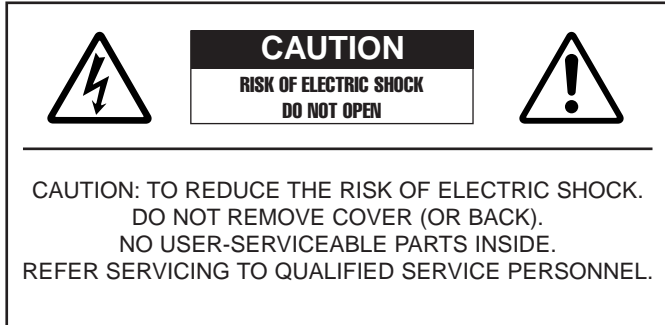

The exclamation point within the equilateral triangle is intended to alert the user to the presence of important operating and maintenance (servicing) instructions in the literature accompanying the product.

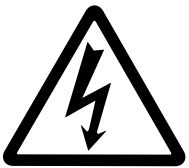

The lightning flash with arrowhead symbol, within the equilateral triangle, is intended to alert the user to the presence of uninsulated “dangerous voltage” within the product’s enclosure that may be of sufficient magnitude to constitute a risk of electrical shock.

IMPORTANT NOTICE: All Yamaha electronic products are tested and approved by an independent safety testing laboratory in order that you may be sure that when it is properly installed and used in its normal and customary manner, all foreseeable risks have been eliminated. DO NOT modify this unit or commission others to do so unless specifically authorized by Yamaha. Product performance and/or safety standards may be diminished. Claims filed under the expressed warranty may be denied if the unit is/has been modified. Implied warranties may also be affected.

SPECIFICATIONS SUBJECT TO CHANGE: The information contained in this manual is believed to be correct at the time of printing. However, Yamaha reserves the right to change or modify any of the specifications without notice or obligation to update existing units.

ENVIRONMENTAL ISSUES: Yamaha strives to produce products that are both user safe and environmentally friendly. We sincerely believe that our products and the production methods used to produce them, meet these goals. In keeping with both the letter and the spirit of the law, we want you to be aware of the following:

Battery Notice: This product MAY contain a small non-rechargeable battery which (if applicable) is soldered in place. The average life span of this type of battery is approximately five years. When replacement becomes necessary, contact a qualified service representative to perform the replacement.

Warning: Do not attempt to recharge, disassemble, or incinerate this type of battery. Keep all batteries away from children. Dispose of used batteries promptly and as regulated by applicable laws. Note: In some areas, the servicer is required by law to return the defective parts. However, you do have the option of having the servicer dispose of these parts for you.

Disposal Notice: Should this product become damaged beyond repair, or for some reason its useful life is considered to be at an end, please observe all local, state, and federal regulations that relate to the disposal of products that contain lead, batteries, plastics, etc.

NOTICE: Service charges incurred due to lack of knowledge relating to how a function or effect works (when the unit is operating as designed) are not covered by the manufacturer’s warranty, and are therefore the owners responsibility. Please study this manual carefully and consult your dealer before requesting service.

NAME PLATE LOCATION: The graphic below indicates the location of the name plate. The model number, serial number, power requirements, etc., are located on this plate. You should record the model number, serial number, and the date of purchase in the spaces provided below and retain this manual as a permanent record of your purchase.

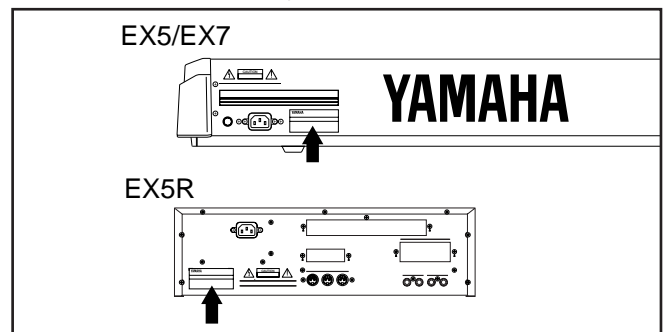

Model _____

Serial No. _____

Purchase Date _____

IMPORTANT SAFETY INSTRUCTIONS

INFORMATION RELATING TO PERSONAL INJURY, ELECTRICAL SHOCK, AND FIRE HAZARD POSSIBILITIES HAS BEEN INCLUDED IN THIS LIST.

WARNING- When using any electrical or electronic product, basic precautions should always be followed. These precautions include, but are not limited to, the following:

- 1.** Read all Safety Instructions, Installation Instructions, Special Message Section items, and any Assembly Instructions found in this manual BEFORE making any connections, including connection to the main supply.
- 2.** Do not attempt to service this product beyond that described in the user-maintenance instructions. All other servicing should be referred to qualified service personnel.
- 3.** Main Power Supply Verification: Yamaha products are manufactured specifically for the supply voltage in the area where they are to be sold. If you should move, or if any doubt exists about the supply voltage in your area, please contact your dealer for supply voltage verification and (if applicable) instructions. The required supply voltage is printed on the name plate. For name plate location, please refer to the graphic found in the Special Message Section of this manual.
- 4. DANGER-**Grounding Instructions: This product must be grounded and therefore has been equipped with a three pin attachment plug. If this product should malfunction, the ground pin provides a path of low resistance for electrical current, reducing the risk of electrical shock. If your wall socket will not accommodate this type plug, contact an electrician to have the outlet replaced in accordance with local electrical codes. Do NOT modify the plug or change the plug to a different type!
- 5. WARNING:** Do not place this product or any other objects on the power cord or place it in a position where anyone could walk on, trip over, or roll anything over power or connecting cords of any kind. The use of an extension cord is not recommended! If you must use an extension cord, the minimum wire size for a 25' cord (or less) is 18 AWG. NOTE: The smaller the AWG number, the larger the current handling capacity. For longer extension cords, consult a local electrician.
- 6.** Ventilation: Electronic products, unless specifically designed for enclosed installations, should be placed in locations that do not interfere with proper ventilation. If instructions for enclosed installations are not provided, it must be assumed that unobstructed ventilation is required.
- 7.** Temperature considerations: Electronic products should be installed in locations that do not seriously contribute to their operating temperature. Placement of this product close to heat sources such as; radiators, heat registers etc., should be avoided.
- 8.** This product was NOT designed for use in wet/damp locations and should not be used near water or exposed to rain. Examples of wet /damp locations are; near a swimming pool, spa, tub, sink, or wet basement.
- 9.** This product should be used only with the components supplied or; a cart ,rack, or stand that is recommended by the manufacturer. If a cart, rack, or stand is used, please observe all safety markings and instructions that accompany the accessory product.
- 10.** The power supply cord (plug) should be disconnected from the outlet when electronic products are to be left unused for extended periods of time. Cords should also be disconnected when there is a high probability of lightening and/or electrical storm activity.
- 11.** Care should be taken that objects do not fall and liquids are not spilled into the enclosure through any openings that may exist.
- 12.** Electrical/electronic products should be serviced by a qualified service person when:
 - a. The power supply cord has been damaged; or
 - b. Objects have fallen, been inserted, or liquids have been spilled into the enclosure through openings; or
 - c. The product has been exposed to rain; or
 - d. The product does not operate, exhibits a marked change in performance; or
 - e. The product has been dropped, or the enclosure of the product has been damaged.
- 13.** This product, either alone or in combination with an amplifier and headphones or speaker/s, may be capable of producing sound levels that could cause permanent hearing loss. DO NOT operate for a long period of time at a high volume level or at a level that is uncomfortable. If you experience any hearing loss or ringing in the ears, you should consult an audiologist.
IMPORTANT: The louder the sound, the shorter the time period before damage occurs.
- 14.** Some Yamaha products may have benches and/or accessory mounting fixtures that are either supplied as a part of the product or as optional accessories. Some of these items are designed to be dealer assembled or installed. Please make sure that benches are stable and any optional fixtures (where applicable) are well secured BEFORE using. Benches supplied by Yamaha are designed for seating only. No other uses are recommended.

PLEASE KEEP THIS MANUAL

FCC INFORMATION (U.S.A.)

1. IMPORTANT NOTICE: DO NOT MODIFY THIS UNIT!

This product, when installed as indicated in the instructions contained in this manual, meets FCC requirements. Modifications not expressly approved by Yamaha may void your authority, granted by the FCC, to use the product.

2. IMPORTANT: When connecting this product to accessories and/or another product use only high quality shielded cables. Cable/s supplied with this product **MUST** be used. Follow all installation instructions. Failure to follow instructions could void your FCC authorization to use this product in the USA.

3. NOTE: This product has been tested and found to comply with the requirements listed in FCC Regulations, Part 15 for Class "B" digital devices. Compliance with these requirements provides a reasonable level of assurance that your use of this product in a residential environment will not result in harmful interference with other electronic devices. This equipment generates/uses radio frequencies and, if not installed and used according to the instructions found in the users manual, may cause interference harmful to the operation of other electronic devices. Compliance with FCC regulations does not guarantee that interference will not

occur in all installations. If this product is found to be the source of interference, which can be determined by turning the unit "OFF" and "ON", please try to eliminate the problem by using one of the following measures:

Relocate either this product or the device that is being affected by the interference.

Utilize power outlets that are on different branch (circuit breaker or fuse) circuits or install AC line filter/s.

In the case of radio or TV interference, relocate/reorient the antenna. If the antenna lead-in is 300 ohm ribbon lead, change the lead-in to co-axial type cable.

If these corrective measures do not produce satisfactory results, please contact the local retailer authorized to distribute this type of product. If you can not locate the appropriate retailer, please contact Yamaha Corporation of America, Electronic Service Division, 6600 Orangethorpe Ave, Buena Park, CA90620

The above statements apply **ONLY** to those products distributed by Yamaha Corporation of America or its subsidiaries.

* This applies only to products distributed by YAMAHA CORPORATION OF AMERICA.

ADVARSEL!

Lithiumbatteri—Eksplussionsfare ved fejlagtig håndtering. Udskiftning må kun ske med batteri af samme fabrikat og type. Levér det brugte batteri tilbage til leverandoren.

VARNING

Explosionsfara vid felaktigt batteribyte. Använd samma batterityp eller en ekvivalent typ som rekommenderas av apparatillverkaren. Kassera använt batteri enligt fabrikantens instruktion.

VAROITUS

Paristo voi räjähtää, jos se on virheellisesti asennettu. Vaihda paristo ainoastaan laitevalmistajan suosittelemaan tyyppiin. Hävitä käytetty paristo valmistajan ohjeiden mukaisesti.

NEDERLAND NETHERLAND

- Dit apparaat bevat een lithium batterij voor geheugen back-up.
- This apparatus contains a lithium battery for memory back-up.
- Raadpleeg uw leverancier over de verwijdering van de batterij op het moment dat u het apparaat aan het einde van de levensduur afdankt of de volgende Yamaha Service Afdeling:
Yamaha Music Nederland Service Afdeling
Kanaalweg 18-G, 3526 KL UTRECHT
Tel. 030-2828425
- For the removal of the battery at the moment of the disposal at the end of the service life please consult your retailer or Yamaha Service Center as follows:
Yamaha Music Nederland Service Center
Address : Kanaalweg 18-G, 3526 KL UTRECHT
Tel : 030-2828425
- Gooi de batterij niet weg, maar lever hem in als KCA.
- Do not throw away the battery. Instead, hand it in as small chemical waste.

• This applies only to products distributed by Yamaha-Kemble Music (U.K.) Ltd.

IMPORTANT NOTICE FOR THE UNITED KINGDOM

Connecting the Plug and Cord

WARNING: THIS APPARATUS MUST BE EARTHED
IMPORTANT. The wires in this mains lead are coloured in accordance with the following code:

GREEN-AND-YELLOW:	EARTH
BLUE	: NEUTRAL
BROWN	: LIVE

As the colours of the wires in the mains lead of this apparatus may not correspond with the coloured markings identifying the terminals in your plug proceed as follows:

The wire which is coloured GREEN-and-YELLOW must be connected to the terminal in the plug which is marked by the letter E or by the safety earth symbol or colored GREEN or GREEN-and-YELLOW.

The wire which is coloured BLUE must be connected to the terminal which is marked with the letter N or coloured BLACK.

The wire which is coloured BROWN must be connected to the terminal which is marked with the letter L or coloured RED.

PRECAUTIONS

PLEASE READ CAREFULLY BEFORE PROCEEDING

* Please keep these precautions in a safe place for future reference.



WARNING

Always follow the basic precautions listed below to avoid the possibility of serious injury or even death from electrical shock, short-circuiting, damages, fire or other hazards. These precautions include, but are not limited to, the following:

- This instrument contains no user-serviceable parts. Do not attempt to disassemble or modify the internal components in any way.
- Do not expose the instrument to rain, use it near water or in damp or wet conditions, or place containers on it containing liquids which might spill into any openings.
- If the power cord or plug becomes frayed or damaged, or if there is a sudden loss of sound during use of the instrument, or if any unusual smells or smoke should appear to be caused by it, immediately turn off the power switch, disconnect the electric plug from the outlet, and have the instrument inspected by qualified Yamaha service personnel.
- Only use the voltage specified as correct for the instrument. The required voltage is printed on the name plate of the instrument.
- Always connect the three-pin attachment plug to a properly grounded power source. (For more information about the main power supply, see page 16.)
- Before cleaning the instrument, always remove the electric plug from the outlet. Never insert or remove an electric plug with wet hands.
- Check the electric plug periodically and remove any dirt or dust which may have accumulated on it.



CAUTION

Always follow the basic precautions listed below to avoid the possibility of physical injury to you or others, or damage to the instrument or other property. These precautions include, but are not limited to, the following:

- Do not place the power cord near heat sources such as heaters or radiators, and do not excessively bend or otherwise damage the cord, place heavy objects on it, or place it in a position where anyone could walk on, trip over, or roll anything over it.
- When removing the electric plug from the instrument or an outlet, always hold the plug itself and not the cord. Pulling by the cord can damage it.
- Do not connect the instrument to an electrical outlet using a multiple-connector. Doing so can result in lower sound quality, or possibly cause overheating in the outlet.
- Remove the electric plug from the outlet when the instrument is not to be used for extended periods of time, or during electrical storms.
- Before connecting the instrument to other electronic components, turn off the power for all components. Before turning the power on or off for all components, set all volume levels to minimum.
- Do not expose the instrument to excessive dust or vibrations, or extreme cold or heat (such as in direct sunlight, near a heater, or in a car during the day) to prevent the possibility of panel disfiguration or damage to the internal components.
- Do not use the instrument near other electrical products such as televisions, radios, or speakers, since this might cause interference which can affect proper operation of the other products.
- Do not place the instrument in an unstable position where it might accidentally fall over.
- Before moving the instrument, remove all connected cables.
- When cleaning the instrument, use a soft, dry cloth. Do not use paint thinners, solvents, cleaning fluids, or chemical-impregnated wiping cloths. Also, do not place vinyl, plastic or rubber objects on the instrument, since this might discolor the panel or keyboard.
- Do not rest your weight on, or place heavy objects on the instrument, and do not use excessive force on the buttons, switches or connectors.
- Use only the stand/rack specified for the instrument. When attaching the stand or rack, use the provided screws only. Failure to do so could cause damage to the internal components or result in the instrument falling over.
- Do not operate the instrument for a long period of time at a high or uncomfortable volume level, since this can cause permanent hearing loss. If you experience any hearing loss or ringing in the ears, consult a physician.

■ REPLACING THE BACKUP BATTERY

- This instrument contains a non rechargeable internal backup battery which permits internal data to remain stored even when the power is off. When the backup battery needs replacing, the message "Change internal battery!" will display in the LCD. When this happens, immediately back up your data, then have qualified Yamaha service personnel replace the backup battery.
- Do not attempt to replace the backup battery yourself, in order to prevent the possible serious hazards. Always have qualified Yamaha service personnel replace the backup battery.
- Never place the backup battery in a location that a child can reach, since a child might accidentally swallow the battery. If this should happen, consult a physician immediately.

■ SAVING USER DATA

- Always save data to a floppy disk frequently, in order to help prevent the loss of important data due to a malfunction or user operating error.

Yamaha cannot be held responsible for damage caused by improper use or modifications to the instrument, or data that is lost or destroyed.

Always turn the power off when the instrument is not in use.

The Yamaha EX5 and EX7 Music Synthesizers, and the EX5R Tone Generator, offer more music performance and production power than ever before available in a single keyboard or tone generator unit. All three models feature a unique Extended Synthesis system which incorporates a number of the most advanced tone generator technologies currently available ... plus a full-featured sampling system. There's also a top-quality internal effect system so no extra sound-processing equipment is required. 16-track song and 8-track pattern sequencers provide sophisticated on-board sequence programming and editing capability, while a unique 4-track arpeggiator function adds extended performance and accompaniment capability. The EX-series keyboards and tone generator also offer one of the most versatile and intuitive real-time control systems available, and they're expandable to suit a wide range of professional systems and requirements. We urge you to read through at least the introductory section of this owner's manual while familiarizing yourself with your EX5, EX5R, or EX7, and keep the manual in a safe place for future reference.

About the Manual

This owner's manual is divided into two main sections: The Introductory Section, and the Reference Section:

■ Introductory Section

This section has been designed to provide you with an overall understanding of the EX5, EX5R, and EX7, as well as some hints as how to use these advanced instruments most effectively. It will also refer you to corresponding sections in the Reference section, so you can refer to the pertinent details as necessary. Use the Introductory Section as a guide and directory to the main features and functions of the EX5, EX5R, and EX7.

■ Reference Section

The Reference Section contains full details and instructions for all of the EX features and functions. You should be able to find the information you need via the table of contents, the index at the back of the manual, or via the Introductory Section, described above.

SONDIUS-XG™ (EX5/5R)

Products bearing the SONDIUS-XG logo are licensed under patents of Stanford University and Yamaha as listed on the internet web site, < <http://www.sondius-xg.com> > .

This product is not compatible with the XG format or XG song data.

Included Accessories

Demonstration Disk 1-4
Owner's Manual
Data List
AC Power Cord

Copying of the commercially available music sequence data and/or digital audio files is strictly prohibited except for your personal use.

The illustrations and LCD screens as shown in this owner's manual are for instructional purposes only, and may appear somewhat different from those on your instrument.

The company names and product names in this Owner's Manual are the trademarks or registered trademarks of their respective companies.

Contents

Introductory Section

The Controls & Connectors	8
Setting Up	16
The Supplied Disks, Demos, & Factory Set Data	25
EX System Overview	28
Extended Synthesis	29
AWM Synthesis	29
Virtual Acoustic Synthesis (EX5/5R)	30
AN Synthesis (Analog Physical Modeling)	33
FDSP Synthesis (Formulated Digital Signal Processing)	34
Voice and Performance Selection.....	36
Voice Structure & Editing Hints	40
System Overview	40
Polyphony.....	45
Editing Control	45
Voice Store Procedure	48
The Power of the Performance Mode	49
Performance Store Procedure	53
Performance Mode DSP Limitations	54
The Controllers	55
The EX Controllers	55
Scene Switching & Morphing.....	57
Controller Sets	58
Sequencer Functions	60
Sequencer Record Modes & Editing.....	62
Play Effects & Groove Quantization	64
The EX Effect System	65
Sampling	69
The Key Map Mode	72

Reference Section

Voice Mode.....	75
Voice Play Mode.....	75
Voice Edit Mode.....	76
Voice Job Mode	148
Wave Edit Mode.....	150
Wave Job Mode	154
Performance Mode	156
Performance Play Mode	156
Performance Edit Mode	158
Performance Job Mode	172
Sample Mode	175
Sample Play Mode	175
Sample Record Mode.....	176
Sample Edit Mode	179
Sample Job Mode	182
Song Mode	185
Song Play Mode	185
Song Record Mode.....	193
Song Edit Mode	201
Song Job Mode	206
Pattern Mode	219
Pattern Play Mode	219
Pattern Record Mode.....	223
Pattern Edit Mode	226
Pattern Job Mode	227
Arpeggio Mode.....	238
Arpeggio Record Mode	245
Arpeggio Edit Mode	247
Arpeggio Job Mode	249
Disk Mode	259
Utility Mode.....	270
Appendix	278
Optional Boards/Memories.....	278
Troubleshooting.....	291
LCD Messages	294
Specifications	295
Index.....	296

Introductory Section

Reference Section

Voice Mode

Performance Mode

Sample Mode

Song Mode

Pattern Mode

Arpeggio Mode

Disk Mode

Utility Mode

Appendix

Introductory Section

The Controls & Connectors

The following brief descriptions of the EX controls and connectors should help you to understand the overall logic of the interface.

Front Panel

EX5/7

① **OCTAVE [DOWN] and [UP] Keys** (EX5 and EX7 only)

Shift the pitch of the keyboard up or down up to five octaves in one-octave steps. The pitch is shifted one octave in the corresponding direction, up to the maximum, each time one of these keys is pressed. When the current octave is higher than the normal octave the UP indicator will be lit, and vice versa. Neither indicator will be lit when the normal octave is selected.

② **[PITCH] Wheel** (EX5 and EX7 only)

This self-centering pitch wheel allows smooth upward and downward pitch bends. A range of other control functions can be assigned to the PITCH wheel.

➔ See page 55 for more information.

③ **[MODULATION 1] and [MODULATION 2] Wheels** (EX5 and EX7 only)

Can be assigned to any of the extensive range of controller parameters for extraordinary expressive control. The MODULATION 2 wheel can also be used for “scene morphing” — i.e. smoothly changing from one memorized scene to the other.

➔ See page 55 for more information.

④ **Ribbon Controller** (EX5 and EX7 only)

Another expressive EX controller, the Ribbon Controller is touch sensitive, and is controlled by running a finger lightly across its surface to the left or right. The Ribbon Controller can be assigned to the full range of EX parameters.

➔ See page 56 for more information.

⑨ **Floppy Disk Drive**

The built-in floppy disk drive allows easy, economical, high-volume storage of voice data. The disk-in-use LED indicator below the drive slot lights while any disk operation is in progress (NEVER attempt to remove a disk or turn the power off while a disk operation is in progress). The eject key, also below the disk slot, is used to remove disks from the drive.

➔ See page 259 for more information.

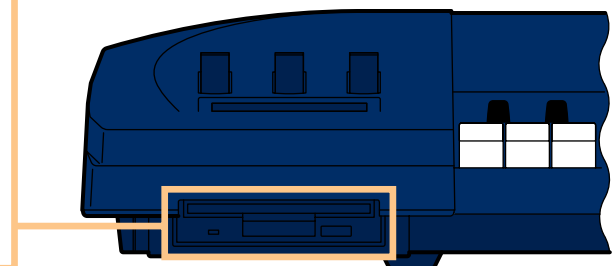
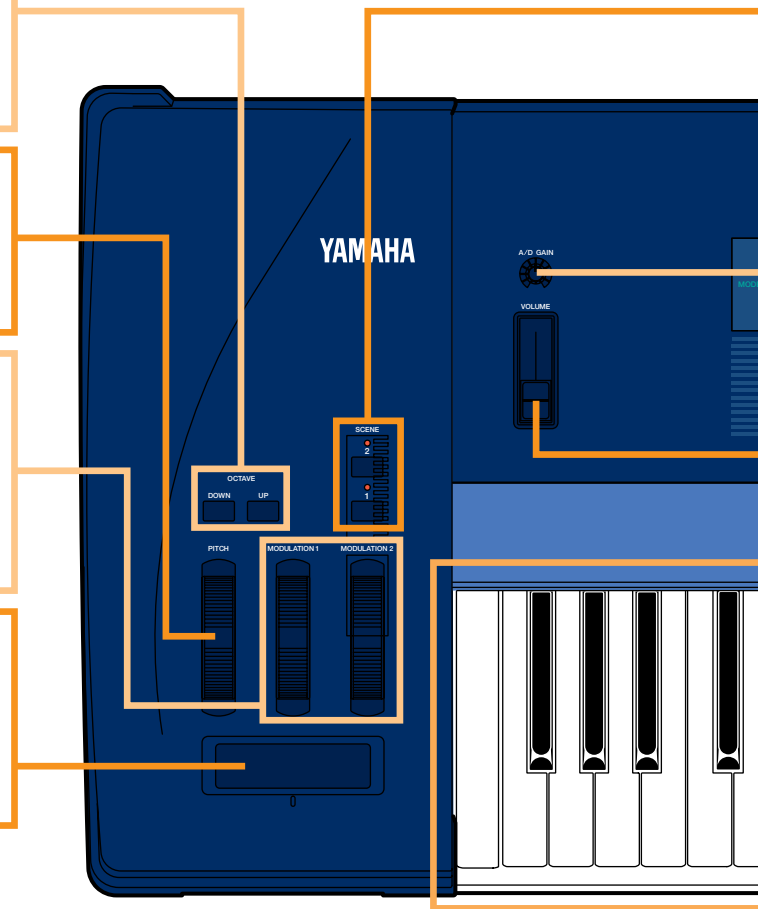

⑤ **SCENE [1] and [2] Keys** ([SC1] and [SC2] on the EX5R)

The SCENE [1] and [2] keys can be used to memorize and recall different settings of the Controller Knobs, so a complete set of knob settings can be recalled instantaneously. Knob scenes are stored by using the SCENE keys in conjunction with the STORE key (page 57). When both SCENE indicators are lit (this is done by pressing one SCENE key while holding the other), the MODULATION 2 wheel or a foot controller can be used to “morph” between the two scenes stored in the SCENE [1] and [2] keys (page 57).

⑥ **A/D Gain Control**

Adjusts the input level of the INPUT R and L/MONO jacks (the INPUT jack on the EX7), and therefore the level of the signal appearing at the input of the A/D (Analog-to-Digital) converter. This control is important for setting optimum record level when recording samples in the SAMPLE mode.

➔ See page 70 for more information.

⑦ **VOLUME Control**

Adjusts the volume of the sound delivered via the rear-panel OUTPUT L/MONO and R jacks as well as the PHONES jack.

⑧ **Keyboard** (EX5 and EX7 only)

The EX5 has a 76-key keyboard while the EX7 has a 61-key keyboard. Both are velocity and after-touch sensitive for broad, intimate expressive control.

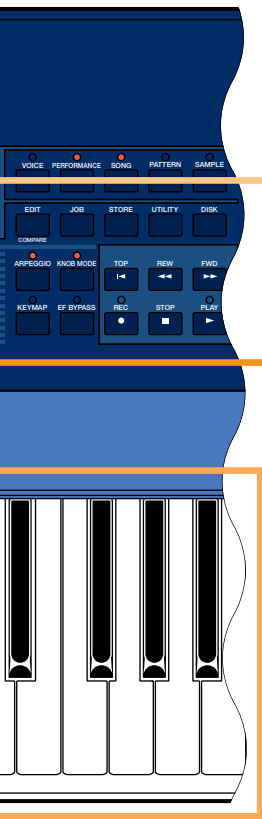

EX5R



* ①, ②, ③, ④ and ⑧ are not available on EX5R.

EX5/7

10 [KNOB MODE] Key ([KNOB] on the EX5R)

The six Controller Knobs, described below, can function either as sound controllers or data entry knobs. In the Song, Pattern, Sample, Edit, Job, Store, Utility and Disk modes the [KNOB MODE] key switches between data entry and sound control, allowing you to try out the effect of knob-related settings without having to exit from the Edit mode. The knobs function only as sound controllers in the Voice and Performance modes.

11 [ARPEGGIO] Key ([ARPEG] on the EX5R)

This key turns the advanced automatic arpeggiator on or off. When the arpeggiator is turned on, the Voice or Performance Edit mode Arpeggiator edit display will appear.

➔ See page 238 for more information.

NOTE [ARPEGGIO] key functions (can be turned on or off) when in Voice mode, Performance mode and Song mode.

12 [KEY MAP] Key

Engages the Key Map mode in which samples, entire patterns, or pattern tracks can be individually assigned to separate keys on the keyboard.

➔ See page 72 for more information.

NOTE [KEYMAP] key functions (can be turned on or off) when in Voice mode, Performance mode and Song mode.

13 [EF BYPASS] Key ([BYPASS] on the EX5R)

Turns the type of effects specified in the Utility mode Other Setup display on or off. When engaged (i.e. when the indicator is lit) the specified effects are bypassed.

➔ See page 276 for more information.

15 MODE Keys

The MODE keys select the corresponding EX modes, or appropriate sub-modes. The upper row of MODE keys engage the primary modes, and have LED indicators to show which mode(s) are currently active. The lower row of MODE keys select secondary or utility modes.

NOTE You can not enter Pattern mode when [ARPEGGIO] key or [KEYMAP] key is turned on.

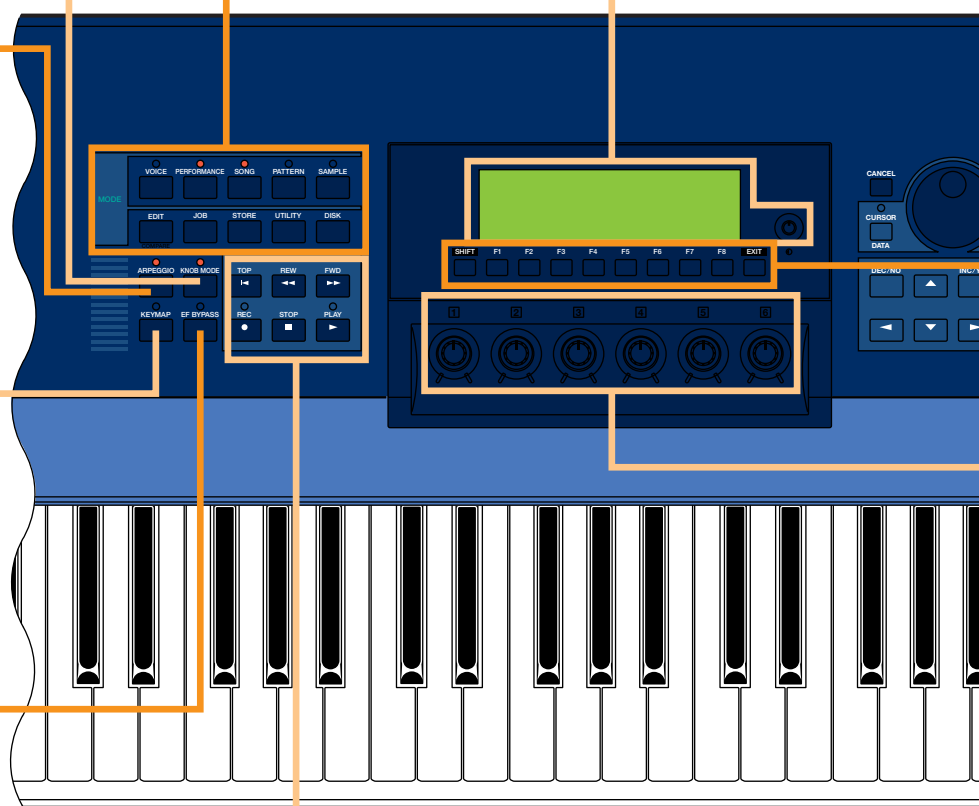

14 Sequencer Keys

The sequencer keys control recording and playback in the Song, Pattern, and Arpeggio modes, and allow you to locate a specific measure within a song or pattern. Their layout and functions are similar to the transport controls on a tape recorder.

[●] REC	Press this key to engage the record ready mode. You have to press the START key to actually start recording.
[■] STOP	Press to stop recording or playback.
[▶] START	Press to start recording or playback.

[◀] TOP	This key takes you directly to the first measure (the "top") of the current song or pattern.
[◀◀] REW	Press briefly to move back one measure, or hold for continuous scrolling.
[▶▶] FWD	Press briefly to move forward one measure, or hold for continuous scrolling.

[VOICE]	The Voice mode lets you select, play, and edit individual voices. The [VOICE] key indicator also blinks to indicate that a MIDI System Exclusive message is being received. [→ page 75]	[SAMPLE]	Advanced sample recording and editing features are available via the Sample mode. [→ page 175]
[PERFORMANCE]	In the Performance mode you can select, play, and edit individual "performance" programs including multiple layered or split voices and effects. Press the [VOICE] key while holding the [PERFORMANCE] key to go directly to the Voice Edit mode from the Performance mode. The [PERFORMANCE] key indicator also blinks to indicate that a MIDI System Exclusive message is being received. [→ page 156]	[EDIT]	The [EDIT] key accesses the appropriate editing functions for the currently selected mode: Voice, Performance, Song, Pattern, or Sample.
[SONG]	The Song mode provides access to the sophisticated sequence recording, playback, and editing capabilities provided by the EX5, EX5R, and EX7. [→ page 185]	[JOB]	Each of the primary modes — Voice, Performance, Song, Pattern, and Sample — have a range of "jobs" which can be accessed by pressing the [JOB] key.
[PATTERN]	Sequence "patterns" which can be used individually or incorporated into complete songs in the Song mode can be recorded, played, and edited in the Pattern mode. [→ page 219]	[STORE]	This key is used to store edited data to an internal memory location, or controller knob settings to either of the SCENE keys. [→ pages, 48, 53 and 57]
		[UTILITY]	The UTILITY mode includes MIDI, system and other functions that are essential for general operation. [→ page 270]
		[DISK]	The Disk mode includes disk save and load functions as well as all other functions you need for efficient data storage and management. [→ page 259]

16 LCD Display Screen & Contrast Control

This large multi-function liquid crystal display screen shows all parameters and prompts you need to operate the EX5, EX5R, or EX7 with optimum ease and efficiency.

Use the contrast control to achieve the best display visibility (LCD visibility varies greatly with viewing angle and lighting).

17 [F1] through [F8] Function, [SHIFT], and [EXIT] Keys

The functions of these keys depend on the selected mode. They are used to engage a function indicated on the display immediately above the key or select a page of parameters.

When the "S" symbol appears in the lower left corner of the display, the [SHIFT] key can be used to select a secondary function menu for the function keys: press the appropriate function key while holding the [SHIFT] key to access a secondary function.

The [EXIT] key will return you to the next highest level in the display hierarchy when in an editing, utility, or disk function display. In most cases you can return directly to the top-level primary mode display by directly pressing the appropriate MODE key.

18 Controller Knobs

These knobs form an important part of the advanced EX user interface. They can be assigned to control an impressively wide range of sound parameters in real time during performance/playback, and they can function as data entry controls in the editing, utility, disk, and some other modes. The [KNOB MODE] key, described above, determines which function the knobs assume in the appropriate modes.

Normally when you rotate a controller knob being used for data entry, the corresponding value changes in *relative* fashion — i.e. the knob increases or decreases the value of the parameter in relation to the value that was initially on the display. If you rotate a controller knob while holding the [KNOB MODE] key, however, the relationship between the controller position and the data value becomes *absolute*, and the central detented position of the knob will correspond to the exact center of the parameter range.

EX5R

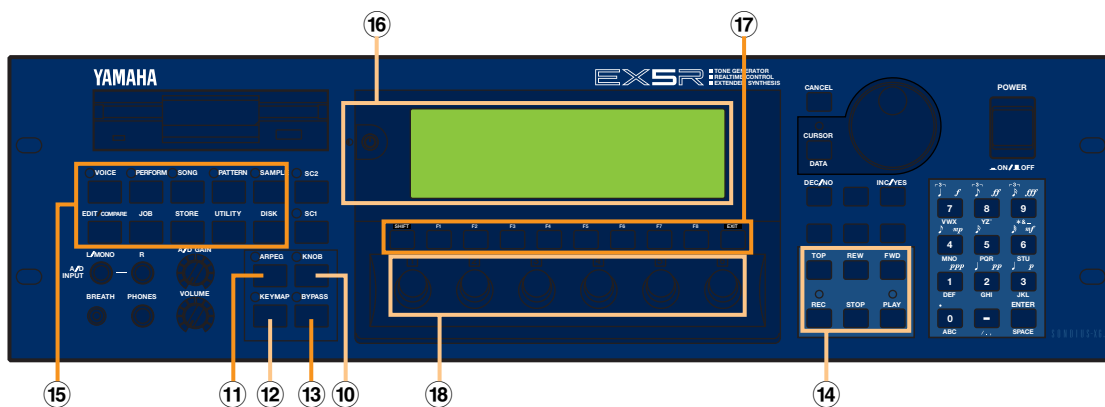

EX5/7**19 Data Dial and [CURSOR/DATA] Key**

The Data Dial provides a fast, efficient way to cover a broad range of voice numbers when, for example, you're looking for a voice but don't know the number. It's also handy for making large value changes in any of the editing and utility modes.

When editing the Data Dial will normally increment or decrement the selected parameter value. When the [CURSOR/DATA] key is pressed and its indicator is lit, however, the Data Dial moves the cursor around the display rather than changing values. This can be handy when navigating a complex display which includes many individual parameters.

20 [CANCEL] Key

The [CANCEL] key can be used to cancel an entered value and return to the previous value if pressed before a different parameter is selected.

21 [DEC/NO] and [INC/YES] Keys

Used to select voices and edit parameter values in any of the EX edit modes. Either key can be pressed briefly for single stepping in the specified direction, or held for continuous scrolling. These keys are also used to respond "Yes" or "No" to confirmation prompts when executing certain operations or saving/loading data.

22 Cursor Keys

These 4 keys move the "cursor" around the display screen, highlighting the various items that are available for selection or parameters that are available for editing (the cursor appears as a dark block with inverse characters).

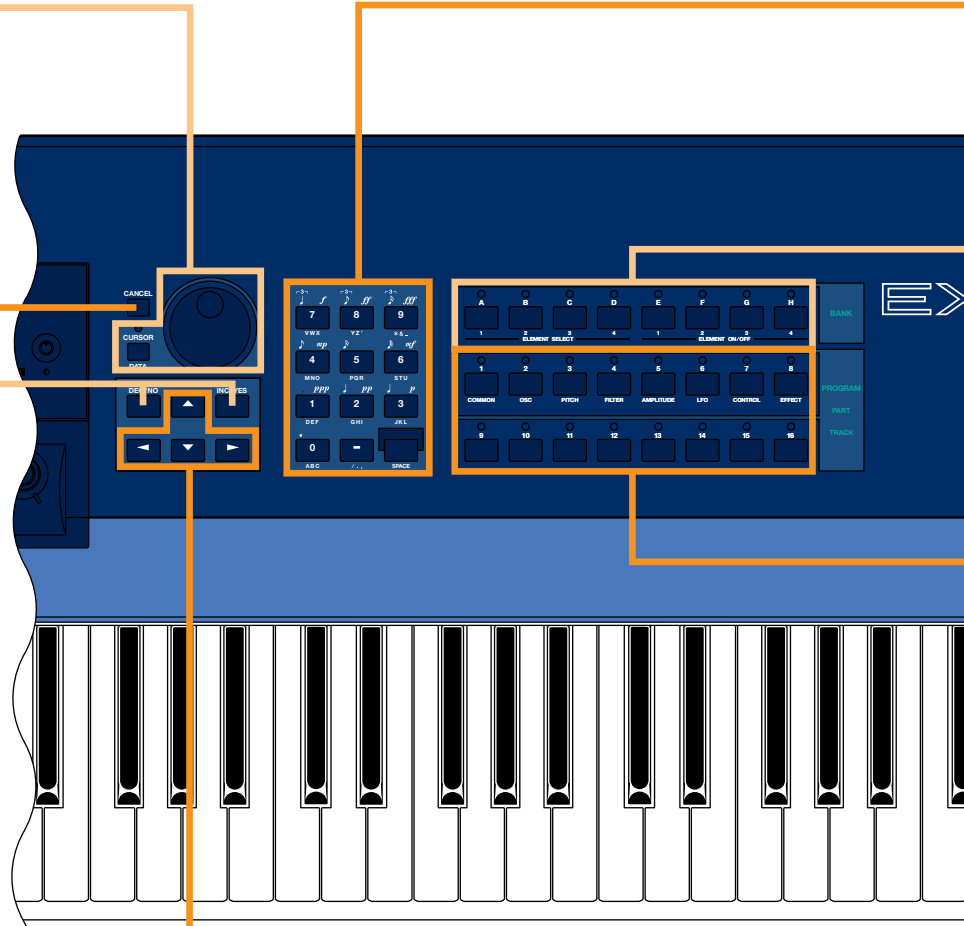

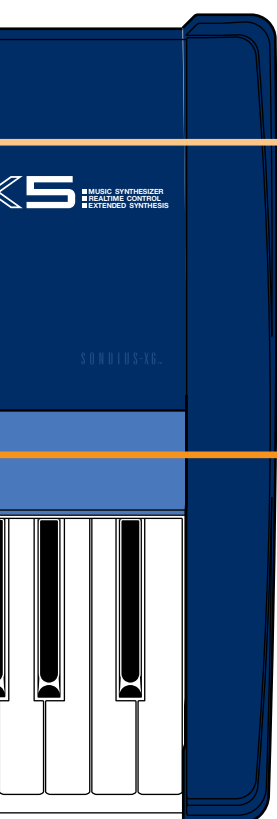

23 Numeric Keypad and [ENTER] Key

These keys allow direct entry of numeric values where applicable. Enter the required value via the numeric keys — the entered number will flash on the displays — then press the [ENTER] key to actually enter the specified value. The [ENTER] key is also used to enter notes and other events when editing sequence data, and to execute a specified job or disk function. The numeric keys are also used to specify note lengths and dynamics (velocity) when step recording in the SONG or PATTERN mode.

➔ See page 199 for more information.

24 Bank [A] Through [H] Keys (EX5 and EX7 only)

Each of the EX5 and EX7 voice memories — P1 (Preset 1), P2 (Preset 2), I1 (Internal 1) and I2 (Internal 2) — has 128 voice memory locations arranged in 8 banks of 16 voices each. The 128 performance memories are also organized in 8 banks of 16 performance setups. These keys select the bank from which an individual voice or performance setup will be selected. When editing voice parameters they are also used to select and mute elements.

25 Program Number [1] Through [16] Keys (EX5 and EX7 only)

The program number keys are used in conjunction with the bank keys to select any of the 128 voice memory locations within the currently selected voice memory — P1 (Preset 1), P2 (Preset 2), I1 (Internal 1) and I2 (Internal 2) — in the VOICE mode, or any of the 128 performance memory locations in the Performance mode. In the Voice Edit mode keys [1] through [8] can be used to directly select the various edit displays.

EX5R

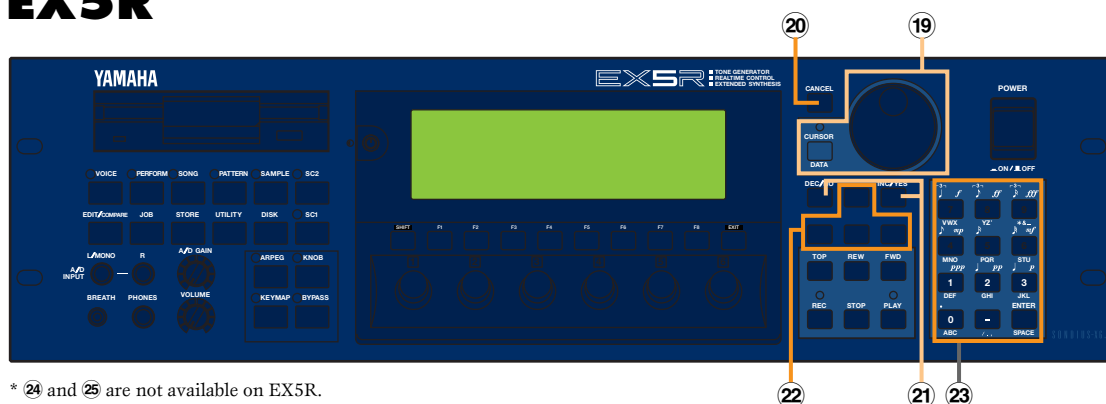

* 24 and 25 are not available on EX5R.

Rear Panel

EX5

26 [POWER] Switch

Press to turn power ON or OFF. The EX5 and EX7 power switch is located on the rear panel near the AC power cord socket. The EX5R power switch is located on the front panel.

28 INDIVIDUAL OUTPUT 1 and 2 Jacks (EX5 and EX5R only)

In addition to the stereo OUTPUT L/MONO and R jacks, the EX5 and EX5R initially have two individual outputs: the INDIVIDUAL OUTPUT 1 and 2 jacks. Individual “parts” of a performance setup can be assigned to different individual outputs via the PERFORMANCE EDIT mode PART display (see page 164). Four individual outputs can be added to the EX5, EX5R, and EX7 by installing the optional EXIDO1 Individual Output Board (page 19.)

29 A/D INPUT L/MONO and R Jacks (A/D INPUT on the EX7)

Line and microphone sampling sources can be connected to these jacks. Line or microphone input sensitivity is switched via the “line/mic” parameter in the Sample mode REC display (page 176), and fine input sensitivity adjustment can be carried out via the A/D GAIN control on the control panel. ➔ See page 70 for more information.



27 AC Power Cord Socket

Be sure the plug the AC power cord into this socket before plugging the power cord into an AC outlet. Use only the AC power cord supplied with the EX5, EX5R, or EX7. If the supplied cord is lost or damaged and needs to be replaced, contact your Yamaha dealer. The use of an inappropriate replacement can pose a fire and shock hazard!

30 MIDI IN, OUT and THRU Connectors

The MIDI IN connectors receive data from an external sequencer or other MIDI device which is to control or transmit data to the EX. The MIDI THRU connector simply re-transmits the data received at the MIDI IN connector, allowing convenient chaining of MIDI devices. The MIDI OUT connectors transmit data corresponding to all EX performance and playback operations.

The EX5 is equipped with two sets of MIDI terminals: MIDI A and MIDI B. The MIDI A group includes MIDI IN, OUT, and THRU terminals, while the MIDI B group only has MIDI IN and OUT terminals.

➔ See page 22 for more information.

EX7

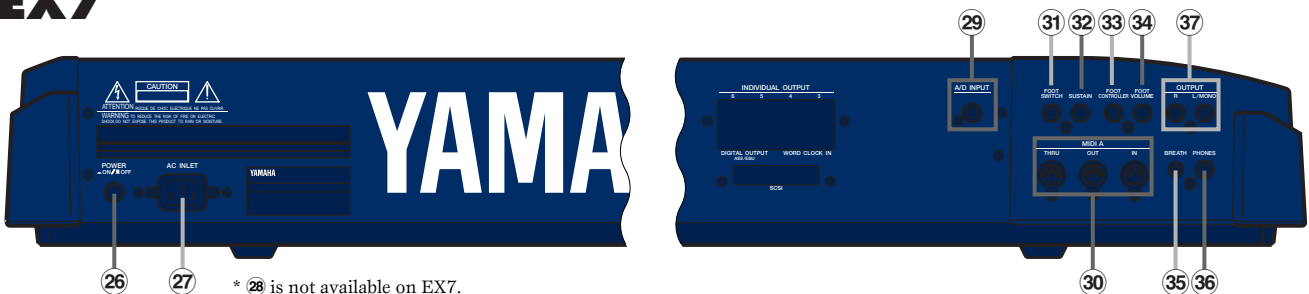

* 28 is not available on EX7.

31 FOOT SWITCH Jack

(EX5 and EX7 only)
An optional Yamaha FC4 or FC5 footswitch can be connected to this jack to control a range of on/off type functions: sustain, sostenuto, portamento, and others.
➔ See page 17 for more information.

32 SUSTAIN Jack

(EX5 and EX7 only)
An optional Yamaha FC4 or FC5 footswitch can be connected here for sustain control.

33 FOOT CONTROLLER Jack

(EX5 and EX7 only)
This jack accepts a Yamaha FC7 Foot Controller which can be used to control any of the EX controller parameters.
➔ See page 17 for more information.

34 FOOT VOLUME Jack

(EX5 and EX7 only)
A Yamaha FC7 Foot Controller can be plugged in here for convenient foot volume or expression control.

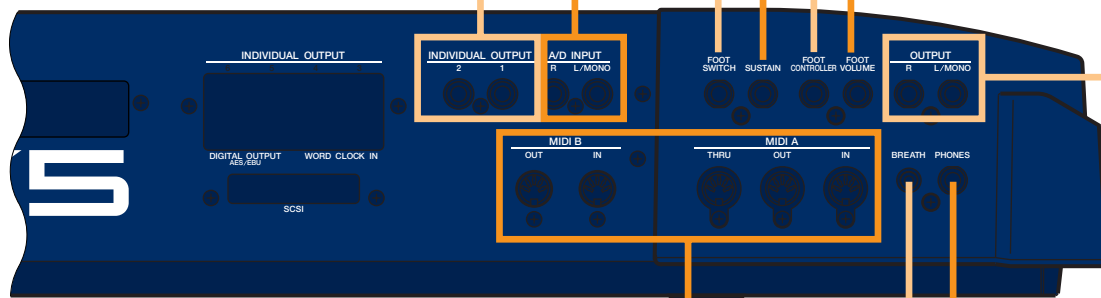

35 Breath Controller Jack

Plug an optional Yamaha BC3 Breath Controller in here for expressive breath control capability.
➔ See page 56 for more information.

36 PHONES Jack

Accepts a standard pair of stereo headphones (1/4" stereo phone plug) for headphone monitoring of the EX sound without the need for external amplification equipment. The EX5R PHONES jack is on the front panel.

37 OUTPUT L/MONO and R Jacks

These are the main stereo outputs from the EX5, EX5R, and EX7. Be sure to connect both outputs to the appropriate channels of a stereo sound system in order to appreciate the full quality of the EX sound and effects. Connect only the L/MONO jack when connecting to a mono sound system.

EX5R Front

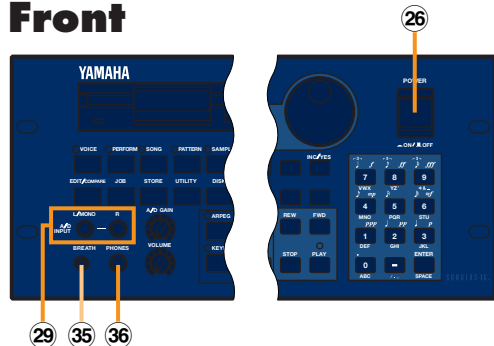

Rear

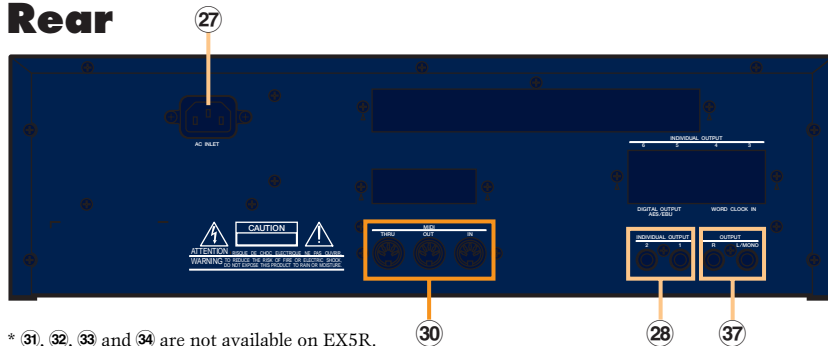

* 31, 32, 33 and 34 are not available on EX5R.

Setting Up

The EX5 or EX7 can be used virtually on its own — with a pair of headphones or a simple instrument amplifier — or it can be the core of complex and powerful music production system. Naturally, the EX5R Tone Generator will require an external MIDI keyboard or other controller.

Power Supply

Before making any other connections the “female” end of the AC power cord supplied with the EX5, EX5R, and EX7 should be firmly plugged into the rear-panel AC cord socket. Ideally the power cord should then be plugged into a convenient AC outlet after you've made all other necessary connections and placed the EX5, EX5R, or EX7 in the position in which it will be used. Always make sure that the POWER switch is in the OFF (extended) position before plugging the power cord in an AC outlet.

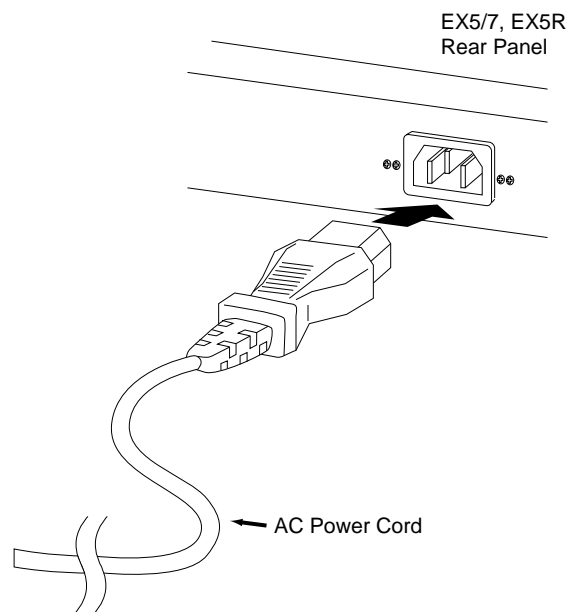

WARNING!

Make sure your EX5, EX5R, or EX7 is rated for the AC voltage supplied in the area in which it is to be used (as listed on the rear panel). Connecting the unit to the wrong AC supply can cause serious damage to the internal circuitry and may even pose a shock hazard!

Use only the AC power cord supplied with the EX5, EX5R, or EX7. If the supplied cord is lost or damaged and needs to be replaced, contact your Yamaha dealer. The use of an inappropriate replacement can pose a fire and shock hazard!

The type of AC power cord provided with the EX5, EX5R, or EX7 may be different depending on the country in which it is purchased (a third prong may be provided for grounding purposes). Improper connection of the grounding conductor can create the risk of electrical shock. Do NOT modify the plug provided with the EX5/EX5R/EX7. If the plug will not fit the outlet, have a proper outlet installed by a qualified electrician. Do not use a plug adapter which defeats the grounding conductor.

External Controllers

In addition to the many realtime controllers provided on the EX5 and EX7 panel (the PITCH wheel, MODULATION 1 wheel, MODULATION 2 wheel and Ribbon Controller), plus the six Controller Knobs provided on the EX5, EX5R and EX7, a number of additional controllers can be plugged into the appropriate rear-panel jacks as required.

■ Foot Switches (EX5 and EX7)

At the very least you'll probably want to plug a footswitch into the SUSTAIN jack for piano-type sustain control. You might also want to plug a second footswitch into the FOOTSWITCH jack to control other on/off type functions such as sostenuto, portamento, or arpeggio hold for the sophisticated automatic arpeggiator feature. Footswitch functions are assigned via the UTILITY mode, as described on page 275.

■ Foot Controllers (EX5 and EX7)

The EX5 and EX7 have jacks for two optional Yamaha FC7 Foot Controller units: FOOT VOLUME and FOOT CONTROLLER. An FC7 plugged into the FOOT VOLUME jack can be used (as its name implies) for main volume or expression control. The desired FOOT VOLUME function can be selected via the UTILITY mode Controller display, as described on page 275. An FC7 plugged into the FOOT CONTROLLER jack can be assigned for continuous realtime control of a wide range of parameters (pages 104 and 163).

NOTE For more information on Foot Controller setup and operation, see the instructions packed with the supplied FC7 Foot Controller.

■ Breath Controller

A Breath Controller can be an essential expressive tool for realistic expression with wind-instrument type voices and unprecedented expressive control with other voices. Plug an optional BC3 Breath Controller into the BREATH jack. The Breath Controller is ideal for controlling parameters that would normally be affected by a wind player's breath: dynamics, timbre, pitch, and others.

NOTE For more information on Breath Controller setup and operation, see the instructions packed with the optional BC3 Breath Controller.

Audio Connections

■ Headphones

For private listening and practice headphones are ideal. You don't have to hook up and complete sound system, and you won't disturb the neighbors no matter how loud or late you play. Recommended Yamaha headphones for EX monitoring are the HPE-170, HPE-160, or HPE-150 Stereo Headphones. Any standard pair of stereo headphones with a 1/4" stereo phone plug can be used.

■ Instrument Amplifier or Stereo Sound System

The EX voices and effects are designed to sound their best in stereo, so you should always use a stereo sound system to appreciate the full impact of the EX voices and expressive features. The OUTPUT L/MONO and R jacks can be connected directly to musical instrument amplifiers designed for keyboard use, or to the line inputs of a mixing console. It is also possible to connect the outputs directly to the inputs of a multitrack or stereo tape recorder. When connecting to a mono sound system be sure to use only the OUTPUT L/MONO jack.

NOTE Make sure that both the EX and your sound system are turned OFF when making connections.

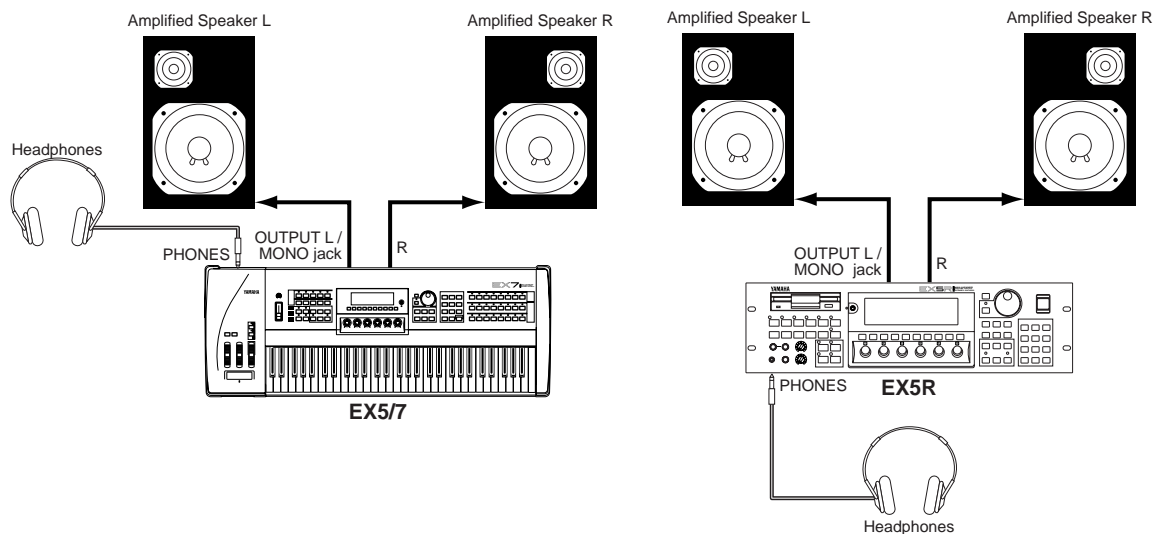

■ Mixing Console

In addition to the stereo OUTPUT L/MONO and R jacks, the EX5 and EX5R initially have two individual outputs: the INDIVIDUAL OUTPUT 1 and 2 jacks. An additional four individual outputs (3 through 6) can be added by installing the optional EXIDO1 Individual Output Board. The stereo and individual outputs can be fed to separate channels of a mixing console for individual processing. Individual “parts” of a performance setup can be assigned to different individual outputs via the PERFORMANCE EDIT mode PART display (see page 164).

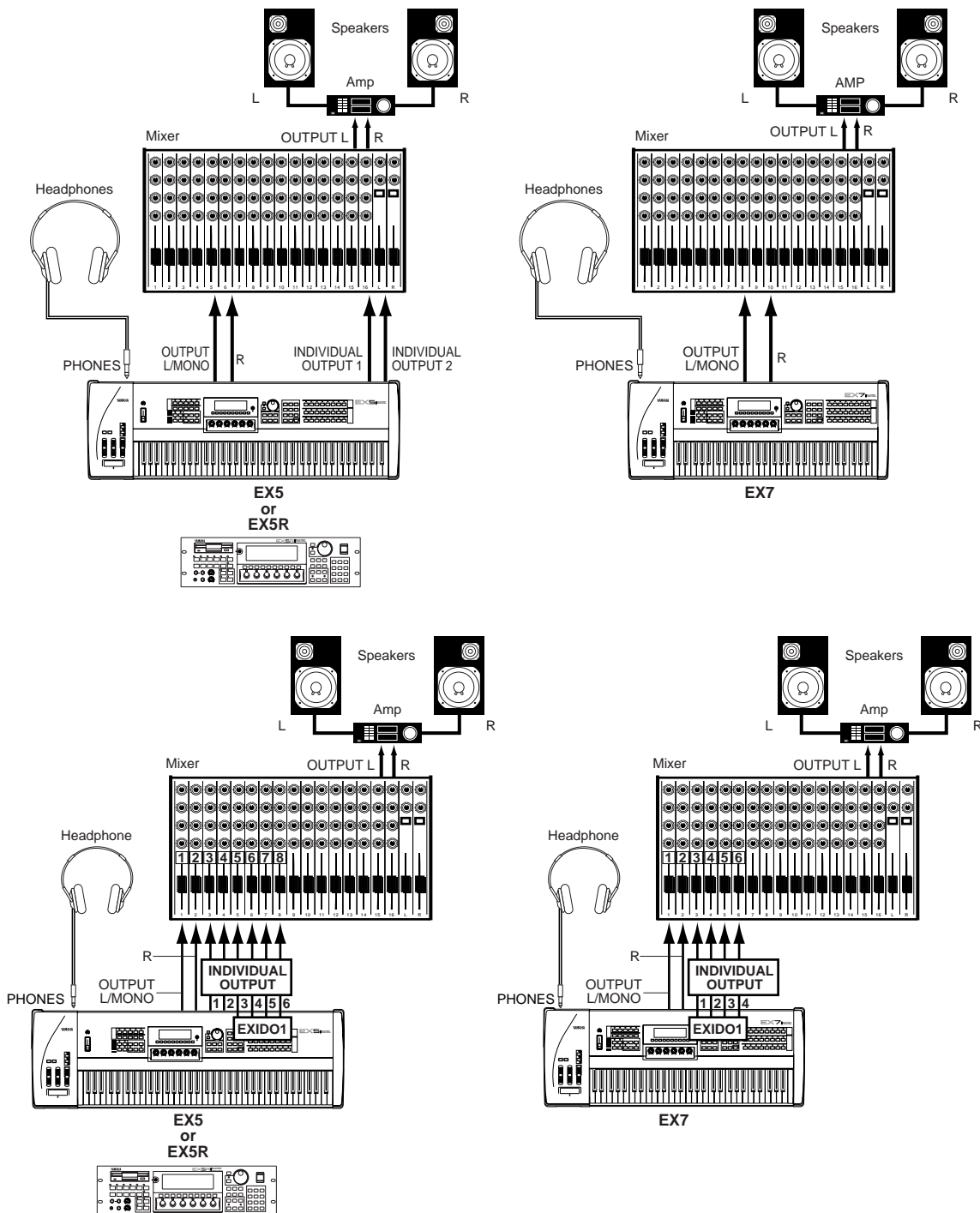

NOTE See page 278 for details on installation of the EXIDO1 Individual Output Board.

NOTE The EXIDO1 Individual Output Board and EXDGO1 Digital Output Board use the same option slot, so only one can be installed at a time.

■ Digital Audio (Option)

The optional EXDGO1 Digital Output Board provides an AES/EBU-format digital output which can be directly connected to an external digital recorder, mixing console, or other digital processing equipment. This allows the EX sound to be recorded or processed with maximum quality. The EXDGO1 Digital Output Board also includes a WORD CLOCK IN connector for precise digital audio synchronization with the external digital devices.

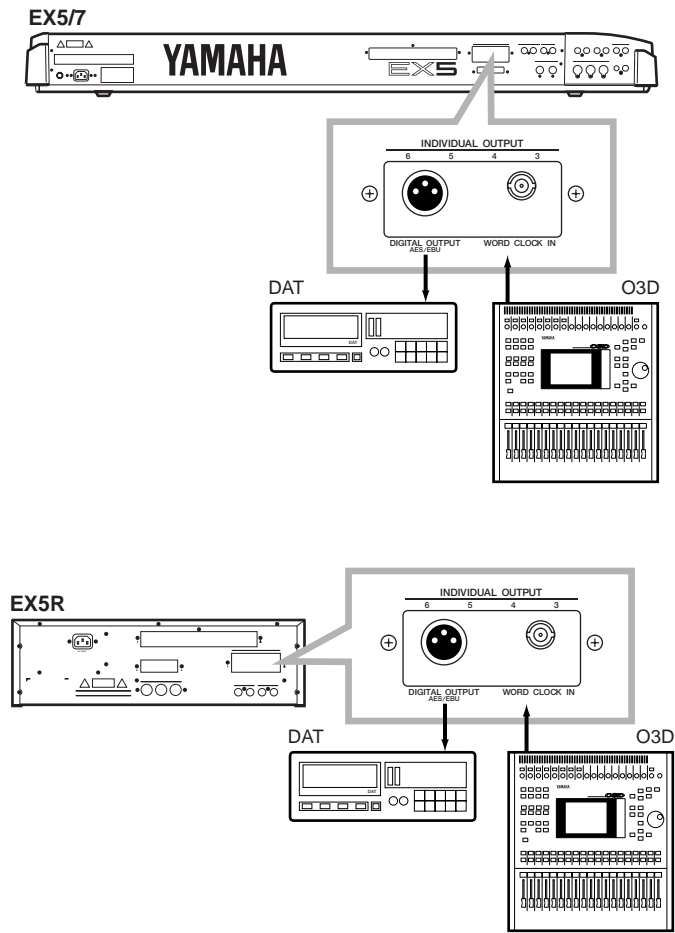

- NOTE** See page 278 for details on installation of the EXDGO1 Digital Output Board.
- NOTE** The EXDGO1 Digital Output Board and EXIDO1 Individual Output Board use the same option slot, so only one can be installed at a time.
- NOTE** When connecting the EXDGO1 (Digital Output AES/EBU [XLR] jack) and an external audio device, use the XLR cable with the impedance characteristics, 110 Ω .
- NOTE** When receiving word clock from an external audio device, you are required to connect the EXDGO1 (Word Clock In [BNC] jack) and the external audio device. In this case, use the BNC connector/coaxial cable with the impedance characteristics, 75 Ω .

External Sampling Sources

The Sampling mode can be used to sample external audio sources as well as internal voice data. The external source can be either a line-level source such as a CD player or other audio playback device, or a microphone for direct sampling of live sound. Line and microphone sources should be connected to the AD INPUT jacks. Line or microphone input sensitivity is switched via the “line/mic” parameter in the Sample mode REC display (page 176), and fine input sensitivity adjustment can be carried out via the A/D GAIN control on the control panel. See page 70 for details.

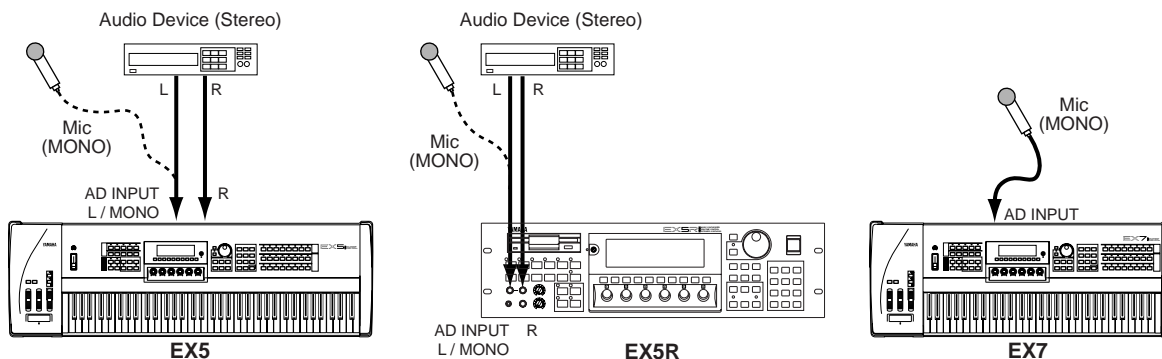

SCSI Interface (Option)

When the optional ASIB1 SCSI Interface Board is installed (see page 278) the EX5, EX5R, or EX7 can be connected directly to an external SCSI data storage device for high-speed, high-volume data storage and retrieval, and/or to a personal computer to allow data transfer between the EX and the Yamaha Wave Editor application (separately available) running on the computer.

When connected to an appropriate external storage device — hard disk, ZIP, or JAZZ drive (see “NOTES,” below) — the storage device can be formatted by the EX5, EX5R, or EX7 via the Disk mode Device Format display (page 269). Voice, performance, song, pattern, arpeggio, wave and other data can then be saved to and loaded from the hard disk as required via the Disk mode functions described on page 259.

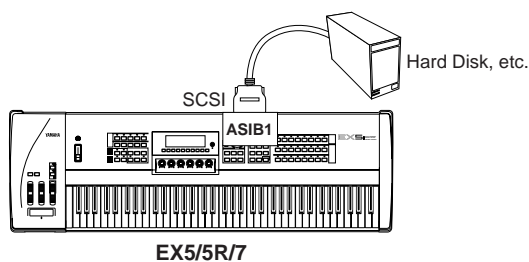

When connected to a personal computer (MacOS® or Windows®), either directly or “chained” via an external hard disk (see “NOTES” regarding SCSI ID numbers, below), wave data can be transferred from the EX5, EX5R, or EX7 to the computer, edited using the Yamaha Wave Editor TWE application (separately available), and then transferred back to the EX5, EX5R, or EX7.

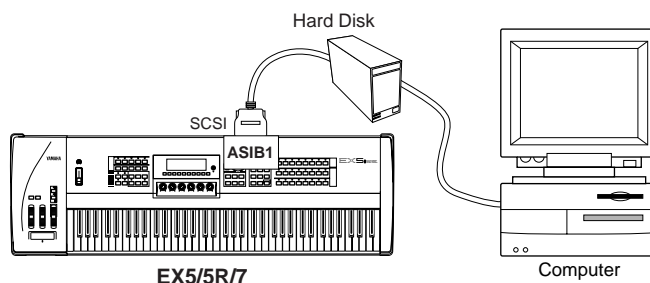

NOTE See page 278 for details on installation of the ASIB1 SCSI Interface Board.

NOTE Please note that since the EX5, EX5R, and EX7 use a proprietary data format, the external hard disk must be formatted by the EX5, EX5R, or EX7 to allow direct data storage and retrieval. The EX5, EX5R, or EX7 will not directly write to or read from a hard disk formatted by any other computer or device, and vice-versa.

NOTE When connecting the EX5, EX5R, or EX7 to a personal computer and/or hard disk via the SCSI interface, make sure that the EX5, EX5R, or EX7 SCSI ID number — set via the UTILITY mode Other Setup display (page 276) — does not conflict with any other SCSI device in the SCSI chain. In other words, no two devices in the SCSI chain should be set to the same SCSI ID number.

NOTE The ASIB1 SCSI Interface Board only has a single SCSI connector and thus must be connected at the end of the SCSI chain (the ASIB1 interface is internally terminated).

MIDI Connections

Like any other MIDI instrument the EX5, EX5R, and EX7 can be used with MIDI tone generators, sequencers, computer software, and controllers for virtually unlimited system expansion and control capability. You might, for example, like to control it from a Yamaha wind controller such as the WX11 rather than the keyboard for even more realistic wind-instrument feel and expression.

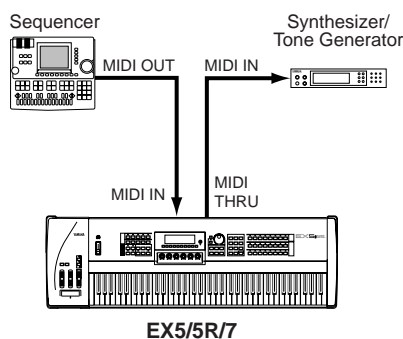
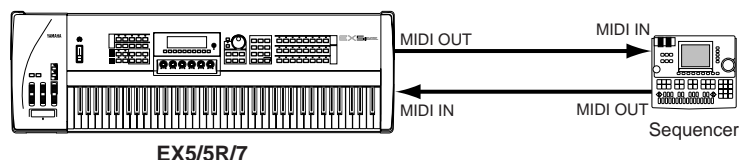

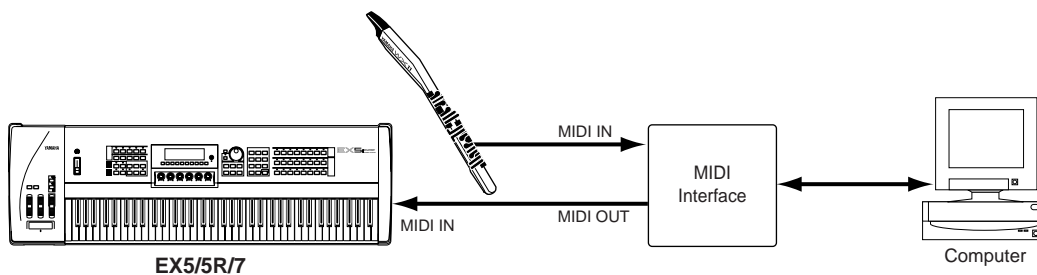

The EX5R Tone Generator will additionally require an external MIDI master keyboard or other MIDI controller.

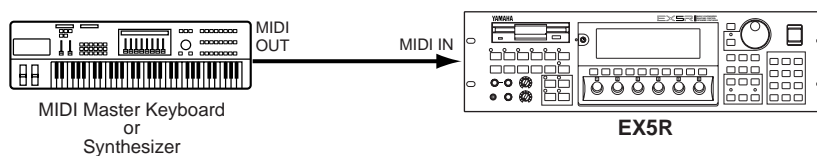

To ensure reliable error-free transmission of MIDI data always use high-quality MIDI cables obtained from your Yamaha dealer or music equipment store. Also avoid MIDI cables that are longer than about 15 meters, since cables longer than this can pick up noise which can cause data errors.

The EX MIDI receive channel, device number, local on/off, and other parameters are available in the UTILITY mode MIDI display described on page 274. Make sure these parameters are set to match the corresponding settings of the external MIDI device(s) used.

NOTE For detailed MIDI specifications refer to the “MIDI Data Format” in the Data List book.

NOTE When using the EX5, EX5R, or EX7 with other MIDI equipment, it is a good idea to refer to the MIDI specifications (implementation chart, MIDI data format) of the equipment used to ensure compatibility.

Power-on Procedure

Always follow proper procedure when powering-up a sound system to minimize the possibility of damage to the equipment (and your ears!).

- 1 Make sure your sound system's main level/volume control(s) and the EX volume control are turned all the way down prior to turning power on.
- 2 Turn on the EX5, EX5R, or EX7.

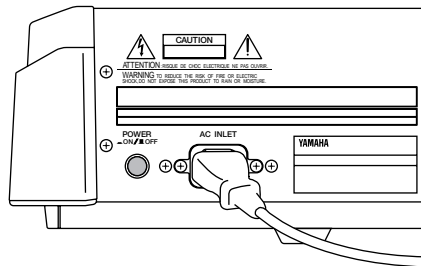

EX5/7

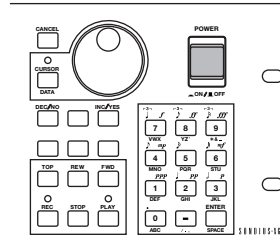

EX5R

- 3 Turn on the sound system.

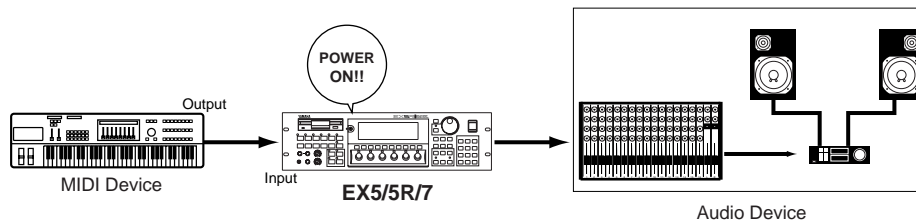

- 4 Raise the sound system volume to a reasonable level.
- 5 Gradually raise the EX VOLUME control while playing the keyboard to set the desired listening level.



EX5/7



EX5R

NOTE The EX5, EX5R, and EX7 automatically transmits MIDI control change data corresponding to its control status when its power switch is turned ON or OFF. This can interfere with operation of other MIDI equipment connected to the EX MIDI OUT connectors. If the EX5, EX5R, or EX7 is transmitting MIDI data to other MIDI equipment, the EX power switch should be turned ON before, and turned OFF after the power switch(es) of the receiving MIDI device(s).

The Supplied Disks, Demos & Factory Set Data

The EX5, EX5R, and EX7 are supplied with four Demonstration Disks containing various types of pre-programmed demo data which will give you an idea of some of their advanced capabilities, as well as provide a number of programming examples that may help you to create the type of sound you need. Each disk contains an all-data file (suffix “.S1A”) containing a demonstration song, and a Factory Set file (file name: “FACTSET1/2/3/4.S1Y”) containing the original factory pre-programmed voices and performance setups.

Try loading these files and playing the songs, patterns, arpeggios, voices, performance setups, or samples they contain. Full disk loading details are provided on page 259, but to get you started, here’s the procedure for loading and playing the demo songs.

NOTE For information on restoring the Factory Set data, see “Restoring the Factory Set Data,” below.

Load and Play the Demo Songs

1 Insert the Demonstration Disk

Insert the Demonstration disk in the EX floppy disk drive (shutter first, label side up).

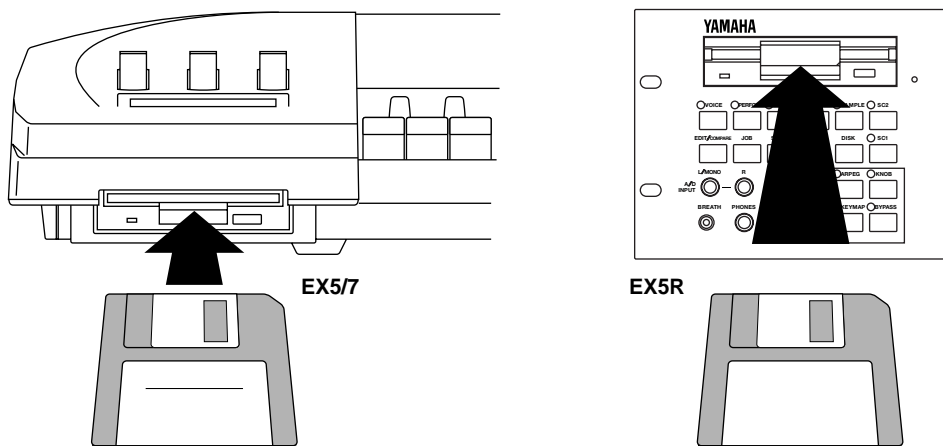

2 Engage the Disk mode

Press the [DISK] key to engage the Disk mode.

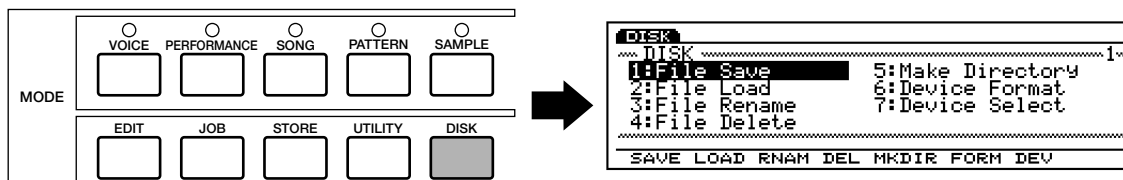

3 Select File Load

Press the [F2] function key to go to the File Load menu.

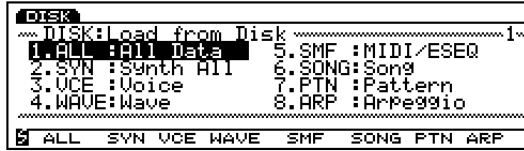

4 Select All Data

Press the [F1] function key to select All Data. Please note that all-data files have the suffix “.S1A” appended to the file name.

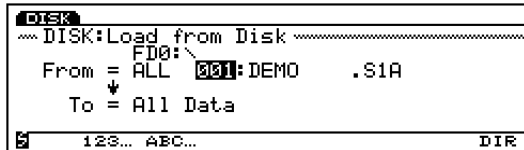

5 Select a file and load

Use the Data Dial, [DEC]/[INC] keys, or numeric keypad to select a file number (all of the files on the Demonstration disk contain different demo songs), then press the [ENTER] key. A confirmation display will appear.



Press the [INC/YES] key to confirm and load the data.

6 Play the song

When the file has finished loading, first press the [PERFORM (ANCE)] key to select the Performance mode, next press the [SONG] key to go to the Song mode, and then press the sequencer PLAY [▶] key to start playback of the loaded demo song. Playback will stop automatically when the song has finished, but you can also stop playback at any time by pressing the STOP [■] key.

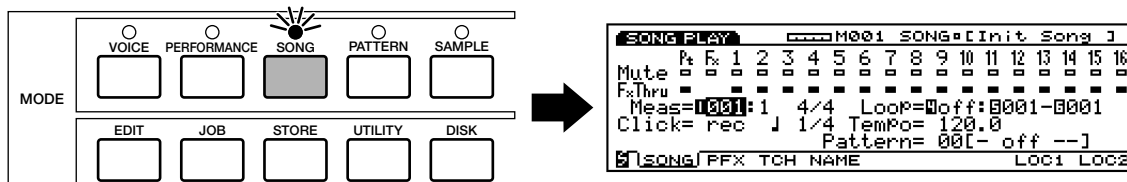

IMPORTANT Before playing “DEMO2” song, press the [KEYMAP] key to engage the Key Map mode. To Play the Demonstrations other than “DEMO2,” always turn the Key Map mode off (pressing the [KEYMAP] key again cancels the Key Map mode).

7 Try other demo files

Go back to the Disk mode and load other files to play the songs they contain.

Restoring the Factory Set Data

In addition to the preset voices (which cannot be erased or overwritten), the EX5, EX5R, and EX7 come with a range of pre-programmed voices, performance setups, and other data in memory. If you perform any operations that overwrite the data in memory (including system initialization, below), the factory preset data will be lost. If at any time you want to restore the original factory preset data, simply load the Factory Set file — file name: “FACTSET1/2/3/4.S1Y” — from the appropriate Demonstration Disk via the Disk mode Load Synth All function (the same procedure described above except for the file type selection [2. SYN, in this case] for loading the demo song files).

```

DISK:
-----
DISK:Load from Disk
FD0:\
From = SYN 001:FACTSET1.S1Y
↓ All Data
To = All Data
123... ABC... DIR
  
```

Loading the Factory Set data will overwrite any other data in the EX voice and performance memories! Be sure to save any internal voices or performances setups you want to keep to disk before loading the Factory Set data.

NOTE Each of the Demonstration Disk contains different Factory Set files (their contents are the same except for the voices numbered 1 through 32 in the Internal voice 1). Refer to the separate Data List book (Internal Voice 1) and choose the disk which contains the appropriate file for your EX5, EX5R or EX7.

System Initialization

To completely erase all data in the EX internal memory and initialize the entire system, turn on the power while holding the [EXIT] key.

System initialization will erase all data in the EX voice and performance memories! Be sure to save any internal voices or performances setups you want to keep to disk before initializing the system.

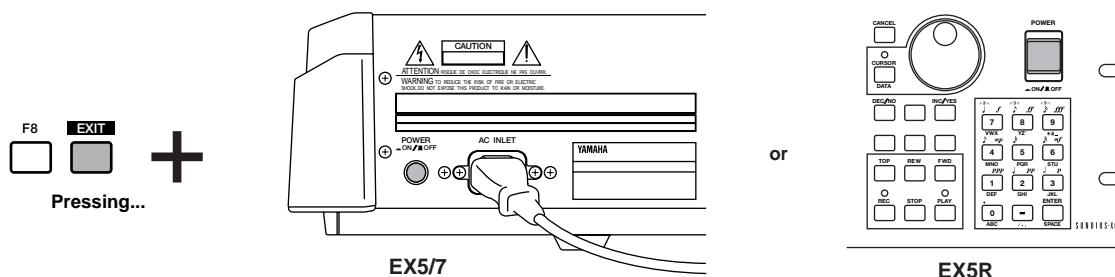

EX System Overview

The EX system can be broadly categorized into four main blocks, as shown in the diagram below:

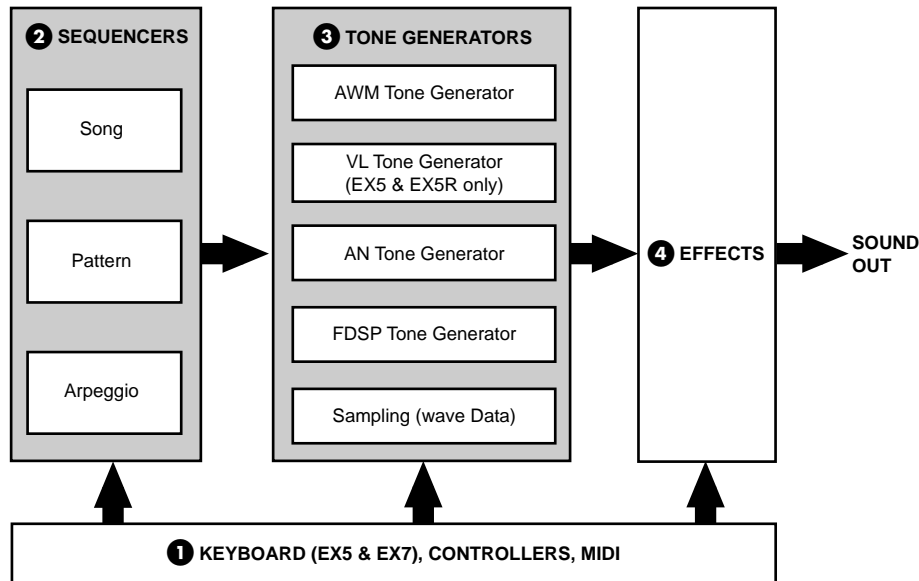

1 The keyboard, controllers, and MIDI control.

The EX5 and EX7 feature keyboards (76 and 61 keys, respectively) and a range of realtime controllers not available on the EX5R Tone Generator. Full control is available on the EX5R, however, via a MIDI master keyboard or other MIDI controller.

2 The sequencers: Song, Pattern, and Arpeggiator.

The EX5, EX5R and EX7 feature a range of sequencing functions that give them many of the capabilities of a sophisticated music production system without the need for any extra equipment.

NOTE See pages 185, 219 and 238 for more information.

3 The tone generators: AWM, VL (EX5/5R only), AN, and FDSP.

Extended Synthesis is simply the most powerful array of tone generation technologies ever provided in a single keyboard or tone generator unit. Whether you need the outstanding sound and programmability of AWM synthesis, the unmatched playability and musical response of VL synthesis (EX5 and EX5R only), beefy analog synthesizer voices, or the most responsive effects and simulated resonant systems available, you need look no further.

The EX5, EX5R, and EX7 also feature a built-in sampling system which is capable of sampling sounds from external sources (line or microphone) as well as internal voices.

NOTE See pages 77, 107, 112 and 123 for more information.

4 Effects.

The EX effect system is a top-quality digital signal processing system which is capable of producing effects rivalling and even exceeding those of many separate component effect units in quality. In the EX5, EX5R, and EX7, effect programming is an integral and important part of voice programming, and the ability to control specific effect parameters in real time makes them indispensable for expressive control as well.

NOTE See page 65 for more information.

Extended Synthesis

Over the years Yamaha has developed a range of industry-leading music synthesis technologies, each with its individual strengths and advantages. The EX5, EX5R, and EX7 take an innovative step forward by combining multiple state-of-the-art Yamaha tone generation technologies in one extraordinarily versatile instrument. When you need the outstanding sound and programmability of AWM synthesis, it is there. When you need the unmatched playability and musical response of VL synthesis (EX5 and EX5R only), it is right at your fingertips. When you want a beefy analog synthesizer voice, you don't even have to change keyboards. And when you want the most responsive effects and simulated resonant systems available, you need look no further.

This is Extended Synthesis: simply the most powerful array of tone generation technologies ever provided in a single keyboard or tone generator unit.

NOTE About the polyphony of each tone generator, see page 45.

AWM Synthesis

AWM, or “Advanced Wave Memory,” is Yamaha’s original system for effectively using sampled waveforms in synthesizers and tone generators. Although the basis for all AWM voices is a sampled waveform — a sample of a “real” existing instrument, a classic synthesizer sound, or other electronically created sounds — the AWM system provides an extensive range of envelope generator, filter, modulation, and other parameters which can be applied to the basic waveform. Furthermore, up to four elements, each with its own “wave” and a complete set of editable parameters, can be assigned to each voice. The strength of AWM synthesis lies not only in its outstanding sound quality (it uses 16-bit, 44.1 kHz samples), but also in its extraordinary ability to “shape” and control the sound of the samples.

AWM synthesis also allows the creation of “drum voices” in which different drum and percussion instruments with individual volume, pitch, and timbre parameters can be assigned to individual notes of the keyboard (from C-2 through G8).

The EX5, EX5R, and EX7 feature a built-in sampling system which is capable of sampling sounds from external sources (line or microphone) as well as internal voices. Waveforms sampled using this feature can be used in AWM voices, so your capacity to create totally new AWM voices is truly unlimited.

■ AWM System Overview

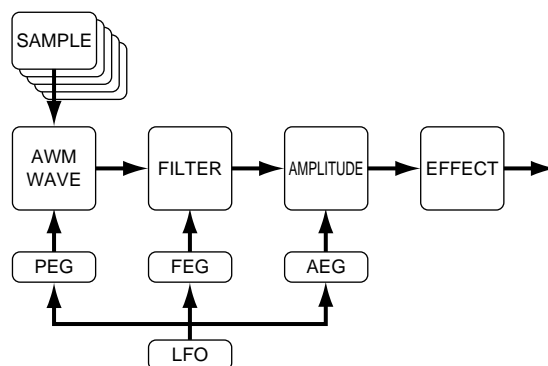

■ Layered AWM Voices

In AWM voices up to four AWM elements can be layered to create extraordinarily rich voice textures.

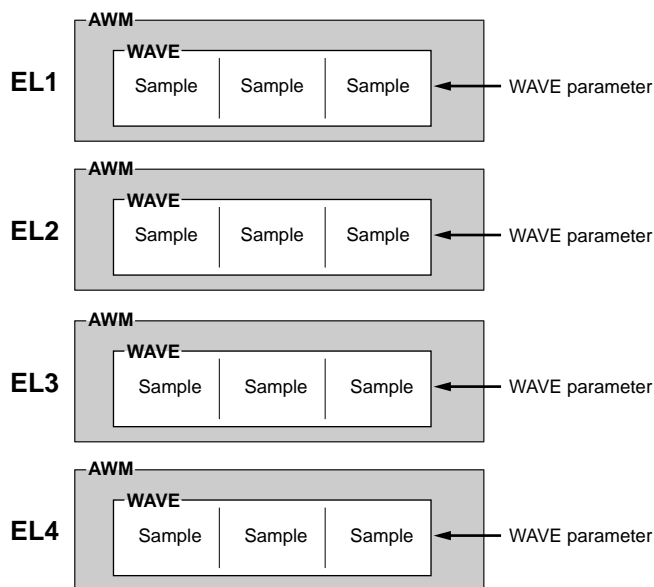

Virtual Acoustic Synthesis (EX5 and EX5R only)

Yamaha's Virtual Acoustic ("VL") Synthesis tone generation system does not use oscillators, function generators, preset waveforms or samples to produce sound. Rather, it applies sophisticated computer-based "physical modeling" technology to musical sound synthesis. In the same way that computer "models" are used to simulate weather systems or the flight characteristics of aircraft in the design stage, the VL system simulates the very complex vibrations, resonances, reflections and other acoustic phenomena that occur in a real wind or string instrument.

VL synthesis offers many advantages in terms of musical performance. Not just in terms of sound, but also in terms of the "behavior" that makes acoustic instruments so "musical." For example, simply playing a note in the same way does not always produce precisely the same sound — the instrument is responsive and "alive." Rather than simply controlling parameters like volume or pitch, you can control characteristics such as breath and reed pressure with appropriate complex effects on the timbre of the sound.

■ The VL "Instrument" or "Wave"

The VL "instrument" or "wave" defines the fundamental tone or timbre of the sound. The instrument model consists primarily of a driver — the reed/mouthpiece, lip/mouthpiece, or bow/string system — and a resonant system corresponding to the tube and air column or string. One of the remarkable features of the Virtual Acoustic Synthesis system is that just about any driver can be used with any type of pipe or string. The EX5/5R provides a range of 272 preset VL "waves" which integrate all of the necessary characteristics, and which can be assigned to voice elements in much the same way as AWM waves (VL voices can have 1 VL element plus up to 3 AWM elements).

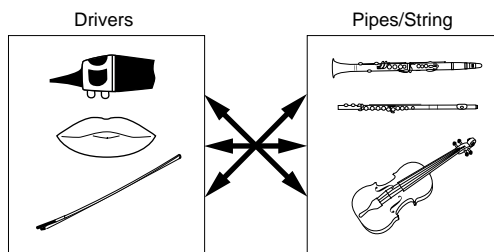

■ Controllers & Modifiers

The input to an acoustic wind instrument comes from the player's lungs, trachea, oral cavity, and lips. In a string instrument it comes from the player's arm movement, transmitted to the string via a bow. These factors actually form an important part of the sound generating system and, in the VL model, are known as “controllers” (note that these are parameters, not physical controllers like the modulation wheels or knobs). The player also influences the sound of the instrument by playing the keys, tone holes, or frets, and this aspect of control constitutes another part of the “controllers” system.

In essence, the controller parameters determine how the instrument “plays.” All of these parameters can be assigned to any external controller that can be used with the EX5 and EX5R: Foot Controller, Modulation Wheel, Controller Knobs, Ribbon Controller, Breath Controller, etc. The pressure parameter, for example, could be assigned to a breath controller so the player can control the dynamics of the instrument by varying the breath pressure applied to the controller — a natural, instinctive way to play wind-instrument voices. At the same time the growl and throat parameters might also be assigned to the breath controller in order to achieve life-like response and effects.

Modifiers, such as the Harmonic Enhancer and Dynamic Filter, are applied after the VL controllers. Although these may appear to be simple effects, they are actually intimately related to the VL sound-producing model and have a significant effect on the sound.

Some of the controller and modifier parameters provided by the EX5 and EX5R are listed in the chart below.

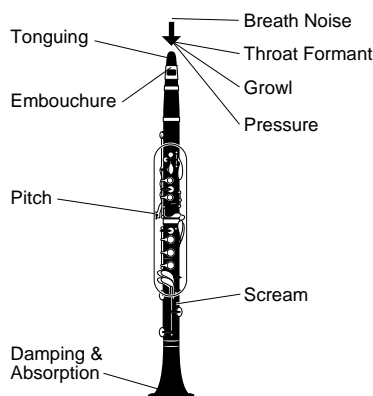

Throat Formant	Controls the characteristics of the "player's" throat or bowing arm.
Pressure	The amount of breath pressure applied to the reed or mouthpiece, or bow velocity applied to the string.
Growl	A periodic pressure (bow velocity) modulation which produces the "growl" effect often heard in wind instruments.
Embouchure	The tightness of the lips against the reed or against each other, or the force of the bow against the string.
Tonguing	Simulates the half-tonguing technique used by saxophone players by changing the "slit" of the reed.
Pitch	Changes the length of the air column or string, and thereby the pitch of the sound.
Scream	Drives the entire system into chaotic oscillation, creating effects that can only be achieved with physical modelling technology.
Breath Noise	Adds breath noise to produce exceptionally realistic effects with many wind instruments.
Damping & Absorption	Simulates the effects of air friction in the pipe or on the string, and of high-frequency losses at the end of the pipe or string.
Harmonic Enhancer	The Harmonic Enhancer determines the harmonic structure of the sound to the extent that it can produce radical timbral variations within an instrument "family" (e.g. saxes).
Filter	This modifier is similar to the dynamic filters found in many conventional synthesizers, with high-pass, bandpass, band elimination, and low-pass modes.

■ VL System Overview

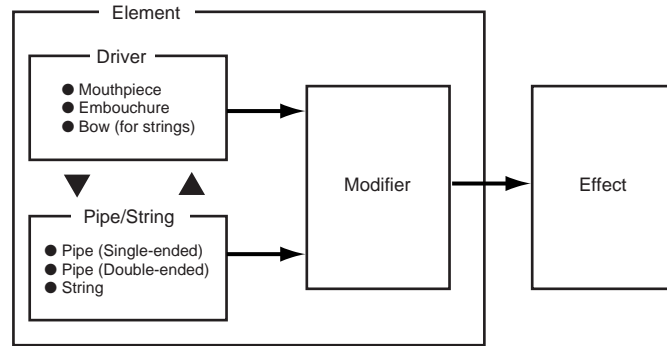

■ VL + AWM Voices

A single VL element can be combined with up to three AWM elements.

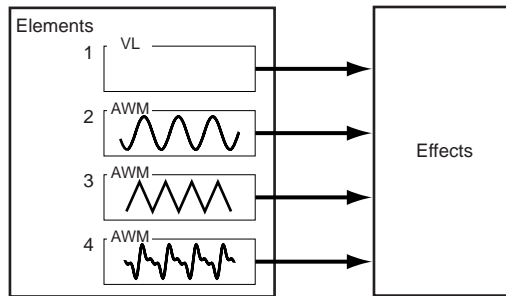

AN Synthesis (Analog Physical Modeling)

Although synthesizers have come a long way since the days of VCOs (Voltage Controlled Oscillators), VCFs (Voltage Controlled Filters), and VCAs (Voltage Controlled Amplifiers), modern digital tone generators can't quite reproduce the punch, power, and interactive control capabilities of such older systems. Yamaha AN Synthesis (Analog Physical Modeling), however, offers all the benefits of traditional analog synthesis with the stability, reproducibility, and precise control of digital technology. It is capable of accurately reproducing the sound of classic analog synthesizer without patch cables, setting charts, or the frustrating instability that was the bane of the analog age. AN Synthesis also offers many features that were simply not possible in pure analog systems. It is, for example, also capable of FM synthesis similar to the type that made the legendary Yamaha DX7 one of the most popular synthesizers of all time. In addition to single-element AN voices, the EX5 and EX5R allow two AN elements to be layered to create even thicker analog synth sounds.

■ AN System Overview

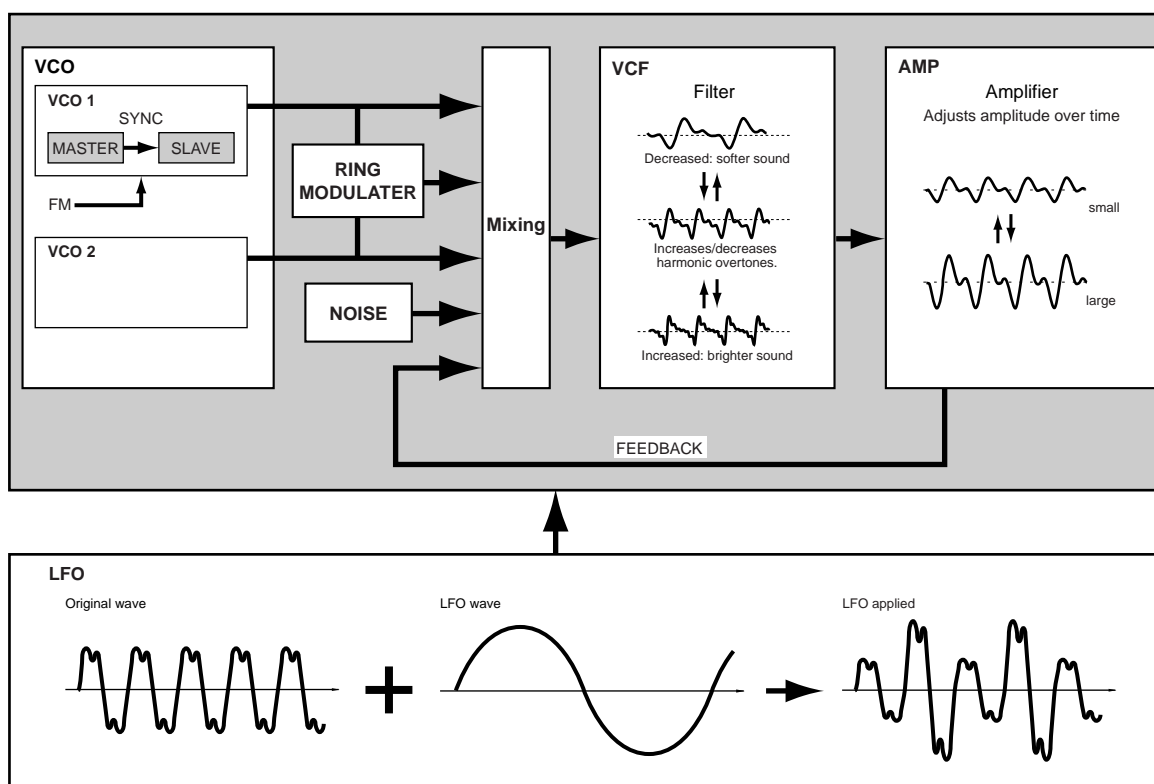

■ **AN (Poly)+AWM Voices**
 ■ **AN (Layer)+AWM Voices**

As shown in the diagrams below, a single AN element can be combined with up to three AWM elements in AN(Poly) + AWM voices. In the EX5 and EX5R, two AN elements can be combined with up to two AWM elements in AN(Layer) + AWM Voices. AN + FDSP voices are described in the FDSP Synthesis section, below.

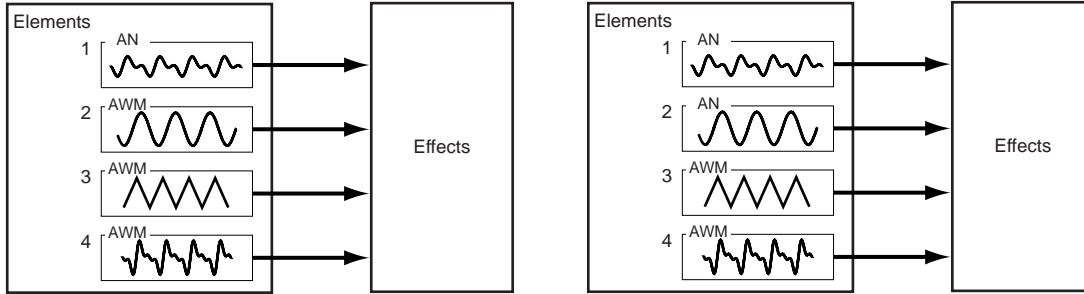

FDSP Synthesis (Formulated Digital Signal Processing)

FDSP, or “Formulated Digital Sound Processing,” is actually an adjunct to AWM synthesis. It adds a sophisticated note-dependent effect processor to the basic AWM synthesis system. In contrast to a standard effect stage, the FDSP synthesis stage uses individual note and velocity data to control effect parameters, thus making it possible to simulate the characteristics of a number of real-world musical components, as well as produce totally new effects. For example, FDSP can effectively model the frequency and velocity dependent characteristics of electromagnetic guitar or piano pickups, thus adding more realistic response to these types of voices, or adding a whole new dimension to other sounds. It can also alter the delay time of flange or chorus type effects according to the note played, thus producing totally new sounds that are responsive and “alive.” Many other effects are possible.

■ **FDSP System Overview**

This block diagram is only one example of an FDSP configuration. In this case the FDSP system is used to model the response of an electric guitar pickup.

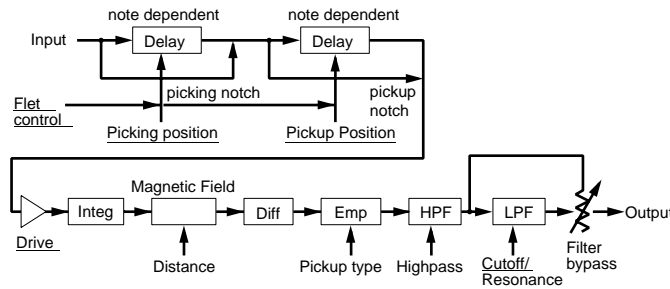

■ FDSP Voice Element Structure

In an FDSP voice up to four AWM elements can be fed to the FDSP stage or routed directly to the normal effect stage as required.

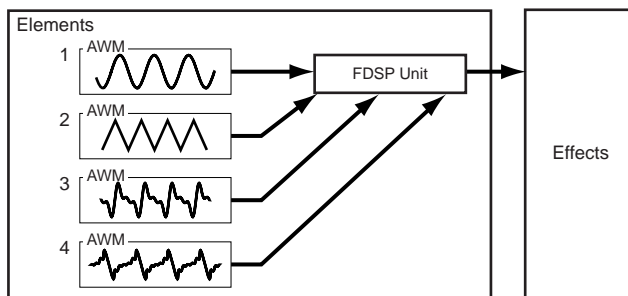

■ AN+FDSP Voices

AN + FDSP voices allow a single AN element to be layered with up to three AWM elements feeding the FDSP stage.

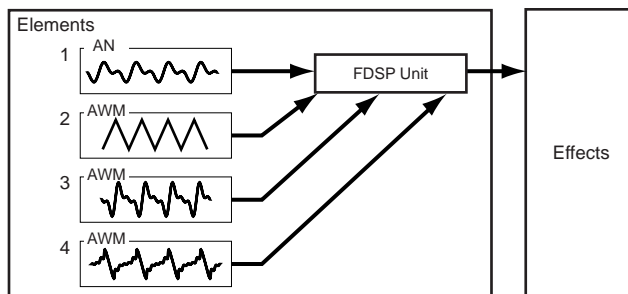

Voice & Performance Selection

One of the first things you'll want to do with your EX5, EX5R, or EX7 is select and play some of its voices or performance combinations ... this section will show you how to do just that. The EX has 256 preset voices organized into two separate memories — Preset 1 (“P1”), and Preset 2 (“P2”) — each containing 128 voices. Two 128-voice “Internal” memory areas are also provided for storage of original voices or voices loaded from an external storage medium: Internal 1 (“I1”) and Internal 2 (“I2”). The EX voice memory can thus hold up to 512 voices at once for instant selection and performance.

One internal 128-location memory area is provided for performance combinations, so there's no need to switch memory areas as in the Voice mode.

NOTE If at any time you want to restore the original factory voices, they can be reloaded from the supplied Factory Set file as described on page 27.

1 Select the Voice or Performance Mode

To select and play voices, press the [VOICE] MODE button so that its indicator lights and “VOICE PLAY” appears in the upper left corner of the LCD screen. The voice-mode display provides a few items of information in addition to the name of the currently selected voice.

The abbreviations in the section separated by a line at the bottom of the display (“P1,” “P2,” etc) indicate the functions of the corresponding function keys below the display screen.

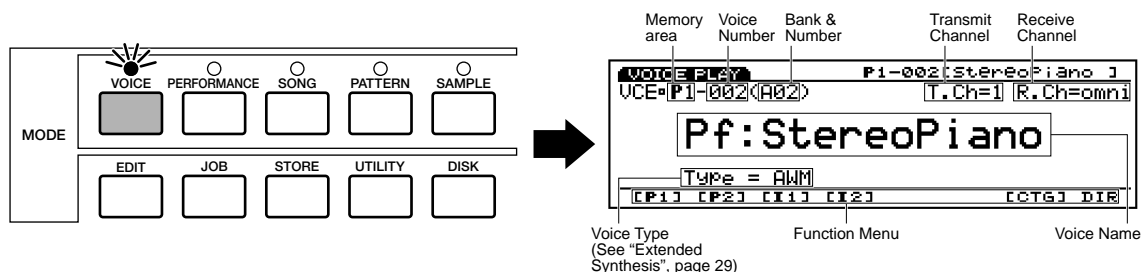

To select and play performance combinations press the [PERFORMANCE] MODE button so that its indicator lights and “PERFORM PLAY” appears in the upper left corner of the LCD screen. The performance-mode display is somewhat simpler than the voice mode display.

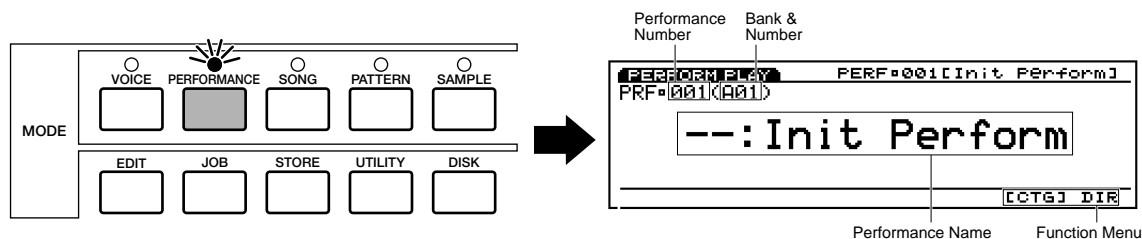

2 Select a Voice or Performance

In the Voice mode the P1, P2, I1, and I2 memory areas can be directly selected by pressing the corresponding function key, [F1] through [F4], and successively pressing [ENTER] key. Each memory area contains 8 banks of 16 voices each (8 x 16 = 128). The Performance mode has just one 128-location memory area. On the EX5 and EX7, any voice or performance in the current memory area can be selected by specifying its bank using the BANK keys ([A] through [H]), and its number using the PROGRAM number keys ([1] through [16]). To select voice or performance “D7” (number 55), for example, first press the bank [D] key and then the program number [7] key. The bank [D] key indicator will flash until the program number [7] key is pressed and the D7 voice or performance is actually engaged.

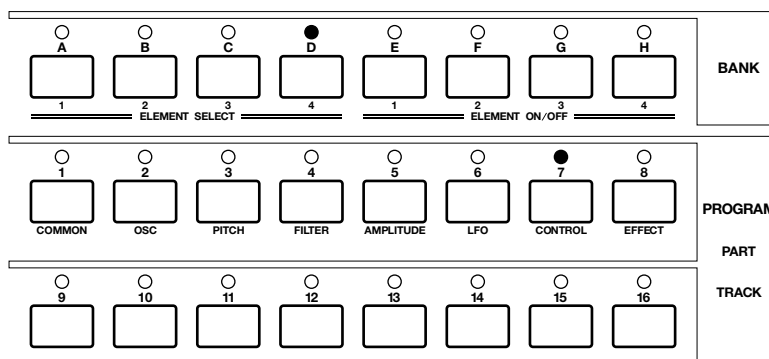

The Data Dial and [DEC]/[INC] keys, as well as the numeric keypad, can be used to select voices and performance setups on the EX5R (see “Alternate Selection Methods,” below).

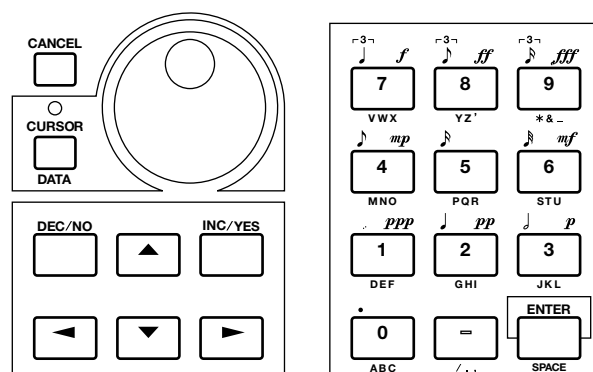

NOTE The number of the selected voice or performance will appear in the upper left corner of the display. Note that each voice or performance in the active memory area can be referred to in two ways: as a decimal number from 1 to 128, or as a bank and number (A1...A16, B1...B16, etc, through H1...H16).

To select a different voice or performance within the same bank it is only necessary to press the appropriate PROGRAM number key. To select a different bank, however, you'll always have to press both a bank key (followed by [ENTER]) and a program number key.

■ Alternate Selection Methods

The [INC] and [DEC] Keys

The [INC] and [DEC] Keys are best used for small, step-wise changes — e.g. selecting adjacent voice or performance numbers, or numbers that are only a few steps away. Press the [DEC] or [INC] key briefly to decrement or increment the number by one, or hold either key for continuous decrementing or incrementing in the corresponding direction.

The Data Dial

The Data Dial provides a fast, efficient way to cover a broad range of numbers when, for example, you're looking for a voice or performance but don't know the exact number. Simply rotate the data dial clockwise for higher numbers or counter-clockwise for lower numbers while watching the screen.

The Numeric Keypad

The number keys are an excellent choice when you know the decimal number of the voice or performance you want. Simply enter the number (“1” through “128” using 1, 2, or 3 digits as required), then press the [ENTER] key to actually select the voice or performance.

■ The Voice/Performance Directory

The voice/performance directory shows the names of 16 voices or performances at a time, with the cursor located at the currently selected number. To switch to the directory display, press the [F8] button — located directly below “DIR” on the display. Voices and performances are selected using the same methods described above, as well as by using the cursor keys to highlight the number and name of the desired voice or performance.

When the voice directory is initially selected the voice names are preceded by the corresponding voice number. By pressing the [DIR] function key a second time, however, the voice numbers are replaced by the voice category abbreviation for that voice (“Pf” for piano, “Or” for organ, etc). A complete list of the voice categories is provided on page 76.

To return to the normal voice or performance display press the [EXIT] button.



F8



■ Selecting By Category

In both the Voice and Performance modes the [F7] function key is marked “[CTG],” for “Category.” Press the [CTG] function key to select voices belonging to the same category (e.g. all piano voices in the “Pf” category) in sequence, beginning with the currently selected voice.

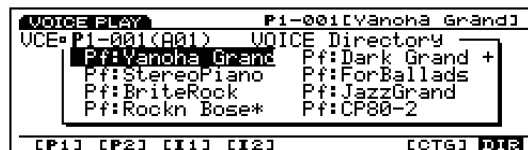

F7



Normal Voices & Drum Voices

AWM voices can be divided into two groups : normal voices and drum voices.

- A normal voice is simply a pitched voice which can be played on a musical scale from low to high, such as a piano or trumpet.
- A drum voice is a complete set of drum and other percussion sounds, each having a fixed pitch and being assigned to individual notes of the keyboard (from C-2 through G8). When initially shipped from the factory, EX instruments have 9 drum voices, numbered 123 through 128 in the Preset 2 bank and 126 through 128 in the Internal 2 bank (see the separate Data List for details). You can also create your own drum voices (page 141).

DSP Limitations

The DSP (Digital Signal Processing) system used to create the EX effects is also used by the AN, FDSP, and VL (EX5/5R only) tone generators to create voices. This means that less DSP capacity is available to produce effects when the aforementioned voice types are used. This imposes limitations which are different for the EX5/5R and EX7. The Reverb and Chorus effect units function normally regardless of the type of voice used.

EX5/5R

There are no limitations to using insertion effects in the EX5 or EX5R Voice mode. In the Performance mode, however, insertion effects can be used on a maximum of 4 parts (voices) if the performance setup consists entirely of AWM voices. If a VL, AN, or FDSP voice is used in the performance setup, however, an insertion effect can only be used on one part (voice).

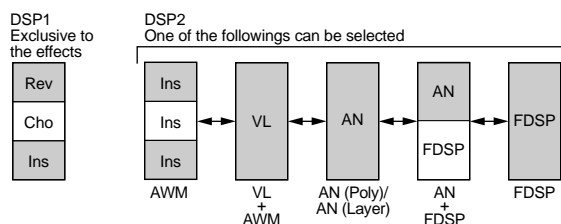

EX7

In the EX7 Voice mode, Insertion effects can be used in AWM voices, but not in any other voice type (AN or FDSP). In the Performance mode, if the performance setup consists of only AWM voices, then an insertion effect may be used on one voice. But if the performance setup includes an AN or FDSP voice, then no insertion effects can be used.

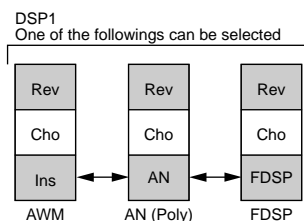

Voice Structure & Editing Hints

Although the EX Extended Synthesis tone generator system is quite complicated, the overall system and interface have been designed to make voice editing as easy and efficient as possible. A thorough understanding of the system will depend on familiarity with the individual parameters connected with each tone generator type (see list, below), but in this section we'll provide some information that may help in grasping how everything fits together, and perhaps in developing an organized approach to voice editing on the EX5/5R/7.

For details on the individual parameters connected with each tone generator type, see the following pages:

AWM Parameters	Page 75
VL Parameters	Page 107
AN Parameters	Page 112
FDSP Parameters.....	Page 123

System Overview

■ Individual Element Structure

Any EX voice, no matter what tone generator type it uses, can have anywhere from one to four “elements.” The structure of each element consists of four “stages” as shown in the block diagram below.

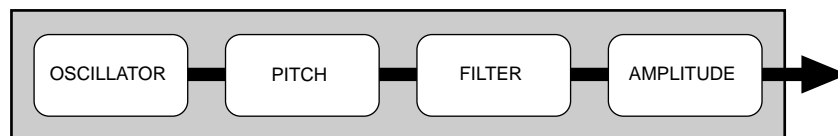

Although the individual parameters available in each stage will vary to some degree depending on the type of tone generator being edited, the basic function of each stage is the same.

OSCILLATOR

This stage is not really an “oscillator” in the traditional sense of the word, but it is here that the basic sound of the voice is produced.

- In an AWM element, the “oscillator” is the waveform or sample on which the voice is based.
- In a VL element (EX5/5R only), it is the instrument model: the reed/mouthpiece, lip/mouthpiece, or bow/string system plus the resonant system corresponding to the tube and air column or string.
- In an AN element it is the simulated VCO (Voltage Controlled Oscillator) of the simulated analog synthesis system.
- Since FDSP elements are based on AWM synthesis, an AWM oscillator stage is the same as in an AWM element.

NOTE AWM OSCILLATOR parameter details begin on page 80.

NOTE VL OSCILLATOR parameter details begin on page 108.

NOTE AN OSCILLATOR parameter details begin on page 113.

PITCH

The PITCH stage determines the pitch of the sound. In addition to allowing the pitch of the voice to be controlled from the keyboard or via MIDI note data, it allows pitch control from the pitch bend wheel, keyboard aftertouch, or any other assignable controller. The PITCH stage also includes programmable pitch envelope generators which can be programmed to produce time-based pitch variation, as well as key scaling parameters which can be used to produce different tuning curves.

NOTE AWM PITCH parameter details begin on page 83.

NOTE VL PITCH parameter details begin on page 108.

NOTE AN PITCH parameter details begin on page 117.

FILTER

This stage controls the filters provided for the selected tone generator type, and thus allows both static and dynamic timbral control. Dynamic filters can be set to respond to keyboard touch response or other controllers, while filter envelope generators can produce time-based timbral variation. The type and number of filter parameters available varies considerably according to the selected tone generator type.

NOTE AWM FILTER parameter details begin on page 86.

NOTE VL FILTER parameter details begin on page 109.

NOTE AN FILTER parameter details begin on page 118.

AMPLITUDE

This stage includes all parameters which affect the amplitude or volume level of the sound, including basic level control, touch dynamics, keyboard level scaling, and amplitude envelope generation.

NOTE AWM AMPLITUDE parameter details begin on page 96.

NOTE VL AMPLITUDE parameter details begin on page 110.

NOTE AN AMPLITUDE parameter details begin on page 119.

Overall System Structure

If we now put all four elements together, and add in the all-important control and effect blocks, the system looks something like this:

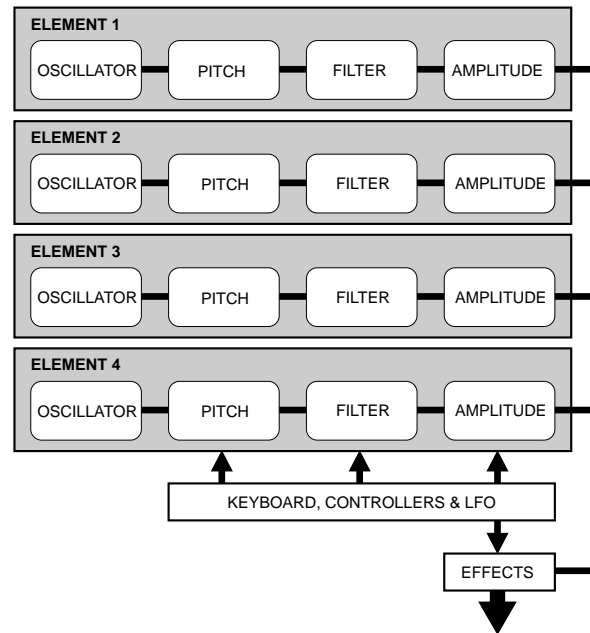

In this diagram note that the KEYBOARD, CONTROLLERS & LFO block affects the PITCH, FILTER, and AMPLITUDE stages of each element, as well as the EFFECT block.

KEYBOARD, CONTROLLERS & LFO

The EX5 and EX7 keyboards include both initial and aftertouch response which can be used for realtime control of an extremely wide range of parameters. The EX5R does not have a keyboard, but it accepts corresponding MIDI data from an external device which can be used to the same effect. The extremely versatile realtime control assignment system allows just about any controller to be assigned to any parameter — or multiple parameters, as required — for extraordinary expressive control. The LFO (in some elements multiple LFOs) can be used for pitch, filter, and/or amplitude modulation.

NOTE CONTROLLER parameter details begin on page 103.

EFFECTS

The EX internal effect system provides an extensive range of programmable effects including natural reverberation, modulation effects such as chorus and flanging, compression, distortion, auto-wah, rotary speaker, and much, much more. Controllers can also be assigned to specific effect parameters for unlimited realtime effect variation.

NOTE EFFECT parameter details begin on page 105.

FDSP ELEMENTS

The structure of FDSP elements is just slightly different from those shown above with the addition of an FDSP stage between the basic AWM element and effect block. The FDSP parameters are available via the FDSP parameter page which is accessible via the COM (COMMON) parameter page.

NOTE FDSP parameter details begin on page 123.

■ Element Configuration

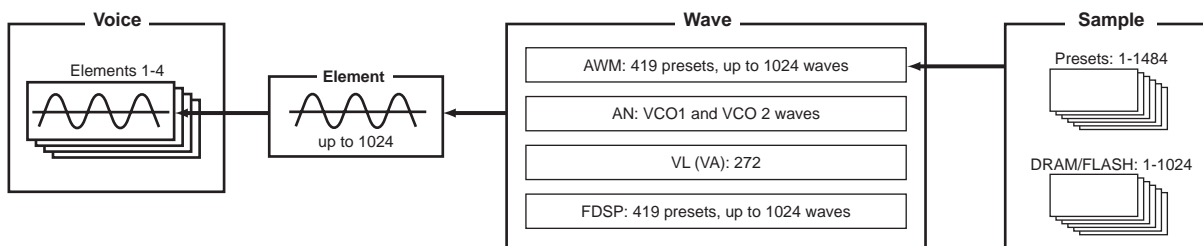

■ Element Combinations

Although the various element combinations possible with each voice type were introduced in the “Extended Synthesis” section (page 29), we’ll cover them again here because they are so pertinent to the current topic.

Remember that you can create a voice with only one element, or combine as many as four. The allowable element combinations, listed below, will greatly affect the way you approach voice editing. The type of element(s) you use will always be your first decision when creating a new voice.

AWM Voices (EX5, EX5R, and EX7)

AWM voices can have from 1 to 4 AWM elements. If you’re creating an AWM voice, this is obviously the type to choose. Please note that you also want to start with an AWM element when you intend to use a wave you have sampled yourself using the Sampling feature, or sampled waveforms imported from another source. The ability to combine AWM elements means that you could, for example, combine separate samples for the attack and sustains portions of an instrument’s sound, with independent control over each.

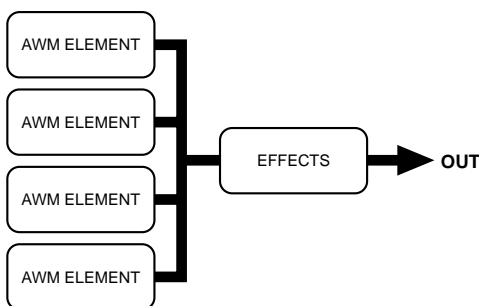

NOTE More on AWM voices on page 77.

VL Voices (EX5 and EX5R only)

VL voices can have 1 VL element and from 1 to 3 AWM elements. In many cases you’ll probably want to use the VL element alone to emphasize the full realism and expressive power of the VL tone generator. But the ability to add AWM elements provides an unprecedented measure of flexibility for thickening and adding depth to the VL sound.

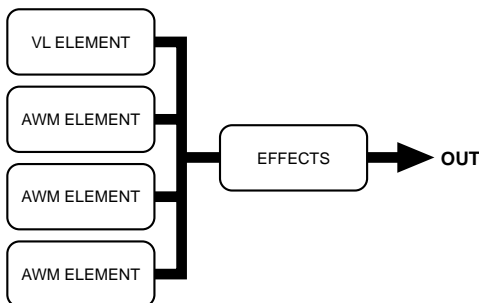

NOTE More on VL voices on page 107.

AN(Poly) Voices (EX5, EX5R, and EX7)

A standard (Poly) AN voice can have 1 AN element and from 1 to 3 AWM elements. If you're striving to create a classic analog synth or FM synthesizer type sound, it is probably better to start with the single AN element alone. Add AWM elements as necessary to "modernize" the sound.

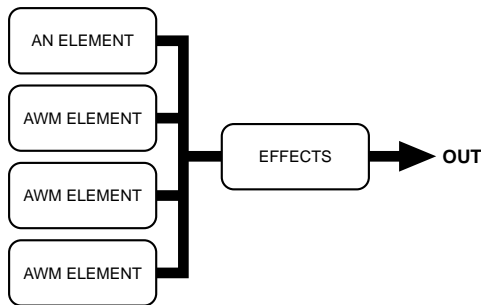

NOTE More on AN voices on page 112.

AN(Layer) Voices (EX5 and EX5R only)

AN layer voices can have 1 or 2 AN elements and 1 or 2 AWM elements. When you need a really thick, powerful pad or a punchy analog type voice, try combining the two AN elements in this voice type. Once again, the AWM elements are there when you need them to add realistic samples or other textures.

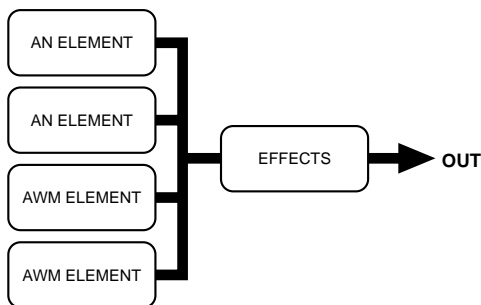

FDSP Voices (EX5, EX5R, and EX7)

FDSP voices have from 1 to 4 AWM elements with an FDSP stage between the elements and the main effect stage. The FDSP stage can be applied to any or all of the AWM elements used, as required.

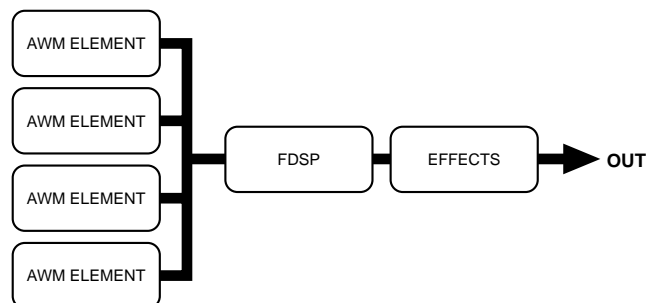

NOTE More on FDSP voices on page 123.

AN + FDSP Voices (EX5 and EX5R only)

AN + FDSP voices can have 1 AN element and from 1 to 3 FDSP elements. The FDSP stage can be applied to any or all of the AWM elements used, as required.

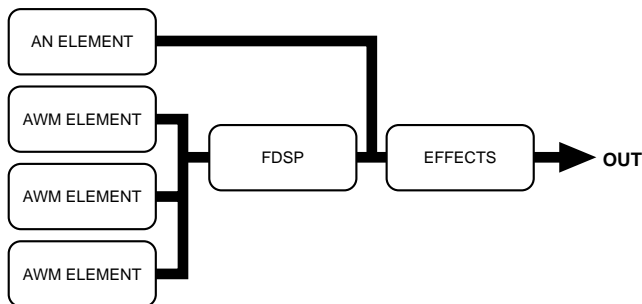

Polyphony

The maximum polyphony of the EX5 and EX5R is 126 notes, and the maximum polyphony of the EX7 is 64 notes. Full polyphony, however, is not available for all voice types. The chart below lists the maximum polyphony for each voice type.

Voice Type	EX5/5R Polyphony	EX7 Polyphony
AWM/Drum*	126	64
VL+AWM	1+AWM	—
FDSP	16	8
AN(Poly)+AWM	2+AWM	1+AWM
AN(Layer)+AWM	1+AWM	—
AN+FDSP	AN: 1; FDSP: 8	—

*Please note that the actual polyphony may be reduced under certain conditions.

Editing Control

The EX5, EX5R, and EX7 provide a number of tools and techniques to facilitate voice editing. Some of the more important methods are discussed below.

■ Element Selection

When editing a multi-element voice, you will obviously need to select the specific element you want to edit. On all models this can be done via the edit display, cursor keys and data entry dial/keys. The EX5 and EX7 additionally allow element selection via BANK select keys [1] through [4] (labelled “ELEMENT SELECT”), corresponding to elements 1 through 4. In the VOICE EDIT mode pressing any of these keys will select the corresponding element for editing. The currently selected element is indicated by an inverse element number on the left side of the edit display, and by a lit indicator above the corresponding ELEMENT SELECT key. Any element can be selected and enabled as required in the OSC page, but only elements which are on can be selected when any other editing page is showing. Only one element can be selected at a time.

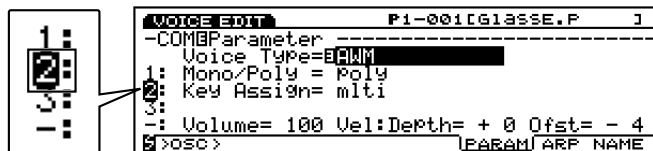

■ Element Muting

Another necessity when editing a multi-element voice is the ability to turn individual elements off or on. You might need to concentrate on the sound of a single element, for example, and need to “mute” any other elements so you can hear only the target element while making subtle changes. On the EX5 and EX7 individual element muting can be accomplished via BANK select keys [5] through [8] (labelled “ELEMENT ON/OFF”). The key indicators corresponding to elements which are on will be lit, and will go out when the corresponding element is muted. Muted elements are also indicated by a small element number on the left side of the edit display. On all models, individual elements can also be turned on or off while editing by pressing the correspondingly-numbered key on the numeric keypad while holding the [SHIFT] key.

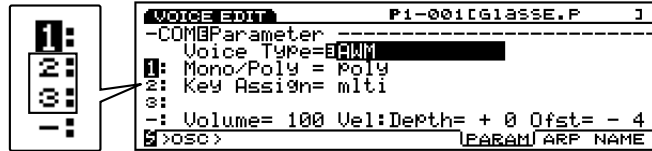

■ Direct Edit Page Selection

Once you’ve entered the Voice Edit mode, you can directly select each edit page by one of the following methods: use the [F1] key to select the edit pages in sequence, or select any individual page by pressing the corresponding function key while holding the [SHIFT] key. On the EX5 and EX7 all of the top-level edit pages can also be directly accessed via PROGRAM keys [1] through [8] — corresponding to the COMMON, OSC, PITCH, FILTER, AMPLITUDE, LFO, CONTROL, and EFFECT parameter pages, respectively (these are marked on the panel below the corresponding keys).

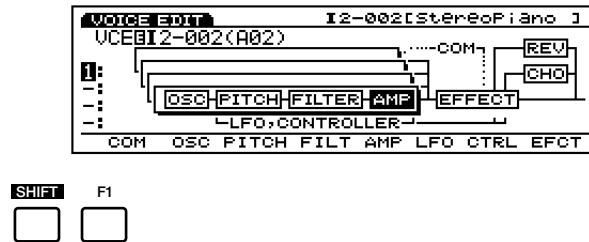

■ Controller Knob Mode Switching

The Controller Knobs are conveniently set up to act as data entry controls for voice editing. A small inverse number beside a parameter in the display indicates that the correspondingly-numbered Controller Knob will adjust that parameter.

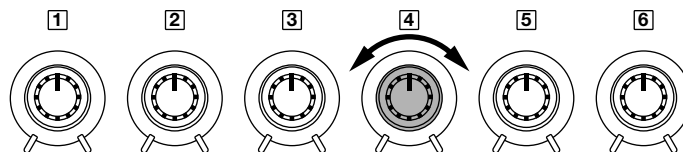
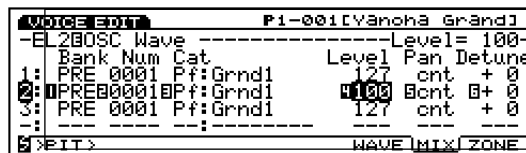

There will be cases, however, where you’ll want to try out the effect of the Controller Knobs as they apply to the sound of the voice. Simply press the [KNOB MODE] key so that its indicator lights to instantly switch the knobs back to sound control. When you’re ready to continue editing, press the [KNOB MODE] key again so that its indicator goes out to reset the knobs to the data entry mode.

■ Relative & Absolute Controller Knob Data Entry

Normally when you rotate a Controller Knob being used for data entry, the corresponding value changes in relative fashion — i.e. the knob increases or decreases the value of the parameter in relation to the value that was initially on the display. To put it another way, the central detented position of the Controller Knob will correspond approximately to the parameter value that was on the display before the knob was rotated.

If you rotate a Controller Knob while holding the [KNOB MODE] key, however, the relationship between the controller position and the data value becomes absolute, and the central detented position of the knob will correspond to the exact center of the parameter range.

■ Compare & Store

The moment you alter any parameter in the Voice Edit mode a small inverse “E” will appear at the top left on the display, indicating that the voice has been edited but not yet stored.

```

VOICE EDIT P1-0010
-COMPEParameter -----
  Voice Type=AWM
  Mono/Poly = Poly

```

You can also press the [EDIT/COMPARE] key while in the edit mode to switch back and forth between the original and edited sound (an inverse “E” appears at the top left on the display when the Compare function is engaged — i.e. the original sound is being monitored).

```

VOICE EDIT P1-0010
-COMEParameter -----
  Voice Type= AWM
  Mono/Poly = Poly

```

When you exit from the Voice Edit mode the “E” will remain at the top left on the display until you either store the edited voice or select a different voice number or mode. If you do select a different voice number or mode prior to storing the edited voice, the edited data will be lost! So be sure to store edited voice data you want to keep, as described on page 48.

NOTE If at any time you want to restore the original factory voices, they can be reloaded from the supplied Factory Set file as described on page 27.

Voice Store Procedure

To store an edited voice:

1 Press the [STORE] key

After editing the voice as required, press the [STORE] key either while still in the Voice Edit mode, or immediately after returning to the Voice Play mode (do not select a different voice or mode before storing the edited data, or the edited data will be lost!).

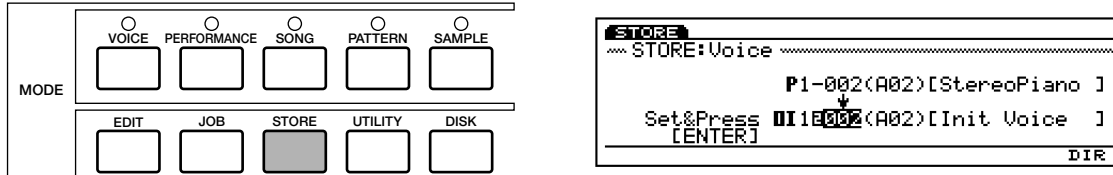

2 Select the destination voice

Use the Cursor keys in conjunction with the Data Dial, the [DEC]/[INC] keys, the numeric keypad, or Controller Knob 1 to select the internal Voice memory location to which you want to store the edited data. The BANK and PROGRAM keys can also be used on the EX5 and EX7.

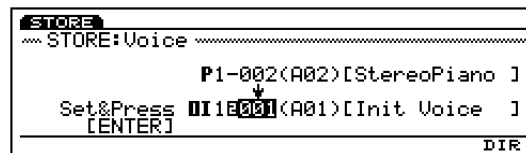

3 Press [ENTER] and confirm

Press the [ENTER] key. The “Are you sure?” confirmation display will appear. Press the [INC/YES] key to confirm and actually store the edited data. Press [DEC/NO] if you want to abort the store operation.

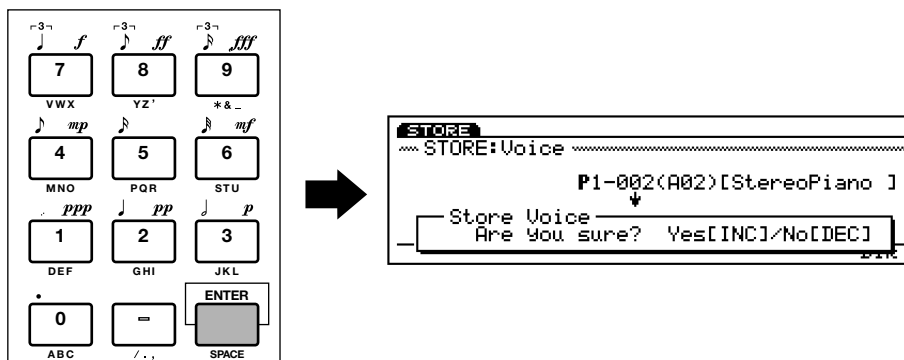

4 Press [EXIT]

When the data has been stored (“Completed!” will appear briefly on the display), press the [EXIT] key to return to the previous display.

NOTE Up to 1024 elements can be stored onto your EX.

The Power of the Performance Mode

The EX Performance mode allows up to 16 different voices to be assigned to different “parts” and combined in a number of ways. The results can be ideal for real-time performance — as the name of the mode suggests — or for sequencing via the EX Song or Pattern mode, or via external MIDI control. Either way, the Performance mode offers versatility and control not available in the Voice mode.

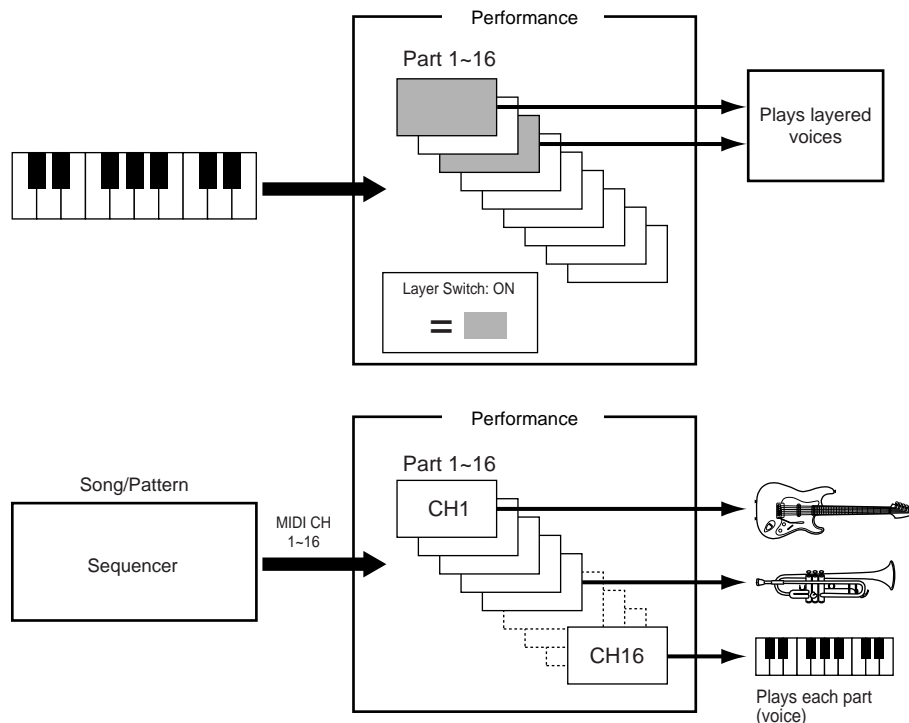

Layers

Two different voices (known as “parts” in the Performance mode) can be combined in layers and played simultaneously. Independent volume, panning, effects, and control parameters are provided for each part, so you have total control over how the parts are mixed to create the final sound. Straightforward layering lets you combine similar voices to create exceptionally thick, rich textures. You can also detune layers in relation to each other for even greater depth. Completely different voices can also be layered for unique effects: a fairly common example would be layered piano and strings. But layering is only the beginning ...

NOTE See the Performance Edit mode parameters, page 158, for part assignment, volume, panning, effects, and related parameters.

Example: a simple 2-layer performance.

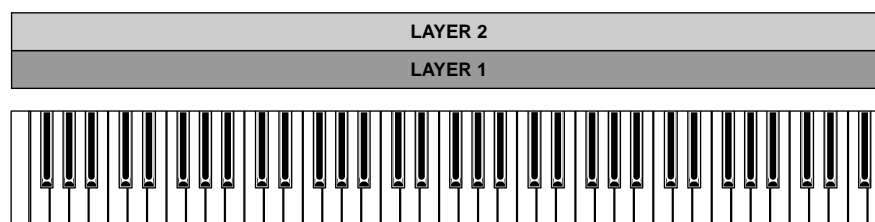

NOTE You can layer the voices, though, the sounds being produced may be delayed depending on the voice combination.

■ Split Keyboard

Instead of layering voice parts over the same keyboard range, different parts can be assigned to different areas of the keyboard for split keyboard setups. A simple example would be to assign a bass voice to the left-hand section of the keyboard and a piano voice to the right-hand section.

NOTE The Note Limit parameters in the Performance Edit mode are used to assign the various parts to the required note ranges (page 166).

Example: simple 2-way split keyboard.

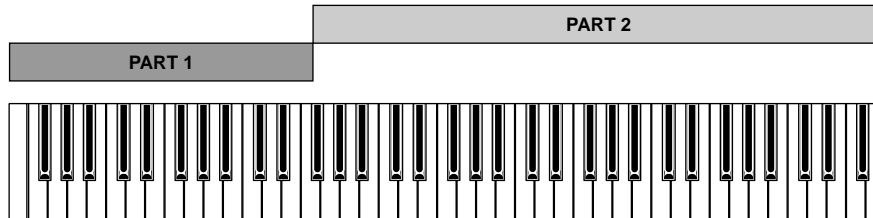

■ Velocity Switching

Velocity switching takes layering a step further by assigning the layered voices to different velocity ranges. As an example, let's consider how a slap bass voice could be created using two layers: the first a smooth fingered bass sound, and the second a snappy slapped bass sound. If we assign the first layer — the fingered bass — to the velocity range from, say, 1 through 64, and the slapped layer to velocities from 65 through 128 (the total keyboard velocity range is from 1 to 128), then when we play the keyboard gently we have the fingered sound, and when we play harder we get the slapped sound.

NOTE Velocity switching can be accomplished by using the Velocity Limit parameters in the Performance Edit mode (page 166).

Example: velocity switched layers.

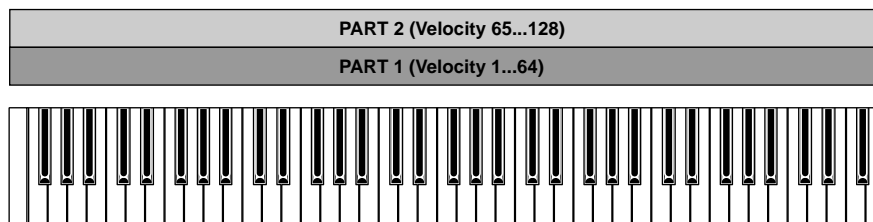

■ Arpeggiator Accompaniment

The EX Arpeggiator (page 61) is capable of producing an essentially unlimited range of patterns which can be tailored to make ideal accompaniment for a wide spectrum of musical styles. The Arpeggiator can be assigned to any of the Performance mode parts, so in a split-keyboard setup you could control an Arpeggiator pattern with the left hand while playing a lead line with the right. You could even have two “contrapuntal” Arpeggiator patterns controlled via different sections of the keyboard. The Arpeggiator can easily be turned on or off while playing via the panel [ARPEGGIO] key (the Arpeggio editor display will appear — press [EXIT] to return to the Performance play display).

NOTE Arpeggiator programming is described on page 238, and the Arpeggiator is assigned to Performance parts via the Arpeggio parameter in the Performance Edit mode (page 160).

```

PERFORM EDIT          PERF#001[Init Perform]
-COMBArpeggio -----Arp Sw= on-
Sw   =E on  Type =0001:PRELUOct1 ]
Tempo= 120  Ctrl = off
Hold = off  NoteLimit= C-2 - G 8
MIDI:Ch= 1  MIDI A= off MIDI B= off
[COM] PART MLT          [ARP]
  
```

Example: left-hand arpeggio control + right-hand lead.

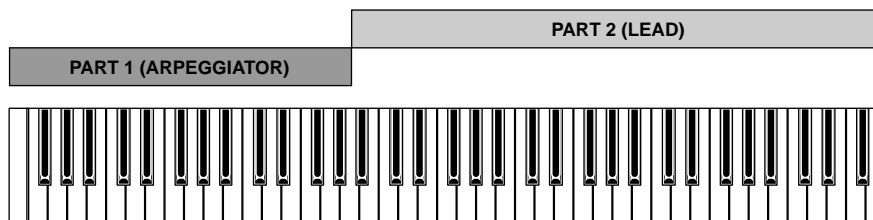

■ Multi-timbre Tone Generator

Another important function of the Performance mode is to assign and set up the various parts for the internal EX Song or Pattern mode sequencer, or for multi-timbre MIDI control from an external computer-based or stand-alone MIDI sequencer device. The 16 Performance mode parts correspond to the 16 Song mode tracks, so voices assigned to the Performance parts are played by the corresponding Song tracks. The Pattern mode only uses the first 8 tracks/parts. The Performance mode volume, pan, and effect parameters define the overall sequence mix.

NOTE The Song and Pattern modes are described in more detail on pages 185 and 219, respectively.

■ Voice Editing From the Performance Mode

There may be times when you'll want to actually edit a voice being used in the Performance mode rather than just the Performance parameters. You can jump directly to the Voice Edit mode from the Performance or Performance Edit mode by pressing the [VOICE] key while holding the [PERFORMANCE] key. First the Performance mode display will appear with the [F1] and [F2] function keys assigned to part selection.

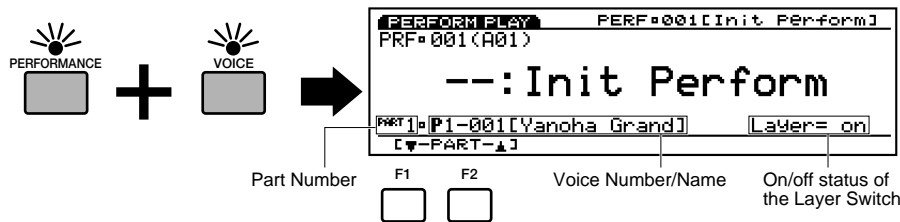

Use the [F1] and [F2] keys to select the part corresponding to the voice you want to edit, then press the [EDIT] key to go to the Voice Edit mode. Once the voice has been edited as required, save the edited data (page 48), then press the [PERFORMANCE] key to return to the Performance mode.

NOTE The voice type cannot be changed when this method is used to access the Voice Edit mode. Use the normal Voice Edit mode — accessed via the Voice mode — if you need to change the voice type.

NOTE When you edit the voice with the Layer Switch (page 166) turned on, the voices from the other parts with the Layer Switch turned on will be produced. When you edit the voice with the Layer Switch turned off, only the currently editing voice will be produced.

■ Compare & Store

As in the Voice Edit mode, the moment you alter any parameter in the Performance Edit mode a small inverse “**E**” will appear at the top left on the display, indicating that the performance has been edited but not yet stored.



You can also press the [EDIT/COMPARE] key while in the edit mode to switch back and forth between the original and edited sound (an inverse “**E**” appears at the top left on the display when the Compare function is engaged — i.e. “**E**” the original sound is being monitored).



When you exit from the Performance Edit mode the “**E**” will remain at the top left on the display until you either store the edited performance or select a different performance number or mode. If you do select a different performance number or mode prior to storing the edited performance, the edited data will be lost! So be sure to store edited performance data you want to keep, as described on page 53.

Performance Store Procedure

To store an edited performance setup:

1 Press the [STORE] key

After editing the performance setup as required, press the [STORE] key either while still in the Performance Edit mode, or immediately after returning to the Performance Play mode (do not select a different performance setup or mode before storing the edited data, or the edited data will be lost!).

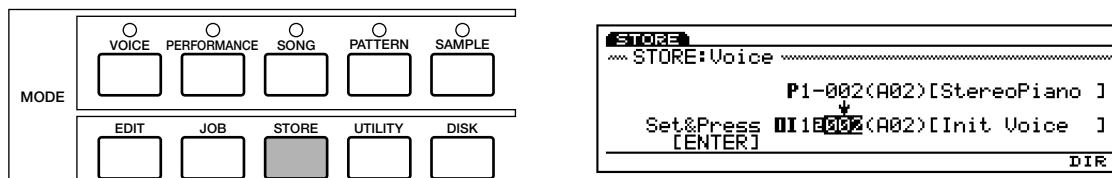

2 Select the destination Performance

Use the Data Dial, the [DEC]/[INC] keys, the numeric keypad, or Controller Knob 1 to select the Performance memory location to which you want to store the edited data. The BANK and PROGRAM keys can also be used on the EX5 and EX7.

3 Press [ENTER] and confirm

Press the [ENTER] key. The “Are you sure?” confirmation display will appear. Press the [INC/YES] key to confirm and actually store the edited data. Press [DEC/NO] if you want to abort the store operation.

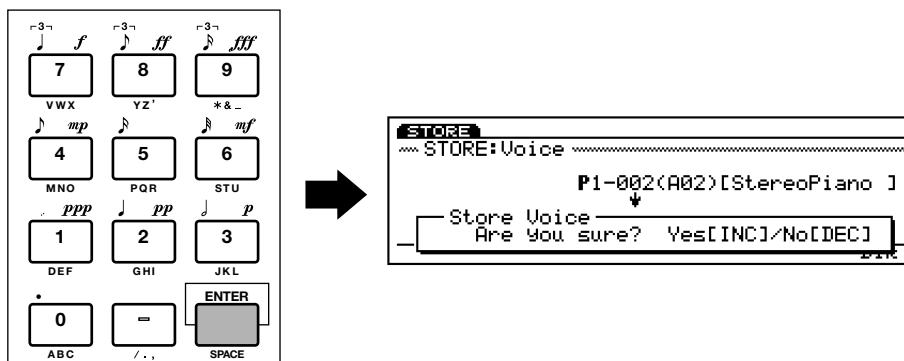

4 Press [EXIT]

When the data has been stored (“Completed!” will appear briefly on the display), press the [EXIT] key to return to the previous display.

Performance Mode DSP Limitations

The DSP (Digital Signal Processing) system used to create the EX effects is also used by the AN, FDSP, and VL (EX5/5R only) tone generators to create voices. This means that less DSP capacity is available to produce effects when the aforementioned voice types are used. This imposes limitations which are different for the EX5/5R and EX7. The Reverb and Chorus effect units function normally regardless of the type of voice used.

EX5/5R

There are no limitations to using insertion effects in the EX5 or EX5R Voice mode. In the Performance mode, however, insertion effects can be used on a maximum of 4 parts (voices) if the performance setup consists entirely of AWM voices. If a VL, AN, or FDSP voice is used in the performance setup, however, an insertion effect can only be used on one part (voice).

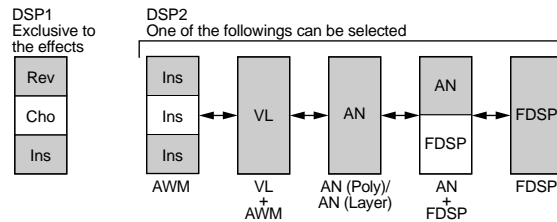

EX7

In the EX7 Voice mode, Insertion effects can be used in AWM voices, but not in any other voice type (AN or FDSP). In the Performance mode, if the performance setup consists of only AWM voices, then an insertion effect may be used on one voice. But if the performance setup includes an AN or FDSP voice, then no insertion effects can be used.

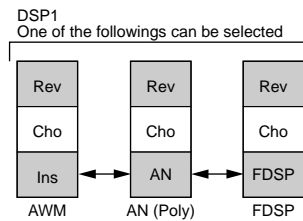

The Controllers

In addition to the standard pitch bend and modulation wheels, the EX5 and EX7 offer a range of assignable controllers that can be used for unprecedented sound control. The EX5R Tone Generator also offers extended controller versatility for enhanced programming and performance control.

The keyboard models feature a second modulation wheel and a ribbon controller, plus full keyboard initial and aftertouch response. All models also have 6 Controller Knobs which can be assigned to any of the same parameters as the modulation wheels and ribbon controller, providing intimate analog-synthesizer type control convenience. Another powerful feature associated with the Controller Knobs is a “scene” memory, with two scene buttons which can be used to switch or “morph” between memorized Controller Knob setups. The Controller knobs also function as data entry controls while editing for fast, efficient operation. Jacks additionally allow connection of a foot controller (EX5 and EX7) and breath controller (particularly valuable for use with VL voices).

An important feature of all models is that a number of controller “sets” can be created, with total assignment freedom: e.g. different controllers can be assigned to totally different parameters, a single controller can be assigned to several parameters, multiple controllers can control a single parameter, or just about any combination of the above.

The EX Controllers

All of the controllers that can be used with the EX5 and EX7 are listed below. Since the EX5R is a tone generator, it does not have many of the physical controllers provided on the keyboard models. The EX5R does, however, receive MIDI control change data, so the corresponding controllers on the keyboard or other master MIDI control device can be used in the same way.

Pitch Wheel (EX5/EX7)

The self-centering EX5 and EX7 PITCH wheel can be assigned to a range of internal parameters, but it's “standard” function is pitch control: roll up (away from the keyboard) to bend the pitch upward, or down (toward the keyboard) to bend down. Normal pitch is produced with the PITCH wheel at its center position.

NOTE No matter parameter the PITCH wheel is assigned to, operating it always causes MIDI pitch control data to be transmitted via the MIDI OUT terminal(s).

Modulation 1 Wheel (EX5/EX7)

This wheel produces minimum effect in its lowest position and maximum effect in the highest position. It can be assigned to the full range of available control parameters, but it's normal function is to control modulation depth.

Modulation 2 Wheel (EX5/EX7)

The second modulation is not self-centering, but it has a center click-stop which makes it ideal for assignment to parameters that have a “normal” central setting with variations above and below. The MODULATION 2 wheel is also used for “scene morphing” (see “Scene Switching & Morphing,” below).

NOTE An optional foot controller connected to the rear-panel FOOT CONTROLLER jack can also be assigned to the scene morphing function — page 58.

Ribbon Controller (EX5/EX7)

The Ribbon Controller is a touch sensor that you control by running a finger lightly across its surface to the left or right. The Ribbon Controller can be assigned to the full range of EX parameters.

Controller Knobs (EX5/EX5R/EX7)

In addition to their function as data entry controls in the editing, utility, and some other modes, each of the six Controller Knobs can be independently assigned to any of the available EX parameters for realtime control in the Voice Play and Performance Play modes.

Breath Controller (EX5/EX5R/EX7)

An optional Yamaha BC3 Breath Controller plugged into the rear-panel BREATH jack can be assigned to control any of the available EX parameters — but it is a natural candidate for controlling Pressure, Tonguing, Throat, Growl, and other VL tone generator parameters.

Foot Controller (EX5/EX7)

An optional Yamaha FC7 Foot Controller connected to the rear-panel FOOT CONTROLLER jack can be assigned to any EX controller parameter. The advantage of using a foot controller for parameter control is, obviously, that it leaves both your hands free to play the keyboard (or operate other controllers).

Foot Switch (EX5/EX7)

An optional Yamaha FC4 or FC5 Footswitch connected to the rear-panel FOOTSWITCH jack can be assigned to a limited range of parameters via the Utility mode Controller Setup display (page 275). Of course, the footswitch is only really useful with on/off type parameters — not with parameters that allow continuous control.

Aftertouch (EX5/EX7)

Keyboard aftertouch allows you to control any controller parameter by the pressure you apply to a key after it is initially pressed. This is perhaps the most “intimate” type of keyboard expression control. Like most of the EX controllers, keyboard aftertouch can be assigned to the full range of available parameters.

MIDI (EX5/EX5R/EX7)

Particularly on the EX5R Tone Generator, which does not have the full range of controllers provided on the keyboard models, most parameter control operations will be carried out via MIDI control change messages. The MIDI protocol provides a lot of control change numbers, some of which are pre-assigned to specific controllers — “001” is “Modulation Wheel,” for example. All of these are available for assignments to the EX controller parameters, so external MIDI control devices can be used to full advantage.

■ Extended MIDI Control Capability

In addition to controlling the internal tone generator, all of the controllers listed above — with the sole exception of the PITCH wheel — can be assigned to transmit MIDI control data using any MIDI control change number, so that the EX controllers can be used to control a wide range of external MIDI devices and parameters as well.

Scene Switching & Morphing

The SCENE [1] and [2] keys can be used to memorize and recall different settings of the Controller Knobs for the voices, so a complete set of knob settings can be recalled instantaneously. You can also “morph” smoothly between memorized scenes for new expressive effects. Scenes can be independently stored with each internal voice and performance combination, so they will be available instantly when you recall a voice or performance.

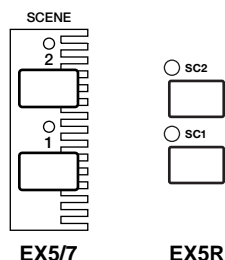

Storing a Scene

Either using the preset Controller Knob assignments or assignments you have made yourself, go to the VOICE PLAY or PERFORMANCE PLAY mode and set the Controller Knobs to produce the required sound. To store the “scene” simply press either the SCENE [1] or [2] key while holding the [STORE] key. Repeat as required for the remaining scene.

In order to store the settings you have just made with a voice or performance combination, it is necessary to execute the voice store (page 48) or performance store (page 54) operation, otherwise your scene settings will be lost as soon as you select a different voice, performance, or mode.

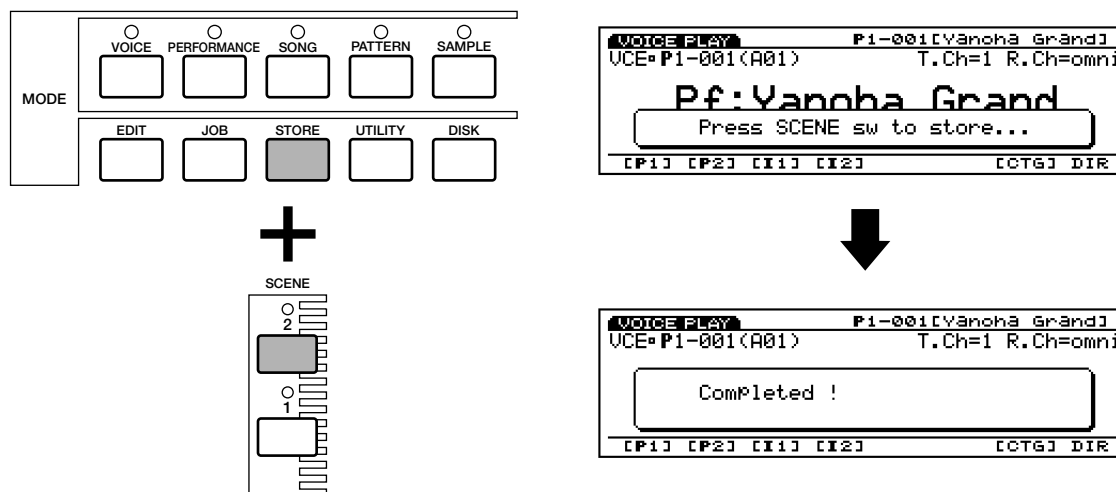

Scene Recall & Switching

To recall a stored scene simply press the corresponding SCENE key so that its indicator lights. If you press the same scene button again so that its indicator goes out the recalled scene will be disengaged and the current panel Controller Knob settings will again take effect. While either scene is active, you can switch directly to the other scene by pressing its key — the indicator of the previously active scene key will go out and the new scene indicator will light.

■ Scene Control (Scene Morphing)

The term “morph” comes from the word “metamorphosis,” meaning to change from one form or shape to another. In the case of the EX scenes it means to change gradually and smoothly from one scene to another, instead of switching abruptly as described in the preceding section.

To morph between scenes, first press one SCENE key while holding the other so that both SCENE indicators light simultaneously. You can then use the MODULATION 2 wheel to gradually change from SCENE 1 (wheel at its lowest position) to SCENE 2 (wheel at its highest position). With the MODULATION 2 wheel at its center click-stop position you have an approximately 50/50 blend of the two stored scenes. Press either SCENE key to disengage scene morphing.

NOTE Although the MODULATION 2 wheel is normally assigned to scene morphing, the FOOT CONTROLLER can be used as an alternative (assigned via the UTILITY MODE Controller Setup display - page 276) if you want to retain use of the MODULATION 2 wheel for other parameters while scene morphing is active.

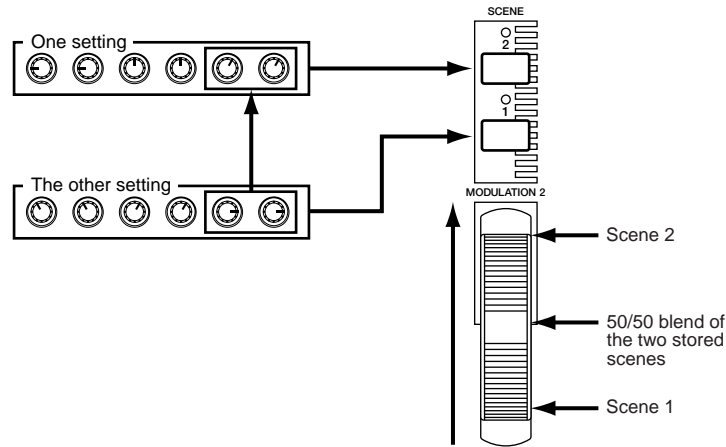

Controller Sets

One of the most powerful features of the EX controller system is the ability to create controller “sets.” Up to 16 controller sets can be created for each voice. Each set allows any or all of the “source” controllers to be assigned to one of the available parameters.

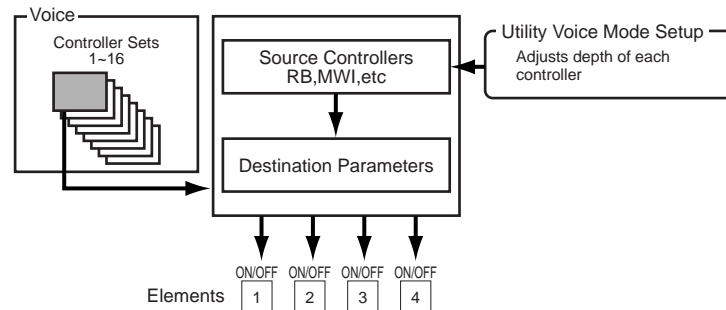

The source controllers are:

Display Abbreviation	Controller
PB	PITCH Wheel
RB	Ribbon Controller
MW1	MODULATION Wheel 1
MW2	MODULATION Wheel 2
KN1	Controller Knob 1
KN2	Controller Knob 2
KN3	Controller Knob 3
KN4	Controller Knob 4
KN5	Controller Knob 5
KN6	Controller Knob 6
AT	Keyboard Aftertouch
FC	Foot Controller
BC	Breath Controller

The destination parameters are organized into 8 related groups, listed below. The actual parameters available in each group for a given voice will depend to some extent on the type of voice and how it is set up, the type of effects selected, etc.

The destination parameter groups are:

Display Abbreviation	Controller
COM	Common
EF1	Effect 1 (Insertion)
EF2	Effect 2 (Insertion)
FDSP	FDSP Tone Generator
AWM	AWM Tone Generator
AN	AN Tone Generator
DR	AWM Drum Voice
VL	VL Tone Generator

A controller set can, for example, assign a single controller such as the Ribbon Controller to a single parameter such as, say, AWM tone generator LFO amplitude modulation depth. Or it could assign a number of controllers to the same parameter: the Ribbon Controller, Foot Controller, and Controller Knob 1 could all be assigned to control AWM tone generator LFO amplitude modulation depth. On the other hand, the same controller can be assigned to control different parameters in different controller sets, so you end up with a single controller controlling up to 16 different parameters at the same time!

NOTE Controller set assignment on page 104.

■ Controller Set Remapping

When the Voice Edit mode Controller Set display is selected, “[REMAP]” will appear above the [F3] function key. This key can be used to “remap” non-contiguous controller set numbers to a contiguous set of sequential numbers. For example, if you have created controller sets 1, 3, 6, and 10, pressing the [REMAP] key will re-assign these sets to numbers 1, 2, 3, and 4. If a VL voice is selected, pressing [REMAP] will do the above and add a number of preset “recommended” controller sets for the selected voice in subsequent controller set numbers.

Sequencer Functions

The EX5, EX5R, and EX7 have three separate sequencing functions suited to different purposes:

● The Song Mode

The EX Song Sequencer is a full-featured 16-track sequencer complete with real-time play effects — including “groove” quantization — and a comprehensive range of editing functions. A 30,000 note memory gives this sequencer plenty of capacity for recording and playback of complete songs with rich musical textures and complex arrangements. Only one song can be retained in internal memory at a time, but like all other EX data songs can be saved to and loaded from floppy disk or another external storage medium as required.

```
SONG PLAY: M001 SONG=[Init Song ]
P: Fx 1 2 3 4 5 6 7 8 9 10 11 12 13 14 15 16
Mute  [ ] [ ] [ ] [ ] [ ] [ ] [ ] [ ] [ ] [ ] [ ] [ ] [ ] [ ] [ ] [ ]
FxThru [ ] [ ] [ ] [ ] [ ] [ ] [ ] [ ] [ ] [ ] [ ] [ ] [ ] [ ] [ ] [ ]
Meas=1001:1 4/4 Loop=Off:0001-0001
Click=rec J 1/4 Tempo= 120.0
Pattern= 00[- off --]
[SONG] PFX TCH NAME Loc1 Loc2
```

 The Song memory will always be erased when the power is turned off. If you want to keep a recorded song, use the Disk mode Save Song option to save all data to disk.

NOTE Song recording and playback details begin on page 185.

● The Pattern Mode

The 8-track “pattern” sequencer has most of the functions and features of the 16-track song sequencer, but is more suited to the production and management of shorter patterns or phrases such as drum tracks, dance grooves, or other frequently used phrases. Patterns can be used alone, they can be used in songs (the Song mode has a dedicated “Pattern Track”), or they can be assigned to specific keys and played back in a variety of ways in the Key Map mode (page 72). Up to 50 patterns can be retained in memory and played, sequenced in songs, or mapped to the keyboard as required.

```
PATTERN PLAY: M001 PTN=01[NewTrack]
1 2 3 4 5 6 7 8 No=01[NewTrack]
Mute  [ ] [ ] [ ] [ ] [ ] [ ] [ ] [ ]
FxThru [ ] [ ] [ ] [ ] [ ] [ ] [ ] [ ]
Meas=1001:1 4/4 MaxLng= 4
Click=rec J 1/4 Tempo= 120.0
[PTN] PFX TCH NAME
```

NOTE Pattern recording and playback details begin on page 219.

● The Arpeggiator

4-track arpeggio patterns — from simple to sophisticated — can be stored as performance parameters for automatic recall and use with individual performance setups, or used with voices in the Voice mode. The EX Arpeggiator makes it easy to create automatic arpeggios, techno-style patterns, or a virtually unlimited range of other repeating phrases.

```

ARPEGGIO PLAY          M001 ARF=051[Init Arp]
Mute  1 2 3 4
FxThru  ■ ■ ■ ■
Meas= 001:1 4/4 Length= 4 Key= sort
Click= rec 1/4 Tempo= 120 Vel= seq
[ARPEGGIO] PFX MODE NAME
  
```

In the Performance mode it can be assigned to any of the Performance mode parts, so in a split-keyboard setup you could control an Arpeggiator pattern with the left hand while playing a lead line with the right. You could even have two “contrapuntal” Arpeggiator patterns controlled via different sections of the keyboard. In both the Voice and Performance modes the Arpeggiator can easily be turned on or off while playing via the panel [ARPEGGIO] key (the Arpeggio editor display will appear — press [EXIT] to return to the Performance or Voice play display). The Arpeggiator has the same advanced play effects and in-depth editing capabilities as the Song and Pattern sequencers.

50 preset Arpeggiator patterns are provided, and an additional 50 “user” patterns can be created and retained in memory until needed.

NOTE Arpeggio recording and playback details begin on page 238.

Arpeggio Hold

This handy function adds significantly to the Arpeggiator’s performance potential. When the hold function on, the arpeggiator pattern will continue repeating after the keys have been released, until the next key is pressed. This means that in a split-keyboard performance setup with the arpeggiator assigned to the left-hand section of the keyboard, for example, you only need to play a left-hand chord when a chord change is necessary. The rest of the time the arpeggiator will continue playing automatically while you play a melody on the right-hand section on the keyboard.

In the Performance mode the Hold parameter is turned on or off via the Hold parameter in the Arpeggio display (page 160). In the Voice mode the Hold parameter is turned on or off via the Arpeggio Hold parameter in the Utility mode Voice Mode Setup display (page 272). In either mode the Hold function can be turned on or off by pressing the [ARPEGGIO] key while holding the [SHIFT] key.

```

PERFORM EDIT          PERF=002[Init Perform]
-COMBARpeggio -----Arp Hold= on-
Sw   = off  Type = 001:PRELU*Oct1 ]
Tempo= 120  Ctrl = off
Hold = on   NoteLimit=BC 2 -BG 8
MIDI:Ch= 1  MIDI A= off MIDI B= off
[LOCM] PART MLT          [ARPEGGIO]
  
```

Sequence Record Modes & Editing

The number and type of recording modes available is different for each EX sequencer function:

SEQUENCER FUNCTION	RECORD MODES
SONG	Replace, Overdub, Step, Multi, Punch
PATTERN	Replace, Overdub, Step, Multi
ARPEGGIO	Replace, Overdub, Step

```

SONG REC                               M001 SONG=[Init Song J
P: F: 1 2 3 4 5 6 7 8 9 10 11 12 13 14 15 16
Mute  [ ] [ ] [ ] [ ] [ ] [ ] [ ] [ ] [ ] [ ] [ ] [ ] [ ] [ ] [ ] [ ]
FxThru [ ] [ ] [ ] [ ] [ ] [ ] [ ] [ ] [ ] [ ] [ ] [ ] [ ] [ ] [ ] [ ]
Meas=001:1B 4/4 Loop=0off:0001-0001
Click= rec J 1/4 Tempo= 120.0
Track= Tr1 Src= normal
[SONG] PFX                               STEP OVER RPLC PNCH
    
```

```

PATTERN REC                             PTN=#01[NewTrackJ
1 2 3 4 5 6 7 8 No=#01[NewTrackJ
Mute  [ ] [ ] [ ] [ ] [ ] [ ] [ ] [ ]
FxThru [ ] [ ] [ ] [ ] [ ] [ ] [ ] [ ]
Meas= 001:1B 4/4 MaxLng= 4
Click= rec J 1/4 Tempo= 120.0
Track= Tr1
[PTN]                                     STEP OVER RPLC
    
```

```

ARP REC                                 ARP=#051[Init ArpegJ
1 2 3 4
Mute  [ ] [ ] [ ] [ ]
FxThru [ ] [ ] [ ] [ ]
Meas= 001:1B 4/4 Length=# 4 Key=#sort
Click= rec J 1/4 Tempo= 120 Vel= seq
Track= Tr1
[ARP]                                     STEP OVER RPLC
    
```

● Replace

In the “Replace” real-time record mode the EX5, EX5R, or EX7 records exactly what you play as you play it, erasing any previous material in the record track as you do so. This is the mode you’ll usually use when recording a new track “from scratch.” The fact that you’re recording in real-time means that all the subtle timing and nuances of your performance will be accurately recorded (as well as the mistakes). If you do need to make changes after making a recording using the Replace mode, the EX editing functions (page 201) give you full control.

● Overdub

The “Overdub” real-time record mode allows the same type of real-time recording as the Replace mode, except that previous material in the record track is retained so that you can add new material to a previously recorded track. This can be particularly useful when recording a drum track, for example: you can record the bass drum and snare on the first run, then overdub the hi-hat and tom-toms, and finally overdub the cymbals and fills.

● Punch

The Punch mode, only available in the Song mode, is actually a variation of the real-time Replace record mode, except that you can specify the measures at which you want to begin and end recording. You can also specify the measure from which you want to begin playback prior to recording. This is perfect for re-recording a section of a track — from one or two measures to an entire chorus, as required — while leaving the rest of the track intact.

● Step

The Step record mode lets you enter each track note-by-note, with precise control over the timing, length, and loudness of each note. You can record entire tracks using the Step mode, or use it to brush-up and add data to an existing track. The Step record mode lets you record extremely fast or complex passages that would be impossible to play in real time.

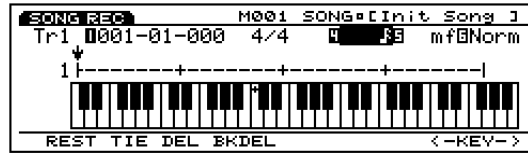

● Multi

The Song and Pattern modes also provide a “Multi” real-time record mode in which all 16 or 8 tracks can be recorded simultaneously. This can be used if, for example, you need to record an entire sequence from an external sequencer or computer via MIDI. On the EX5 and EX7 to record one track from the EX keyboard while recording the rest via MIDI.

■ Sequence Editing

Sequence editing can be accomplished both via a comprehensive selection of “jobs,” and via an in-depth edit mode.

The jobs include a range of functions which can be used to modify all or a portion of a track or sequence in a variety of ways. You have a range of quantization options, clock shift, gate and velocity modification, transposition, data extraction, chord sorting, and much more.

The in-depth editing capabilities of the EX5, EX5R, and EX7 make it easy to correct mistakes made when recording songs, patterns, or arpeggios, and to generally refine your sound. The Song, Pattern, and Arpeggio edit “change” mode lets you individually modify the timing, pitch, gate time (length) and velocity (loudness) of each note in the song or pattern. There's also an edit “insert” mode that allows insertion of note, program change, sustain on/off, pitch bend, modulation, pan, volume, expression, and other events at any point in the sequence.

NOTE Song jobs on page 206, editing details on page 201.

NOTE Pattern jobs on page 227, editing details on page 226.

NOTE Arpeggio jobs on page 249, editing details on page 247.

IMPORTANT When the power is turned off, all sequence data, song, pattern and arpeggio, will be lost. Please remember that important sequence data should be saved to floppy disk or other optional backup device (page 259).

Play Effects & Groove Quantization

An important feature of all EX sequencer functions is “Play Effects,” ... including “Groove Quantization.” Play Effects affect song, pattern, or arpeggio playback in real time, and are not actually recorded with the sequence data. The Play Effects include Groove Quantization and a range of offset parameters affecting overall clock timing, velocity, gate time, and transposition.

“Groove Quantization” is different from standard quantization in that specific beats within a track are shifted away from precise on-the-beat timing to create a natural “groove.” Both the timing and velocity of certain notes can be affected by groove quantization. This means that unlike standard quantization, which can make a sequence sound cold and mechanical, groove quantization can significantly enhance the feel of a track.

100 preset groove “templates” are provided that you can simply select and use. Each groove template affects different beats in different ways, thus creating different grooves. See the separate Data List book for a complete list of the available groove templates. There’s also a Groove Editor in which you can create your own groove template by specifying the precise timing and velocity for each beat.

SONG PLAY		M001 SONG=[Init Song 1]	
[1] Trk: Play Effect			
-Groove-	Val= J+J8	Typ= 032:16	House
Str=	32%	Tim= 4%	Vel= 176% Gat= 4%
-Offset-	Rate-		
Clk= +768	Vel= + 0	Vel= 0%	Gat= 176%
Trns= -	1		
SONG [PEX]	TCH NAME	ALL	TR GROOVE

NOTE Groove editing details on page 190.

The EX Effect System

The EX effect system is not an “extra.” It is a top-quality digital signal processing system which is capable of producing effects rivalling and even exceeding those of many separate component effect units in quality. In the EX5, EX5R, and EX7, effect programming is an integral and important part of voice programming, and the ability to control specific effect parameters in real time makes them indispensable for expressive control as well.

Two main effect types are provided: “system” and “insertion.” System effects apply to the overall sound, whether it be a voice, an entire performance setup, a song, etc. Insertion effects, on the other hand, can be applied individually to each voice so, in a performance setup which uses four voices, for example, you could have completely different insertion effects applied to each voice, plus overall system effects which apply to all voices in the performance setup.

System Effects

Two system effect “units” are provided for overall sound enhancement: Reverb and Chorus.

■ Reverb

The Reverb effect unit provides 12 different reverb-related effects including realistic simulations of the natural reverberation in various halls and rooms. Independent reverb settings can be made for each voice in the Voice mode, and for each performance setup in the Performance mode.

NOTE Effect parameter details begin on page 105.

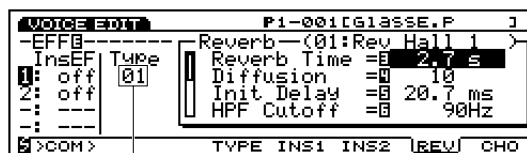

Currently selected reverb type

■ Chorus

The Chorus effect unit includes a selection of 17 chorus-type effects, including flanging, phasing, symphonic, and others. Most of these effects are ideal for thickening and adding animation to the sound. Independent chorus settings can be made for each voice in the Voice mode, and for each performance setup in the Performance mode.

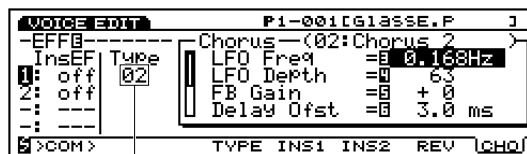

Currently selected Chorus type

NOTE See the Data List book for a complete list of the available system effects.

Insertion Effects

Two insertion effect units are provided in addition to the Reverb and Chorus system effect units described above. The Effect 1 unit includes 24 effects including chorus, distortion and overdrive, amp simulation, auto wah, equalization and more. The Effect 2 unit adds a range delay, reverb, and other effects, providing a total of 79 effects. In the Voice mode the insertion effects can be individually applied to each voice, and can be individually turned on or off for each element within the voice. In the Performance mode the insertion effects programmed for each voice within the performance setup can be turned on or off as required.

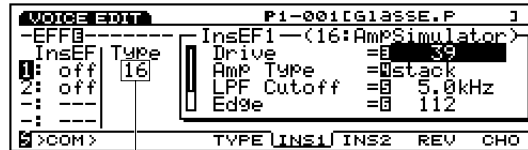

Currently selected effect type

NOTE See the Data List book for a complete list of the available insertion effects.

Effects In the Voice Mode

In the Voice mode, independent effect types and parameter settings can be programmed for each effect unit (Reverb, Chorus, Insertion Effect) and stored with each voice. Furthermore, the two insertion effects can be independently turned on or off for each voice element. It is also possible to specify the insertion effect connection mode (series or parallel), and specify the order of the effect units when series connection is used. The combined signal from all voice elements — after application of the insertion effects — is applied to the Reverb and Chorus system effect units.

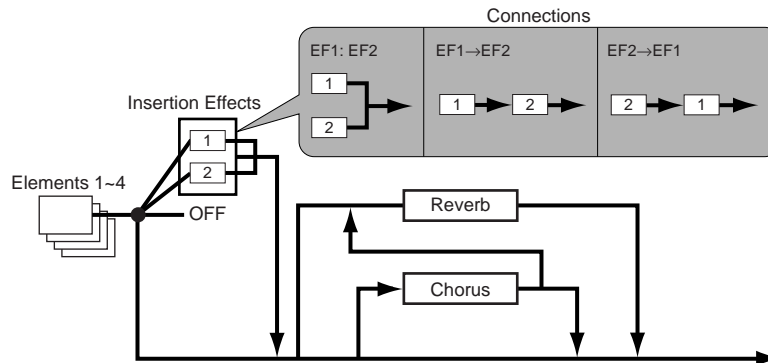

NOTE Voice mode effect assignment details on page 105.

Effects In the Performance Mode

In the Performance mode the insertion effects apply to the voices exactly as they were set up in the Voice mode. The Voice mode Reverb and Chorus unit settings, however, are not used in the Performance mode. In the Performance mode each part has Reverb Send and Chorus Send parameters which determine how much Reverb or Chorus is applied to the corresponding part. The insertion effects set up in the Voice mode can be turned on or off for each part in the Performance mode.

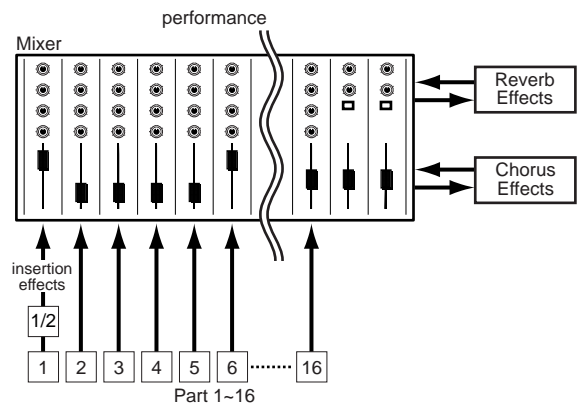

NOTE Performance mode effect details on page 161.

Effect Bypass

You can temporarily turn specified types of effects “off” or “on” by simply pressing the panel [EF BYPASS] ([BYPASS] on the EX5R) key. To use this function, you will need to specify the effect to be bypassed in the Utility mode Other Setup display (page 276).

DSP Limitations

The DSP (Digital Signal Processing) system used to create the EX effects is also used by the AN, FDSP, and VL (EX5/5R only) tone generators to create voices. This means that less DSP capacity is available to produce effects when the aforementioned voice types are used. This imposes limitations which are different for the EX5/5R and EX7. The Reverb and Chorus effect units function normally regardless of the type of voice used.

EX5/5R

There are no limitations to using insertion effects in the EX5 or EX5R Voice mode. In the Performance mode, however, insertion effects can be used on a maximum of 4 parts (voices) if the performance setup consists entirely of AWM voices. If a VL, AN, or FDSP voice is used in the performance setup, however, an insertion effect can only be used on one part (voice).

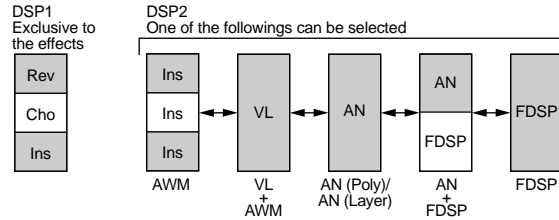

EX7

In the EX7 Voice mode, Insertion effects can be used in AWM voices, but not in any other voice type (AN or FDSP). In the Performance mode, if the performance setup consists of only AWM voices, then an insertion effect may be used on one voice. But if the performance setup includes an AN or FDSP voice, then no insertion effects can be used.

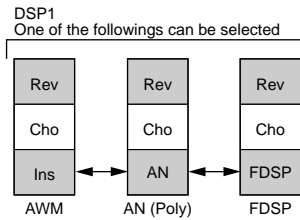

Sampling

The EX Sample mode lets you “sample” sounds via a microphone or line source which can be used in AWM voice elements (samples are assigned to voice elements via the Voice Edit OSC display — page 80), or mapped to individual keys of the keyboard in the Key Map mode (page 72). It is also possible to sample directly from the internal EX tone generator system, so you can sample sounds and phrases for Key Mapping, for example, without requiring any external equipment at all. The Sample mode also includes a range of wave editing features which can be used to “fine tune” your samples for optimum sound.

During use samples are kept in the internal wave RAM memory. The EX5, EX5R, and EX7 are supplied with a 1-megabyte wave memory which can be expanded up to 65 megabytes by installing optional SIMM memory modules (page 278). An additional 8 megabytes of non-volatile flash memory becomes available for sample storage if the optional EXFLM1 Flash Memory Board is installed (page 278). Sampled waveforms can be saved to floppy disk, or to an external storage device via the optional ASIB1 SCSI Interface (page 278). Wave files in standard WAV, AIFF, or AKAI format produced using other equipment can also be loaded via the Disk mode Load Wave function (page 266) and used by the EX5, EX5R, and EX7.

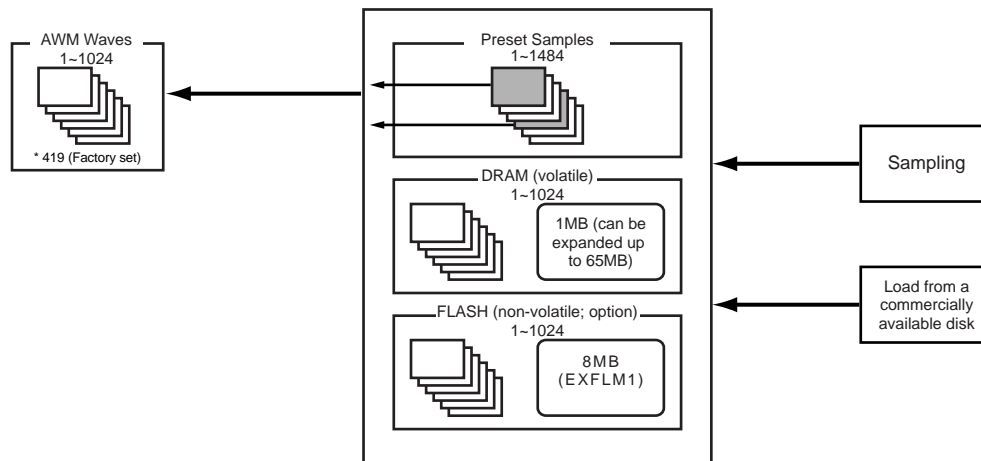

Setting Up and Sampling From an External Source

■ Connecting the Source

The first step in setting up for sampling from an external source is to connect your source — microphone or line — to the EX5, EX5R, or EX7. If you will be using a single microphone, connect it to the L/MONO A/D INPUT jack on the EX5 or EX5R (the EX7 only has a single A/D INPUT jack). If you will be using a pair of microphones with the EX5 or EX5R, connect them to the L/MONO and R A/D INPUT jacks. Standard dynamic microphones with an impedance of about 150 ohms are recommended (the EX instruments do not support phantom-powered condenser microphones).

■ Record Mode & Input Settings

Once your sources are connected as required (if you will be sampling from an external source), press the [SAMPLE] key to engage the Sample mode, and then the [F8] function key (“[REC]”) to go to the SAMPLE REC display.

If you are sampling with an EX5 or EX5R, you will need to set the Rec Mode parameter for mono or stereo sampling (this is not necessary with the EX7, since it has a MONO A/D INPUT):

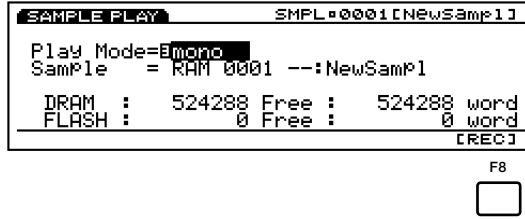

L	Sample from the L A/D INPUT only
R	Sample from the R A/D INPUT only
L+R	Combine input from the L and R A/D INPUT jacks to a mono sample.
stereo	stereo Sample the L and R A/D INPUT signals to separate files.

Also be sure to set the Source parameter to “A/D” if you are sampling from an external source, and the mic/line parameter to “mic” if you will be sampling from a microphone, or “line” if you will be sampling from a CD player or other line source.

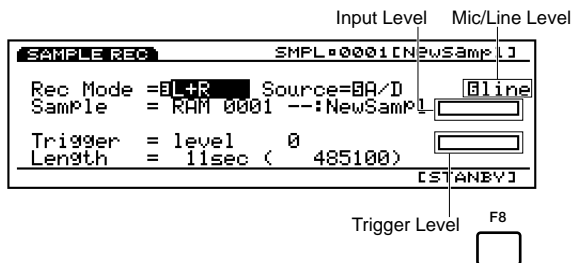

When sampling from a line source with the EX7, you may have to use a stereo-to-mono cable or a “Y” cable to combine the left- and right-channel output signals from the source device for input to the EX7’s mono A/D INPUT jack.

■ Setting Levels

Once your source is connected and the Rec Mode, Source, and mic/line parameters have been set as required, you can use the A/D GAIN control in conjunction with the bar-graph level indicator(s) to the right of the new sample name(s) to set the optimum input level.

Begin with the A/D GAIN control set all the way to the MIN position, and play your source at the highest expected volume. Gradually rotate the A/D GAIN control clockwise until the bar graph extends to around 80 % or 90 % of its maximum length. This should be approximately the optimum level setting for your source.

If the bar graph extends all the way to the right regardless of the setting of the A/D GAIN control, the output level of your source is probably too high. Compensate by reducing the output level of the source device.

■ Recording the Sample

After making sure that your source is properly connected and the input parameters and levels are set, set the Trigger Level if necessary (page 177), set the desired maximum length of the sample via the Length parameter (page 177), and press the [F8] function key (“[STANDBY]”). “Waiting ...” will appear on the display.

Play your source and sampling will begin automatically as soon as a signal which exceeds the Trigger Level is detected. You can also start sampling manually by pressing the [F8] function key, which at this point will have changed to “[START].” After sampling has started (“Now recording” will appear on the display), the [F8] function key will change to “[STOP],” and you can stop recording at any time by pressing it. Sampling will continue for the amount of time specified by the Length parameter, or until the end of the sample memory is reached, if not stopped manually.

NOTE The EX5, EX5R, and EX7 record at a sample rate of 44.1 kHz.

NOTE See page 176 for details on sampling from the internal tone generators.

■ Edit the Sample

Once you have successfully recorded a sample, use the Sample Jobs (page 182) and Sample Edit mode (page 179) to normalize, extract, tune, loop, and otherwise refine your sample as required.

Save Samples to Disk

Please note that the standard EX sample memory is volatile. That means that its contents will be lost when the power is turned off. The 8-megabyte flash memory provided on the optional EXFLM1 Flash Memory Board is non-volatile, and will retain samples which have been saved to it even when the EX power is off. Since it is only possible to record to the volatile RAM sample memory, you will have to use the Copy Sample job (page 183) to copy samples to the flash memory.

Whether you have installed the optional flash memory or not, it is always a good idea (essential if you only have volatile RAM) to save samples you want to keep to disk via the Disk mode Save Wave function (page 264).

The Key Map Mode

The EX Key Map mode allows you to assign individual samples, patterns, or pattern tracks to different keys of the keyboard (or MIDI note numbers in the case of the EX5R). The assigned samples and/or patterns can then be played via the EX5/EX7, or via an external sequencer or other MIDI controller on all models. Key Mapping makes it possible, for example, to combine playback of looped rhythm samples with patterns to create new rhythmic textures that can be controlled “live,” in real time.

Key Mapping Procedure

1 Engage the Key Map mode

Press the [KEYMAP] key to engage the Key Map mode. Non-assigned notes are listed as “off” on the display. (If necessary, press the [F1] key to select the Mode screen.)

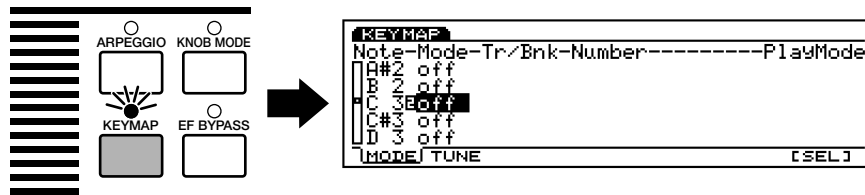

NOTE [KEYMAP] key functions (can be turned on or off) when in Voice mode, Performance mode and Song mode.

2 Select a note

Select a note to which you want to map a sample or pattern either by using the cursor ▲ and ▼ keys to highlight the desired note on the display (the note list will scroll up or down as required), or press the desired key on the keyboard while holding the [F8] function key (“[SEL]”).

3 Select pattern or sample assignment

Use the Data Dial, [DEC]/[INC] keys, or Controller Knob 2 to select “ptn” if you want to assign a pattern to the key, or “smp” if you want to assign a sample to the key.

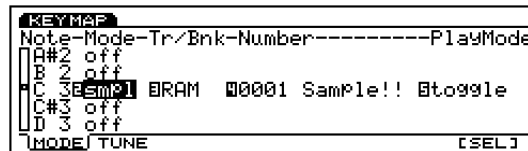
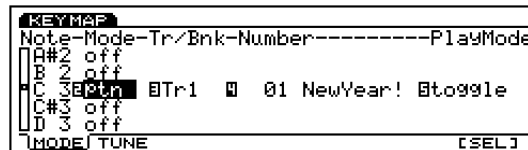

4 Specify a pattern or sample

If you chose to map a pattern to the selected note, use the cursor keys in conjunction with the Data Dial, [DEC]/[INC] keys, or appropriate Controller Knobs to specify a track — “Tr1 ... Tr8” for an individual track, or “all” to map the entire pattern — and the pattern number (the pattern name will appear to the right of the pattern number).

```

KEYMAP
Note-Mode-Tr/Bnk-Number-----PlayMode
C#3 ptn  E[Tr1]  01  NewYear!  toggle
C#3 ptn  Tr2    02  NewTrack  toggle
D#3 ptn  Tr3    03  NewYear3  toggle
D#3 ptn  Tr4    04  NewTrack  toggle
E#3 ptn  all    01  NewYear!  toggle
[MODE] TUNE                                [SEL]
  
```

If you chose to map a sample to the selected note, use the cursor keys in conjunction with the Data Dial, [DEC]/[INC] keys, or appropriate Controller Knobs to specify the “RAM” (internal) or “FLS” (flash memory, if the optional EXFLM1 Flash Memory Board is installed) sample memory, and the number of the desired sample (the sample name will appear to the right of the sample number).

```

KEYMAP
Note-Mode-Tr/Bnk-Number-----PlayMode
C#3 smp1  RAM   0001  Sample!!  toggle
C#3 smp1  RAM   0002  NewSamp1  toggle
D#3 smp1  E[RAM] 0003  NewSamp1  toggle
D#3 smp1  FLS   0004  NewSamp1  toggle
E#3 smp1  FLS   0001  NewSamp1  toggle
[MODE] TUNE                                [SEL]
  
```

5 Specify a play mode

The rightmost parameter on the display, following the pattern or sample number, specifies the play mode for the corresponding key.

toggle	Pattern or sample playback begins when the key is pressed, and stops when the key is pressed a second time.
oneshot	The pattern or sample begins playing when the key is pressed, and stops automatically when the pattern or sample has played completely through once.
gating	Pattern or sample playback starts when the key is pressed and stops when the key is released.

6 Continue as required

Repeat the above process, mapping as many patterns or samples to as many keys as required.

- NOTE** The Key Map assignments will always be erased when the power is turned off. If you want to keep a Key Map setup, use the Disk mode Save ALL option to save all data to disk.
- NOTE** Only one sample, pattern, or pattern track can be assigned to each key.
- NOTE** The number of samples available for key mapping will depend on the number of samples currently in the EX sample memory (max. 1024).

About The Tune Screen

Pressing the [F2] key selects the Tune screen, which is only available for samples and includes two tune-related parameters: Coarse and Fine.

```
KEYMAP
Note-Mode-Tr/Bnk-Number-----Coarse-Fine
A#2 off
B 2 off
C 3 SEMPR1 BRAM 00001 NewSamp1 B+ 0 B-64
C#3 off
D 3 off
MODE [TUNE] [SEL]
```

Coarse: Raises or lowers the pitch of each sample in semitone steps.

Settings: -64 ~ +63

Fine: Allows fine adjustment of the pitch of each element.

Settings: -64 ~ +63

Using these two parameters you can adjust the playback speed of EX samples as well as data recorded at different sampling rates.

Reference Section

Voice Mode

Voice Play Mode

Voice Play Mode lets you play the 256 Preset Voices and User Voices of your own creation.

Voice Play Mode screen

Press [VOICE] key on the panel to enter Voice Play mode. When you enter Voice Play mode, the following screen appears. The contents are shown below.

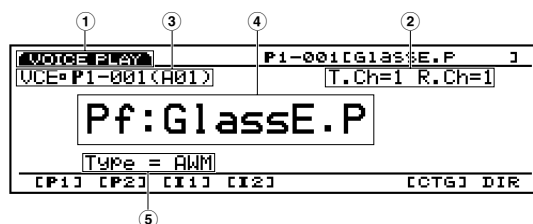

① Screen Title

Indicates Voice Play mode.

② Transmit Channel/Receive Channel

Indicates which MIDI channel is used for the voices in the Voice mode. The transmit/receive channels are set in the Voice Mode Setup, Utility mode (page 271).

③ Voice Number area

Shows the Memory location, Program number (001 ~ 128) and Bank(A ~ H)/Program number (1 ~ 16) for the currently selected voice. For example, the displayed voice number, P1-001(A01) indicates that this is the 001 voice in Preset 1 memory location and is the 01 voice in the Bank A.

Memory

There are two types of memories: Preset and Internal (user). Each Preset—P1 (Preset 1) and P2 (Preset 2)—contain 128 preset voices. Each Internal—I1 (Internal 1) and I2 (Internal 2)—contain 128 user areas for your own voice creation.

Voice Number

Voice numbers are indicated in two ways as shown below: from 1 through 128 or 8 (A ~ H) banks of 16 voices each (8 x 16 = 128).

Voice Number	Bank	Program Number	Voice Number	Bank	Program Number
001	A	1	065	E	1
002	A	2	066	E	2
003	A	3	067	E	3
004	A	4	068	E	4
005	A	5	069	E	5
006	A	6	070	E	6
007	A	7	071	E	7
008	A	8	072	E	8
009	A	9	073	E	9
010	A	10	074	E	10
011	A	11	075	E	11
012	A	12	076	E	12
013	A	13	077	E	13
014	A	14	078	E	14
015	A	15	079	E	15
016	A	16	080	E	16
017	B	1	081	F	1
018	B	2	082	F	2
019	B	3	083	F	3
020	B	4	084	F	4
021	B	5	085	F	5
022	B	6	086	F	6
023	B	7	087	F	7
024	B	8	088	F	8
025	B	9	089	F	9
026	B	10	090	F	10
027	B	11	091	F	11
028	B	12	092	F	12
029	B	13	093	F	13
030	B	14	094	F	14
031	B	15	095	F	15
032	B	16	096	F	16
033	C	1	097	G	1
034	C	2	098	G	2
035	C	3	099	G	3
036	C	4	100	G	4
037	C	5	101	G	5
038	C	6	102	G	6
039	C	7	103	G	7
040	C	8	104	G	8
041	C	9	105	G	9
042	C	10	106	G	10
043	C	11	107	G	11
044	C	12	108	G	12
045	C	13	109	G	13
046	C	14	110	G	14
047	C	15	111	G	15
048	C	16	112	G	16
049	D	1	113	H	1
050	D	2	114	H	2
051	D	3	115	H	3
052	D	4	116	H	4
053	D	5	117	H	5
054	D	6	118	H	6
055	D	7	119	H	7
056	D	8	120	H	8
057	D	9	121	H	9
058	D	10	122	H	10
059	D	11	123	H	11
060	D	12	124	H	12
061	D	13	125	H	13
062	D	14	126	H	14
063	D	15	127	H	15
064	D	16	128	H	16

④ Voice Category/Name

Voice Category

The respective voices are organized into the two-letter-code Voice Categories. Each Category code implies the voice's property.

LCD	Category	LCD	Category
--	No Assign	Pd	Synth Pad
Pf	Piano	Fx	Synth Sound Effects
Cp	Chromatic Percussion	Et	Ethnic
Or	Organ	Pc	Percussive
Gt	Guitar	Se	Sound Effects
Ba	Bass	Dr	Drums
St	Strings/Orchestral	Sc	Synth Comping
En	Ensemble	Vo	Vocal
Br	Brass	Co	Combination
Rd	Reed	Wv	Material Wave
Pi	Pipe	Sq	Sequence
Ld	Synth Lead		

Voice Name

Shows the current voice name in up to 12 letters.

⑤ Voice Type

Indicates the voice type of the current voice.

NOTE For more information on the voice type, see page 77.

Selecting Voices

Various methods are available for selecting voices. See page 36 for more information.

Voice Mode Setup

You can set up the connections with the internal tone generator and/or an external device for the voices in the Voice mode and assign the control numbers, in the Voice Mode Setup, Utility mode (page 271).

Voice Edit Mode

There are two types of voices: a normal voice and a drum voice. The edit parameters for each type of voice are explained separately, as are the different types of elements that make up a normal voice.

NOTE For more information about voices, see page 43. For more information about elements, see page 43.

[VOICE]	
Normal + [EDIT] AWM Element	77
[F1:COMMON]	77
[F6:Parameter]	77
[F7:Arpeggio]	79
[F3:Arpeggio-Edit]	79
[F8:Name]	79
[F2:OSCILLATOR]	80
[F6:Wave]	80
[F3:Wave-Edit]	81
[F7:Mix]	81
[F8:Zone]	82
[F3:PITCH]	83
[F6:Parameter]	83
[F7:Scaling]	83
[F8:EG]	84
[F4:FILTER]	86
[F4:Static Control Filter]	86
[F5:Dynamic Control Filter]	91
[F6:Sensitivity]	93
[F7:Scaling]	94
[F8:EG]	95
[F5:AMPLITUDE]	96
[F6:Parameter]	96
[F7:Scaling]	97
[F8:EG]	98
[F6:LFO]	100
[F7:LFO1]	100
[F8:LFO2]	102
[F7:CONTROLLER]	103
[F7:Pitch Control]	103
[F8:Controller Set]	104
[F3:Remap]	104
[F8:EFFECT]	105
[F4:Type]	105
[F5:Insertion Effect 1]	106
[F6:Insertion Effect 2]	106
[F7:Reverb]	107
[F8:Chorus]	107
Normal + [EDIT] VL Element	107
Normal + [EDIT] AN Element	112
FDSP	123
Drum + [EDIT]	141

Press [EDIT] key on the panel while in Voice mode to enter Voice Edit mode. When you enter Voice Edit mode, the following menu appears. Below are the eight menus in Voice Edit mode.

NOTE Before entering Voice Edit mode, select the voice to be edited. All parameters within a voice can be edited and stored as a new voice.

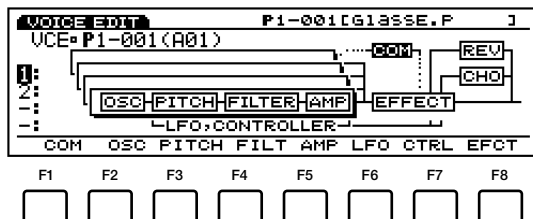

- [F1]: COM (Common settings equally applied to all elements)
- [F2]: OSC (Tone generator settings related to Oscillator)
- [F3]: PITCH (Settings related to Pitch)
- [F4]: FILT (Settings related to Filter, for tone)
- [F5]: AMP (Settings related to Amplitude, for volume)
- [F6]: LFO (Settings related to the Low Frequency Oscillator, for modulation)
- [F7]: CTRL (Settings related to the Controllers)
- [F8]: EFCT (Settings related to the Effects)

Element Mute

During voice edit you may need to temporarily mute the rest elements. For information on how to mute each element, see page 44.

Compare and Store

The moment you alter any parameter in the Voice Edit mode a small inverse “E” will appear at the top left on the display, indicating that the voice has been edited but not yet stored.

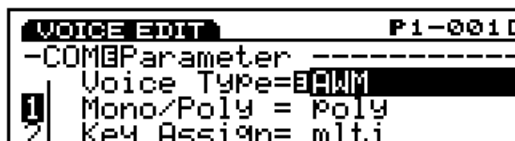

You can also press the [EDIT/COMPARE] key while in the edit mode to switch back and forth between the original and edited sound (an inverse “E” appears at the top left when the Compare function is engaged – i.e. the original sound is being monitored).

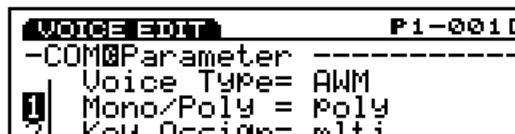

When you exit from the Voice Edit mode the “E” will remain at the top left on the display until you either store the edited voice or select a different voice number or mode. If you do select a different voice number or mode prior to storing the edited voice, the edited data will be lost! So be sure to store edited voice data you want to keep, as described on page 48.

NOTE Compare function is not available, when the voice type is changed.

NOTE If you want to create a voice from scratch, it will be handy to use initialize voice function (Voice Job mode, see page 148) to initialize the voice you have selected.

NOTE Up to 1024 elements can be stored onto your EX.

Normal Voice (AWM Element)

[F1]: COM (Common)

Common Edit includes settings that affect all elements (maximum four) in a selected voice. There are three menus available.

- [F6]: PARAM (Parameters)
- [F7]: ARP (Arpeggio)
- [F3]: [ARP EDIT]
- [F8]: NAME (Name)

[F6]: PARAM (Parameters)

Various control parameters such as Voice Type determine the fundamental characteristics of a voice.

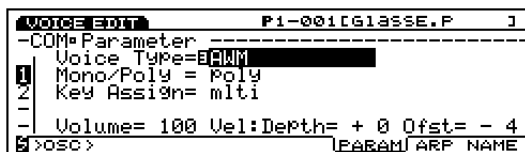

Voice Type

For selecting the type of voice. Selecting a voice type also determines the type of elements that are used in the voice.

Settings:

AWM:

Uses up to a maximum of four AWM elements. AWM elements are digitally recorded waveforms, or “samples” of musical instrument and other sounds.

VL + AWM (EX5/5R only):

Uses one VL element for Virtual Acoustic synthesis, plus three AWM elements. Once the VL voice type is selected, the first element in the OSC screen (page 108) is fixed to the VL element.

FDSP (Formulated Digital Sound Processing):

Uses each of the four AWM elements (up to a maximum of four), which are applied to the FDSP unit. Once the FDSP type is selected, the FDSP menu will also display. It can be accessed using [F5] at the bottom of the COM screen (see page 123).

AN (Poly) + AWM (“AN + AWM” on EX7):

Uses one AN element for Analog Physical Modeling synthesis, plus three AWM elements. Once the Analog Poly is selected, the first element in the OSC screen (page 113) is fixed to the AN element.

AN (Layer) + AWM (EX5/5R only):

This type can use two AN elements for Analog Physical Modeling, plus two AWM elements. This allows for the two AN elements to be layered. Once the Analog Layer is selected, the first and second element in the OSC screen (see page 113) are fixed to AN elements.

AN + FDSP (EX5/5R only):

This type can use one AN element for Analog Physical Modeling synthesis, plus the three AWM elements, which can be applied to the FDSP unit. Once Analog + FDSP is selected, use [F5] at the bottom of the COM screen to access the FDSP menu (see page 123). Also, the first element in the OSC screen (page 113) is fixed to an AN element.

Drum:

Uses up to a maximum of 128 AWM elements, each assigned to a specific key or note number.

NOTE The available parameters and the edit menu in the Voice Edit mode will change according to the selected voice type. For more information about VL, see page 30; FDSP: page 34; Analog: page 33; Drum: page 39.

Polyphony

The maximum polyphony of the EX5 and EX5R is 126 notes, and the maximum polyphony of the EX7 is 64 notes. Full polyphony, however, is not available for all voice types. The chart below lists the maximum polyphony for each voice type.

Voice Type	EX5/5R Polyphony	EX7 Polyphony
AWM/Drum*	126	64
VL+AWM	1+AWM	—
FDSP	16	8
AN(Poly)+AWM	2+AWM	1+AWM
AN(Layer)+AWM	1+AWM	—
AN+FDSP	AN: 1; FDSP: 8	—

*Please note that the actual polyphony may be reduced under certain conditions.

DSP Limitations

The DSP (Digital Signal Processing) system used to create the EX effects is also used by the AN, FDSP, and VL (EX5/5R only) tone generators to create voices. This means that less DSP capacity is available to produce effects when the aforementioned voice types are used. This imposes limitations which are different for the EX5/5R and EX7. The Reverb and Chorus effect units function normally regardless of the type of voice used.

EX5/5R

There are no limitations to using insertion effects in the EX5 or EX5R Voice mode. In the Performance mode, however, insertion effects can be used on a maximum of 4 parts (voices) if the performance setup consists entirely of AWM voices. If a VL, AN, or FDSP voice is used in the performance setup, however, an insertion effect can only be used on one part (voice).

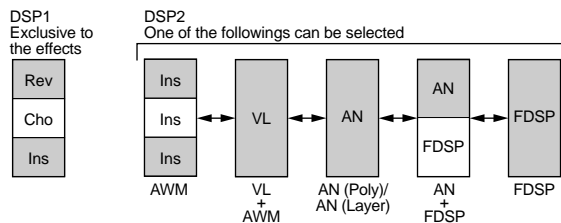

EX7

In the EX7 Voice mode, Insertion effects can be used in AWM voices, but not in any other voice type (AN or FDSP). In the Performance mode, if the performance setup consists of only AWM voices, then an insertion effect may be used on one voice. But if the performance setup includes an AN or FDSP voice, then no insertion effects can be used.

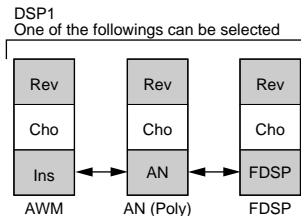

■ Mono/Poly

Selects whether the voice is played monophonically (only one note at a time) or polyphonically (multiple notes sounding simultaneously).

❑ **Settings:** mono, poly

■ Key Assign

Selects snl (single) or mlti (multi) Key Assign. In snl (single), if the tone generator receives the same note twice, the first note is terminated when the next same note is received again. In mlti (multi), when the same notes are received, sounds are assigned to one channel after another, making multiple part tone generation possible.

❑ **Settings:** snl, mlti

■ Volume

Sets the volume of the voice.

❑ **Settings:** 0 ~ 127

■ Vel Depth (Velocity Depth)

Determines the depth of velocity sensitivity.

❑ **Settings:** -64 ~ 0 ~ +63

■ Vel Offset (Velocity Offset)

Sets the velocity offset value.

❑ **Settings:** -64 ~ 0 ~ +63

NOTE Changing the value will add to or subtract from the current velocity value.

[F7]: ARP (Arpeggio)

Following are the parameters related to the Arpeggiator.

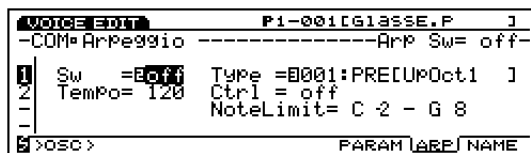

■ Arp Sw (Arpeggio Switch)

Turns the Arpeggiator on and off.

❑ **Settings:** on, off

NOTE The ARPEGGIO key on the front panel serves the same function.

■ Arp Type (Arpeggio Type)

Selects the type of arpeggio.

❑ **Settings:** See the Arpeggio Type on page 242.

■ Arp Tempo (Arpeggio Tempo)

Sets the tempo for the arpeggio.

❑ **Settings:** 30 ~ 250

■ Tempo Ctrl (Tempo Control)

Sets whether one of the Knobs controls the arpeggio tempo, or not.

❑ **Settings:** off, knob 1 ~ 6

■ Arp Note LimitL (Note Limit Low)

Determines the lowest note of the arpeggio range on the keyboard.

❑ **Settings:** C-2 ~ G8

NOTE The lowest note set here and the note set for Arp Note High (Note Limit High; see below) determine the range of notes within which the arpeggio will play.

■ Arp Note LimitH (Note Limit High)

Determines the highest note of the arpeggio range on the keyboard.

❑ **Settings:** C-2 ~ G8

[F3]: ARP-EDIT (Arpeggio Edit)

Once the “USR” (USER) arpeggio type is selected, the ARP EDIT menu is accessible using [F3] at the bottom of the screen. Press [F3] to access the ARP EDIT screen, which lets you create your own custom arpeggio type (User arpeggio). For more information, see page 238.

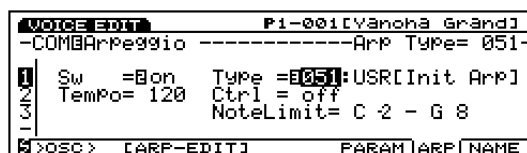

[F8]: NAME

Lets you name the edited voice, using up to twelve characters.

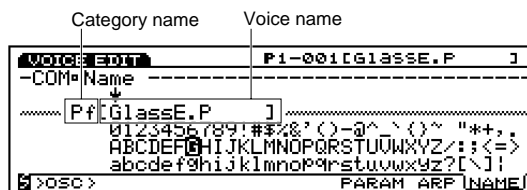

Setting the Voice Name

- Press [F8] to enter the Name screen.
 - Move the [↓] cursor to the far left with the Cursor key.
 - Use [INC]/[DEC] or Data Dial to select the Category.
- NOTE** The category names help you to sort the voices you have created. If you don't want to specify the name, select hyphens (--), no assign.
- Move the [↓] cursor to the Name.
 - Use [INC]/[DEC] or Data Dial to select a letter, number, or symbol.
 - Move the [↓] Cursor with the cursor keys and select the next character.
 - Repeat the operations above to set the file name.

You can also enter numbers, letters, or symbols using the numeric keypad. Several letters or symbols are assigned to each key (the letters or symbols listed below correspond to the key above). Upper and Lower case letters are available. For example, each time the 0 key is pressed, the available number and letters are displayed in the following order: 0→A→B→C→a→b→c. "SPACE" (one space) is assigned to [ENTER] key. You can move through the input locations using the cursor key as mentioned above.

Available numbers and letters:
Shown in the above illustration.

[F2]: OSC (Oscillator)

The Oscillator parameters generate the sound waves that create a voice. A voice consists of a maximum of four elements (see page 29). You can select the wave for each element and make adjustments to various parameters. There are four menus available.

[F6]: WAVE

[F3]: WAVE-EDIT

[F7]: MIX

[F8]: ZONE

[F6]: WAVE

Selects the waves for the elements (maximum four elements per voice), and sets parameters related to the Loop configuration for each wave.

VOICE EDIT		P1-001GLASSE.P		J	
EL1	OSC Wave	Bank=	PRE		
	Bank Num	Cat	WavePlay	Delay	
1	PRE 0033	OC: Gam1n1	default	0	
2	PRE 0034	Pf: DXTS	default	0	
[F]FIT>			[WAVE]MIX ZONE		

Bank (Wave Bank)

In the selected Voice Bank, this parameter lets you choose a wave bank which contains available waves. You can designate a different bank for each element.

- Settings:** PRE (Preset), RAM (DRAM), FLS (Flash Memory)

NOTE When an element is not used, hyphens (--) will be displayed in the bank and the cursor will not be able to select Num (Number) and some other items.

Number

In the selected wave bank, this parameter lets you select the wave number you want. After the number is selected, the wave category letter and wave name are displayed to the right of the number.

- Settings:** (For information about each wave, see the Wave List in the separate Data List book.)

NOTE Some waves may not contain the category names.

Cat (Category)

Selects the category containing the wave you want to use. Replacing the category from one to another selects the first wave in the newly selected category.

- Settings:** See the following list.

LCD	Category	LCD	Category
--	No Assign	Pd	Synth Pad
Pf	Piano	Fx	Synth Sound Effects
Cp	Chromatic Percussion	Et	Ethnic
Or	Organ	Pc	Percussive
Gt	Guitar	Se	Sound Effects
Ba	Bass	Dr	Drums
St	Strings/Orchestral	Sc	Synth Comping
En	Ensemble	Vo	Vocal
Br	Brass	Co	Combination
Rd	Reed	Wv	Material Wave
Pi	Pipe	Sq	Sequence
Ld	Synth Lead		

NOTE Hyphens displayed at the category indicate that the current wave is not assigned with a category.

■ Wave Play

Switches how the wave is played back. There are five choices: “FwdLp,” “FwdLpEx,” “FwdNoLp,” “RevNoLp” or “default.”

□ Settings:

FwdLp:

While a key is pressed (held down), the wave playback begins from the Start point, moves to the Top point and then repeats continuously from the Top point to the End point.

FwdLpEx:

This is the same as “FwdLp” as long as the key is held. However, when you release your finger from the keyboard, the Ex5/5R/7 cancels the loop playback, goes beyond the End point, and plays the rest of the sample data, then stops at the data end.

FwdNoLp:

Each time a key is played, the wave will play back one time from the Start point to the End point.

RevNoLp:

Each time a key is played, the wave will play back in reverse one time, from the End point to the Start point.

default:

Follows the original setting made in the Wave Edit mode or Sample Edit mode.

■ KeyOn Delay

Sets the amount of delay from the point at which the note is played on the keyboard, to when the sound is produced. A different KeyOn delay amount can be set for each element.

□ Settings: 0 ~ 127

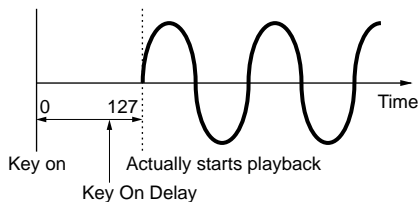

[F3]: WAVE-EDIT

Lets you edit waves. When you select “RAM” for the Wave Bank, [F3] (WAVE-EDIT) will be added, allowing you to edit waves. For more information about WAVE EDIT, see page 150.

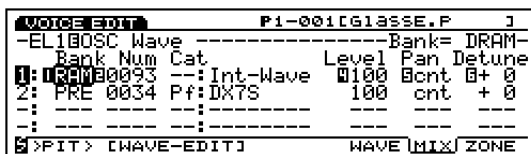

NOTE When PRE (Preset) or FLS (Flash memory) is selected in WAVE, the WAVE-EDIT screen is unavailable.

[F7]: MIX

Sets the output balance between the various element waves that make up a voice.

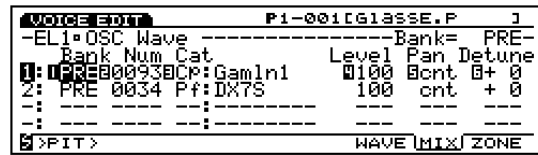

■ Bank (Wave Bank)

■ Number

■ Cat (Category)

These parameters are the same as those described for the WAVE screen. For information, see page 80.

■ Level

Sets the output level of each wave, which lets you adjust the output balance between each element.

□ Settings: 0 ~ 127

■ Pan

Sets the panning of each wave. This function determines the left or right positioning of each element in the stereo spectrum.

□ Settings: scl (Scaling Pan), L63 (far left) ~ cnt (center) ~ R63 (far right), rnd (Random Pan)

NOTE In scl (Scaling Pan), a base pitch is set as a reference that determines the degree to which a sound moves to the right or left in the stereo spectrum. Control depends on the pitch that is played on the keyboard in relation to the base pitch. Rnd (Random Pan) causes the sound to appear randomly from left to right in the stereo spectrum. For Scaling Pan and Random Pan settings, the fixed range of the sound movement and the standard pitch is designated in KeyFlw (Key Follow), and Pan parameters in the PARAM screen of AMP (Amplitude).

■ Detune

Sets the detune value for each wave. Detune is handy for making the sound thicker by raising or lowering the pitch of each individual element in fine increments or decrements, in relation to each other.

□ Settings: -75 ~ 0 ~ + 75

NOTE The Level, Pan & Detune parameters are also available from the PITCH PARAM screen.

[F8]: ZONE

Sets the zone of each element (the keyboard and velocity ranges within which the sounds are played). A different zone can be set for each element.

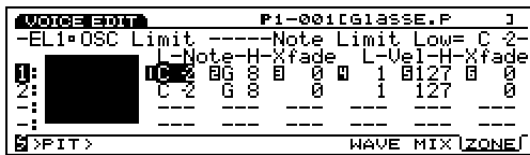

Note Limit Low

Sets the lowest note of the zone on the keyboard, for each element.

Settings: C-2 ~ G8

NOTE The lowest note you set here and the value in Limit High (Note Limit High; see below) determine the range of notes which can be played on the keyboard.

Note Limit High

Sets the highest note that each element can play.

Settings: C-2 ~ G8

NOTE It is not possible to set the Note Limit Low above the Note Limit High, or the Note Limit High below the Note Limit Low.

NOTE You can designate the key by pressing the key on the keyboard while holding [F8] key.

Note Xfade (Note Cross Fade)

Sets the cross fade range (Note Limit Low and High) of each element. As the value increases, the range becomes wider. A setting of "0" produces no effect.

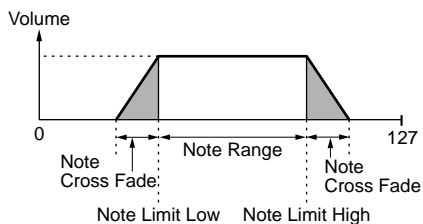

Settings: 0 ~ 127

Vel Limit Low (Velocity Limit Low)

Sets the lowest velocity value of each element wave that is detected when the keyboard is played.

Settings: 1 ~ 127

NOTE The lowest velocity value set here and for the value set in Vel Limit High (Velocity Limit High) determines the range of velocity for the selected element wave.

Vel Limit High (Velocity Limit High)

Sets the highest velocity value of each element wave that is detected when the keyboard is played.

Settings: 1 ~ 127

Vel Xfade (Velocity Cross Fade)

Sets the cross fade velocity range (Vel Limit Low and High) for each element. As the value increases, the range becomes wider. A setting of "0" produces no effect.

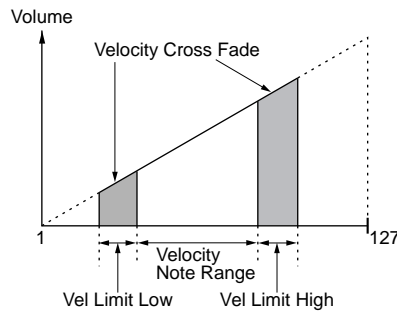

Settings: 0 ~ 127

Zone Graphical Display

On the left side of this screen the zone (keyboard and velocity range at which sound will be produced) is displayed. The note range is indicated by the horizontal axis, while the velocity note range is indicated by the vertical axis. As each parameter value is adjusted, the shape of the black box, which represents the note range, changes accordingly. The zones of other elements are stacked and displayed below the element zone that is currently selected.

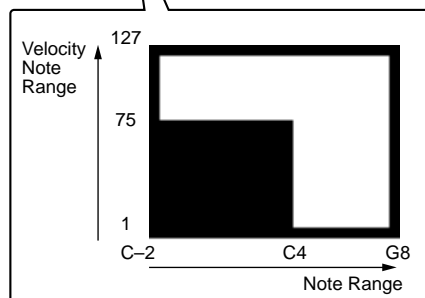
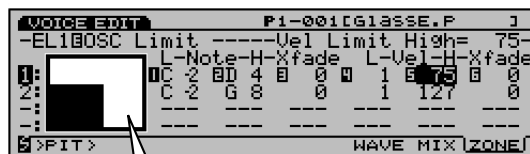

[F3]: PITCH

The Pitch parameters adjust the pitch of the wave and configures the tuning system. There are three menus with various parameters that can be applied to each element.

- [F6]: PARAM (Parameters)
- [F7]: SCALE
- [F8]: EG (Envelope Generator)

[F6]: PARAM (Parameters)

Adjusts each wave's tuning and the PEG settings. A different value can be set for each element.

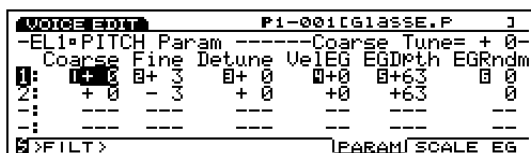

■ Coarse Tune

Raises or lowers the pitch of each element wave in semitones.

□ Settings: -64 ~ +63

■ Fine Tune

Finely adjusts the pitch of each element wave.

□ Settings: -64 ~ +63

■ Detune

Sets the detune value for each element. Detune is effective for making the sound thicker by raising or lowering the pitch of each element in Hertz (Hz).

□ Settings: -75 ~ 0 ~ +75

NOTE The Detune parameter here is the same as in the OSC's MIX screen.

■ Vel→EG (Velocity→EG)

Sets the velocity sensitivity for the PEG (Pitch Envelope Generator). Positive values means the harder a note is played, the greater the change in pitch. Negative values will produce the opposite effect.

□ Settings: -7 ~ 0 ~ +7

■ EG Depth

Sets the amount of pitch change in the PEG. A setting of "0" produces no change, and maintains the original pitch.

□ Settings: -64 ~ 0 ~ +63

■ EG Random

Changes the Hold Level (page 85) of the PEG randomly. The higher the value, the greater the change in pitch. A setting of "0" produces no change, and maintains the original pitch.

□ Settings: 0 ~ 15

[F7]: SCALE

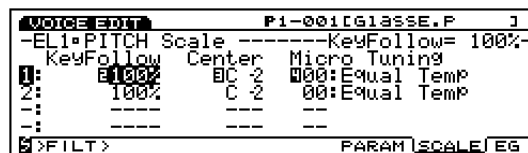

Sets the pitch scaling for each element, which determines the tuning.

■ KeyFollow

Sets the KeyFollow for each element. The KeyFollow function adjusts the pitch change of the PEG in accordance with the notes played on the keyboard. When KeyFollow is applied, the amount of pitch change of the PEG is adjusted accordingly at every note relative to the Center pitch (explained below) on the keyboard.

□ Settings: 0, 5, 10, 20, 50, 100%

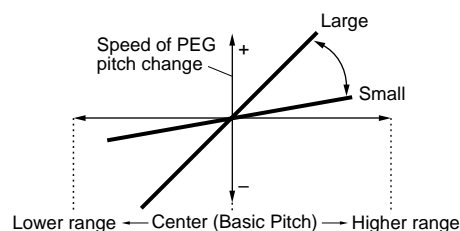

■ Center Key

Sets the basic pitch for the KeyFollow of each element. The same pitch change set in the PEG can be obtained exactly for the note set as Center pitch. The other pitches will be affected in proportion to the value set for the KeyFollow parameter.

□ Settings: C-2 ~ G8

■ Micro Tuning

Sets the Micro Tuning (tuning system, or temperament) each element will use. Beginning with the standard tuning “equal temperament,” there are 32 tuning systems available.

□ **Settings:** Each system is listed below.

No.	Type	Key	Comments
00	Equal temperament	—	The “compromise” tuning used for most of the last 200 years of Western music, and found on most electronic keyboards. Each half step is exactly 1/2th of an octave, and music can be played in any key with equal ease. However, none of the intervals are perfectly in tune.
01–12	Pure major	C–B	This tuning is designed so that most of the intervals (especially the major third and perfect fifth) in the major scale are pure. This means that other intervals will be correspondingly out of tune. You need to specify the key (C–B) you will be playing in.
13–24	Pure minor	A–G#	The same as Pure Major, but designed for the minor scale.
25	Werckmeister	—	Andreas Werckmeister, a contemporary of Bach, designed this tuning so that keyboard instruments could be played in any key. Each key has a unique character.
26	Kirnberger	—	Johan Philipp Kirnberger was also concerned with tempering the scale to allow performances in any key.
27	Vallotti & Young	—	Francescantonio Vallotti and Thomas Young (both mid–1700s) devised this adjustment to the Pythagorean tuning in which the first six fifths are lower by the same amount.
28	1/4 shifted	—	This is the normal equal tempered scale shifted up 50 cents.
29	1/4 tone	—	Twenty–four equally spaced notes per octave. (Play twenty–four notes to move one octave.)
30	1/8 tone	—	Forty–eight equally spaced notes per octave. (Play forty–eight notes to move one octave.)
31	Indian	C–B	Usually observed in the Indian music (white keys [C–B] only).

[F8]: EG (Pitch Envelope Generator)

Sets the PEG, which determines how the pitch will change over time, from when the key is pressed, held, then released. A different value can be set for each element.

When setting the PEG, press [F8] and two types of screens will appear alternately. You can switch back and forth between the screens to set each parameter.

All Parameters Screen

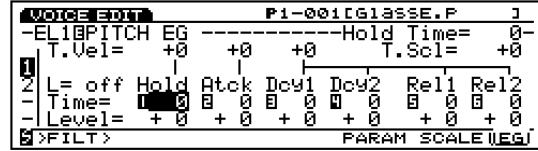

Envelope Screen

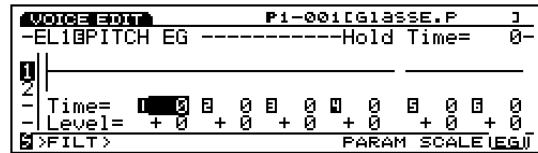

■ Hold Time Vel (Hold Time Velocity)

Sets the velocity sensitivity for the Hold Time. When Hold Time Vel is set to a positive value, the harder the keyboard is played, the faster a change occurs. Negative values will have the opposite effect.

□ **Settings:** -7 ~ 0 ~ +7

NOTE This parameter is not displayed in the ENVELOPE screen.

■ Atck Time Vel (Attack Time Velocity)

Sets the velocity sensitivity for the Attack Time. When Atck Time Vel is set to a positive value, the harder the keyboard is played, the faster a change occurs. Negative values will have the opposite effect.

□ **Settings:** -7 ~ 0 ~ +7

NOTE This parameter is not displayed in the ENVELOPE screen.

■ Other Time Vel (Other Time Velocity)

Sets the velocity sensitivity for the Decay 1/2 Time and the Release 1/2 Time. When Other Time Vel is set to a positive value, the harder the keyboard is played, the faster a change occurs. Negative values will have the opposite effect.

□ **Settings:** -7 ~ 0 ~ +7

NOTE This parameter is not displayed in the ENVELOPE screen.

Time Scale

The Time Scale function determines the speed of change in the PEG according to the pitch played on the keyboard. When the Time Scale is set to a positive value, the lower the note played on the keyboard, the slower the change that occurs over time. The higher the note played on the keyboard, the faster the change occurs. Negative values will have the opposite effect.

Settings: -7 ~ 0 ~ +7

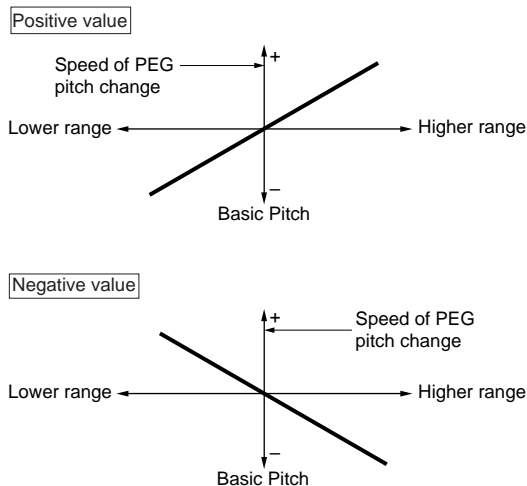

NOTE This parameter is not displayed in the ENVELOPE screen.

L (Loop)

Determines the loop for the PEG. As seen in the following diagram, this function sets the position to be returned to after reaching Decay 2 (loop point). Selecting “off” turns the loop function off.

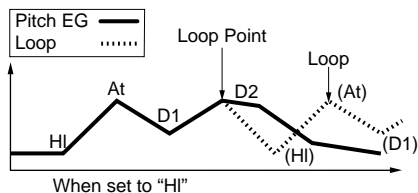

Settings: off, HI (Hold), At (Attack), D1 (Decay 1)

NOTE This parameter is not displayed in the ENVELOPE screen.

Hold Time

Sets the Hold Time.

Settings: 0 ~ 127

Atck Time (Attack Time)

Sets the Attack Time.

Settings: 0 ~ 127

Dcy 1/2 Time (Decay 1/2 Time)

Sets the Decay 1/2 Time.

Settings: 0 ~ 127

Rel1/Rel2 Time (Release 1/2 Time)

Sets the Release 1/2 Time.

Settings: 0 ~ 127

Hold Level

Sets the Hold Level.

Settings: -128 ~ 0 ~ +127

Atck Level (Attack Level)

Sets the Attack Level.

Settings: -128 ~ 0 ~ +127

Dcy 1/2 Level (Decay 1/2 Level)

Sets the Decay 1/2 Level.

Settings: -128 ~ 0 ~ +127

Rel1/Rel2 Level (Release 1/2 Level)

Sets the Release 1/2 Level.

Settings: -128 ~ 0 ~ +127

Setting the Pitch Envelope Generator

There are six Time settings (the speed of the changes) and six Level settings (for pitch) that shape how the pitch of the sound changes over time, from when a key is pressed, then released, and how the sound decays.

Press [F8] to select the ENVELOPE screen; each value can be set with the Envelope graphical display. The pitch of a played note can be set to continue at a defined level for a fixed period of time by setting the Hold Level and the Hold Time. Then, the pitch change over time can be controlled by setting the Attack Time/Level and the Dcy1/2 Time/Level. Finally, when the key is released, the pitch change over time can be controlled by setting the Rel1/2 Time/Level parameter.

If necessary, Time Velocity and Loop can be set in the ALL PARAMETERS screen.

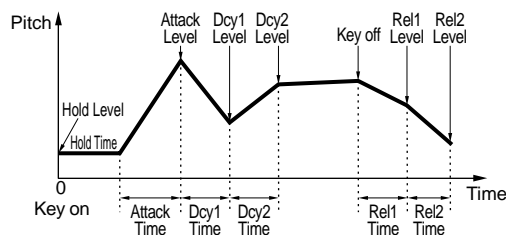

[F4]: FILT (Filter)

The Filter parameters configure the filter setting which can be applied to each element to change the timbre of the sound. There are five menus available.

- [F4]: SCF (Static Control Filter)
- [F5]: DCF (Dynamic Control Filter)
- [F6]: SENS (Sensitivity)
- [F7]: SCALE
- [F8]: EG (Envelope Generator)

[F4]: SCF (Static Control Filter)

Sets up the parameters for the Static Control Filter. The SCF has various types of filters that pass a specific frequency bandwidth while filtering out other frequencies. A different filtration can be set for each element.

NOTE The EX5/5R/7 has two other filters that make it possible to create a wide range of sounds. These are two sets of DCF (Dynamic Control Filter) filters. For information, see page 91.

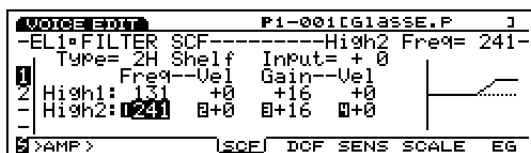

■ Type

Selects the type of filter. The parameters available depend on the selected filter type.

- **Settings:** L/H Shelf (Low/High Shelving Filter), 2L Shelf (2-Low Shelving Filter), 2H Shelf (2-High Shelving Filter), LPF (Low Pass Filter), HPF (High Pass Filter), BPF (Band Pass Filter), InvertLPF (Inverted Low Pass Filter), PEQ (Parametric Equalizer), thru, boost 6dB/12dB/18dB

■ Input Gain

Sets the gain of the signal that is sent to the SCF (Static Control Filter) unit. The higher the value, the more the amount of gain of the input signal.

- **Settings:** -32 ~ +0

NOTE Input Gain is not available with the following types: thru, boost 6dB/12dB/18dB. Input Gain is common for the all types except for the above four.

The available filter types and associated parameters are explained below.

L/H Shelf (Low/High Shelving Filter)

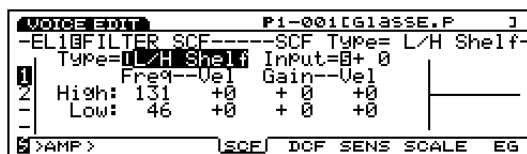

A shelving type filter that can increase or decrease the signal level in both the high and low frequency ranges.

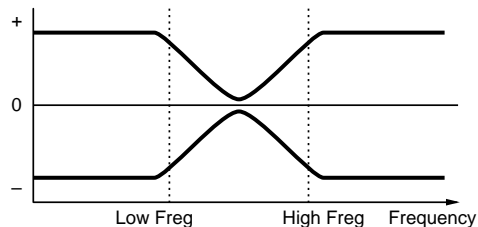

■ High Freq (High Frequency)

Sets the high frequency shelving point. Use High Gain (see below) to increase or decrease the signal level above the specified point.

- **Settings:** 131 ~ 241

■ Low Freq (Low Frequency)

Sets the low frequency shelving point. Use Low Gain (see below) to increase or decrease the signal level below the specified point.

- **Settings:** 46 ~ 182

■ High/Low Freq Vel (High/Low Frequency Velocity)

Sets the velocity sensitivity for the frequency ranges specified by the High Freq and Low Freq. When High/Low Freq Vel is set to a positive value, the harder a note is played on the keyboard, the higher the frequencies of the High Freq and Low Freq. This creates a greater change in the timbre of the sound. Negative values will have the opposite effect.

- **Settings:** -7 ~ +7

■ High/Low Gain

Sets the signal level for the frequencies passing above the High Freq point and for those passing below the High Freq point.

- **Settings:** -32 ~ 0 ~ +32

■ High/Low Gain Vel (High/Low Gain Velocity)

Sets the velocity sensitivity for signal levels designated by the High Gain and Low Gain. When the High/Low Gain Vel is set to a positive value, the harder a note is played on the keyboard, the more the amount of gain is applied. Negative values will have the opposite effect.

□ Settings: $-7 \sim +7$

2L Shelf (2-Low Shelving Filter)

VOICE EDIT		P1-0010GLASSE.P		J	
-EL1BFILTER SCF-----SCF Type= 2L Shelf -					
Type=2L Shelf Input=B+ 0					
	1	2	3	4	5
		Low1:	72	+0	+0
		Low2:	72	+0	+0
[>AMP>] [SCF] DCF SENS SCALE EG					

A shelving type filter that increases or decreases the signal levels for two low frequency ranges (Low1 and Low2).

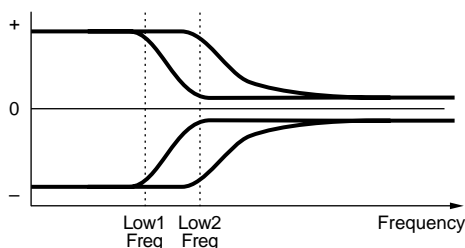

■ Low1/2 Freq (Low 1/2 Frequency)

Sets the two low frequency shelving points, Low1 and Low2. Use Low1/2 Gain (see below) to increase or decrease the signal levels below the specified point.

□ Settings: $72 \sim 182$

NOTE The two frequency ranges below the shelving point will overlap one another.

■ Low1/2 Freq Vel (Low1/2 Frequency Velocity)

Sets the velocity sensitivity for the frequency ranges specified by the Low1/2 Freq parameter. When Low1/2 Freq Vel is set to a positive value, the harder a note is played on the keyboard, the higher the frequencies of the Low1/2 Freq. This creates a greater change in the timbre of the sound. Negative values will have the opposite effect.

□ Settings: $-7 \sim +7$

■ Low1/2 Gain

Sets the signal levels for the frequencies passing below the Low1/2 Freq points.

□ Settings: $-16 \sim 0 \sim +16$

■ Low1/2 Gain Vel (Low1/2 Gain Velocity)

Sets the velocity sensitivity for signal levels designated by the Low1/2 Gain. When Low1/2 Gain Vel is set to a positive value, the harder a note is played on the keyboard, the more gain that is applied. Negative values will have the opposite effect.

□ Settings: $-7 \sim +7$

2H Shelf (2-High Shelving Filter)

VOICE EDIT		P1-0010GLASSE.P		J	
-EL1BFILTER SCF-----SCF Type= 2H Shelf -					
Type=2H Shelf Input=B+ 0					
	1	2	3	4	5
		High1:	131	+0	+0
		High2:	131	+0	+0
[>AMP>] [SCF] DCF SENS SCALE EG					

A shelving type filter that increases or decreases the signal levels for the two high frequency ranges (High1 and High2).

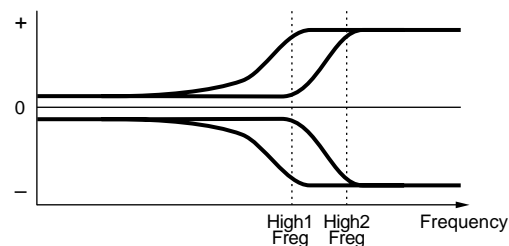

■ High1/2 Freq (High 1/2 Frequency)

Sets two high frequency shelving points, High1 and High2. Use High1/2 Gain (see below) to increase or decrease each signal level above the specified point.

□ Settings: $131 \sim 241$

NOTE The two frequency ranges above the shelving point overlap one another.

■ High1/2 Freq Vel (High1/2 Frequency Velocity)

Sets the velocity sensitivity for the frequency ranges specified by the High1/2 Freq. When High1/2 Freq Vel is set to a positive value, the harder a note is played on the keyboard, the higher the frequencies of the High1/2 Freq. This creates a greater change in the timbre of the sound. Negative values will have the opposite effect.

□ Settings: $-7 \sim +7$

■ High1/2 Gain

Sets the signal levels for the frequencies passing above the High1/2 Freq points.

□ **Settings:** -16 ~ 0 ~ +16

■ High1/2 Gain Vel (High1/2 Gain Velocity)

Sets the velocity sensitivity for signal levels designated by the High1/2 Gain parameter. When High1/2 Gain Vel is set to a positive value, the harder a note is played on the keyboard, the more the gain that is applied. Negative values will have the opposite effect.

□ **Settings:** -7 ~ +7

LPF (Low Pass Filter)

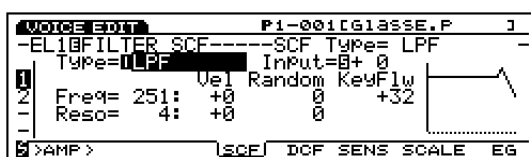

The LPF passes only the signals below the specified cutoff frequency (point) set in the Freq parameter (below), and cuts all signals above it.

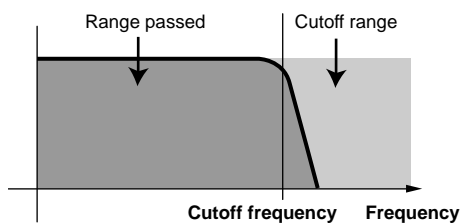

VCF Type = Low Pass Filter

■ Freq (Frequency)

Sets the cutoff frequency value. This determines the cutoff frequency of the filter, or the frequency above which all other frequencies are filtered out.

□ **Settings:** 0 ~ 251

■ Freq Vel (Frequency Velocity)

Sets the velocity sensitivity for the cutoff frequency. When Freq Vel is set to a positive value, the harder a note is played on the keyboard, the higher the cutoff frequency. This creates a greater change in the timbre of the sound. Negative values will have the opposite effect.

□ **Settings:** -7 ~ +7

■ Freq Random (Frequency Random)

Freq Random causes the cutoff frequency to move randomly. The higher the value, the wider the change of the cutoff frequency. A setting of “0” produces no effect.

□ **Settings:** 0 ~ 7

■ Freq KeyFollow

Sets the KeyFollow for the cutoff frequency set in the Freq parameter. The Freq KeyFollow functions to adjust the cutoff frequency by the notes played on the keyboard. When Freq KeyFollow is set to a positive value, the higher the note played on the keyboard, the higher the cutoff frequency. When a negative value is set, the lower the note played, the higher the cutoff frequency becomes.

□ **Settings:** -64 ~ +63

■ Reso (Resonance)

Determines the amount of resonance boost, or emphasis of harmonics located near the cutoff frequency. A setting of “0” produces no effect.

□ **Settings:** 0 ~ 31

■ Reso Vel (Resonance Velocity)

Sets the velocity sensitivity for the value designated in the Reso. When the Reso Vel is set to a positive value, the harder a note is played on the keyboard, the greater the resonance becomes, and a greater change occurs in the timbre of the sound. Negative values will have the opposite effect.

□ **Settings:** -7 ~ +7

■ Reso Random (Resonance Random)

Reso Random causes the amount of the Resonance effect to vary randomly. The higher the value, the greater the change in the amount of the resonance. A setting of “0” produces no effect.

□ **Settings:** 0 ~ 7

HPF (High Pass Filter)

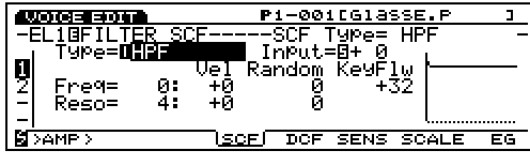

The HPF passes the signals above the specified cutoff frequency set in the Freq parameter (below), and cuts the signals below it.

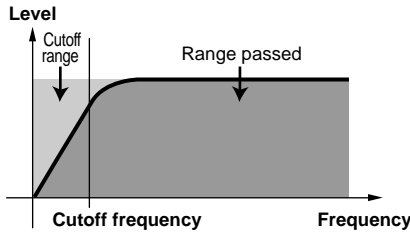

■ Freq (Frequency)

Sets the cutoff frequency. This determines the cutoff frequency of the filter, or the frequency below which all other frequencies are filtered out.

□ Settings: 0 ~ 251

All other parameters for this filter are the same as explained for the LPF (Low Pass Filter) parameters. For information, see page 88.

BPF (Band Pass Filter)

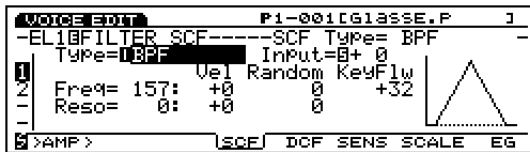

The BPF filter passes only a band of frequencies centered at the cutoff frequency, and cuts others.

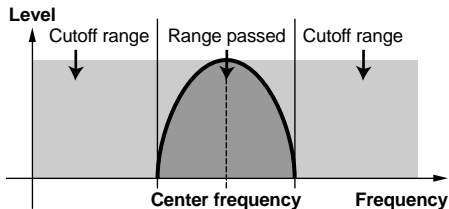

■ Freq (Frequency)

Sets the cutoff frequency. Only the frequencies around the cutoff frequency will be passed, while other frequencies will be filtered out.

□ Settings: 0 ~ 251

All other parameters for this filter are the same as explained for the LPF parameters. For information, see page 88.

InvertLPF (Inverted Low Pass Filter)

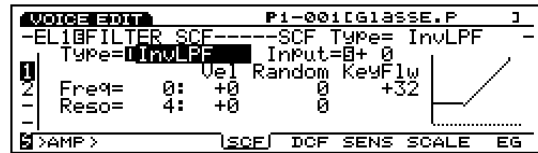

The InvertLPF inverts the function of the LPF. The signals below the specified cutoff frequency are filtered out, and other frequencies are passed. The InvertLPF and LPF form a symmetrical curve on the horizontal axis.

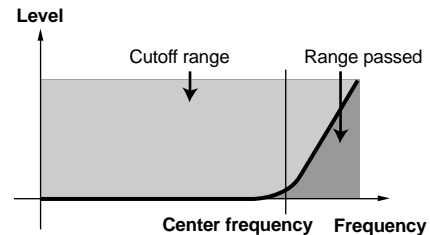

■ Freq (Frequency)

Sets the cutoff frequency. The frequencies below the cutoff frequency are filtered out.

□ Settings: 0 ~ 229

All other parameters for this filter are the same as explained for the LPF parameters. For information, see page 88.

PEQ (Parametric Equalizer)

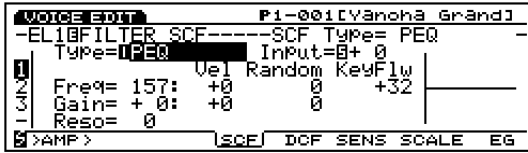

The PEQ increases or decreases the signal levels around the frequency designated in Freq (see below) using the Gain parameter.

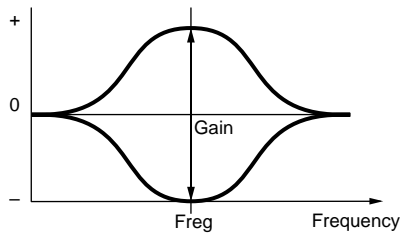

■ Freq (Frequency)

Sets the center frequency. The signal levels of the band of frequencies designated here can be increased or decreased by the Q setting.

□ Settings: 83 ~ 251

■ Freq Vel (Frequency Velocity)

Sets the velocity sensitivity for the frequency designated in the Freq parameter. When Freq Vel is set to a positive value, the harder a note is played on the keyboard, the higher the frequency (set in Freq) becomes, and a greater change occurs in the timbre of the sound. Negative values will have the opposite effect.

□ Settings: -7 ~ +7

■ Freq Random (Frequency Random)

Freq Random causes the frequency set in the Freq parameter to move randomly. The higher the value, the wider the change of the center frequency. A setting of “0” produces no effect.

□ Settings: 0 ~ 7

■ Freq KeyFollow

Sets the KeyFollow for the center frequency set in the Freq. The Freq KeyFollow adjusts the center frequency by the notes played on the keyboard. When the Freq KeyFollow is set to a positive value, the higher the note played on the keyboard, the higher the center frequency becomes. When a negative value is set, the lower the note played, the higher the center frequency becomes.

□ Settings: -64 ~ +63

■ Gain

Sets the SCF (Static Control Filter) signal level. This parameter increases or decreases the signal levels around the frequency designated in the Freq parameter.

□ Settings: -32 ~ 0 ~ +32

■ Gain Vel (Gain Velocity)

Sets the velocity sensitivity for the signal level designated in the Gain parameter. When Gain Vel is set to a positive value, the harder a note is played on the keyboard, the greater the gain that is applied. Negative values will have the opposite effect.

□ Settings: -7 ~ +7

■ Gain Random

Gain Random causes the level set in the Gain parameter to move randomly. The higher the value, the greater the change of the gain level. A setting of “0” produces no effect.

□ Settings: 0 ~ 7

■ Reso (Frequency Characteristics)

Selects the frequency characteristics. There are 32 different Reso types.

□ Settings: 0 ~ 31

Thru

Passes all the frequencies through without any filter applied.

boost 6dB/12dB/18dB

Increases the volume by 6dB 12dB and 18dB, respectively.

[F5]: DCF (Dynamic Control Filter)

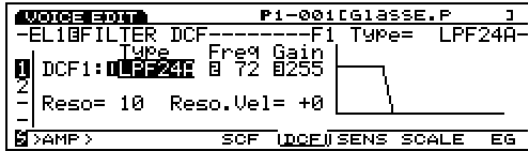

Configures the parameters for the Dynamic Control Filter. There are various kinds of filters that change the timbre of the sound by passing only specific frequencies through from the harmonic contents (other frequencies are filtered out). A different filtration can be applied to each element. The DCF filter effect can be changed over time using the Filter Envelope Generator (see FEG on page 96).

NOTE While the SCF filters are mainly used for basic voicing without change (over time), the DCF filters are used to change the harmonic content over time, from the initial attack to the ending decay by using the FEG. This lets you simulate various types of musical instruments and create sounds with a change in timbre over time.

■ DCF1 Type (Filter 1 Type)

Selects the filter type. Available parameters will differ depending on the selected filter type.

Settings: LPF24A (Low Pass Filter 24A), LPF24D (Low Pass Filter 24D), LPF18 (Low Pass Filter 18), LPF12 (Low Pass Filter 12), LPF6 (Low Pass Filter 6), HPF (High Pass Filter), BPF (Band Pass Filter), BEF (Band Elimination Filter), thru

■ DCF2 Type (Filter 2 Type)

If a type of filter other than LPF24A, LPF24D, LPF18, and Thru is selected, two DCF (DCF1/2) filters can be used simultaneously. The DCF2 Type parameters will be added to the screen. The two DCF filters can be connected in series or parallel. For more information, see the next section.

Settings: LPF (Low Pass Filter), BPF (Band Pass Filter), HPF (High Pass Filter), BEF (Band Elimination Filter)

Press [F5] and the following two types of parameter screens alternately appear. If necessary, change the screens when adjusting each parameter. For more information, see the following section.

Frequency Characteristics Screen

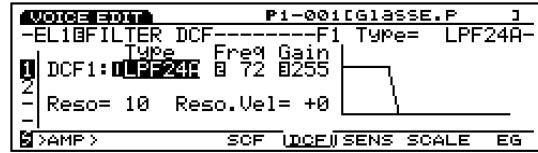

All Parameters Screen

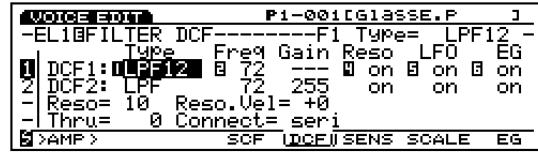

■ DCF1/2 Freq (F1/2Frequency)

Sets the cutoff frequency. The cutoff frequency set here will be effective for the signal which passes through the DCF 1/2 filters.

Settings: 0 ~ 255

■ DCF1/2 Gain

Sets the amount of signal level for the DCF1/2 filters.

Settings: 0 ~ 255

NOTE If a filter type other than LPF24A, LPF24D and LPF18 is selected, and the Connect setting (below) is set to seri (serial), hyphens (---) will be displayed in DCF1 Gain. In this case, the gain of the signals passed through DCF1 and DCF2 is adjusted by the DCF2 Gain.

■ Reso (Resonance)

Determines the amount of resonance or emphasis around the cutoff frequency, and adds a pronounced effect to the sound. The setting made here is equally applied to both DCF1 and DCF2 filters.

Settings: 0 ~ 31

■ Reso. Vel (Resonance Velocity)

Sets the velocity sensitivity for the value designated in the Reso parameter. When Reso Vel is set to a positive value, the harder a note is played on the keyboard, the greater the resonance becomes, and a greater change occurs in the timbre of the sound. Negative values will have the opposite effect. The setting made here is equally applied to both DCF1 and DCF2 filters.

Settings: -7 ~ +7

Thru Gain

Determines the amount of the signals that does not pass through the filter, or the original dry sound.

Settings: 0 ~ 255

NOTE The Thru Gain is displayed and effective only when a filter type other than LPF24A, LPF24D, LPF18 and Thru is selected, and the Connect setting (see below) is set to seri (serial).

Connect

Sets how the DCF1 and DCF2 are connected. There are two types of connections available.

Settings: seri (serial), para (parallel)

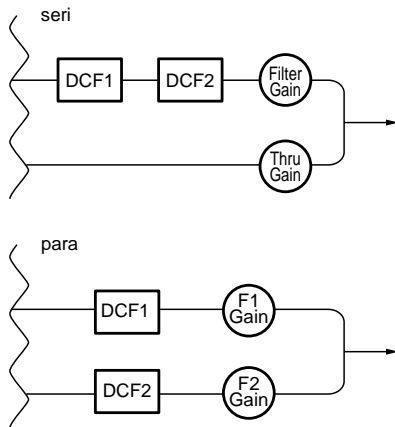

NOTE The Connect parameter is displayed only when a filter type other than LPF24A, LPF24D, LPF18 or Thru is selected.

NOTE The following three parameters are displayed only when a filter type other than LPF24A, LPF24D, LPF18 or Thru is selected, and the Frequency Characteristics screen is not selected.

The parameters added in the All Parameters Screen.

DCF1/2 Reso (F1/2 Resonance)

Turns the resonance effect on or off for the DCF1/2.

Settings: on, off

DCF1/2 LFO (F1/2 LFO)

Turns the LFO (Low Frequency Oscillator) effect on or off for the DCF1/2.

Settings: on, off

DCF1/2 EG (F1/2 EG)

Turns the PEG effect on or off for the DCF1/2.

Settings: on, off

The following filter types are available for the DCF 1/2.

LPF (Low Pass Filter)

The LPF passes the signals below the specified cutoff frequency and cuts the signals above it. There are five different types of Low Pass Filters for the DCF1.

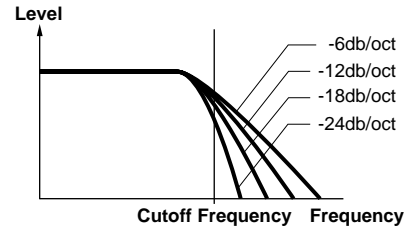

LPF24A (Low Pass Filter 24A):

Digital dynamic filter similar to a -24dB/oct low pass filter of an analog synthesizer.

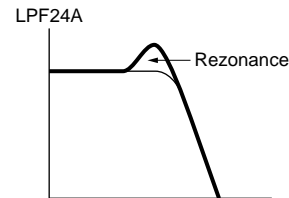

LPF24D (Low Pass Filter 24D):

-24dB/oct low pass filter-type digital dynamic filter with pronounced resonance.

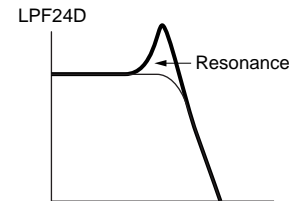

LPF18 (Low Pass Filter 18):

-18dB/oct low pass filter-type digital dynamic filter.

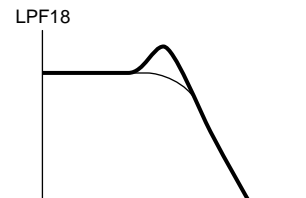

LPF12 (Low Pass Filter 12):

-12dB/oct low pass filter-type digital dynamic filter.

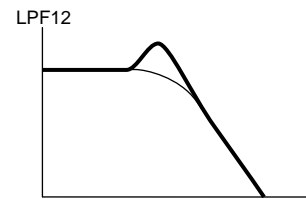

LPF6(Low Pass Filter 6):

-6dB/oct low pass filter-type digital dynamic filter with no resonance.

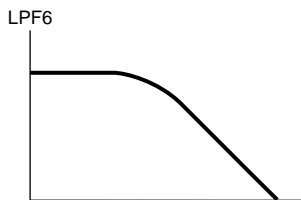

HPF (High Pass Filter)

The HPF filter passes the signals above the specified cutoff frequency, and cuts the signals below it.

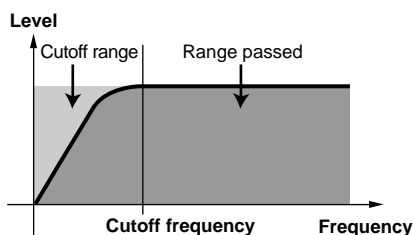

BPF (Band Pass Filter)

The BPF filter passes the signals around the specified cutoff frequency, and cuts other signals.

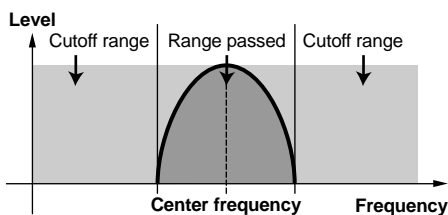

BEF (Band Elimination Filter)

The BEF filter cuts the signals around the specified cutoff frequency, and passes other signals.

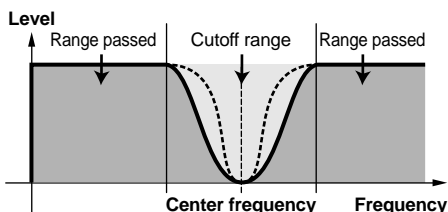

Thru

The Thru function by-passes the filter and the signal remains unaffected (dry).

Filter Graphic Display

On the right side of the Frequency Characteristics screen, the type of the filter frequency characteristics curve is displayed. The frequency bandwidth is indicated by the horizontal axis, while the level is indicated by the vertical axis. As each parameter value is adjusted, the changes are shown accordingly in the graphical display. When two DCF filters (DCF1/2) are used, the two curves are displayed on top of one another.

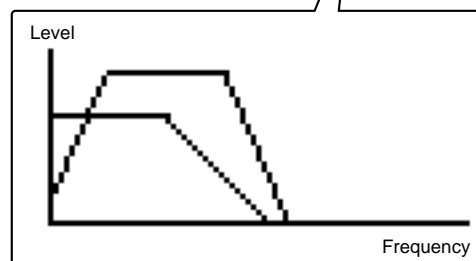
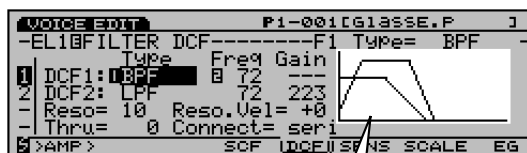

[F6]: SENS (Sensitivity)

Sets the sensitivity of the DCF filter for each element. A different value can be set for the two DCF filters of each element.

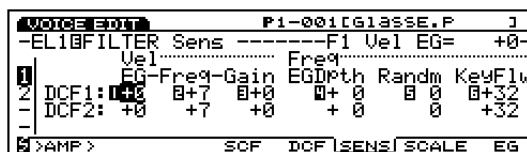

NOTE When LPF24A, LPF24D, or LPF18 is selected, only the DCF1 parameters are displayed (see page 91).

F1/2 Vel EG (Filter 1/2 Velocity EG)

Sets the velocity sensitivity for the FEG. When set to a positive value, the harder a note is played on the keyboard, the greater the change becomes in the filtered sound. Negative values will have the opposite effect.

Settings: -7 ~ +7

■ F1/2 Vel Freq (Filter 1/2 Velocity Frequency)

Sets the velocity sensitivity for the cutoff frequency parameter. When F1/2 Vel Freq is set to a positive value, the harder a note is played on the keyboard, the higher the cutoff frequency becomes, and a greater change occurs in the timbre of the sound. Negative values will have the opposite effect.

□ **Settings:** -7 ~ +7

■ F1/2 Vel Gain (Filter 1/2 Velocity Gain)

Sets the velocity sensitivity for the gain level. When F1/2 Vel Gain is set to a positive value, the harder a note is played on the keyboard, the more the amount of gain is applied. Negative values will have the opposite effect.

□ **Settings:** -7 ~ +7

■ F1/2 Freq EG Depth (Filter 1/2 Frequency EG Depth)

Sets the depth of the change in the cutoff frequency over time. The higher the value, the wider the change in depth becomes. Negative values will result in an inverted envelope.

□ **Settings:** -64 ~ 0 ~ +63

■ F1/2 Freq Random (Filter 1/2 Frequency Random)

Freq Random causes the cutoff frequency to move randomly. The higher the value, the greater the change in the movement. A setting of “0” produces no effect.

□ **Settings:** 0 ~ 15

■ F1/2 Freq KeyFlw (Filter 1/2 Frequency KeyFollow)

Sets the KeyFollow for the cutoff frequency. The F1/2 Freq KeyFollow adjusts the cutoff frequency by the notes played on the keyboard. When the F1/2 Freq KeyFollow is set to a positive value, the larger the note played on the keyboard, the higher the cutoff frequency becomes. When a negative value is set, the lower the note played, the higher the cutoff frequency becomes.

□ **Settings:** -64 ~ +63

[F7]: SCALE

Sets the scaling for the filter. The filter scaling function adjusts the filter cutoff frequency based on notes played on the keyboard. There are four Break Points, each with their own offset level settings. A different value can be set for the two DCF filters of each element.

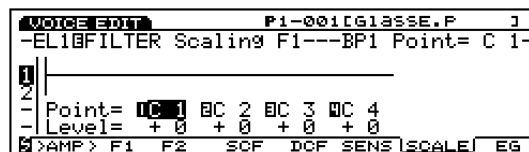

Press [F2] and [F3] to select the DCF1 and the DCF2 screens, respectively.

■ BP 1 ~ 4 point

■ BP 1 ~ 4 Level

□ **Settings:**

BP 1/2/3/4 Point: C-2 ~ G8

BP 1/2/3/4 Level: -128 ~ +127

Setting the Filter Scaling

Set the note names (pitch) and the offset levels for each break point (BP1-4) as seen in the following example.

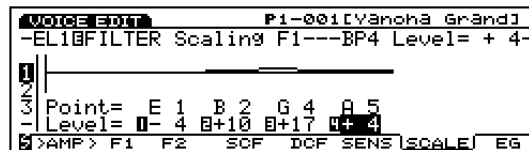

In this example, with a cutoff frequency of 64, the note name E1 at the BP 1 Point is set to the offset value -4. B2 at the BP 2 Point is +10. G4 at the BP 3 Point is +17. And A5 at the BP 4 Point is +4. Each cutoff frequency will be offset to 60, 74, 81 and 68, respectively. The cutoff frequencies other than the ones at each Break Point will be on the straight line connected between the two adjacent Break Points.

NOTE Sets the Break Point note names from the lowest BP1 to the highest BP4. Be aware that, for example, the BP1 note name cannot be set higher than the adjacent BP2.

NOTE The Break Point level is an offset value and will increase or decrease from the currently selected cutoff frequency. Even if an offset value is set above or below the limits of the cutoff frequency, it will not go beyond the upper and lower cutoff frequency limits.

NOTE A note set below the BP1 Break Point becomes the BP1 level. Likewise, a note set above the BP4 Break Point becomes the BP4 level.

[F8]: EG (Filter Envelope Generator)

Sets the FEG, which determines how the timbre of the sound will change over time, from when the key is pressed, held, then released. The FEG is effective for both DCF1/2, and different settings can be made for each element.

When setting the FEG, press [F8] and the following two types of screens appear alternately. You can switch between screens to set each parameter.

All Parameters Screen

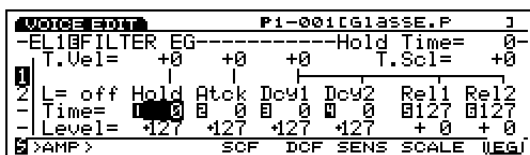

Envelope screen

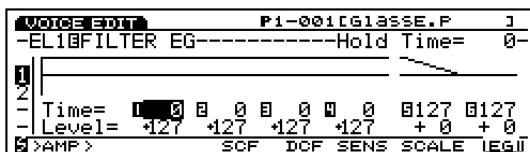

■ Hold Time Vel (Hold Time Velocity)

Sets the velocity sensitivity for the Hold Time. When Hold Time Vel is set to a positive value, the softer the keyboard is played, the longer the Hold Time becomes. Negative values will have the opposite effect.

□ Settings: $-7 \sim 0 \sim +7$

NOTE This parameter is not displayed in the ENVELOPE screen.

■ Atck Time Vel (Attack Time Velocity)

Sets the velocity sensitivity for the Attack Time. When Atck Time Vel is set to a positive value, the softer the keyboard is played, the longer the Attack Time becomes. Negative values will have the opposite effect.

□ Settings: $-7 \sim 0 \sim +7$

NOTE This parameter is not displayed in the ENVELOPE screen.

■ Other Time Vel (Other Time Velocity)

Sets the velocity sensitivity for Decay 1/2 Time and the Release 1/2 Time. When Other Time Vel is set to a positive value, the softer the keyboard is played, the longer the change becomes over time. Negative values will have the opposite effect.

□ Settings: $-7 \sim 0 \sim +7$

NOTE This parameter is not displayed in the ENVELOPE screen.

■ Time Scale

The Time Scale function determines the speed of change in the FEG according to the pitch played on the keyboard. When Time Scale is set to a positive value, the lower a note that is played on the keyboard, the slower the change over time becomes. Likewise, the higher a note that is played on the keyboard, the faster the change occurs. Negative values will have the opposite effect.

□ Settings: $-7 \sim 0 \sim +7$

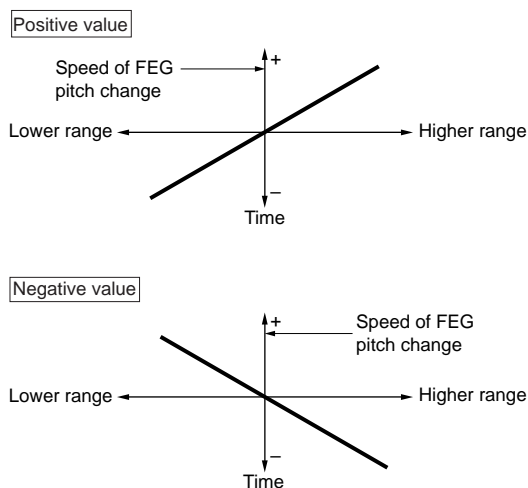

NOTE This parameter is not displayed in the ENVELOPE screen.

■ L (Loop)

Sets the loop point for the FEG. As seen in the FOLLOWING diagram, this function sets the position to be returned to after reaching the Decay 2 (loop point). Selecting “off” turns the loop function off.

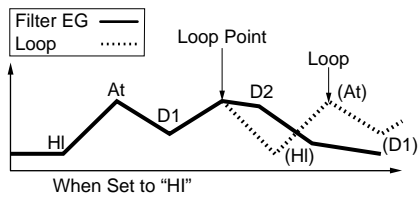

❑ **Settings:** off, HI (Hold), Atck (Attack), D1 (Decay 1)

NOTE This parameter is not displayed in the ENVELOPE screen.

■ Hold Time

Sets the Hold Time.

❑ **Settings:** 0 ~ 127

■ Attack Time

Sets the Attack Time.

❑ **Settings:** 0 ~ 127

■ Dcy 1/2 Time (Decay 1/2 Time)

Sets the Decay 1/2 Time.

❑ **Settings:** 0 ~ 127

■ Rel1/Rel2 Time (Release 1/2 Time)

Sets the Release 1/2 Time.

❑ **Settings:** 0 ~ 127

■ Hold Level

Sets the Hold Level.

❑ **Settings:** -128 ~ 0 ~ + 127

■ Attack Level

Sets the Attack Level.

❑ **Settings:** -128 ~ 0 ~ + 127

■ Dcy 1/2 Level (Decay 1/2 Level)

Sets the Decay 1/2 level.

❑ **Settings:** -128 ~ 0 ~ + 127

■ Rel1/Rel2 Level (Release 1/2 Level)

Sets the Release 1/2 Level.

❑ **Settings:** -128 ~ 0 ~ + 127

Setting the Filter Envelope Generator

There are six Time settings (the speed of changes) and six Level settings (the amount of changes) that shape how the timbre of the sound changes over time, from when a key is hit, then released, and how the sound decays.

Press [F8] to select the ENVELOPE screen. Each value can be set with the Envelope graphical display. The level of a played note can be set to continue at a defined level for a fixed period of time by setting the Attack Level and the Attack Time. Then the level change over time can be controlled by setting Dcy 1/2/3 Time/Level. Finally, when the key is released, the pitch change over time can be controlled by setting the Rel 1/2 Time/Level.

Time Velocity and Loop can also be set in the All Parameters screen.

NOTE The level here refers to the amount of offset value relative to the current cutoff frequency.

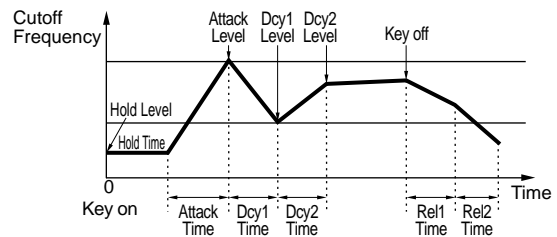

[F5]: AMP (Amplitude)

The Amplitude parameters set the volume of each element. There are three menus available.

[F6]: PARAM (Parameters)

[F7]: SCALE

[F8]: EG (Envelope Generator)

[F6]: PARAM (Parameters)

Determines the output level for each element. A different value can be set for each element.

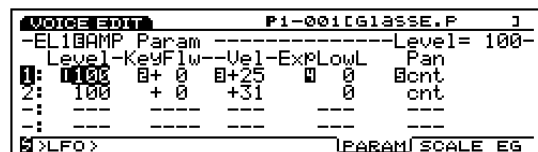

■ Level

Sets the output level of each element.

❑ **Settings:** 0 ~ 127

■ Level KeyFollow

Sets the Level KeyFollow for each element. The Level KeyFollow function determines the output level in accordance with the notes played on the keyboard. When Level KeyFollow is applied, the output level is increased or decreased relative to the basic pitch, which is designated here as C3.

□ **Settings:** -64 ~ +63

■ Level Vel (Level Velocity)

Sets the velocity level for each element. This function lets you control the volume by the velocity that is played on the keyboard (playing strength). When Level Vel is set to a positive value, the harder a note is played on the keyboard, the greater the change in volume that occurs. Negative values will have the opposite effect.

□ **Settings:** -64 ~ +63

■ ExpLowLimit (Expression Low Limit)

Sets the Expression Low Limit for each element. The lower limit can be set so that even when a sound is played below the set value, the volume will not go below the designated lower limit.

□ **Settings:** 0 ~ 127

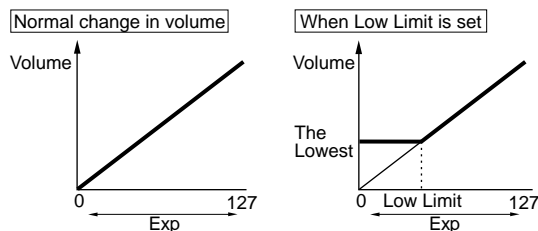

■ Pan

Determines the left or right positioning of each element in the stereo spectrum. Select “scl” to activate the scaling pan. In this way, the designated range of the scaling pan movement from left to right can be controlled by Pan KeyFollow. Select “rnd” to activate the Random Pan. In this way, the width of the sound moving from left to right can be controlled by Random Depth.

□ **Settings:** scl (Scaling Pan), L63 ~ cnt (center) ~ R63, rnd (Random)

■ Pan KeyFollow

This parameter is displayed when you select “scl” (Scaling Pan) in Pan. The Pan KeyFollow function determines the positioning of the sound in the stereo spectrum in accordance with the notes played on the keyboard. When Pan KeyFollow is applied, the positioning shifts accordingly at every note relative to the basic pitch C3 (as Center).

□ **Settings:** 0 ~ 15

■ Random Depth

This parameter is displayed when you select “rnd” (Random Pan) in Pan, to let you set the depth (width) of the Random Pan. This function causes the sound to move randomly within the stereo spectrum.

□ **Settings:** 0 ~ 127

[F7]: SCALE

Sets the amplitude scaling. The amplitude scaling function allows for control of the output level of the element by the pitch that is played on the keyboard. A different value can be set for each element. For information about setting the level of the element, see Element Level, page 81.

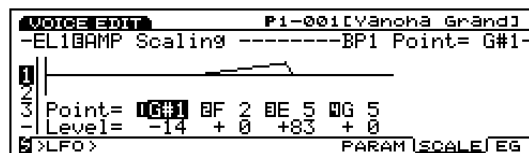

■ BP 1 ~ 4 point

■ BP 1 ~ 4 Level

□ **Settings:**

BP1/2/3/4 Point: C-2 ~ G8

BP1/2/3/4 Level: -128 ~ +127

Setting the Amplitude Scaling

You can set the note (pitch) and the offset level for each break point (BP1-4), as shown in the following example.

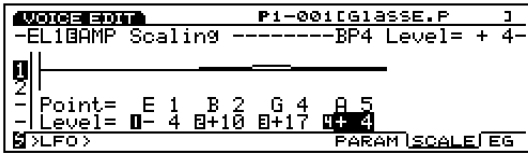

In this example, E1 has a level of -4. This means that the present output level is 76, because 80-4 equals 76. B2 has an offset value of +10; therefore, the level is 80 + 10 = 90. G4 is +17, so the level is 80 + 17 = 96. And A5, with an offset of +4, would be 80 + 4 = 84. The output levels other than the ones at each Break Point will be on the straight line connected between the two adjacent Break Points.

- NOTE** Set the Break Point note names from BP1 to BP4 in an ascending order.
- NOTE** The Break Point level offset value will increase or decrease relative to the currently selected value for the element. The range of possible values for an element is 0-127. Therefore, even if a Break Point value of +50 is applied to an element set to 80, the level will not become 130, but rather 127, which is the maximum available.
- NOTE** A note set below the BP1 break point will become the BP1 level. Likewise, a note set above the BP4 break point will become the BP4 level.

[F8]: EG (Amplitude Envelope Generator)

Sets the AEG. This determines how the amplitude will change over time, from when the key is pressed, held, then released. A different value can be set for each element.

When setting the AEG, press [F8] and two types of screens appear alternately. You can switch between screens as you set each parameter.

All Parameters Screen

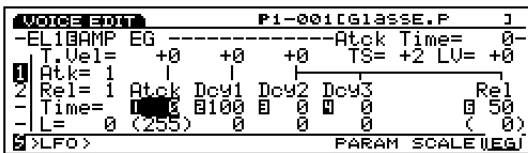

Envelope screen

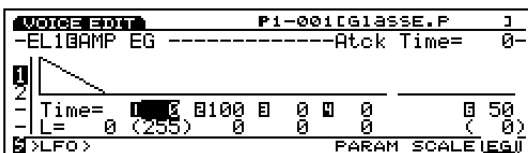

Atk Time Vel (Attack Time Velocity)

Sets the velocity sensitivity for the Attack Time. When Attack Time Vel is set to a positive value, the softer the keyboard is played, the longer the Attack time becomes. Negatives values will have the opposite effect.

Settings: -7 ~ 0 ~ +7

NOTE This parameter can be used for Attack Mode1 (see page 99). This parameter is not displayed in the ENVELOPE screen.

Dcy 1 Time Vel (Decay 1 Time Velocity)

Sets the velocity sensitivity for the Decay 1 Time. When Dcy 1 Time Vel is set to a positive value, the softer the keyboard is played, the longer the Decay 1 Time becomes. Negatives values will have the opposite effect.

Settings: -7 ~ 0 ~ +7

NOTE This parameter can be used for Attack Mode 2 (see page 99). This parameter is not displayed in the ENVELOPE screen.

Other Time Vel (Other Time Velocity)

Sets the velocity sensitivity for the Decay 2/3 and the Release 1/2 Time. When Other Time Vel is set to a positive value, the softer the keyboard is played, the longer the change in the sound. Negatives values will have the opposite effect.

Settings: -7 ~ 0 ~ +7

NOTE This parameter is not displayed in the ENVELOPE screen.

Time Scale

The Time Scale function determines the speed of change in the AEG according to pitch. When Time Scale is set to a positive value, the lower the note that is played on the keyboard, the slower the change over time becomes. The higher a note is played on the keyboard, the faster the change that occurs. Negatives values will have the opposite effect.

Settings: -7 ~ 0 ~ +7

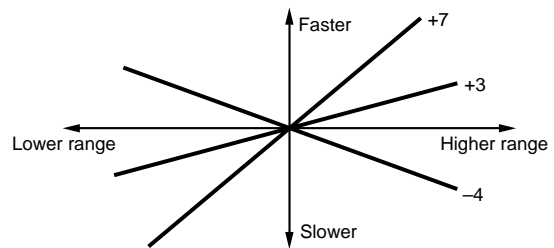

NOTE This parameter is not displayed in the ENVELOPE screen.

■ Decay Level Vel (Decay Level Velocity)

Increase or decrease the Decay Level with the velocity.

□ **Settings:** $-7 \sim 0 \sim +7$

■ Attack Mode

Selects the Attack Mode (1 or 2) or switches back and forth between modes.

□ **Settings:** 1 (Attack Mode 1), 2 (Attack Mode 2)

NOTE More information about each mode is provided below.

■ Release Mode

Selects the Release Mode (1 or 2) or switches back and forth between modes. When Release mode 2 is selected, Release Time 2 and Release Level 2 (set at “0”) are added and an even more complex envelope curve can be created.

□ **Settings:** 1 (Release Mode 1), 2 (Release Mode 2)

■ Attack Time

Sets the Attack Time.

□ **Settings:** $0 \sim 127$

■ Dcy 1 ~ 3 Time (Decay 1-3 Time)

Sets the Decay 1-3 Time.

□ **Settings:** $0 \sim 127$

■ Rel (Rel 1/2) Time

Sets the Release Time.

□ **Settings:** $0 \sim 127$

NOTE You can set the Release 1/2 Time only when Release Mode 2 is selected.

■ Init Level (Initial Level)

Sets the Initial level (when in “Hold mode”).

□ **Settings:** $0 \sim 127$

NOTE This parameter is effective only when the “Attack mode 1” is selected.

■ Dcy 1 ~ 3 Level

Sets the level of Decay 1-3.

□ **Settings:** $0 \sim 127$

■ Rel1 Level

Sets the level of Release 1 (when in Release Mode 2)

□ **Settings:** $0 \sim 127$

NOTE Release 1 Level is fixed to “0” in the Release Mode 1.
Release 2 Level is fixed to “0” in the Release Mode 2.

Setting the Amplitude Envelope Generator

There are six Time settings (the speeds of changes) and seven Level settings that shape how the volume of the sound changes over time, from when a key is hit, then released, and how the sound decays.

Press [F8] to select the ENVELOPE screen. Here each value can be set with the Envelope graphical display.

There are two types of Attack Modes (1 and 2) for the AEG. Attack Mode 1 has one attack and Attack Mode 2 has a two-step attack. Select the Attack Mode you want to use from the All Parameters screen.

You can also set the desired values for the Time Velocity and Time Scaling in the All Parameters screen.

Attack Mode 1

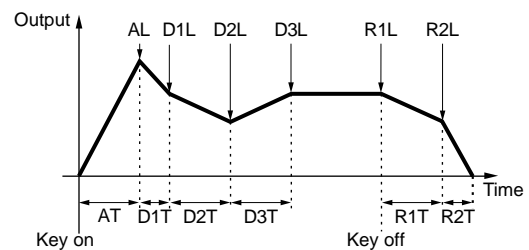

Initial Level = Attack Level

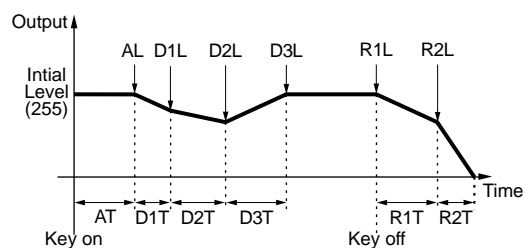

Attack Mode 2

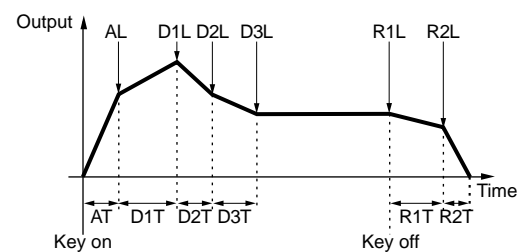

[F6]: LFO (Low Frequency Oscillator)

The LFO parameters set the LFO. The LFO oscillator generates low frequency signals that allow for modulation to be applied to specific aspects of the voice. Applying an LFO wave (shape of modulation) to the pitch, filter, or amplitude creates effects such as vibrato, waw, and tremolo. There are two LFOs (LFO1 and LFO2), available for applying the LFO to each element.

- [F7]: LFO1 (Low Frequency Oscillator1)
- [F8]: LFO2 (Low Frequency Oscillator2)

[F7]: LFO1 (Low Frequency Oscillator1)

Sets parameters for the LFO1. A different value can be set for each element.

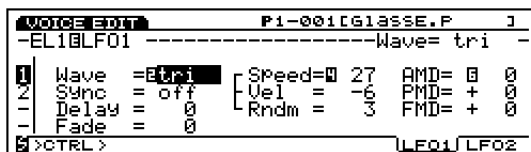

Wave

Selects the LFO 1 wave. Various kinds of modulated sounds can be created depending on the selected wave. Three types of waves are available.

Settings: saw, tri, squ

NOTE It is possible for the LFO1 to modulate the pitch, filter and amplitude simultaneously.

saw

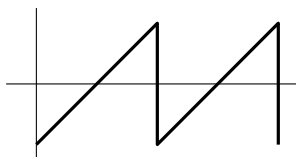

tri (triangle)

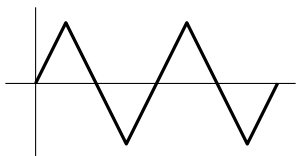

squ (square)

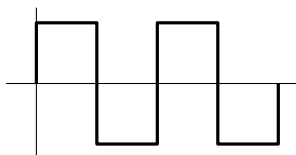

Sync

This switch turns the Sync on and off. When Sync is turned on, the LFO oscillator is always reset each time the keys are pressed.

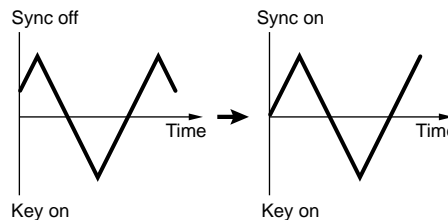

Settings: off, on

Delay

Sets the delay time from when the keyboard is played to when the LFO modulation begins. As shown in the diagram below, the larger the value, the longer the delay time.

Settings: 0 ~ 127

Short Delay

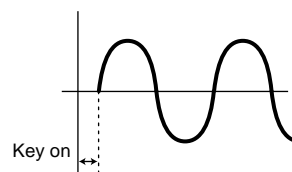

Long Delay

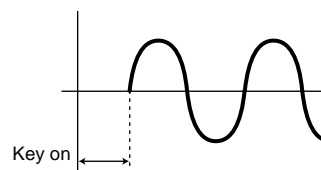

NOTE This setting can be applied to pitch only.

■ Fade

Sets the fade-in effect of the LFO after the designated delay time has passed. As shown in the diagram below, the larger the value, the longer it takes for the LFO effect to reach the peak in modulation.

□ Settings: 0 ~ 255

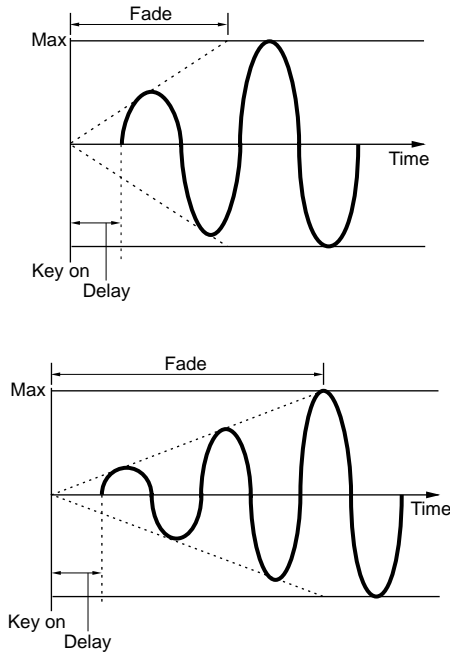

NOTE This setting can be applied to pitch only.

■ Speed

Sets the speed of the LFO wave modulation. The higher the value, the faster the speed.

□ Settings: 0 ~ 63

Slow

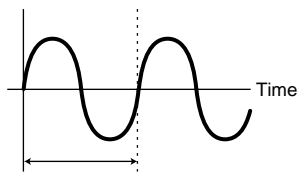

Fast

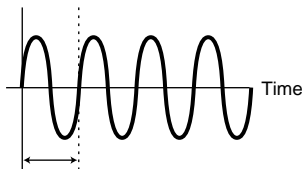

■ Vel (Velocity)

Sets the velocity sensitivity for the LFO speed. When Vel is set to a positive value, the harder the keyboard is played, the greater the LFO modulation. Negatives values will have the opposite effect.

□ Settings: -7 ~ +7

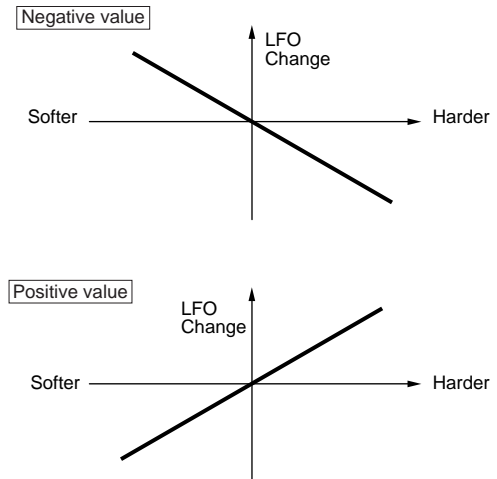

■ Rndm (Random)

Moves and changes the depth of the LFO speed (AMOD, PMOD, and FMOD below) randomly. The larger the value, the greater the change. A setting of "0" produces no effect.

□ Settings: 0 ~ 15

Small value

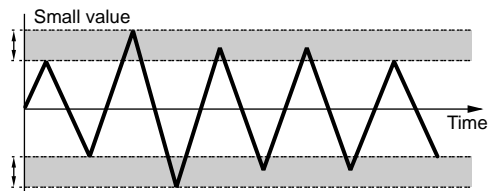

Large value

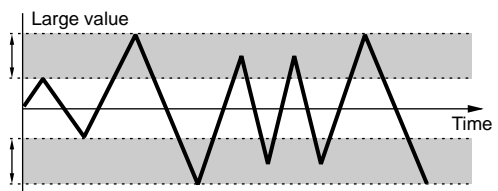

■ AMD (Amplitude Modulation Depth)

Determines how greatly the LFO will affect the output level. Larger values widen the range of the volume change.

□ **Settings:** 0 ~ 127

■ PMD (Pitch Modulation Depth)

Determines how greatly the LFO will affect the pitch. Larger values widen the range of the change in pitch. Negative values reverse the phase of the LFO wave.

□ **Settings:** -255 ~ 0 ~ +255

■ FMD (Filter Modulation Depth)

Determines how greatly the LFO will affect the filter cutoff frequency. Larger values widen the range of change in the cutoff frequency. Negative values reverse the phase of the LFO wave.

□ **Settings:** -127 ~ 0 ~ +127

NOTE The effect may not be audible, if the DCF is not properly set.

[F8]: LFO2 (Low Frequency Oscillator 2)

Sets the parameters for the LFO2. A different value can be set for each element.

```

VOICE EDIT      P1-001G1ASSE.P  1
-----Wave= tri
1 Wave = tri      Speed= 30  Phase= 0  0
2 Sync = on
- Delay = 0      Dest = 03:Pitch
- Fade = 0      Depth= 0
<CTRL>         LFO1 LFO2
    
```

■ Wave

Selects the LFO 2 wave. The waves selected here modulate the amplitude, filter, and pitch, to create effects like tremolo, waw, and vibrato, respectively.

□ **Settings:** sine, tri, saw u, saw d, squ, trpzd, s/h 1, s/h 2

NOTE Compared to the previously explained LFO1, the LFO2 has many more types of waves. However, only one item can be modulated at a time by the LFO2.

sine (sine wave)

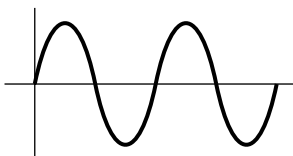

tri (triangle wave)

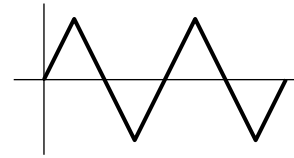

saw u (saw up wave)

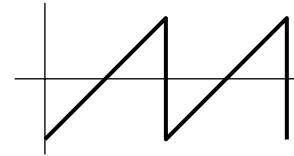

saw d (saw down wave)

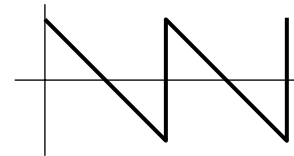

squ (square wave)

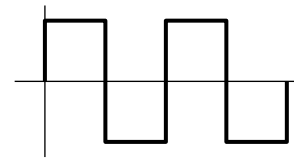

trpzd (trapezoid wave)

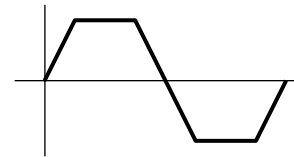

s/h 1 (sample & hold1)

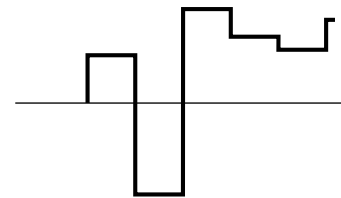

s/h 2 (sample & hold2)

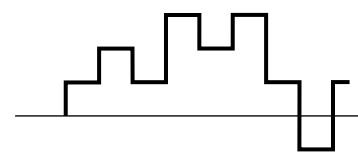

■ Sync

The parameters for LFO2 Sync are the same as for LFO1 Sync. For an explanation, see page 100.

■ Delay

The parameters for LFO2 Delay are the same as for LFO1 Delay. For an explanation, see page 100.

■ Fade

The parameters for LFO2 Fade are the same as for LFO1 Fade. For an explanation, see page 101.

■ Speed

The parameters for LFO2 Speed are the same as for LFO1 Speed. For an explanation, see page 101.

■ Phase

Sets the phase of the LFO frequency modulation wave at which a key is pressed.

As shown in the diagram below, the values 0-3 correspond to phase degrees as follows: 0, 90, 180, and 270, respectively.

□ **Settings:** 0 ~ 3

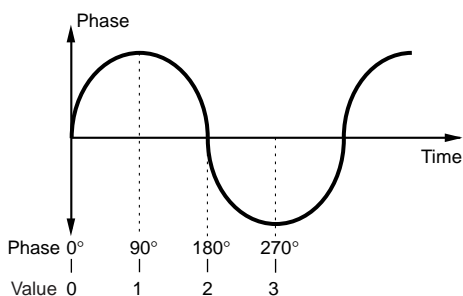

■ Dest (Destination)

Selects the objects to be modulated by the LFO2 wave.

□ **Settings:** 00: OFF
 01: volume
 02: pan
 03: pitch
 04: LFO1speed
 05: LFO1 PMD
 06: LFO1 AMD
 07: LFO1 FMD

■ Depth

Sets the depth of the LFO2 wave modulation.

□ **Settings:** 0 ~ 127

[F7]: CTRL (Controller)

The Controller parameters set the Controllers. Starting with the [PITCH] wheel on the front panel, various controllers can be set for each element. There are two menus available.

[F7]: PITCH (Pitch Control)

[F8]: SET (Controller Set)

[F3]: [REMAP]

[F7]: PITCH (Pitch Control)

Sets parameters for pitch bend and portamento. A different value can be set for each element.



■ Pitch Bend Upper

Sets the degree of pitch change in semitones (half steps) when the [PITCH] wheel is moved in an upwards direction. For example, a value of +12 means that moving the [PITCH] wheel upwards can raise the pitch a maximum of one octave.

□ **Settings:** -48 ~ 0 ~ +24

■ Pitch Bend Lower

Sets the degree of pitch change in semitones (half steps) when the Pitch Bend Wheel is moved in a downwards direction. For example, a value of -12 means that moving the [PITCH] wheel downwards can lower the pitch a maximum of one octave.

□ **Settings:** -48 ~ 0 ~ +24

■ Port Sw (Portamento Switch)

Turns the portamento “on” and “off.” Portamento creates a smooth glide in pitch from one note to the next. Portamento is a common function equally applied to all elements.

□ **Settings:** off, on

■ Port Time (Portamento Time)

Sets the time of the pitch glide between successively played notes. Higher settings result in a longer (slower) glide.

□ **Settings:** 0 ~ 127

■ Port Mode (Portamento Mode)

Selects the portamento mode. The way in which the portamento moves will differ depending on whether the Mono or Poly parameter is selected in the Common menu.

Settings: fngr (fingered), full

When “Mono” is selected in the Common menu:

fngr (fingered): Portamento is applied only when you play legato (playing a note before releasing the previous one).

full: Portamento is always applied.

When “Poly” is selected in the Common menu:

Same as for the mono (monophonic) mode except that portamento is applied to multiple notes.

[F8]: SET (Controller Set)

A variety of control change functions can be assigned to a controller such as the Control Knobs on the front panel or the keyboard. For example, aftertouch of the keyboard can be assigned to control vibrato or the [MODULATION] wheel can be assigned to apply resonance. The control functions can be assigned to affect a specific element. The assignment of controls to a voice is called voice control, and a maximum of 16 different Voice Controller Sets can be assigned to one voice.

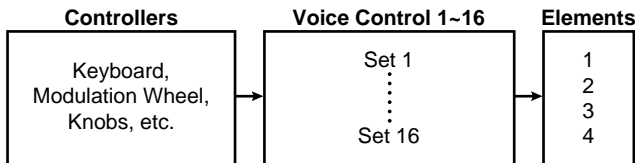
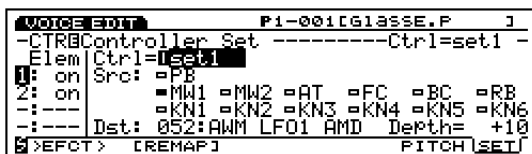

When you select [F8]: SET, [F3]: REMAP function will be added to the screen.

[F3]: REMAP

The Remap function allows you to arrange the Voice Controller Sets. For example, when you have created four Controller Sets, number 1, 3, 4 and 7, the numbers will be ranged from 1 through 4.

■ Ctrl (Controllers)

Selects the voice control number. When creating a Voice Controller Set, first select the control number.

Settings: Set 1-16 (Voice Controller set 1-16)

■ Elem Sw (Element Switch)

Sets the controller for each element as active (“on”) or inactive (“off”).

Settings: For each element 1-4, on, off

■ Src Sw (Source Switch)

Sets the control devices that control the functions selected with the Dst Param (Destination Parameter). Set the controllers that you want to use to “on.” There are 13 types of controllers, and it is possible to select more than one controller at a time.

Settings: PB (Pitch Bend Wheel), AT (After Touch), FC (Foot Controller), BC (Breath Controller), RC (Ribbon Controller), MW1 (Modulation Wheel 1), MW2 (Modulation Wheel 2), KN1 ~ 6 (Knobs1-6); for each controller, on, off

NOTE When VL or AN elements are selected, Vel (Velocity) parameter will be added to the “Src Sw.” You can control Dest Parameters by keyboard velocity.

■ Dest Param (Destination Parameter)

Sets the control function that will be assigned to a voice control set. The control function that is selected here will be controlled by the controller selected in Src Sw (Source Switch).

Settings: (See the Controller List in the separate Data List book.)

NOTE The available destination parameters are from No.45 through No.78. For more information, refer to the Controller List.

■ Dest Depth (Destination Depth)

Sets the depth for the control function selected in Dst Param.

□ **Settings:** -64 ~ 0 ~ 63

Assigning Controllers to the Controller Set

Due to the 16 voice controller sets, there are many possible combinations. For example, one Src Sw (Source Switch) can control various Destinations Parameter (Dest Param), or various Source Switch (Src Sw) can control a single Dest Param (Destination Parameter).

Example 1: One Source Switch controls various Destination Parameter.

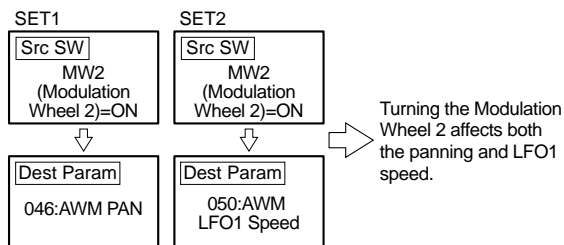

Example 2: Various Sources controls one Destination.

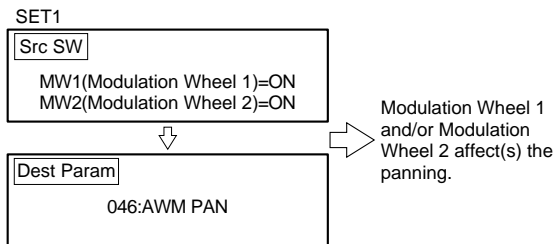

[F8]: EFCT (Effects)

The Effect parameters sets the parameters related to the two types of Insertion effects and the System (Reverb and Chorus) effects. The effects signal flow can be confirmed in the graphic display screen as you set values. There are five menus available.

- [F4]: TYPE
- [F5]: INS1 (Insertion 1)
- [F6]: INS2 (Insertion 2)
- [F7]: REV (Reverb)
- [F8]: CHO (Chorus)

NOTE For more information on Insertion and System effects, see page 65.

F4: TYPE

Sets the type of Insertion Effect 1/2 as well as the Reverb and Chorus. You can set the send and return levels of each effect unit.

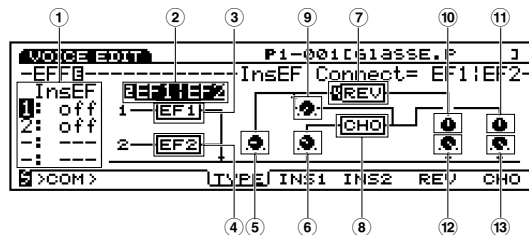

■ ① InsEF Elem Sw (Insertion Effect Element Switch)

Selects the Insertion Effect unit for each element. When “off” is selected the Insertion Effect unit is bypassed.

□ **Settings:** For each element, 1 (Insertion Effect unit 1), 2 (Insertion Effect unit 2), off

NOTE If you select and edit an AN or FDSP voice on EX7, you cannot use insertion Effect. For more information, see page 54.

■ ② InsEF Connect (Insertion Effects Connect)

Sets how Insertion Effects 1 and 2 are configured. The graphical display visually maps out the course of the signal and displays changes made in the type of connection.

□ **Settings:** 1: 2 (parallel connection), 1 > 2 (the signal travels from the Insertion Effect 1 to the Insertion Effect 2 in a serial connection), 2 > 1 (the signal travels from the Insertion Effect 2 to Insertion Effect 1 in a serial connection)

■ ③ InsEF1 (Insertion Effect 1)

Selects the type of effect for Insertion Effect 1.

□ **Settings:** 00 (thru) ~ 24

NOTE For more information about each type of effect, see the Effect Type List in the separate Data List book.

■ ④ InsEF2 (Insertion Effect 2)

Selects the type of effect for Insertion Effect 2.

□ **Settings:** 00 (thru) ~ 79

NOTE For more information about each type of effect, see the Effect Type List in the separate Data List book.

■ ⑤ Rev Send (Reverb Send)

Sets the send level of the signal output from Insertion Effect 1/2 (or by-passed) and sent to the Reverb unit.

□ **Settings:** 0 ~ 127

■ ⑥ Cho Send (Chorus Send)

Sets the send level of the signal output from the Insertion Effect 1/2 (or by-passed) and sent to the Chorus unit.

□ **Settings:** 0 ~ 127

■ ⑦ Rev (Reverb)

Selects the type of reverb for the Reverb unit.

□ **Settings:** 00 (off) ~ 12

NOTE For more information about each type of Reverb, see the Effect Type List in the separate Data List book.

■ ⑧ Cho (Chorus)

Selects the type of chorus for the Chorus unit.

□ **Settings:** 00 (off) ~ 17

NOTE For more information about each type of Chorus, see the Effect Type List in the separate Data List book.

■ ⑨ Cho→Rev (Chorus→Reverb)

Sets the send level of the signal output from the Chorus unit and sent to the Reverb unit.

□ **Settings:** 0 ~ 127

■ ⑩ Rev Pan (Reverb Pan)

Sets the panning of the signal output from the Reverb unit.

□ **Settings:** L64 (far left) ~ cnt (center) ~ R63 (far right)

■ ⑪ Cho Pan (Chorus Pan)

Sets the panning of the signal output from the Chorus unit.

□ **Settings:** L64 (far left) ~ cnt (center) ~ R63 (far right)

■ ⑫ Rev Return (Reverb Return)

Sets the return level of the signal output from the Reverb unit.

□ **Settings:** 0 ~ 127

■ ⑬ Cho Return (Chorus Return)

Sets the return level of the signal output from the Chorus unit.

□ **Settings:** 0 ~ 127

[F5]: INS1 (Insertion 1)

Sets various parameters for the currently selected Insertion 1 effect.

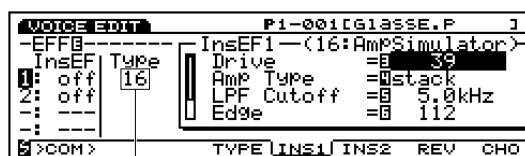

Currently selected effect type

□ **Settings:** (The number of parameters and values available differs depending on the currently selected effect type. For more information, see the Effect Parameter List in the separate Data List book.)

[F6]: INS2 (Insertion 2)

Sets various parameters for the currently selected Insertion 2 effect.

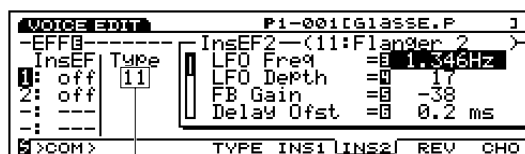

Currently selected effect type

□ **Settings:** (The number of parameters and values available differs depending on the currently selected effect type. For more information, see the Effect Parameter List in the separate Data List book.)

[F7]: REV (Reverb)

Sets various parameters for the currently selected Reverb effect.

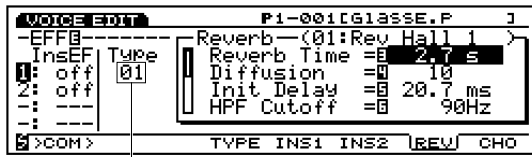

Currently selected reverb type

- **Settings:** (The number of parameters and values available differs depending on the currently selected Reverb type. For more information, see the Effect Type List in the separate Data List book.)

[F8]: CHO (Chorus)

Sets various parameters for the currently selected Chorus effect.

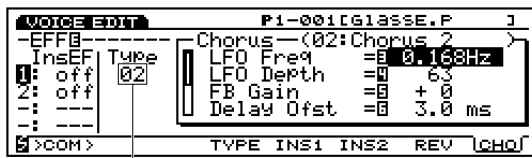

Currently selected Chorus type

- **Settings:** (The number of parameters and values available differs depending on the currently selected Chorus type. For more information, see the Effect Type List in the separate Data List book.)

Normal Voice (VL Element) (EX5/5R only)

The following explanations include only the differences between the VL Element and the AWM Elements. The remaining functions and parameters are the same as those for the AWM Elements. For more information, see the relevant sections starting on page 77.

[VOICE]

Normal + [EDIT] VL Element

- [F1:COMMON]107
 - [F6:Parameter]107
 - [F7:Arpeggio]79
 - [F3:Arpeggio-Edit]79
 - [F8:Name]79
- [F2:OSCILLATOR]108
 - [F6:Wave]108
 - [F7:Mix]81
 - [F8:Zone]82
- [F3:PITCH]108
 - [F6:Parameter]83
 - [F7:Scaling]83
 - [F8:EG]109
- [F4:FILTER]109
 - [F7:EQ]109
 - [F8:DCF]110
- [F5:AMPLITUDE]110
 - [F6:Parameter]96
 - [F8:EG]110
- [F6:LFO]111
 - [F8:LFO]111
- [F7:CONTROLLER]111
 - [F7:Pitch Control]103
 - [F8:Controller Set]111
 - [F3:Remap]111
- [F8:EFFECT]105
 - [F4:Type]105
 - [F5:Insertion Effect 1]106
 - [F6:Insertion Effect 2]106
 - [F7:Reverb]107
 - [F8:Chorus]107

* The parameters in the above grayed menus are the same as those found in the AWM Elements.

[F1]: COM (Common)

[F6]: PARAM (Parameters)

When VL is selected as a Voice Type from the PARAM menu, it is possible to create a voice with one VL Element and three AWM Elements. The first element is fixed as VL Element, and remaining Elements are for the AWM Elements. The parameters explained below will be added to the screen.

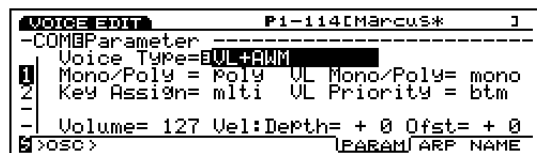

■ VL Mono/Poly (VL Monophonic/Polyphonic)

Selects how the VL Element produces sound. The VL Element is limited to only one sound at a time. However, as shown below, the way in which sound is produced is different depending on whether “mono” (monophonic) or “poly” (polyphonic) is selected. Select the mode that best suits your playing style.

Settings:

mono:

If the one key (which was currently sounding) is released while the other key is held, a new note will be triggered.

poly:

If the one key (which was currently sounding) is released while the other keys are held, the other note will not be retriggered.

NOTE For the other three AWM Elements, how each element produces sound is determined by the Mono/Poly parameters on page 79.

■ VL Priority

Determines the priority for notes played as the VL Element. When chords or several notes are played at the same time, you can select which note will sound: last (the note that was played last), top (the highest note), or bottom (the lowest note).

Settings: last, top, btm (bottom)

[F2]: OSC (Oscillator)

[F6]: WAVE

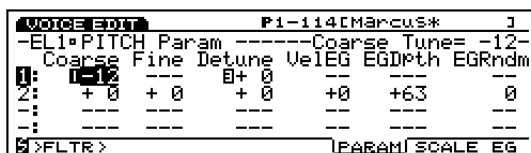

■ Bank

VL can be selected only for the first Element.

■ Number

Selects the VL Element wave number. Displayed to the right of the number is the category name of the wave and wave name.

Settings: (For more information about each type of wave, see the Wave List in the separate Data List book.)

■ WavePlay

When the VL Element is selected, WavePlay is inactive and hyphens (---) will display.

■ KeyOn Delay

When the VL Element is selected, KeyOn Delay is inactive and hyphens (---) will display.

[F3]: WAVE-EDIT

When the VL Element is selected, Wave-Edit is inactive. For more information about Wave-Edit, see page 150.



[F3]: PITCH (Pitch Parameters)

[F6]: PARAM (Parameters)

Only the Coarse Tune and Detune parameters are available for the VL Element. The values that can be set with these parameters are the same as those explained for AWM Elements on page 83. The remaining parameters are inactive and hyphens (---) will be displayed.

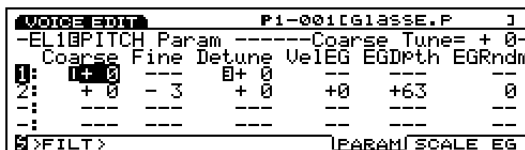

[F7]: SCALE

Sets the pitch scaling for the VL element. The available parameters are the same as those for AWM element on page 83.

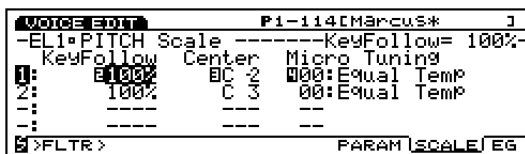

[F8]: EG (Pitch Envelope Generator)

The following screen appears when the VL Element is selected in the PEG screen.

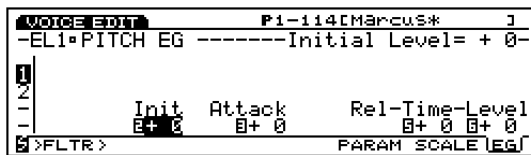

■ Initial Level

Sets the initial pitch of the VL Element when a note is played. When the Initial Level is set to a positive value, the pitch generated will be higher than the correct pitch. Negative values cause the pitch generated to be lower than the correct pitch. The correct pitch is generated when Initial Level is set to a value of “0.”

□ **Settings:** -64 ~ 0 ~ +63

■ Attack Time

Sets the amount of time it takes for the VL Element to reach the correct pitch from when a note is played. When Attack Time is set to a positive value, the change occurs more slowly. Negative values cause the change to occur more quickly.

□ **Settings:** -64 ~ 0 ~ +63

■ Release Time

Sets the amount of time it takes to reach the designated Release Level pitch from when a key is released. When Release Time is set to a positive value, the change occurs more slowly. Negative values cause the change to occur more quickly.

□ **Settings:** -64 ~ 0 ~ +63

■ Release Level

Sets the last pitch of the note from when a key is released. When Release Level is set to a positive value, the pitch generated changes towards a higher pitch. Negative values causes the pitch generated to be lower. Selecting a value of “0” produces a pitch that moves towards the correct pitch.

□ **Settings:** -49 ~ 0 ~ +50

[F4]: FILT (Filter)

When VL Element is selected, following two menus are available for Filter parameters.

[F7]: EQ (Equalizer)

[F8]: DCF (Dynamic Control Filter)

[F7]: EQ (Equalizer)

The 5-band parametric equalizer with the parameters, Frequency, Q, and Gain, permit further sound tailoring capability. There is also a post EQ parameter.

	EQ1	EQ2	EQ3	EQ4	EQ5	Post
Freq :	24	39	64	74	61	EQ
Reso :	0	0	0	0	0	EQ
Gain :	+12	+13	+5	+7	+9	-2

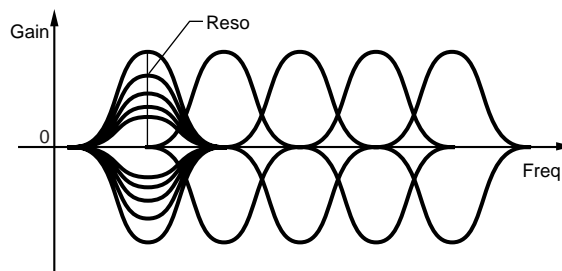

■ EQ1 ~ EQ5 Freq (EQ1 ~ EQ5 Frequency)

Sets the central frequency of each band.

□ **Settings:** 0 ~ 48 for each point from EQ1 ~ EQ5

■ EQ1 ~ EQ5 Reso (EQ1 ~ EQ5 Resonance)

Increase or decrease the central frequency of each of the five frequency bands set in Freq. This, combined with Gain level control capability, lets you create unique EQ curves.

□ **Settings:** 0 ~ 127

■ EQ1 ~ EQ5 Gain

Sets each of the central frequency signal levels for EQ1-EQ5.

□ **Settings:** -64 ~ 0 ~ +63

■ Post EQ

Adjusts the output level of the signal passed through the EQ. The signal adjusted here will be sent to an Insertion Effect.

□ **Settings:** -8 ~ 0 ~ +8

[F8]: DCF (Dynamic Control Filter)

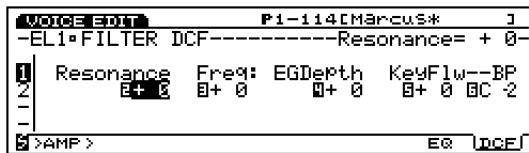

■ Resonance

Parameters which let you boost specific frequencies around the cutoff frequency.

□ **Settings:** -64 ~ 0 ~ +63

■ Cutoff Freq (Cutoff Frequency)

Sets the cutoff frequency for the filter.

□ **Settings:** -64 ~ 0 ~ +63

■ Freq EG Depth (Frequency EG Depth)

Sets the depth of the change in the cutoff frequency over time. The larger the value, the wider the change in depth becomes. Negative values will produce an inverted envelope.

□ **Settings:** -64 ~ 0 ~ +63

■ Freq K.Follow (Frequency Key Follow)

Sets the cutoff frequency for KeyFollow. The Freq K.Follow function adjusts the cutoff frequency in accordance with the notes played on the keyboard. When Freq K.Follow is applied, the cutoff frequency changes relative to the pitch set in the Freq K.FlW BP (explained below). When set to a positive value, the lower the note played, the lower the cutoff frequency becomes. When a negative value is set, the higher the note played, the lower the cutoff frequency.

□ **Settings:** -64 ~ +63

■ Freq K.FlW BP (Frequency KeyFollow Break Point)

Sets the basic pitch for Frequency KeyFollow.

□ **Settings:** C-2 ~ G8

[F5]: AMP (Amplitude)

When VL Element is selected, there are two menus available with Amplitude parameters.

[F6]: PARAM (Parameters)

[F8]: EG (Envelope Generator)

[F6]: PARAM (Parameters)

When the VL Element is selected, Level Vel (Level Velocity) is inactive. Other settings are the same as for the AWM Elements. For more information about AWM Elements, see page 96.

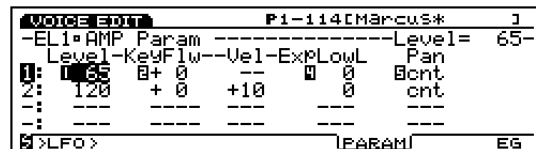

[F8]: EG (Envelope Generator)

Sets the Amplitude Envelope Generator for the VL Element.

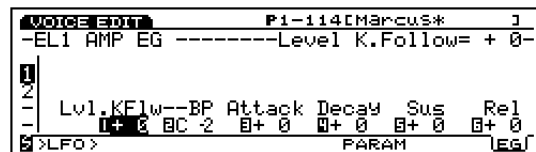

■ Level K.Follow (Level KeyFollow)

Sets the Level KeyFollow for the VL Element. The Level K.Follow function adjusts the output level in accordance with the notes played on the keyboard. When Level K.Follow is applied, the output level changes relative to the output level set in the Level K.FlW BP (explained below). When set to a positive value, the lower the note played, the lower the output level becomes. When a negative value is set, the higher the note played, the lower the output level becomes.

□ **Settings:** -64 ~ +63

■ Level K.FlW BP (Level Key Follow Break Point)

Sets the basic pitch for the VL Element Level KeyFollow.

□ **Settings:** C-2 ~ G8

■ Attack Time

Sets the amount of time it takes to reach the peak in volume from when a note is played. When Attack Time is set to a positive value, the peak is reached more slowly. Negative values cause the peak to be reached more quickly.

❑ **Settings:** -64 ~ 0 ~ +63

■ Decay Time

Sets the amount of time it takes to reach the sustain level from the peak in volume. When Attack Time is set to a positive value, change occurs more slowly. Negative values cause change to occur more quickly.

❑ **Settings:** -64 ~ 0 ~ +63

■ Sustain Level

Sets the Sustain Level (after the Decay Time is finished), where the sound remains at a constant level while the key is pressed.

❑ **Settings:** -64 ~ 0 ~ +63

■ Release Time

Sets the amount of time it takes for the sound to decay to a volume of 0 from when the key is released. When Release Time is set to a positive value, the decay occurs more slowly. Negative values cause the decay to occur more quickly.

❑ **Settings:** -64 ~ 0 ~ +63

[F6]: LFO (Low Frequency Oscillator)

When VL Element is selected, one menu of LFO parameters is available.

[F8]: LFO (Low Frequency Oscillator)

[F8]: LFO (Low Frequency Oscillator)

Sets the LFO parameters for the VL Element. Applying LFO modulation to the pitch creates vibrato.

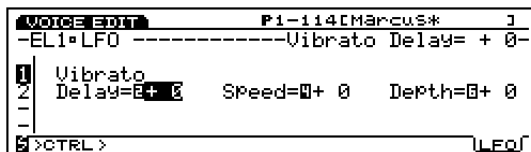
**■ Vibrato Delay**

Sets the delay time from when the keyboard is played to when the vibrato effect begins. The larger the value, the longer the delay time before the vibrato effect begins. Negative values cause the delay time to be shorter. For more details about Delay, see page 100.

❑ **Settings:** -64 ~ 0 ~ +63

■ Vibrato Speed

Sets the speed of the vibrato effect. The larger the value, the faster the movement of the vibrato. For more information about Speed, see page 101.

❑ **Settings:** -64 ~ 0 ~ +63

■ Vibrato Depth

Sets the depth of the vibrato. The larger the value, the deeper the vibrato.

❑ **Settings:** -64 ~ 0 ~ +63

[F7]: CTRL (Controller)

The available menus for the VL Element are as follows:

[F7]: PITCH
[F8]: SET
[F3]: REMAP

[F7]: PITCH

The available parameters are the same as those of the AWM Element (page 103).

[F8]: SET

“Velocity” is added to the Src (Source) parameter. You can control Dest (Destination) parameters by keyboard velocity. The available destination parameters are from No.126 to the end. For more information, refer to the Controller List in the separate Data List book.

When you select [F8]: SET, [F3]: REMAP function will also be added to the screen. The Remap function allows you to arrange the Voice Controller Sets. For example, when you have created four Controller Sets, number 1, 3, 4 and 7, the numbers will be ranged from 1 through 4. In addition, pressing the [F3] REMAP may provide you with recommendable preset Voice Controller Sets depending on the selected VL voice.

NOTE When you press [F3] key to execute the Remap function without enough vacant Controller Sets, “Can’t set VL control!” will be displayed indicating that the Remap function is impossible.

Normal Voice (AN Element)

Explanations below cover only the differences between the AN Element and the AWM Elements. The remaining functions and parameters are the same as for the AWM Elements. For explanations, see the relevant sections in this Owner's Manual.

VOICE

Normal + [EDIT] AN Element

- [F1:COMMON].....112
 - [F6:Parameter]112
 - [F7:Arpeggio]79
 - [F3:Arpeggio-Edit].....79
 - [F8:Name]79
- [F2:OSCILLATOR]113
 - [F3:Algorithm]113
 - [F4:VCO]114
 - [F5:Modulation]116
 - [F6:Wave]116
 - [F7:Mix]81
 - [F8:Zone].....82
- [F3:PITCH]117
 - [F6:Parameter]83
 - [F7:Scaling]83
 - [F8:EG]117
- [F4:FILTER]118
 - [F7:VCF].....118
 - [F8:EG]119
- [F5:AMPLITUDE]119
 - [F6:Parameter]96
 - [F7:Mixing]119
 - [F8:EG].....120
- [F6:LFO]121
 - [F8:LFO].....121
- [F7:CONTROLLER]123
 - [F7:Pitch Control]103
 - [F8:Controller Set]123
- [F8:EFFECT]105
 - [F4:Type]105
 - [F5:Insertion Effect 1]106
 - [F6:Insertion Effect 2]106
 - [F7:Reverb]107
 - [F8:Chorus]107

* The parameters in the above grayed menus are the same as those found in the AWM Elements.

[F1]: COM (Common)

[F6]: PARAM (Parameters)

When an AN Element Voice Type, AN (Poly) + AWM, AN (Layer) + AWM or AN + FDSP is selected from the PARAM menu, the following parameters will be added to the screen.

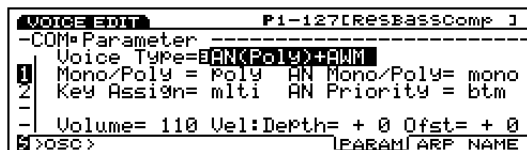

NOTE AN (Layer) + AWM and AN + FDSP Voice Types are not available with the EX7.

NOTE When AN + FDSP Voice Type is selected, the function key [F5] for the FDSP at the bottom of the screen will be added and the FDSP parameters can be accessible. For more information about the FDSP, see page 123.

NOTE When the AN (Poly) + AWM or AN + FDSP Voice Type is selected, the first Element is fixed as an AN Element. When the AN (Layer) + AWM is selected, the first and second Elements are fixed as an AN Element. The remaining Elements are for the AWM Elements. (Set in the OSC WAVE screen.)

■ AN Mono/Poly (AN Monophonic/Polyphonic)

Selects how an AN Element produces sound. There are two types, “mono” for monophonic and “poly” for polyphonic. However, even if Poly mode is selected for an AN Element, only one note is produced with EX7 and two notes at maximum for EX5/5R. Select the mode that best suits your playing style.

□ Settings:

mono:

Only one note can be produced at a time. If two keys are held simultaneously, a new note will be triggered when the first key which currently produces sound is released.

poly:

With the EX7, only one sound can be produced at a time. The EX5/5R in Poly mode can produce one or two sounds depending on the selected Voice Type. In Poly mode, if two or more keys are held simultaneously, when the first key which currently produces sound is released, the other notes will not be retriggered.

Voice Type	EX5/5R	EX7
AN(Poly)	2 notes	1 note
AN(Layer)	1 note	—
AN+FDSP	1 note	—

NOTE For the other three (or two) AWM Elements, how each element produces sound is determined by the AWM Mono/Poly parameter on page 79.

■ AN Priority

Determines the priority for notes played as an AN Element. When chords or several notes are played at the same time, you can select which note will sound, as follows: last (the note that was played last), top (the highest note), bottom (the lowest note).

❑ **Settings:** last, top, btm (bottom)

[F2]: OSC (Oscillator)

In the OSC's WAVE/MIX/ZONE screen, three menus related to AN are added to the screen when an AN element is selected (when the cursor is positioned on either of the AN element parameters), as shown below.

- [F3]: ALG (Algorithm)
- [F4]: VCO (Voltage Controlled Oscillator)
- [F5]: MOD (Modulation)
- [F6]: WAVE
- [F7]: MIX
- [F8]: ZONE

[F3]: ALG (Algorithm)

An algorithm defines the way the two VCO1 oscillators (master and slave) are connected in relation to the FM(Frequency Modulation). Here you can select an algorithm and set parameters related to the “sync” and FM.

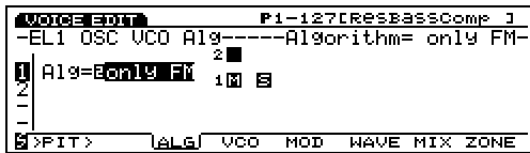

NOTE For more information about the general concepts of the VCO and AN tone generation, see page 33.

■ Algorithm

For selecting the algorithm. One algorithm can be selected from the four types of algorithms listed below. Available parameters differ depending on the currently selected algorithm.

❑ **Settings:** only FM, FM/both, FM/mstr (master), FM/sl (slave)

only FM (Sync is disabled): When selected, no other parameter is available.

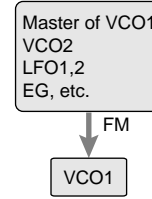

FM/both (Sync is enabled and FM is applied to both master and Slave oscillators): When selected, Sync Pitch, Depth, Src parameters are added.

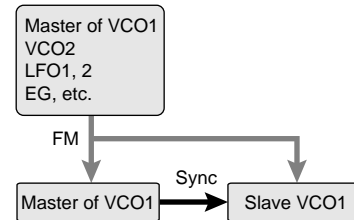

FM/mstr (Sync is enabled and FM is applied to the master oscillator): When selected, FM Modulator, Depth, Src parameters are added to those for “FM/both.”

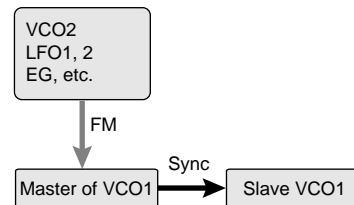

FM/sl (Sync is enabled and FM is applied to the slave oscillator): The available parameters are the same as those for “FM/mstr.”

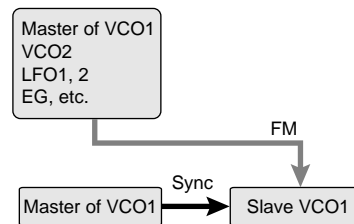

Sync

Synchronizing the master and slave oscillator in VCO1 will increase the wave harmonics and create a more complex sound. The Sync is automatically set to “on” when an algorithm other than FM is selected.

NOTE The FM algorithm does not contain the master and slave oscillators but functions just as one VCO.

FM (Frequency Modulation)

In FM, the source wave that modulates another wave is called a modulator, while waves that are modulated are called carriers. No matter what algorithm is selected for an AN element, VCO1 is always fixed as the FM carrier. The FM modulator will differ depending on the algorithm and can be selected from VCO1 master oscillator, VCO2, LFO1/2, EG, or others.

The parameters listed below are not related to FM algorithms. When an FM algorithm is selected, these parameters are not displayed in the screen.

Sync Pitch

Adjusts the pitch of the slave oscillator in semitones. This lets you create a difference in pitch between the master and slave oscillators and control the resulting harmonic interval. A sound with many harmonic overtones, or a brighter tone can be created. The larger the value, the greater the effect, whereas the lower the value, the more rounder and softer the tone becomes. A setting of “0” produces a pitch which is the same as the master oscillator.

Settings: -64 ~ 0 ~ +63

Sync Depth

Sets the amount of depth of control from the Sync Src (Sync Source) over time. The larger the value, the greater the change in depth.

Settings: -64 ~ 0 ~ +63

Sync Src (Sync Source)

Sets the source signal which applies the modulation over time to the slave oscillator.

Settings: fixed, PEG, FEG, LFO1, LFO2

NOTE When set to “fixed,” there is no change in modulation over time.

FM Modulator

Selects the source unit to get the frequency modulation. The waveform of the source selected here modulates the VCO1 wave.

Settings: fixed, PEG, FEG, LFO1, LFO2

NOTE When set to “fixed,” there is no change in modulation over time.

FM Depth

Adjusts the amount of modulation created by the FM modulator. The larger the value, the greater the modulation depth.

Settings: -64 ~ +63

FM Src (FM Source)

Sets the modulation source which controls the FM Depth.

Settings: VCO2, VCO1, VCO1s (sub oscillator), PEG, FEG, LFO1, LFO2

[F4]: VCO (Voltage Controlled Oscillator)

Sets the parameters related to the two VCOs (VCO1/2) that can be used by the AN element.

VOICE EDIT		P1-127[RESBASSComp 1	
-EL1BOSC VCO Param-VCO1 FreqCoarse= + 0-			
1	VCO1:	1+0	0+0
2	VCO2:	+0	+0
		Wave	Edge
		Width	
		127	64
[>PIT>] ALG [WCO] MOD WAVE MIX ZONE			

VCO1/2 FreqCoarse (VCO1/2Frequency Coarse)

Adjusts the pitch of each VCO1/2 oscillator in semitones. A setting of “0” produces a pitch the same as the basic pitch of the currently selected VCO1/2 wave.

Settings: -64 ~ 0 (basic pitch) ~ +63

VCO1/2 Freq Fine (VCO1/2Frequency Fine)

Adjusts the pitch of each VCO1/2 oscillator in cents.

Settings: -49 ~ 0 ~ +50cent

VCO1/2 PitchScale

Sets the Pitch Scale for each VCO1/2 oscillator. The Pitch Scale function corrects the pitch change of VCO1/2 in accordance with the notes played on the keyboard. When VCO1/2 Pitch Scale is applied, the pitch change is increased or decreased relative to the specific pitch, which is designated here as MIDI note number 64 (E3).

Settings: -64 ~ 0 ~ +63

VCO1/2 Wave

Selects the wave for each VCO1/2 oscillator. Waves available for VCO1 depend on the current Sync status (on/off).

Settings:

VCO1 (when Sync is set to on: other than only FM): saw, pulse, innr1/2/3 (inner1/2/3)

VCO1 (when Sync is set to off: only FM): saw, pulse, saw2, mix

VCO2: saw, pulse, saw2, mix

saw (Sawtooth wave)

As seen in the diagram, this wave derives its name from its shape, and is used to create a brass instrument sounds such as trumpet and strings such as violin. Since it contains all harmonics in the spectrum, it produces a full rich sound. When used with the Pulse Width function (see page 116), increasing the even harmonics can raise the pitch to a maximum of a full octave.

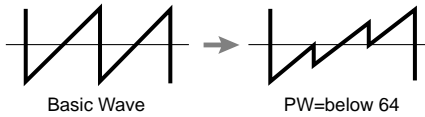

pulse (Pulse wave)

The pulse (square) wave, familiar as dial tone of touch-tone phone, is used to make woodwind instrument sounds. When the Pulse Width is set to 64, the waveform will contain only odd-numbered harmonics.

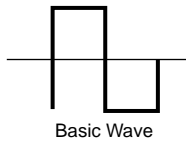

saw2 (Sawtooth2)

This wave is slightly different from the saw wave. The spectrum of the saw2 wave is created by a sawtooth wave combined with a pulse wave, and therefore. When the Pulse Width is set to 64, the wave shape is the same as the saw. As you change the Pulse Width, the even-number harmonics increase and the saw wave volume becomes larger. Even if the pitch is raised an octave, the basic pitch remains the same.

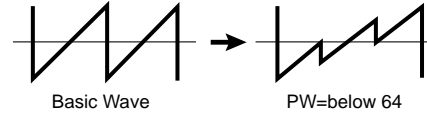

mix (Mix)

This mix wave is a mix of the saw and pulse waves.

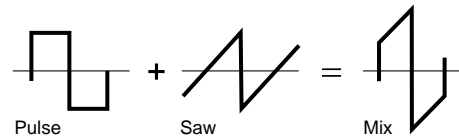

Innr1 (Inner1: Inner1)

Innr2 (Inner2: Inner2)

Innr3 (Inner3: Inner3)

Active when the Sync function is on. This waveform is output according to the Sync's structural formula. These three types are effective when used with the Pulse Width.

VCO1/2 Edge

Adjusts the shape of each VCO1/2 wave. The larger the value, the sharper the wave becomes, whereas the smaller the value, the rounder and softer the wave becomes. This parameter can make the sound harsher or softer.

Settings: 0 ~ 127

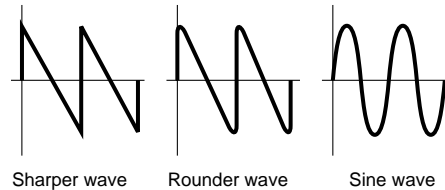

■ VCO1/2 PulseWidth

Adjusts the width of each VCO1/2 pulse wave. When the pulse is set to a value of 64, the pulse wave is equally balanced, generating only odd-numbered harmonics. When the value of 64 is increased or decreased, the more the pulse width changes, the fatter the sound becomes, caused by the increase in harmonics. In general, the Pulse Width parameter is used to control the width of the pulse (pulse wave); however, it can be used for waves other than the pulse with the EX5/5R/7, providing much more possibilities in sound creation.

Settings: 0 ~ 64 ~ 127 (0% ~ 50% ~ 99%)

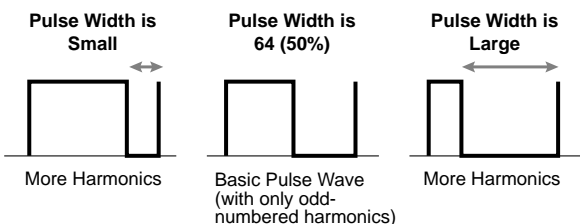

[F5]: MOD (Modulation)

Settings related to the VCO (VCO1/2) modulation.

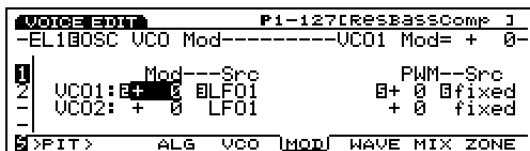

■ VCO1/2 Mod (VCO1/2Modulation)

Sets the depth of the pitch modulation for each VCO1/2 wave applied by LFO1 or LFO2. When set to a positive setting, the higher the value, the wider the range of the pitch change becomes. Negative settings reverse the phase signal waveform of LFO1 or LFO2.

Settings: -128 ~ 0 ~ +127

■ VCO1/2 Mod Src (VCO1/2 Modulation Source)

Selects which source signal (LFO1 or LFO2) will be used to modulate the pitch of each VCO1/2 wave.

Settings: LFO1, LFO2

■ VCO1 ModSw (VCO1 Modulation Switch)

When the pitch of VCO1 wave is modulated by LFO1 or LFO2, this setting selects which waveform (the master oscillator or the slave oscillator inside VCO1) will be modulated.

Settings: master (master oscillator), slave (slave oscillator), both (both the master and the slave oscillator)

NOTE This is active only when VCO1 is selected, and Sync is set to “on” (other than only FM). This parameter cannot be selected with VCO2.

■ VCO1/2 PWM (Pulse Width Modulation)

Sets the amount of depth of the pulse width for each VCO1/2 wave, which is adjusted by the PWM Src (Pulse Width Modulation Source). When set to a positive setting, the higher the value, the greater the change in the width. Negative settings reverse the phase signal waveform from the source.

Settings: -64 ~ +63

■ PWM Src (Pulse Width Modulation Source)

Sets the source wave used to modulate the pulse width of VCO1/2 wave. The pulse width is modulated by the signal waveform of the source selected here.

Settings: fixed, PEG, FEG, LFO1, LFO2, LFO2p (phase), LFO2f (fast)

NOTE When set to “fixed,” there is no change in modulation over time.

NOTE Low Frequency Oscillator 2 Phase (LFO2p) shifts the LFO2 wave later by 60 degrees. Low Frequency Oscillator 2 Fast (LFO2f) slightly speeds up the LFO2 cycle.

[F6]: WAVE

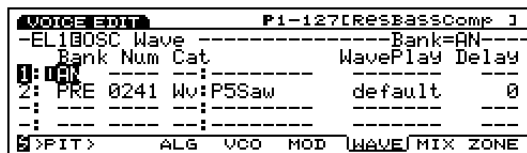

Bank

In the COM PARAM screen (explained above), when the Voice Type, AN (Poly) + AWM or AN + FDSP is selected, the first Element wave is always set as an AN Element. When the Analog Layer is selected, the first and second Elements are always set as an AN Element. The remaining three or two Elements can be used as AWM Elements.

Settings: AN, off

NOTE Different from the AWM tone generator, the Num (Wave Number) cannot be accessible in the AN Element. Also, LoopMode and KeyOn Delay are inactive and hyphens (---) will be displayed for those parameters.

[F7]: MIX

The available parameters are the same as those for AWM Element (page 81).

[F8]: ZONE

The available parameters are the same as those for AWM Element (page 82).

[F3]: PITCH (Pitch Parameters)

[F6]: PARAM (Parameters)

The parameters, Coarse Tune, Detune, and Random can be used to set the AN Element. Available settings are the same as for the AWM Element (see page 83). All other parameters are inactive, and hyphens (---) will be displayed.

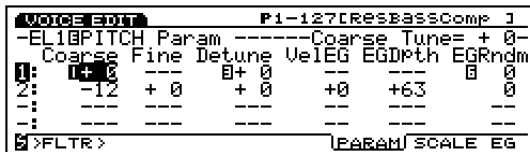

[F7]: SCALE

Sets the pitch scaling for the AN Element. The available parameters are the same as those for AWM Element (page 83).

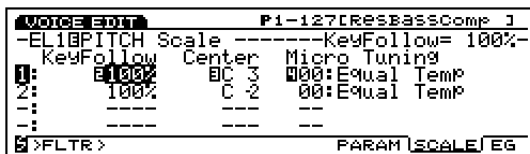

[F8]: EG (Envelope Generator)

The following screen appears when the AN Element is selected in the PEG screen.

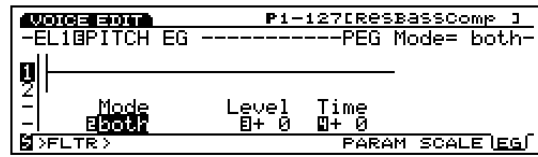

PEG Mode

Selects the VCO that will be affected by the PEG.

Settings: VCO1, VCO2, both (both VCO1 and VCO2)

PEG Depth

Sets the amount of pitch change of the PEG in semitones. When the PEG Decay Time (explained below) is set to a positive value, the value set here will be the pitch right after the key is played. Also, when the PEG Decay Time is set to a negative value, the value set here will be the last pitch after change has occurred from the basic pitch (see the graph below). When set to a positive value, the higher the value, the higher the pitch becomes. When set to a negative value, the higher the negative value, the lower the pitch becomes. A setting of “0” produces the basic pitch, and the pitch will not change.

Settings: -64 ~ 0 (basic pitch) ~ + 63

PEG Decay = Positive setting

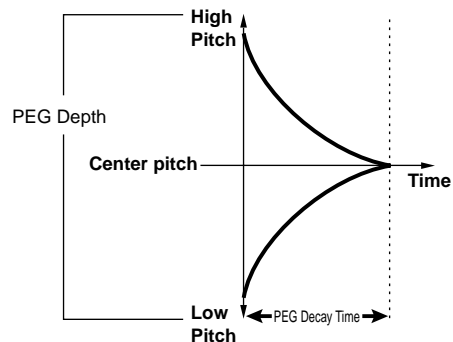

PEG Decay = Negative setting

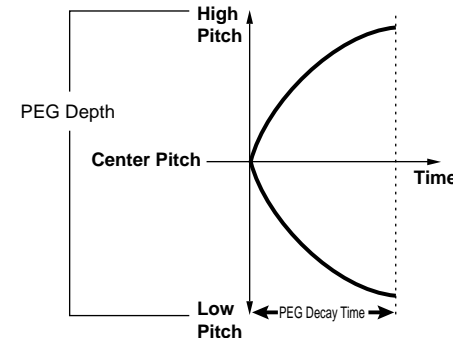

■ PEG Decay Time

Sets the PEG Decay Time. When set to a positive value, this setting determines the amount of time for the sound to reach its basic pitch from the PEG Depth level. When a negative value is set, this setting determines the amount of time starting from the basic pitch to the set PEG Depth level.

❑ **Settings:** -64 (0.3 milliseconds) ~ +63 (10.6 milliseconds)

NOTE See the previous pitch change graph for an illustration of the relationship between PEG Depth and PEG Decay.

[F4]: FILT (Filter)

When an AN Element is selected, there are two types of menus related to filter settings available.

[F7]: VCF (Voltage Controlled Filter)

[F8]: EG (Envelope Generator)

[F7]: VCF (Voltage Controlled Filter)

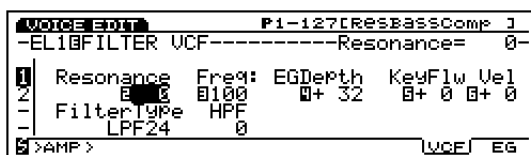

Settings related to the VCF. The VCF is a filter which affects the harmonic structure of the VCO wave by permitting a specific range of frequencies to pass, while cutting off the rest. There are various types of filters that change the timbre of the sound. Also, as explained later, the FEG can be used to affect how the timbre of the sound changes over time.

■ Resonance

Sets the strength of the resonance effect. This setting determines the amount of resonance boost near the cutoff frequency and create completely unique sounds.

❑ **Settings:** -12 ~ 0 ~ +102

■ FilterType

Selects the type of filter.

❑ **Settings:** LPF24, LPF18, LPF12, BPF, HPF, BEF

NOTE For more information about each type of filter, see page 86.

■ Cutoff Freq (Cutoff Frequency)

Sets the Cutoff Frequency.

❑ **Settings:** 0 ~ 127

■ HPF Freq (High Pass Filter Cutoff Frequency)

Sets the High Pass Filter cutoff frequency.

Frequencies above the cutoff frequency are passed while those below are cut off. The larger the value, the higher the cutoff frequency becomes, resulting in a brighter sound. This high pass filter functions separately from the filter currently selected in Filter Type.

❑ **Settings:** 0 ~ 127

NOTE For general concepts about the High Pass Filter, see page 89.

■ Freq EG Depth (Frequency EG Depth)

Sets the depth of the change in the cutoff frequency over time. The larger the value, the greater the amount of change becomes. When set to a negative value, the shape of the envelope is reversed.

❑ **Settings:** -127 ~ 0 ~ +128

■ Freq K.Follow (Frequency Key Follow)

Sets the Key Follow for the cutoff frequency. This frequency Key Follow functions to adjust the cutoff frequency according to the note played on the keyboard. When set to a positive value, the higher the note played on the keyboard, the higher the cutoff frequency becomes. When a negative value is set, the lower the note played, the higher the cutoff frequency becomes.

❑ **Settings:** -32 ~ +63

■ Freq Vel Sens (Frequency Velocity Sensitivity)

Sets the velocity sensitivity for the FEG Depth. The timbre of the sound can be changed based on the amount of pressure applied to each key. The effect can be changed depending on the FEG settings.

❑ **Settings:** -64 ~ +63

[F8]: EG (Filter Envelope Generator)

Sets the FEG for the AN Element. You can control the change in the timbre of the sound over time, from when the key is played until it is released. This is effective for VCF 1/2 filters.

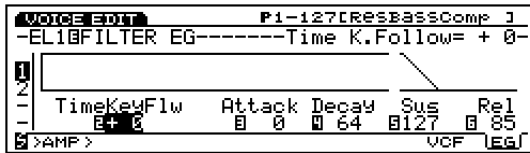

■ Time K.Follow (Time KeyFollow)

Sets the Time Key Follow for the AN Element. This Time Key Follow function adjusts the speed of the change in timbre over time according to the note played on the keyboard. The lower the note that is played on the keyboard, the slower the change in time becomes, whereas the higher the note played on the keyboard, the faster the change in time becomes. Negative values will produce the opposite effect.

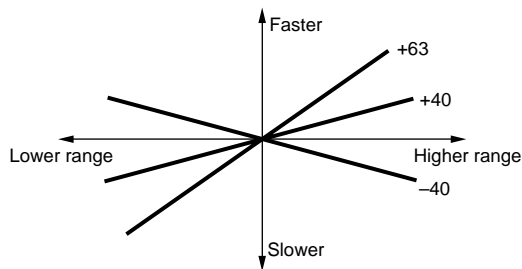

□ Settings: -64 ~ +63

■ Attack Time

Sets the amount of time from when the note is played to the maximum cutoff frequency level.

□ Settings: 0 ~ 127

■ Decay Time

Sets the amount of decay time from the maximum cutoff frequency level to the sustain level.

□ Settings: 0 ~ 127

■ Sustain Level

After passing through the Decay Time, this sets the sustain level which the cutoff frequency maintains as long as the key is held (key on).

□ Settings: 0 ~ 127

■ Release Time

Sets the amount of time it takes for the signal to reach the initial “0” value, after releasing the key.

□ Settings: 0 ~ 127

[F5]: AMP (Amplitude)

When an AN Element is selected, there are three types of menus available.

[F6]: PARAM (Parameters)

[F7]: MIX

[F8]: EG (Envelope Generator)

[F6]: PARAM (Parameters)

Available settings are the same as for the AWM Element (see page 96).

[F7]: MIX

Determines the settings related to the volume of VCO1 and VCO2. You can control the balance (mix) of the VCO1/2, Noise and the Ring Modulator signal levels.

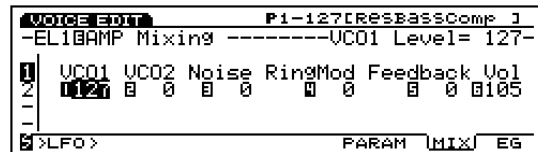

Block Diagram

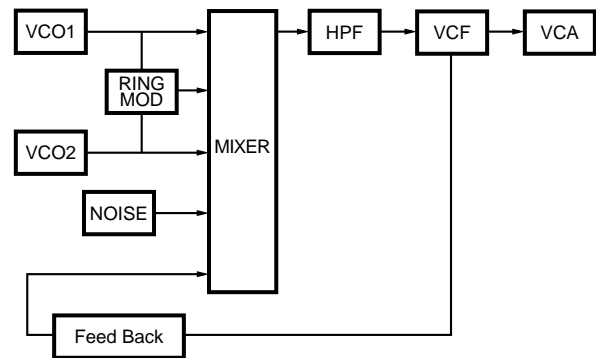

■ VCO1 Level

Sets the signal level of the wave sent from VCO1 to the mixer. When you do not want to apply the VCO1 signal, set the level to “0.”

□ Settings: 0 ~ 127

■ VCO2 Level

Sets the signal level of the wave sent from VCO2 to the mixer. When you do not want to apply the VCO2 signal, set the level to “0.”

□ **Settings:** 0 ~ 127

■ Noise Level

Sets the level of the signal sent from the Noise unit to the mixer. When you don’t want to apply the Noise signal, set the level to “0.”

□ **Settings:** 0 ~ 127

NOTE The Noise signal can be used to create unique special effect type sounds by applying various types of filters to the Noise signal, such as the VCF and the HPF.

■ Ring Mod Level (Ring Modulation Level)

Sets the level of the signal sent from the Ring Modulator to the mixer. When you don’t want to apply the Ring Modulator signal, set the level to “0.”

NOTE The Ring Modulator combines VCO1 and VCO2 waves and outputs a combination of all the frequency components of both. When a large value is set, you can make dissonant interval sounds with a clangorous, or metallic effect.

□ **Settings:** 0 ~ 127

■ Feedback Level

Sets the level of the feedback signal which is output from the AMP and “fed back” into the input of the mixer. Depending on the feedback amount, a fatter sound can be obtained.

□ **Settings:** 0 ~ 127

NOTE Feedback should be applied slowly and with caution. Too much feedback can create extremely high frequencies, potentially resulting in damage to your speakers.

■ Volume

Sets the output volume from the AMP. This determines the actual output volume of the AN Element wave. (The signal does pass into the effects procession after this point.)

□ **Settings:** 0 ~ 127

[F8]: EG (Amplitude Envelope Generator)

Sets the AEG for the AN Element. This lets you determine the change in volume over time, from when the key is played to when it is released.

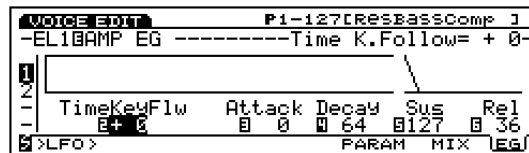

■ Time K.Follow (Time KeyFollow)

Sets the Time Key Follow for the AN Element. This Time Key Follow function adjusts the speed of the change in volume over time, according to the note played on the keyboard. The lower a note that is played on the keyboard, the slower the change in time becomes, whereas the higher the note that’s played on the keyboard, the faster the change in time becomes. Negative values will produce the opposite effect.

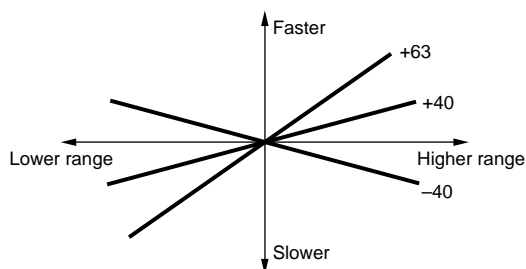

□ **Settings:** -64 ~ +63

■ Attack Time

Sets the amount of time from when the note is played to the maximum volume level.

□ **Settings:** 0 ~ 127

■ Decay Time

Sets the amount of decay time from the maximum volume level to the sustain level.

□ **Settings:** 0 ~ 127

■ Sustain Level

After passing through the Decay Time, this sets the sustain level which is maintained as long as the key is held (key on).

□ **Settings:** 0 ~ 127

Release Time

This sets the amount of time it takes for the signal to reach “0,” after releasing the key.

□ **Settings:** 0 ~ 127

[F6]: LFO (Low Frequency Oscillator)

When an AN Element is selected, there is one type of menu related to LFO settings available.

[F8]: LFO (Low Frequency Oscillator)

[F8]: LFO (Low Frequency Oscillator)

Sets the LFO for the AN Element. The LFO is an oscillator which generates low frequency signals out of hearing range that can apply modulation to specific aspects of the voice. Applying an LFO wave (shape of modulation) to the VCO (pitch), filter, or amplitude creates effects such as vibrato, waw, and tremolo, respectively. There are two LFOs (LFO1 and LFO2).

```

VOICE EDIT P1-127[RESBASSComp 1
-EL1BLFO -----LFO2 Wave= sine
LFO1: Delay= 0 Sync= off
Wave= sine Speed= 88 FMD= + 0
AMD= + 0
LFO2:
Wave= sine Speed= 32
>CTRL> LFO1
    
```

LFO1 Wave (Low Frequency Oscillator1 Wave)

Selects the LFO1 wave. Various kinds of modulated sounds (cyclical) can be created depending on the selected wave. There are 21 types of waves available.

□ **Settings:** sine, sine↑, sine↑↑, sine180↑, sine180↑↑, tri, tri↑, tri↑↑, tri180↑, tri180↑↑, squ, squ↑, squ180↑, saw dwn, saw dwn↑, saw up, saw up↑, s/h, s/h↑, s/h2, s/h2↑

NOTE VCO1/2, filter, and amplitude can be modulated simultaneously by the LFO1.

NOTE The settings related to modulation for VCO1/2 can be set in the OSC MOD screen (see page 116).

Listed below are the basic waveforms for each signal waveform.

Sine Wave

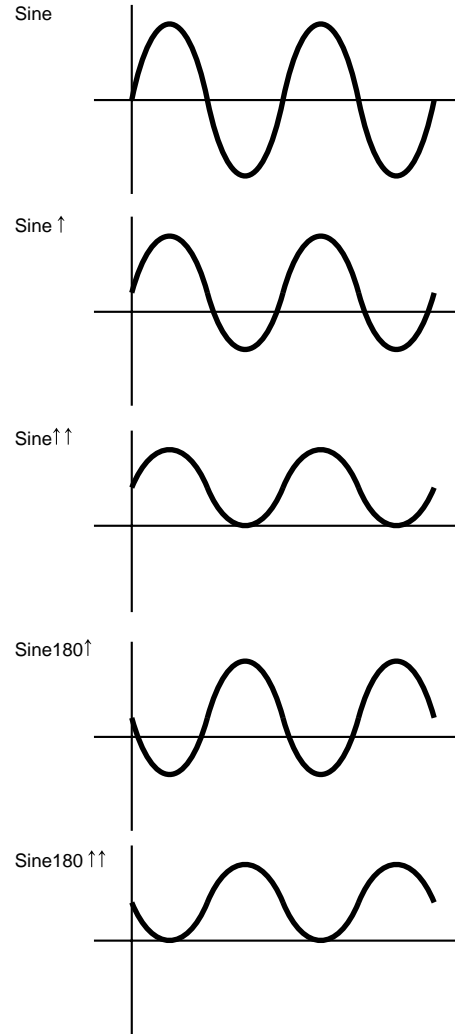

Tri (Triangle) Wave

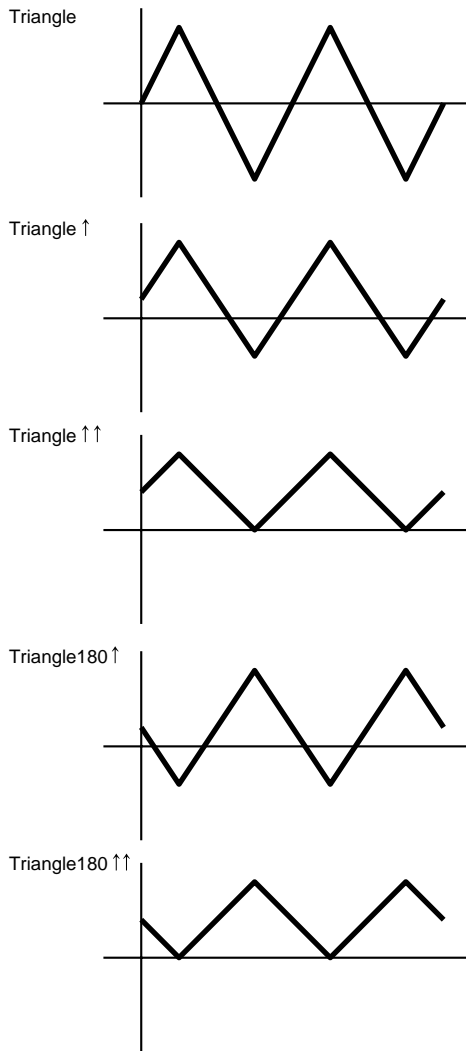

Squ (Square) Wave

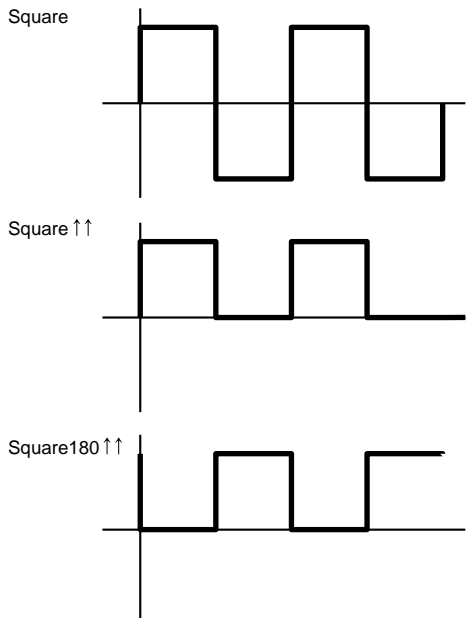

Saw (Sawtooth) Wave

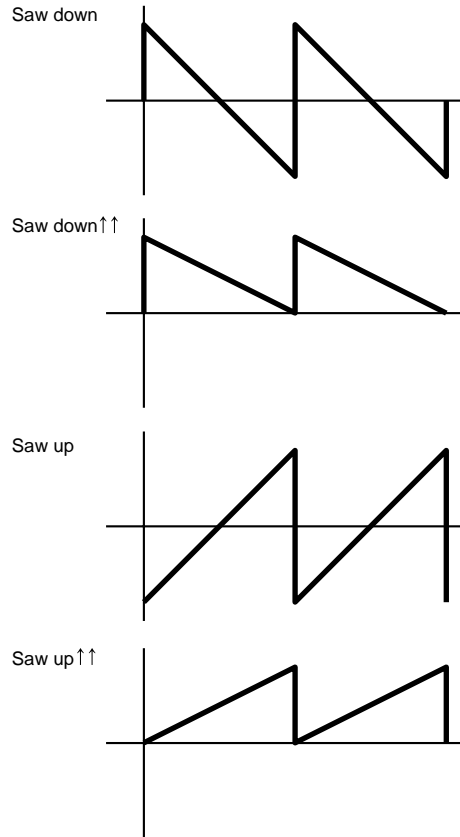

s/h (Sample & Hold) Wave

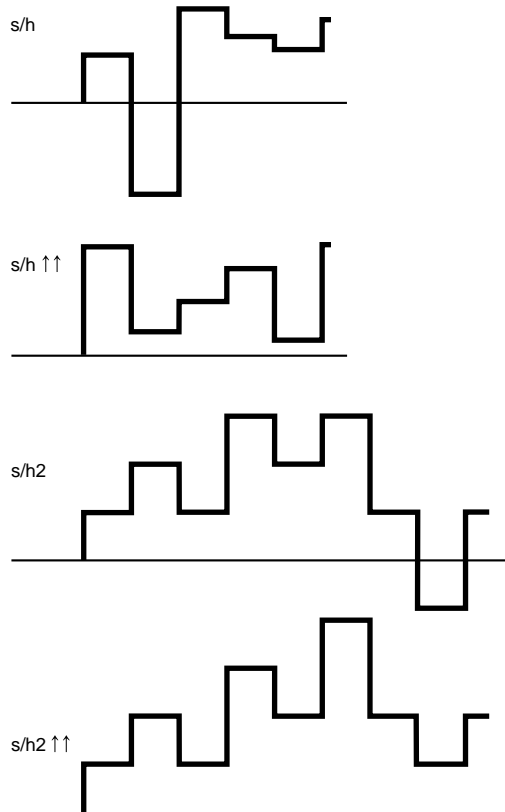

■ LFO1 Delay

Sets the delay of the time from when the keyboard is played to when the LFO modulation begins. The larger the value, the longer the delay time. For more information, see the Delay concept graph, page 100.

❑ **Settings:** 0 ~ 127

■ LFO1 Speed

Sets the speed of the LFO1 wave. The higher the value, the faster the speed. For more information, see the Speed concept graph, page 101.

❑ **Settings:** 0 ~ 255

■ LFO1 Sync

Determines whether the phase of the LFO1 wave is reset or not when the keyboard is played. As shown in the diagram below, when the keyboard is played, the phase of the LFO wave is reset. If you don't want the phase to be reset, select the "off" setting.

❑ **Settings:** on, off

NOTE For more information on resetting the phase, see page 103.

■ LFO1 FMD (LFO1 Frequency Modulation)

Determines how greatly the LFO1 will affect the filter cutoff frequency. The larger the value, the wider the degree of change in the cutoff frequency. When negative values are set, the phase of the LFO1 is reversed.

❑ **Settings:** -64 ~ 0 ~ +63

■ LFO1 AMD (LFO1 Amplitude Modulation)

Determines how greatly the LFO1 will affect the volume. The larger the value, the wider the degree of change in the volume. When negative values are set, the phase of the LFO1 is reversed.

❑ **Settings:** -64 ~ 0 ~ +63

■ LFO2 Wave (Low Frequency Oscillator 2 Wave)

Selects the waveform signal for LFO2. Using the wave selected here you can apply modulation to VCO 1/2 to create vibrato. There are two waveform signals available.

❑ **Settings:** sine, tri (triangle)

NOTE For more information about sine and tri (triangle), see page 121.

NOTE The settings related to modulation for VCO1/2 can be set in the OSC MOD screen (see page 116).

■ LFO2 Speed

Sets the speed of the LFO2 wave. The higher the value, the faster the speed. For more information, see the Speed concept graph, page 101.

❑ **Settings:** 0 ~ 255

[F7]: CTRL (Controller)

[F8]: SET (Controller Set)

"Velocity" is added to the Src (Source) parameter. You can control Dest (Destination) parameters by keyboard velocity. The available destination parameters are from No.79 through No.120. For more information, refer to the Controller List in the separate Data List book.

FDSP (Formulated Digital Sound Processing)

When FDSP or AN + FDSP (EX5/5R) is selected as the Voice Type from the PARAM menu (in COM), FDSP menu is added to the bottom of the screen as the [F5] function. Each of the four AWM elements for the FDSP voice type, and three AWM elements for the AN + FDSP voice type, utilize the FDSP unit in creating a voice.

NOTE The FDSP unit, through precision processing of each note data of the voices, has made it possible to add a new dimension to the voice creation that have never been realized by adding conventional effects before. For more information on the general concepts of FDSP, see page 34.

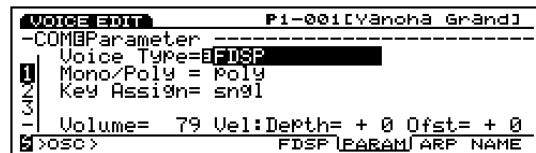

NOTE AN + FSDP voice type is not available with the EX7.

[F1]: COM (Common)

[F5]: FDSP

After selecting the FDSP Voice Type (or AN + FDSP), push [F5] and the FDSP sub menu will be displayed.

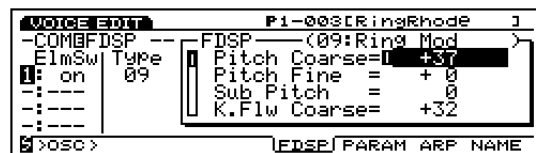

■ ElmSw (Element Switch)

This switch sets the FDSP unit for each AWM element as active, “on” or inactive, “off.”

- **Settings:** on or off for each element, 1 ~ 4 (for AN + FDSP voice type, element 2 ~ 4)

■ Type

Selects the FDSP type that will be used. Beginning with guitar pickup simulators, there are a variety of FDSP types that support new sound creation. The available parameters will differ depending on the selected FDSP type.

- **Settings:** 01: EP Pickup (Electric Piano Pickup)
 02: EG Pickup (Electric Guitar Pickup)
 03: Water
 04: PWM (Pulse Width Modulation)
 05: Flange
 06: Phaser
 07: Self FM
 08: Tornado
 09: Ring Mod (Ring Modulator)
 10: Seismic

NOTE The FDSP type selected here is equally applied to all the AWM elements that are set to “on.”

NOTE For more information on the parameters for each FDSP type, see the FDSP Parameter List in the separate Data List book.

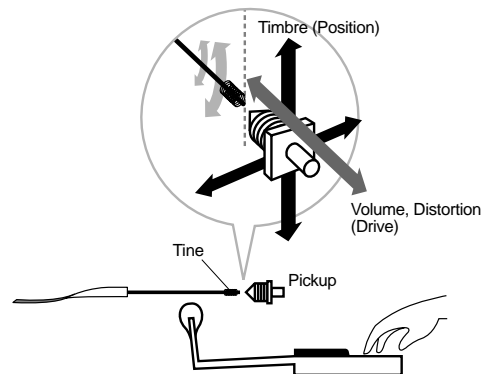

■ Pickup Type

Sets the type of pickup. There are three types, normal, integrate, and differentiate.

- **Settings:**

normal:
 Produces a slight simulation.

integrate:
 Produces a physically correct simulation; relationship between the tine vibration and the pickup magnetic flux.

different (differentiate):
 Produces a simulation that emphasizes the higher range.

■ Drive

Sets the amplitude size of the tine vibration, or the distance between the tine and pickup. The higher the value, the more the change in the timbre affected by the volume change of the input signal is emphasized.

- **Settings:** -64 ~ 0 ~ +63

■ Drive K.Flw(Drive KeyFollow)

Sets the Drive KeyFollow for a voice. The Drive KeyFollow function controls the change in the amount of Drive in accordance with the notes played on the keyboard. When set to a positive value, the higher the note played on the keyboard, the greater the change in the timbre becomes. When a negative value is set, the lower the note played, the greater the change in the timbre becomes.

- Settings:** -64 ~ 0 ~ +63

■ BP Low (Break Point Low)

Sets the Break Points, which affect the parameters Position and Out Level in accordance with the pitch change, in the note range below C3. Values can be set in semitones from C3, which is regarded as the value of 0.

- **Settings:** -48 (= C-1) ~ 0 (= C3)

Explanation for each FDSP type

01: EP Pickup (Electric Piano Pickup)

EP Pickup simulates the electromagnetic pickup of an electric piano. The mechanism how the EP Pickup type is formed is as follows: first, the signal sent to the FDSP unit is converted into the vibration of the tine of an electric piano. Next, the vibration is detected by the pickup opposite to the tine. Then the signal detected by the pickup is modified with the frequency characteristics unique to the electromagnetic pickup, and output. This system incorporates Yamaha’s Virtual Acoustic technology.

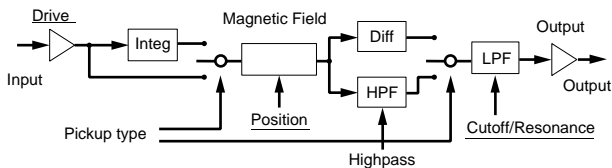

NOTE The underlined items in the diagram are available as the Destination parameters for the FDSP Controller set (page 141).

■ BP High (Break Point High)

Sets the Break Points, which affect the parameters Position and Out Level in accordance with the pitch change, in the note range above C3. Values can be set in semitones from C3, which is regarded as the value of 0.

□ **Settings:** 0 (= C3) ~ +48 (= C7)

■ Position

Sets the gap between the tine position and the center of the pickup to change the harmonics. The larger the value, the farther the gap position becomes from the center.

□ **Settings:** 0 ~ 127

■ Pos High Kf (Position High KeyFollow)

Offsets the gap position in the note range higher than the BP High (Break Point High). When set to a positive value, the higher the note played on the keyboard, the greater the gap position becomes. When a negative value is set, the higher the note played, the smaller the gap position becomes.

□ **Settings:** -64 ~ 0 ~ +63

■ Pos Hmid Kf (Position High Mid KeyFollow)

Offsets the gap position in the note range between C3 and the BP High (Break Point High).

□ **Settings:** -64 ~ 0 ~ +63

■ Pos Lmid Kf (Position Low Mid KeyFollow)

Offsets the gap position in the note range between C3 and the BP Low (Break Point Low). When set to a positive value, the lower the note played on the keyboard, the smaller the gap position becomes. When a negative value is set, the lower the note played, the greater the gap position becomes.

□ **Settings:** -64 ~ 0 ~ +63

■ Pos Low Kf (Position Low KeyFollow)

Offsets the gap position in the note range lower than the BP Low (Break Point Low).

□ **Settings:** -64 ~ 0 ~ +63

■ Out Level (Output Level)

Sets the pickup output level.

□ **Settings:** -64 ~ 0 ~ +63

■ Out High Kf (Out High KeyFollow)

Offsets the change in the pickup output level in the note range higher than the BP High (Break Point High). When set to a positive value, the higher the note played on the keyboard, the greater the change in the output level becomes. When a negative value is set, the lower the note played, the greater the change in the output level becomes.

□ **Settings:** -64 ~ 0 ~ +63

■ Out Hmid Kf (Out High Mid KeyFollow)

Offsets the change in the pickup output level in the note range between C3 and the BP High (Break Point High). When set to a positive value, the higher the note played on the keyboard, the greater the change in the output level becomes. When a negative value is set, the lower the note played, the greater the change in the output level becomes.

□ **Settings:** -64 ~ 0 ~ +63

■ Out Lmid Kf (Out Low Mid KeyFollow)

Offsets the change in the pickup output level in the note range between C3 and the BP Low (Break Point Low). When set to a positive value, the lower the note played on the keyboard, the smaller the change in the output level becomes. When a negative value is set, the lower the note played, the greater the change in the output level becomes.

□ **Settings:** -64 ~ 0 ~ +63

■ Out Low Kf (Out Low KeyFollow)

Offsets the change in the pickup output level in the note range lower than the BP Low (Break Point Low).

□ **Settings:** -64 ~ 0 ~ +63

■ HPF (High Pass Filter)

Sets the cutoff frequency which cuts the lower range of the pickup output signals. However, this setting is not available when the Pickup Type “differentiate” is selected.

□ **Settings:** 0 ~ 127

■ HPF K.Flw (High Pass Filter KeyFollow)

Sets the KeyFollow for the High Pass Filter cutoff frequency. The High Pass Filter KeyFollow function controls the change in the cutoff frequency by the notes played on the keyboard. When set to a positive value, the higher the note played on the keyboard, the higher the cutoff frequency becomes. When a negative value is set, the lower the note played, the higher the cutoff frequency becomes. When set to “+ 32,” the KeyFollow functions at 100 % and the cutoff frequency changes in proportion to the pitch.

□ **Settings:** -32 ~ 0 ~ + 64

■ Freq (Frequency)

Sets the low pass filter cutoff frequency which simulates the inductance (coil's electric capacity) characteristics of an electromagnetic pickup. (This filter cutoff frequency has no relation to that of the HPF above.)

□ **Settings:** 0 ~ 127

■ Freq K.Flw (Frequency KeyFollow)

Sets the KeyFollow for the Freq (frequency). The Frequency KeyFollow function controls the change in the cutoff frequency by the notes played on the keyboard. When set to a positive value, the higher the note played on the keyboard, the higher the cutoff frequency becomes. When a negative value is set, the lower the note played, the higher the cutoff frequency becomes. When set to “+ 32,” the KeyFollow functions at 100 % and the cutoff frequency changes in proportion to the pitch.

□ **Settings:** -32 ~ 0 ~ + 64

■ Resonance

Sets the resonance quality of an electromagnetic pickup. This setting determines the amount of resonance boost near the cutoff frequency set in Freq.

□ **Settings:** 0 ~ 31

■ Pan

Sets the panning for the selected FDSP type. This function determines the left or right positioning of each FDSP in the stereo spectrum.

□ **Settings:** L63 (far left) ~ cnt (center) ~ R63 (far right)

02: EG Pickup (Electric Guitar Pickup)

EG Pickup simulates the electromagnetic pickup of an electric guitar: tonal changes due to the picking position and the pickup position, and the characteristics of an electromagnetic pickup. The mechanism how the EG Pickup type is formed is as follows: first, the signal sent to the FDSP unit is converted into the string vibration. Next, the vibration is detected by the pickup. Then the signal detected by the pickup is modified with the frequency characteristics unique to the electromagnetic pickup, and output. This system incorporates Yamaha's Virtual Acoustic technology.

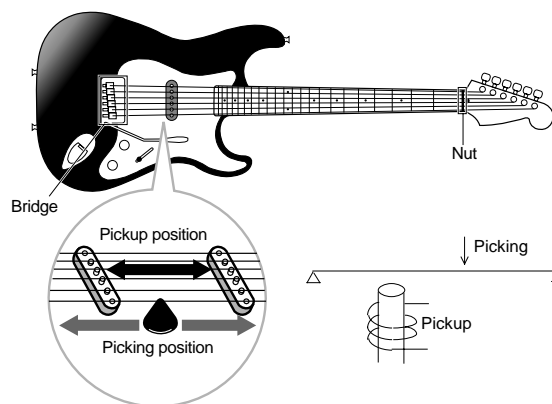
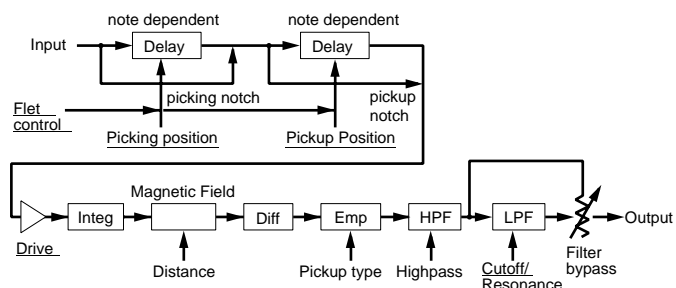

NOTE The underlined items in the diagram are available as the Destination parameters for the FDSP Controller set (page 141).

■ Pickup Type

Sets the type of pickup. There are two types, single (single coil), and humback.

□ Settings:

single:

Produces the projective sounds in the high register, one of the characteristics of a single coil pickup.

humback:

Produces the mellow and warm sounds unique to a humbacking pickup.

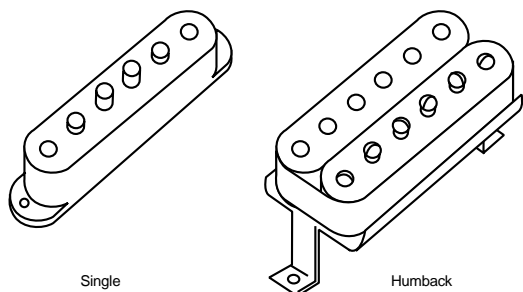

■ Coarse

Sets the basic pitch of the input signal in semitones. A setting of “0” produces a pitch of C3 = 261.63Hz.

□ Settings: -24 ~ 0 (C3) ~ +24

■ Picking Pos (Picking Position)

Sets the picking position. A setting of “0” puts the picking right on the bridge while “127” on the center of the strings.

□ Settings: 0 ~ 127

■ Picking P Kf (Picking Position KeyFollow)

Sets the KeyFollow for the Picking Position. The Picking Position KeyFollow function controls the timbre change that is determined by the picking position by the notes played on the keyboard. When set to a positive value, the higher the note played on the keyboard, the closer the picking position moves to the nut. When a negative value is set, the lower the note played, the closer the picking position moves to the nut.

□ Settings: -64 ~ 0 ~ +63

■ PickingNotch

Sets the picking position that provides tonal changes. When set to a positive value, physically correct effects are obtained at around the maximum value. When a negative value is set, physically impossible effects can be obtained. A setting of “0” produces no change in the timbre.

□ Settings: -32 ~ 0 ~ +32

NOTE When set to “0” here, the parameters “Picking Pos,” “Picking P Kf,” “Pickup Pos” and “Pickup P Kf” will be inactive.

■ Pickup Pos (Pickup Position)

Sets the pickup position. A setting of “0” puts the pickup right on the bridge while “127” on the center of the strings.

□ Settings: 0 ~ 127

■ Pickup P Kf (Pickup Position KeyFollow)

Sets the KeyFollow for the Pickup Position. The Pickup Position KeyFollow function controls the timbre change that is determined by the pickup position by the notes played on the keyboard. When set to a positive value, the higher the note played on the keyboard, the closer the pickup position moves to the nut. When a negative value is set, the lower the note played, the closer the pickup position moves to the nut.

□ Settings: -64 ~ 0 ~ +63

■ Pickup Notch

Sets the pickup position that provides tonal changes. When set to a positive value, physically correct effects are obtained at around the maximum value. When a negative value is set, physically impossible effects can be obtained. A setting of “0” produces no change in the timbre.

□ Settings: -32 ~ 0 ~ +32

■ Drive

Sets the amplitude size of the string vibration. The higher the value, the more the change in the timbre affected by the volume change of the input signal is emphasized.

□ Settings: -48 ~ 0 ~ +48

■ Distance

Sets the distance between the pickup and the strings. The smaller (closer) the value, the greater the output level becomes and the electromagnetic pickup’s distortion is emphasized.

□ Settings: 0 ~ 127

■ Output

Sets the pickup output level.

□ **Settings:** -48 ~ 0 ~ +48

■ Output KFlw (Output KeyFollow)

Sets the KeyFollow for the Output. The Output KeyFollow function controls the pickup output level in accordance with the notes played on the keyboard. When set to a positive value, the higher the note played on the keyboard, the greater the change in the output level becomes. When a negative value is set, the lower the note played, the greater the change in the output level becomes.

□ **Settings:** -32 ~ 0 ~ +32

■ HPF (High Pass Filter)

Sets the cutoff frequency which cuts the lower range of the pickup output signals.

□ **Settings:** 0 ~ 127

■ HPF K.Flw (High Pass Filter KeyFollow)

Sets the KeyFollow for the High Pass Filter cutoff frequency. The High Pass Filter KeyFollow function controls the change in the cutoff frequency by the notes played on the keyboard. When set to a positive value, the higher the note played on the keyboard, the higher the cutoff frequency becomes. When a negative value is set, the lower the note played, the higher the cutoff frequency becomes. When set to “+32,” the KeyFollow functions at 100% and the cutoff frequency changes in proportion to the pitch.

□ **Settings:** -32 ~ 0 ~ +64

■ Freq (Frequency)

Sets the low pass filter cutoff frequency which simulates the inductance (coil’s electric capacity) characteristics of an electromagnetic pickup. (This filter cutoff frequency has no relation to that of the HPF above.)

□ **Settings:** 0 ~ 127

■ Resonance

Sets the resonance quality of an electromagnetic pickup. This setting determines the amount of resonance boost near the cutoff frequency set in Freq.

□ **Settings:** 0 ~ 31

■ FilterBypass

Sets the amount (percentage) bypassing the Freq filter above.

□ **Settings:** 0 ~ 127 (= 100%)

■ Pan

The same as the one in the EP Pickup. See page 126 for information.

03: Water

The FDSP unit uses a unique algorithm to change the input signal to the sound of water, an application of the Virtual Analog synthesis. The feeling of running water is created by the Sample & Hold LFO filter modulation that is applied to the input signal. Also passing the signal through the resonating strings corresponding to each pitch gives the feeling of various pitches.

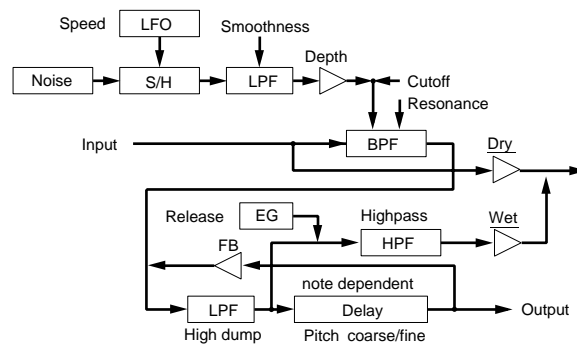

NOTE The underlined items in the diagram are available as the Destination parameters for the FDSP Controller set (page 141).

■ Pitch Coarse

Sets the basic pitch of the input signal in semitones. A setting of “0” produces a pitch of C3 = 261.63Hz.

□ **Settings:** -64 ~ 0 (C3) ~ +63

■ Pitch Fine

Finely adjusts the basic pitch of resonating strings.

□ **Settings:** -50 ~ 0 ~ +50

■ KeyFollow

Sets the KeyFollow for the pitch of resonating strings. This KeyFollow function controls the change in the pitch of the resonating strings in accordance with the notes played on the keyboard. When set to a positive value, the higher the note played on the keyboard, the higher the pitch of the resonating strings becomes. When a negative value is set, the lower the note played, the higher the pitch of the resonating strings becomes. When set to “+32,” the KeyFollow functions at 100% and the pitch of the resonating strings moves in proportion to the pitch played on the keyboard. When set to a value of “0” the pitch of the resonating strings is fixed.

□ **Settings:** -32 ~ 0 ~ +64

■ **Freq (Frequency)**

Sets the central frequency for the Sample & Hold LFO filter modulation.

□ **Settings:** 0 ~ 127

■ **Freq K.Flw(Frequency KeyFollow)**

Sets the KeyFollow for the filter modulation central frequency. This KeyFollow function controls the change of the central frequency in accordance with the notes played on the keyboard. When set to a positive value, the higher the note played on the keyboard, the higher the central frequency becomes. When a negative value is set, the lower the note played, the higher the central frequency becomes.

□ **Settings:** -15 ~ 0 ~ +15

■ **Resonance**

Sets the strength of the filter resonance. This setting determines the amount of resonance boost near the central frequency set in Freq.

□ **Settings:** 0 ~ 63

■ **Freq Mod (Frequency Modulation)**

Sets the depth of the filter modulation. The larger the value, the greater the degree of change in the central frequency. A setting of “0” produces no effect.

□ **Settings:** 0 ~ 63

■ **Mod Speed (Modulation Speed)**

Sets the speed of change for the Sample & Hold LFO filter modulation. The larger the value, the faster the change becomes. This let's you get a sound where the water appears to be moving rapidly.

□ **Settings:** 2 ~ 200

■ **Mod Smooth (Modulation Smooth)**

Sets the smoothness of the Sample & Hold LFO filter modulation. The larger the value, the greater the degree of the viscosity becomes.

□ **Settings:** 0 ~ 63

■ **Feedback**

Sets the strength of the resonance for the resonating strings. The larger the value, the more the pitch becomes articulate. However, if the value is increased too much, the atmosphere of water will disappear.

□ **Settings:** 0 ~ 63

■ **Feedback Kf (Feedback KeyFollow)**

Sets the KeyFollow for the Feedback. Feedback KeyFollow function controls the change in the resonance (for the resonating strings) in accordance with the notes played on the keyboard. When set to a positive value, the higher the note played on the keyboard, the greater the change in resonance becomes. When a negative value is set, the lower the note played, the greater the change in resonance becomes.

□ **Settings:** -15 ~ 0 ~ +15

■ **High Dump**

Sets the amount of decay in the higher frequencies for the resonating strings. The larger the value, the larger the higher frequency decay becomes. This setting corresponds to the the simulation that determines the material of the strings.

□ **Settings:** 0 ~ 15

■ **High Dump Kf (High Dump KeyFollow)**

Sets the KeyFollow for the amount of the higher frequency decay. This KeyFollow function controls the change in the amount of the higher frequency decay for the resonating strings in accordance with the notes played on the keyboard. When set to a positive value, the higher the note played on the keyboard, the greater the change becomes. When a negative value is set, the lower the note played, the greater the change becomes.

□ **Settings:** -15 ~ 0 ~ +15

■ **ReleaseTime**

Sets the release time (the time from note-off until the sound ends).

□ **Settings:** 0 ~ 48

■ **HPF (High Pass Filter)**

Sets the cutoff frequency which cuts the lower range of the water sound.

□ **Settings:** 0 ~ 127

■ **Wet Level**

Sets the output level for the water sound. You can adjust the FDSP (Water) balance by combining this parameter and the Dry Level below. A setting of “0” produces no output. Settings with the negative values reverse the phase of the waveform.

□ **Settings:** -64 ~ 0 ~ +63

■ Dry Level

Sets the output level for the original input signal. A setting of “0” produces no output. Settings with the negative values reverse the phase of the waveform.

□ **Settings:** -64 ~ 0 ~ +63

■ Pan

The same as the one in the EP Pickup. See page 126 for information.

04: PWM (Pulse Width Modulation)

PWM is a sort of chorus effect, similar to the pulse width modulation found on an analog synthesizer. Generally, a pulse (square) wave can be obtained by taking the difference between a phase shifted saw-tooth wave and the original wave, and by modulating the delayed phase of the resultant wave using LFO and/or EG. Utilizing this principle, the frequency characteristics similar to a comb (comb filter), the PWM type allows you to simulate the pulse width modulation of VCO. Chorus effects similar to the conventional pulse width modulation can be added, since this program decrease specific harmonics on any type of the input signal. The LFO can be set for each individual note or for all notes at one time, while EG can be set for each individual note.

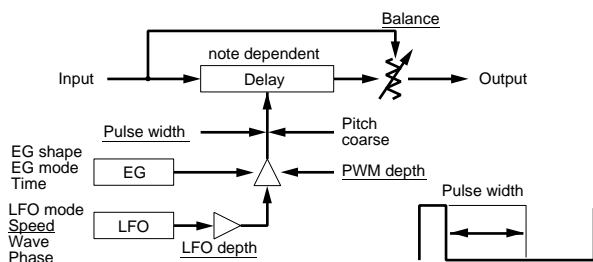

NOTE The underlined items in the diagram are available as the Destination parameters for the FDSP Controller set (page 141).

■ Pitch Coarse

Adjusts the length of the delay in semitones. A setting of “0” produces the delay length corresponding to the pitch of C3 = 261.63Hz. In general this should be adjusted to the basic pitch of the input signal.

□ **Settings:** -64 ~ 0 (C3) ~ +63

■ KeyFollow

Sets the KeyFollow for the delay length. This KeyFollow function controls the length of the delay in accordance with the notes played on the keyboard. When set to “+32,” the KeyFollow functions at 100% and the length of the delay moves in inverse proportion to the pitch played on the keyboard. When set to a value of “0” the length of the delay is fixed. To prevent the effect from being irregular, the value should be set at “+32” normally.

□ **Settings:** -32 ~ 0 ~ +64

NOTE When obtaining the pulse width modulation, set this value to “+32.”

■ Pulse Width

Adjusts the width of the pulse wave. When the Pulse Width is set to a value of “64,” the pulse wave is equally balanced, generating only odd-numbered harmonics. When the value is increased or decreased from “64,” the pulse width will be narrower, producing the sound with more harmonics (page 116).

□ **Settings:** 0 ~ 64 ~ 127(0% ~ 50% ~ 99%)

■ PWM Depth (Pulse Width Modulation Depth)

Sets the depth of the pulse width modulated by the LFO and EG.

□ **Settings:** -64 ~ 0 ~ +63

■ PWM DepthVel (Pulse Width Modulation Depth Velocity)

Sets the velocity sensitivity for the PWM depth. The PWM Depth can be controlled by the velocity at which the note played on the keyboard.

□ **Settings:** -64 ~ 0 ~ +63

■ LFO Mode (Low Frequency Oscillator Mode)

Sets the LFO mode (the way in which the LFO functions). There are three types of modes.

□ **Settings:**

common:

The LFO functions the same for all notes. In general this mode should be selected for the pulse width modulation.

key reset:

The LFO functions for each individual note. Each time a note is played, the phase of the LFO wave will be reset.

random:

The LFO functions for each individual note. Each time a note is played, the phase of the LFO wave will change randomly.

■ LFO Depth (Low Frequency Oscillator Depth)

Sets the depth of the LFO wave for the pulse width modulation. When set to “0,” only the EG functions. When set to “32,” the LFO wave ranges from “0” to the extent of the EG amplitude. When set to “64,” the absolute values of LFO wave range between the positive and negative extents of the EG amplitude.

□ **Settings:** 0 ~ 64

■ LFO Speed (Low Frequency Oscillator Speed)

Sets the frequency of the LFO wave. The higher the value, the faster the speed.

□ **Settings:** 1 ~ 255

■ LFO Wave (Low Frequency Oscillator Wave)

Selects the LFO wave type. The wave selected here determines the characteristics of the modulation and can produce a variety of ways that the sound will be modulated.

□ **Settings:** triangle (Triangle Wave), sin (Sine Wave)

NOTE For more information on each LFO wave, see page 121.

■ LFO Phase (Low Frequency Oscillator Phase)

Sets the phase of the LFO wave that is reset when the note is played.

□ **Settings:** 0, 90, 180, 270 (degrees).

■ EG Mode (Envelope Generator Mode)

Sets the EG mode (the way in which the EG functions). There are three types of modes.

□ **Settings:**

decay: The EG effect decays.

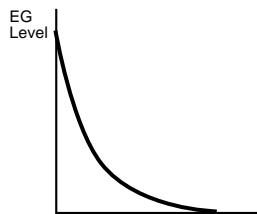

attack: The EG effect increases.

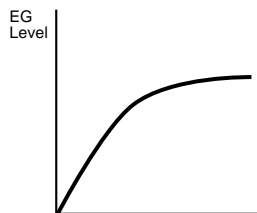

fade in: The EG effect increases gradually after a delay.

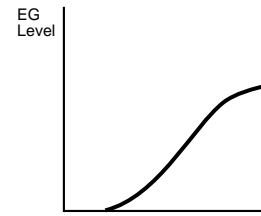

■ EG Shape (Envelope Generator Shape)

Sets the shape (depth) of the envelope. When set to “0,” no envelope exist (holds at a maximum value). When set to “32,” the depth is 50 %, and at “64,” the depth is 100 %. If the “fade in” type is selected in EG Mode, at a value above “32,” the delay works.

□ **Settings:** 0 ~ 64

EG Mode: decay

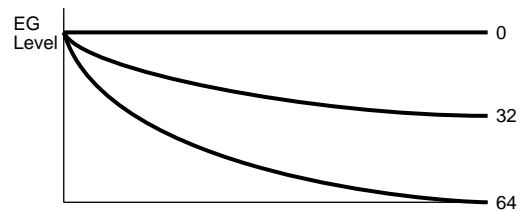

EG Mode: attack

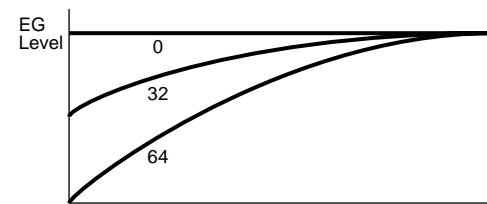

EG Mode: fade in

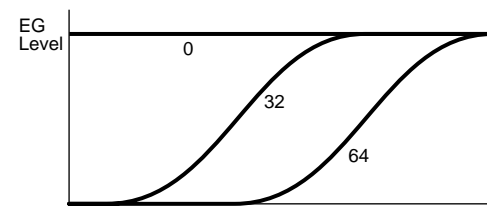

■ EG Time (Envelope Generator Time)

Sets the amount of time from when the note is played to when the EG terminates.

□ **Settings:** 0 ~ 127

■ EG Time Kflw (Envelope Generator Time KeyFollow)

Sets the KeyFollow for the EG Time. This KeyFollow function controls the amount of the EG time in accordance with the notes played on the keyboard. When set to a positive value, the higher the note played on the keyboard, the shorter the EG time becomes. When a negative value is set, the lower the note played, the shorter the EG time becomes.

□ **Settings:** $-64 \sim 0 \sim +63$

■ Balance

Sets the mix balance for the original input signal and the delayed signal. A setting of “0” means that only the original input signal is produced. When set to a positive value, the difference between the input signal and the delayed signal is produced and the usual pulse width modulation effect will be obtained at the value of “+32.” When a negative value is set, the input signal and the delay signal are added and a chorus effect is obtained at the value of “-32.”

□ **Settings:** $-32 \sim 0 \sim +32$

■ Pan

The same as the one in the EP Pickup. See page 126 for information.

05: Flange

Flange lets you get the flanging effect for each note. The original input signals and the delayed signals are mixed together to produce dips and their feedbacks produce peaks, to create a unique comb filter, accordingly. The frequencies of the dips and peaks can be changed by modulating the delay length using LFO and/or EG. The LFO is set for all notes at one time while the EG can be set for each individual note.

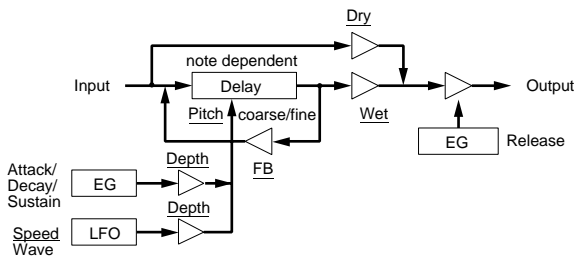

NOTE The underlined items in the diagram are available as the Destination parameters for the FDSP Controller set (page 141).

■ Pitch Coarse

Adjusts the length of the delay in semitones. A setting of “0” produces the delay length corresponding to the pitch of C3 = 261.63Hz. In general this should be adjusted to the basic pitch of the input signal.

□ **Settings:** $-64 \sim 0 (C3) \sim +63$

■ Pitch Fine

Adjusts the length of the delay in increments of cents.

□ **Settings:** $-50 \sim 0 \sim +50$

■ KeyFollow

Sets the KeyFollow for the delay length. This KeyFollow function controls the length of the delay in accordance with the notes played on the keyboard. When set to “+32,” the KeyFollow functions at 100% and the length of the delay moves in inverse proportion to the pitch played on the keyboard. When set to a value of “0” the length of the delay is fixed.

□ **Settings:** $-32 \sim 0 \sim +64$

■ EG Depth (Envelope Generator Depth)

Sets the EG depth that affects the delay length.

□ **Settings:** $-64 \sim 0 \sim +63$

■ EG Depth Vel (Envelope Generator Depth Velocity)

Sets the velocity sensitivity for the EG depth. The EG depth can be controlled by the velocity at which the note played on the keyboard.

□ **Settings:** $-64 \sim 0 \sim +63$

■ Attack Time

Sets the amount of time from when the note is played to the maximum level.

□ **Settings:** $0 \sim 127$

■ Attack T.Kf (Attack Time KeyFollow)

Sets the KeyFollow for the Attack Time. This KeyFollow function controls the attack time in accordance with the notes played on the keyboard. When set to a positive value, the higher the note played on the keyboard, the shorter the attack time becomes. When a negative value is set, the lower the note played, the shorter the attack time becomes.

□ **Settings:** $-64 \sim 0 \sim +63$

■ Decay Time

Sets the EG decay time (the time of decay from the maximum level until reaching the sustain level).

□ **Settings:** 0 ~ 127

■ Decay T.Kf (Decay Time KeyFollow)

Sets the KeyFollow for the Decay Time. This KeyFollow function controls the decay time in accordance with the notes played on the keyboard. When set to a positive value, the higher the note played on the keyboard, the shorter the decay time becomes. When a negative value is set, the lower the note played, the shorter the decay time becomes.

□ **Settings:** -64 ~ 0 ~ +63

■ Sustain Lvl (Sustain Level)

Sets the EG sustain level (the level to be reached from when the note is played, still the note is held).

□ **Settings:** 0 ~ 127

■ ReleaseTime

Sets the EG release time (the time from key-off until the sound ends).

□ **Settings:** 0 ~ 48

■ LFO Depth (Low Frequency Oscillator Depth)

Sets the depth of the LFO wave.

□ **Settings:** 0 ~ 127

■ LFO Speed (Low Frequency Oscillator Speed)

Sets the frequency of the LFO wave. The higher the value, the faster the speed.

□ **Settings:** 1 ~ 255

■ Feedback

Sets the amount of flanger feedback. The larger the value, the more the frequency peaks are emphasized, resulting in pronounced sounds.

□ **Settings:** -64 ~ 0 ~ +63

■ Feedback Vel(Feedback Velocity)

Sets the velocity sensitivity for the amount of feedback. The amount of feedback can be controlled by the velocity at which the note played on the keyboard.

□ **Settings:** -64 ~ 0 ~ +63

■ Wet Level

Sets the output level for the signal that is affected by the flanger. You can adjust the FDSP (Flange) balance by combining this parameter and the Dry Level below.

□ **Settings:** -64 ~ 0 ~ +63

■ Dry Level

Sets the output level for the original input signal.

□ **Settings:** -64 ~ 0 ~ +63

■ Pan

The same as the one in the EP Pickup. See page 126 for information.

06: Phaser

Phaser lets you get phasing effect for each note. The original input signals and the shifted phase signals obtained by passing an all pass filter are mixed together to produce dips and their feedbacks of the repeated delay produce peaks. The frequencies of the dips and peaks can be changed by modulating the factor of the all pass filter using LFO and/or EG. This allows you to get special effects by synchronizing the phase-shift to the pitch frequencies correctly. The LFO is set for all notes at one time while the EG can be set for each individual note.

NOTE An all pass filter is one type of filter that changes the characteristics of phases. It is possible to invert the phase at the border of a specific frequency.

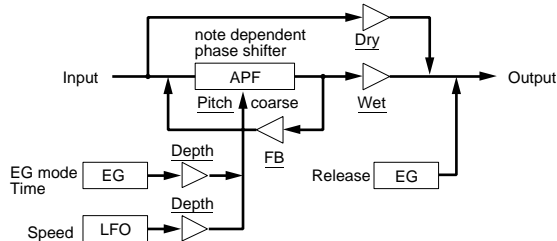

NOTE The underlined items in the diagram are available as the Destination parameters for the FDSP Controller set (page 141).

■ Pitch Coarse

Adjusts the peak frequency in semitones. A setting of "0" produces the frequency corresponding to the pitch of C3 = 261.63Hz.

□ **Settings:** -64 ~ 0 (C3) ~ +63

■ KeyFollow

Sets the KeyFollow for the peak frequency change. This KeyFollow function controls the first peak frequency in accordance with the notes played on the keyboard. When set to “+ 32,” the KeyFollow functions at 100% and the peak frequency moves in proportion to the pitch played on the keyboard. When set to a value of “0” the peak frequency is fixed.

□ **Settings:** -32 ~ 0 ~ + 64

■ EG Depth (Envelope Generator Depth)

Sets the EG depth that affects the peak frequency.

□ **Settings:** -64 ~ 0 ~ + 63

■ EG Depth Vel (Envelope Generator Depth Velocity)

Sets the velocity sensitivity for the EG depth. The EG depth can be controlled by the velocity at which the note played on the keyboard.

□ **Settings:** -64 ~ 0 ~ + 63

■ EG Mode(Envelope Generator Mode)

Sets the EG mode (the way in which the EG functions). There are two types of modes.

□ **Settings:**

decay: The EG effect decays.

attack: The EG effect increases.

■ EG Time (Envelope Generator Time)

Sets the amount of time from when the note is played to when the EG terminates.

□ **Settings:** 0 ~ 127

■ EG Time Kflw (Envelope Generator Time KeyFollow)

Sets the KeyFollow for the EG Time. This KeyFollow function controls the amount of the EG time in accordance with the notes played on the keyboard. When set to a positive value, the higher the note played on the keyboard, the shorter the EG time becomes. When a negative value is set, the lower the note played, the shorter the EG time becomes.

□ **Settings:** -64 ~ 0 ~ + 63

■ ReleaseTime

Sets the EG release time (the time from key-off until the sound ends).

□ **Settings:** 0 ~ 48

■ LFO Depth (Low Frequency Oscillator Depth)

Sets the depth of the LFO wave.

□ **Settings:** 0 ~ 127

■ LFO Speed (Low Frequency Oscillator Speed)

Sets the frequency of the LFO wave. The higher the value, the faster the speed.

□ **Settings:** 1 ~ 255

■ Feedback

Sets the amount of phaser feedback. The larger the value, the more the frequency peaks are emphasized, resulting in pronounced sounds.

□ **Settings:** -64 ~ 0 ~ + 63

■ Feedback Vel (Feedback Velocity)

Sets the velocity sensitivity for the amount of feedback. The amount of feedback can be controlled by the velocity at which the note played on the keyboard.

□ **Settings:** -64 ~ 0 ~ + 63

■ Wet Level

Sets the output level for the signal that is affected by the phaser. You can adjust the FDSP (Phaser) balance by combining this parameter and the Dry Level below.

□ **Settings:** -64 ~ 0 ~ + 63

■ Dry Level

Sets the output level for the original input signal.

□ **Settings:** -64 ~ 0 ~ + 63

■ Pan

The same as the one in the EP Pickup. See page 126 for information.

07: Self FM

Self FM lets you add extra richer harmonics to the sounds. The mechanism how the Self FM type is formed is as follows: first, input signals are sent to the delay unit. Next, the phases of each signal sent from the delay unit are modulated (phase/frequency) by the input signals themselves, to cause the waves distorted. Consequently, extra harmonics are obtained.

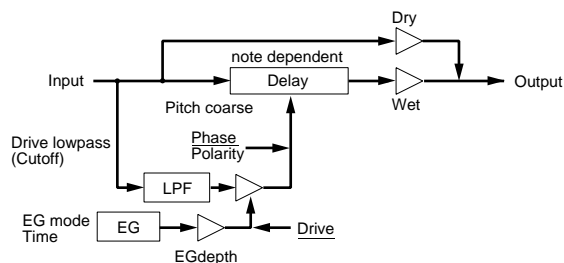

NOTE The underlined items in the diagram are available as the Destination parameters for the FDSP Controller set (page 141).

■ Pitch Coarse

Adjusts the length of the delay in semitones. A setting of “0” produces the delay length corresponding to the pitch of C3 = 261.63Hz. Decreasing the value increases the depth of the modulation. If the input signal’s basic pitch is lowered an octave (-12), the length of the delay will be twice as long. A setting of (-24) will lower the pitch two octaves, and the length of the delay will be four times as long.

□ **Settings:** -64 ~ 0 (C3) ~ +63

■ KeyFollow

Sets the KeyFollow for the delay length. This KeyFollow function controls the length of the delay in accordance with the notes played on the keyboard. When set to “+32,” the KeyFollow functions at 100% and the length of the delay moves in inverse proportion to the pitch played on the keyboard. When set to a value of “0” the length of the delay is fixed. To prevent the effect from being irregular, the value should be set at “+32” normally.

□ **Settings:** -32 ~ 0 ~ +64

■ Polarity

Sets the direction of the modulation of the input signal. There are two settings, positive (0) and negative (1).

□ **Settings:**

0 (positive): The delay increases as the input signal increases.

1 (negative): The delay decreases as the input signal increases.

■ Phase

Sets the center position of the phase of the input signal for modulation. Timbre will change depending on the designated position.

□ **Settings:** 0 ~ 127

■ Drive

Sets the depth of the modulation.

□ **Settings:** 0 ~ 127

■ Drive K.Flw (Drive KeyFollow)

Sets the KeyFollow for the Drive. The Drive KeyFollow function controls the depth of the modulation in accordance with the notes played on the keyboard. When set to a positive value, the higher the note played on the keyboard, the deeper the modulation becomes. When a negative value is set, the lower the note played, the deeper the modulation becomes.

□ **Settings:** -64 ~ 0 ~ +63

■ Drive EG (Drive EG Depth)

Sets the EG depth to affect the depth of the modulation.

□ **Settings:** -64 ~ 0 ~ +63

■ Drive EG Vel (Drive Envelope Generator Velocity)

Sets the velocity sensitivity for the Drive EG. The EG depth can be controlled by the velocity at which the note played on the keyboard.

□ **Settings:** -64 ~ 0 ~ +63

■ LPF (Low Pass Filter)

Sets the cutoff frequency which cuts the higher range of the input signals for modulation.

□ **Settings:** 0 ~ 127

■ LPF K.Flw (Low Pass Filter KeyFollow)

Sets the KeyFollow for the Low Pass Filter cutoff frequency. The Low Pass Filter KeyFollow function controls the cutoff frequency in accordance with the notes played on the keyboard. When set to a positive value, the higher the note played on the keyboard, the higher the cutoff frequency becomes. When a negative value is set, the lower the note played, the higher the cutoff frequency becomes. When set to “+32,” the KeyFollow functions at 100% and the cutoff frequency changes in proportion to the pitch.

□ **Settings:** -32 ~ 0 ~ +64

■ EG Mode (Envelope Generator Mode)

Sets the EG mode (the way in which the EG functions). There are two types of modes.

□ **Settings:**

decay: The EG effect decays.

attack: The EG effect increases.

■ EG Time (Envelope Generator Time)

Sets the amount of time from when the note is played to when the EG terminates.

□ **Settings:** 0 ~ 127

■ EG Time Kflw(Envelope Generator Time KeyFollow)

Sets the KeyFollow EG time. This KeyFollow function controls the change in the length of the EG time in accordance with the notes played on the keyboard. When set to a positive value, the higher the note played on the keyboard, the shorter the EG time becomes. When a negative value is set, the lower the note played, the shorter the EG time becomes.

□ **Settings:** -64 ~ 0 ~ +63

■ Wet Level

Sets the output level for the signal that is affected by the Self FM. You can adjust the FDSP (Self FM) balance by combining this parameter and the Dry Level below.

□ **Settings:** -64 ~ 0 ~ +63

■ Wet Vel (Wet Level Velocity)

Sets the velocity sensitivity for the Wet Level. This lets you control the output level of the modulated signal by the strength at which you play the keyboard.

□ **Settings:** -64 ~ 0 ~ +63

■ Dry Level

Sets the output level for the original input signal.

□ **Settings:** -64 ~ 0 ~ +63

■ Dry Vel (Dry Level Velocity)

Sets the velocity sensitivity for the Dry Level. This lets you control the output level of the original input signal by the strength at which you play the keyboard.

□ **Settings:** -64 ~ 0 ~ +63

■ Pan

The same as the one in the EP Pickup. See page 126 for information.

08: Tornado

Tornado is a kind of FM synthesis operator with the carrier frequency “0,” using input signal as a modulator. The input signal is modified by the LPF and the special limiter, to form an appropriate modulator waveform, and the modulator waveform looks up the sine wave. The greater the modulation intensity, the greater the change of the phase to be looked up becomes, to emphasize the higher frequency range. As the modulation intensity decreases so does the harmonic content. The feedback for the FM (“Edge Bias” parameter, below) is available to get sounds with both true sine wave and rich harmonic contents of the saw-tooth wave.

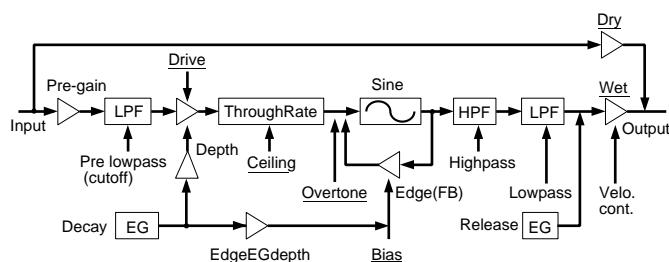

NOTE The underlined items in the diagram are available as the Destination parameters for the FDSP Controller set (page 141).

■ Pre Gain

Sets the gain for amplifying the input signal that is used for modulation.

□ **Settings:** 0 ~ 120

■ Pre LPF (Low Pass Filter)

Sets the cutoff frequency which cuts the higher range of the input signals for modulation.

□ **Settings:** 0 ~ 127

■ Drive

Sets the depth of the modulation.

□ **Settings:** 0 ~ 127

■ Drive K.Flw (Drive KeyFollow)

Sets the KeyFollow for the Drive. The Drive KeyFollow function controls the depth of the modulation in accordance with the notes played on the keyboard. When set to a positive value, the higher the note played on the keyboard, the deeper the modulation becomes. When a negative value is set, the lower the note played, the deeper the modulation becomes.

□ **Settings:** -64 ~ 0 ~ +63

■ EG Depth (Envelope Generator Depth)

Sets the EG depth to affect the depth of the modulation.

□ **Settings:** -64 ~ 0 ~ +63

■ EG Depth Vel (Envelope Generator Depth Velocity)

Sets the velocity sensitivity for the EG Depth. The EG depth can be controlled by the velocity at which the note played on the keyboard.

□ **Settings:** -64 ~ 0 ~ +63

■ Decay Time

Sets the EG decay time (the time of decay from the maximum level until reaching the sustain level).

□ **Settings:** 0 ~ 127

■ ReleaseTime

Sets the EG release time (the time from key-off until the sound ends).

□ **Settings:** 0 ~ 48

■ Overtone

Overtone controls the harmonic content. The higher the value, the more the even-numbered harmonic overtones increase.

□ **Settings:** 0 ~ 64

■ Ceiling

Sets the frequency upper limit for the harmonic overtones that are emphasized.

□ **Settings:** 0 ~ 127

■ Edge Bias

Determines the amount of FM feedback. The higher the value, the wider the harmonic range becomes to include the harmonics in the higher range. The value set here will be added to the amount of feedback that is controlled by the EG.

□ **Settings:** -64 ~ 0 ~ +63

■ Edge EGDepth (Edge Envelope Generator Depth)

Sets the EG depth for the FM feedback.

□ **Settings:** -64 ~ 0 ~ +63

■ HPF (High Pass Filter)

Sets the cutoff frequency which cuts the lower range of the modulated signals.

□ **Settings:** 0 ~ 127

■ HPF K.Flw (High Pass Filter KeyFollow)

Sets the KeyFollow for the High Pass Filter cutoff frequency. The High Pass Filter KeyFollow function controls the cutoff frequency in accordance with the notes played on the keyboard. When set to a positive value, the higher the note played on the keyboard, the higher the cutoff frequency becomes. When a negative value is set, the lower the note played, the higher the cutoff frequency becomes. When set to “+32,” the KeyFollow functions at 100% and the cutoff frequency changes in proportion to the pitch.

□ **Settings:** -32 ~ 0 ~ +64

■ LPF (Low Pass Filter)

Sets the cutoff frequency which cuts the higher range of the modulated signals.

□ **Settings:** 0 ~ 127

■ LPF K.Flw (Low Pass Filter KeyFollow)

Sets the KeyFollow for the Low Pass Filter cutoff frequency. The Low Pass Filter KeyFollow function controls the change in the cutoff frequency in accordance with the notes played on the keyboard. When set to a positive value, the higher the note played on the keyboard, the higher the cutoff frequency becomes. When a negative value is set, the lower the note played, the higher the cutoff frequency becomes. When set to “+32,” the KeyFollow functions at 100% and the cutoff frequency changes in proportion to the pitch.

□ **Settings:** -32 ~ 0 ~ +64

Wet Gain

Sets the maximum output level for the modulated signal.

Settings: 0 ~ 127

Wet Vel (Wet Level Velocity)

Sets the velocity sensitivity for the Wet Level. This lets you control the output level of the modulated signal by the strength at which you play the keyboard.

Settings: -64 ~ 0 ~ +63

Wet Level

Sets the output level for the signal that is affected by the Tornado. You can adjust the FDSP (Tornado) balance by combining this parameter and the Dry Level below.

Settings: 0 ~ 127

Dry Level

Sets the output level for the original input signal.

Settings: 0 ~ 127

Pan

The same as the one in the EP Pickup. See page 126 for information.

09: Ring Mod (Ring Modulator)

Ring Mod modulates the original input signal (as carrier) using the modulators of the amplitude modulation (AM). When set to a maximum (200%) of modulation depth, being equivalent to a conventional “ring modulator,” two frequency components are generated: the one as a sum frequency of the carrier and modulator signals, and the other as a difference of them. As the modulation depth is decreased, the intensity of the carrier frequency components is more dominant in output. When set to 0%, only the original input signal is output. Even though this program uses a sine wave as the modulation wave, the Ring Mod provides with more complicated harmonics because two AM modulators (main and sub) can be used.

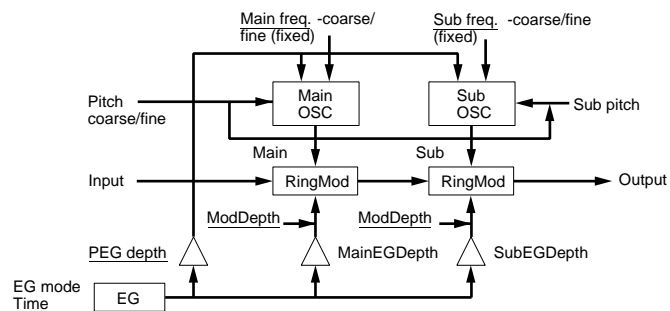

NOTE The underlined items in the diagram are available as the Destination parameters for the FDSP Controller set (page 141).

Pitch Coarse

Sets the pitch of the main modulator’s wave in semitones. A setting of “0” produces a pitch of C3 = 261.63Hz.

Settings: -64 ~ 0 (C3) ~ +63

Pitch Fine

Adjusts the pitch of the main modulator’s wave.

Settings: -50 ~ 0 ~ +50

Sub Pitch

Sets the pitch of the sub modulator’s wave in ca. semitones, at a ratio to the main modulator’s wave pitch. A setting of “0” produces a frequency of “0,” while when set to “127,” the pitch of the sub modulator wave becomes equal to the one of the main modulator’s wave pitch.

Settings: 0 ~ 127

K.Flw Coarse (KeyFollow Coarse)

Sets the KeyFollow for the Pitch Coarse. The KeyFollow Coarse function controls the pitch of the modulation wave form in accordance with the notes played on the keyboard. When set to “+32,” the KeyFollow functions at 100% and the change in the pitch of the modulation wave moves in proportion to the pitch played on the keyboard. When set to a value of “0” the pitch of the modulation wave is fixed.

Settings: -32 ~ 0 ~ +64

K.Flw Fine (KeyFollow Fine)

Sets the KeyFollow for the Pitch Fine to finely adjust the KeyFollow Coarse function.

Settings: -64 ~ 0 ~ +63

■ PEG Depth (Pitch Envelope Generator Depth)

Sets the PEG depth that affects the modulation wave's pitch.

□ **Settings:** -64 ~ 0 ~ +63

■ PEG DepthVel (Pitch Envelope Generator Depth Velocity)

Sets the velocity sensitivity for the PEG depth. The PEG depth can be controlled by the velocity at which the note played on the keyboard.

□ **Settings:** -64 ~ 0 ~ +63

■ M.FreqCoarse (Main Frequency Coarse)

Sets the offset value for the main modulation wave's frequency. The value set here is added or subtracted to or from the frequency set in the Pitch Coarse.

□ **Settings:** -64 ~ 0 ~ +63

NOTE A negative value will also raise the frequency, though, the value will be offset if a positive value is set for the other parameter.

■ M.FreqFine (Main Frequency Fine)

Finely adjusts the offset value set in the M.FreqCoarse above.

□ **Settings:** -64 ~ 0 ~ +63

■ S.FreqCoarse (Sub Frequency Coarse)

Sets the offset value for the sub modulation wave's frequency. The value set here is added or subtracted to or from the frequency set in the Sub Pitch.

□ **Settings:** -64 ~ 0 ~ +63

■ S.FreqFine (Sub Frequency Fine)

Finely adjusts the offset value set in the S.FreqCoarse above.

□ **Settings:** -64 ~ 0 ~ +63

NOTE When the above four parameters, Main/Sub Frequency Coarse/Fine, are set to 0, the modulation frequency is determined only by KeyFollow. In this case, setting the KeyFollow Coarse to +32 will be equivalent to the result, which the operator is set to ratio in the FM synthesis.

■ EG Mode (Envelope Generator Mode)

Sets the EG mode (the way in which the EG functions). There are two types of modes.

□ **Settings:**

decay: The EG effect decays.

attack: The EG effect increases.

■ EG Time (Envelope Generator Time)

Sets the amount of time from when the note is played to when the EG terminates.

□ **Settings:** 0 ~ 127

■ EG Time Kflw (Envelope Generator Time KeyFollow)

Sets the KeyFollow for the EG Time. This KeyFollow function controls the amount of the EG time in accordance with the notes played on the keyboard. When set to a positive value, the higher the note played on the keyboard, the shorter the EG time becomes. When a negative value is set, the lower the note played, the shorter the EG time becomes.

□ **Settings:** -64 ~ 0 ~ +63

■ M.Mod Depth (Main Modulation Depth)

Sets the modulation depth of the main modulator.

□ **Settings:** -64 ~ 0 ~ +63

■ M.Mod EG (Main Modulation Envelop Generator Depth)

Sets the EG depth for the modulation depth of the main modulator.

□ **Settings:** -64 ~ 0 ~ +63

■ M.Mod EG Vel (Main Modulation Envelop Generator Velocity)

Sets the velocity sensitivity for the main modulation EG depth. The main modulation EG depth can be controlled by the velocity at which the note played on the keyboard.

□ **Settings:** -64 ~ 0 ~ +63

■ S.Mod Depth (Sub Modulation Depth)

Sets the modulation depth of the sub modulator.

□ **Settings:** -64 ~ 0 ~ +63

■ S.Mod EG (Sub Modulation Envelop Generator Depth)

Sets the EG depth for the modulation depth of the sub modulator.

□ **Settings:** -64 ~ 0 ~ +63

■ S.Mod EG Vel (Sub Modulation Envelop Generator Velocity)

Sets the velocity sensitivity for the sub modulation EG depth. The sub modulation EG depth can be controlled by the velocity at which the note played on the keyboard.

□ **Settings:** -64 ~ 0 ~ +63

■ Pan

The same as the one in the EP Pickup. See page 126 for information.

10: Seismic

The Seismic, as its name implies, makes the sounds roar. The input signal is sent to the time-variant low-boost filter, then passed through the overdrive. Since the low-boost amount can be controlled by the EG, Seismic will not only emphasize the bottom of the sounds but provide with a compressor type effect. Also, since the overdrive is effective for each note, different from a conventional effector, Seismic can offer you a new dimension to your sounds.

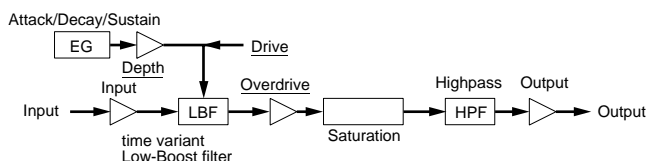

NOTE The underlined items in the diagram are available as the Destination parameters for the FDSP Controller set (page 141).

■ Input Level

Sets the input level for the FDSP unit.

□ **Settings:** $-64 \sim 0 \sim +16$

■ Drive

Sets the low-boost amount.

□ **Settings:** $0 \sim 127$

■ Drive Vel (Drive Velocity)

Sets the velocity sensitivity for the low-boost amount. The low-boost amount can be controlled by the velocity at which the note played on the keyboard.

□ **Settings:** $-64 \sim 0 \sim +63$

■ Drive K.Flw (Drive KeyFollow)

Sets the KeyFollow for the Drive. The Drive KeyFollow function controls the amount of the low-boost in accordance with the notes played on the keyboard. When set to a positive value, the higher the note played on the keyboard, the greater the low-boost becomes. When a negative value is set, the lower the note played, the greater the low-boost becomes.

□ **Settings:** $-64 \sim 0 \sim +63$

■ Drive EG (Drive Envelope Generator Depth)

Sets the EG depth to affect the amount of the low-boost.

□ **Settings:** $-64 \sim 0 \sim +63$

■ Drive EG Vel (Drive Envelope Generator Velocity)

Sets the velocity sensitivity for the Drive EG. The EG depth can be controlled by the velocity at which the note played on the keyboard.

□ **Settings:** $-64 \sim 0 \sim +63$

■ Attack Time

Sets the amount of time from when the note is played to the maximum level.

□ **Settings:** $0 \sim 127$

■ Attack T.Kf (Attack Time KeyFollow)

Sets the KeyFollow for the Attack Time. This KeyFollow function controls the attack time in accordance with the notes played on the keyboard. When set to a positive value, the higher the note played on the keyboard, the shorter the attack time becomes. When a negative value is set, the lower the note played, the shorter the attack time becomes.

□ **Settings:** $-64 \sim 0 \sim +63$

■ Decay Time

Sets the EG decay time (the time of decay from the maximum level until the sustain level).

□ **Settings:** $0 \sim 127$

■ Decay T.Kf (Decay Time KeyFollow)

Sets the KeyFollow for the Decay Time. This KeyFollow function controls the decay time in accordance with the notes played on the keyboard. When set to a positive value, the higher the note played on the keyboard, the shorter the decay time becomes. When a negative value is set, the lower the note played, the shorter the decay time becomes.

□ **Settings:** $-64 \sim 0 \sim +63$

■ Sustain Lvl (Sustain Level)

Sets the EG sustain level (the level to be reached from the maximum level).

□ **Settings:** $0 \sim 127$

Overdrive

Sets the amount of the over drive.

Settings: 0 ~ 127

HPF (High Pass Filter)

Sets the cutoff frequency which cuts the lower range of the output signals.

Settings: 0 ~ 127

HPF K.Flw (High Pass Filter KeyFollow)

Sets the KeyFollow for the High Pass Filter cutoff frequency. The High Pass Filter KeyFollow function controls the change in the cutoff frequency in accordance with the notes played on the keyboard. When set to a positive value, the higher the note played on the keyboard, the higher the cutoff frequency becomes. When a negative value is set, the lower the note played, the higher the cutoff frequency becomes. When set to “+ 32,” the KeyFollow functions at 100 % and the cutoff frequency changes in proportion to the pitch.

Settings: -32 ~ 0 ~ + 64

Output (Output Level)

Sets the final output level.

Settings: -60 ~ 0 ~ + 60

Pan

The same as the one in the EP Pickup. See page 126 for information.

[F7]: Ctrl (Controller)

[F8]: SET (Controller Set)

The effective “Destinations” for the FDSP voices are No. 36 ~ No. 44 controls. Refer to the Controller List in the separate Data List.

Drum Voice

Drum Voice editing lets you create your own drum kit by assigning AWM Elements to each note (pitch range C-2 ~ G8) and setting various parameters related to volume, pitch, and timbre.

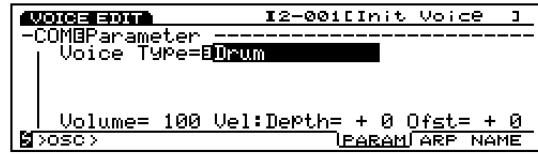

NOTE You can also use your own sampled data as an element.

NOTE For more information about drum voices, see page 39.

Since many of the parameters are the same as for normal voices (AWM Element), only the parameters that differ are explained.

VOICE

- └─Drum + [EDIT]
 - └─[F1:COMMON]142
 - └─[F6:Parameter]142
 - └─[F7:Arpeggio]79
 - └─[F3:Arpeggio-Edit]79
 - └─[F8:Name]79
 - └─[F2:OSCILLATOR]142
 - └─[F5:Tune]143
 - └─[F6:Wave]144
 - └─[F7:Mix]145
 - └─[F8:Zone]146
 - └─[F3:PITCH].....83
 - └─[F8:EG]84
 - └─[F4:FILTER]86
 - └─[F4:Static Control Filter]86
 - └─[F5:Dinamic Control Filter]91
 - └─[F6:Sensitivity].....93
 - └─[F8:EG]95
 - └─[F5:AMPLITUDE].....96
 - └─[F8:EG]98
 - └─[F6:LFO]147
 - └─[F8:LFO].....147
 - └─[F7:CONTROLLER]103
 - └─[F7:Pitch Control]103
 - └─[F8:Controller Set].....104
 - └─[F8:EFFECT]148
 - └─[F4:Type]148
 - └─[F5:Insertion Effect 1]106
 - └─[F6:Insertion Effect 2]106
 - └─[F7:Reverb]107
 - └─[F8:Chorus]107

* The parameters in the above grayed menus are the same as those found in the AWM Elements.

[F1]: COM (Common)

[F6]: PARAM (Parameters)

When Drum is selected for Voice Type in the PARAM menu, a maximum of 128 AWM Elements can be used to create drum voices (i.e., drum kits).

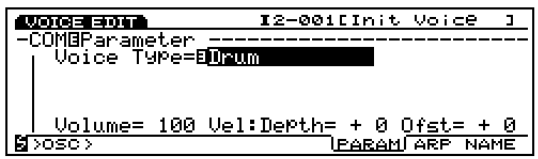

- NOTE** When Drum is selected for Voice Type, the panel ELEMENT SELECT keys 1-4 (EX5/7) for normal voices become inactive.
- NOTE** For more information about each voice type, see page 29.

[F2]: OSC (Oscillator)

These settings are related to the samples that form a voice. Because one drum voice (drum kit) can be formed with a maximum of 128 AWM Elements (see page 39), OSC lets you select the sample for each element as well as set minute parameters. There are four menus available.

- [F5]: TUNE
- [F6]: WAVE
- [F7]: MIX
- [F8]: ZONE

- NOTE** For more information about elements and samples, see page 29.

Steps for Assigning Elements to Each Key, and for Editing

- NOTE** An element can be assigned in the TUNE, WAVE, MIX, or ZONE screens, available from the OSC menu.
- 1 Select a key to which you want to assign an element.**
Turn the Data Dial or KNOB1 to select the key (note name) that will be assigned an element.

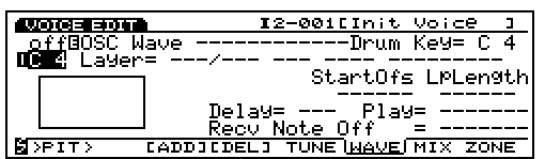

- NOTE** In the screen that has not been assigned an Element, hyphens (---) will be displayed and the cursor cannot be moved.
- NOTE** You can also use the INC/DEC key or the numeric keypad.

2 Assign the Element

Press [F3] to execute the ADD function. The sample (PRE:0001) is assigned as the first element for that key.

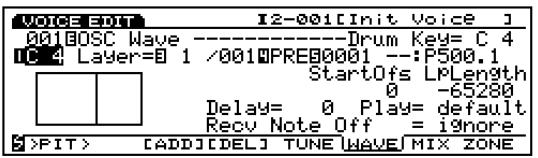

The key location of the currently assigned element is confirmed as indicated in the screen. The display corresponds to the musical scale from C-2 ~ G8.

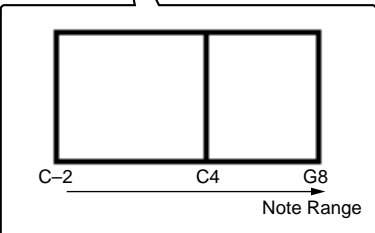
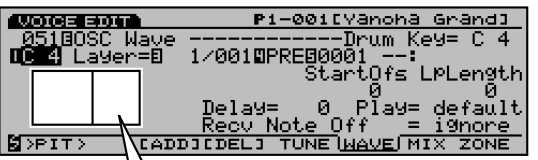

If you want, it is possible to assign many elements to the same key (called layering). To create layers, continue by pressing [F3] once more.

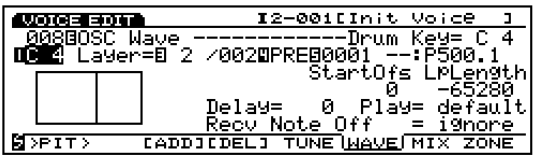

- NOTE** A maximum of 128 elements can be layered by repeating pressing F3 key. However, when one key uses a number of elements, the number of elements available for other keys decreases. The first four elements from the lowest number will sound at a time for a key.

3 (When setting the layers more than one for a key) Select a layer.

When many layers have been assigned to the currently selected key, move the cursor to Layer, select the layer to which you want to assign an element.

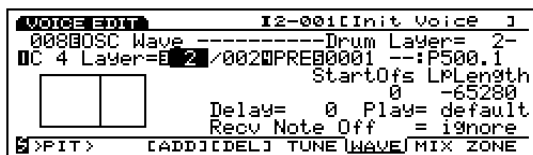

NOTE These steps are not necessary when you want to assign an element to the currently selected key.

4 Select a sample.

Move the cursor to the Sample Bank and the Sample Number to select the desired bank and number. The sample is assigned to the layer for the currently selected key.

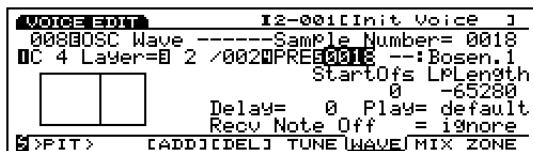

5 Set the parameters.

Move the cursor to the desired parameter, and then set each value.

6 Assigning to other keys.

Repeat steps 1 ~ 5 above to assign elements to the remaining keys, then complete a drum voice.

Deleting an Element from Each Key

NOTE You can delete an element in either the TUNE, WAVE, MIX, or ZONE screens, available from the OSC menu.

1 Select the key that will have an element deleted.

Turn the Data Dial or KNOB 1 to select the key (note name) you want to delete.

NOTE You can also use the [INC]/[DEC] key or the numeric keypad.

2 Delete the element.

Press the [F4] key to execute the [DEL] function. The elements assigned to that key, and all the layers, will be deleted. Hyphens (---) will be displayed for each parameter in the screen and the cursor can no longer be moved to those areas.

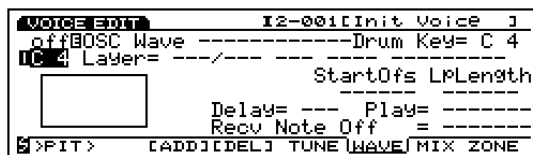

[F5]: TUNE

Sets the tuning and the EG for each element. A different value can be set for each element.

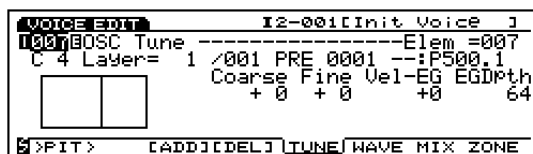

■ Drum Key

Selects the key (note name) that will be assigned an element. An element (sample) will be assigned to the key selected here. The key selection can be confirmed to the left of the screen. For more information, see page 146.

Settings: C-2 ~ G8

NOTE Different from a normal voice, drum elements are assigned to each key.

NOTE When an element has not been assigned to a key, hyphens (---) will be displayed for each parameter in the screen and the cursor cannot be moved.

■ Drum Layer

Selects the layer (see above). An element will be assigned to each layer and the related parameters can be set for the selected layer. This parameter is selectable only when elements more than one are assigned to the current key by pressing F3 (ADD) key.

Settings: 1 ~ 128 (depending on the number of assigned elements)

■ Sample Bank

Selects the desired sample bank. A different bank can be selected for each element.

- ❑ **Settings:** PRE (Preset), RAM (DRAM), FLS (Flash Memory)

NOTE FLS is effective only when an optional EXFLM1 is mounted onto the EX5/5R/7.

■ Sample Number

Selects the desired sample number from the sample bank. The category and sample name of the selected sample number are displayed to the right of the number. A different sample number can be selected for each element.

- ❑ **Settings:** For more information about each sample, see the separate Data List book.

■ Coarse Tune

Adjusts the pitch of the sample for each element, in semitones.

- ❑ **Settings:** -64 ~ +63

NOTE The setting exceeding the upper or lower limit of the MIDI note number range (C-2 ~ G8) is ineffective.

■ Fine Tune

Minutely adjusts the pitch of the sample of each element.

- ❑ **Settings:** -64 ~ +63

■ Pitch EG VelSens (PEG Velocity Sensitivity)

Sets the velocity sensitivity for the PEG. With positive values the harder a note is played, the greater the change in pitch. Negative values will produce the opposite effect.

- ❑ **Settings:** -7 ~ 0 ~ +7

■ Pitch EG Depth

Sets the amount of pitch change in the PEG. A setting of “0” produces no change, and maintains the original pitch.

- ❑ **Settings:** 0 ~ 127

[F6]: WAVE

Selects the element samples (maximum 128) that form a voice, and determines Loop related settings for each sample. A different value can be set for each element.

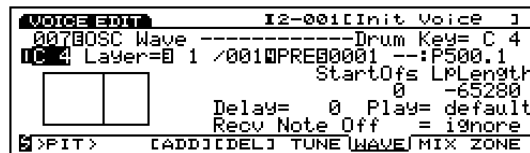

NOTE Although the menu name, WAVE is used here for the Drum Voice like the Normal Voice, the Drum Voice directly selects a sample, not a wave.

■ Drum key

■ Drum Layer

■ Sample Bank

■ Sample Number

These are the same parameters as those explained for the TUNE screen. See page 143.

■ Start Offset

Sets the offset value for the point where the sample sound actually begins.

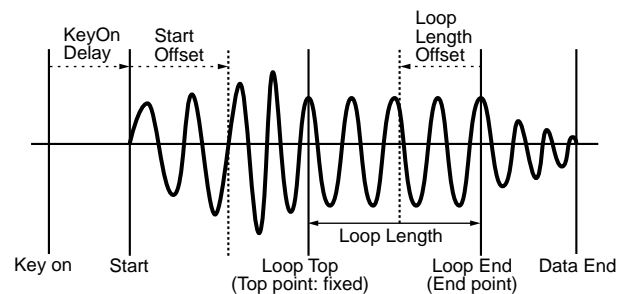

- ❑ **Settings:** 0 ~ 65535

■ Loop Length Offset

Sets the end point for the sample loop (see diagram, above).

- ❑ **Settings:** 0 ~ 65535

■ KeyOn Delay

Sets the amount of delay from when the key is played until sound is produced.

- ❑ **Settings:** 0 ~ 127

■ Sample Play

Sets the way in which the sample will be played.

❑ **Settings:** FwdLp, FwdLpEx, FwdNoLp, RevNoLp, default

NOTE For more information about each setting, see page 81.

■ Recv Note Off (Receive Note Off)

Sets whether or not MIDI Note Off messages for each element will be received or ignored.

❑ **Settings:** receive, ignore

[F7]: MIX

Sets the mix (output) balance for the elements' samples which configure a drum voice.

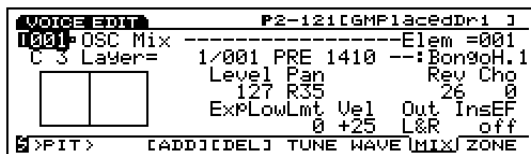

■ Drum key

■ Drum Layer

■ Sample Bank

■ Sample Number

These are the same parameters as those explained in the TUNE screen. See page 143.

■ Level

Sets the output level for each element. This setting adjusts the output balance for each drum/percussion instrument that make up the drum voice.

❑ **Settings:** 0 ~ 127

■ Pan

Sets the left and right positioning of each sound element in the stereo spectrum. This lets you adjust the positioning of where each instrument of the drum voice (drum kit) appears in the stereo spectrum. When set to “rnd” the sound moves randomly. You can control the range of movement to the left or right using the next setting, Random Depth.

❑ **Settings:** L63 (far left) ~ cnt (center) ~ R63 (far right), rnd (Random Pan)

■ Rev Send (Reverb Send)

Sets the Send level of the signal output from the Insertion Effects 1/2 (or by-passed) and sent to the Reverb unit.

❑ **Settings:** 0 ~ 127

NOTE The value set here will be multiplied by the value set in Reverb Send (EFCT screen), and output as an actual Reverb Send level.

NOTE For more information about Effects, see page 148.

■ Cho Send (Chorus Send)

Sets the Send level of the signal that output from the Insertion Effects 1/2 (or by-passed) and sent to the Chorus unit.

❑ **Settings:** 0 ~ 127

NOTE The value set here will be multiplied by the value set in Chorus Send (EFCT screen), and output as an actual Chorus Send level.

NOTE For more information about Effects, see page 148.

■ Random Depth

When you select “rnd” (Random Pan) in Pan, this parameter is displayed. This function causes the sound to move randomly in the stereo spectrum. Use this parameter to set the depth (range) of the Random Pan.

❑ **Settings:** 1 ~ 127

■ ExpLowLimit (Expression Low Limit)

Sets the Expression Low Limit for each sample. The lower limit can be set so that even when a sound is played below the set value, the volume will not go below the designated lower limit.

❑ **Settings:** 0 ~ 127

■ Level Vel (Level Velocity)

Sets the velocity level for each sample. The Level Velocity function controls the volume based on how hard the keyboard is played. When a positive value is set, the harder the keyboard is played, the greater the change in the volume. Negative values will have the opposite effect.

❑ **Settings:** -64 ~ 0 ~ +63

■ Out (Output Select)

Selects the output for each element. These settings let you send each element to a different output.

- ❑ **Settings:** L&R (OUTPUT L&R), ind1 (INDIVIDUAL OUTPUT1), ind2, ind3, ind4, ind5, ind6, i1&2 (INDIVIDUAL OUTPUT1&2), i3&4, i5&6

NOTE For example, when “i1&2” is selected, the L channel will be output from INDIVIDUAL OUTPUT1, and the R channel from INDIVIDUAL OUTPUT2.

NOTE EX5 is equipped with two Individual Outputs (1 and 2) while EX5R and EX7 are not equipped with the Individual Output. You can increase/equip the Individual Outputs on your instrument by installing an optional Individual Output Board (EXIDO1). For more information, see page 19.

■ InsEF Elem Sw (Insertion Effect Element Switch)

Selects the Insertion Effects unit that is sent a signal from each element. When “off” is selected, the Insertion Effect unit is by-passed.

- ❑ **Settings:** For each element, 1 (Insertion Effect unit 1), 2 (Insertion Effect unit 2), off

NOTE For more information about Effects, see page 148.

[F8]: ZONE

Sets velocity range at which sound is produced for each element. A different zone can be set for each element.

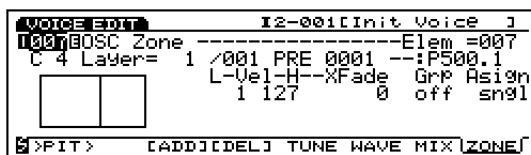

■ Drum key

■ Drum Layer

■ Sample Bank

■ Sample Number

These are the same parameters as those explained for the TUNE screen. See page 143.

■ Vel Limit Low (Velocity Limit Low)

Sets the lowest velocity value of each element sample that is detected when the keyboard is played.

- ❑ **Settings:** 1 ~ 127

NOTE The lowest velocity value set here and the value set in Vel Limit High (Velocity Limit High) determine the range of velocity for the selected element sample.

■ Vel Limit High (Velocity Limit High)

Sets the highest velocity value of each element sample that is detected when the keyboard is played.

- ❑ **Settings:** 1 ~ 127

■ Vel Xfade (Velocity Cross Fade)

Sets the cross fade velocity range (Vel Limit Low and High) for each element. As the value increases, the range becomes wider. A setting of “0” produces no effect.

- ❑ **Settings:** 0 ~ 127

NOTE For more information about Velocity Cross Fade, see page 82.

■ Alternate Group

This setting is used to terminate two sounds that in a traditional drum kit could not physically sound at the same time, or would not sound natural when played simultaneously. For example, it is impossible for a real drum set to sound a closed hi-hat and open hi-hat at the same time. Therefore, elements that should not sound simultaneously should be assigned to the same group number. There are 127 types of group numbers. When it does not matter if two elements sound simultaneously, or when it is preferable that two sound together, select “off.”

- ❑ **Settings:** off, 1 ~ 127

■ Key Assign

Selects sngl (single) or mlti (multi) Key Assign. In sngl (single), if the tone generator receives the same note twice, the first note is terminated when the same note is received. In mlti (multi), when the same notes are received, sounds are assigned to one channel after another, making multiple tone generation possible.

- ❑ **Settings:** sngl, mlti

[F3]: PITCH

There is one type of menu related to pitch when editing a Drum Voice. The parameters and settings are the same as those for AWM Element. For information, see page 83.

[F8]: EG (Envelope Generator)

[F4]: FILT (Filter)

There are four types of menus related to filters when editing a Drum Voice. The parameters and settings are the same as those for AWM Element. For information, see page 86.

[F4]: SCF (Static Control Filter)
 [F5]: DCF (Dynamic Control Filter)
 [F6]: SENS (Sensitivity)
 [F8]: EG (Envelope Generator)

[F5]: AMP (Amplitude)

There is one type of menu related to amplitude when editing a Drum Voice. The parameters and settings are the same as those for AWM element. For information, see page 96.

[F8]: EG (Envelope Generator)

[F6]: LFO (Low Frequency Oscillator)

There is one type of menu with LFO related settings when editing a Drum Voice.

[F8]: LFO (Low Frequency Oscillator)

[F8]: LFO (Low Frequency Oscillator)

Sets LFO related parameters. A different value can be set for each element.

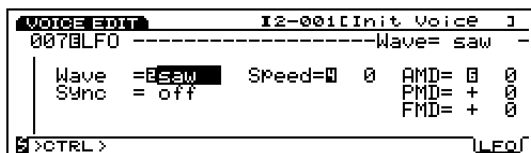

■ Wave

Selects the LFO wave. Using the waves selected here, you can modulate the sound in various ways. There are three types of waves available.

□ **Settings:** saw, tri, squ

NOTE The LFO can modulate the pitch, filter, and amplitude at the same time.

NOTE For more information about each wave, see page 122.

■ Sync

This switch turns the Sync on and off. When Sync is set to “on,” the LFO oscillator is reset every time the keyboard is played.

□ **Settings:** on, off

NOTE For more information about resetting the LFO, see page 103.

■ Speed

Sets the speed of change of the LFO wave. The higher the value, the faster the speed.

□ **Settings:** 0 ~ 63

NOTE For more information, see the Speed concept graph on page 101.

■ AMD (Amplitude Modulation Depth)

Determines how greatly the LFO will affect the volume. The larger the value, the wider the degree of change in the volume.

□ **Settings:** 0 ~ 127

■ PMD (Pitch Modulation Depth)

Determines how greatly the LFO will affect the pitch. The larger the value, the wider the degree of change in the pitch. When negative values are set, the phase of the LFO is reversed.

□ **Settings:** -255 ~ 0 ~ +255

■ FMD (Filter Modulation Depth)

Determines how greatly the LFO will affect the filter cutoff frequency. The larger the value, the wider the degree of change in the cutoff frequency. When negative values are set, the phase of the LFO is reversed.

□ **Settings:** -127 ~ 0 ~ +127

[F7]: Ctrl (Controller)

[F8]: SET(Controller Set)

The effective “Destinations” for the Drum voices are No. 121 DRPAN ~ No. 125 DR FEG Depth controls. Refer to the Controller List in the separate Data List.

[F8]: EFCT (Effects)

Sets the effects for the drum elements. The signals from the maximum of 128 drum elements can be connected either to Insertion Effect 1 or 2, then sent to the Reverb/Chorus unit. “InsRev” and “InsCho” parameters added to the Type screen allow you to emphasize the effect for specific drum elements. The other parameters are the same as those for AWM elements on page 105.

[F4]: TYPE

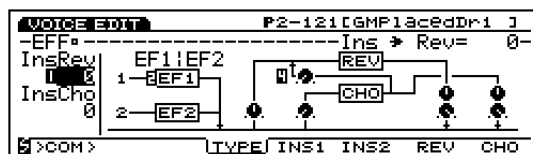

■ Ins→Rev

Sets the send level of the signal output from the Insertion unit and sent to the Reverb unit. By passing specific elements through Insertion effect and setting the output level here, you can make different setting for the amount of Reverb applied to the specific elements.

□ **Settings:** 0 ~ 127

■ Ins→Cho

Sets the send level of the signal output from the Insertion unit and sent to the Chorus unit. By passing specific elements through Insertion effect and setting the output level here, you can make different setting for the amount of Chorus applied to the specific elements.

□ **Settings:** 0 ~ 127

NOTE You can determine whether or not each effect is applied to each element in the Mix screen (page 145).

Voice Job Mode

These jobs let you initialize or recall voices that are created in Voice Edit mode.

Press [JOB] key on the panel while in Voice mode to enter Voice Job mode. When you enter the Voice Job mode, the following menu will be displayed. There are three types of jobs in Voice Job mode. Press [F1] (INIT), [F2] (RECL), or [F3] (COPY) to select a job.

NOTE It is necessary to first select the voice that will be initialized or recalled, before entering the Voice Job mode.

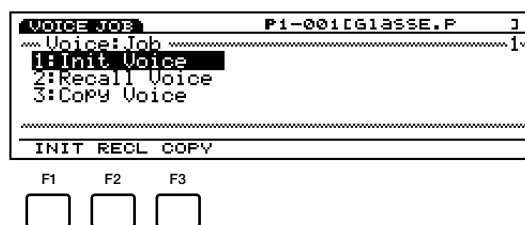

[F1]: INIT (Initialize)

[F2]: RECL (Recall)

[F3]: COPY (Copy)

Steps for Executing a Job

- 1 When in the Voice Play mode, select the voice number you want to execute job operation.
- 2 Press [JOB] to enter the Voice Job mode.
- 3 Press [F1] (INIT), [F2] (RECL), or [F3] (COPY) to select a job to execute. The selected job screen will be displayed.

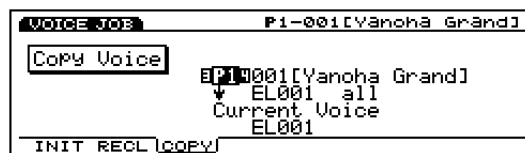

NOTE You can also select each job by moving the cursor to the desired job name on the screen and pressing [ENTER].

- 4 Move the cursor to a parameter and use the [INC]/[DEC], Data Dial, numeric keypad, or the Knobs 1 ~ 6 to set values.

NOTE This operation is not necessary for Initialize and Recall.

- 5 Press [ENTER]. The following pop-up menu will appear, prompting confirmation of the operation.

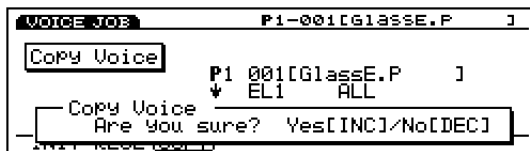

- 6 Press [YES] to execute the job. “Completed!” will momentarily appear in the screen indicating that the job was executed and the previous screen will be displayed.

Press [NO] to cancel the job.

NOTE “Executing...” will appear when the Voice Job takes some time to execute. Take note that if the power is turned off while “Executing...” is displayed, the data may be destroyed.

- 7 Press [EXIT] twice to exit the Voice Job mode and return to the Voice Play mode.

[F1]: Init Voice(Initialize Voice)

This job lets you call up the initial values for each voice (to initialize). Initializing should be used before editing, for example when creating an original voice from scratch.

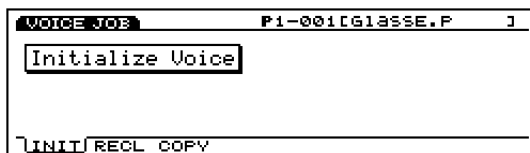

[F2]: Recall Voice

Without storing a voice while editing, if you select another voice, the previous voice’s edit data will be lost. The Recall job makes it possible to return to the original data that was being edited, even after selecting another voice.

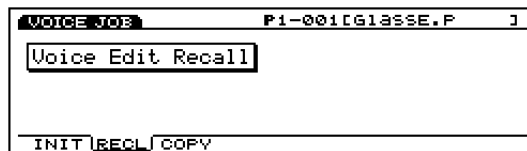

NOTE Even after turning the power “off” and “on,” you can still return to the data that was being edited.

[F3]: Copy Voice

This job lets you copy the common data of a voice or the specific data of a specified element to the currently editing voice. This job is convenient for utilizing a portion of a voice’s data in the creation of another voice.

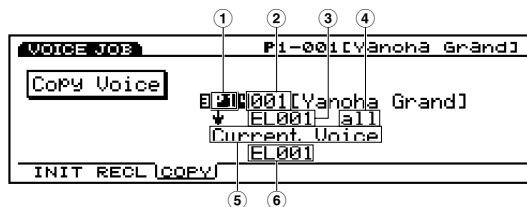

NOTE This job is not to copy a voice as a user voice. Instead, this job copies the different parameter values for the one voice to another voice (regardless of the presets and user voices).

1 Source Voice Bank

Sets the source voice bank.

Settings: P1 (Preset 1), P2 (Preset 2), I1 (Internal 1), I2 (Internal 2)

2 Source Voice Number

Sets the source voice number that will be copied from.

Settings: 001 ~ 128

3 Source Element

Sets the source voice element that will be copied from. When copying data that is common to all the elements, select Common.

Settings: Common (All elements), EL1 ~ 4 (Normal voice), EL1 ~ 128 (Drum voice)

④ Types of Source Data

Selects the type of data that will be copied. It is possible to designate common data that affects all of the elements, and specific data for specified elements.

When Common (All elements) is selected for the Source Element:

ALL (All voice data), PARAM (Parameter settings), ARP (Arpeggio settings), EFCT (Effect settings), CTRL (Controller settings), NAME (Voice name)

When an Element is selected for the Source Element:

ALL (All the data for that element), OSC (Oscillator settings), PITCH (Pitch settings), FILTER (Filter settings), AMP (Amplitude settings), LFO (Low Frequency Oscillator settings)

⑤ Current Voice

Fixed to the currently editing voice.

⑥ Destination Element

Sets the destination voice element that will be copied to. This parameter is displayed only when an element is selected in the Source Element parameter.

- **Settings:** EL1 ~ 4 (Normal voice), EL1 ~ 128 (Drum voice)

Wave Edit Mode

When you select a DRAM (RAM) bank and AWM wave number (0001 ~ 1024) from the Bank and Number in the WAVE display of the OSC menu in the Voice Edit mode, [F3] (WAVE-EDIT) sub menu is added to the screen.

Press [F3] to enter the Wave Edit mode. In the Wave Edit mode, you can create waves that make up a voice by layering preset samples and/or your own samples that you created, designating the keyboard range for each sample. Waves that you have created here can be used the same as preset waves.

- NOTE (D)RAM bank/number is selectable, only when the AWM elements are selected for editing.

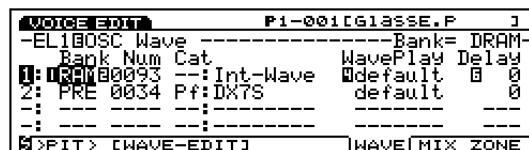

Press [EXIT] to exit the Wave Edit mode. The EX5/5R/7 returns to the original display (Voice Edit mode).

- NOTE In Wave Edit mode, a sample wave is not changed and therefore not destroyed. The edit here will not change the sample waves but designate their layerings, their keyboard ranges and mix balance between them.

In the Wave Edit mode, there are the following four types of menus. Press each [F5] (NAME), [F6] (SMPL), [F7] (MIX), or [F8] (ZONE) to switch to the necessary display. Also for adding or deleting layers, the “ADD” function is assigned to [F3] (ADD) and the delete function is assigned to [F4] (DEL).

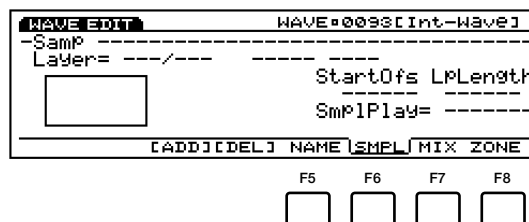

- [F5]: NAME (Settings for naming waves)
- [F6]: SMPL (Settings related to playing back samples)
- [F7]: MIX (Settings related to the output balance)
- [F8]: ZONE (Settings related to the sound range)

Basic Steps for Wave Edit (Creating a new wave scratch)

- 1 In the WAVE display, select the wave number to edit. Select the DRAM (RAM) bank and a wave number (Int-Wave) from the bank. [F3] (WAVE-EDIT) will be added.
- 2 Press [F3] (WAVE-EDIT) to enter the Wave Edit mode. [F3] (ADD) and [F4] (DEL) will be added.
- 3 Press either [F6] (SMPL), [F7] (MIX), or [F8] (ZONE) to access the necessary display.
- 4 Press [F3] to execute Add function. The first layer will be assigned with "PRE: 001."
- 5 Select the Sample Bank and sample number you want to use.

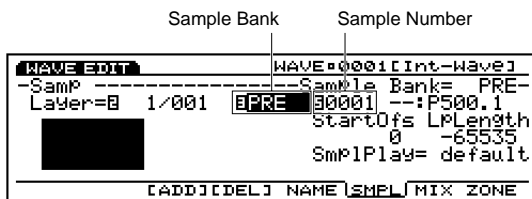

- 6 Set the necessary parameters for the first layer. Access other displays according to your objectives and set the parameters.
- 7 (If necessary,) press [F3] (ADD) to add the second layer. At this point, the layer number also automatically switches to the next number. Also, the previous layer's (in this case, the first layer's) settings are copied as is to the added layer.

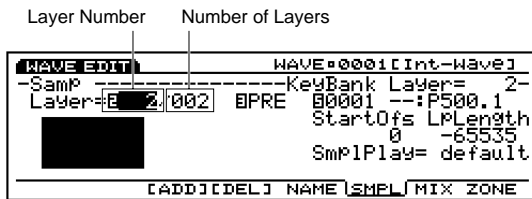

NOTE When [F4] is pressed, the currently selected layer will be deleted.

- 8 Select a sample that will be used as the second layer.

- 9 Set the necessary parameters for the second layer. Access other displays according to your objectives and set the parameters.
- 10 Repeat steps 7 ~ 9 and set the necessary parameters for each layer.
- 11 Press [F5] (NAME) to access the NAME display and set the wave name for the wave that you created.
- 12 Press [EXIT] to exit the Wave Edit mode. The EX5/5R/7 returns to the Voice Edit mode.

NOTE You can use the Wave Job mode (page 154) to copy already existing waves or to delete unnecessary waves.

[F3] (ADD) and [F4] (DEL) Keys

A wave can be made up of one or more layers (a maximum of 128 layers). Each layer is assigned with a sample. By setting the same sound range for each layer, you can layer two or more samples.

NOTE Although you can layer as many samples as you like, up to two samples sound simultaneously. In this case, the samples with lowest layer numbers have the priority.

When you edit a wave for the first time, the default of layer number is set to one.

You can add a layer each time you press [F3] (ADD). As shown in the diagram, you can confirm the current layer number used for the wave and select a sample for the current layer number.

You can select an unnecessary layer and delete that layer by pressing [F4] (DEL).

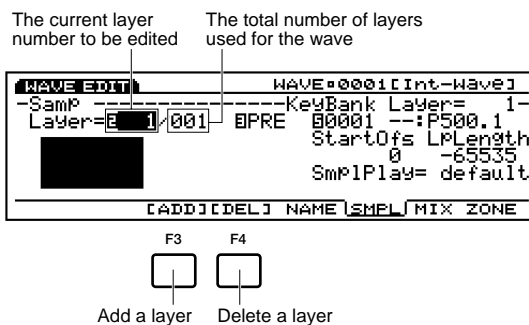

NOTE The maximum number of layers are 1024 for DRAM and FLS (Flash), respectively.

[F5]: NAME

Lets you give a name to the wave with up to eight characters. You can also put a category name to which the current wave belongs by moving the cursor to the left of the wave name and using the [INC]/[DEC] or the Data Dial to select a two-letter category name.



NOTE The method for naming a wave and its category is the same as that for a Voice. For more information, see page 79.

[F6]: SMPL (Sample)

Provides the settings related to playback for the samples that make up a wave. You can make settings for each layer.

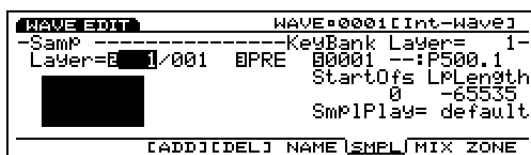

Layer

Selects the layer number that will be assigned with a sample. Once a layer number is selected, the parameter settings of the selected layer will be displayed. By switching among the layer numbers, you can make settings for each sample in all layers.

Settings: 1 ~ 128 (Differs depending on the total number of layers used for a wave.)

NOTE “Layer” is also found in the same position of the [F7]: MIX display and the [F8]: ZONE display.

Sample Bank

Selects the desired sample bank that contains the sample that you want to use. A different bank can be selected for each layer.

Settings: PRE (Preset), DRAM (including SIMM), FLS (Flash Memory)

NOTE “FLS” and its sample number can also be selected, though, the selection is ineffective unless you install the optional EXFLM1s in the instrument.

NOTE “Sample Bank” is also found in the same position of the [F7]: MIX display and the [F8]: ZONE display.

Sample Number

Selects the desired sample number from the sample bank. When the sample number is selected, its name and category are displayed to the right of the number. A different sample number can be selected for each layer.

Settings: 0001 ~ 1024

NOTE “Sample Number” is also found in the same position of the [F7]: MIX display and the [F8]: ZONE display.

Zone Graphical Display

The zone (the keyboard/velocity range within which a sample is played) of the currently selected layer can be confirmed visually. For the information how to set a zone, see page 153.

StartOfs (Start Offset)

Sets the offset value for the Start point of the sample playback. The value set here will increase or decrease the Start point for each sample.

Settings: 0 ~ 65535

LpLength (Loop Length)

Sets the offset value for the loop length of the sample loop playback. The value set here will increase or decrease the loop length for each sample.

Settings: 0 ~ 65535

SmpPlay (Sample Play)

Switches how the sample is played back. There are five choices: “FwdLp,” “FwdLpEx,” “FwdNoLp,” “RevNoLp” or “default.”

Settings:

FwdLp:

While a key is pressed (held down), the sample playback begins from the Start point, moves to the Top point and then repeats continuously from the Top point to the End point.

FwdLpEx:

This is the same as “FwdLp” as long as the key is held. However, when you release your finger from the keyboard, the Ex5/5R/7 cancels the loop playback, goes beyond the End point, and plays the rest of the sample data, then stops at the data end.

FwdNoLp:

Each time a key is played, the sample will play back one time from the Start point to the End point.

RevNoLp:

Each time a key is played, the sample will play back in reverse one time, from the End point to the Start point.

default:

Follows the original setting made in the Sample Edit mode.

[F7]: MIX

Sets the mix (output), pan, and other settings related to pitch for each sample which make up a wave. Settings can be made for each layer.

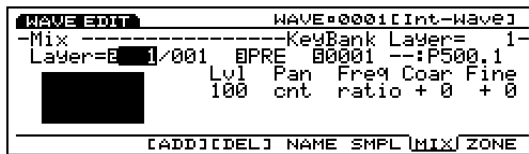

NOTE The Layer and Sample Bank/Number parameters here are the same as those in the SMPL display. For more information on these parameters, see page 152.

NOTE The Zone Graphical Display to the left of the screen shows the keyboard/velocity range of the currently selected layer. For more information on the Zone Graphical Display, see below.

■ Lvl (Level)

Sets the output level for each sample. This setting adjusts the output balance for the samples/layers.

Settings: 0 ~ 127

■ Pan

Sets the left or right positioning of each sample in the stereo spectrum. This setting adjusts the positioning of where each sample appears in the stereo spectrum.

Settings: L64 (far left) ~ cnt (center) ~ R63 (far right)

■ Freq Mode (Frequency Mode)

Sets the pitch for each sample either to semitones for each key (ratio), or to the same pitch for the entire keyboard (fixed).

Settings: ratio, fixed

■ Coar (Coarse Tune)

Adjusts the pitch of the sample for each layer in semitones.

Settings: -64 ~ 0 ~ +63

■ Fine (Fine Tune)

Finely adjusts the pitch of the sample for each layer.

Settings: -64 ~ 0 ~ +63

[F8]: ZONE

Sets the zone of each sample (the keyboard and velocity ranges within which the sounds are played). A different zone can be set for each sample/layer.

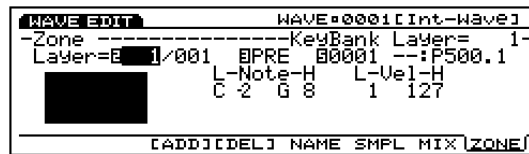

NOTE The Layer and Sample Bank/Number parameters here are the same as those in the SMPL display. For more information on these parameters, see page 152.

■ Note Limit Low

Sets the lowest note of the zone on the keyboard, for each sample.

Settings: C-2 ~ G8

NOTE The lowest note set here and the note set in Note Limit High determine the range where sound will be produced for the selected sample.

■ Note Limit High

Sets the highest note of the zone on the keyboard, for each sample.

Settings: C-2 ~ G8

NOTE The Note Limit Low note can not be set higher than the Note Limit High, and vice versa.

■ Vel Limit Low (Velocity Limit Low)

Sets the lowest velocity value of each sample that is detected when the keyboard is played.

Settings: 1 ~ 127

NOTE The lowest velocity value set here and the value set in Vel Limit High determine the range of velocity for the selected sample.

■ Vel Limit High (Velocity Limit High)

Sets the highest velocity value of each sample that is detected when the keyboard is played.

Settings: 1 ~ 127

NOTE The Vel Limit Low value can not be set higher than the Vel Limit High. Also vice versa, the Vel Limit High value can not be set lower than the Vel Limit Low.

Zone Graphical Display

On the left side of this screen, the zone (keyboard and velocity range at which sound will be produced) is displayed. The note range is indicated by the horizontal axis, while the velocity note range is indicated by the vertical axis. As each parameter value is adjusted, the shape of the black box, which represents the note range, changes accordingly.

NOTE When you switch to a different layer, that layer's zone is displayed in the Zone Graphical Display. It is not possible to view more than one zone at the same time.

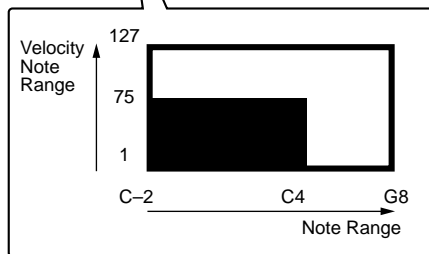
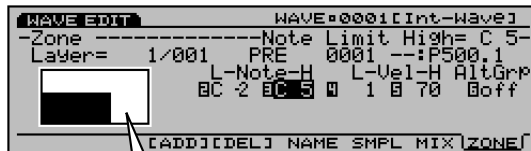

Wave Job Mode

When in the Wave Edit mode, press [JOB] to enter Wave Job mode. These jobs let you copy and delete waves that were created in Wave Edit mode.

When you enter the Wave Job mode, the following menu will be displayed. There are two types of jobs in Wave Job mode, Copy wave and Delete wave. Press [F1] (COPY) or [F2] (DEL) to select a job.



[F1]: COPY (Copy wave)

[F2]: DEL (Delete wave)

Steps for Executing a Job

- 1 When in the Wave Edit mode, press [JOB] to enter the Wave Job mode.
- 2 Press [F1] (COPY) or [F2] (DEL), to select a job to execute. The selected job screen will be displayed.

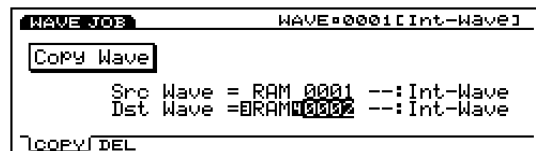

NOTE You can also select each job by moving the cursor to the desired job name on the screen and pressing [ENTER].

- 3 Move the cursor to a parameter and use the [INC]/[DEC], Data Dial, numeric keypad, or the Knobs 1 ~ 6 to set values.
- 4 Press [ENTER]. The following pop-up menu will appear, prompting confirmation of the operation.

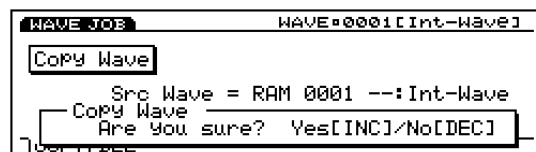

- 5 Press [YES] to execute the job. “Completed!” will momentarily appear in the screen indicating that the job was executed and the previous screen will be displayed.

Press [NO] to cancel the job.

NOTE “Executing...” will appear when the Wave Job takes some time to execute. Take note that if the power is turned off while “Executing...” is displayed, the data may be corrupted.

- 6 Press [EXIT] twice to exit the Wave Job mode and return to the Wave Edit mode.

[F1]: Copy Wave

This job copies wave data to a designated wave number. More than one layer can be copied at the same time.

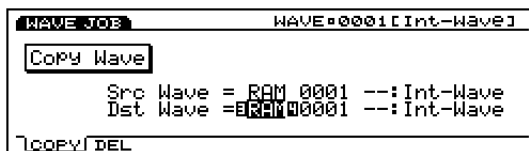

■ Src Wave (Source Wave)

Sets the source wave bank/number.

- Wave Bank:** RAM (DRAM, including SIMM), FLS (Flash Memory)

NOTE “FLS” and its wave number can also be selected, though, the selection is ineffective unless you install the optional EXFLM1s in the instrument.

- Wave Number:** 0001 ~ 1024

■ Dst Wave (Destination Wave)

Sets the destination wave bank/number that will be copied to.

- Wave Bank:** RAM (DRAM, including SIMM), FLS (Flash Memory)

- Wave Number:** 0001 ~ 1024

NOTE When you copy from RAM to FLS, if there is enough FLS memory available, the sample data used for the wave will also be copied together.

NOTE “FLS” and its wave number can also be selected, though, the selection is ineffective unless you install the optional EXFLM1s in the instrument.

[F2]: Delete Wave

This job deletes a designated wave or all waves at the same time.

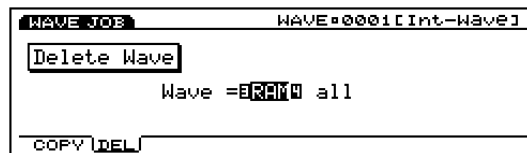

■ Wave

Sets the wave bank/number of the wave that will be deleted. To delete all of the waves in the selected bank, set the wave number parameter to “all.”

- Wave Bank:** RAM (DRAM, including SIMM), FLS (Flash Memory)

- Wave Number:** all, 0001 ~ 1024

Performance Mode

Performance Play Mode

Performance Play mode lets you play the Performances of your own creation in realtime and use the EX5/5R/7 as a powerful multi timbre tone generator using the internal sequencer function (Song mode/Pattern mode) or an external sequencer.

In Performance Edit mode you can assign voices and drum voices to a maximum of 16 parts with the different MIDI channel settings. It means the EX5/5R/7 can operate as 16 individual tone generators (maximum). Also, multiple parts can be set to the same MIDI channel to create layers.

For Performances you have created, there are eight Internal Banks (A-H) each with 16 Programs, a total of 128 memory locations. With EX5/7 all of the Performances are quickly accessible from the panel by pressing Bank/Program keys. It will be a powerful tool for your realtime performance in a studio or on a stage.

Following is an explanation of the screen that appears when Performance Play mode is selected, and how to select a Performance.

NOTE To obtain the arpeggiator function in Performance mode, both the Arpeggio Switch and Layer Switch (page 166) should be on before turning on the Arpeggiator by ARPEG(GIO) key on the panel.

Performance Play Mode screen

Press [PERFORM] key on the panel to enter Performance Play mode. When you enter Performance Play mode, the following screen appears. The contents are shown below.

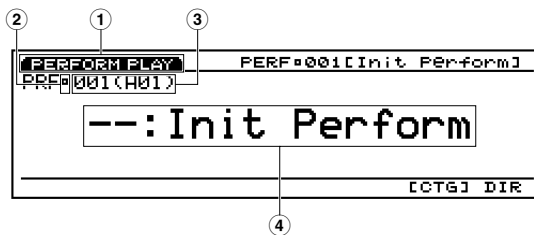

① Screen Title

Indicates Performance Play mode.

② Edit/Compare

When the currently selected Performance is being edited (see page 159), an "E" (Edit) mark is displayed. When comparing sounds (page 159), a "C" (Compare) mark is displayed.

③ Performance number

The selected Performance number (001 ~ 128) and the Bank (A ~ H)/Program (1 ~ 16) are displayed. When initially turned on, "001 (A01)" will be displayed. "001" indicates the Performance number, "A" indicates the Bank/Program. "01" is the Program number for the current Bank.

■ About Performance number

Each Performance not only has a Performance number (listed 001 ~ 128), but also a Bank (A-H) with a Program number from 1 ~ 16. With EX5/7 You can access the Performance two different ways, with the numeric keypad for the Performance numbers or with the Bank and Program keys for the Bank/Program numbers.

NOTE The Bank and Program keys are not available with the EX5R.

The relationship between the Performance number and the Bank/Program number is shown below.

Performance Number	Bank	Program Number	Performance Number	Bank	Program Number
001	A	1	065	E	1
002	A	2	066	E	2
003	A	3	067	E	3
004	A	4	068	E	4
005	A	5	069	E	5
006	A	6	070	E	6
007	A	7	071	E	7
008	A	8	072	E	8
009	A	9	073	E	9
010	A	10	074	E	10
011	A	11	075	E	11
012	A	12	076	E	12
013	A	13	077	E	13
014	A	14	078	E	14
015	A	15	079	E	15
016	A	16	080	E	16
017	B	1	081	F	1
018	B	2	082	F	2
019	B	3	083	F	3
020	B	4	084	F	4
021	B	5	085	F	5
022	B	6	086	F	6
023	B	7	087	F	7
024	B	8	088	F	8
025	B	9	089	F	9
026	B	10	090	F	10
027	B	11	091	F	11
028	B	12	092	F	12
029	B	13	093	F	13
030	B	14	094	F	14
031	B	15	095	F	15
032	B	16	096	F	16
033	C	1	097	G	1
034	C	2	098	G	2
035	C	3	099	G	3
036	C	4	100	G	4
037	C	5	101	G	5
038	C	6	102	G	6
039	C	7	103	G	7
040	C	8	104	G	8
041	C	9	105	G	9
042	C	10	106	G	10
043	C	11	107	G	11
044	C	12	108	G	12
045	C	13	109	G	13
046	C	14	110	G	14
047	C	15	111	G	15
048	C	16	112	G	16
049	D	1	113	H	1
050	D	2	114	H	2
051	D	3	115	H	3
052	D	4	116	H	4
053	D	5	117	H	5
054	D	6	118	H	6
055	D	7	119	H	7
056	D	8	120	H	8
057	D	9	121	H	9
058	D	10	122	H	10
059	D	11	123	H	11
060	D	12	124	H	12
061	D	13	125	H	13
062	D	14	126	H	14
063	D	15	127	H	15
064	D	16	128	H	16

Selecting a Performance

When selecting a Performance, there are six types of methods that can be used, depending on your objectives and the present status.

- Use the Bank/Program keys.
- Designates the Performance number with the numeric keypad.
- Use the INC/DEC keys.
- Use the Data Dial.
- Use the Category Search function.
- Use the Directory Screen function.

All of the above methods of operation are the same as the selection methods explained in the Voice Play mode. For more information about how to select a voice, see page 36.

NOTE You can edit the voice which is used for a specific part of a performance, in the Performance mode. For more information, see page 159.

NOTE You cannot use two or more AN, FDSP or VL (EX5/5R) voices for a performance. Also, on EX7, if you use an AN or FDSP voice for a part, you cannot use insertion Effect for a voice in the same performance. For more information, see page 54.

④ Performance Category/name

■ Performance Category

A two letter abbreviation for the sound Category is located to the left of the Performance name. This abbreviation lets you see at-a-glance the type of voice selected.

NOTE For more information about categories, see page 76.

■ Performance name

A Performance name with a maximum of 12 characters can be displayed.

Performance Edit Mode

Following are explanations of the parameters related to Performance Edit mode. There are parameters whose settings affect all the parts and parameters which affect each individual part. These settings can be stored in each Performance.

Press [EDIT] key on the panel while in Performance mode to enter Performance Edit mode. When you enter Performance Edit mode, the following screen will be displayed. Performance Edit mode is divided into two groups: COM (common settings applied equally to all parts) and PART/MLT (settings related to each part). In PART and MLT (multi) all possible parameter settings are shared. In the PART screen, each part is displayed and set individually, whereas in the MLT screen, all 16 parts are displayed in a chart (list), and can be set within that chart.

NOTE You must first select the Performance that you want to edit before entering Performance Edit mode.

COM Menu

- [F1]: COM (Common settings applied equally to all elements)
- [F2]: PART
- [F3]: MLT

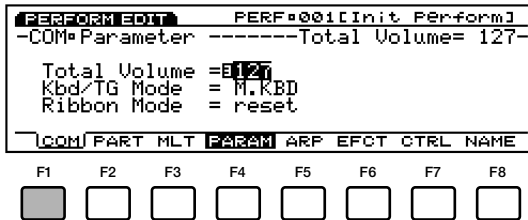

- [F4]: PARAM (Settings related to Common parameters)
- [F5]: ARP (Settings related to Arpeggiator)
- [F6]: EFCT (Settings related to the Effects)
- [F7]: CTRL (Settings related to the Controllers)
- [F8]: NAME (Settings related to a Performance Name)

PART Menu

- [F1]: COM
- [F2]: PART (Settings for each Part: 1 Part is displayed)
- [F3]: MLT

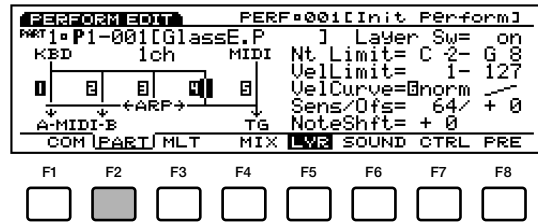

These keys let you access the desired parameter by jumping to a page.

- [F4]: MIX (Settings related to Mix)
- [F5]: LYR (Settings related to Layers)
- [F6]: SOUND (Settings related to Sound)
- [F7]: CTRL (Settings related to Controllers)
- [F8]: PRE (Settings related to the Presets)

MULTI Menu

- [F1]: COM
- [F2]: PART
- [F3]: MLT (Settings for each Part: All Parts are displayed)

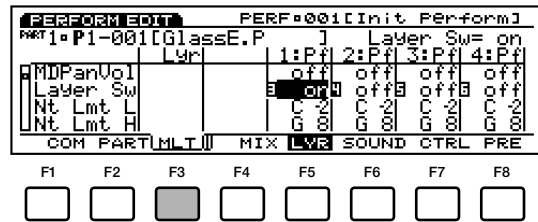

These keys let you access the desired parameter by scrolling down/up.

- [F4]: MIX (Settings related to Mix)
- [F5]: LYR (Settings related to Layers)
- [F6]: SOUND (Settings related to Sound)
- [F7]: CTRL (Settings related to the Controllers)
- [F8]: PRE (Settings related to the Presets)

About the E (Edit) mark

Whenever any setting is being made or an operational change is taking place, the “E” (Edit) mark appears in the upper left corner of the screen, next to the part number. This lets you confirm that the currently selected Performance is being edited and has not yet been stored.



NOTE The edited settings will be retained even after entering into Performance Play mode. However, once you select another Performance the settings are lost. Therefore if you return to the Performance Edit mode before selecting another Performance, the “E” mark is displayed.

NOTE The “E” mark also displays in the Performance Play mode screen.

About the Compare function

While in Performance Edit mode, you can listen to and compare both the original unedited sound and the edited sound.

1 Press the EDIT key while in the Performance Edit screen.

The “E” (Edit) mark which is displayed in the upper left corner of the screen (next to the part number) changes into a “C” (Compare), and you can hear the original sound before editing (i.e., Compare status).



NOTE When in Compare status, the cursor will not appear in the screen and Function keys F1 ~ F8 and Knobs 1 ~ 6 cannot be used for editing operations.

2 Press EDIT once more to exit the Compare status and return to the previous edit in progress.

Voice Editing From the Performance Mode

There may be times when you’ll want to actually edit a voice being used in the Performance mode rather than just the Performance parameters. You can jump directly to the Voice Edit mode from the Performance or Performance Edit mode by pressing the [VOICE] key while holding the [PERFORMANCE] key. First the Performance mode display will appear with the [F1] and [F2] function keys assigned to part selection.

Use the [F1] and [F2] keys to select the part corresponding to the voice you want to edit, then press the [EDIT] key to go to the Voice Edit mode. Once the voice has been edited as required, save the edited data (page 48), then press the [PERFORMANCE] key to return to the Performance mode.

NOTE The voice type cannot be changed when this method is used to access the Voice Edit mode. Use the normal Voice Edit mode—accessed via the Voice mode—if you need to change the voice type.

NOTE When you edit the voice with the Layer Switch (page 166) turned on, the voices from the other parts with the Layer Switch turned on will be produced. When you edit the voice with the Layer Switch turned off, only the currently editing voice will be produced.

[F1]: COM (Common)

The Common parameter settings are equally applied to all of the 16 parts of the performance. There are five types of menus available.

- [F4]: PARAM (Parameters)
- [F5]: ARP (Arpeggiator)
- [F6]: EFCT (Effect)
- [F7]: CTRL (Controllers)
- [F8]: NAME (Performance Name)

[F4]: PARAM (Parameters)

These parameters are related to the overall volume of the parts, as well as the keyboard/tone generator settings.

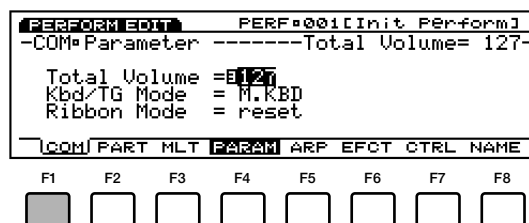

Total Volume

Sets the overall volume for the performance. The volume for each part will be explained later (see page 164).

Settings: 0 ~ 127

Kbd/TG Mode (Keyboard/Tone Generator Mode)

Configures how the tone generator is connected (the signal flow) when in Performance mode. Select M.KBD (Master Keyboard) when mainly using the keyboard for performing, and select TG (Tone Generator) when mainly used as a tone generator for the sequencer.

Settings: M.KBD, TG

M.KBD (Master Keyboard) Mode

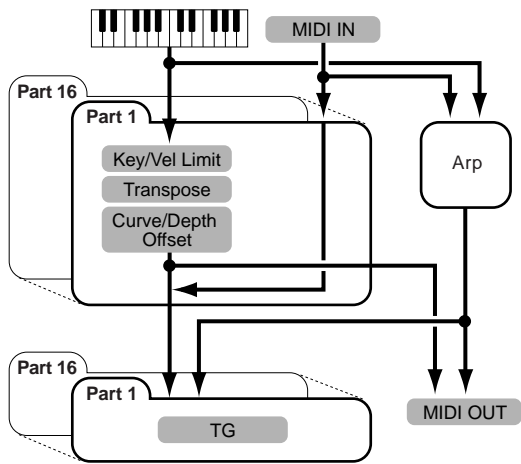

TG (Tone Generator Mode)

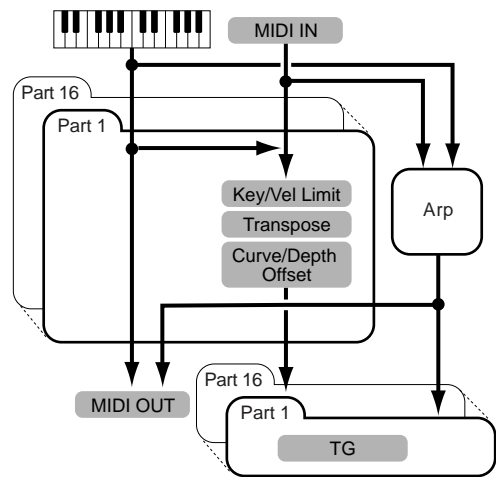

Ribbon Mode

Sets how the Ribbon Controller functions. When the “reset” setting is selected, if you release your finger from the Ribbon Controller, the value is reset to the center position on the Ribbon. When the “hold” setting is selected, if you release your finger from the Ribbon, the value of the position where your finger left the Ribbon is maintained.

Settings: reset, hold

NOTE This parameter is not available with EX5R.

[F5]: ARP (Arpeggio)

Parameters related to the Arpeggiator. Select the ARP menu with [F5] and the following setting directory menu is displayed.

```
PERFORM EDIT   PERF#001[Init Perform]
-COMBARpeggio -----Arp Sw= off-
Sw   =Eoff  Type =0001:PRE[UpOct1 ]
Tempo= 120  Ctrl = off
Hold = off  NoteLimit= C 2 - G 8
MIDI:Ch= 1  MIDI A= off MIDI B= off
[COM]PART MLT [ARP]
```

[F5]: [ARP-EDIT] (Arpeggio Edit)

[F8]: ARP

[F5]: ARP-EDIT (Arpeggio Edit)

When “USR” (USER) 51-100 is selected in Arpeggio Type with the Arpeggiator set to on, the ARP-EDIT menu is added to the [F5] key at the bottom of the screen. After entering the ARP-EDIT screen using [F5], you can perform Arpeggio editing operations. You can create your own original arpeggio. For more information, see page 238.

```
PERFORM EDIT   PERF#001[Init Perform]
-COMBARpeggio -----Arp Type= 051-
Sw   =B on  Type =0051:USR[Init Arp]
Tempo= 120  Ctrl = off
Hold = off  NoteLimit= C 2 - G 8
MIDI:Ch= 1  MIDI A= off MIDI B= off
[COM]PART MLT [ARP-EDIT] [ARP]
```

[F8]: ARP

Lets you select the type of arpeggio that will be used in the selected Performance, as well as determine the way the arpeggiator functions, and select MIDI related settings.

```
PERFORM EDIT   PERF#001[Init Perform]
-COMBARpeggio -----Arp Sw= off-
Sw   =Eoff  Type =0001:PRE[UpOct1 ]
Tempo= 120  Ctrl = off
Hold = off  NoteLimit= C 2 - G 8
MIDI:Ch= 1  MIDI A= off MIDI B= off
[COM]PART MLT [ARP]
```

■ Arpeggio Sw (Arpeggio Switch)

Turns the Arpeggiator on and off.

□ **Settings:** off, on

NOTE The ARPEGGIO key on the front panel also serves the same function. However, to actually activate the function, in the LYR (Layer) screen of each part, set the Layer Sw (Layer Switch) and the Arpeggio Switch to “on” (see page 166).

■ Arpeggio Type (Arpeggio Type)

Sets the arpeggio type.

□ **Settings:** See the Arpeggio Type List in the separate Data List book.

■ Arpeggio Tempo (Arpeggio Tempo)

Sets the arpeggio tempo.

□ **Settings:** 30 ~ 250

■ Tempo Ctrl (Tempo Control)

Sets whether one of the Knobs controls the arpeggio tempo, or not.

□ **Settings:** off, knob 1 ~ 6

■ Arpeggio Hold (Arpeggio Hold)

Sets the Arpeggio Hold to “on” or “off.” When Arpeggio Hold is set to “on,” even if you remove your fingers from the keyboard after playing, the arpeggio will continue to loop indefinitely.

□ **Settings:** on, off

■ Arpeggio Note LimitL (Note Limit Low)

Sets the lowest note of the arpeggio range on the keyboard.

□ **Settings:** C-2 ~ G8

NOTE The lowest note you set here and the note set for the Arpeggio Note High (Note Limit High) shown below, determine the range of notes within which the arpeggios will play.

■ Arpeggio Note LimitH (Note Limit High)

Sets the highest note of the arpeggio range on the keyboard.

□ **Settings:** C-2 ~ G8

■ Arpeggio MIDI Ch (Arpeggio MIDI Channel)

Sets the MIDI channel for the Arpeggiator. The voice of the part assigned to the same MIDI channel is arpeggiated.

□ **Settings:** 1 ~ 16

■ Arpeggio MIDI A/B (Arpeggio MIDI OUT A/B)

Sets the phrase of the Arpeggiator MIDI note to output from each MIDI OUT A/B when set to “on.” When set to “off,” no notes are output.

□ **Settings:** on, off

NOTE Arpeggio MIDI Out A/B is available for EX5. In the case of EX5R and EX7, only a set of Arpeggio MIDI Out is available.

[F6]: EFCT (Effects)

These are parameter settings related to the System Effects (effects equally applied to the entire parts). When the EFCT menu is selected using [F6], the following menu will be displayed.

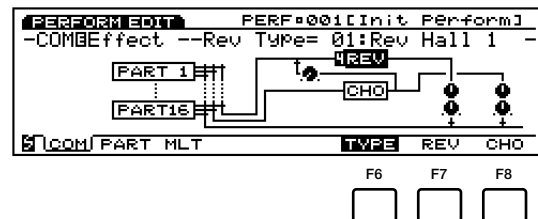

[F6]: TYPE

[F7]: REV (Reverb)

[F8]: CHO (Chorus)

NOTE The Insertion Effects (effects applied to each part) is not set here, but in Voice Edit mode (page 105).

NOTE For more information about effects, see page 65.

[F6]: TYPE

Sets the type of Reverb and Chorus effects. You can set the send and return levels of each effect unit to complete the total amount of effect signal for all parts.

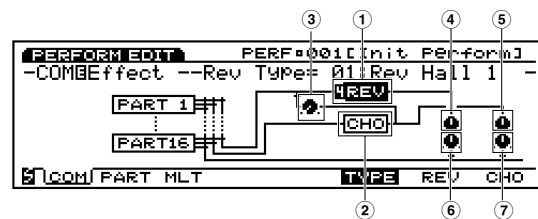

■ ① Rev Type (Reverb Type)

Selects the type of reverb for the Reverb unit.

□ **Settings:** 00 (off) ~ 12

NOTE For more information about each type of reverb, see the Effect Type List in the separate Data List book.

■ ② Cho Type (Chorus Type)

Selects the type of chorus for the Chorus unit.

❑ **Settings:** 00 (off) ~ 17

NOTE For information about each type of chorus, see the Effect Type List in the separate Data List book.

■ ③ Cho→Rev (Chorus→Reverb)

Sets the send level of the signal output from the Chorus unit, and then sent to the Reverb unit.

❑ **Settings:** 0 ~ 127

■ ④ Rev Pan (Reverb Pan)

Sets the panning position of the signal output from the Reverb unit.

❑ **Settings:** L64 (far left) ~ cnt (center) ~ R63 (far right)

■ ⑤ Cho Pan (Chorus Pan)

Sets the panning position of the signal output from the Chorus unit.

❑ **Settings:** L64 (far left) ~ cnt (center) ~ R63 (far right)

■ ⑥ Rev Return (Reverb Return)

Sets the return level of the signal output from the Reverb unit.

❑ **Settings:** 0 ~ 127

■ ⑦ Cho Return (Chorus Return)

Sets the return level of the signal output from the Chorus unit.

❑ **Settings:** 0 ~ 127

[F7]: REV (Reverb)

Sets various parameters for the currently selected Reverb effect.

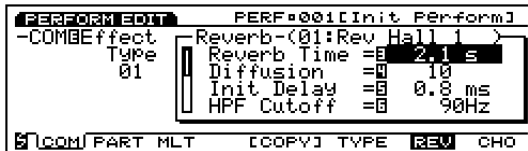

❑ **Settings:** (Available parameters and values that can be set depend on the type of reverb that is selected. For more information about each type of reverb, see the Effect Type List in the separate Data List book.)

[F8]: CHO (Chorus)

Sets various parameters for the currently selected Chorus effect.

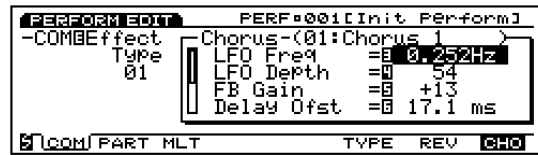

❑ **Settings:** (Available parameters and values that can be set depend on the type of chorus that is selected. For more information about each type of chorus, see the Effect Type List in the separate Data List book.)

[F5]: COPY

When [F7]: REV or [F8]: CHO is selected, the Copy function will be added to the [F5] key. This Copy function allows you to copy the reverb or chorus setting used for the voice of the currently selected part, and paste it as the Performance's reverb or chorus setting.

① Press [F5]: COPY while [F7]: REV or [F8]: CHO is selected. The following pop-up dialog appears.

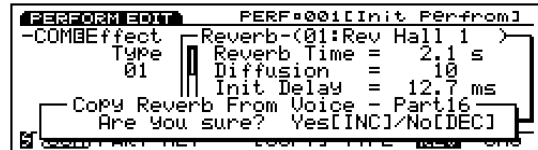

② Press [YES] key to execute the Copy function.

NOTE Press [NO] to abort the operation, returning to the previous screen.

③ “Completed!” momentarily appears to indicate that the Copy function has been executed.

[F7]: CTRL (Controller)

These settings are related to the Controllers. Beginning with the [PITCH] wheel, the settings that are common to all parts are arranged in a chart-type screen and can be set within the chart. When the CTRL menu is selected with the [F7] key, the following menus are displayed. The [F6], [F7] and [F8] keys can be used to easily scroll through the device types.

- [F6]: WHEEL
- [F7]: KNOB
- [F8]: OTHER

F6:WHEEL	PB (Pitch Bend Wheel) RC (Ribbon Controller) MW1 (Modulation Wheel 1) MW2 (Modulation Wheel 2)
F7:KNOB	KN1 (Knobs 1) KN2 (Knobs 2) KN3 (Knobs 3) KN4 (Knobs 4) KN5 (Knobs 5) KN6 (Knobs 6)
F8:OTHER	AT (Attack Touch) FC (Foot Controller) BC (Breath Controller)

Each of the parameters below can be set for the 13 types of devices (controllers), listed above.

Assign

Assigns a control function (MIDI control change number) to each device.

- Settings: 000 ~ 095 (See the Control List in the separate Data List book.)

NOTE Depending on the device, such as the [PITCH] wheel, for example, the control function may be fixed.

Depth

Sets the depth for the control of the control function selected in Assign.

- Settings: -8 ~ 0 ~ +7

Ofst (Offset)

Precisely adjusts the depth of control for the value set in Depth. The value set here will be added to or subtracted from the value set in Depth.

- Settings: -64 ~ 0 ~ +63

Curve

Selects the control curve, displayed to the far right of the screen, which defines the characteristics of the selected controller.

- Settings: -6 ~ +7

The Control Curve

Displayed to the far right of the screen is the current control curve image for each device. You can refer to this image when setting each value.

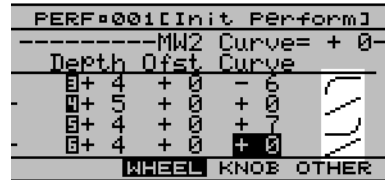

NOTE The settings here cannot be recorded to the sequencer.

[F8]: NAME

Lets you give a name to the Performance you have created with up to twelve characters.

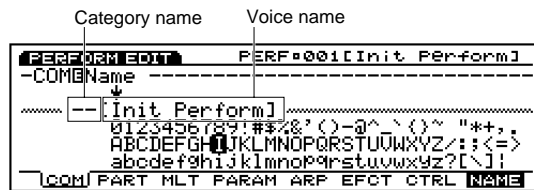

NOTE The method for naming a Performance is the same as that for a Voice. For more information, see page 79.

[F2]: PART

Lets you edit any one of the 16 parts that make up a performance. The parameters that can be set are the same as those explained for the MLT (multi) screen.

- [F4]: MIX
- [F5]: LYR (Layer)
- [F6]: SOUND (Sound)
- [F7]: CTRL (Controller)
- [F8]: PRE (Preset)

[F4]: MIX

These parameters are mainly related to output settings such as volume, pan and effect send levels. With these settings you can obtain just the right balance between each part in the mix.

PERFORM EDIT		PERF=001[Init Perform]	
PART1	P1-001[GlassE.P]	Bank=	P1
Volume	= 100	Reverb Send =	40
Pan	= cnt	Chorus Send =	0
Out Select	= L&R	InSEF Switch=	off
Detune	= + 0	Mono/Poly =	Poly
MIDI Pan/Vol=	off	Key Assign =	miti
COM PART MLT		MIX LYR SOUND CTRL PRE	

Part

Selects the part you will edit. When a part is selected, the current parameter settings for the selected part will be displayed.

When “L” is selected, you can adjust the overall settings (such as volume and pan) for the parts which “Layer Switches” (LYR menu) are turned on. Mix ([F4]) and Sound ([F6]) menus are available for “L” parts.

PERFORM EDIT		PERF=001[Init Perform]	
PART1	L	Volume	= 127
		Pan	= cnt
		Reverb Send =	40
		Chorus Send =	0
		Detune	= + 0
		Mono/Poly =	Poly
COM PART MLT		MIX SOUND	

- Settings: L, 1 ~ 16

NOTE In the PART screen and the MLT screen (explained next), the part that you want to edit can easily be displayed using the PART 1-16 keys on the panel (EX5/7 only).

Bank (Voice Bank)

Selects the Bank which contains the voice you want to use for the part. A different Bank can be selected for each part.

- Settings: P1 (Preset 1), P2 (Preset 2), I1 (Internal 1), I2 (Internal 2)

Number

Selects the voice number that you want to use from within the selected voice bank. When a number is selected here, the selected voice name is displayed to the right of the voice name. A different voice number can be selected for each part.

- Settings: 001 ~ 128 (For information about each voice, see the Voice List in the separate Data List book.)

Volume

Adjusts the volume of each part. These settings let you control the volume balance of each part.

- Settings: 0 ~ 127

Pan

Adjusts the panning position for each part. These settings let you position each part in the stereo spectrum.

- Settings: L63 (far left) ~ cnt (center) ~ R63 (far right)

Out Select (Output Select)

Selects the output for each part. These settings let you send each part to a different output.

- Settings: L&R (OUTPUT L&R), ind1 (INDIVIDUAL OUTPUT1), ind2, ind3, ind4, ind5, ind6, i1&2 (INDIVIDUAL OUTPUT1&2), i3&4, i5&6, Drum

NOTE For example, when “i1&2” is selected, the L channel will be output from INDIVIDUAL OUTPUT1, and the R channel from INDIVIDUAL OUTPUT2.

NOTE EX5 and EX5R are equipped with two Individual Outputs (1 and 2) while EX7 is not equipped with the Individual Output. You can increase/equip the Individual Outputs on your instrument by installing an optional Individual Output Board (EXIDO1). For more information, see page 278.

NOTE When “drum” is selected for the drum voice (part), the drum elements in the drum voice will be output according to the output destinations set for each element in the Output Select (page 146) of the Voice Edit mode.

Detune

Sets the detune value for each part. Detune is effective for making the sound thicker by raising or lowering the pitch of each element in fine increments or decrements in relation to each other.

- Settings: -128 ~ 0 ~ +127

■ MIDI Pan/Vol (MIDI Pan/Volume)

Sets the MIDI Pan/Volume to “on” or “off” when changing to another performance. Pan and Volume are sent to MIDI [OUT] when set to “on,” and are not sent when set to “off.”

❑ **Settings:** on, off

■ Rev Send (Reverb Send)

Sets each part's send level of the signal output from Insertion Effect (or by-passed) and then sent to the Reverb unit.

❑ **Settings:** 0 ~ 127

■ Cho Send (Chorus Send)

Sets each part's send level of the signal output from Insertion Effect (or by-passed) and then sent to the Chorus unit.

❑ **Settings:** 0 ~ 127

■ InsEF Sw (Insertion Effect Switch)

Sets the Insertion Effect unit for each part to “on” or “off.” The Insertion Effect is used when set to “on,” and is not used when set to “off.”

❑ **Settings:** on, off

NOTE The type of Insertion Effect is selected in Voice Edit mode (see page 106).

NOTE If you exceed the DSP limitation (page 54), this switch cannot be turned on. In this case, “DSP resource full” may appear on the screen.

■ Mono/Poly (Monophonic/Polyphonic)

Selects whether the voice is played monophonically (only one note at a time) or polyphonically (multiple notes sounding simultaneously).

❑ **Settings:** mono, poly

■ Key Assign

Selects *sngr* (single) or *mlti* (multi) Key Assign for each part. In *sngr* (single), if the tone generator receives the same note twice, the first note is terminated when the same note is subsequently received. In *mlti* (multi), when the same notes are received, sounds are assigned to one channel after another, making multiple part tone generation possible.

❑ **Settings:** *sngr*, *mlti*

[F5]: LYR (Layer)

Layer parameters are mainly related to MIDI settings including the MIDI channel, Arpeggiator on/off, Note Limit and Velocity for each part. These settings let you control each part's MIDI output.

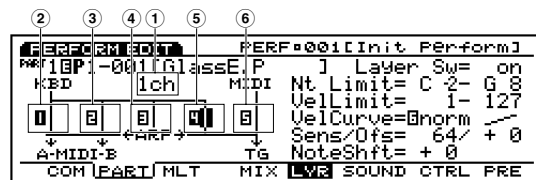

Pressing [F5] Key alternately selects the following two screens.

Select the appropriate screen for setting each parameter as required.

• MIDI Signal Graphical Display

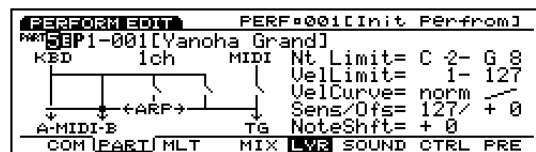

• Note/Velocity Limits Graphical Display



■ Part

■ Bank (Voice Bank)

■ Number

These parameters are the same as those explained in the MIX screen. See page 164.

■ ① MIDI Ch (MIDI Channel)

Sets the MIDI channel for each part.

❑ **Settings:** 1 ~ 16

■ ② ③ Trns MIDI A/B (Transmit to MIDI A/B)

Sets the Trns MIDI A/B to “on” or “off.” MIDI data from the keyboard/controller is sent to each MIDI output (MIDI OUT A/B) when set to “on,” and is not sent when set to “off.”

❑ **Settings:** on, off

NOTE Transmit MIDI Out A/B is available for EX5. In the case of EX5R and EX7, only a set of MIDI Out is available.

■ ④ **ArpeggioSw (Arpeggio Switch)**

Determines whether the currently selected part will be arpeggiated, or not.

❑ **Settings:** on, off

■ ⑤ **Layer Sw (Layer Switch)**

Sets the Layer SW to “on” or “off.” When set to “on” you can play two parts in a layer.

❑ **Settings:** on, off

NOTE When the parts’ Layer Switches are turned on here, you can adjust the overall settings (such as volume and pan) for the parts (page 171).

NOTE The layered sounds being produced may be delayed depending on the voice combination.

■ ⑥ **MIDI to TG (MIDI to Tone Generator)**

When this is set to “on,” the MIDI data input at MIDI IN will be received by the internal tone generator, and when set to “off,” it will not be received.

❑ **Settings:** on, off

About the MIDI Signal Graphical Display

On the left side of the screen is a graphical image that lets you monitor the signal flow, and easily set each of the five switches explained above to “on” or “off.”

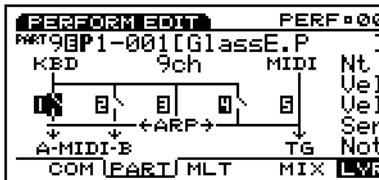

■ **Note Limit L/H (Note Limit Low/High)**

Sets the note range (the lowest and the highest note) on the keyboard for each part. The part will only sound within the keyboard range set here.

❑ **Settings:** Each Low and High (can be set between) C-2 ~ G8

■ **Vel Limit L/H (Vel Limit Low/High)**

Sets the velocity range (the lowest and the highest value) for each part. The part will only sound within the velocity range set here.

❑ **Settings:** Each Low and High (can be set between) 0 ~ 127

NOTE When the Kbd/TG Mode (see page 160) is set to M.KBD Mode, the Note Limit Low/High and the Vel Limit Low/High, are active for the MIDI [OUT] output.

About Note/Velocity Limits Graphical Display

The left side of the screen shows each note range and velocity (note) range for 16 parts, set in the above parameters.



First, move the cursor to the Part number at the top left and select the part you want to set the Note Limit and/or Velocity Limit. Then, move the cursor to the Note Limit L/H and/or Vel Limit L/H, and specify each range. Each time you change the values, the ranges represented by bars will lengthen or shorten, accordingly.

■ **VelCurve (Velocity Curve)**

Sets the Velocity Curve for each part. These settings determine how sound is produced based on the strength at which notes are played on the keyboard. To the right of the set value, the velocity curve is displayed as a graphical image.

❑ **Settings:** norm (normal), soft, hard, wide, fix

norm (normal): The velocity is in proportion to the strength at which the keyboard is played.

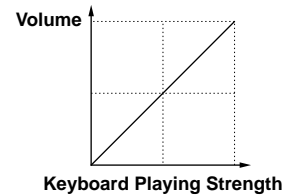

soft: This curve increases the volume level with a softer playing style, and is suitable for players with a light key touch.

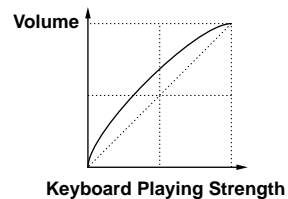

hard: This curve increases the volume level with a stronger playing style, and is suitable for players with a heavy key touch.

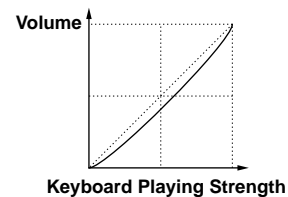

wide: This curve decreases the volume level with a light touch playing and increases the volume level with a heavy touch playing. This lets you produce a wider dynamic range.

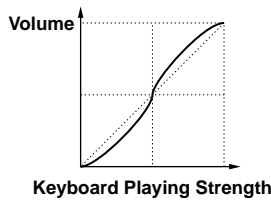

fix: This sets the velocity to a fixed value, and the tone generator will produce sound at that value, regardless of the strength at which the keyboard is played. The fixed value is set in the Vel Sens Value, below.

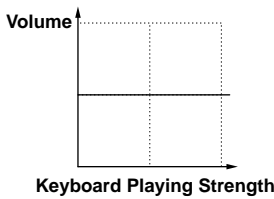

■ **Vel Sens/Ofst (Velocity Sensitivity/Offset)**

Sets the Velocity Sensitivity and Offset values for each part.

□ **Settings:**

Vel Sens (Velocity Sensitivity): 0 ~ 127

Vel Ofst (Velocity Offset): -64 ~ 0 ~ + 63

Vel Sens (Velocity Sensitivity):

As seen in the following graph, the larger the value, the greater the change in volume.

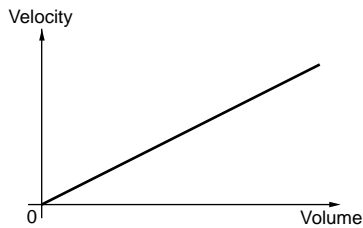

Vel Ofst (Velocity Offset):

As seen in the following graph, the value set here is added to or subtracted from the velocity value.

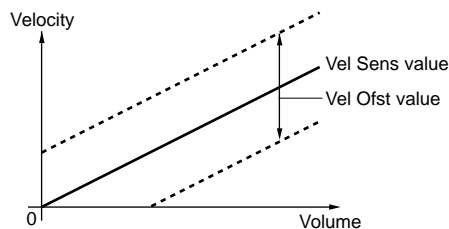

■ **NoteShift**

Transposes the voice pitch of each part in semitones.

□ **Settings:** -24 ~ + 24

[F6]: SOUND

These parameters are mainly related to sound, such as the EG and Portamento. These settings let you determine and control the volume, pitch, and timbre for each part.

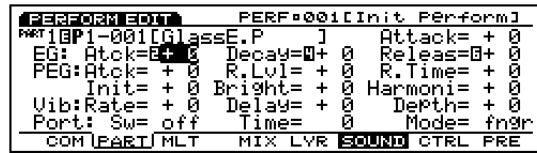

■ **Part**

■ **Bank (Voice Bank)**

■ **Number**

These parameters are the same as those explained in the MIX screen. See page 164.

EG (Envelope Generator)

For setting the EG for each part. The following three parameters let you create the change of the pitch, timbre and volume over time, from when the key is played until it is released.

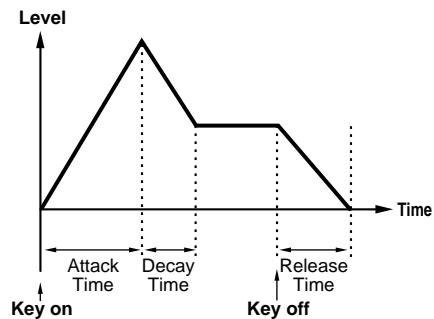

■ **Attack Time**

Sets the amount of time it takes to reach the peak level, from when a note is played. When Attack Time is set to a positive value, the peak is reached more slowly. Negative values cause the peak to be reached more quickly.

□ **Settings:** -64 ~ 0 ~ + 63

■ Decay Time

Sets the amount of time it takes to reach the level set in the Decay Time, from the peak level. When Decay Time is set to a positive value, change occurs more slowly. Negative values cause the change to occur more quickly.

□ **Settings:** -64 ~ 0 ~ +63

NOTE The Decay Time are set for each voice in Voice Edit mode.

■ Release Time

Sets the amount of time it takes for the sound to decay to 0, from when the key is released. When Release Time is set to a positive value, the decay occurs more slowly. Negative values cause the decay to occur more quickly.

□ **Settings:** -64 ~ 0 ~ +63

PEG (Pitch Envelope Generator)

For setting the PEG for each part. The following four parameters let you create the change of the pitch over time, from when the key is played until it is released. The Attack Time and Release Time set here offset the value of the same parameters in the EG in Voice Edit mode.

■ PEG Atck (PEG Attack)

Sets the amount of time it takes to reach the correct pitch, from when a note is played. When Attack Time is set to a positive value, the change is more slowly. Negative values cause change to occur more quickly.

□ **Settings:** -64 ~ 0 ~ +63

■ PEG RelL (PEG Release Level)

Sets the amount of time it takes to reach the last pitch, from when the key is released. When set to a positive value, the pitch is sharp (higher) in relation to the correct pitch. Negative values cause the pitch to change towards a flat (lower) pitch in relation to the correct pitch. A setting of “0” produces a sound that changes to the correct pitch.

□ **Settings:** -64 ~ 0 ~ +63

■ PEG RelT (PEG Release Time)

Sets the amount of time it takes to reach the pitch set in PEG RelL, from when the key is released. When set to a positive value, the change occurs more slowly. Negative values cause the change to occur more quickly.

□ **Settings:** -64 ~ 0 ~ +63

■ PEG Init (PEG Initial)

Sets the initial pitch that is produced when the keyboard is played. When set to a positive value, the pitch is sharp (higher) in relation to the correct pitch. Negative values cause the pitch to be flat (lower) in relation to the correct pitch. A setting of “0” produces the correct pitch.

□ **Settings:** -64 ~ 0 ~ +63

■ Bright

Adjusts the cutoff frequency for the filter that is set for the voice. The values 0 ~ 127 are converted to -64 ~ 0 ~ +63, and added to the original voice data.

□ **Settings:** -64 ~ 0 ~ +63

■ Harmonic

Adjusts the filter resonance that is set for the voice. The values 0 ~ 127 are converted to -64 ~ 0 ~ +63, and added to the original voice data.

□ **Settings:** -64 ~ 0 ~ +63

Vib (Vibrato)

Settings related to the vibrato effect for each part. The following three parameters let you create the vibrato effect.

■ VibRate (Vibrato Rate)

Sets the speed of the vibrato effect. The larger the value, the faster the vibrato movement.

□ **Settings:** -64 ~ 0 ~ +63

■ VibDelay (Vibrato Delay)

Sets the delay time, from when the keyboard is played to when the vibrato effect begins. The larger the value, the longer the delay time before the vibrato effect begins. Negative values cause the delay time to be shorter.

□ **Settings:** -64 ~ 0 ~ +63

■ VibDepth (Vibrato Depth)

Sets the depth of the vibrato. The larger the value, the deeper the vibrato.

□ **Settings:** -64 ~ 0 ~ +63

Port (Portamento)

Settings related to the Portamento effect of each part. The following three parameters are available.

■ Port Sw (Portamento Switch)

Turns the portamento “on” and “off.” Portamento creates a smooth glide in pitch from one note to the next.

❑ **Settings:** off, on

■ Port Time (Portamento Time)

Sets the time of the pitch glide between successively played notes. Higher settings result in a longer (slower) glide.

❑ **Settings:** 0 ~ 127

■ Port Mode (Portamento Mode)

Selects the Portamento mode. The way the Portamento moves will differ depending on whether the Mono or Poly setting (page 165) in the MIX screen is selected.

❑ **Settings:** fngr (fingered), full

When “Mono” is selected in the Mix menu:

fngr (fingered): Fingered portamento is applied only when you play legato (playing a note before releasing the previous one).

full: Portamento is always applied.

When “Poly” is selected in the Mix menu:

Same as for the mono (monophonic) mode except that portamento is applied to multiple notes.

[F7]: CTRL (Controllers)

A variety of control functions can be assigned beforehand to a controller such as the CONTROL Knobs on the front panel or the keyboard. For example, aftertouch of the keyboard can be assigned to control vibrato or the [MODULATION] wheel can be assigned to apply resonance. The control functions can be assigned to affect a specific element in a voice for each part. The assignment of controls to a voice is called voice control, and a maximum of 16 different types of voice controls can be assigned to one voice.

NOTE Excluding the master keyboard settings, the voice control settings made here are the same as those explained in SET (Controller Set) menu in Voice Edit (see page 104). Only the content sections that differ from the SET will be explained below.

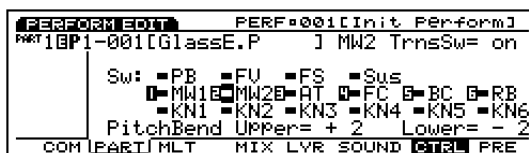

■ Part

■ Bank (Voice Bank)

■ Number

These parameters are the same as those explained in the MIX screen. See page 164.

■ Trns Sw (Transmission Switch)

Selects the necessary controllers to perform as a master keyboard in Performance mode. Set the controllers that you want to use to “on.” There are 16 types of controllers, and you can select whether or not to output.

❑ **Settings:** PB (Pitch Bend Wheel), FV (Foot Volume), FS (Foot Switch), Sus (Sustain), AT (After Touch), FC (Foot Controller), BC (Breath Controller), RB (Ribbon Controller), MW1 (Modulation Wheel 1), MW2 (Modulation Wheel 2), KN1 ~ 6 (Knobs1-6); for each controller, on, off

■ Pitch Bend Upper

Sets the degree of pitch change in semitones (half steps) when the [PITCH] wheel is moved in an upwards direction. For example, a value of +12 means that when the [PITCH] wheel is moved upwards, the pitch can be raised to a maximum of one octave.

❑ **Settings:** -48 ~ 0 ~ +24

■ Pitch Bend Lower

Sets the degree of pitch change in semitones (half steps) when the [PITCH] wheel is moved in a downwards direction. For example, a value of -12 means that when the [PITCH] wheel is moved downwards, you can lower the pitch a maximum of one octave.

❑ **Settings:** -48 ~ 0 ~ +24

[F8]: PRE (Preset)

Settings related to the preset values and MIDI matters applied to the tone generator for each part.

PERFORM EDIT		PERF=001 Init Perform										
PART	IBP1-001	IGlassE.P	PC To MIDI=off								PB=0 64	
Bank/PC:MD=0001		006300000001										
TG=	off	MD=	off	MW1	MW2	AT	FC	BC	RC	RB		
Controller	---	0	64	0	127	0	64					
TG=	off	MD=	off	KN1	KN2	KN3	KN4	KN5	KN6			
Knob	-----	64	64	64	64	64	64	64	64	64	64	
COM		PART	MLT	MIX	LVR	SOUND	CTRL	PRE				

■ Part

■ Bank (Voice Bank)

■ Number

These parameters are the same as those explained in the MIX screen. See page 164.

Bank/PC:MD (Bank/Program Change: MIDI)

Sets the program change and bank select messages that are sent to an external MIDI device when making bank/program changes on the front panel of the EX5/5R/7. A different value can be set for each part.

■ PC To MIDI

Sets whether or not the program change and bank select messages are sent to an external MIDI device. When set to “on” messages are sent, and when set to “off” messages are not sent.

Settings: off, on

■ MD BankMSB (MIDI Bank Select MSB)

Sets the bank select MSB messages that are sent to an external MIDI device when making bank/program changes.

Settings: 000 ~ 127

■ MD BankLSB (MIDI Bank Select LSB)

Sets the bank select LSB messages that are sent to an external MIDI device when making bank/program changes.

Settings: 000 ~ 127

NOTE Bank Select messages are MIDI messages used to change a voice bank. With the combination of the two Bank Select MSB and LSB control change messages, a single voice bank can be specified. Available banks and control change numbers will differ depending on the tone generator that is used. For more information, refer to the Owner’s Manual for each tone generator that is in use.

■ MIDI PC (MIDI Program Change)

Sets the MIDI program numbers sent to an external MIDI device when making bank/program changes.

Settings: 001 ~ 128

NOTE Note that the program numbers are 001 ~ 128, but the actual MIDI program change numbers range from 0 ~ 127. Therefore, keep in mind that the numbers are shifted by one.

Controller

■ InitVal PB (Initial Value Pitch Bend)

Sets the preset value for the pitch bend for a part.

Settings: 0 ~ 127

■ Ctrl To TG (Controller To Tone Generator)

When making bank/program changes, this sets whether or not the preset values for the six controllers below (AT, FC, BC, RC, MW1, MW2) are sent to the internal tone generator. When set to “on” they are sent, and when set to “off” they are not sent.

Settings: off, on

■ Ctrl To MIDI (Controller To MIDI)

When making bank/program changes, this sets whether or not the preset values for the six controllers below (AT, FC, BC, RC, MW1, MW2) are sent to an external MIDI device. When set to “on” they are sent, and when set to “off” they are not sent.

Settings: off, on

■ InitVal MW1/MW2/AT/FC/BC/RB (Initial Values)

Sets the control change preset values that are sent by each controller.

Settings: Each of the following devices can be set from 0 ~ 127: AT (After Touch), FC (Foot Controller), BC (Breath Controller), RB (Ribbon Controller), MW1 (Modulation Wheel 1), MW2 (Modulation Wheel 2)

Knob

■ Knob To TG (Knob To Tone Generator)

When making bank/program changes, this sets whether or not the preset values for Knobs 1-6 are sent to the tone generator. When set to “on” the messages are sent, and when set to “off” they are not sent.

Settings: off, on

■ Knob To MIDI

When making bank/program changes, this sets whether or not the preset values for Knobs 1-6 are sent to an external MIDI device. When set to “on” the messages are sent, and when set to “off” they are not sent.

Settings: off, on

■ InitVal KN1 ~ 6 (Initial Values KN1 ~ 6)

Sets the control change preset values that are sent by the Knobs 1-6.

Settings: Each of the Knobs 1-6 can be set from 0 ~ 127

NOTE The contents of the control change for each controller and Knobs 1-6 are designated in the CTRL screen.

Auditioning the Settings Done in the Preset Menu

The EX will output the parameter settings done in the preset menu when you press [ENTER] key while holding [SHIFT] key. You can audition the results.

[F3]: MLT (Multi)

Setting the parameters for each part in each Performances is achieved in the chart. Various parts can be displayed simultaneously and each can be edited. Available parameters are the same as for those explained for the PART screen, page 164.

When the MLT menu is selected with [F3], the following five types of category menus are displayed. You can easily scroll through the list and select the desired parameter using the [F4] ~ [F8] keys.

- [F4]: MIX (Settings related to MIX)
- [F5]: LYR (Settings related to Layers)
- [F6]: SOUND (Settings related to Sound)
- [F7]: CTRL (Settings related to the Controllers)
- [F8]: PRE (Settings related to the Presets)

Each time [F3] is pressed the Part section changes to show the Part 1 ~ 4, Part 5 ~ 10 and Part 11 ~ 16, alternately.

Lyr ~ Part 1 ~ 4

PERFORM EDIT		PERF#001[Init Perfrom]					
PART 1[P1-001[Yanoha Grand]		Bank=P1					
	Lyr	1:Pf	2:Pf	3:Pf	4:Pf		
Bank		P1	P1	P1	P1	P1	
Number		001	001	001	001	001	
Volume	127	127	127	127	127	127	
Pan	cnt	cnt	cnt	cnt	cnt	cnt	
COM PART MLT		MIX LYR SOUND CTRL PRE					

F3



Part 5 ~ 10

PERFORM EDIT		PERF#001[Init Perfrom]					
PART 7[P1-001[Yanoha Grand]		Bank=P1					
	Lyr	5:Pf	6:Pf	7:Pf	8:Pf	9:Pf	
Bank		P1	P1	P1	P1	P1	
Number		001	001	001	001	001	
Volume	127	127	127	127	127	127	
Pan	cnt	cnt	cnt	cnt	cnt	cnt	
COM PART MLT		MIX LYR SOUND CTRL PRE					

F3



Part 11 ~ 16

PERFORM EDIT		PERF#001[Init Perfrom]					
PART 13[P1-001[Yanoha Grand]		Bank=P1					
	Lyr	11:Pf	12:Pf	13:Pf	14:Pf	15:Pf	
Bank		P1	P1	P1	P1	P1	
Number		001	001	001	001	001	
Volume	127	127	127	127	127	127	
Pan	cnt	cnt	cnt	cnt	cnt	cnt	
COM PART MLT		MIX LYR SOUND CTRL PRE					

F3



“Lyr” column allows you to adjust the overall settings (such as volume and pan) for the parts which “Layer Switches” (LYR menu) are turned on. You can adjust each setting with the relative values among the balance of the parts kept.

NOTE In the MLT screen, you can directly select the Part that you want to edit by using the PART keys 1-16 on the panel (EX5/7).

The available parameters are listed below. For information about each parameter’s contents and available values, see the explanation for the PART screen (page 164).

	Lyr	1: Pf	2: Pf	3: Pf	14: Pf	15: Pf	16: Pf
Bank		P1	P1	P1	P1	P1	P1
Number		001	001	001	001	001	001
Volume	100	100	100	100	100	100	100
Pan	cnt	cnt	cnt	cnt	cnt	cnt	cnt
Rev Send	40	40	40	40	40	40	40
Cho Send	0	0	0	0	0	0	0
InsEF Sw		off	off	off	off	off	off
Out Sel		L&R	L&R	L&R	L&R	L&R	L&R
Detune	+0	+0	+0	+0	+0	+0	+0
MonoPoly	poly	poly	poly	poly	poly	poly	poly
KeyAssign		miti	miti	miti	miti	miti	miti
MDPanVol		off	off	off	off	off	off
Layer Sw		on	on	on	on	on	on
Nt Lmt L		C-2	C-2	C-2	C-2	C-2	C-2
Nt Lmt H		G8	G8	G8	G8	G8	G8
VelLmt L		1	1	1	1	1	1
VelLmt H		127	127	127	127	127	127
NoteShft		+0	+0	+0	+0	+0	+0
Vel Sens		64	64	64	64	64	64
Vel Crve		norm	norm	norm	norm	norm	norm
Vel Ofst		+0	+0	+0	+0	+0	+0
Arpeggio		on	on	on	on	on	on
Tx MIDIA		on	on	on	on	on	on
Tx MIDIB		on	on	on	on	on	on
MIDItTG		on	on	on	on	on	on
MIDI Ch		1	2	3	14	15	16
Bright	+0	+0	+0	+0	+0	+0	+0
Harmonic	+0	+0	+0	+0	+0	+0	+0
Attack	+0	+0	+0	+0	+0	+0	+0
Decay	+0	+0	+0	+0	+0	+0	+0
Release	+0	+0	+0	+0	+0	+0	+0
Vib Rate	+0	+0	+0	+0	+0	+0	+0
VibDelay	+0	+0	+0	+0	+0	+0	+0
VibDepth	+0	+0	+0	+0	+0	+0	+0
PEG Init	+0	+0	+0	+0	+0	+0	+0
PEG Atck	+0	+0	+0	+0	+0	+0	+0
PEG RelL	+0	+0	+0	+0	+0	+0	+0
PEG RelH	+0	+0	+0	+0	+0	+0	+0
PortSw	off	off	off	off	off	off	off
PortTime	0	0	0	0	0	0	0
PortMode		fngr	fngr	fngr	fngr	fngr	fngr
PB Upper		+2	+2	+2	+2	+2	+2
PB Lower		-2	-2	-2	-2	-2	-2
PB Trns		on	on	on	on	on	on
RB Trns		on	on	on	on	on	on
MW1 Trns		on	on	on	on	on	on
MW2 Trns		on	on	on	on	on	on
KN1 Trns		on	on	on	on	on	on
KN2 Trns		on	on	on	on	on	on
KN3 Trns		on	on	on	on	on	on
KN4 Trns		on	on	on	on	on	on
KN5 Trns		on	on	on	on	on	on
KN6 Trns		on	on	on	on	on	on
AT Trns		on	on	on	on	on	on
FC Trns		on	on	on	on	on	on
BC Trns		on	on	on	on	on	on
Sus Trns		on	on	on	on	on	on
FS Trns		on	on	on	on	on	on
FV Trns		off	off	off	off	off	off
CtrlToMD		off	off	off	off	off	off
CtrlToTG		off	off	off	off	off	off
KnobToMD		off	off	off	off	off	off
KnobToTG		off	off	off	off	off	off
PC toMD		off	off	off	off	off	off
Bank MSB		063	063	063	063	063	063
Bank LSB		000	000	000	000	000	000
MIDI PC		001	001	001	001	001	001
Init PB		64	64	64	64	64	64
Init MW1		0	0	0	0	0	0
Init MW2		64	64	64	64	64	64
Init AT		0	0	0	0	0	0
Init FC		127	127	127	127	127	127
Init BC		0	0	0	0	0	0
Init RB		64	64	64	64	64	64
Init KN1		64	64	64	64	64	64
Init KN2		64	64	64	64	64	64
Init KN3		64	64	64	64	64	64
Init KN4		64	64	64	64	64	64
Init KN5		64	64	64	64	64	64
Init KN6		64	64	64	64	64	64

Performance Job Mode

These jobs let you initialize, recall or copy performances that were created in Performance Edit mode (or are being edited).

Press [JOB] key on the panel while in Performance mode to enter Performance Job mode. When you enter the Performance Job mode, the following menu will be displayed. There are two types of jobs in Performance Job mode. Press [F1] (INIT), [F2] (RECL), or [F3] (COPY) to select a job.

NOTE It is necessary to first select the performance that will be initialized, recalled or copied, before entering the Performance Job mode (See page 172).

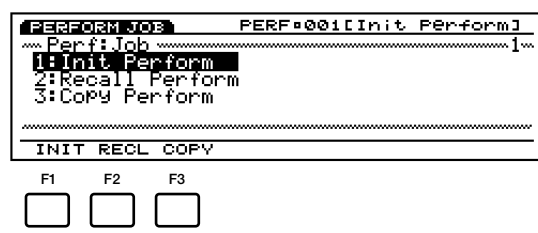

- [F1]: INIT (Initialize)
- [F2]: RECL(Recall)
- [F2]: COPY (Copy)

Steps for Executing a Job

- 1 When in the Performance Play mode, select the performance number you want to execute job operation.
- 2 Press [JOB] to enter the Performance Job mode.
- 3 Press [F1] (INIT), [F2] (RECL), or [F3] (COPY) to select a job to execute. The selected job screen will be displayed.

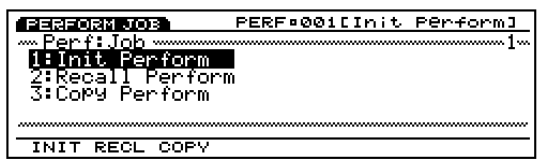

NOTE You can also select each job by moving the cursor to the desired job name on the screen and pressing [ENTER].

- 4 Move the cursor to a parameter and use the [INC]/[DEC], Data dial, numeric keypad, or the Knobs 1 ~ 6 to set values.

NOTE This operation is not necessary for Initialize and Recall.

- 5 Press [ENTER]. The following pop-up menu will appear, prompting confirmation of the operation.



- 6 Press [YES] to execute the job. “Completed!” will momentarily appear in the screen indicating that the job was executed and the previous screen will be displayed.

Press [NO] to cancel the job.

NOTE “Executing...” will appear when the Performance Job takes some time to execute. Take note that if the power is turned off while “Executing...” is displayed, the data may be destroyed.

- 7 Press [EXIT] twice to exit the Performance Job mode and return to the Performance Play mode.

[F1]: Init Perform (Initialize Performance)

This job lets you call up the initial values for each performance (to initialize). Initializing should be used before editing, for example when creating an original performance from scratch.

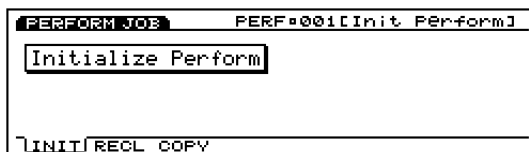

[F2]: Recall Perform (Recall Performance)

Without storing a performance while editing, if you select another performance, the previous performance’s edit data will be lost. The Recall job makes it possible to return to the original data that was being edited, even after selecting another performance.

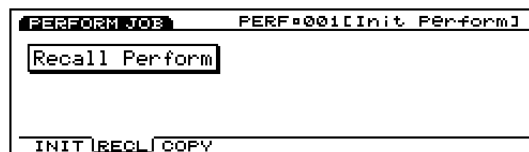

NOTE Even after turning the power “off” and “on,” you can still return to the data that was being edited.

[F3]: Copy Perform (Copy Performance)

This job lets you copy the common data of a performance and the specific data of a specified part to the currently selected performance. This job is convenient for utilizing a portion of a performance’s data, in the creation of another performance.

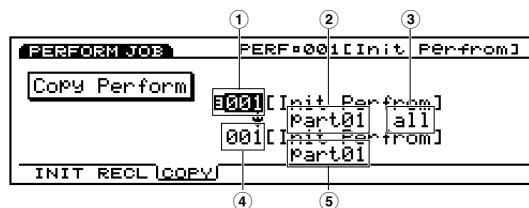

NOTE This job is not for copying a performance as is to internal memory. Instead, this job copies the different parameter values for the one performance to the edit buffer of another performance.

1 Source Performance Number

Sets the source performance number that will be copied from.

Settings: 001 ~ 128

2 Source Part

Sets the source performance part that will be copied from. When copying data that is common to all parts, select Common.

Settings: Common (All parts), PART01 (Part 1) ~ PART16 (Part 16)

■ ③ Types of Source Data

Selects the type of data that will be copied. It is possible to designate common data that affects all of the parts, and specific data for specified parts.

When Common (All parts) is selected for the Source Part:

ALL (All performance data), PARAM (Parameter settings), ARP (Arpeggio settings), EFCT (Effect settings), CTRL (Controller settings), NAME (Performance name)

When PART01 ~ 16 is selected for the Source Part:

ALL (All the data for that part), MIX (Mix settings), LAYER (Layer settings), SOUND (Sound settings), CTRL (Controller settings), PRE (Preset settings)

■ ④ Destination Performance Number

Fixed to the currently selected (destination) performance.

NOTE It is necessary to select the destination performance in Performance Play mode before entering the Performance Job mode.

■ ⑤ Destination Part

Sets the destination performance part that will be copied to. This parameter is displayed only when a part is selected in the Source Part parameter.

□ **Settings:** PART01 ~ 16

Sample Mode

Sample Play Mode

This mode lets you select a sample and play it back. You can also enter the Sample Record mode from the Sample Play mode and execute sampling sounds. The internal memory can record up to a maximum of 1024 different samples. Also, for organizing your samples after they have been recorded, they can be stored to floppy disk so that you can make use of them whenever you like.

NOTE For more information about the sampling basics, see page 69.

Press [SAMPLE] key on the panel to enter Sample Play mode. When you enter the Sample Play mode, the following menu screen will be displayed. You can select a sample number to play back. You can also perform sampling by Pressing [F8] (REC) to enter the Sample Record mode.

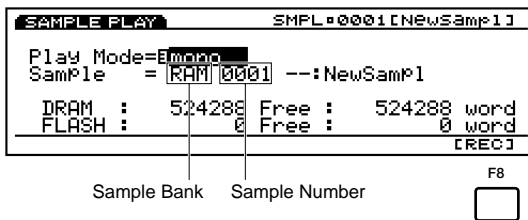

NOTE At the bottom of the screen, the total memory capacities (left) and available memories (right) of DRAM and FLASH are displayed in the unit of words. 1 word is equivalent to 2 bytes, or 16 bits. Accordingly, the total memory capacity of DRAM or FLASH are the half of the one for the DRAM SIMM or Flash Memory you installed.

■ Play Mode

Sets the sample playback mode. There is “stereo” and “mono” (monaural). When “stereo” mode is selected, the sample bank/numbers for two channels, L (left) and R (right) will be displayed. When “mono” mode is selected, only one sample bank/number will be displayed.

Settings: stereo, mono

■ Sample Bank

Sets the bank that contains the sample you want to play. When “stereo” is selected, you can set a different sample bank for the L (left channel) and the R (right channel). Although “FLASH” can be selected, the selection is not effective unless you install the Flash Memory Board EXFLM1 to your EX5/5R/7.

Settings: RAM, FLASH

NOTE Settings: The EX5/5R/7 contains 1MB of DRAM when shipped from the factory. Installing a pair of 72 PIN DRAM SIMMs can increase the internal memory to a maximum of 65MB (including the original internal 1MB).

NOTE The internal DRAM (including the DRAM SIMM) is volatile, and all the data is erased when the power is turned off. Thus, when you turn the power back to on, no sample is available in the internal memory.

■ Sample Number

Sets the sample that you want to play. When “stereo” is selected, you can set a different sample bank for the L (left channel) and the R (right channel).

Settings: 1 ~ 1024

NOTE Although the sample numbers go to 1024, the amount of recordable data depends on the available memory. When the available memory has been consumed, recording will stop. Therefore although 1024 sample numbers are displayed, this does not necessarily mean that all the numbers contain sample data and can be played back.

NOTE The EX5/5R/7 can load and play back the WAV, AIFF and AKAI format files. For more information on loading files, see page 265.

NOTE When you play back the sample having short loop length in the high register (or after raised its pitch using transpose function), noises may be reproduced. In this case set the loop length (page 180) longer.

NOTE The sample having the end point (page 180) at the data end may produce some noise when it is played back in loop. In this case try to change the loop length.

Sample Record Mode

Sampling takes place in the Sample Record mode. Connect an external microphone to the EX5/5R/7 to record (sample) a sound, then that sound can be performed as an instrument. In addition, the sampled sound can be re-sampled after processing the sound with applying various effects (re-sampling function). You can play the sampled sounds by assigning them to any note on the keyboard (keymap). In addition, you can use the Wave Edit function (page 150) to make up a wave and play it as an AWM voice. (It is necessary to use an external MIDI keyboard to perform the sample with the EX5R.) Also, for organizing your samples after they have been recorded, they can be stored to floppy disk so that you can make use of them whenever you like.

NOTE The recorded samples can be saved in the EX original file format to floppy disk or an external SCSI device, such as a hard disk drive. For more information on saving files, see page 263.

How to Enter the Sample Record Mode

When in the Sample Play mode, press [F8] (REC) to enter the Sample Record mode. The [F8] function key will change to “STANDBY” and the following screen will be displayed.

Press [EXIT] to return to Sample Play mode.

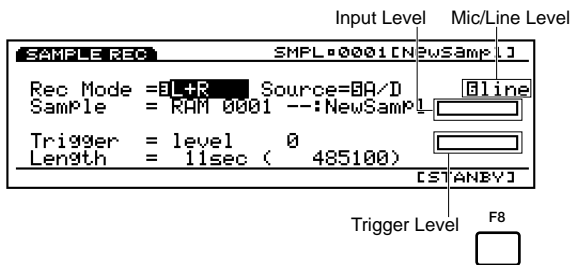

■ Rec Mode (Record Mode)

Sets the Sample Record mode. There are the following selections: L (left channel record mode), R (right channel record mode), mono (monaural record mode), and stereo (stereo record mode [only available for the EX5/5R]).

□ **Settings:** L, R, mono, stereo(EX5/5R only)

NOTE On the EX7, when “A/D” is selected in the Source(next explained), “mono” is automatically set as the recording mode.

■ Source

Selects the recording source. When sampling, for example, with a microphone connected to the A/D INPUT jack(s), select “A/D” (Analog/Digital). When “A/D” is selected, the input level bars for each channel will be displayed according to the selected record mode.

If you plan to re-sample a sample from internal memory, select “Internal.” When “Internal” is selected, the level bars are not displayed.

□ **Settings:** A/D, Internal

■ Mic/Line Level

Set the input level for the A/D INPUT jack(s) (only when “A/D” is selected above). When a microphone is connected, select Mic (Mic Level) and when an audio device such as a CD player is connected, select Line (Line Level).

□ **Settings:** Line, Mic

■ Input Level Bar

When A/D is selected as the recording source, the input level bars for each channel will be displayed according to the selected record mode. As you watch the movement of the bars, you can confirm the input levels of an external device, and you can use it as a guide when adjusting the levels.

■ Trigger

Sets the trigger method (how sampling will be triggered) for sampling. The type of trigger method that is available will differ depending on the currently selected record source.

When “A/D” is set as the record source, you can select either “manual” or “level.” When “manual” is selected, you can start sampling whenever you like by pressing the [F8: START] key. When “level” is selected, sampling automatically begins when the input level passes the designated value (trigger level). If you select “level” here, the value parameter is added to the screen, and a specified trigger level can be set with this parameter.

When “Internal” is set as the record source, you can select either “key” or “seq” (sequencer). When “key” is selected, you can start sampling by pressing a key on the keyboard. When “seq” is selected, sampling automatically begins simultaneously when a song/pattern playback is begun.

□ **Settings:**

When “A/D” is selected as the Source: manual, level

When “Internal” is selected as the Source: key, seq

■ Trigger Level

When “level” is selected as the trigger method, this parameter will be displayed. This parameter sets the trigger level at which sampling begins. When the input signal through A/D INPUT jack(s) passes the set value (trigger level), sampling automatically begins. When setting the trigger level, you can see the value level move in the level bar as you adjust the level. In this way you can compare the starting trigger value with the input level bar, to confirm the level at which sampling will begin.

□ **Settings:** 0 ~ 127

■ Length

This parameter displays the available sampling time (recording time). The time is displayed both in seconds and words. The value set here determines the length (amount of time) that the sample is recorded.

□ **Settings:** The length will differ depending on the amount of DRAM and FLASH memory capacity. When shipped from the factory, the EX5/5R/7 contains 1MB of DRAM and this provides for about 12 seconds of monaural recording.

Steps for Sampling 1 (Sampling from an external device such as a microphone)

First connect the microphone or audio device that you will use in sampling to the A/D INPUT jack(s) (page 14).

- 1 When in the Sample Play mode, press [F8] (REC) to enter the Sample Record mode.
- 2 Set desired record mode and select “A/D” for the Source.
- 3 Set the parameter to the right of Source to “Mic” or “Line” depending on the type of the input signal level. When a microphone is connected, select Mic (Mic Level). When an audio device such as a CD player is connected, select Line (Line Level).
- 4 Adjust the input gain with the [A/D GAIN] knob on the front panel.
- 5 Set the trigger method in the Trigger parameter. When “level” is selected, continue by setting the trigger level.
- 6 Confirm the available sampling time (recording time) in the Length parameter. (If necessary,) set the length of the sampling.

- 7 Check the input level of the microphone or audio device with the input level bar(s).

NOTE For setting the destination sample bank/number, (even when FLS is selected for the sample bank in the Sample Play mode) an empty DRAM sample number is automatically selected. Therefore it is not necessary to select a sample number.

- 8 Press [F8] (STANDBY) to engage sampling standby status, and “Waiting...” will be displayed in the screen.

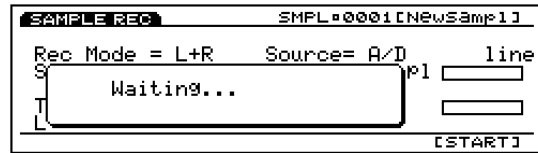

- 9 Start sampling using the trigger method specified in step 5 above.

When “manual” is selected:

Press [F8] (START) to begin sampling.

When “level” is selected:

When the input signal from a microphone, for example, passes the set value (trigger level), sampling automatically begins.

When sampling is underway, “Now Recording...” is displayed.

- 10 Press [F8] (STOP) to stop sampling. The sampled bank/number will be displayed.

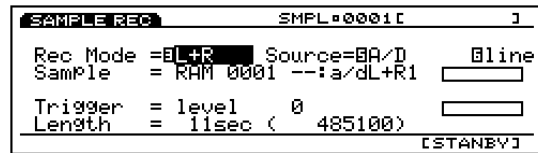

NOTE If the set length of the sample is reached before you press [F8] (STOP), sampling will automatically stop.

- 11 Press [EXIT] to return to the Sample Play mode and you can audition the newly recorded sample.
- 12 To execute another sampling, repeat the above steps 1 ~ 11.

NOTE When the power is turned off, the data in the internal memory is erased. Remember to save important sample data to floppy disk or an external storage device (page 259).

NOTE You can edit the sampled data using the sample edit function in the Sample Edit mode and the copy function in the Sample Job mode. Also, in the Voice Edit mode (page 76) you can use the sampled data as an element/wave in creating your original voice. Furthermore, you can assign the sampled data to each key (keymap function on page 72) and play them on the keyboard.

Steps for Sampling 2 (Re-sampling from the internal tone generator/memory)

You can re-sample a previously recorded sample or a preset wave, as well as a song/pattern phrase.

NOTE When re-sampling the previously recorded sample, you must first edit it in the Sample Edit mode, and use it as an element/wave for an internal voice in the Voice Edit mode (page 76), then store the internal voice in memory.

- In the Voice Play mode, select a voice that you want to sample. Or in the case when you sample a song/pattern phrase, first perform the necessary operations to prepare the phrase for playback (for example, selecting a performance for song/pattern or pattern number).

Example 1:

When sampling a voice (select the voice number in the Voice Play mode)

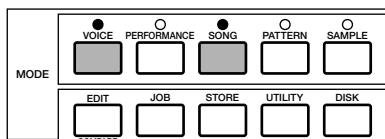

Example 2:

When sampling a pattern (select a pattern number in the Pattern Play mode, and select a performance for the pattern in the Performance Play mode)

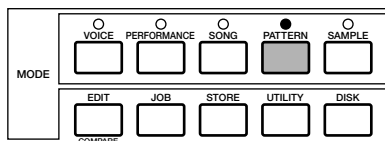

- Enter the Sample Play mode, and press [F8] (REC) to enter the Sample Record mode.
- Set desired record mode and select “Internal” for the Source.
- Set the trigger method in the Trigger parameter. When sampling a voice that you play on the keyboard, select “key,” or when sampling a song/pattern phrase, select “seq.”
- Confirm the available sampling time (recording time) in the Length parameter. (If necessary,) set the length of the sampling.

NOTE For setting the destination sample bank/number, (even when FLS is selected for the sample bank in the Sample Play mode) an empty DRAM sample number is automatically selected. Therefore it is not necessary to select a sample number.

- Press [F8] (STANDBY) to engage sampling standby status, and “Waiting...” will be displayed in the screen.
- Start sampling using the trigger method specified in step 4 above.

When “key” is selected:

Press any key on the keyboard to begin sampling.

When “seq” is selected:

Press the sequencer [PLAY] key to begin sampling.

When sampling is underway, “Now Recording...” is displayed.

- Press [F8] (STOP) to stop sampling. The sampled bank/number will be displayed.

NOTE If the set length of the sample is reached before you press [F8] (STOP), sampling will automatically stop.

- Press [EXIT] to return to the Sample Play mode and you can audition the newly recorded sample.

- To execute another sampling, repeat the above steps 1 ~ 9.

NOTE You can edit the sampled data using the sample edit function in the Sample Edit mode and the copy function in the Sample Job mode. Also, in the Voice Edit mode (page 76) you can use the sampled data as an element/wave in creating your original voice. Furthermore, you can assign the sampled data to each key (keymap function on page 72) and play them on the keyboard.

NOTE Samples are recorded into the DRAM of the internal memory. However, the recorded samples can be transferred to FLS (optional Flash Memory Board EXFLM1; if it is properly installed) using the Copy Sample function in the Sample Job mode. Once the recorded or edited samples are transferred to the EXFLM1, the samples can be used the same as preset waves (the data is not erased when the power is turned off).

NOTE When the power is turned off, the data in the internal memory is erased. Remember to save important sample data to floppy disk or an external storage device (page 259).

Sample Edit Mode

In the Sample Edit mode, you can edit samples recorded in the Sample Record mode to put them into the final form as you like.

Press [EDIT] key on the panel while in Sample mode to enter Sample Edit mode. You cannot enter Sample Edit mode, if the targeted sample number (in RAM bank) contains no data. When you enter the Sample Edit mode, the following sub menu below will be displayed. There are the next three types of settings available. Press [F6] ~ [F8] to select the necessary menu.

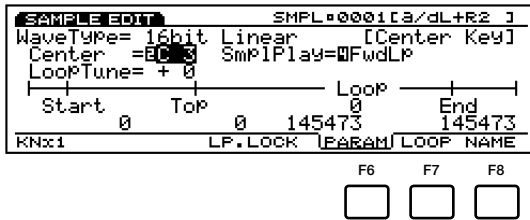

- [F6]: PARAM (Settings related to playing back samples)
- [F7]: LOOP (Settings related to the sample loop)
- [F8]: NAME (Settings for naming samples)

NOTE In the [F6]: PARAM and [F7]: LOOP screens, [F1]: KNx*(Knob x [unit]) and [F4]: LP. LOCK (Loop Lock) will be added. In the [F7]: LOOP screen, [F3]: ZOOM* will also be added. For the information about each item see the respective explanations below.

NOTE Before entering the Sample Edit mode, it is first necessary to select the sample that you want to edit in Sample Play mode (page 175). All parameters can be applied to each sample. After you have finished editing, remember to save to floppy disk or an external storage device.

NOTE When the power is turned off, the data in the internal memory is erased. Remember to save important sample data to floppy disk or an external storage device (page 259).

NOTE The sample recorded as stereo data can be edited in stereo. However, if you combine and set the different two samples as L/R data, you cannot enter Sample Edit mode.

[F6]: PARAM (Parameter)

There are various parameters for setting the most basic aspects of sample playback, such as setting the wave Start/End point as well as how the sample will sound.

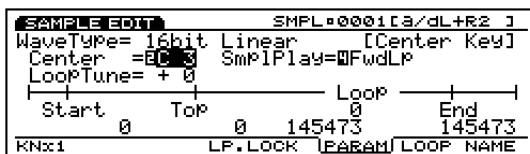

Wave Type

Displays the sample wave type. The sampling frequency for a sample recorded on the EX5/5R/7 is fixed at 16 bit linear/44.1 KHz.

NOTE The EX5/5R/7 can load and play back the WAV, AKAI and AIFF format files. In this case, a wave type other than 16 bit linear/ 44.1KHz such as 12 bit linear, 8 bit linear and 8 bit LPC (compressed) may be displayed.

NOTE For more information on loading sample files, see page 263.

Center key

Assigns the original pitch of the sample to a key on the keyboard. Using this assigned key as the center pitch, you can raise or lower the pitch in semitones and play back the sample.

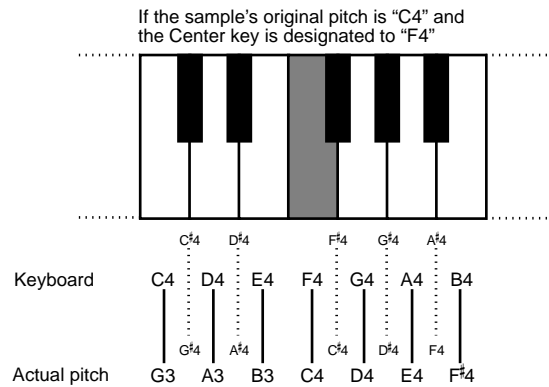

Settings: C-2 ~ G8

LoopTune

Finely adjusts the pitch of the loop section for playback.

Settings: -63 ~ 0 ~ + 63

SmplPlay (Sample Play)

Switches how the sample is played back. There are four choices: "FwdLp," "FwdLpEx," "FwdNoLp" or "RevNoLp."

Settings:

FwdLp:

While a key is pressed (held down), the sample playback begins from the Start point, moves to the Top point and then repeats continuously from the Top point to the End point.

FwdNoLp:

Each time a key is played, the sample will play back one time from the Start point to the End point.

RevNoLp:

Each time a key is played, the sample will play back in reverse one time, from the End point to the Start point.

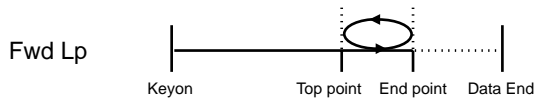

Plays back repeatedly until you release the key.

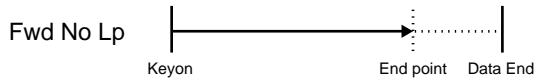

Plays back one time.

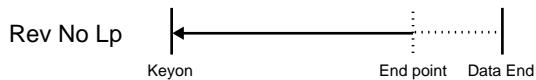

Plays back in reverse one time.

About the Unit of the Sample Playback Parameters

If you change the following sample playback parameters using the Data Dial or [INC]/[DEC] keys, it may take some time for you since the parameter value is too large. In such cases, press [F1]: $KN \times (\text{Knob} \times \text{Unit})$ to change the unit to 10, 100, 1000 or 10000 and use the related knobs to adjust the values. For example, use the unit of 1000 to roughly search the figure and use the unit of 10 or 1 to finely determine the position or length.

Wave Start

Sets the Start point for the sample playback. As seen in the next diagram, the Start point can be set to remove unwanted noise that exists before that point in the sample.

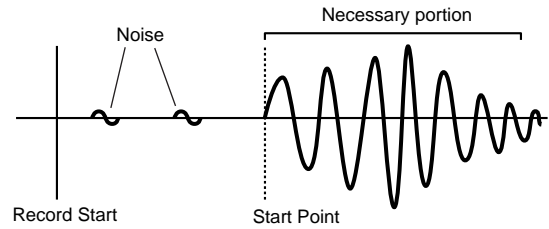

□ **Settings:** Differs depending on the sample length

Loop Top

Sets the Top point of the loop playback (the point where the loop begins) within the range of the entire sample. For example, when setting a loop for the sustained sound of a violin, the Top and End point is usually set after the attack portion of the sound. In this way, the sample playback begins from the attack portion which determines the characteristics of the violin, and repeats basically the same sustained portion of the sound. For the sounds which don't have distinctive attack portion, you can leave this parameter the same as the Start point.

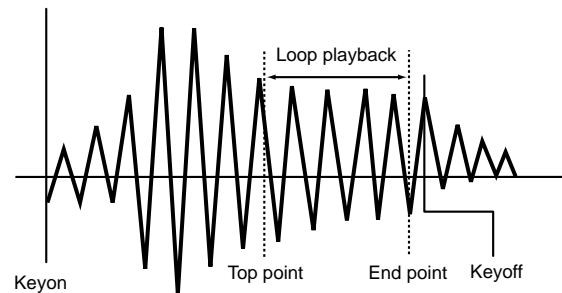

□ **Settings:** Differs depending on the sample length

Loop Length

Displays and sets the length from the Top point to the End point. As this value moves, the End point value will increase or decrease accordingly.

□ **Settings:** Differs depending on the sample length

Fraction

Finely adjusts the length of the loop. For example, when the loop is set to 100, and Loop Fraction is set to 1, the loop becomes 100 points and 1/64 point in length.

Settings: 0 ~ 63

Loop End

Sets the End point of the loop playback within the range of the entire sample. As seen in the next diagram, the End point can be set to remove unwanted noise that exists after that point in the sample.

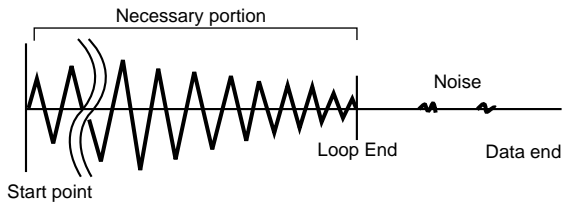

Settings: Differs depending on the sample length

About the Loop Lock Function

Changing the Start point or Top point may affect the loop length you have set. Thus, you may inadvertently change the loop length during editing. If you don't want to change the loop length, you can fix it by pressing the [F4] (LP. LOCK) key. Pressing it again cancels the Loop Lock function.

[F7]: LOOP

Here you can grasp the over all wave visually. In the right half of the screen, the Start, End and Top points are emphasized so that you can accurately set the Start point, and the Top and End loop playback points.

NOTE The parameters here correspond to the ones in the PARAM (Parameter) display. If you change the values for some parameters here, the changes are mirrored in the related parameters in the PARAM, and vice versa.

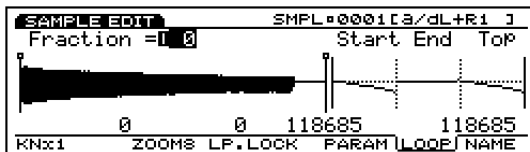

The following parameters are the same as the ones in the PARAM display. For more information on the details of each parameter, see page 179.

Fraction (Loop Fraction)

Sets the Loop Fraction. This is the same as in the PARAM display.

Settings: 0 ~ 63

START (Start Point)

Sets the Start point for the sample playback.

TOP

Sets the Top point of the loop playback (the point where the loop begins) within the range of the entire sample.

LOOP

Displays and sets the length from the Top point to the End point. As this value moves, the End point value will increase or decrease accordingly.

END (End Point)

Sets the End point of the loop playback within the range of the entire sample.

Wave Display

Displays an image of the over all sample wave.

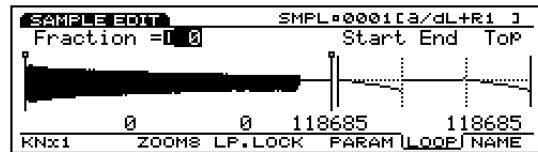

Waves for Start/Top/End Points and Magnifying Function

In the right half of the screen, waves for the Start/Top/End points are displayed. Pressing [F3] key allows you to magnify the three points for fine adjustment. Each press changes the magnification from 8, 4, 2, to 1. Since the End point is followed by the Top point, you can visually check the point of loop connection.

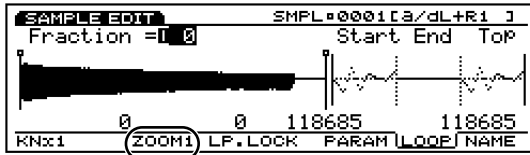
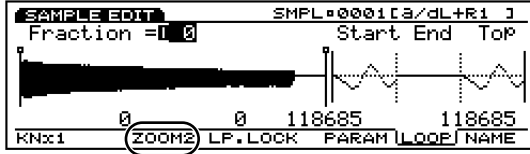
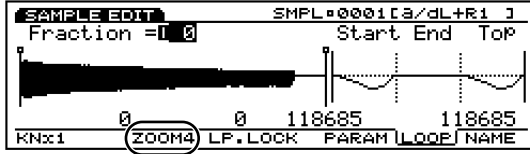
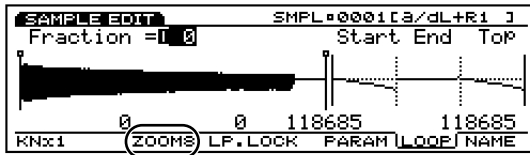

[F8]: NAME

Lets you give a name to the sample with up to eight characters.

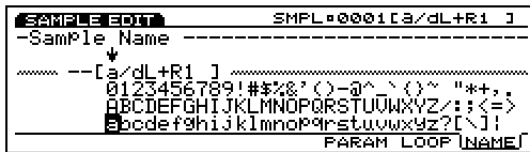

NOTE The method for naming an sample and its category is the same as that for a Voice. For more information, see page 79.

NOTE When edited as a stereo data, only the first five letters will be effective (e. g. ***** L 01).

Sample Job Mode

These jobs let you copy, delete, or append samples that are created in Sample Edit mode.

Press [JOB] key on the panel while in Sample mode to enter Sample Job mode. When you enter the Sample Job mode, the following menu will be displayed. There are five types of jobs in the Sample Job mode. Press [F1] (COPY), [F2] (DEL), [F3] (APND), [F4] (NORM), or [F5] (EXTR) to select a job.

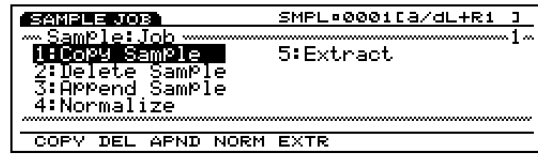

- [F1]: COPY (Copy sample)
- [F2]: DEL (Delete sample)
- [F3]: APND (Append sample)
- [F4]: NORM (Normalize)
- [F5]: EXTR (Extract)

Steps for Executing a Job

- 1 When in the Sample Play mode or the Sample Edit mode, press [JOB] to enter the Sample Job mode.
- 2 Press [F1] (COPY), [F2] (DEL), [F3] (APND), [F4] (NORM), or [F5] (EXTR) to select a job to execute. The selected job screen will be displayed.

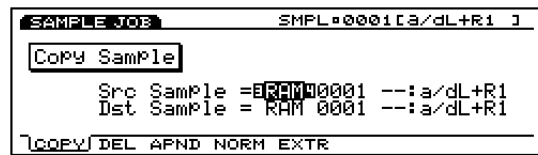

NOTE You can also select each job by moving the cursor to the desired job name on the screen and pressing [ENTER].

- 3 Move the cursor to a parameter and use the [INC]/[DEC], Data Dial, numeric keypad, or the Knobs 1 ~ 6 to set values.

- 4 Press [ENTER]. The following pop-up menu will appear, prompting confirmation of the operation.

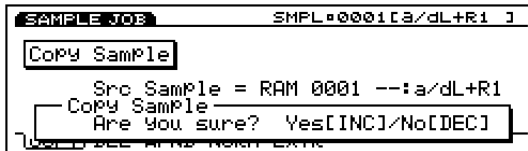

- 5 Press [YES] to execute the job. “Completed!” will momentarily appear in the screen indicating that the job was executed and the previous screen will be displayed.

Press [NO] to cancel the job.

NOTE “Executing...” will appear when the Sample Job takes some time to execute. Take note that if the power is turned off while “Executing...” is displayed, the data may be corrupted.

- 6 Press [EXIT] twice to exit the Sample Job mode and return to the Sample Play mode.

[F1]: Copy Sample

This job copies data from a source sample to a designated destination sample. The parameter settings done in Sample Edit mode are also copied at the same time.

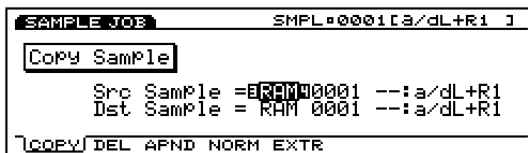

■ Src Sample (Source Sample Bank)

Selects the source sample bank.

Settings: DRAM, FLS (FLASH)

NOTE “FLASH” is effective only , Flash Memory Board (EXFLM1) has been installed in your EX. Although “FLASH” can be selected even when the optional Flash Memory Board is not installed, an error message will appear and execution will not take place.

■ Src Sample (Source Sample Number)

Selects the source sample number that will be copied from.

Settings: 0001 ~ 1024

■ Dst Sample (Destination Sample Bank)

Selects the destination sample bank.

Settings: DRAM, FLS (FLASH)

■ Dst Sample (Source Sample Number)

Selects the destination sample number that will be copied to.

Settings: 0001 ~ 1024

[F2]: Delete Sample

This job deletes the designated sample. The parameter settings done in Sample Edit mode are also initialized.

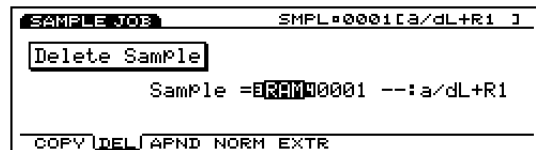

■ Src Sample (Source Sample Bank)

Selects the source sample bank.

Settings: DRAM, FLS (FLASH)

NOTE “FLASH” is effective only when the optional Flash Memory Board (EXFLM1) has been installed in your EX. Although “FLASH” can be selected even when the optional Flash Memory Board is not installed, an error message will appear and execution will not take place.

■ Src Sample (Source Sample Number)

Selects the number of the sample that will be deleted. Select “all data” to delete all of the samples in the designated sample bank.

Settings: all data, 0001 ~ 1024

[F3]: Append Sample

This job connects the data of source 2 sample to the end of the source 1 sample (append the source 2 sample to source 1 sample) and copies to the destination sample. After Append is executed, the original source sample 1 and 2 data remain the same. The available sample bank is DRAM (RAM) only.

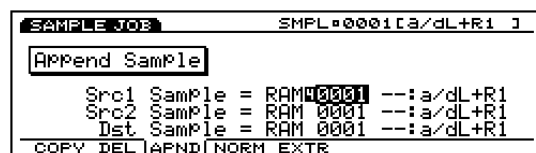

■ Src1 Sample (Source 1 Sample Number)

Sets the source number of sample 1.

❑ **Settings:** 0001 ~ 1024

■ Src2 Sample (Source 2 Sample Number)

Sets the source number of sample 2 that will be appended.

❑ **Settings:** 0001 ~ 1024

■ Dst Sample (Destination Sample Number)

Set the destination number of the sample that will be copied to.

❑ **Settings:** 0001 ~ 1024

[F4]: Normalize Sample

This job normalizes the data of the designated sample and copies the data to a specified destination. The normalize job increases the volume of the sampled sound to the maximum within a range where it is not distorted. This allows non-distorted correction of data that was recorded at an extremely low level. After Normalize is executed, the original source sample data remains the same. The available sample bank is DRAM (RAM) only.

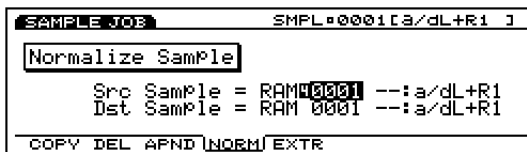

■ Src Sample (Source Sample Number)

Sets the source number of the sample that will be normalized.

❑ **Settings:** 0001 ~ 1024

■ Dst Sample (Destination Sample Number)

Sets the destination number of the sample that the normalized sample will be copied to.

❑ **Settings:** 0001 ~ 1024

[F5]: Extract Sample

This job extracts a specified part from the designated sample and copies the data to another sample. The extracted data is not erased from the source sample. Different from the Copy Sample function, you can extract just a part of sample data. The available sample bank is DRAM (RAM) only.

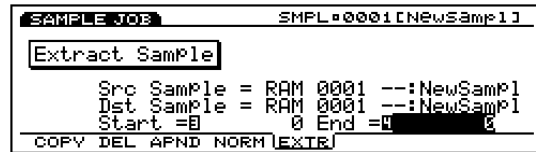

■ Src Sample (Source Sample Number)

Sets the source number of the sample that will be extracted.

❑ **Settings:** 0001 ~ 1024

■ Dst Sample (Destination Sample Number)

Sets the destination number of the sample that the extracted sample data will be copied to.

❑ **Settings:** 0001 ~ 1024

■ Start/End

When the source sample that is extracted is changed, that sample's Start/End points are automatically set here. The length set here will become the length of the data that is extracted. If necessary you can also adjust the range of the extracted data.

❑ **Settings:** These settings will differ depending on the length of the source sample that is extracted from.

Song Mode

Song Play Mode

This mode uses the internal sequencer to play songs and has various functions related to song playback. You can enter the Record mode from the Song Play mode and record a song. The songs you have recorded can be stored to floppy disk so that you can make use of them whenever you like.

NOTE For more information about the sequencer, see page 60.

Press [SONG] key on the panel to enter Song Play mode. When you enter the Song Play mode, the following menu screen will appear. In the Song Play mode, there are four types of menus.

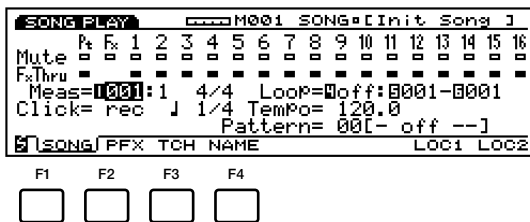

[F1]: SONG (Settings related to song playback)

[F2]: PFX (Settings related to Play Effects)

[F3]: TCH (Settings related to the track transmit channels)

[F4]: NAME (Settings related to naming songs)

[F1]: SONG

These parameters are used to set the Mute and Play Effects Thru functions for each song track (1 ~ 16 tracks, Pt track, Fx track). They can be set to “on” or “off.” There are also settings related to song playback, such as Tempo and Loop.

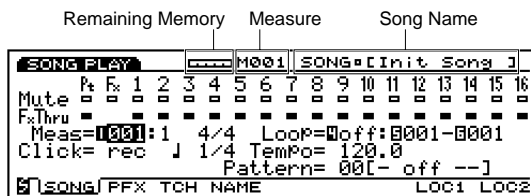

■ Remaining Memory

This bar graph indicates the amount of memory available for recording, or the remaining memory of the internal sequencer. This is common for all the internal sequencer functions, Song, Pattern and Arpeggio.

■ Measure/SONG (Song Name)

The song name and the current measure number will be displayed. These items cannot be modified.

Track Section

These settings are used to set the Mute and Play Effects Thru to “on” or “off” for each track even during song playback.

■ Track Number

One song consists of 1 ~ 16 sequence tracks, Pt (Pattern) tracks, and Fx (Pattern Play Effects) tracks. The Track Number is highlighted (box colored black) for tracks that have been recorded on and contain data.

■ Mute

Sets Mute for a track, by moving the cursor to the Mute line, and using Data Dial or [INC]/[DEC] to select “on” or “off.” As shown in the diagram, the box colored black indicates that Mute is turned “on.” When Mute is turned “on,” that track is muted during playback, and the sound is temporarily suspended. When Mute is turned “off,” only the outline of the box will be displayed, Mute is canceled, and sound will once again be produced.

■ Play Effects Thru

Sets FxThru (Play Effects Thru) for a track, by moving the cursor to the FX Thru line, and using Data Dial or [INC]/[DEC] to select “on” or “off.” As shown in the diagram, the box colored black indicates that FxThru is turned “on.” When FxThru is turned “on” for a track, Play Effects are temporarily by-passed during playback. When FxThru is turned “off,” only the outline of the box will be displayed, the FxThru function is canceled, and Play Effect settings become effective once again.

NOTE The Play Effects Thru function is not available for the Pattern Play Effects tracks.

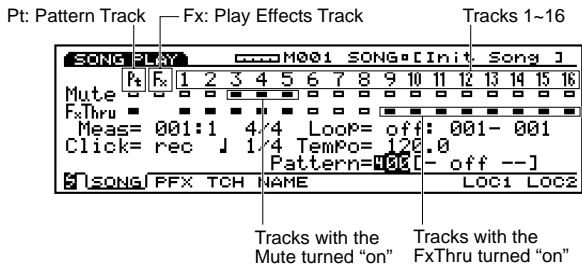

NOTE When the cursor is on the Mute or the FxThru line, you can directly select a track by pressing corresponding TRACK [1 ~ 16] key on the panel (EX5/7 only). You can directly set the Mute or FxThru to “on” or “off” by holding the [F1] PTN key and pressing the targeted TRACK [1 ~ 8] key as far as the cursor is on the Mute or FxThru line.

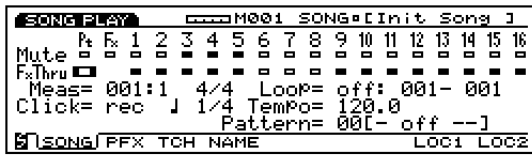

■ Meas (Measure)

Sets and indicates the Measure and Beat numbers in the currently selected song.

□ **Settings:** 001 ~ 999

NOTE The sequencer [REW] and [FWD] keys can also be used for rewinding and fast forwarding, and [TOP] key returns you to the first measure of the song.

■ Time Signature

Indicates the time signature of a song. Time signature can be set in the Song Record mode (see page 193).

■ Click (Metronome) (Click Mode)

Sets the sound mode for the metronome (Click). There are four modes, “off”(does not sound), “rec”(sounds during recording), “play”(sounds during playback and while recording), and “all”(sounds always). This function is convenient for playing in time, when performing or recording.

□ **Settings:** off, rec, play, all

NOTE In the PFX screen (see page 187), the sound and volume of the metronome (Click) can be set.

■ Click (Metronome) Beat

Sets the beat(note unit) for when the metronome (Click) will sound.

□ **Settings:** 1/4, 1/8, 1/16

■ Loop

Sets the Loop playback to “on” or “off.” The Loop function will always play in a loop according to the measures designated as the Start Point and End Point.

□ **Settings:** on, off

■ Loop Start/End Point

Sets the range of the loop (the beginning measure and end measure for playback). As stated above, when Loop is set to “on,” the designated range will play back repeatedly.

□ **Settings:** Each Start Point and End Point can be set from 001 ~ 999.

NOTE If you start the song at a measure before the loop range, the loop function will begin when the Start Point is reached. Whereas, if you start the song at a measure after the loop range, the song will proceed to play back like any other song, and automatically stop at the end.

■ Tempo

Sets the tempo for the song that is played.

□ **Settings:** 30.0 ~ 250.0

■ Pattern

Displays the pattern that is set for the measure of the currently selected song. When a pattern has not been recorded in the current pattern track, you can select a pattern that suits the performance for that song. Recording for the pattern track is explained on page 196, and is accomplished in Song Record mode.

□ **Settings:** off, 01 ~ 50, end

NOTE In Pattern Record mode (page 223), a maximum of 50 types of patterns can be created.

[F7]/[F8]: LOC1/LOC2 (Location 1/2)

The Function keys, [F7] and [F8], can be designated with appropriate measure (location) numbers. Later you can recall these locations regardless of whether the song is being played or not. Press [F7] and [F8] to recall these location points.

To set Location 1, press [F7] while holding down the [SHIFT] key. In the same way, to set Location 2, press [F8] while holding down the [SHIFT] key at the measure number of the measure that you want to recall. Press either [F7] or [F8] to recall the measure (location) set here.

Song Control

Song playback is controlled with the sequencer keys.

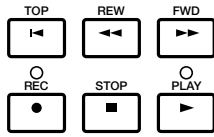

- [TOP]: Returns the song to the first measure.
- [REW] (Rewind): Rewinds through the song measure numbers.
- [FWD] (Forward): Fast Forwards through song measure numbers.
- [REC] (Recording): Engages the Song Record mode.
- [STOP]: Stops playback.
- [PLAY]: Begins playback.

[F2]: PFX (Play Effects)

These settings are related to Play Effects. The Play Effect function lets you temporarily adjust the velocity and the sound timing of MIDI notes. You can change the playback groove without altering the original data. Also you can apply various grooves to a pattern by using the 100 different types of groove templates or create your original groove templates. Different Play Effects can be set for each track.

Press [F2], the PFX screen appears. [F5] (All) ,[F6] (TR), and [F8] (GROOVE) functions are added to the screen. Pressing [F8] key opens the Groove Template screen, where you can make your own groove templates and confirm the contents of the preset groove templates.

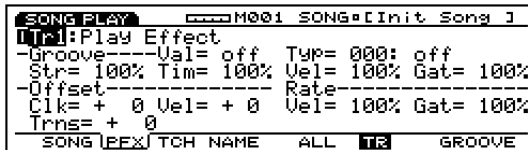

IMPORTANT It is necessary for you to turn off the “Play Effect Thru” for the track(s) you want to get the Play Effect functions in advance.

Steps for Setting the Play Effects

1 Start song playback.

Press [PLAY] key for song playback to begin.

NOTE Play Effects can be set when the song is stopped, and also can be set in real time when the song is playing back. This lets you check and audition the effect that results from the Play Effects.

2 Select [F5] ALL or [F6] TR.

When you want to apply the same Play Effects to all tracks, press [F5] to select ALL(All tracks). On the other hand, when you want to set the Play Effects differently for each track individually, press [F6] to select TR(each track).

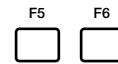
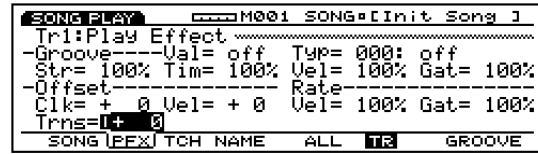

3 Select the track to which you want to apply the Play Effects.

When you select TR (each track) in step 2 above, select a track from the 16 tracks, Tr 1 ~ 16.

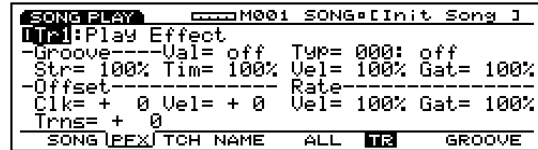

NOTE This step is unnecessary when you select ALL (All Tracks) in step 2 above.

4 Select a groove template.

Move the cursor to Type and select a groove template. When you select a User groove template, continue by moving the cursor to Val (Value), and select a Quantize value.

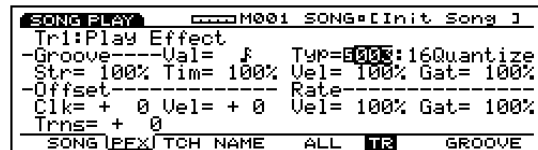

NOTE When a template is selected from the 1 ~ 100 Preset groove templates, Quantize value can be confirmed, but not changed.

5 Set each parameter.

Set the necessary parameters.

6 Set the Play Effects for other tracks.

Repeat the steps from 3 ~ 5 and set Play Effect settings for the necessary tracks.

■ Tr (Track Number)

Indicates the currently selected track number (1 ~ 16). Select the track that will be affected by the Play Effects.

□ **Settings:** Tr1 ~ 16

NOTE TRACK [1 ~ 16] keys on the panel can also be used to select a track number (EX5/7 only).

NOTE When ALL is selected with [F5], whichever track you select here, the Play Effects settings will be the same for all tracks.

Groove

You can select a groove template of your choice and set parameters for each groove template.

■ Val (Quantize value)

Indicates the Quantize value for each track. The Quantize value sets the basic note that each groove template uses to correct the timing. You can change this value only when User groove template is selected.

□ **Settings:** off, $\frac{F}{4}$, $\frac{F}{8}$, $\frac{F}{2}$, $\frac{1}{4}$, $\frac{1}{8}$, $\frac{1}{2}$, $\frac{1}{4} + \frac{F}{8}$, $\frac{1}{2} + \frac{F}{8}$

■ Type

Displays and sets the Template Type for each track. To apply various grooves, select a template from the 100 Preset groove templates, or from your own User groove templates (see page 190). When you don't use a template, set to 000 (off).

□ **Settings:** 000 (off), 001 ~ 100, 101 (usr)

NOTE For more information about Preset groove templates, see the Groove Template List in the separate Data List book.

■ Str (Quantize Strength)

Sets the degree how much the timing of the song data is moved toward the grid position (page 191) predetermined in the groove template. As shown in the diagram, when set to 100% the timing is exactly moved to the grid position set in the groove template. When 0% is set, the song data is not affected at all.

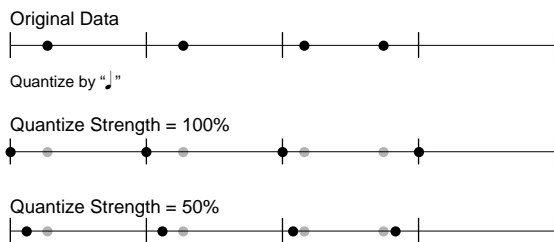

□ **Settings:** 0 ~ 100%

■ Tim (Timing)

Sets the degree of the Clock Shift (page 189) value, predetermined in the groove template, to be added to the timing of the song data. When set to 100%, the Clock Shift is calculated as is. When set to 0%, the Clock Shift becomes 0 and the timing of the original data does not change. When set above 100%, the Clock Shift value exceeds its original value.

□ **Settings:** 0% ~ 100% ~ 200%

■ Vel (Velocity)

Sets the degree of the Velocity Offset (page 189) value, predetermined in the groove template, to be added to the velocity of the song data. When set to 100%, the Velocity Offset that was set by the template is calculated as is. When set to 0%, the Velocity Offset becomes 0 and the velocity of the original data does not change. When set above 100%, the Velocity Offset value exceeds its original value.

□ **Settings:** 0% ~ 100% ~ 200%

NOTE If the value set here designates the velocity value below "1," the value will be replaced with "1."

NOTE If the value set here designates the velocity value above 127, the value will be replaced with "127."

■ Gat (Gate Time)

Sets the degree of the Gate Time Rate (page 190) value, predetermined in the groove template, to be added to the gate time (Gate Time is the length of notes) of the song data. When set to 100%, the gate time of the song data will follow to change according to the predetermined Gate Time Rate. When set to 0%, the gate time of the original data does not change. When set above 100%, the gate time changes larger than the Gate Time Rate setting.

□ **Settings:** 0% ~ 100% ~ 200%

NOTE If the value set here designates the gate time value below "1," the value will be replaced with "1."

Offset

Sets the offset values of the Clock Shift and Velocity for each track.

■ Clk (Clock Shift)

The Clock Shift function moves (shifts) the playback timing forwards or backwards in clock units. One clock unit length is equal to 1/480th of a quarter note. When set to a positive value, the playback timing moves backwards. When set to a negative value, the playback timing moves forwards. For example as shown in the diagram, when set to +240, the playback timing is moved backwards half a quarter note (an 8th note).

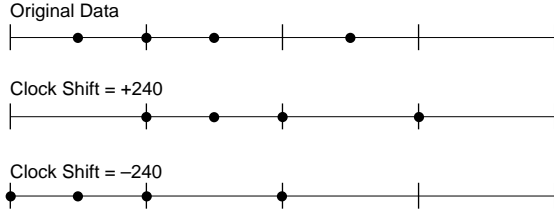

□ **Settings:** -999 ~ 0 ~ +999

■ Vel (Velocity)

Sets the Velocity offset value (velocity is the strength at which the keyboard is played). The value set here increases or decreases from the velocity value of the original data. When set to a positive value, the velocity becomes stronger. When set to a negative value, the velocity becomes weaker. When set to 0, the velocity of the original data does not change.

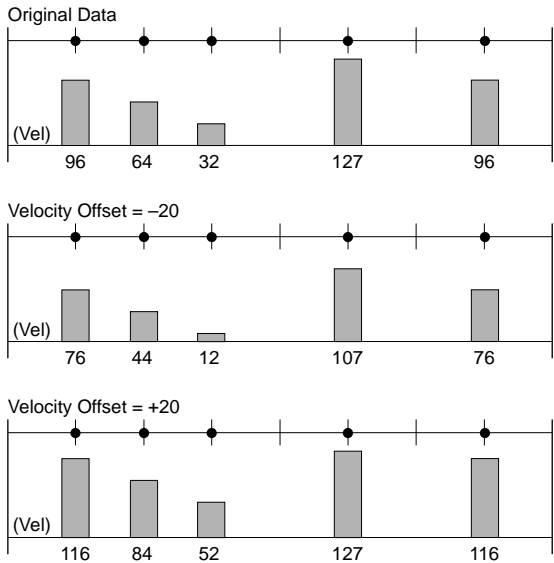

□ **Settings:** -99 ~ 0 ~ +99

NOTE If the value set here designates the velocity value below "1," the value will be replaced with "1."

NOTE If the value set here designates the velocity value above 127, the value will be replaced with "127."

Rate

Sets the rate value of the Velocity and Gate Time for each track.

■ Vel (Velocity)

Sets the Velocity Rate value. Multiplying the velocity of the original data by the velocity value set here results in the actual velocity value for playback. When set to 100%, there is no change from the original Velocity value. When set to a value larger than 100%, the velocity becomes stronger. When set to a value less than 100%, the velocity becomes weaker.

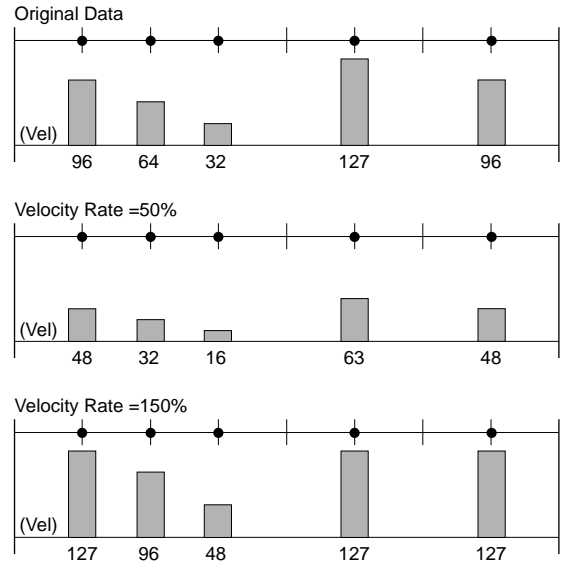

□ **Settings:** 0% ~ 100% ~ 200%

NOTE If the value set here designates the velocity value below "1," the value will be replaced with "1."

NOTE If the value set here designates the velocity value above 127, the value will be replaced with "127."

■ Gat (Gate Time)

Sets the Gate Time Rate value. Multiplying the gate time of the original data by the gate time value set here results in the actual gate time value for playback. When set to 100 %, there is no change from the original gate time value. When set to a value larger than 100 %, the gate time becomes longer. When set to a value less than 100 %, the gate time becomes shorter.

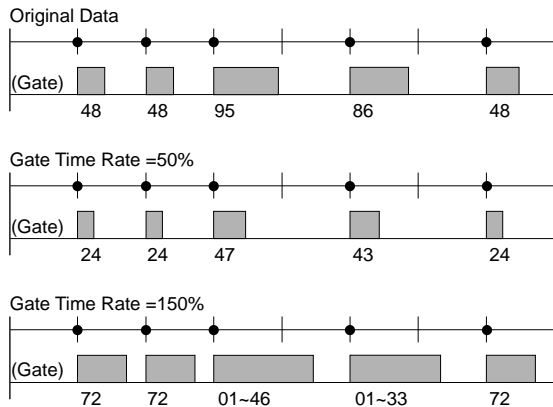

□ **Settings:** 0 % ~ 100 % ~ 200 %

NOTE If the value set here designates the velocity value below “1,” the value will be replaced with “1.”

Transpose

■ Trns (Transpose)

Adjusts the pitch in semitones for all of the song data in each track. For example, when a value of + 12 is set, the pitch of all of the data becomes one octave higher.

□ **Settings:** -127 ~ 0 ~ + 127

NOTE The Transposition setting exceeding the upper/lower limit of the MIDI note number (0 ~ 127) is invalid.

[F5]: ALL [F6]: TR(Track)

When [F5]: ALL is selected, all changes to be made will be effective for all the tracks.

When [F6]: TR is selected, all changes to be made will be effective for the specified track.

[F8]: GROOVE (Groove Template)

Pressing [F8] key changes the screen to the GROOVE display. Here you can create your own User template or confirm the settings of a Preset groove template. [F6] COPY function is added to the screen.

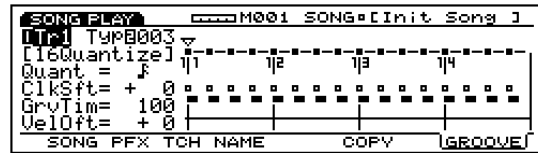

The groove templates give you instant access to add groove feeling to your song by changing the timing of the song data using the Play Effect function. Each groove template contains the parameters in one measure.

You can create your own template by copying a template from the 100 types of Preset groove templates and making necessary adjustments. Or you can create a template by setting all the parameters from scratch.

Steps for creating a User Template.

① Select a User groove template.

There are two ways to select a User groove template.

If you create a User groove template based on a Preset groove template:

1.1 Copy a Preset groove template using the Copy (page 192) function.

If you create a User groove template from scratch:

1.2. Designate “usr“(User) in the Tmplt (Template) parameter to select a User groove template .

② Set the grid, or the Quantize value.

In the Quant (Quantize value) parameter, select the note that will be the basic value by which all timing corrections are made. This selection determines the template grid.

③ Set the parameters for each grid.

Use the horizontal cursor [◀/▶] keys to move this mark ▽ to a grid you want to edit, and use the vertical cursor [▲/▼] keys to select the necessary parameters and set a value.

NOTE You can edit the parameters even while the song plays back.

■ Tr (Track Number)

Indicates the currently selected track number (1 ~ 16). Select the track you want to edit the groove template.

□ **Settings:** Tr1 ~ 16

NOTE TRACK [1 ~ 16] keys on the panel can also be used to select a track number (EX5/7 only).

■ Type

The current template type for each track is displayed here. The contents for each will be displayed in the Groove View. Different template types can be selected. At this point, to create a User template select “usr.” The parameters below can be selected and modified only when the User (usr) template is selected.

□ **Settings:** off (000), 001 ~ 100, 101 (usr)

■ Quant (Quantize value)

Indicates the Quantize value for the currently selected groove template. The Quantize value determines the note that will be the basic value by which all timing corrections are made for each groove template. The value set here can be adjusted by the Groove Strength parameter in the Play Effect screen. When “usr” Template Type is selected, you can change the values. As values change, the grids (see below) on the Groove View change accordingly.

□ **Settings:** off, $\frac{1}{2}$, $\frac{1}{4}$, $\frac{1}{8}$, $\frac{1}{16}$, $\frac{1}{32}$, $\frac{1}{64}$, $\frac{1}{128}$, $\frac{1}{256}$, $\frac{1}{512}$

Groove View

This display lets you visually grasp the Grid, Clock Shift, Gate Time, and Velocity settings that are basically based on the Quantize value. Groove View lets you confirm the settings of the Preset groove templates, and create and confirm your own User groove templates.

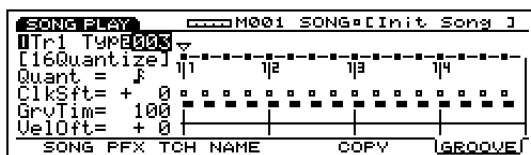

Grid

The Grid is the basic unit you use when setting a groove template and is displayed in the Groove View using the Measure, Beat and Clock unit. The detail of the grid changes depending on the Quantize value. The template is configured with eight beats.

▽Mark

This mark lets you select a specific grid. Use the horizontal cursor [◀/▶] keys to move forwards or backwards through the grids. As the mark ▽ is moved to a grid, the current parameter settings for the selected grid will be displayed, and you can confirm the values. When User groove template is selected, you can set the parameter values in grid units.

■ ClkSft (Clock Shift)

The Clock Shift parameter moves (shifts) the playback timing forwards or backwards in clock units. With the User groove templates, you can set the amount of movement, forwards or backwards for the clock number at each grid position. The value set here can be adjusted by the Groove Timing parameter in the Play Effect screen.

With the Preset groove templates, Clock Shift values can be confirmed at each grid, but not be edited.

□ **Settings:** Values from the middle Clock number between the previous note and the current note, to the middle Clock number between the current note and the next note (the actual Clock value that can be set will differ according to the Quantize value).

■ GrvTim (Groove Gate Time)

The Groove Gate Time parameter changes the gate time of the original data. With the User groove templates, you can set the amount of increments/decrements for the gate time of the original data at each grid position. The value set here can be adjusted by the Groove Gate Time parameter in the Play Effect screen.

With the Preset groove templates, Groove Gate Time values can be confirmed at each grid, but not be edited.

□ **Settings:** 0% ~ 100% ~ 200%

■ VelOft (Velocity Offset)

The Velocity Offset parameter changes the velocity of the original data. With the User groove templates, you can set the amount of increments/decrements for the velocity value of the original data at each grid position. The value set here can be adjusted by the Groove Velocity parameter in the Play Effect screen.

With the Preset groove templates, Velocity Offset values can be confirmed at each grid, but not be edited.

□ **Settings:** -99 ~ 0 ~ +99

[F6]: COPY

Lets you copy the currently selected Preset groove template to a User groove template. A specific Preset groove template can be used as the basis for creating a User groove template.

- 1 Move the cursor to the Type parameter, and select the Preset groove template that will be copied.
- 2 Press [F6] (COPY) to execute the Copy function. When Copy has finished “Completed!” will momentarily be displayed and a User groove template is automatically selected.

[F3]: TCH (Transmit Channel)

Sets the transmit channel for each track and where the data is sent. Move the cursor to a parameter (grids on the crisscrosses), set the switch to “on” or “off,” and set the MIDI channels by using [INC]/[DEC].

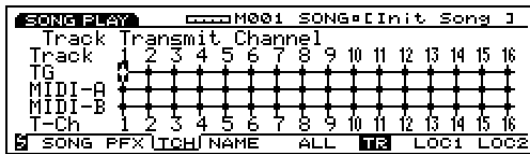

NOTE TRACK [1 ~ 16] keys on the panel can also be used to select a track number (EX5/7 only).

■ TG (Tone Generator)

Sets whether or not each track’s data is output to the internal tone generator.

Settings: \oplus (is output), \ominus (is not output)

■ MIDI-A/MIDI-B (MIDI OUT A/B)

Sets whether or not each track’s data is output from MIDI OUT A/B to an external device.

Settings: \oplus (is output), \ominus (is not output)

NOTE “MIDI B” is inactive on EX5R and EX7.

■ T-Ch (Transmit Channel)

Sets the MIDI transmit channel for each track.

Settings: 1 ~ 16

[F5]: ALL [F6]: TR(Track)

When [F5]: ALL is selected, all changes to be made will be effective for all the tracks.

When [F6]: TR is selected, all changes to be made will be effective for the specified track.

[F4]: NAME (Song Name)

Lets you name a song using up to a maximum of ten letters and/or numbers.

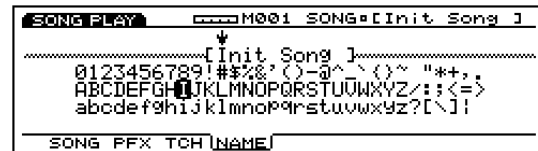
**Setting a File Name**

- 1 Press [F4] and the NAME screen will be displayed.
- 2 Use [INC]/[DEC] or Data Dial to select a number, letter, or symbol.
- 3 Move the cursor and select the next character.
- 4 Repeat the above steps 2 and 3 to set the song file name.

You can also enter numbers, letters, or symbols using the numeric keypad. Several letters or symbols are assigned to each key (available letters or symbols are printed below each key). Upper and lower case letters are available. For example, each time the 0 key is pressed, the available number and letters are displayed in the following order: 0→A→B→C→a→b→c. SPACE (one space) is assigned to [ENTER] key. You can also move through the input locations (numbers, letters, and symbols) using the cursor key.

Available numbers and letters:

Shown in the above illustration.

Song Record Mode

In Song Record mode there are two methods available for recording songs, real time recording and step recording. There are also various functions related to recording songs. For organizing your songs after they have been recorded, they can be stored to floppy disk so that you can make use of them whenever you like.

Real time recording:

Just like a multi-track recorder, the actual performance is recorded as you play. Because the performance is recorded exactly as played, the subtle nuances and the feeling of the recording are accurately expressed.

Step recording:

Just like writing music on a music score, each note is programmed in separately. You can confirm each beat in the measure in the screen as you perform operations. Therefore this type of recording is perfect for programming repetitive patterns and phrases, basic rhythms and bass lines that require precision. This method of recording is also convenient for inputting the trigger timing of sample loops for break beats.

You can create songs by utilizing the patterns which have been made in Pattern mode (see page 219) beforehand. First create various patterns in Pattern mode. Next compose the accompaniment part by putting the patterns on the pattern track in the order you specify. Then play and record the various parts on the tracks 1 ~ 16 one by one to complete the song. Pattern tracks and Song tracks share the same 16 parts of the tone generator. Set the MIDI channels in a way that prevents the parts from overlapping.

For recording Play Effects in real time for the pattern track, there is a Pattern Play Effects track, and for recording tempo data there is a Tempo track.

How to Enter Song Record mode

When in Song Play mode, press the sequencer [REC] (Recording) key. The [REC] light will be lit indicating that Song Record mode has been engaged, and is now in standby status.

Press [REC] once more or [STOP] to return to Song Play mode.

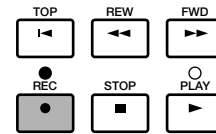
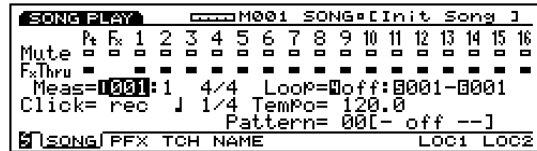

NOTE For information on the basics of the sequencer, see page 60.

When you enter Song Record mode, the menus below appear in the screen. There are seven menus in Song Record mode.

NOTE Before entering Song Record mode, create the performances (page 156) and patterns (page 219) that you want to use.

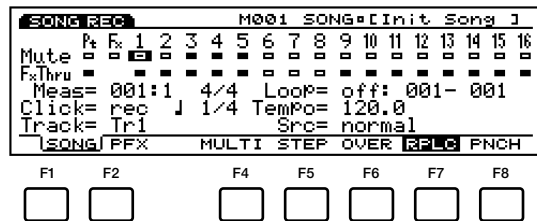

[F1]: SONG(Settings related to song recording)
[F2]: PFX(Settings related to Play Effects)

Recording Mode

[F4]: MULTI (Selecting Multi mode)
[F5]: STEP (Selecting Step recording)
[F6]: OVER (Selecting Overdubbing)
[F7]: RPLC (Selecting Replace recording)
[F8]: PNCH (Selecting Pinch In recording)

[F1]: SONG

These are various settings related to song recording, such as selecting a track for recording, and setting the time signature and tempo. In addition to those settings, there are Mute on/off, Play Effect on/off and Loop playback for each of the playback tracks (tracks 1 ~ 16, Pt track, Fx track).

Many of the parameters here are found in Song Play mode (page 185). Only the parameters that differ from those described in Song Play mode will be explained.

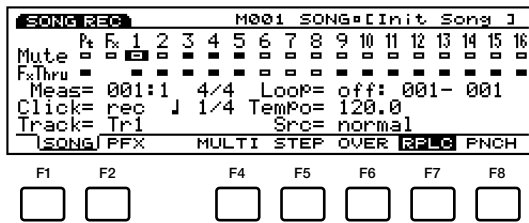

Meas(Measure)

Set the measure where recording will begin. The Beat number is also displayed but cannot be changed.

Settings: 001 ~ 999

NOTE The sequencer [REW] and [FWD] keys can also be used for rewinding and fast forwarding, and [TOP] key returns you to the first measure of the song.

Time Signature

Sets the time signature for a song.

Settings: 1/4 ~ 8/4, 1/8 ~ 16/8, 1/16 ~ 16/16

NOTE The time signature data is recorded on the pattern track. You can change the time signature of the entire song, or in the middle even after recording.

When PNCH (Punch In) is selected in Song Record mode, the parameter “Loop” will change to “Rec From-To” parameter.

Rec From-To

Sets the measures where Punch In recording will begin and end. Available and displayed only when the PNCH (Punch In) is selected.

Settings: 001 ~ 999 for both From and To.

Track

Selects the track for recording. Tracks 1 ~ 16 can also be selected using the TRACK [1 ~ 16](EX5/7 only).

Settings: Tr1 ~ 16(tracks1 ~ 16), Pattern(Pattern track), PFX(Pattern Play Effects track), Tempo(Tempo track)

NOTE Pattern track, Play Effects track, and Tracks 1 ~ 16 are all positioned in the same line at the top of the screen.

Depending on the track selected, the following parameters will be added.

For Tracks 1 ~ 16

Src(Source)

Selects the recording source: the performance data played on the keyboard (normal) or the arpeggiated chord data created by the Arpeggiator (Arpeggio).

NOTE When a track other than the Tr1 ~ 16 (tracks 1 ~ 16) is selected, [F2] (PFX), [F4] (MULTI) and [F5] (STEP) cannot be selected.

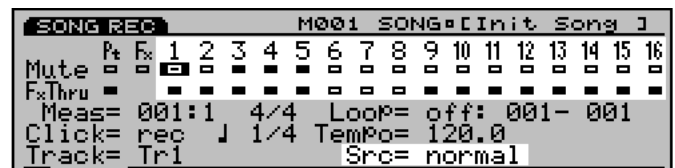

Settings: normal, arpeggio

NOTE For information on recording tracks 1 ~ 16, see page 196.

For Pattern Track

Ptn No (Pattern Number)

Selects the pattern that will be recorded at the currently selected measure into the Pattern track.

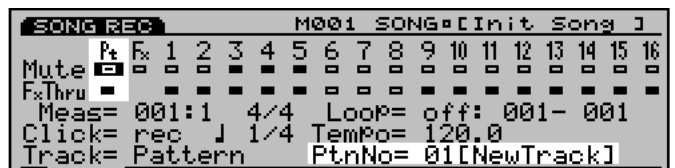

Settings: off, 01 ~ 50, end (the location where the song ends)

NOTE For information on recording Pattern track, see page 196.

For Pattern Play Effects (PFX) Track

■ Ptn Tr (Pattern Track)

Selects one of the tracks 1-8 (in a Pattern) to which the Pattern Play Effects will be applied and recorded.

SONG REC		M001 SONG=[Init Song]															
Mute	Fx	1	2	3	4	5	6	7	8	9	10	11	12	13	14	15	16
☐	☐	☐	☐	☐	☐	☐	☐	☐	☐	☐	☐	☐	☐	☐	☐	☐	☐
FxThru	☐	☐	☐	☐	☐	☐	☐	☐	☐	☐	☐	☐	☐	☐	☐	☐	☐
Meas=	001:1	4/4		Loop= off: 001- 001													
Click=	rec	1/4		Tempo= 120.0													
Track=	PFX	PtnTr= Tr1															

☐ Settings: Tr1 ~ 8, All

NOTE For information on recording pattern Play Effects track, see page 197.

[F2]: PFX (Settings related to Play Effects)

These functions are the same as those explained in Song Play mode, Play Effects settings can be made for tracks 1-16. For information on each parameter, see page 187.

NOTE The Play Effects settings in Song Record mode are done track by track (all tracks cannot be set simultaneously). Also you cannot create a User groove template here.

Recording Mode

In Song Record mode various recording modes have been assigned to [F4] ~ [F8].

[F4]: MULTI

Sets the Multi mode to “on” or “off.” Press [F4], MULTI is highlighted, Multi mode is turned on, and all the tracks can be recorded in real time. This type of recording is mainly utilized when using an external sequencer. For example, on the currently selected track, (the track selected in the parameters), the performance on the EX 5/7 keyboard is recorded, while at the same time performance data is recorded on other tracks from an external sequencer.

NOTE In Multi mode, you can select either Over Dubbing, Replace, or Punch In type of recording.

NOTE When Multi mode is set to “off,” real time recording can only take place on one specified track.

[F5]: STEP

Sets the Step recording mode to “on” or to “off.” Press [F5], STEP is highlighted and the Step recording mode is turned on. Then notes can be programmed in one at a time. Press [F6] ~ [F8] to cancel the Step recording mode and return to real time recording.

NOTE When one of the modes other than STEP is highlighted real time recording is always engaged.

[F6]: OVER (Over Dubbing)

Sets the Over dubbing recording to “on” or “off.” Press [F6], OVER is highlighted and the Over dubbing is turned on. When recording in real time, you can record over previously recorded data. For example, after first recording a bass drum, you can use this function to record a snare and high-hat on top without erasing the original data. Press [F7]/[F8] to cancel the Over Dubbing recording.

[F7]: RPLC (Replace)

Sets the Replace recording to “on” or “off.” Press [F7], RPLC is highlighted and the Replace recording is turned on. When recording in real time, you can record over previously recorded data (erasing and replacing the original data with the new data as you record). Press [F6]/[F8] to cancel the Replace recording.

[F8]: PNCH (Punch In)

Sets the Punch In recording to “on” or “off.” Press [F8], PNCH is highlighted and the Punch In recording is turned on. When recording in real time, you can record (write over the original data) on the specific range designated in the Rec From-To parameter. Press [F6]/[F7] to cancel the Punch In recording.

Real Time Recording: Tr1~Tr16

Real Time recording is just like a multi-track recorder where you record the performance as it is. There are three types of recording methods, Over Dubbing (recording over original data but not erasing it), Replace (erasing and replacing the original data), Punch In (record for a designated length of measures). Also there is Multi mode, that when set to “on” (lets you record on all the tracks simultaneously) and when set to “off” (lets you recording one track at a time).

- 1 When in Song Play mode, press [REC] to enter Song Record mode (record stand-by status).
- 2 Set the parameters necessary for recording, such as the time signature, tempo, and metronome (Click), in the SONG screen (see page 194).

NOTE If necessary, set the Play Effects for each track in the PFX screen.

- 3 Set the beginning measure number for recording with the Meas parameter.
- 4 Select the track (Tr1-16) for recording with the Track parameter.
- 5 Select either the keyboard performance or Arpeggio with the Src parameter.
- 6 Select one of the following recording modes: [F6] (Over Dubbing), [F7] (Replace), [F8] (Punch In). To record on all the tracks simultaneously, press [F4](MULTI), Multi mode is turned on and highlighted.

NOTE If you select Punch In, designate the beginning and end measures for recording (see page 195).

- 7 Press [PLAY] and recording will begin after a two measure countdown. The [PLAY] green light will blink in sync with the metronome (Click).

NOTE During the two measure countdown, Meas (measure) will display the countdown from -2 to -1.

NOTE When in the Punch In recording, playback will proceed as usual until the designated beginning measure is reached, at that measure until the end measure, the data will be recorded over (the original data is written over and erased). When the end measure is reached, the Punch In record function is cancelled, and playback continues if there is recorded data past that point.

- 8 Press [STOP] to stop recording and the EX5/5R/7 automatically returns to Song Play mode.

NOTE After you have finished recording, there are various edit functions that let you correct misplayed notes or the timing, in the Song Edit mode (page 206) and the Song Job mode (page 201).

NOTE When the power is turned off, the song data is lost. Please remember that important song data should be saved to floppy disk or other optional backup device (page 259).

Real Time Recording: Pattern

The Pattern real time recording function lets you take patterns from the previously made 50 types of patterns in the Pattern Record mode, and record them onto the Pattern track. Select the pattern that best suits the song performance and record onto the track. There are the following two types of recording modes available: Replace, Punch In. Multi mode and Over Dubbing recording cannot be used.

- 1 When in Song Play mode, press [REC] to enter Song Record mode.
- 2 Set the parameters necessary for recording, such as the time signature, tempo, and metronome (Click), in the SONG screen (see page 194).

- 3 Set the beginning measure number for recording with the Meas parameter.
- 4 Select the Pattern track for recording with the Track parameter.

- 5 Press either [F7](Replace), or [F8](Punch In), to select the recording mode.

NOTE If you select Punch In, designate the beginning and end measures for recording (see page 195).

- 6 Select the first pattern number to be recorded with Ptn No parameter.

- 7 Press [PLAY] and recording will begin after a two measure countdown. The [PLAY] green light will blink in sync with the metronome click.

NOTE During the two measure countdown, Meas (measure) will display the countdown from -2 to -1.

- Change the pattern numbers you want to use and record them. While recording, without moving the cursor from the Ptn No parameter, use Data Dial, [INC]/[DEC], and the numeric keypad to set the pattern numbers.

NOTE The patterns are recorded in measure units. When “off” is selected for a measure, a pattern will not be recorded. Make sure to record “end” at the end of a song. If “end” is not recorded at the end, the song performance will not end and the measure number continue to advance until you press [STOP] key.

NOTE When in the Punch In recording, playback will proceed as usual until the designated beginning measure is reached, at that measure until the end measure, the data will be recorded over (the original data is written over and erased). When the end measure is reached, Punch In record function is cancelled and playback continues if there is recorded data past that point.

- Press [STOP] to stop recording and the EX5/5R/7 automatically returns to Song Play mode.

NOTE After you have finished recording, there are edit functions that let you edit the pattern track data in the Song Edit mode (page 201) and the Song Job mode (page 206).

NOTE When the power is turned off, the song data is lost. Please remember that important song data should be saved to floppy disk or other optional backup device (page 259).

Real Time Recording: PFX

The Pattern Play Effects real time recording function records the effect of Play Effects for each track (1-8) of the patterns that have been recorded on the song's Pattern Track. The groove of the patterns can be changed in real time and then can be recorded. While listening to the playback of the patterns, you can change the Play Effects parameters by using the Knobs 1-6 and Data Dial and record them. There are the following three types of recording modes available: Over Dubbing, Replace, and Punch In.

- When in Song Play mode, press [REC] to enter Song Record mode.
- Set the parameters necessary for recording, such as the time signature, tempo, and metronome (Click), in the SONG screen (see page 194).
- Set the beginning measure number for recording with the Meas parameter.
- Select the PFX (Pattern Play Effects track) with the Track parameter.

- Select the pattern track (1-8) to record the effect of Play Effects with the Ptn Tr parameter.

NOTE If you want to record the Play Effects onto the all tracks at one time, select “All” from the Ptn Tr parameter.

- Select one of the following recording modes: [F6] (Over Dubbing), [F7] (Replace), [F8] (Punch In).

NOTE If you select Punch In, designate the beginning and end measures for recording (see page 195).

- Press [PLAY], the pattern Play Effects settings screen will be displayed and recording will begin after a two measure countdown. The [PLAY] green light will blink in sync with the metronome click.

NOTE During the two measure countdown, Meas (measure) will display the countdown from -2 to -1.

- Change each parameter while recording. While recording, move the cursor to the parameters you want to edit and make changes using the Knobs 1-6. Or move the cursor to a parameter, and you can use Data Dial, [INC]/[DEC], or the numeric keypad to change a value.

NOTE All parameter changes will be recorded at the exact timing just as you change them. The parameters are the same as those explained in the Song/Pattern Play modes. For more information, see page 185.

NOTE When in the Punch In recording, playback will proceed as usual until the designated beginning measure is reached, at that measure until the end measure, the data will be recorded over (the original data is written over and erased). When the end measure is reached, the Punch In record function is cancelled, and playback continues if there is recorded data past that point.

- Press [STOP] to stop recording, the EX5/5R/7 automatically returns to Song Play mode.

NOTE After you have finished recording, there are edit functions that let you edit the Pattern Play Effects track data in the Song Edit mode (page 201) and the Song Job mode (page 206).

NOTE When the power is turned off, the song data is lost. Please remember that important song data should be saved to floppy disk or other optional backup device (page 259).

Real Time Recording: Tempo

The Tempo real time recording function records changes in the tempo onto the song Tempo Track. You can change the tempo in the middle of the song. There are the following two types of recording modes available: Replace, and Punch In. Multi mode and Over Dubbing cannot be used.

- 1 When in Song Play mode, press [REC] to enter Song Record mode.
- 2 Set the parameters necessary for recording, such as the time signature and metronome (Click), in the SONG screen (see page 194).
- 3 Set the beginning measure number for recording with the Meas parameter.
- 4 Select the tempo (tempo track) with the Track parameter.
- 5 Set the first tempo to be recorded, with the Tempo parameter.
- 6 Press either [F7] (Replace), or [F8] (Punch In), to select the recording mode.
 - NOTE** If you select Punch In, designate the beginning and end measures for recording (see page 195).
- 7 Press [PLAY], after a two measure countdown recording will begin. The [PLAY] green light will blink in sync with the metronome (Click).
 - NOTE** During the two measure countdown, Meas (measure) will display the countdown from -2 to -1.
- 8 Change the tempo by adjusting the tempo value while recording. While recording, without moving the cursor from the Tempo parameter, use Data Dial, [INC]/[DEC], or the numeric keypad to set the tempo.
 - NOTE** When in the Punch In recording, playback will proceed as usual until the designated beginning measure is reached, at that measure until the end measure, the data will be recorded over (the original data is written over and erased). When the end measure is reached the Punch In record function is cancelled and playback continues if there is recorded data past that point.

- 9 Press [STOP] to stop recording. The EX5/5R/7 automatically returns to Song Play mode.

NOTE After you have finished recording, there are edit functions that let you edit the Tempo track data in the Song Edit mode (page 201) and the Song Job mode (page 206).

NOTE When the power is turned off, the song data is lost. Please remember that important song data should be saved to floppy disk or other backup device (page 259).

Step Recording: Tr1 ~ Tr16

In Step recording the performance data (note length [gate time], pitch, and velocity) is programmed one note at a time.

Step Recording Screen

When in Step recording (after you press [PLAY]), the following screen will be displayed.

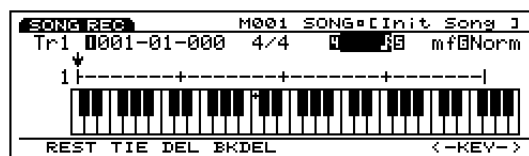

NOTE The available keyboard range is from C-1 through B7.

Using the Cursor Keys in Step Recording

Horizontal cursor [◀ ▶] keys: moves to the Measure number, Note Length, Velocity, and Gate Time within the menu.

Vertical cursor [▲ ▼] keys: selects the input location within a measure.

Track Number

Indicates the track of the currently selected song that is being recorded on. The displayed track number cannot be changed. It is necessary to select the track for recording before entering the Step recording.

Location (Measure, Beat, Clock)

Indicates the current ↓ cursor position, or the note input location, by displaying the Measure number, Beat, and Clock. You can change the Measure number by moving the cursor to the number using the horizontal cursor key.

■ Time Signature

Displays the time signature of the currently selected song that is being recorded. The displayed time signature cannot be changed. It is necessary to select the time signature for recording before entering the Step recording.

■ Note Length

Sets the length of the note that will be input. After selecting Note Length parameter by using the horizontal cursor keys, designate the note length for each note with the numeric keypad which has different note symbols above each key. You can also use Data Dial or [INC]/[DEC] to adjust the note length in clock units.

- **Settings: [using the numeric keypad]**
 whole note(1920), half note(960), quarter note(480), 8th note (240), 16th note(120), 32nd notes(60), quarter note triplet(320), 8th note triplet(160), 16th note triplet(80), dotted note;

[using Data Dial or [INC]/[DEC]]
 any numeric value you enter

■ Velocity

Sets the velocity for the note that is input. After selecting Velocity parameter by using the horizontal cursor keys, designate the note velocity for each note with the numeric keypad which has different dynamic marks above each key. You can also use Data Dial or [INC]/[DEC] to finely adjust the velocity value.

- **Settings: [using the numeric keypad]**
 ppp(8), pp(24), p(40), mp(56), norm(64), mf(72), f(88), ff(104), fff(120);

[using Data Dial or [INC]/[DEC]]
 1 ~ 127, EXT(select EXT when inputting the velocity value by keyboard)

■ Gate Time Display

Sets the actual length that the note sounds.

- **Settings:** Stac(Staccato) = 50 %, Norm(Normal) = 90 %, Slur = 99 %

■ Beat Graph

The Beat Graph lets you confirm and set the note input location within a measure. One small dash “-” indicates the length of a 32nd note. Therefore eight dashes “-” will equal to the length of a quarter note, and 32 dashes “-” will equal to the length of a whole note. For example in 4/4 time, 32 dashes “-” indicate the length of one measure. The Beat location is indicated with a short vertical line.

When you enter a note using the keyboard, the ↓ cursor will advance by the length of the input note. You can use the vertical cursor keys to move the ↓ cursor to select the input location. ● mark will be displayed on “-” at the location where the note is being input.

The Step recording screen may differ depending on the currently selected time signature.

Example 1

When set to 5/4 time. A measure requires two screens.

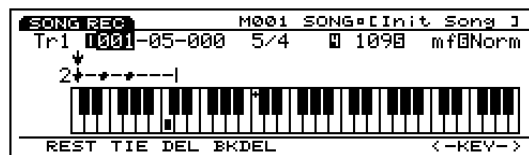
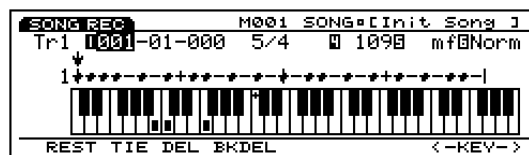

Example 2

When set to 3/4 time.

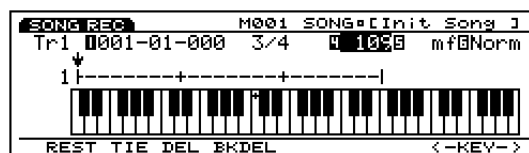

Keyboard Illustration

Shows the currently input note(s) at the present ↓ cursor position. If you move the ↓ cursor to the location where the note has been input (the location where the “●” mark is on the beat graph), the input note(s) will be indicated on the key(s) on the keyboard illustration.

You can use the [F7]/[F8] (< -KEY- >) to scroll to the right or left of the keyboard. Using the “+” mark on the keyboard (fixed at C3) as a reference, you can display the upper or lower regions of the keyboard that are not currently displayed.

Notes can be input using the EX5/7 keyboard or an external MIDI device.

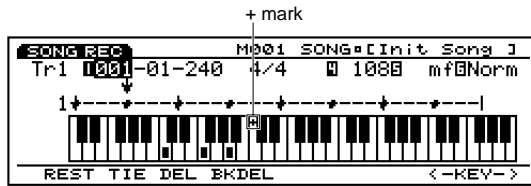

Range of the keyboard displayed: C-2 ~ G8

NOTE For the EX5R, use an external MIDI keyboard to input notes.

- **[F1]/[F2]/[F3]/[F4]:**
REST/TIE/DEL(Delete)/BKDEL(Back Delete)
Convenient functions such as inputting rests and deleting notes are assigned to [F1]/[F2]/[F3]/[F4] function keys. For more information, see page 201.

The Procedure for Step Recording

- 1 When in Song Play mode, press [REC] to enter Song Record mode (record stand-by status).
- 2 Set the time signature in the SONG screen (see page 194).
- 3 Set the beginning measure number for recording with the Meas parameter.
- 4 Select the track (Tr1-16) for recording with the Track parameter.
- 5 Press [F5](STEP) to select the Step recording mode.
- 6 Press [PLAY], the [PLAY] green light will be lit, and the Step Recording screen will be displayed.

- 7 Set the note length, velocity, and input the note with the keyboard. The ↓ cursor automatically moves forward a distance equal to the length of the note that was just input.
- 8 Repeat step 7 above, and program in one note at a time.
- 9 Press [STOP] to stop recording. The EX5/5R/7 automatically returns to Song Play mode.

NOTE After you have finished recording, there are various edit functions in the Song Edit mode (page 201) and the Song Job mode (page 206).

NOTE When the power is turned off, the song data is lost. Please remember that important song data should be saved to floppy disk or other backup device (page 259).

Inputting Notes

1 Set the note length.

Move the horizontal cursors to the Note Length parameter and designate the note length with the numeric keypad (with note symbols). The note length (with numeric values) can also be designated with Data Dial or [INC]/[DEC] in clock units.

To input the dotted notes, select a basic note value then press “0” key on the numeric keypad. For inputting double-dotted note, after designating the basic note value, press the “0” key twice.

2 Set the note velocity.

Move the horizontal cursors to the Velocity parameter and designate the note velocity with the numeric keypad (with dynamic marks). The note velocity (with numeric values) can also be designated with Data Dial or [INC]/[DEC].

Select “EXT” in the Velocity parameter to input the actual velocity that is played on the keyboard.

3 Input the notes.

When you press down a key, the note with the length and velocity designated in steps 1 and 2 above will be input at the note (pitch) that is played on the keyboard. The ↓ cursor automatically moves forward a distance equal to the length of the note that was just input.

To input chords, simply play more than one key simultaneously. A note can also be recorded on top of the previously recorded note at the same location.

Inputting Staccato and Slurs

Move the cursor to the Gate Time parameter, after selecting Stac (Staccato) or Slur, play a note on the keyboard to input that note. The note is input with the selected gate time. Usually this will be set to Norm (Normal).

Inputting Rests

After setting the note length with the numeric keypad, press [F1] REST to input a rest. The ↓ cursor automatically moves forward a distance equal to the length of the rest that was just input.

Inputting Ties

This function is used to connect, or tie the adjacent notes in the same pitch. To execute a tie, simply press [F2] TIE. The current note length set in the Note Length parameter will be added to the note input directly before executing the Tie operation.

Deleting Notes

There are two methods for deleting notes, Delete and Back Delete. Press [F3]DEL (Delete) to delete the note at the current ↓ cursor location. Press [F4] BKDEL (Back Delete) to delete the note just before (one step backwards) the current ↓ cursor location. For chords, either function will delete all notes simultaneously.

Song Edit Mode

In Song Edit mode, you can edit events of songs that were recorded in real time or in step recording.

Press [EDIT] key on the panel while in Song mode to enter Song Edit mode. When you enter Song Edit mode, the Track Event List for the currently selected track in Song Play mode will be displayed. Press [F1] ~ [F4] to select one of the four track types (shown below) to edit. Available data and the Event List to be displayed will differ depending on the selected track type.

Methods for Song Edit will be explained for each track type separately.

SONG EDIT		M010 SONG=[Init Song J			
Tr1	-Note-	Gate	Vel		
009-04-233	C 4	00-346	(J)	88	
009-04-473	B 3	00-211	(J)	30	
010-01-094	A 3	00-275	(J)	51	
010-01-217	G 3	00-236	(J)	53	
010-01-402	F 3	00-430	(J)	55	

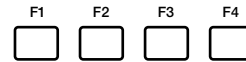

- [F1]: SEQ (Tr1 ~ 16: Editing sequence tracks 1 ~ 16)
- [F2]: PFX (Editing Pattern Play Effects track)
- [F3]: PTN (Editing Pattern track)
- [F4]: TEMPO (Editing Tempo track)

About the Location for Each Event

SONG EDIT		M001 SONG=[Init Song J			
Tr1	-Note-	Gate	Vel		
001-01-000	C 3	00-001	(F)	86	
001-02-000	C 3	00-001	(F)	86	
001-03-000	C 3	00-001	(F)	86	



You can grasp the location for each event by checking Measure/Beat/Clock at the right side of the screen.

- ① **Measure:** 1 ~ 999
- ② **Beat:** 1 ~ 16 (maximum value will change depending on the beat settings)
- ③ **Clock:** 000 ~ 479
- ④ **Top of Track** (indicates the beginning of the track)
- ⑤ **End of Track** (indicates the end of the track)

Insert

To insert an event, first designate the insert location and select the event then press [ENTER].

Change

To change the location of an event, designate the location and press [ENTER].

Delete

To delete an event, move the cursor to an event and press [F8] (Delete).

NOTE For more information on each event, see below.

NOTE Undo/Redo function in Song Job mode allows you to cancel the edit operation you have done or execute the operation again.

[F1]: SEQ (Tr1~16: Sequence tracks 1~16)

When editing the sequence tracks, you can insert new event data as well as change the location and value of previously existing event data. Press [F1] (SEQ) to display the Sequence Track Event List screen. [F5]INS (Insert) and [F6]CHNG (Change) functions are added to the menu. Also [F8] DEL (Delete) is added for deleting events.

SONG EDIT		M008 SONG=[Init Song 1]	
Tr1			
	Note	Gate	Vel
007-02-105	C 3	03-248 ()	99
007-02-106	C 3	03-244 ()	90
007-02-114	C 3	03-239 ()	65
008-01-470	C 3	03-200 ()	100
008-01-475	C 3	03-163 ()	100

[SEQ] PFX PTN TEMPO INS CHNG [DEL]

Event Data That Can Be Edited**Note**

Edits note data (Note Name, Gate Time, Velocity).

SONG EDIT		M001 SONG=[Init Song 1]	
Tr1			
	Note	Gate	Vel
001-01-000	C 3	00-086 (F.)	86

[SEQ] INS CHNG

① ② ③ ④

Settings:

- Note:** C-2 ~ G8
- Gate (Gate Time: Beat/Clock):** 00 ~ 99/000 ~ 479
- Note symbol:** Displays the note length closest to the value designated in Gate Time.
- Vel (Velocity):** 1 ~ 127

Bend (Pitch Bend)

Edits the Pitch Bend data (value).

SONG EDIT		M001 SONG=[Init Song 1]	
Tr1			
	Bend	Value	
001-01-000	Pitch Bend	+ 0	

[SEQ] INS CHNG

①

Settings:

- Value:** -8192 ~ +8191

PC (Program Change)

Edits the Program Change data (Bank MSB/LSB and Voice number). Voice will change when this event is encountered in a song.

SONG EDIT		M001 SONG=[Init Song 1]	
Tr1			
	PC	Bank	Num Name
001-01-000		000-000-001	[Init Voice]

[SEQ] INS CHNG

① ② ③ ④

Settings:

- Bank MSB (Bank MSB):** 000 ~ 127, *** (not assigned)
- Bank LSB (Bank LSB):** 000 ~ 127, *** (not assigned)
- NUM (Number):** 001 ~ 128
- Bank/Voice Name (displayed but not selectable)**

NOTE For more information about voice banks/numbers, see the Voice List in the separate Data List book.

CC (Control Change)

Edits the Control Change data (Control Number and its value).

SONG EDIT		M001 SONG=[Init Song 1]	
Tr1			
	CC	Control	Value
001-01-000		000: Bank MSB	0

[SEQ] INS CHNG

① ②

Settings:

- Control:** 000 ~ 127
- Value:** 0 ~ 127

NOTE For more information about Control Numbers, see the separate Data List book.

NOTE For more information about Control Change data, see the separate Data List book.

■ CAT (Channel After Touch)

Adjusts the Channel After Touch value. After Touch is applied to one channel (track).

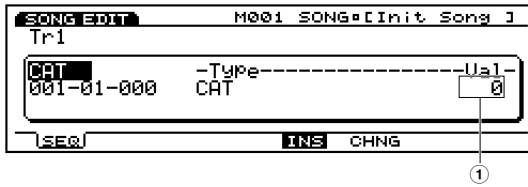

□ Settings:

- ① Value: 0 ~ 127

■ PAT (Polyphonic After Touch)

Edits the Polyphonic After Touch data (note and its value). After Touch is applied to each note individually.

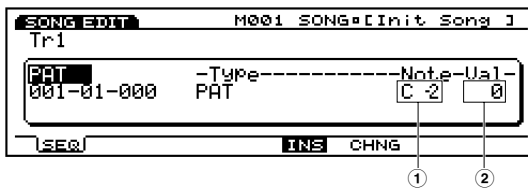

□ Settings:

- ① Note: C-2 ~ G8
- ② Value: 0 ~ 127

■ RPN (Registered Parameter Number)

Edits the Registered Parameter Number (RPN MSB/LSB and Data entry MSB/LSB).

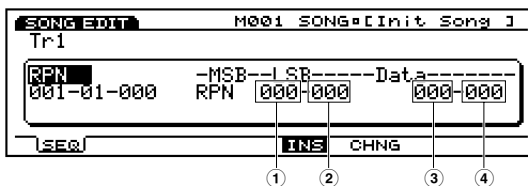

□ Settings:

- ① RPN MSB: 000 ~ 127
- ② RPN LSB: 000 ~ 127
- ③ Data (Data entry MSB): *** (not assigned), 000 ~ 127
- ④ Data (Data entry LSB): *** (not assigned), 000 ~ 127

■ NRPN (Non Registered Parameter Number)

Edits the Non Registered Parameter Number (NRPN MSB/LSB and Data entry MSB/LSB).

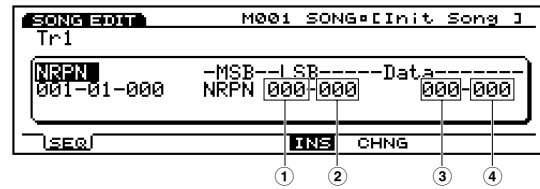

□ Settings:

- ① NRPN MSB: 000 ~ 127
- ② NRPN LSB: 000 ~ 127
- ③ Data (Data entry MSB): *** (not assigned), 000 ~ 127
- ④ Data (Data entry LSB): *** (not assigned), 000 ~ 127

■ Excl (System Exclusive)

Edits the System Exclusive messages (bytes).

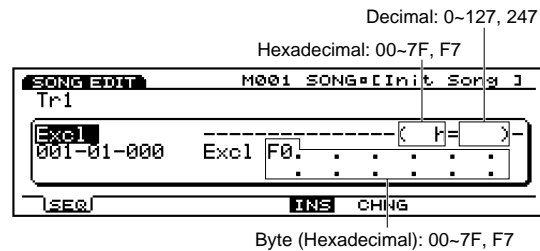

NOTE Although the F0 (Exclusive status), which indicates the beginning of the system exclusive message, will automatically be set and displayed at the beginning, you are required to enter the F7 (End of exclusive) manually at the end of the message.

NOTE For more information about system exclusive messages, see the separate Data List book.

Inserting Events

You can also insert new event data that is not included in the performance data.

- 1 When in the Song Play mode, press [EDIT] to enter the Song Edit mode.
- 2 Press [F1] (SEQ) to display the Sequence Track Event List.
- 3 Press Track [1 ~ 16] to select a track number to edit. The Event List of the selected track will be displayed.
 - NOTE** For the EX5R, select the track before entering Song Edit mode.
 - NOTE** You can scroll through the Event List and search for insert locations with the vertical ▲/▼ cursor keys. When the cursor is moved to an event, the note data will sound.
 - NOTE** If you press [CURSOR] key to turn its light on, Data Dial can be used to move the cursor quickly.
- 4 Press [F5] (INS: Insert) and the Insert pop-up menu will appear.

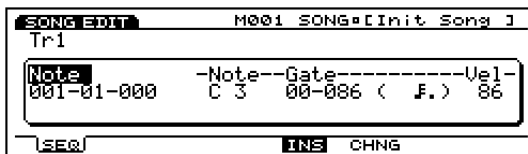

- 5 Move the cursor to the Event type at the top left side of the Insert pop-up menu and designate the type of event that will be inserted.
 - NOTE** For more information about types of events, see page 202.
- 6 Move the cursor to Measure/Beat/Clock and designate the detailed location.
- 7 Move the cursor to each parameter and designate the value for each.
- 8 Press [ENTER] to insert the event.

Changing Events

You can change the events in the performance data.

- 1 When in Song Play mode, press [EDIT] to enter Song Edit mode.
- 2 Press [F1] (SEQ) to display the Sequence Track Event List.

- 3 Press Track[1 ~ 16] to select a track number to edit. The Event List of the selected track will be displayed.
 - NOTE** For the EX5R, select the track before entering Song Edit mode.
 - NOTE** When you follow the steps above, CHNG is highlighted and is automatically selected. If necessary, press [F6] to select CHNG.
- 4 Move the cursor to the location of the event that you want to change, and edit the parameters.
 - NOTE** You can scroll through the Event List and search for event locations and select parameters with the vertical ▲/▼ cursor keys. Also you can move to a parameter with the horizontal ◀/▶ cursor keys. When the cursor is moved to an event, the note data will sound.
 - NOTE** If you press [CURSOR] key to turn its light on, Data Dial can be used to move the cursor quickly.
 - NOTE** For more information about types of events and parameters, see page 202.
- 5 Use [INC]/[DEC], Data Dial or numeric keypad to change and set values.
- 6 Press [ENTER] to execute the change.

Deleting Events

You can delete a specific event from the performance data.

- 1 When in Song Play mode, press [EDIT] to enter the Song Edit mode.
- 2 Press [F1] (SEQ) to display the Sequence Track Event List.
- 3 Press Track [1 ~ 16] to select a track number to edit. The Event List of the selected track will be displayed.
 - NOTE** For the EX5R, select the track before entering Song Edit mode.
- 4 Move the cursor to the location of the event that you want to delete.
- 5 Press [F8] [DEL] (Delete) to delete the currently selected event (the event where the cursor is located).

[F2]: PFX (Pattern Play Effects Track)

When editing the Pattern Play Effects Track, you can insert new Play Effects control data for each pattern track (1 ~ 8), as well as change the location and value of the existing event data. Press [F2] (PFX) to display the Pattern Play Effects Track Event List. [F5]INS (Insert) and [F6] CHNG (Change) functions are added to the menu. Also [F8] DEL (Delete) is added for deleting data.

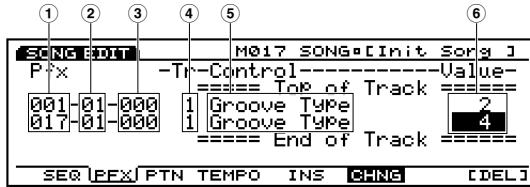

□ Settings:

- ① **Measure:** 1 ~ 999
- ② **Beat:** 1 ~ 16
- ③ **Clock:** 000 ~ 479
- ④ **Tr (Pattern Track):** 1 ~ 8
- ⑤ **Control (control type):** Groove Type
Quantize Strength
Groove Timing
Groove Velocity
Groove Gate Time
Gate Time Rate
Clock Offset
Velocity Rate
Velocity Offset
Transpose
- ⑥ **Value:** The values will differ depending on the type of control.

NOTE For more information about each type of control and values, see page 188.

Inserting Control Data

The basic steps are the same as those for inserting Sequence Tracks. Press [F2] (PFX) to select the Pattern Play Effects Track, and execute insertions.



Changing Control Data

The basic steps are the same as those for changing Sequence Tracks. Press [F2] (PFX) to select the Pattern Play Effects track, and execute changes.

NOTE In the Change display, the types of Controls cannot be changed. Changing the Control type is executed in inserting Control Data (page 204).

Deleting Control Data

The basic steps are the same as those for deleting Sequence Tracks. Press [F2] (PFX) to select the Pattern Play Effects track, and execute deletions.

[F3]: PTN (Pattern Track)

When editing the Pattern Tracks, you can change the recorded time signature and the patterns in measure units. Press [F3] (PTN) to display the Pattern Track Event List. [F6] CHNG (Change) function is added to the menu. Also [F8] CLR (Clear) is added for erasing data.

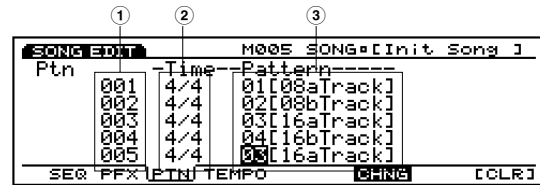

□ Settings:

- ① **Measure:** 001 ~ 999
- ② **Meter:** 1/4 ~ 8/4, 1/8 ~ 16/8, 1/16 ~ 16/16
- ③ **Pattern number:** off, 01 ~ 50, end

Changing the Time Signature And Patterns

The basic steps are the same as those for changing Sequence Tracks. Press [F3] (PTN) to select the Pattern track, and execute changes.

NOTE At the end of a song, select and enter the “end” for the pattern number. If “end” is not entered at the end, the song performance will not end at the desired location.

Clearing Patterns

The basic steps are the same as those for deleting Sequence Tracks. Press [F3] (PTN) to select a Pattern track, and execute Clear function.

NOTE Even though you clear a pattern, the time signature will not be cleared.

[F4]: TEMPO (Tempo Track)

When editing the Tempo Track, you can insert tempo data (tempo changes) as well as change the location and value of the current tempo data. Press [F4] (TEMPO) to display the Tempo Track Event List. [F5] INS (Insert) and [F6] CHNG (Change) functions are added to the menu. Also [F8] DEL (Delete) is added for deleting data.

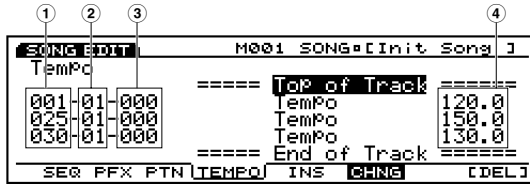

Settings:

- ① **Measure:** 1 ~ 999
- ② **Timing:** 1 ~ 16
- ③ **Clock:** 000 ~ 479
- ④ **Value:** 30.0 ~ 250.0

Inserting Tempo Data

The basic operations are the same as those for inserting Sequence Tracks. Press [F4] (TEMPO) to select the Tempo track, and execute insertions.

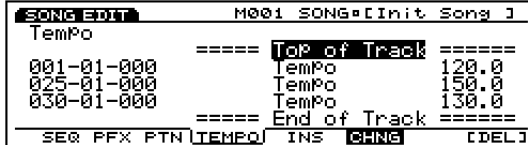

Changing Tempo Data

The basic operations are the same as those for changing Sequence Tracks. Press [F4] (PTN) to select the Tempo track, and execute changes.

Deleting Tempo Data

The basic operations are the same as those for deleting Sequence Tracks. Press [F4] (TEMPO) to select the Tempo track, and execute deletions.

Song Job Mode

Here are various jobs for songs that were created in Song Edit mode (or are being edited). These jobs which allow you to copy or erase, as well as many other operations, are executed by a measure or a track.

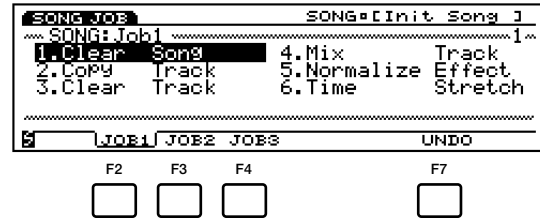

- [F2]: JOB1
- [F3]: JOB2
- [F4]: JOB3
- [F7]: UNDO/REDO

[SONG]		
└─[JOB]		
└─[F2:JOB1]	207
└─└─[Clear Song]	207
└─└─[Copy Track]	208
└─└─[Clear Track]	208
└─└─[Mix Track]	208
└─└─[Normalize Effect]	208
└─└─[Time Stretch]	208
└─[F3:JOB2]	209
└─└─[Copy Measure]	209
└─└─[Erase Measure]	209
└─└─[Create Measure]	209
└─└─[Delete Measure]	210
└─└─[Thin Out]	210
└─└─[Extract]	210
└─└─[Chord Sort]	211
└─└─[Chord Sparate]	211
└─[F4:JOB3]	212
└─└─[Quantize]	212
└─└─[Move Clock]	214
└─└─[Modify GateTime]	215
└─└─[Modify Velocity]	216
└─└─[Transpose]	217
└─└─[Shift Note]	217
└─└─[Crescendo]	217
└─└─[Shift Event]	218
└─[F7:UNDO]	218

Press [JOB] key on the panel while in Song mode to enter Song Job mode. When you enter the Song Job mode, the following menu will be displayed. There are 22 types of jobs in Song Job mode. The jobs are divided into three groups JOB1 ~ 3. Press [F2] (JOB1), [F3] (JOB2) or [F4] (JOB3) to select a menu. The Undo/Redo function is assigned to [F7] which cancels the changes you made in your most recent job operation.

Steps for Executing a Job

- 1 When in the Song Play mode, select the song track that you want to execute job operation.
- 2 Press [JOB] to enter the Song Job mode.
- 3 Press [F2] (JOB1), [F3] (JOB2) or [F4] (JOB3) to select a menu. The selected menu will be displayed.

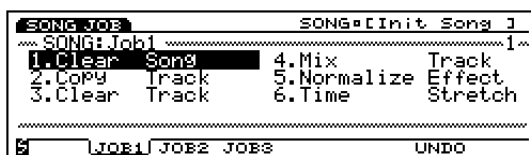

- 4 Move the cursor to a job and press [ENTER]. The selected job screen will be displayed.

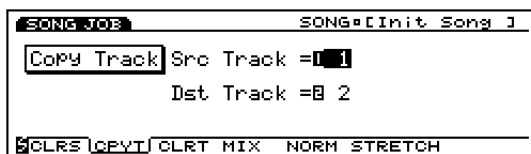

NOTE You can also display each job by pressing [F1] ~ [F8] while holding down [SHIFT].

- 5 Move the cursor to a parameter and use the [INC]/[DEC], Data Dial, numeric keypad, or the Knobs 1 ~ 6 to set values.

NOTE Depending on the selected job it may not be necessary to set values.

- 6 Press [ENTER]. The following pop-up menu will appear, prompting confirmation of the operation.

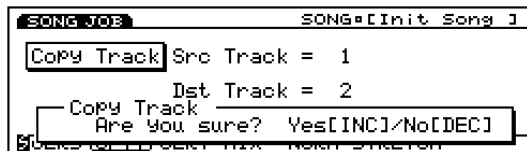

- 7 Press [YES] to execute the job. "Completed!" will momentarily appear in the screen indicating that the job has been executed and the previous screen will be displayed.

Press [NO] to cancel the job.

NOTE "Executing..." will appear when the Song Job takes some time to execute. Take note that if the power is turned off while "Executing..." is displayed, the data may be destroyed.

- 8 Press [EXIT] twice to exit the Song Job mode and return to the Song

[F2]: JOB 1

Press [F2] (JOB1) and JOB1 menu will be displayed. There are six jobs that are executed in units of song tracks.

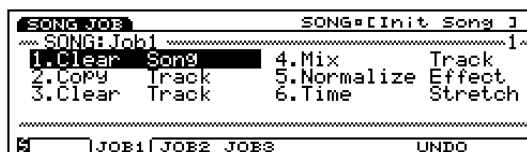

1. Clear Song (Erases all of the song data.)
2. Copy Track (Copies specific track data onto another track.)
3. Clear Track (Clears all data from the designated track.)
4. Mix Track (Mixes one track into another.)
5. Normalize Effect (Applies the Play Effects settings permanently to each track.)
6. Time Stretch (Expands or compresses all timing over designated range for specific track.)

1. Clear Song

This job erases all track data from a song and initializes the song's Play Effects and other settings.



2. Copy Track

This job copies all data from a specified track onto another. The song's Play Effects data and other settings are copied at the same time. This operation overwrites any data already existing on the destination track.

SONG JOB	SONG=[Init Song J]
Copy Track	Src Track = 0 1
	Dst Track = 0 2
<input type="checkbox"/> CLRS <input type="checkbox"/> CPYT <input type="checkbox"/> CLRT <input type="checkbox"/> MIX <input type="checkbox"/> NORM <input type="checkbox"/> STRETCH	

■ Src Track (Source Track)

Sets the source track that will be copied.

Settings: 1 ~ 16

■ Dst Track (Destination Track)

Sets the destination track that will be copied to.

Settings: 1 ~ 16

3. Clear Track

This job erases all data from a specified track.

SONG JOB	SONG=[Init Song J]
Clear Track	Track = 0 1
<input type="checkbox"/> CLRS <input type="checkbox"/> CPYT <input type="checkbox"/> CLRT <input type="checkbox"/> MIX <input type="checkbox"/> NORM <input type="checkbox"/> STRETCH	

■ Track

Sets the track that will be cleared.

Settings: 1 ~ 16 (Sequence tracks 1 ~ 16), ptn (Pattern track), pfx (Pattern Play Effect track), tempo, all (All tracks)

4. Mix Track

This job mixes all data from a specified sequence track (Mix source track) with another track's data (Mix destination track). When the operation is complete, the destination track contains both its original data and a copy of the source track's data.

SONG JOB	SONG=[Init Song J]
Mix Track	Src Track = 0 1
	Dst Track = 0 2
<input type="checkbox"/> CLRS <input type="checkbox"/> CPYT <input type="checkbox"/> CLRT <input checked="" type="checkbox"/> MIX <input type="checkbox"/> NORM <input type="checkbox"/> STRETCH	

■ Src Track (Source track)

Sets the Mix source track.

Settings: 1 ~ 16

■ Dst Track (Destination track)

Sets the Mix destination track.

Settings: 1 ~ 16

5. Normalize Effect

This job overwrites the data in the specified sequence track and applies the Play Effects settings (Page 187) permanently to that track. The Play Effects settings on the track will be reset to the initial status.

SONG JOB	SONG=[Init Song J]
Normalize Play Effect	Track = 0 1
<input type="checkbox"/> CLRS <input type="checkbox"/> CPYT <input type="checkbox"/> CLRT <input type="checkbox"/> MIX <input type="checkbox"/> NORM <input checked="" type="checkbox"/> STRETCH	

■ Track

Sets the track where Normalize Effect is executed.

Settings: 1 ~ 16 (Sequence tracks 1 ~ 16), all (All tracks)

6. Time Stretch

This job expands or compresses the timing over the designated range on the specified track. The operation affects all note step times, gate times, and event timing, expanding or compressing the entire designated range.

SONG JOB	SONG=[Init Song J]
Time Stretch	Track = 0 1
	Measure = 001 - 099
	Time = 0100 %
<input type="checkbox"/> CLRS <input type="checkbox"/> CPYT <input type="checkbox"/> CLRT <input type="checkbox"/> MIX <input type="checkbox"/> NORM <input checked="" type="checkbox"/> STRETCH	

■ Track

Sets the track where Time Stretch is executed.

Settings: 1 ~ 16 (Sequence tracks 1 ~ 16), all (All tracks)

■ Measure

Sets the measure range (beginning measure to the end measure) where Time Stretch is executed.

Settings: 001 ~ 999 (for the beginning measure and the end measure)

■ Time

Sets the ratio in percentages of the expansion or compression in the designated range.

Settings: 50 ~ 200 %

[F3]: JOB2

Press [F3] (JOB2) and JOB2 menu will be displayed. There are eight jobs that are executed in measure units.

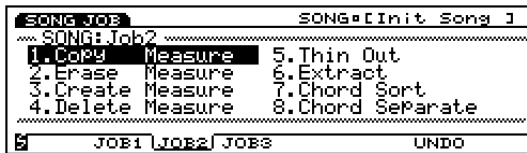

1. Copy Measure (Copies data in the designated range.)
2. Erase Measure (Erases data in the designated range.)
3. Create Measure (Inserts empty measures in all tracks.)
4. Delete Measure (Deletes specified measures from all tracks.)
5. Thin Out (Reduces data such as controller data.)
6. Extract (Extracts specific data from the designated range.)
7. Chord Sort (Sorts chordal note events, by pitch, over a designated range of a track.)
8. Chord Separate (Arranges chord notes in order with a specified interval.)

1. Copy Measure

This job copies all data from a specified range on a track onto another. It is possible to move data within the same track. This operation overwrites any data already existing on the destination track.



■ Src Track (source track)

Sets the source track that will be copied.

- ❑ **Settings:** 1 ~ 16 (Sequence tracks 1 ~ 16), ptn (Pattern track), pfx (Pattern Play Effect track), tempo, all (All tracks)

NOTE As for ptn (Pattern track), pfx (Pattern Play Effect track), tempo, and all (all tracks), the destination track can only copy from a source track that is the same as the destination. When “ptn,” “pfx,” “tempo,” or “all” is selected the destination track automatically changes to match the selection.

■ Src Meas (Source Measure)

Sets the range (the beginning measure and the end measure) in the source track.

- ❑ **Settings:** 001 ~ 999 (for the beginning measure and the end measure)

■ Dst Track (Destination Track)

Sets the destination track that will be copied to.

- ❑ **Settings:** 1 ~ 16 (Sequence tracks 1 ~ 16), ptn (Pattern track), pfx (Pattern Play Effect track), tempo, all (All tracks)

■ Dst Meas (Destination Measure)

Sets the first destination measure (the measure where copying will begin) that will be copied to.

- ❑ **Settings:** 001 ~ 999

■ Times

Sets the number of times copy will take place.

- ❑ **Settings:** 01 ~ 99

2. Erase Measure

This job erases all data from a specified range on a track. Even though the data is erased the empty measures still remain.



■ Track

Sets the track where Erase Measure will be executed.

- ❑ **Settings:** 1 ~ 16 (Sequence tracks 1 ~ 16), ptn (Pattern track), pfx (Pattern Play Effect track), tempo

■ Measure

Sets the measure range (beginning measure to the end measure) where Erase Measure is executed.

- ❑ **Settings:** 001 ~ 999 (for the beginning measure and the end measure)

3. Create Measure

This job inserts one or more empty measures onto all tracks (Sequence tracks 1 ~ 16, Pattern, Pattern Play Effect, and Tempo tracks) at the same time.

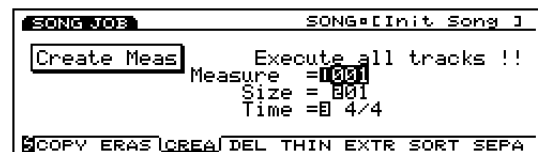

■ Measure

Sets the location (the beginning measure for insertion) where empty measures will be inserted.

□ **Settings:** 001 ~ 999

■ Size

Sets the number of empty measures that will be inserted.

□ **Settings:** 01 ~ 99

■ TIME

Sets the time signature for the empty measures.

□ **Settings:** 1/4 ~ 8/4, 1/8 ~ 16/8, 1/16 ~ 16/16

NOTE Since you can freely set the time signature, you can use Create Measure function to make a song in an odd meter.

4. Delete Measure

This job deletes a specified range of measures from a song. The specified range is removed from all tracks (sequence tracks 1 ~ 16, Pattern, Pattern Play Effect, and Tempo tracks) at the same time. Any measures which follow the last measure in the specified range will move forward to fill the gap.

```

SONG JOB                                SONG=[Init Song J]
Delete Meas                             Execute all tracks !!
                                         Measure = 0001 - 9999
COPY ERAS CREA DEL THIN EXTR SORT SEPA
  
```

■ Measure

Sets the measure range (beginning measure to the end measure) where Delete Measure is executed.

□ **Settings:** 001 ~ 999 (for the beginning measure and the end measure)

5. Thin Out

This job removes every other occurrence of a designated non-note event from the specified track range. The purpose is to reduce the amount of data and free up additional memory.

NOTE When the interval of each event is larger than 60 clocks, data is not removed.

```

SONG JOB                                SONG=[Init Song J]
Thin Out                                 Track = 01
                                         Measure = 0001 - 9999
                                         Events = 0CC0001:ModWheel
COPY ERAS CREA DEL THIN EXTR SORT SEPA
  
```

■ Track

Sets the track where Thin Out will be executed.

□ **Settings:** 1 ~ 16 (Sequence tracks 1 ~ 16), tempo

■ Measure

Sets the measure range (beginning measure to the end measure) where Thin Out is executed.

□ **Settings:** 001 ~ 999 (for the beginning measure and the end measure)

■ Events

Sets the type of event that will be reduced. When “CC” (Control Change) is selected, a setting parameter will be added, and the control number can be designated there.

When “tempo” is selected in Track, the tempo change is automatically set in Events. Therefore, this setting is not necessary.

□ **Settings:** Pitch Bend, Control Change (Control numbers range from 000 ~ 127), Ch After Touch (Channel After Touch), PolyAfter Touch (Polyphonic After Touch)

6. Extract

This job moves all instances of specific data from a designated range of a sequence track to the same range on a different sequence track. Following the operation, the targeted events no longer exist in the source track. If data already existed at the destination, the extracted data and existing data are mixed.

You can also use this job to delete the specified event data rather than move it. You can do this by setting the extract destination track to “off.”

```

SONG JOB                                SONG=[Init Song J]
Extract                                 Track = 01  → 01
                                         Measure = 0001 - 9999
                                         Events = Note
                                         Range = C 2  G 8
COPY ERAS CREA DEL THIN EXTR SORT SEPA
  
```

Track

Select the track that will be extracted from (Extract source) and the track that will be copied to (Extract destination).

Settings:

Extract Source: 1 ~ 16

Extract Destination: 1 ~ 16, off (extracted data is deleted)

Measure

Sets the measure range (beginning measure to the end measure) where Extract is executed.

Settings: 001 ~ 999 (for the beginning measure and the end measure)

Events

Sets the type of event that will be extracted.

When an event other than "Sys. Exclusive" is selected, additional parameters for the event range will be added, and you can designate the range.

Settings: Note, Program Change, Pitch Bend, Control Change, Ch After Touch (Channel After Touch), PolyAfterTouch (Polyphonic After Touch), Sys.Exclusive(System Exclusive)

Event Range

Sets the range you want to extract the event. The unit of the value differs depending on the selected event.

Note: C-2 ~ G8

Program Change, Control Change (Control number), Ch After Touch, PolyAfterTouch: 0 ~ 127

Pitch Bend: -8192 ~ +8192

7. Chord Sort

This job "sorts" chordal note events (simultaneous note events) by order of pitch. The notes can be either sorted from the highest pitch to the lowest or from the lowest pitch to the highest. The chords within the designated range of the specified sequence track can be sorted. For example, if notes E3, C3, and G3 all begin at the same time, the job arranges the order to C3, E3, G3 (if set to "up order") to G3, E3, C3 (if set to "down order").

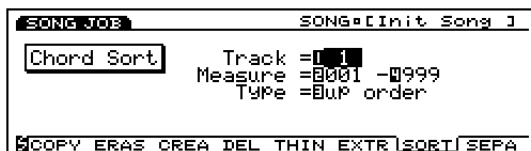

Track

Sets the track where Chord Sort will be executed.

Settings: 1 ~ 16 (Sequence tracks 1 ~ 16)

Measure

Sets the measure range (beginning measure to the end measure) where Chord Sort is executed.

Settings: 001 ~ 999 (for the beginning measure and the end measure)

Type

Sets the type of Chord Sort. When "up order" is selected, chords are sorted from the lowest pitch to the highest, while selecting "down order" will sort from the highest pitch to the lowest.

Settings: up order, down order

8. Chord Separate

This job arranges chord notes in order with a specified interval (within the designated range of the specified sequence track). For example, if the Clock value is set to 30, a block chord consisting of C3,E3,G3 will be played as a C3 (at the chords original timing) followed 30 clocks later by the E3, and then another 30 clocks later by the G3. This feature can separate any chord easily and is useful, for example, when you want to simulate guitar strokes.

NOTE It is not possible to break chord over the next measure boundary or into the next chord.



Track

Sets the track where Chord Separate will be executed.

Settings: 1 ~ 16 (Sequence tracks 1 ~ 16)

Measure

Sets the measure range (beginning measure to the end measure) where Chord Separate is executed.

Settings: 001 ~ 999 (for the beginning measure and the end measure)

Clock

Sets the clock interval inserted between adjacent notes.

Settings: 1 ~ 999

[F4]: JOB3

Press [F4] (JOB3) and JOB3 menu will be displayed. There are eight jobs that are effective for note event data on a specified track.

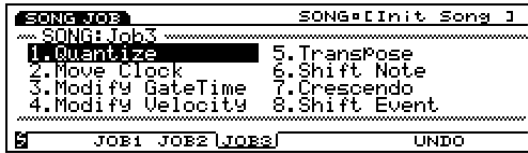

1. Quantize (Corrects the timing of the notes in a designated range.)
2. Move Clock (Moves all of the events in a designated range.)
3. Modify GateTime (Changes the note gate times [length] in a designated range.)
4. Modify Velocity (Changes the note velocities in a designated range.)
5. Transpose (Transposes all notes over a selected range.)
6. Shift Note (Replaces all instances of a selected note with the specified replacement, over a designated range.)
7. Crescendo (Gradually increases or decreases the note velocities over a designated range.)
8. Shift Event (Changes one event type into another, over a designated range.)

1. Quantize

This job quantizes note events over a specified range of a designated track. You can use this feature, for example, to correct the imperfect timing of a performance you have recorded in real time.

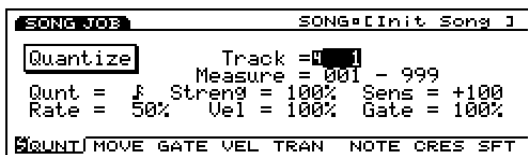

The Quantize Strength and Sensitivity functions allow you to get a variety of settings. The Strength setting varies the degree of the quantize value, and the Sensitivity setting designates the range to be applied. You can combine these settings, for example, to slightly adjust only those notes that are far away from the quantizing line, or the original quantize value, while leaving the closer notes untouched.

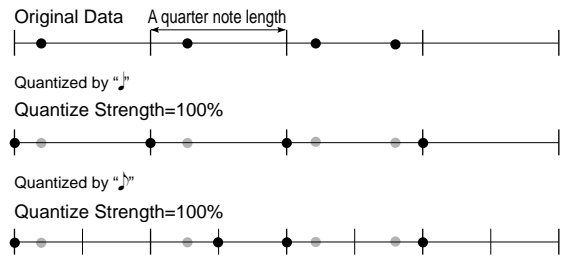

Also, the Rate setting will add a “swing” to the rhythm. This setting allows you to slightly delay the note events in every even-numbered beats, thereby giving the music a “swing” feel. If you are using an eighth-note quantizing value, for example, the delay will be applied to the note events at the second, fourth, sixth, and eighth beats in the measure.

You can further improve the swing by changing the velocity and gate time of the delayed note events.

■ Track

Sets the track where Quantize will be executed.

- Settings:** 1 ~ 16 (Sequence tracks 1 ~ 16)

■ Measure

Sets the measure range (beginning measure to the end measure) where Quantize is executed.

- Settings:** 001 ~ 999 (for the beginning measure and the end measure)

■ Qunt (Quantize Value)

Sets the standard note value by which Quantize corrects timing.

♩+♩♯ uses the 16th note and 16th note triplet as its standard note values, and ♪+♪♯ uses the 8th note and 8th note triplet as its standard note values. If you use the quantize value, 16th note triplet or 8th note triplet, for the song which contains the 16th notes (or 8th notes) and 16th note triplets (or 8th note triplets), all the notes will be quantized to the triplet timing, and this may ruin the song. In such cases, if you use the ♩+♩♯ or ♪+♪♯ for the standard note values, the notes closer to the 16th note (or 8th note) timing will be treated as the 16th notes (or 8th notes) and those closer to the 16th note triplet (or 8th note triplet) timing as the 16th note triplets (or 8th note triplets), and thus the problem can be solved.

- Settings:** ♩, ♩♯, ♪, ♪♯, ♩, ♩♯, ♪, ♪♯, ♩, ♩+♩♯, ♪+♪♯

■ Streng (Quantize Strength)

When quantizing, the Strength value sets the degree how much the timing of the note events is moved toward the quantizing line, or the original quantize value.

A setting of 100 % moves each note event all the way to the quantizing line. A setting of 50 % moves each note only halfway to the quantizing line.

□ **Settings:** 0 % ~ 100 %

■ Sens (Quantize Sensitivity)

The Sensitivity lets you designate the range to which quantize setting is applied. The range of data to be quantized is indicated in percentage (%) values.

In the diagram below a 100 % value means that a half of the quantize value extends to the right (forward) and left (backward) of the quantizing line. If, for example, the quantize value is a quarter note, the Sensitivity value of 100 % indicates the eighth note positions at the far right and far left from the quantizing line.

If you set the Sensitivity to 100 % (or -100 %), then quantizing applies to all notes.

If you set the Sensitivity to 50 %, then quantizing applies only to notes in the half-interval span surrounding the quantizing line. As in the previous example, with a 50 % sensitivity with a quarter note quantizing value, then all notes within a 16th note to either side of the line are affected, while notes that are farther away are left untouched.

If you set the Sensitivity to -50 % with a quarter note quantize value, this would quantize all notes that are more than a 16th note away from the quantizing line, while leaving closer notes unaffected. In a word, you use positive values when you want to shift only notes that are closest to the line and negative values to shift only notes that are farthest away from the line.

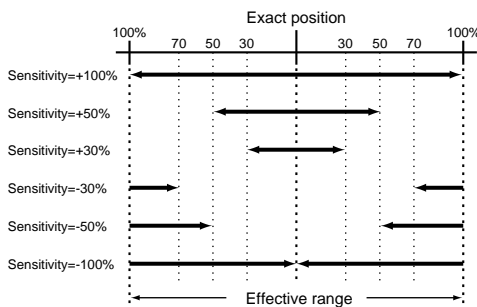

□ **Settings:** -100 % ~ +000 % ~ + 100 %

NOTE Use of this feature allows you to correct notes that are markedly off time while retaining the subtle discrepancies untouched. To achieve this kind of result, you would generally want to set the sensitivity between approximately -30 % and -50 % to quantize notes that are quite far away from the quantize note.

■ Rate (Swing Rate)

This setting allows you to slightly delay the note events in every even-numbered beats of the set quantize value, thereby giving the rhythm a “swing” feel. If you are using one of the triplet quantize values, then the EX applies the delay to the notes in every third beat in the triplet. If you are using the ♪♩ or ♪♩♩ quantizing value, the EX applies the delay only to the even-numbered beats.

Swing Rate (in percentages), how far the note shifts, can be set from the length of two or three quantize values. Available Rate settings will differ depending on the quantize value.

When the quantize value is ♪, ♪♩, ♪♩♩, ♪♩♩♩ :

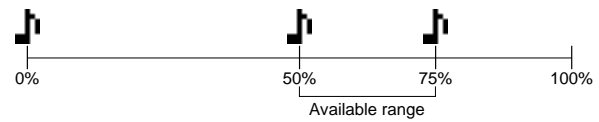

In this case, 100 % represents double the length of the quantize value. Therefore the original position of the even-numbered beats which will be affected by the Rate setting is 50 %.

A 50 % setting produces no adjustment so that the even-numbered beat remains exactly centered without any swing.

Values higher than 50 % shift the timing forward, to produce a “swing” feel for the rhythm.

The maximum value, 75 %, shifts the timing to one-half the quantizing value (a dotted note).

When the quantize value is $\downarrow \text{♩}$, $\downarrow \text{♩}$, $\downarrow \text{♩}$:

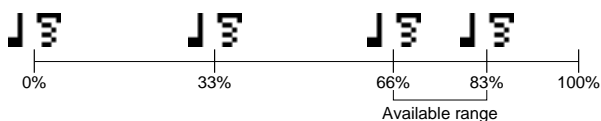

In this case, 100 % represents three times the length of the quantize value. Therefore the original position of the third beat in the triplet which will be affected by the Rate setting is 66 %.

A 66 % setting produces no adjustment so that the third beat in the triplet remains at its original position without any swing.

Values higher than 66 %, shift the timing forward, to produce a “swing” feel for the rhythm.

The maximum value, 83 %, shifts the timing to one-half the quantizing value (a sextuplet).

When the quantize value is $\downarrow + \downarrow \text{♩}$ or $\downarrow + \downarrow \text{♩}$:



In this case, 100 % represents double the length of \downarrow or \downarrow value. Therefore the original position of the even-numbered beat (the second note) which will be affected by the Rate setting is 50 %.

A 50 % setting produces no adjustment so that the even-numbered beat remains at its original position without any swing.

Values higher than 50 % shift the timing forward, to produce a “swing” feel for the rhythm.

The maximum value, 66 %, shifts the timing to the third beat in the triplet.

Settings:

When the quantize value is \downarrow , \downarrow , \downarrow , \downarrow :
50 % ~ 75 %

When the quantize value is $\downarrow \text{♩}$, $\downarrow \text{♩}$, $\downarrow \text{♩}$:
66 % ~ 83 %

When the quantize value is $\downarrow + \downarrow \text{♩}$ or $\downarrow + \downarrow \text{♩}$:
50 % ~ 66 %

NOTE If you set Quantize Strength below 100 %, the shifted notes may lie at the later timings than the following normal notes. In this case, the EX will shift all of the following notes by an equal amount.

Vel (Swing Velocity)

This setting allows you to change the velocity of the note events in every even-numbered beats of the set quantize value, thereby giving the rhythm a “swing” feel.

Remember that velocity is the strength at which key is pressed. You can use this setting, therefore, to increase or decrease the strength of the notes in every even-numbered beats.

A setting of 100 % leaves the original velocity unchanged. Settings below 100 % decrease the velocity of the notes in every even-numbered beats, while settings above 100 % increase it.

The velocity value doesn’t exceed the upper and lower limits, 1 and 127.

Settings: 0 % ~ 100 % ~ 200 %

Gate (Swing Gate Time)

This setting allows you to change the gate time of the note events in every even-numbered beats of the set quantize value, thereby giving the rhythm a “swing” feel.

The gate time is the length of time that a note is actually played. You can use this setting, therefore, to lengthen or shorten the notes in every even-numbered beats.

A setting of 100 % leaves the original gate time unchanged. Settings below 100 % shorten the gate time of the notes in every even-numbered beats, while settings above 100 % lengthen it.

The gate time value doesn’t exceed the lower limit, 1.

Settings: 0 % ~ 100 % ~ 200 %

2. Move Clock

This job shifts all event data for the specified range of the designated sequence track by clock units. This job will never move an event beyond the specified range’s start or end point; any event that would otherwise move beyond this point is instead deposited at the beginning or end of the range.



NOTE If you wish to move events by measures, you may find it easier to use the Copy Measure job (Page 209).

Track

Sets the track where Move Clock will be executed.

□ **Settings:** 1 ~ 16 (Sequence tracks 1 ~ 16), pfx, tempo

Measure

Sets the measure range (beginning measure to the end measure) where Move Clock is executed.

□ **Settings:** 001 ~ 999 (for the beginning measure and the end measure)

Clock

Sets the distance that data is moved forward or backward. Note that there are 480 clock per beat when setting the distance that the data will be moved.

□ **Settings:** -9999 ~ +0 ~ +9999

3. Modify GateTime

This job alters the gate time of the notes in the specified range. The gate time indicates the length of time that a note is held. For sustained voices, the gate time is equal to the actual playback time span. You can modify the gate time using two types of parameters: the Rate and Offset.

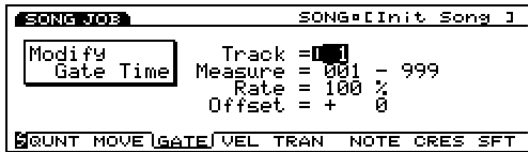

The modified gate time will be obtained based on the formula below.

$$\text{Modified gate time} = \text{original gate time} \times \text{Rate} + \text{Offset value}$$

The gate time value doesn't exceed the lower limit, 1.

Track

Sets the track where Modify GateTime will be executed.

□ **Settings:** 1 ~ 16 (Sequence tracks 1 ~ 16)

Measure

Sets the measure range (beginning measure to the end measure) where Modify Gate Time is executed.

□ **Settings:** 001 ~ 999 (for the beginning measure and the end measure)

Rate

Increases or decreases the gate time of all notes in the designated range by multiplying the Rate value. A setting of 100 % produces no change. A setting less than 100 % will produce a shorter gate time, whereas a setting above 100 % produces a longer gate time.

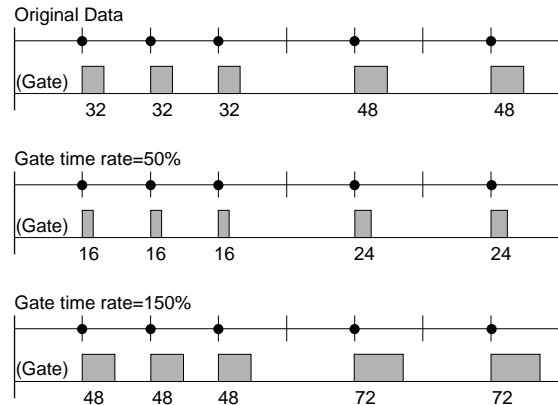

□ **Settings:** 000 % ~ 100 % ~ 200 %

Offset

Increases or decreases the gate time of all notes in the designated range by adding the Offset value. A setting of 0 produces no change. Negative values decrease the gate time, while positive values increase it.

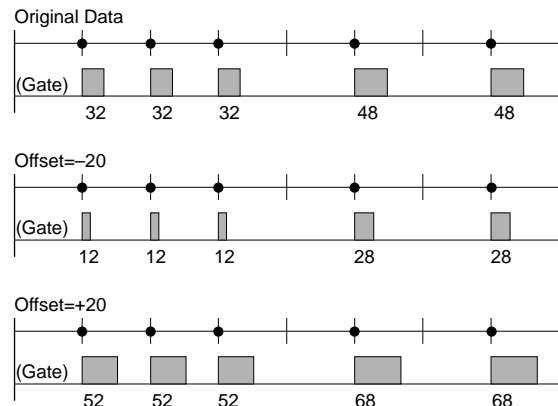

□ **Settings:** -9999 ~ +0 ~ +9999

4. Modify Velocity

This job alters the velocity of the notes in the specified range. The velocity refers to the strength at which a key is pressed. You can change the velocity using two types of parameters: the Rate and Offset.

NOTE The volume may differ depending on the selected voice that has a different velocity settings in the Voice Edit mode.

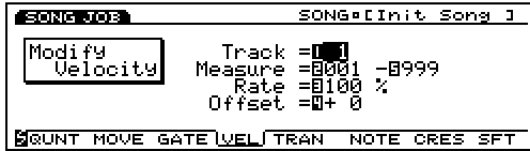

The modified velocity value will be obtained based on the formula below.

$$\text{Modified velocity} = \text{original velocity value} \times \text{Rate} + \text{Offset value}$$

The velocity value doesn't exceed the upper and lower limits, 1 and 127.

Track

Sets the track where Modify Velocity will be executed.

Settings: 1 ~ 16 (Sequence tracks 1 ~ 16)

Measure

Sets the measure range (beginning measure to the end measure) where Modify Velocity is executed.

Settings: 001 ~ 999 (for the beginning measure and the end measure)

Rate

Increases or decreases the velocity of all notes in the designated range by multiplying the Rate value. A setting of 100% produces no change. A setting less than 100% will decrease the velocity, whereas a setting above 100% increase it.

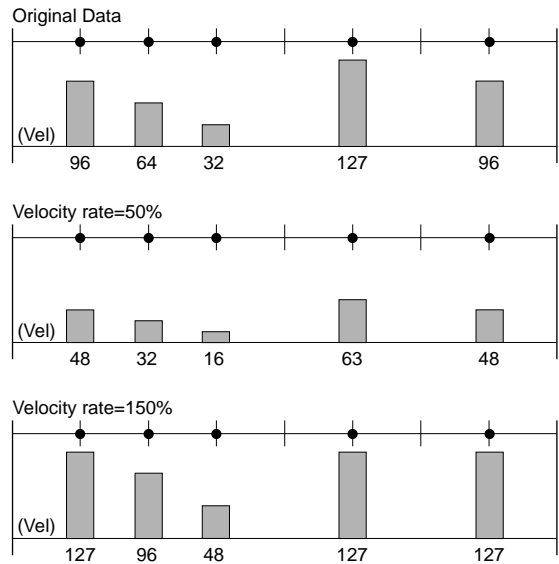

Settings: 000% ~ 100% ~ 200%

Offset

Increases or decreases the velocity of all notes in the designated range by adding the Offset value. A setting of 0 produces no change. Negative values decrease the velocity, while positive values increase it.

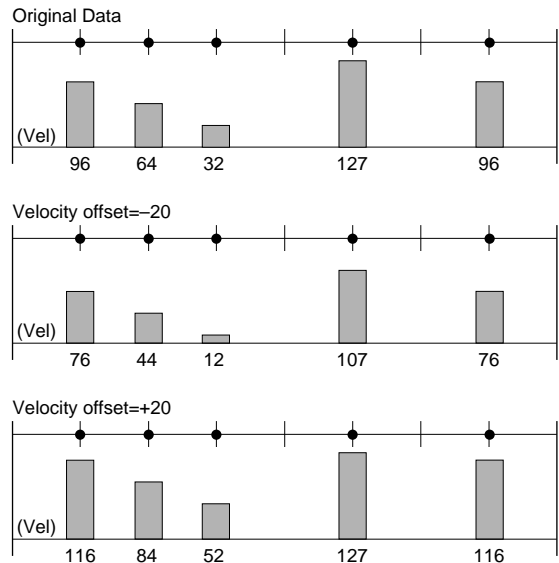

Settings: -99 ~ +00 ~ +99

5. Transpose

This job lets you transpose in semitones the notes in the designated range of a specified sequence track.



■ Track

Sets the track where Transpose will be executed.

Settings: 1 ~ 16 (Sequence tracks 1 ~ 16)

■ Measure

Sets the measure range (beginning measure to the end measure) where Transpose is executed.

Settings: 001 ~ 999 (for the beginning measure and the end measure)

■ Transpose

Sets the transposition value (semitones). A value of +12 transposes all targeted notes up exactly by one octave, while a value of -12 transposes down by a octave.

Settings: -99 ~ +0 ~ +99

6. Shift Note

This job replaces all occurrences of a specified pitch (within the designated range of the specified sequence track) with some other pitch.



■ Track

Sets the track where Shift Note will be executed.

Settings: 1 ~ 16 (Sequence tracks 1 ~ 16)

■ Measure

Sets the measure range (beginning measure to the end measure) where Shift Note is executed.

Settings: 001 ~ 999 (for the beginning measure and the end measure)

■ FromNote (source note)

Sets the source pitch that will be changed.

Settings: C-2 ~ G8

■ To Note(destination note)

Sets the destination pitch.

Settings: C-2 ~ G8

7. Crescendo

This job gradually increases or decreases the volume of your performance. This job produces the crescendo (increasing) or diminuendo (decreasing) effect by applying a gradual change to the velocity of a designated range of a specified track.



■ Track

Sets the track where Crescendo will be executed.

Settings: 1 ~ 16 (Sequence tracks 1 ~ 16)

■ Measure

Sets the measure range (beginning measure to the end measure) where Crescendo is executed.

Settings: 001 ~ 999 (for the beginning measure and the end measure)

■ Range

Sets the amount of the crescendo/diminuendo. You can specify the final velocity value to be reached at the end of the designated range. Positive settings will produce a crescendo, while negative settings produce a diminuendo. The velocity value doesn't exceed the upper and lower limits, 1 and 127.

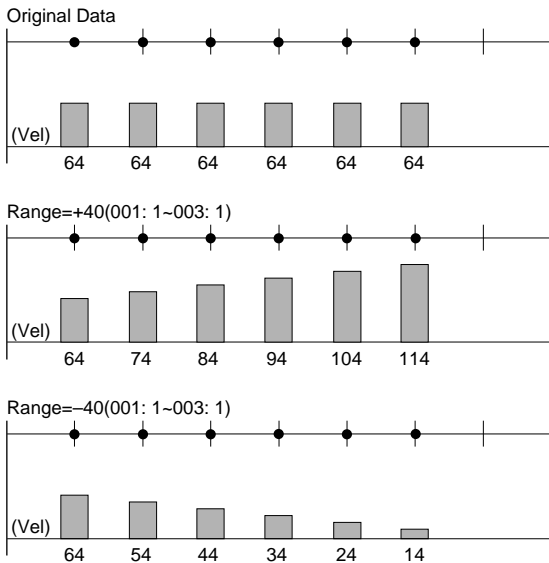

❑ **Settings:** -99 ~ +0 ~ +99

8. Shift Event

This job replaces all occurrences of a specific event type (within the designated range of the specified sequence track) with some other designated event type. For example, you can use this function to change breath controller data into channel aftertouch events.

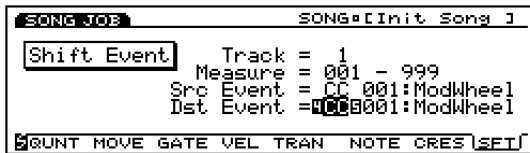

■ Track

Sets the track where Shift Event will be executed.

❑ **Settings:** 1 ~ 16(Sequence tracks 1 ~ 16)

■ Measure

Sets the measure range (beginning measure to the end measure) where Shift Event is executed.

❑ **Settings:** 001 ~ 999 (for the beginning measure and the end measure)

■ Src Event (Source Event)

Selects the source that will be changed.

❑ **Settings:** Control Change, Ch After Touch (Channel After Touch), Pitch Bend, Note (Note#: note numbers), Note (Vel: velocity values of each note)

■ Dst Event (Destination Event)

Sets the destination event that the source event is changed to.

❑ **Settings:** Control Change, Ch After Touch (Channel After Touch), Pitch Bend, Note (Note#: the data change of the source event will be replaced with note numbers with the fixed velocity 64 and fixed gate time 108), Note (Vel: the data change of the source event will be replaced with velocities with the fixed pitch C3 and fixed gate time 108).

[F7]: UNDO/REDO

Undo/Redo function is assigned to [F7]. Undo cancels the changes you made in your most recent record, edit, or job operation, restoring the data to its previous state. Redo, which becomes available only after you execute an Undo, cancels Undo operation and restores the changes. When you inadvertently execute a job, make a mistake while recording or editing, this job is convenient for restoring important data that would otherwise be lost.

Undo/Redo is always effective after a record, edit, and job operation. As soon as you execute an Undo, the job name changes to REDO. UNDO and REDO alternately appear after Undo/Redo operation. If data is not changed, Undo/Redo will not become effective.

Steps for Executing Undo/Redo

① Press [F7] (UNDO/REDO and the UNDO/REDO screen will be displayed.

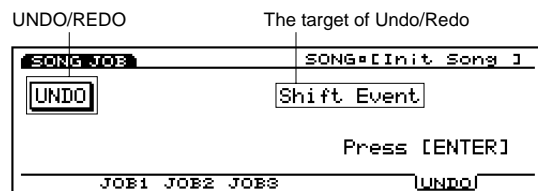

UNDO/REDO:

Available operation, UNDO or REDO, is displayed.

The target of Undo/Redo:

The target of Undo/Redo function will be displayed, that is, the most recent record, edit, or job operation name.

② Press [ENTER] to execute Undo/Redo. “Completed!” will appear in the screen indicating that the cancellation was executed and the previous screen will be displayed.

NOTE If [F7] (UNDO) is pressed without any previous operation taking place, “Undefined job” will be displayed and Undo cannot be executed.

Pattern Mode

Pattern Play Mode

This mode uses the internal sequencer to play patterns and has various functions related to playing patterns. You can enter Pattern Record mode from Pattern Play mode and record patterns, a maximum of 50. These patterns can be used to create a song. For organizing your patterns after they have been recorded, store them on floppy disk so that you can make use of them whenever you like.

NOTE Patterns are configured with several tracks up to 16 measures and always play back in a loop (repeatedly).

NOTE For more information about the sequencer, see page 60.

Press [PATTERN] key on the panel to enter Pattern Play mode. When you enter the Pattern Play mode, the following menu screen will be displayed. In the Pattern Play mode there are four types of menus.

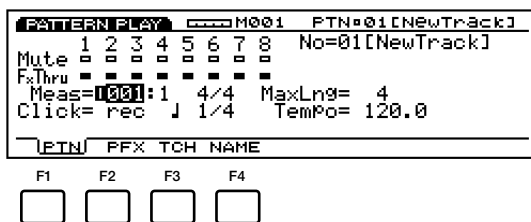

- [F1]: PTN (Settings related to playing patterns)
- [F2]: PFX (Settings related to Play Effects)
- [F3]: TCH (Settings related to the track transmit channels)
- [F4]: NAME (Settings related to naming patterns)

NOTE You cannot enter Pattern mode when [ARPEGGIO] key or [KEYMAP] key is turned on.

[F1]: PTN (Pattern)

These parameters are used to set the Mute and Play Effects Thru functions for each pattern track (1-8 tracks). They can be set to “on” or “off.” There are also settings related to playing patterns such as Tempo.

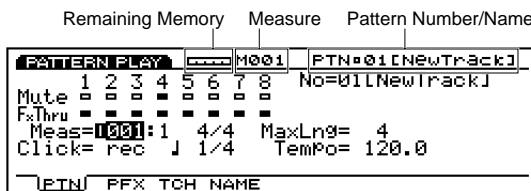

■ Remaining Memory

This bar graph indicates the amount of memory available for recording, or the remaining memory of the internal sequencer. This is common for all the internal sequencer functions, Song, Pattern and Arpeggio.

■ Measure/PTN (Pattern Name)

The pattern number/name and the current measure number will be displayed. These items cannot be modified.

Track Section

These settings are used to set the Mute and Play Effects Thru to “on” or “off” for each track even during pattern playback.

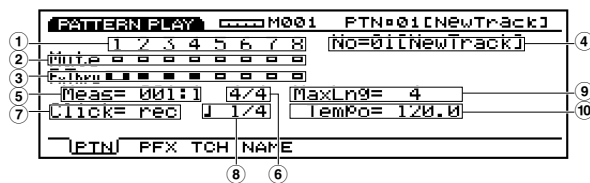

■ ① Track Number

One pattern consists of 1 ~ 8 sequence tracks. The Track Number is highlighted (box colored black) for tracks that have been recorded on and contain data.

■ ② Mute

Sets Mute for a track, by moving the cursor to the Mute line, and using Data Dial or [INC]/[DEC] to select “on” or “off.” As shown in the screen, the box colored black indicates that Mute is turned “on.” When Mute is turned “on,” that track is muted during playback, and the sound is temporarily suspended. When Mute is turned “off,” only the outline of the box is displayed, Mute is canceled, and sound will once again be produced.

③ Play Effects Thru

Sets FxThru (Play Effects Thru) for a track, by moving the cursor to FX Thru line, and using Data Dial or [INC]/[DEC] to select “on” or “off.” As shown in the screen, the box colored black indicates that FxThru is turned “on.” When FxThru is turned “on” for a track, Play Effects are temporarily bypassed during playback. When FxThru is turned “off,” only the outline of the box is displayed, the FxThru function is canceled, and Play Effect settings become effective once again.

NOTE When the cursor is on the Mute or FxThru line, you can select a track by pressing corresponding TRACK [1 ~ 8] key on the panel (EX5/7 only). You can directly set the Mute or FxThru to “on” or “off” by holding the [F1] PTN key and pressing the targeted TRACK [1 ~ 8] key as far as the cursor is on the Mute or FxThru line.

④ No (Pattern Number)

Selects the Pattern Number that will play back. To the right of the Pattern Number the pattern name will be displayed.

□ **Settings:** 01-50

⑤ Meas (Measure)

Sets and indicates the Measure and Beat numbers for the currently selected pattern. Allows you to set by measures.

□ **Settings:** The setting will differ depending on the length of the pattern (001-016).

NOTE The sequencer [REW] and [FWD] keys can also be used for rewinding and fast forwarding, and [TOP] key returns you to the first measure of the pattern.

⑥ Time Signature

Indicates the time signature of a pattern. Setting the time signature is accomplished in the Pattern Record mode (page 223).

⑦ Click (Click Mode)

Sets the sound mode for the metronome (Click). There are four modes, “off” (does not sound), “rec” (sounds during recording), “play” (sounds during playback and while recording), and “all” (sounds always). This function is convenient for playing in time, when performing or recording.

□ **Settings:** off, rec, play, all

⑧ Metronome (Click) Beat

Sets the beat (note unit) for when the metronome (Click) will sound.

□ **Settings:** 1/4, 1/8, 1/16

⑨ MaxLng (Maximum Length)

Shows the length of the longest track, set in the “Length” of [F2]: PFX screen.

⑩ Tempo

Sets the tempo for the pattern that is played.

□ **Settings:** 30.0 ~ 250.0

About Pattern Playback Control

Pattern playback is controlled with the sequencer keys. The pattern will always automatically play in a loop, from when you start the pattern until when you stop it.

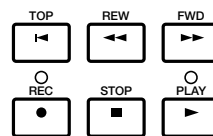

[TOP]: Returns the pattern to the first measure.

[REW]: (Rewind): Rewinds through the pattern measure numbers.

[FWD]: (Forward): Fast Forwards through the pattern measure numbers.

[REC]: (Recording): Engages the Pattern Record mode.

[STOP]: Stops playback.

[PLAY]: Begins playback.

[F2]: PFX (Play Effects)

These settings are related to Play Effects. The Play Effects function lets you temporarily adjust the velocity and the sound timing of MIDI notes. You can change the playback groove without altering the original data. Also you can apply various grooves to a pattern by using the 100 different types of groove templates or create your original groove templates. Different Play Effects can be set to each track.

Press [F2], the PFX screen appears and [F5] (All), [F6] (TR), and [F8] (GROOVE) functions are added to the screen. Pressing [F8] key opens the Groove Template screen, where you can make your own groove templates and confirm the contents of the preset groove templates.

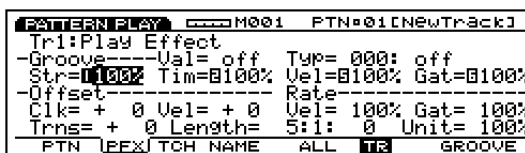

Steps for Setting the Play Effects

1 Start pattern playback.

Press [PLAY] key for pattern playback to begin.

NOTE Play Effects can be set when the pattern is stopped, and also can be set in real time when the pattern is playing back. This lets you check the effect that results from the Play Effects.

2 Select [F5] ALL or [F6] TR.

When you want to apply the same Play Effects to all tracks, press [F5] to select ALL(All tracks). On the other hand, when you want to set the Play Effects differently for each track individually, press [F6] to select TR(each track).

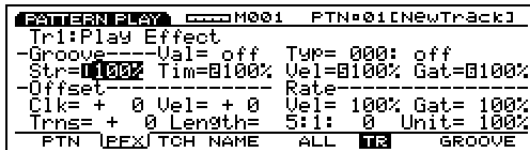

3 Select the track to which you want to apply the Play Effects.

When you select TR (each track) in step 2 above, select a track from the eight tracks, Tr 1-8.

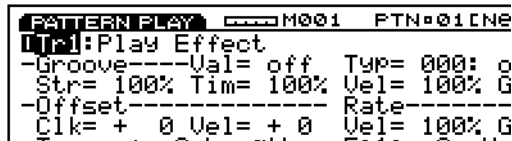

NOTE This step is unnecessary when you select ALL (All Tracks) in step 2 above.

4 Set the length of the loop.

Move the cursor to Length (measure/beat/clock), and set the length of the playback loop (a set phrase is repeated). The length set here determines the pattern playback loop.

5 Select a groove template.

Move the cursor to Type and select a groove template. When a User groove template is selected, continue by moving the cursor to Val (Value), and select a Quantize value.

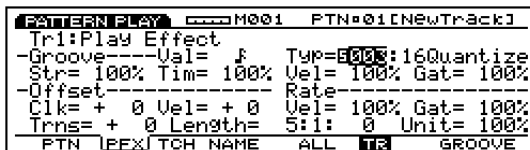

NOTE When a template is selected from the 1 ~ 100 Preset groove templates, the Quantize value can be confirmed, but not changed.

6 Set other parameters.

Set other parameters as necessary.

7 Set the Play Effects for other tracks.

Repeat the above steps 3 ~ 6 and set the Play Effects settings for the necessary tracks.

These parameters are the same as those explained for the PFX screen in Song Play mode. Therefore, only the parameters that differ will be explained. For information on the parameters, see page 187.

The parameters that are not in the PFX screen of the Song Play mode, are added to the bottom of the PFX screen of the Pattern Play mode.

Length (Loop Length)

Sets and displays the loop length (measure/beat/clock) for each track. Here you can set the length of each track to determine the length of each loop that is played back. You can change the loop length for each track and therefore for example, as shown in the next diagram, a one measure bass line loop can have one Play Effects settings, while the four measure rhythm loop can have different Play Effects settings. Through combining the two, you can play even more complicated grooves.

NOTE Before recording the pattern, set the length for each track here.

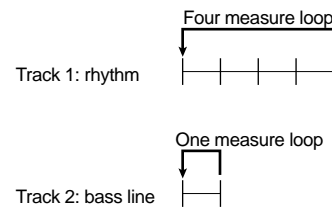

Measure Number

Displays and sets the currently selected track measure number.

Settings: 1 ~ 16

Beat Number

Displays and sets the currently selected track beat number. Available settings will differ depending on the current time signature.

Settings: 1 ~ 8

■ Clock Number

Displays and sets the currently selected track clock number. Available settings will differ depending on the current time signature.

□ **Settings:** 000 ~ 479

■ Unit

You can extend or shorten each track playback time. For example, a setting of 200 % will make the playback time twice as long and result in a tempo that is half as fast. Conversely, a setting of 50 % will make the playback time half as long and the tempo will become twice as fast. When set to 100 %, the original data time does not change. Changing the speed of each track's sequence data lets you create interesting rhythms such as polyrhythms.

□ **Settings:** 50 %, 66 %, 75 %, 100 %, 133 %, 150 %, 200 %

[F5]: ALL [F6]: TR(Track)

When [F5]: ALL is selected, all changes to be made will be effective for all the tracks.

When [F6]: TR is selected, all changes to be made will be effective for the specified track.

[F8]: GROOVE (Groove Template)

Press [F8] (GROOVE) and the GROOVE screen will be displayed. Here you can create your own User template for patterns or confirm the contents of a Preset groove template. Also the [F6] COPY function is added to the screen.

The groove templates give you instant access to add groove feeling to your pattern by changing the timing of the pattern data using the Play Effects function. Each groove template contains the parameters in one measure.

A User template can be created by copying a template from the 100 types of Preset groove templates and making necessary adjustments or you can create a template by setting all the parameters from scratch.

All of the GROOVE screen parameters and settings being used for pattern tracks (tracks1 ~ 8) are the same as those in the GROOVE screen of the Song Play mode. For more information, see page 190.

NOTE Copy function is inactive when "off" is selected for TYPE.

[F3]: TCH (Transmit Channel)

Sets the transmit channel for each track and where data is sent. Move the cursor to a parameter, set the switch to "on" or "off," and set the MIDI channel by using [INC]/[DEC].

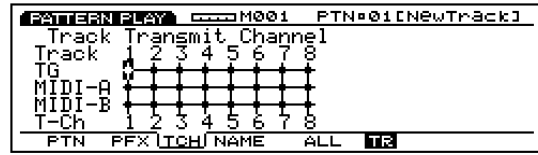

NOTE Press the TRACK [1-8] to select each track number (EX5/7 only).

■ TG (Tone Generator)

Sets whether or not each track's data is output to the internal tone generator.

□ **Settings:** + (is output), ÷ (is not output)

■ MIDI-A/MIDI-B (MIDI OUT A/B)

Sets whether or not each track's data is output from MIDI OUT A/B to an external device.

□ **Settings:** + (is output), ÷ (is not output)

NOTE "MIDI B" is inactive on EX5R and EX7.

■ T-Ch (Transmit Channel)

Sets the MIDI transmit channel for each track.

□ **Settings:** 1 ~ 16

[F4]: NAME (Pattern Name)

Lets you name a pattern using up to a maximum of eight letters and/or numbers.



NOTE The procedure for naming a pattern is the same as naming a song. See page 192.

Pattern Record Mode

In Pattern Record mode there are two methods available for recording patterns, real time recording and step recording. There are also various functions related to recording patterns and a maximum of 50 patterns can be stored in the internal memory. For organizing your patterns, they can be stored to floppy disk so that you can make use of them whenever you like.

Real Time Recording: Just like a multi-track recorder, the actual performance is recorded as you play. Because the performance is recorded exactly as played, the subtle nuances and feeling of the recording are accurately expressed.

Step Recording: Just like writing music on a music score, each note is programmed in separately. You can confirm each beat of the measure in the screen as you perform operations. Therefore this type of recording is perfect for programming repetitive patterns and phrases, basic rhythms and bass lines that require precision. This method of recording is also convenient for inputting the trigger timing of sample loops for break beats.

Previously made patterns are useful for creating songs. A variety of basic accompaniment patterns can be created, stored, and easily programmed (recorded) in any order, on any pattern track in Song Record mode (see page 193). In this way, it is possible to make an accompaniment section for a song quickly. The eight pattern tracks and 16 song tracks share the same 16 parts of the tone generator. Set the MIDI channels in a way that prevents the parts from overlapping.

How to Enter the Pattern Record Mode

When in the Pattern Play mode, press the sequencer [REC] (Recording) key. The [REC] light will be lit indicating that Pattern Record mode has been engaged, and is now in standby status.

Press [REC] once more or [STOP] to return to Song Play mode.

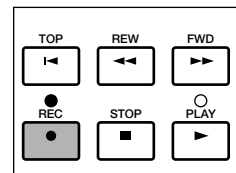
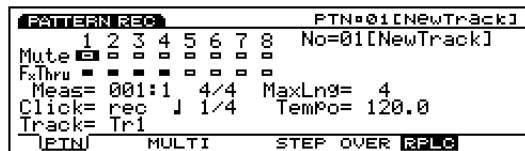

NOTE For information on the basics of the sequencer, see page 60.

When you enter the Pattern Record mode, the menus below appear in the screen. There are five menus in the Pattern Record mode.

NOTE Before entering the Pattern Record mode, create the performances (page 156) that you want to use.

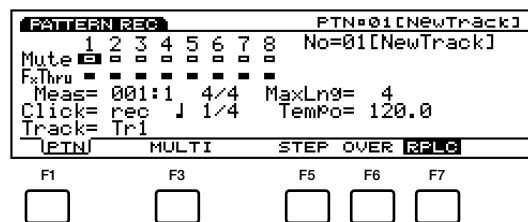

[F1]: PTN (Settings related to recording patterns)

Recording Mode

[F4]: MULTI (Selecting Multi mode)

[F5]: STEP (Selecting Step recording)

[F6]: OVER (Select Overdubbing)

[F7]: RPLC (Selecting Replace recording)

[F1]: PTN (Pattern)

These are various settings related to recording a pattern, such as selecting a track for recording, and setting the time signature and tempo. In addition to those settings, there are Mute on/off and Play Effects Thru on/off for each of the playback tracks (tracks 1 ~ 8).

Many of the parameters here are found in Pattern Play mode (page 219). Only the parameters that differ from those described in Pattern Play mode will be explained.

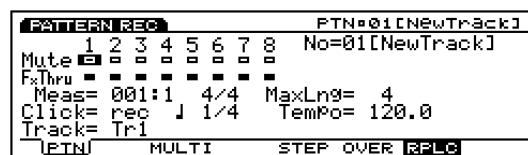

■ No (Pattern Number)

Selects the pattern number of the pattern that will be recorded. The pattern name will be displayed to the right of the pattern number.

□ **Settings:** 01 ~ 50

■ Meas (Measure)

The Measure/Beat numbers will be displayed but cannot be changed. The start position for recording is fixed to “001: 1.”

■ Time Signature

Sets the time signature for a pattern.

□ **Settings:** 1/4 ~ 8/4, 1/8 ~ 16/8, 1/16 ~ 16/16

NOTE You can change the time signature after recording.

■ Track

Selects the track for recording. Tracks 1 ~ 8 can also be selected using the TRACK [1 ~ 8] (EX5/7 only).

□ **Settings:** Tr1 ~ 8(tracks1 ~ 8)

NOTE The pattern tracks 1 ~ 8 are positioned in the same line at the top of the screen.

Recording Mode

In the Pattern Record mode various recording modes have been assigned to[F3] and [F5] ~ [F7].

[F3]: MULTI

Sets MULTI mode to “on” or “off.” Press [F3], MULTI is highlighted, MULTI mode is turned on, and all the tracks can be recorded in real time. This type of recording is mainly utilized when using an external sequencer. For example, on the currently selected track, (the track selected in the parameters), the performance on the EX 5/7 keyboard is recorded, while at the same time performance data is recorded on other tracks from an external sequencer.

NOTE In MULTI mode, you can select either Over Dubbing or Replace type of recording.

NOTE When MULTI mode is set to “off,” real time recording can only take place on one specified track at a time.

[F5]: STEP

Sets the STEP recording mode to “on” or “off.” Press [F5], STEP is highlighted and the Step recording mode is turned on. Then notes can be programmed in one at a time. Press [F6] ~ [F7] to cancel Step recording mode and return to real time recording.

NOTE When STEP is not highlighted, real time recording is always engaged.

[F6]: OVER(Over Dubbing)

Sets the OVER dubbing recording to “on” or “off.” Press [F6], OVER is highlighted and the OVER Dubbing is turned on. When recording in real time, you can record over previously recorded data. For example, after first recording a bass drum, you can use this function to record a snare and high hat on top without erasing the original data. Press [F5]/[F7] to cancel the Over Dubbing recording.

[F7]: RPLC(Replace)

Sets Replace recording to “on” or “off.” Press [F7], RPLC is highlighted and the Replace recording is turned on. When recording in real time, you can record over previously recorded data (erasing and replacing the original data with the new data as you record). Press [F5]/[F6] to cancel the Replace recording.

Real Time Recording

Real Time recording is just like a multi-track recorder where you record as you play on each track (Tr1-8). There are two types of recording methods, Over Dubbing (recording over original data but not erasing it) and Replace (erasing and replacing the original data). Also there is Multi mode, that when set to “on,” (lets you record on all the tracks simultaneously) and when set to “off,” (lets you record one track at a time).

- 1 In the PTN display of Pattern Play mode, select a pattern number (01-50) to be recorded.
- 2 In the PFX display of Pattern Play mode, set the Length (loop length) for each track (1-8).
- 3 In Pattern Play mode, press [REC] to enter Pattern Record mode (stand-by record status).
- 4 In the PTN display, set the necessary settings for recording, such as the time signature and tempo, as well as the click.

- 5 Select the track (Tr1-8) for recording with the Track parameter.
- 6 Select one of the following recording modes: [F6] (Over Dubbing) or [F7] (Replace). To record on all the tracks simultaneously, press [F3] (MULTI), Multi mode is turned on and highlighted.

7 Press [PLAY] and recording will begin after a two measure countdown. Record something by playing the keyboard. The [PLAY] green light will blink in sync with the metronome click.

NOTE During the two measure countdown, Meas (measure) will display the countdown from -2 to -1.

8 Press [STOP] to stop recording, the EX automatically returns to the Pattern Play mode.

NOTE When you start realtime recording [F8] (DEL: Delete) will be added to the screen. In the middle of realtime recording you can delete an unnecessary sound by pressing the appropriate key while holding down [F8] (DEL). This is effective for the notes appeared during the delete operation.

NOTE After you have finished recording, there are various edit functions that let you correct misplayed notes or the timing in the Pattern Edit mode (page 226) and the Pattern Job mode (page 227).

3 When in Pattern Play mode, press [REC] to enter Pattern Record mode (record stand-by status).

4 Set the time signature for recording in the PTN display.

5 Set the beginning measure number for recording with the Meas parameter.

6 Select the track (Tr1-8) for recording with the Track parameter.

7 Press [F5] (STEP) to select the Step recording mode.

8 Press [PLAY], the [PLAY] green light will be lit, and the Step Recording screen will be displayed.

9 Set the note length and the velocity, and input the note with the keyboard. The ↓ cursor automatically moves forward a distance equal to the length of the note that was just input.

10 Repeat step 9 above, and program in one note at a time.

11 Press [STOP] to stop recording. The EX automatically returns to Pattern Play mode.

NOTE After you have finished recording, there are various edit functions in Pattern Edit mode (page 226) and Pattern Job mode (page 227).

Step Recording

In Step recording the performance data (note length, pitch, and velocity) is programmed one note at a time.

Step Recording Screen

When in Step Recording (after you press [PLAY]), the following screen will be displayed.

All of these functions are the same as those explained in STEP recording of the Song Record mode. For more information about each parameter and the ways to input notes, see page 198.

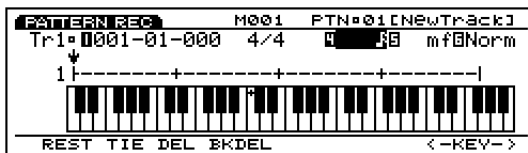

The Procedure for Step Recording

- 1 When in the PTN display of Pattern Play mode, select a pattern number (01-50) to record.
- 2 In the PFX display of Pattern Play mode, set the Length (loop length) for each track (1-8).

Pattern Edit Mode

Press [EDIT] key on the panel while in Pattern mode to enter Pattern Edit mode. In Pattern Edit mode, you can edit events of patterns for each sequence track 1 ~ 8, that were recorded in real time or in step recording.

[F5] INS (Insert) allows you to insert new events and [F6] CHNG (Change) is for changing the position or value of previously existing data. [F8] DEL (Delete) lets you delete unnecessary events.

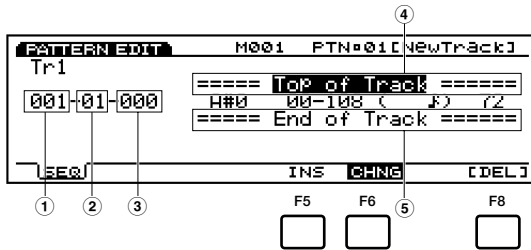

- ① **Measure:** 1 ~ 16 (maximum value will change depending on the Length setting)
- ② **Beat:** 1 ~ 16 (maximum value will change depending on the Beat setting)
- ③ **Clock:** 000 ~ 479
- ④ **Top of Track (indicates the beginning of the track)**
- ⑤ **End of Track (indicates the end of the track)**

[F5]: INS(Insert: insert a new event)

[F6]: CHNG (Change: change the position or value of an event)

[F8]: DEL (Delete: delete an event)

NOTE Undo/Redo function in Pattern Job mode allows you to cancel the edit operation you have done or execute the operation again.

Event Data That Can Be Edited

Event data that can be edited is the same as those for the sequence tracks 1 ~ 16 in the Song Edit mode, for more information see page 202.

Inserting Events

You can insert new event data that is not included in the pattern data.

- ① When in the Pattern Play mode, press [EDIT] to enter the Pattern Edit mode. The Event List will be displayed.

- ② Press Track [1 ~ 8] to select a track number to edit. The Event List of the selected track will be displayed.

NOTE For the EX5R, select the track before entering Pattern Edit mode.

NOTE You can scroll through the Event List and search for insert locations with the vertical ▲/▼ cursor keys. When the cursor is moved to an event, the note data will sound.

NOTE If you press [CURSOR] key to turn its light on, Data Dial can be used to move the cursor quickly.

- ③ Press [F5] (INS: Insert) and the Insert pop-up menu will appear.

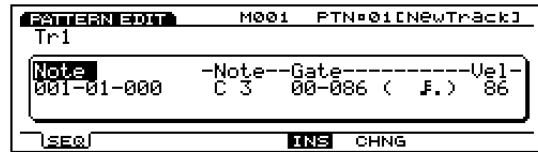

- ④ Move the cursor to the Event type at the top left side of the Insert pop-up menu and designate the type of event that will be inserted.

NOTE For more information about types of events and parameters, see page 202.

- ⑤ Move the cursor to Measure/Beat/Clock and designate the detailed location.

- ⑥ Move the cursor to each parameter and designate the value for each.

- ⑦ Press [ENTER] to insert the event.

Changing Events

You can change the events in the pattern data.

- ① When in Pattern Play mode, press [EDIT] to enter Pattern Edit mode.

- ② Press Track [1 ~ 8] to select a track number to edit (EX5/7 only). The Event List of the selected track will be displayed.

NOTE When you follow the steps above, CHNG is highlighted and is automatically selected. If necessary, press [F6] to select CHNG.

- 3 Move the cursor to the location of the event that you want to change, and edit the parameters.

NOTE You can scroll through the Event List and search for event locations and select parameters with the vertical ▲/▼ cursor keys. Also you can move to a parameter with the horizontal ◀/▶ cursor keys. When the cursor is moved to an event, the note data will sound.

NOTE If you press [CURSOR] key to turn its light on, Data Dial can be used to move the cursor quickly.

NOTE For more information about types of events and parameters, see page 202.

- 4 Use [INC]/[DEC], Data Dial or numeric keypad to change and set values.

- 5 Press [ENTER] to execute the change.

Deleting Events

You can delete a specific event from the pattern data.

- 1 When in Pattern Play mode, press [EDIT] to enter the Pattern Edit mode.
- 2 Press Track [1 ~ 8] to select a track number to edit (EX5/7 only). The Event List of the selected track will be displayed.
- 3 Move the cursor to the location of the event that you want to delete.
- 4 Press [F8] [DEL] (Delete) to delete the currently selected event (the event where the cursor is located).

Pattern Job Mode

Here are various jobs for patterns that were created in Pattern Record/Edit mode. These jobs which allow you to copy or erase, as well as many other operations, are executed by the measure or the track.

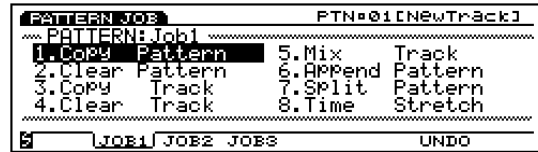

- [F2]: JOB1
- [F3]: JOB2
- [F4]: JOB3
- [F7]: UNDO/REDO

[PATTERN]		
└─[JOB]		
└─[F2:JOB1]	228
└─└─[Copy Pattern]	229
└─└─[Clear Pattern]	229
└─└─[Copy Track]	229
└─└─[Clear Track]	229
└─└─[Mix Track]	229
└─└─[Append Pattern]	230
└─└─[Split Pattern]	230
└─└─[Time Stretch]	231
└─[F3:JOB2]	231
└─└─[Copy Measure]	231
└─└─[Erase Measure]	231
└─└─[Get Phrase]	232
└─└─[Put Phrase]	232
└─└─[Thin Out]	232
└─└─[Extract]	233
└─└─[Chord Sort]	233
└─└─[Chord Separate]	234
└─[F4:JOB3]	234
└─└─[Quantize]	234
└─└─[Move Clock]	235
└─└─[Modify GateTime]	235
└─└─[Modify Velocity]	235
└─└─[Transpose]	236
└─└─[Shift Note]	236
└─└─[Crescendo]	236
└─└─[Shift Event]	237
└─[F7:UNDO]	237

Press [JOB] key on the panel while in Pattern mode to enter Pattern Job mode. When you enter the Pattern Job mode, the following menu will be displayed. There are 24 types of jobs in Pattern Job mode. The jobs are divided into three groups JOB1 ~ 3. Press [F2] (JOB1), [F3] (JOB2) or [F4] (JOB3) to select a menu. The Undo/Redo function is assigned to [F7] which cancels the changes you made in your most recent job operation.

Steps for Executing a Job

- 1 When in the Pattern Play mode, select the pattern that you want to execute job operation.
- 2 Press [JOB] to enter the Pattern Job mode.
- 3 Press [F2] (JOB1), [F3] (JOB2) or [F4] (JOB3) to select a menu. The selected menu will be displayed.

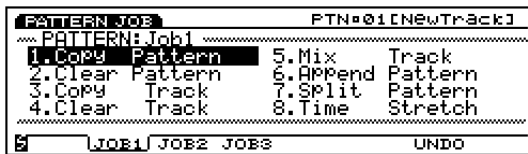

- 4 Move the cursor to a job and press [ENTER]. The selected job screen will be displayed.

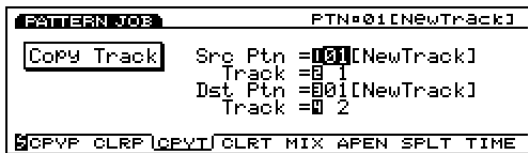

NOTE You can also display each job by pressing [F1] ~ [F8] while holding down [SHIFT].

- 5 Move the cursor to a parameter and use the [INC]/[DEC], Data Dial, numeric keypad, or the Knobs 1 ~ 6 to set values.

NOTE Depending on the selected job it may not be necessary to set values.

- 6 Press [ENTER]. The following pop-up menu will appear, prompting confirmation of the operation.

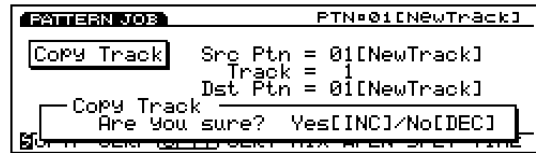

- 7 Press [YES] to execute the job. “Completed!” will momentarily appear in the screen indicating that the job has been executed and the previous screen will be displayed.

Press [NO] to cancel the job.

NOTE “Executing...” will appear when the Pattern Job takes some time to execute. Take note that if the power is turned off while “Executing...” is displayed, the data may be destroyed.

- 8 Press [EXIT] twice to exit the Pattern Job mode and return to the Pattern Play mode.

[F2]: JOB 1

Press [F2] (JOB1) and JOB1 menu will be displayed. There are eight jobs that are executed in units of patterns or respective tracks.

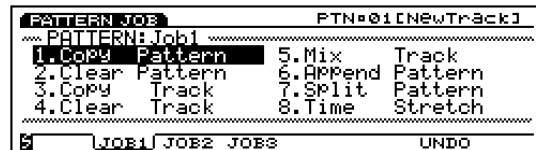

1. Copy Pattern (Copies all pattern data onto another pattern.)
2. Clear Pattern (Clears all data from a pattern.)
3. Copy Track (Copies specific track data onto another track.)
4. Clear Track (Clears all data from designated track.)
5. Mix Track (Mixes one track into another.)
6. Append Pattern (Appends one pattern to another.)
7. Split Pattern (Splits pattern into two patterns.)
8. Time Stretch (Expands or compresses timing over designated range for specific track.)

1. Copy Pattern

This job copies all data from a source pattern to a designated destination pattern. The pattern's Play Effects data and other settings are also copied simultaneously.

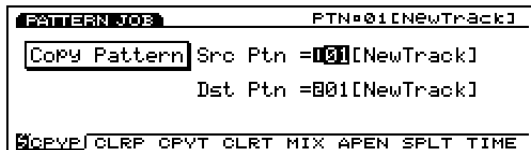

■ Src Ptn (Source Pattern)

Sets the source pattern number that will be copied.

□ Settings: 1 ~ 50

■ Dst Ptn (Destination Pattern)

Sets the destination pattern number that will be copied to.

□ Settings: 1 ~ 50

2. Clear Pattern

This job erases all data from a pattern and initializes the pattern's Play Effects and other settings.

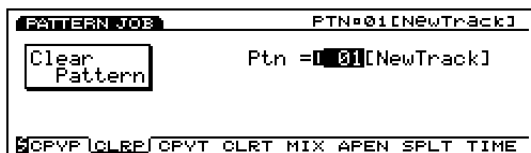

■ Ptn

Sets the pattern number of the pattern that will be cleared.

□ Settings: 1 ~ 50

3. Copy Track

This job copies all data from a specified track onto another. The pattern's Play Effects data and other settings are also copied simultaneously. This operation overwrites any data already existing on the destination track.

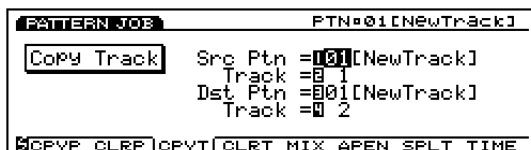

■ Src Ptn (Source Pattern)

Sets the source pattern number.

□ Settings: 1 ~ 50

■ SrcTrk (Source Track)

Sets the source track that will be copied.

□ Settings: 1 ~ 8

■ Dst Ptn (Destination Pattern)

Sets the destination pattern number.

□ Settings: 1 ~ 50

■ Dst Trk (Destination Track)

Sets the destination track that will be copied to.

□ Settings: 1 ~ 8

4. Clear Track

This job erases all data from a specified track of the currently selected pattern. In this case, the job also initializes all Play Effects and other settings for that track.



■ Track

Sets the track that will be cleared.

□ Settings: 1 ~ 8, all

5. Mix Track

This job mixes all data from a specified sequence track (Mix source track) of the currently selected pattern with another track's data (Mix destination track). When the operation is complete, the destination track contains both its original data and a copy of the source track's data.

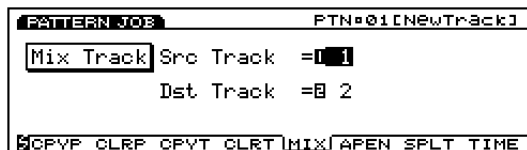

■ Src Track (source track)

Sets the Mix source track.

Settings: 1 ~ 8

■ Dst Track (Destination track)

Sets the Mix destination track.

Settings: 1 ~ 8

6. Append Pattern

This job lets you connect the data of two specific tracks to complete a pattern. A source pattern (Append source pattern) is connected to the end of a destination pattern (Append destination pattern).

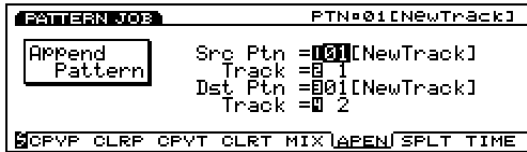

■ Src Ptn (Source Pattern)

Sets the Append source pattern number.

Settings: 1 ~ 50

■ SrcTrk (Source Track)

Sets the Append source pattern track that will be copied to the destination pattern.

Settings: 1 ~ 8

■ Dst Ptn (Destination Pattern)

Sets the Append destination pattern number.

Settings: 1 ~ 50

■ Dst Track (Destination Track)

Sets the Append destination pattern track.

Settings: 1 ~ 8

7. Split Pattern

This job splits track data of a pattern (Split source pattern) at a specified measure and moves the latter half of the split track data to the beginning of the track of another pattern (Split destination pattern). The former half of the split track data remains in its original location.

The job overwrites any data already existing in the destination location.

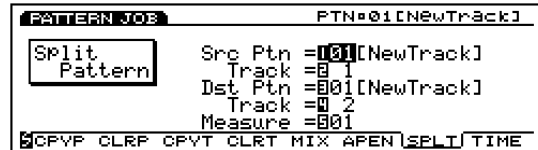

■ Src Ptn (Source Pattern)

Sets the Split source pattern number.

Settings: 1 ~ 50

■ SrcTrack (Source Track)

Sets the Split source pattern track.

Settings: 1 ~ 8

■ Dst Ptn (Destination Pattern)

Sets the Split destination pattern number that will be moved to.

Settings: 1 ~ 50

■ Dst Track (Destination Track)

Sets the Split destination pattern track that will be moved to.

Settings: 1 ~ 8

■ Measure

Sets the measure number in the designated source pattern track (this measure number marks the beginning of the latter half data).

Settings: 1 ~ 16

8. Time Stretch

This job expands or compresses the timing over the designated range on the specified track. The operation affects all note step times, gate times, and event timing, expanding or compressing the entire designated range.

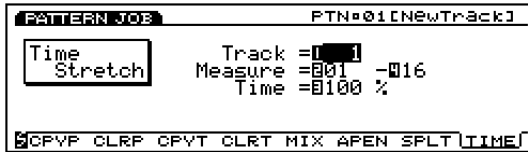

Track

Sets the track where Time Stretch is executed.

Settings: 1 ~ 8, all

Measure

Sets the measure range (beginning measure to the end measure) where Time Stretch is executed.

Settings: 01 ~ 16 (for the beginning measure and the end measure)

Time

Sets the ratio in percentages of the expansion or compression in the designated range.

Settings: 50 ~ 200 %

[F3]: JOB2

Press [F3] (JOB2) and JOB2 menu will be displayed. There are eight jobs that are executed in measure units.

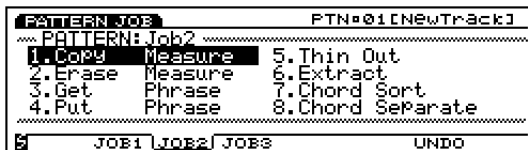

1. Copy Measure (Copies data in the designated range.)
2. Erase Measure (Erases data in the designated range.)
3. Get Phrase (Borrows sequence data from a song track.)
4. Put Phrase (Copies a pattern track data into song sequence track.)
5. Thin Out (Reduces data such as controller data.)
6. Extract (Extracts specific data from the designated range.)
7. Chord Sort (Sorts chordal note events, by pitch, over a designated range of a track.)
8. Chord Separate (Arranges chord notes in order with a specified interval.)

1. Copy Measure

This job copies all data from a specified range on a track onto another. It is also possible to copy data within the same track. This operation overwrites any data already existing on the destination track.

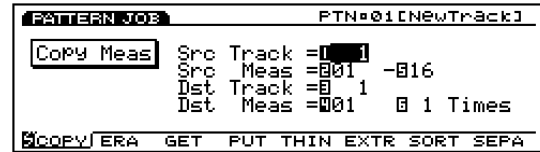

Src Track (Source Track)

Sets the source track that will be copied.

Settings: 1 ~ 8, all

Src Meas (Source Measure)

Sets the range (the beginning measure and the end measure) in the source track.

Settings: 01 ~ 16 (for the beginning measure and the end measure)

Dst Track (Destination Track)

Sets the destination track that will be copied to.

Settings: 1 ~ 8, all

Dst Meas (Destination Measure)

Sets the first destination measure (the measure where copying will begin) that will be copied to.

Settings: 01 ~ 16

Times

Sets the number of times copy will take place.

Settings: 1 ~ 16

2. Erase Measure

This job erases all data from a specified range on a track. Even though the data is erased the empty measures still remain.

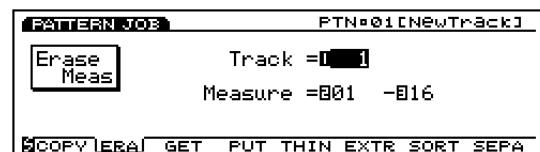

Track

Sets the track where Erase Measure will be executed.

Settings: 1 ~ 8, all

■ Measure

Sets the measure range (beginning measure to the end measure) where Erase Measure is executed.

- Settings:** 01 ~ 16 (for the beginning measure and the end measure)

3. Get Phrase

This job borrows sequence data from a song track onto the currently selected pattern track. The job overwrites any data already existing in the destination track.

NOTE The maximum length of the measures to be taken in are 16. If you attempt to borrow the data longer than 16 measures, the error message will be displayed and Get Phrase cannot be executed.

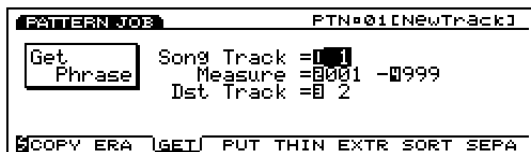

■ Src Song Track (Source Song Track)

Sets the source song sequence track.

- Settings:** 1 ~ 16

■ Measure

Sets the measure range (the beginning measure and the end measure) for the phrase that will be taken in.

- Settings:** 01 ~ 16 (for the beginning measure and the end measure)

■ Dst Track (Destination Track)

Sets the destination track for the phrase that will be taken in.

- Settings:** 1 ~ 8

4. Put Phrase

This job copies specified pattern track data onto a designated sequence track of a song. Any previous data existing in the destination sequence track is erased. Regardless of the time signature, the phrase data is copied as is to the song.

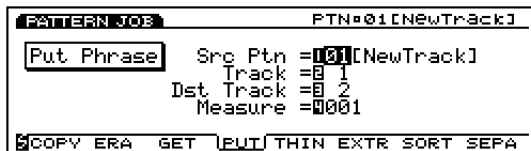

■ Src Ptn (Source Pattern)

Sets the source pattern number that will be copied.

- Settings:** 1 ~ 50

■ Track (Source Track)

Sets the source pattern track that contains the phrase that will be copied.

- Settings:** 1 ~ 8

■ Dst Track (Destination Track)

Sets the destination song sequence track for the phrase that will be copied to.

- Settings:** 1 ~ 16

■ Measure

Sets the beginning destination measure (the measure where copying will begin) where the phrase is copied to.

- Settings:** 001 ~ 999

5. Thin Out

This job removes every other occurrence of a designated non-note event from the specified track range. The purpose is to reduce the amount of data and free up additional memory.

NOTE When the interval of each event is larger than 60 clocks, data is not removed.

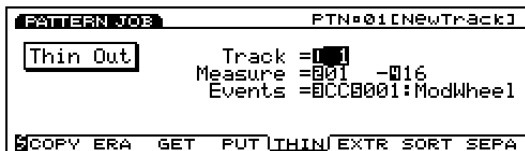

■ Track

Sets the track where Thin Out will be executed.

- Settings:** 1 ~ 8

■ Measure

Sets the measure range (beginning measure to the end measure) where Thin Out is executed.

- Settings:** 01 ~ 16 (for the beginning measure and the end measure)

■ Events

Sets the type of event that will be reduced. When “Control Change” is selected, a setting parameter will be added, and the control number can be designated there.

- ❑ **Settings:** Pitch Bend, Control Change (Control numbers range from 000 ~ 127), Ch After Touch (Channel After Touch), PolyAfter Touch (Polyphonic After Touch)

6. Extract

This job moves all instances of specific data from a designated range of a sequence track to the same range on a different sequence track. Following the operation, the targeted events no longer exist in the source track. If data already existed at the destination, the extracted data and existing data are mixed.

You can also use this job to delete the specified event data rather than move it. You can do this by setting the extract destination track to “off.”

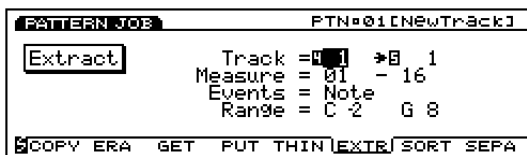

■ Track

Selects the track that will be extracted from (Extract source) and the track that will be copied to (Extract destination).

- ❑ **Settings:**
Extract source: 1 ~ 8
Extract destination: 1 ~ 8, off (extracted data is deleted)

■ Measure

Sets the measure range (the beginning measure and the end measure) where Extract is executed.

- ❑ **Settings:** 01 ~ 16 (for the beginning measure and the end measure)

■ Events

Sets the type of event that will be extracted.

When an event other than "Sys. Exclusive" is selected, additional parameters for the event range will be added, and you can designate the range.

- ❑ **Settings:** Note, Program Change, Pitch Bend, Control Change, Ch After Touch (Channel After Touch), PolyAfterTouch (Polyphonic After Touch), Sys.Exclusive(System Exclusive)

■ Event Range

Sets the range you want to extract the event. The unit of the value differs depending on the selected event.

- ❑ **Note:** C-2 ~ G8
- ❑ **Program Change, Control Change (Control number), Ch After Touch, PolyAfterTouch:** 0 ~ 127
- ❑ **Pitch Bend:** -8192 ~ +8192

7. Chord Sort

This job “sorts” chordal note events (simultaneous note events) by order of pitch. The notes can be either sorted from the highest pitch to the lowest or from the lowest pitch to the highest. The chords within the designated range of the specified sequence track can be sorted. For example, if notes E3, C3, and G3 all begin at the same time, the job arranges the order to C3, E3, G3 (if set to “up order”) to G3, E3, C3 (if set to “down order”).

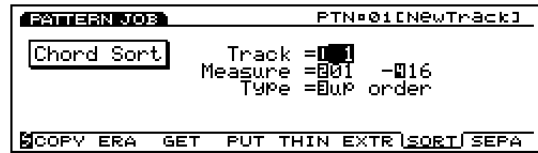

■ Track

Sets the track where Chord Sort will be executed.

- ❑ **Settings:** 1 ~ 8

■ Measure

Sets the measure range (beginning measure to the end measure) where Chord Sort is executed.

- ❑ **Settings:** 01 ~ 16 (for the beginning measure and the end measure)

■ Type

Sets the type of Chord Sort. When “up order” is selected, chords are sorted from the lowest pitch to the highest, while selecting “down order” will sort from the highest pitch to the lowest.

- ❑ **Settings:** up order, down order

8. Chord Separate

This job arranges chord notes in order with a specified interval (within the designated range of the specified sequence track). For example, if the Clock value is set to 30, a block chord consisting of C3, E3, G3 will be played as a C3 (at the chords original timing) followed 30 clocks later by the E3, and then another 30 clocks later by the G3. This feature can separate any chord easily and is useful, for example, when you want to simulate guitar strokes.

NOTE It is not possible to break chord over the next measure boundary or into the next chord.

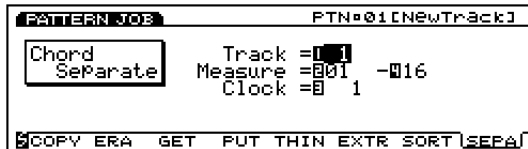

Track

Sets the track where Chord Separate will be executed.

□ **Settings:** 1 ~ 8

Measure

Sets the measure range (beginning measure to the end measure) where Chord Separate is executed.

□ **Settings:** 01 ~ 16 (for the beginning measure and the end measure)

Clock

Sets the clock interval inserted between adjacent notes.

□ **Settings:** 1 ~ 999

[F4]: JOB3

Press [F4] (JOB3) and JOB3 group screen will be displayed. There are eight jobs that are effective for note event data on a specified track.

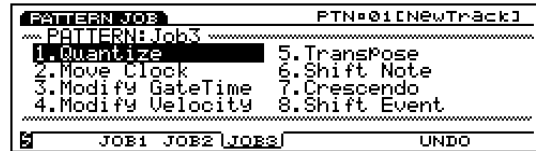

1. Quantize (Corrects the timing of the notes in a designated range.)
2. Move Clock (Moves all of the events in a designated range.)
3. Modify GateTime (Changes the note gate time [length] in a designated range.)
4. Modify Velocity (Changes note velocities in a designated range.)
5. Transpose (Transposes all notes over a selected range.)
6. Shift Note (Replaces all instances of a selected note with the specified replacement, over designated range.)
7. Crescendo (Gradually increases or decreases the note velocities over a designated range.)
8. Shift Event (Changes one event type into another, over a designated range.)

1. Quantize

This job quantizes note events over a specified range of a designated track. You can use this feature, for example, to correct the imperfect timing of a performance you have recorded in real time.

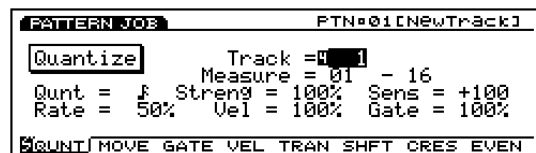

NOTE For more information on functions and each parameter, see page 212, Quantize in Song Job mode.

Track

□ **Settings:** 1 ~ 8, all

Measure

□ **Settings:** 01 ~ 16 (for the beginning measure and the end measure)

Qunt (Quantize Value)

□ **Settings:** F, F#, F, F#, F, F#, F, F#, F, F#, F, F#, F, F#, F, F#

■ Streng (Quantize Strength)

□ Settings: 0% ~ 100%

■ Sens (Quantize Sensitivity)

□ Settings: -100% ~ +000% ~ +100%

■ Rate (Swing Rate)

□ Settings:

When the quantize value is \downarrow , \downarrow , \downarrow , \downarrow :
50% ~ 75%

When the quantize value is \downarrow , \downarrow , \downarrow :
66% ~ 83%

When the quantize value is \downarrow + \downarrow or \downarrow + \downarrow :
50% ~ 66%

■ Vel (Swing Velocity)

□ Settings: 0% ~ 100% ~ 200%

■ Gate (Swing Gate Time)

□ Settings: 0% ~ 100% ~ 200%

2. Move Clock

This job shifts all event data for the specified range of the designated pattern track by clock units. This job will never move an event beyond the specified range's start or end point; any event that would otherwise move beyond this point is instead deposited at the beginning or end of the range.

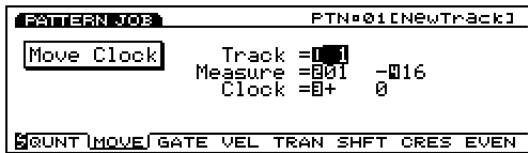

NOTE For more information on functions and each parameter, see page 214, Move Clock in Song Job mode.

■ Track

□ Settings: 1 ~ 8

■ Measure

□ Settings: 01 ~ 16 (for the beginning measure and the end measure)

■ Clock

□ Settings: -9999 ~ +0 ~ +9999

3. Modify GateTime

This job alters the gate time of the notes in the specified range. The gate time indicates the length of time that a note is held. For sustained voices, the gate time is equal to the actual playback time span. You can modify the gate time using two types of parameters: the Rate and Offset.

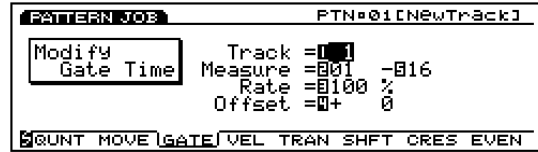

NOTE For more information on functions and each parameter, see page 215, Modify Gate Time in Song Job mode.

■ Track

□ Settings: 1 ~ 8

■ Measure

□ Settings: 01 ~ 16 (for the beginning measure and the end measure)

■ Rate

□ Settings: 000% ~ 100% ~ 200%

■ Offset

□ Settings: -9999 ~ +0 ~ +9999

4. Modify Velocity

This job alters the velocity of the notes in the specified range. The velocity refers to the strength at which a key is pressed. You can change the velocity using two types of parameters: the Rate and Offset.

NOTE The volume may differ depending on the selected voice that has a different velocity settings in the Voice Edit mode.

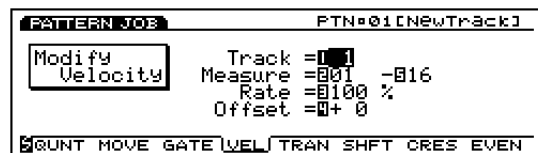

NOTE For more information on functions and each parameter, see page 216, Modify Velocity in Song Job mode.

■ Track

□ Settings: 1 ~ 8

■ Measure

- Settings:** 01 ~ 16 (for the beginning measure and the end measure)

■ Rate

- Settings:** 000% ~ 100% ~ 200%

■ Offset

- Settings:** -99 ~ +0 ~ +99

5. Transpose

This job lets you transpose in semitones the notes in the designated range of a specified pattern track.

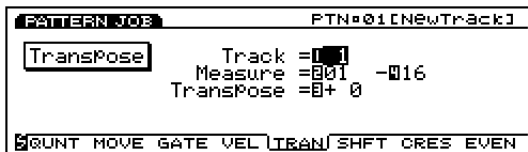

NOTE For more information on functions and each parameter, see page 217, Transpose in Song Job mode.

■ Track

- Settings:** 1 ~ 8

■ Measure

- Settings:** 01 ~ 16 (for the beginning measure and the end measure)

■ Transpose

- Settings:** -99 ~ +0 ~ +99

6. Shift Note

This job replaces all occurrences of a specified pitch (within the designated range of the specified pattern track) with some other pitch.

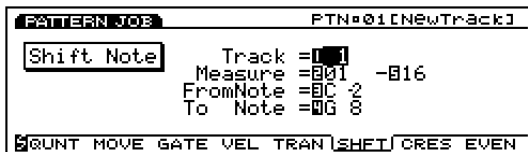

NOTE For more information on functions and each parameter, see page 217, Shift Note in Song Job mode.

■ Track

- Settings:** 1 ~ 8

■ Measure

- Settings:** 01 ~ 16 (for the beginning measure and the end measure)

■ FromNote

- Settings:** C-2 ~ G8

■ To Note

- Settings:** C-2 ~ G8

7. Crescendo

This job gradually increases or decreases the volume of the pattern. This job produces the crescendo (increasing) or diminuendo (decreasing) effect by applying a gradual change to the velocity of a designated range of a specified track.

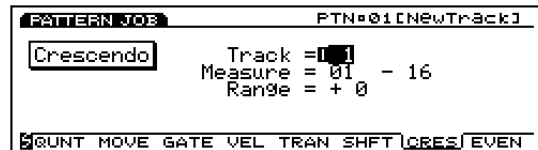

NOTE For more information on functions and each parameter, see page 217, Crescendo in Song Job mode.

■ Track

- Settings:** 1 ~ 8

■ Measure

- Settings:** 01 ~ 16 (for the beginning measure and the end measure)

■ Range

- Settings:** -99 ~ +0 ~ +99

8. Shift Event

This job replaces all occurrences of a specific event type (within the designated range of the specified pattern track) with some other designated event type.

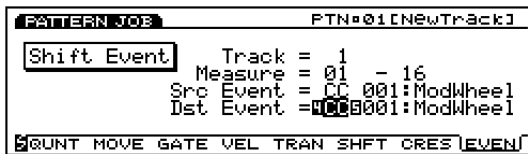

NOTE For more information on functions and each parameter, see page 218, Shift Event in Song Job mode.

■ Track

□ **Settings:** 1 ~ 8

■ Measure

□ **Settings:** 01 ~ 16 (for the beginning measure and the end measure)

■ Src Event (Source Event)

□ **Settings:** Control Change, Ch After Touch (Channel After Touch), Pitch Bend, Note (Note#: note numbers), Note (Vel: velocity values of each note)

■ Dst Event (Destination Event)

Sets the Shift Event event that the source event is changed to.

□ **Settings:** Control Change, Ch After Touch (Channel After Touch), Pitch Bend, Note (Note#: the data change of the source event will be replaced with note numbers with the fixed velocity 64 and fixed gate time 108), Note (Vel: the data change of the source event will be replaced with velocities with the fixed pitch C3 and fixed gate time 108).

[F7]: UNDO/REDO

Undo/Redo function is assigned to [F7]. Undo cancels the operation you made in your most recent record, edit, or job operation, restoring the data to its previous state. Redo, which becomes available only after you execute an Undo, cancels Undo operation and restores the changes. When you inadvertently execute a job, make a mistake while recording or editing, this job is convenient for restoring important data that would otherwise be lost.

NOTE For more information on Undo/Redo, see page 218.

Arpeggio Mode

When you select a user arpeggio type from the “Type” parameter in the ARP (Arpeggio) sub menu of COM in the Voice Edit mode (or ARP sub menu of COM in the Performance Edit mode), [ARP-EDIT] function will be assigned to [F3] key (or [F5] key in the Performance Edit mode). Press [F3] key (or [F5]) to enter the Arpeggio Mode.

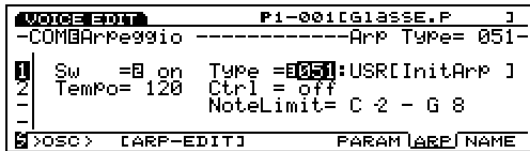

Press [EXIT] to quit the Arpeggio Mode, returning you to the Voice Edit mode (or the Performance Edit mode).

NOTE You can also open the Arpeggio Mode screen by pressing [ARPEGGIO] key on the panel from the Voice Play mode (or Performance Play mode).

NOTE [ARPEGGIO] key functions (can be turned on or off) when in Voice mode, Performance mode and Song Play mode.

Arpeggio Mode screen

This screen, available only for the “user” arpeggio patterns, lets you play back the recorded arpeggio sequence data track by track and edit each contents including the Play Effects settings.

You can enter Arpeggio Record mode from this screen and record your own arpeggio sequence data, a maximum of 50. For organizing your arpeggio sequence data after they have been recorded, store them on floppy disk so that you can make use of them whenever you like.

NOTE For additional information about Arpeggiator, see page 61.

NOTE If you want to create an arpeggio that is similar to an existing preset arpeggio, copy the preset arpeggio to create a user in the Arpeggio Job mode (page 249) and edit the detailed settings as you like in this screen or in the Arpeggio Edit mode (page 247).

When you display the Arpeggio Mode screen, the following menu screen will be displayed. In the Arpeggio Mode screen there are four types of sub menus.

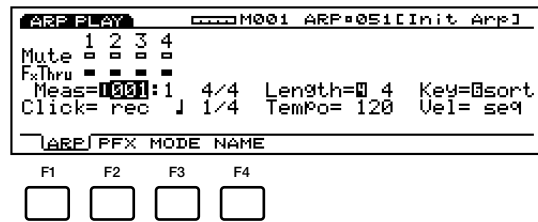

[F1]: ARP (Settings related to playing arpeggios)

[F2]: PFX (Settings related to Play Effects)

[F3]: MODE (Settings related to the sounding mode for each arpeggio track)

[F4]: NAME (Settings related to naming arpeggios)

NOTE The arpeggio sequencer doesn't read the messages of the program change and system exclusive.

[F1]: ARP (Arpeggio)

These parameters are used to set the Mute and Play Effects Thru functions for each arpeggio track (1-4 tracks). They can be set to “on” or “off.” You can audition and confirm the contents of the user arpeggios.

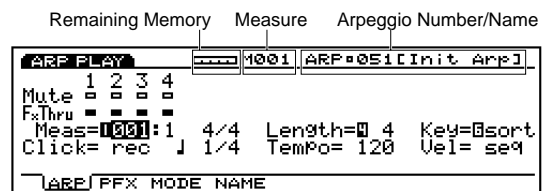

■ Remaining Memory

This bar graph indicates the amount of memory available for recording, or the remaining memory of the internal sequencer. This is common for all the internal sequencer functions, Song, Pattern and Arpeggio.

■ Measure/ARP (Arpeggio Type Number/Name)

The arpeggio number/name and the current measure number will be displayed. These items cannot be modified.

NOTE You are required to select the arpeggio type you want to record, play or edit from “USR” 051 ~ 100 in the ARP menu, COM, Voice/Performance Edit mode, before displaying the Arpeggio Mode screen.

Track Section

These settings are used to set the Mute and Play Effects Thru to “on” or “off” for each track even during arpeggio playback.

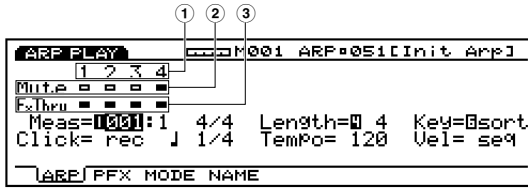

1 Track Number

An arpeggio consists of 1 ~ 4 sequence tracks. The Track Number is highlighted (box colored black) for tracks that have been recorded on and contain data.

2 Mute

Sets Mute for a track, by moving the cursor to the Mute line, and using Data Dial or [INC]/[DEC] to select “on” or “off.” As shown in the screen, the box colored black indicates that Mute is turned “on.” When Mute is turned “on,” that track is muted during playback, and the sound is temporarily suspended. When Mute is turned “off,” only the outline of the box is displayed, Mute is canceled, and sound will once again be produced.

3 Play Effects Thru

Sets FxThru (Play Effects Thru) for a track, by moving the cursor to FX Thru line, and using Data Dial or [INC]/[DEC] to select “on” or “off.” As shown in the screen, the box colored black indicates that FxThru is turned “on.” When FxThru is turned “on” for a track, Play Effects are temporarily bypassed during playback. When FxThru is turned “off,” only the outline of the box is displayed, the FxThru function is canceled, and Play Effect settings become effective once again.

NOTE When the cursor is on the Mute or FxThru line, you can select a track by pressing corresponding TRACK [1 ~ 4] key on the panel (EX5/7 only). You can directly set the Mute or FxThru to “on” or “off” by holding the [F1] ARP key and pressing the targeted TRACK [1 ~ 4] key as far as the cursor is on the Mute or FxThru line.

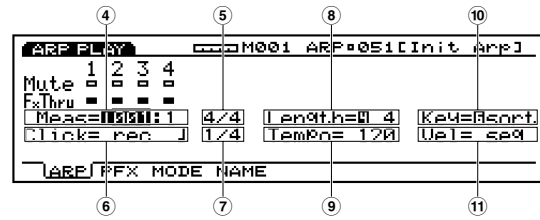

4 Meas (Measure)

Indicates the Measure and Beat numbers for the currently selected arpeggio. Allows you to set by measures.

Settings: The setting will differ depending on the length of the arpeggio (001 ~ 016).

NOTE The sequencer [REW] and [FWD] keys can also be used for rewinding and fast forwarding, and [TOP] key returns you to the first measure of the arpeggio.

5 Time Signature

Indicates the time signature of an arpeggio. Setting the time signature is accomplished in the Arpeggio Record mode (page 245).

6 Click (Click Mode)

Sets the sound mode for the metronome (Click). There are four modes, “off” (does not sound), “rec” (sounds during recording), “play” (sounds during playback and while recording), and “all” (sounds always). This function is convenient for playing in time, when performing or recording.

Settings: off, rec, play, all

7 Metronome (Click) Beat

Sets the beat (note unit) for when the metronome (Click) will sound.

Settings: 1/4, 1/8, 1/16

8 Length

Sets the length of the arpeggio in measures. Here you can set the length of an arpeggio to determine the loop length that is actually played back. For example, if you play back an eight-measure sequence data with this parameter set to “4,” it will play back to the end of the fourth measure, then return to the beginning measure, and play back from the first measure to the fourth in a loop (repeatedly).

Settings: 1 ~ 16

9 Tempo

Sets the tempo for the arpeggio that is played.

Settings: 30.0 ~ 250.0

10 Key

Sets the keyboard mode how the arpeggio responds when keys are pressed. The following three modes are available:

Settings:

sort:

Plays the arpeggio in ascending order (from the lowest pitch to the highest).

thru:

Plays the arpeggio in the order keys are pressed.

drct(direct):

Plays the notes as you play on the keyboard. If you program control changes such as cutoff (brightness) and pan in the sequence data, the control changes will automatically be reproduced as the arpeggio plays back.

NOTE When you select “sort” and “thru” the order notes are actually played back depends on the the settings for the sequence data and the selected mode.

11 Vel(Velocity)

Sets the velocity for the arpeggio when played back. The following two velocity modes are available:

Settings:

seq(sequence):

Selects the velocity preset for the arpeggio sequence data.

thru:

Selects the velocity actually played on the keyboard.

Auditioning the Arpeggiator

If you want to audition the arpeggio sequence data only, use the sequencer keys on the panel. Press [PLAY] to start the arpeggio. The arpeggio is played back repeatedly until you press [STOP] key.

If you want to audition the arpeggio sequence data with a variety of settings including the Play Effects, play the keyboard. The Arpeggiator will be activated with the settings such as current tempo, length and etc.

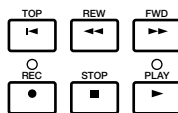

[TOP]: Returns the arpeggio to the first measure.

[REW]: (Rewind): Rewinds through the arpeggio measure numbers.

[FWD]: (Forward): Fast Forwards through the arpeggio measure numbers.

[REC]: (Recording): Engages the Arpeggio Record mode.

[STOP]: Stops playback.

[PLAY]: Begins playback.

Pitch Related Settings for Arpeggio

Arpeggiator reproduces the notes (pitches) played on the keyboard according to the preset sequence data in a specified manner and in the designated order. Different from the note names and MIDI note numbers (for example, C3, 60) used in Songs and Patterns, the pitch names in programming an arpeggio are described using Key numbers (1 ~ 16) and Octave numbers.

For example, imagine following sequence data which reproduces notes at every quarter note timing.

ARP EDIT	M001	ARP	0	SIC	Init	Arp]
Tr3	-K	0	Gate	-----	Vel		
==== Top of Track =====							
001-01-000	1	+0	00-432	(J)	72
001-02-000	2	+0	00-432	(J)	72
001-03-000	3	+0	00-432	(J)	72
001-04-000	4	+0	00-432	(J)	72
[SEQ]			INE		CHNG		[DEL]

In this case, when you play keyboard, for example, C3, E3, G3 and B3, the Key numbers are automatically assigned to each note played on the keyboard in an ascending order.



Key	1	2	3	4
Note	C3	E3	G3	B3

Since the sequence data is programmed to sound in the order shown above (from Key number 1, 2, 3 to 4) and at every quarter note timing, notes C3, E3, G3 and B3 will be produced in sequence.

Next, when you play keyboard, A2, C3, E3 and G3, the Key numbers are automatically assigned to each note played on the keyboard in an ascending order.



Key	1	2	3	4
Note	A2	C3	E3	G3

Since the sequence data is programmed to sound in the order shown above (from Key number 1, 2, 3 to 4) and at every quarter note timing, notes A2, C3, E3 and G3 will be produced in sequence.

In this way, the pitches (notes) played on the keyboard are assigned to the Key numbers based on the arpeggio sequence data.

[F2]: PFX (Play Effects)

These settings are related to Play Effects. The Play Effects function lets you temporarily adjust the velocity and the sound timing of MIDI notes. You can change the playback groove without altering the original data. Also you can apply various grooves to an arpeggio by using the 100 different types of groove templates or create your original groove templates. Different Play Effects can be set to each track.

Press [F2], the PFX screen appears and [F5] (All) , [F6] (TR), and [F8] (GROOVE) functions are added to the screen. Pressing [F8] key opens the Groove Template screen, where you can make your own groove templates and confirm the contents of the preset groove templates.

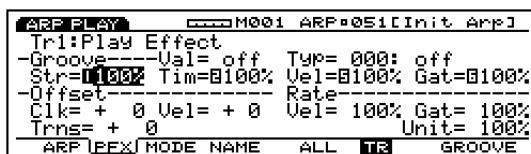

Steps for Setting the Play Effects

- 1 Start arpeggio playback by pressing the sequence [START] key on the panel.

NOTE If you want to use the keyboard (EX5/7) to start arpeggio, you are required to turn the Arpeggiator on by pressing the [ARPEGGIO] key on the panel (or by setting the Sw parameter to “on” in the ARP screen) before selecting the Play Effects screen.

Actually play the keyboard to activate the arpeggiator.

NOTE Play Effects can be set when the arpeggio is stopped, and also can be set in real time when the arpeggio is playing back. This lets you check the effect that results from the Play Effects.

- 2 Select [F5] ALL or [F6] TR.

When you want to apply the same Play Effects to all tracks, press [F5] to select ALL(All tracks). On the other hand, when you want to set the Play Effects differently for each track individually, press [F6] to select TR(each track).

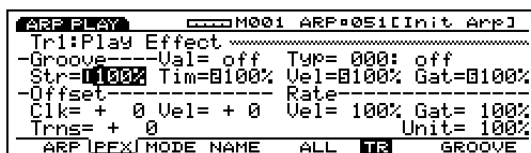

- 3 Select the track to which you want to apply the Play Effects.

When you select TR (each track) in step 2 above, select a track from the four tracks, Tr 1 ~ 4.

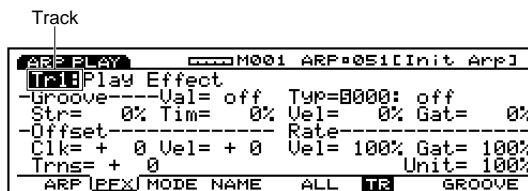

NOTE This step is unnecessary when you select ALL (All Tracks) in step 2 above.

- 4 Select a groove template.

Move the cursor to Type and select a groove template. When a User groove template is selected, continue by moving the cursor to Val (Value), and select a Quantize value.

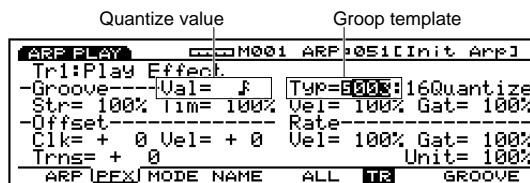

NOTE When a template is selected from the 1 ~ 100 Preset groove templates, the Quantize value can be confirmed, but not changed.

- 5 Set other parameters.

Set other parameters as necessary.

- 6 Set the Play Effects for other tracks.

Repeat the above steps 2 ~ 5 and set the Play Effects settings for the necessary tracks.

These parameters are the same as those explained for the PFX screen in Song Play mode. Therefore, only the parameters that differ will be explained. For information on the parameters, see page 187.

The Unit parameter is added to the PFX screen.

■ Unit

You can extend or shorten each track playback time. For example, a setting of 200% will make the playback time twice as long and result in a tempo that is half as fast. Conversely, a setting of 50% will make the playback time half as long and the tempo will become twice as fast. When set to 100%, the original data time does not change. Changing the speed of each track's sequence data lets you create interesting rhythms such as polyrhythms.

❑ **Settings:** 50%, 66%, 75%, 100%, 133%, 150%, 200%

[F8]: GROOVE (Groove Template)

Press [F8] (GROOVE) and the GROOVE screen will be displayed. Here you can create your own User template for arpeggios or confirm the contents of a Preset groove template. Also the [F6] COPY function is added to the screen.

The groove templates give you instant access to add groove feeling to your arpeggio by changing the timing of the sequence data using the Play Effects function. Each groove template contains the parameters in one measure.

A User template can be created by copying a template from the 100 types of Preset groove templates and making necessary adjustments or you can create a template by setting all the parameters from scratch.

All of the GROOVE screen parameters and settings being used for arpeggio tracks (tracks1 ~ 4) are the same as those in the GROOVE screen of the Song Play mode. For more information, see page 190.

[F3]: MODE

Sets the sounding mode for each arpeggio track.

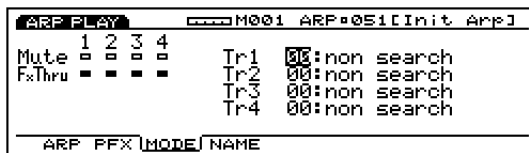

Track Section

These settings are used to set the Mute and Play Effects Thru to "on" or "off" for each track even during arpeggio playback. This is the same as that in the ARP screen.

■ Mode

Sets the sounding mode for the arpeggio tracks 1 ~ 4. The arpeggiated notes are produced according to the formation rules based on the selected mode as you play the keyboard. The following 17 modes are available:

Each Mode is explained using the following arpeggio sequence data as an example, with the Key (Keyboard mode on page 240), "sort" selected.

Sequence data (Example)

timing	key	oct	gate	vel
001-01-000	1	+0	00-432	72
001-02-000	2	+0	00-432	72
001-03-000	3	+0	00-432	72
001-04-000	4	+0	00-432	72

❑ **Settings:** Shown below.

00: non search

When the notes (pitches) corresponding to the arpeggio sequence data are not played on the keyboard, they will not be reproduced.

C3, E3, G3 and B3 are played in order.



C3 and E3 are played in order.



01: search low

When the notes (pitches) corresponding to the arpeggio sequence data are not played on the keyboard, the closest notes to them will be detected and reproduced.

C3, E3, G3 and B3 are played in order.



C3, E3 and G3 are played in order.



C3 and E3 are played in order.



C3 is played.



In the following modes, the arpeggio reproduction is independent of the pitch data of the arpeggio sequence. Typical arpeggiated chords will be formed according to the notes played on the keyboard and the timing of the sequence data.

02: note up 1oct (octave): The chord (phrase) you play ascends up to one octave.

C3, E3, G3 and B3 are played in order.



C3, E3 and G3 are played in order.

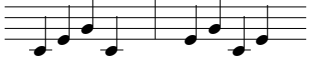

C3 and E3 are played in order.



C3 is played.



03: note up 2oct: The chord (phrase) ascends up to two octaves.

C3, E3, G3 and B3 are played in order.



C3 and E3 are played in order.



C3 is played.



04: note up 4oct: The chord (phrase) ascends up to four octaves.

05: note down 1oct: The chord (phrase) descends down to one octave.

C3, E3, G3 and B3 are played in order.



C3, E3 and G3 are played in order.

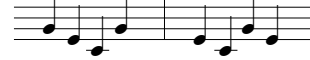

C3 and E3 are played in order.



C3 is played.



06: note down 2oct: The chord (phrase) descends down to two octaves.

07: note down 4oct: The chord (phrase) descends down to four octaves.

08: alternate1 1oct: The chord (phrase) ascends up to one octave, then descends down.

C3, E3, G3 and B3 are played in order.



C3, E3 and G3 are played in order.

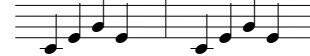

C3 and E3 are played in order.

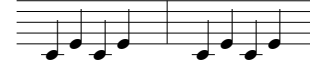

C3 is played.



09: alternate1 2oct: The chord (phrase) ascends up to two octaves, then descends down.

10: alternate1 4oct: The chord (phrase) ascends up to four octaves, then descends down.

11: alternate2 1oct: The chord (phrase) ascends up to one octave, then descends down to the lowest note. Slightly different from 08 above.

C3, E3, G3 and B3 are played in order.



C3, E3 and G3 are played in order.

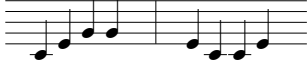

C3 and E3 are played in order.



C3 is played.



12: alternate2 2oct: The chord (phrase) ascends up to two octaves, then descends down. Slightly different from 09 above.

13: alternate2 4oct: The chord (phrase) ascends up to four octaves, then descends down. Slightly different from 10 above.

14: random 1oct: Plays up and down randomly between one octave, based on the chord (phrase).

15: random 2oct: Plays up and down randomly between two octaves, based on the chord (phrase).

16: random 4oct: Plays up and down randomly between four octaves, based on the chord (phrase).

NOTE A variety of rhythmic phrases can be created based on the contents of recorded sequence data.

Arpeggio Played back as Chords

An arpeggio sequence data can consist of chords, several notes at the same location (timing) such as the data found in the following example.

Sequence data (Example)

timing	key	oct	gate	vel
001-01-000	1	+0	00-432	72
001-01-000	2	+0	00-432	72
001-01-000	3	+0	00-432	72
001-02-000	1	+1	00-432	72
001-02-000	2	+1	00-432	72
001-02-000	3	+1	00-432	72
001-03-000	1	+0	00-432	72
001-03-000	2	+0	00-432	72
001-03-000	3	+0	00-432	72
001-04-000	1	+1	00-432	72
001-04-000	2	+1	00-432	72
001-04-000	3	+1	00-432	72

In this case, when you play keyboard, for example, C3, E3, G3 and B3 in order, the resultant arpeggio will be played back as chords and will vary depending on the selected mode as follows.

Sequence data

00:non search

01:search low



02:note up 1oct



[F4]: NAME (Arpeggio Type Name)

Lets you name an arpeggio using up to a maximum of eight letters and/or numbers.



NOTE The procedure for naming an arpeggio is the same as naming a song. See page 192.

Arpeggio Record Mode

In Arpeggio Record mode there are two methods available for recording arpeggio sequence data, real time recording and step recording. There are also various functions related to recording arpeggios and a maximum of 50 arpeggios, each of which are accompanied with the settings in Arpeggio Mode screen, can be stored in the internal memory. For organizing your arpeggios, they can be stored to floppy disk so that you can make use of them whenever you like.

Real Time Recording: Just like a multi-track recorder, the actual performance is recorded as you play. Because the performance is recorded exactly as played, the subtle nuances and feeling of the recording are accurately expressed.

Step Recording: Just like writing music on a music score, each note is programmed in separately. You can confirm each beat of the measure in the screen as you perform operations. Therefore this type of recording is perfect for programming repetitive phrases and bass lines that require precision.

Arpeggiator will use the sequence data recorded here as its basic patterns. An arpeggio consists of four tracks. The arpeggio tracks, pattern tracks and song tracks share the same 16 parts of the tone generator. The MIDI channels for each arpeggio track can be set in Arp CH parameter of the Voice Mode Setup in Voice mode and of the COM menu in Performance mode, respectively.

NOTE The arpeggio sequencer doesn't read the messages of the program change and system exclusive.

How to Enter the Arpeggio Record Mode

When in the Arpeggio Mode screen, press the sequencer [REC] (Recording) key. The [REC] light will be lit indicating that Arpeggio Record mode has been engaged, and is now in standby status.

Press [REC] once more or [STOP] to return to Arpeggio Mode screen.

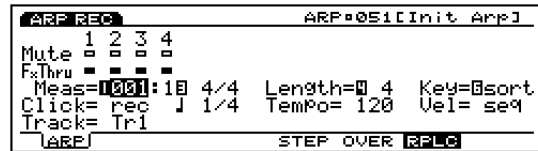

When you enter the Arpeggio Record mode, the sub menus below appear in the screen. There are four menus in the Arpeggio Record mode.

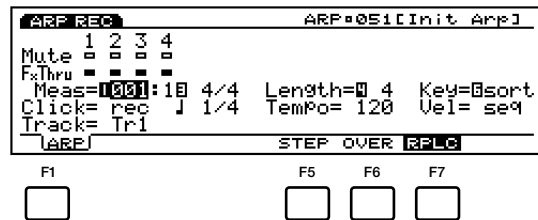

[F1]: ARP (Settings related to recording arpeggios)

Recording Mode

[F5]: STEP (Selecting Step recording)

[F6]: OVER (Select Overdubbing)

[F7]: RPLC (Selecting Replace recording)

[F1]: ARP (Arpeggio)

These are various settings related to recording an arpeggio, such as selecting a track for recording, and setting the time signature and tempo. In addition to those settings, there are Mute on/off and Play Effects Thru on/off for each of the playback tracks (tracks 1 ~ 4).

Many of the parameters here are found in Arpeggio Mode screen (page 238). Only the parameters that differ from those described in Arpeggio Mode screen will be explained.

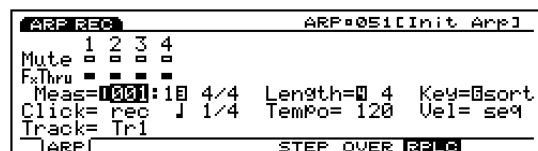

■ Meas (Measure)

Sets the measure number where recording will begin, using the Sequencer keys (the Cursors cannot be used).

□ **Settings:** 001 ~ 016

■ Time Signature

Sets the time signature for an arpeggio.

□ **Settings:** 1/4 ~ 8/4, 1/8 ~ 16/8, 1/16 ~ 16/16

NOTE You can change the time signature after recording.

■ Track

Selects the track for recording. Tracks 1 ~ 4 can also be selected using the TRACK [1 ~ 4] (EX5/7 only).

□ **Settings:** Tr1 ~ 4(tracks1 ~ 4)

NOTE The arpeggio tracks 1 ~ 4 are positioned in the same line at the top of the screen.

Recording Mode

In the Arpeggio Record mode various recording modes have been assigned to [F3] and [F5] ~ [F7].

[F5]: STEP

Sets the STEP recording mode to “on” or “off.” Press [F5], STEP is highlighted and the STEP recording mode is turned on. Then notes can be programmed in one at a time. Press [F6] ~ [F7] to cancel STEP recording mode and return to real time recording.

NOTE When STEP is not highlighted, real time recording is always engaged.

[F6]: OVER(Over Dubbing)

Sets the OVER dubbing recording to “on” or “off.” Press [F6], OVER is highlighted and the OVER Dubbing is turned on. When recording in real time, you can record over previously recorded data. For example, after first recording quarter notes, you can use this function to record fine 16th notes on top without erasing the original data. Press [F5]/[F7] to cancel the Over Dubbing recording.

[F7]: RPLC (Replace)

Sets Replace recording to “on” or “off.” Press [F7], RPLC is highlighted and the Replace recording is turned on. When recording in real time, you can record over previously recorded data (erasing and replacing the original data with the new data as you record). Press [F5]/[F6] to cancel the Replace recording.

Real Time Recording

Real Time recording is just like a multi-track recorder where you record as you play on each track (Tr1-4). There are two types of recording methods, Over Dubbing (recording over original data but not erasing it) and Replace (erasing and replacing the original data).

❶ In the Arpeggio Mode screen, press [REC] to enter Arpeggio Record mode (stand-by record status).

NOTE Before displaying the Arpeggio Mode screen, you are required to select a user arpeggio number for recording.

❷ In the ARP display, set the necessary settings for recording, such as the length, time signature and tempo, as well as the click.

❸ Set the beginning measure number for recording with the Meas parameter.

❹ Select the track (Tr1-4) for recording with the Track parameter.

❺ Select one of the following recording modes: [F6] (Over Dubbing) or [F7] (Replace).

❻ Press [PLAY] and recording will begin after a two measure countdown. Record something by playing the keyboard. The [PLAY] green light will blink in sync with the metronome click.

NOTE During the two measure countdown, Meas (measure) will display the countdown from -2 to -1.

❼ Press [STOP] to stop recording, the EX automatically returns to the Arpeggio Mode screen.

NOTE After you have finished recording, there are various edit functions that let you correct misplayed notes or the timing in the Arpeggio Edit mode (page 247) and the Arpeggio Job mode (page 249).

Step Recording

In Step recording the performance data (note length, pitch, and velocity) is programmed one note at a time.

Step Recording Screen

When in Step Recording (after you press [PLAY]), the following screen will be displayed.

All of these functions are the same as those explained in STEP recording of the Song Record mode. For more information about each parameter and the ways to input notes, see page 198.

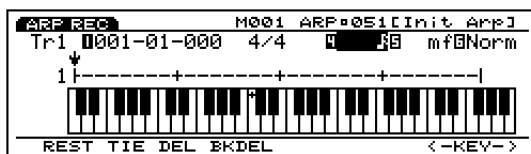

The Procedure for Step Recording

- 1 In the Arpeggio Mode screen, press [REC] to enter Arpeggio Record mode (stand-by record status).
 - NOTE** Before displaying the Arpeggio Mode screen, you are required to select a user arpeggio number for recording.
- 2 In the ARP display, set the necessary settings for recording, such as the length, time signature and tempo (see page 246).
- 3 Set the beginning measure number for recording with the Meas parameter.
- 4 Select the track (Tr1-4) for recording with the Track parameter.
- 5 Press [F5] (STEP) to select the Step recording mode.
- 6 Press [PLAY], the [PLAY] green light will be lit, and the Step Recording screen will be displayed.
- 7 Set the note length and the velocity, and input the note with the keyboard. The ↓ cursor automatically moves forward a distance equal to the length of the note that was just input.
- 8 Repeat step 7 above, and program in one note at a time.
- 9 Press [STOP] to stop recording. The EX automatically returns to the Arpeggio Mode screen.

NOTE After you have finished recording, there are various edit functions in Arpeggio Edit mode and Arpeggio Job mode (page 249).

Arpeggio Edit Mode

In Arpeggio Mode screen (or Arpeggio Job mode), you can enter Arpeggio Edit mode by pressing [EDIT] key on the panel. In Arpeggio Edit mode, you can edit events for each user arpeggio sequence track 1 ~ 4, that were recorded in real time or in step recording.

[F5] INS (Insert) allows you to insert new events and [F6] CHNG (Change) is for changing the position or value of previously existing data. [F8] DEL (Delete) lets you delete unnecessary events.

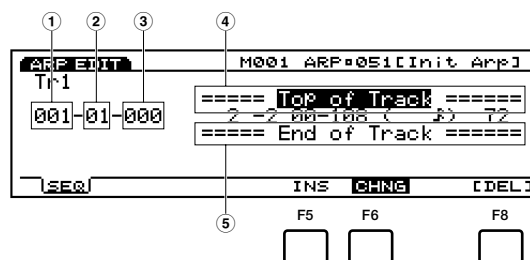

- 1 **Measure:** 1 ~ 16 (maximum value will change depending on the Length setting)
- 2 **Beat:** 1 ~ 16 (maximum value will change depending on the Beat setting)
- 3 **Clock:** 000 ~ 479
- 4 **Top of Track (indicates the beginning of the track)**
- 5 **End of Track (indicates the end of the track)**

[F5]: INS (Insert: insert a new event)

[F6]: CHNG (Change: change the position or value of an event)

[F8]: DEL (Delete: delete an event)

Press [EXIT] to quit the Arpeggio Edit mode, returning you to the Arpeggio Mode screen.

Event Data That Can Be Edited

Event data that can be edited is the same as those for the sequence tracks 1 ~ 16 in the Song Edit mode, for more information see page 202.

Inserting Events

You can insert new event data that is not included in the arpeggio sequence data.

- 1 When in the Arpeggio Mode screen (or Arpeggio Job mode), press [EDIT] to enter the Pattern Edit mode. The Event List will be displayed.

- 2 Press Track [1 ~ 4] to select a track number to edit (EX5/7). The Event List of the selected track will be displayed.

NOTE For the EX5R, select the track before entering Arpeggio Edit mode.

NOTE You can scroll through the Event List and search for insert locations with the vertical ▲/▼ cursor keys. When the cursor is moved to an event, the note data will sound.

NOTE If you press [CURSOR] key to turn its light on, Data Dial can be used to move the cursor quickly.

- 3 Press [F5] (INS: Insert) and the Insert pop-up menu will appear.

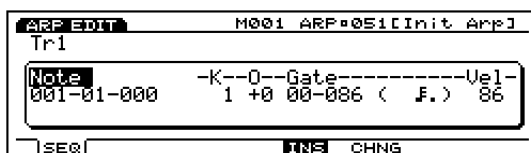

- 4 Move the cursor to the Event type at the top left side of the Insert pop-up menu and designate the type of event that will be inserted.

NOTE For more information about types of events and parameters, see page 202.

- 5 Move the cursor to Measure/Beat/Clock and designate the detailed location.
- 6 Move the cursor to each parameter and designate the value for each.
- 7 Press [ENTER] to insert the event.
- 8 Press [EXIT] key to quit the Arpeggio Edit mode, returning you to the Arpeggio Mode screen.

Changing Events

You can change the events in the arpeggio sequence data.

- 1 When in the Arpeggio Mode screen (or Arpeggio Job mode), press [EDIT] to enter the Pattern Edit mode. The Event List will be displayed.

- 2 Press Track [1 ~ 4] to select a track number to edit (EX5/7). The Event List of the selected track will be displayed.

NOTE For the EX5R, select the track before entering Arpeggio Edit mode.

NOTE When you follow the steps above, CHNG is highlighted and is automatically selected. If necessary, press [F6] to select CHNG.

- 3 Move the cursor to the location of the event that you want to change, and edit the parameters.

NOTE You can scroll through the Event List and search for event locations and select parameters with the vertical ▲/▼ cursor keys. Also you can move to a parameter with the horizontal ◀/▶ cursor keys. When the cursor is moved to an event, the note data will sound.

NOTE If you press [CURSOR] key to turn its light on, Data Dial can be used to move the cursor quickly.

NOTE For more information about types of events and parameters, see page 202.

- 4 Use [INC]/[DEC], Data Dial or numeric keypad to change and set values.

- 5 Press [ENTER] to execute the change.

- 6 Press [EXIT] key to quit the Arpeggio Edit mode, returning you to the Arpeggio Mode screen.

Deleting Events

You can delete a specific event from the arpeggio data.

- 1 When in the Arpeggio Mode screen (or Arpeggio Job mode), press [EDIT] to enter the Pattern Edit mode. The Event List will be displayed.

- 2 Press Track [1 ~ 4] to select a track number to edit (EX5/7). The Event List of the selected track will be displayed.

NOTE For the EX5R, select the track before entering Arpeggio Edit mode.

- 3 Move the cursor to the location of the event that you want to delete.

- 4 Press [F8] [DEL] (Delete) to delete the currently selected event (the event where the cursor is located).

- 5 Press [EXIT] key to quit the Arpeggio Edit mode, returning you to the Arpeggio Mode screen.

Arpeggio Job Mode

Here are various jobs for user arpeggios that were created in Arpeggio Edit mode (or are being edited). These jobs which allow you to copy or erase, as well as many other operations, are executed by the measure or the track.



[F2]: JOB1
 [F3]: JOB2
 [F4]: JOB3
 [F7]: UNDO/REDO

[ARPEGGIO]
 └─ [JOB]

- └─ [F2:JOB1]250
 - └─ [Copy Arpeggio]250
 - └─ [Clear Arpeggio]250
 - └─ [Copy Track]251
 - └─ [Clear Track]251
 - └─ [MIX Track].....251
 - └─ [Append Arpeggio]251
 - └─ [Split Arpeggio]252
 - └─ [Time Stretch]252
- └─ [F3:JOB2]252
 - └─ [Copy Measure]253
 - └─ [Erase Measure]253
 - └─ [Get Phrase].....253
 - └─ [Thin Out]254
 - └─ [Extract]254
 - └─ [Chord Sort].....255
 - └─ [Chord Separate].....255
- └─ [F4:JOB3]255
 - └─ [Quantize]256
 - └─ [Move Clock]256
 - └─ [Modify GateTime].....256
 - └─ [Modify Velocity]257
 - └─ [Transpose]257
 - └─ [Shift Note]257
 - └─ [Crescendo]258
 - └─ [Shift Event]258
- └─ [F7:UNDO]258

In Arpeggio Mode screen (or Arpeggio Edit mode), you can enter Arpeggio Job mode by pressing [JOB] key on the panel. When you enter the Arpeggio Job mode, the following menu will be displayed. There are 23 types of jobs in Arpeggio Job mode. The jobs are divided into three groups JOB1 ~ 3. Press [F2] (JOB1), [F3] (JOB2) or [F4] (JOB3) to select a menu. The Undo/Redo function is assigned to [F7] which cancels the changes you made in your most recent job operation.

Steps for Executing a Job

- 1 In Arpeggio Mode screen, select the arpeggio that you want to execute job operation.
- 2 Press [JOB] key to enter the Arpeggio Job mode.
- 3 Press [F2] (JOB1), [F3] (JOB2) or [F4] (JOB3) to select a menu. The selected menu will be displayed.



- 4 Move the cursor to a job and press [ENTER]. The selected job screen will be displayed.

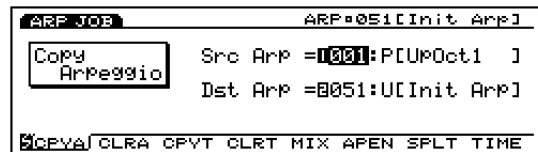

- NOTE** You can also display each job by pressing [F1] ~ [F8] while holding down [SHIFT].
- 5 Move the cursor to a parameter and use the [INC]/[DEC], Data Dial, numeric keypad, or the Knobs 1 ~ 6 to set values.
- NOTE** Depending on the selected job it may not be necessary to set values.

- 6 Press [ENTER]. The following pop-up menu will appear, prompting confirmation of the operation.

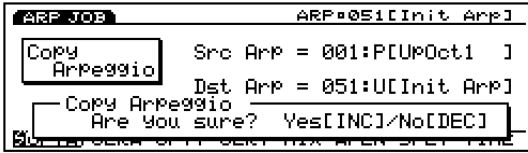

- 7 Press [YES] to execute the job. "Completed!" will momentarily appear in the screen indicating that the job has been executed and the previous screen will be displayed.

Press [NO] to cancel the job.

NOTE "Executing..." will appear when the Arpeggio Job takes some time to execute. Take note that if the power is turned off while "Executing..." is displayed, the data may be destroyed.

- 8 Press [EXIT] twice to exit the Arpeggio Job mode and return to the Arpeggio Mode screen.

[F2]: JOB1

Press [F2] (JOB1) and JOB1 menu will be displayed. There are eight jobs that are executed in units of arpeggios or respective tracks.



1. Copy Arpeggio (Copies all arpeggio data onto another arpeggio.)
2. Clear Arpeggio (Clears all data from a arpeggio.)
3. Copy Track (Copies specific track data onto another track.)
4. Clear Track (Clears all data from designated track.)
5. Mix Track (Mixes one track into another.)
6. Append Arpeggio (Appends one arpeggio to another.)
7. Split Arpeggio (Splits arpeggio into two arpeggios.)
8. Time Stretch (expands or compresses timing over designated range for specific track.)

1. Copy Arpeggio

This job copies all data from a source arpeggio to a designated destination arpeggio (user number 51 ~ 100). The arpeggio's Play Effects data and other settings are also copied simultaneously. It will be handy when you want to create a user arpeggio that is similar to an existing preset arpeggio.

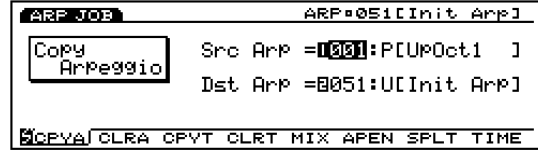

■ Src Arp (Source Arpeggio)

Sets the source arpeggio number that will be copied.

□ **Settings:** 1 ~ 100

■ Dst Arp (Destination Arpeggio)

Sets the destination arpeggio number that will be copied to.

□ **Settings:** 51 ~ 100

2. Clear Arpeggio

This job erases all data from an arpeggio and initializes the arpeggio's Play Effects and other settings.

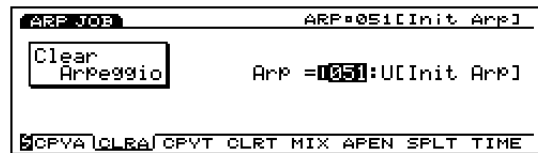

■ Clear Arp

Sets the arpeggio number of the arpeggio that will be cleared.

□ **Settings:** 51 ~ 100

3. Copy Track

This job copies all data from a specified track onto another. The arpeggio's Play Effects data and other settings are also copied simultaneously. This operation overwrites any data already existing on the destination track.



■ Src Arp (Source Arpeggio)

Sets the source arpeggio number.

□ Settings: 01 ~ 100

■ SrcTrack (Source Track)

Sets the source track that will be copied.

□ Settings: 1 ~ 4

■ Dst Arp (Destination Arpeggio)

Sets the destination arpeggio number.

□ Settings: 51 ~ 100

■ Dst Track (Destination Track)

Sets the destination track that will be copied to.

□ Settings: 1 ~ 4

4. Clear Track

This job erases all data from a specified track of the currently selected arpeggio. In this case, the job also initializes all Play Effects and other settings for that track.



■ Track

Sets the track that will be cleared.

□ Settings: 1 ~ 4, all

5. Mix Track

This job mixes all data from a specified sequence track (Mix source track) with another track's data (Mix destination track). When the operation is complete, the destination track contains both its original data and a copy of the source track's data.

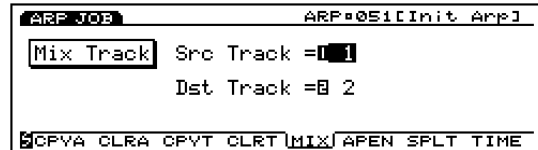

■ Src Track (Source Track)

Sets the Mix source track.

□ Settings: 1 ~ 4

■ Dst Track (Destination Track)

Sets the Mix destination track.

□ Settings: 1 ~ 4

6. Append Arpeggio

This job lets you connect the data of two specific tracks to complete an arpeggio. A source arpeggio (Append source arpeggio) is connected to the end of a destination arpeggio (Append destination arpeggio).



■ Src Arp (Source Arpeggio)

Sets the Append source arpeggio number.

□ Settings: 51 ~ 100

■ SrcTrack (Source Track)

Sets the Append source arpeggio track that will be copied to the destination arpeggio.

□ Settings: 1 ~ 4

■ Dst Arp (Destination Arpeggio)

Sets the Append destination arpeggio number.

□ Settings: 51 ~ 100

■ Dst Track (Destination Track)

Sets the Append destination arpeggio track.

□ **Settings:** 1 ~ 4

7. Split Arpeggio

This job splits track data of a arpeggio (Split source arpeggio) at a specified measure and moves the latter half of the split track data to the beginning of the track of another arpeggio (Split destination arpeggio). The former half of the split track data remains in its original location.

The job overwrites any data already existing in the destination location.

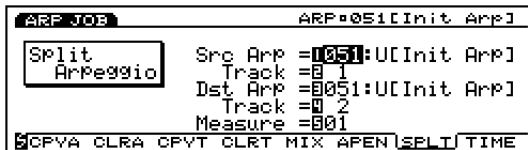

■ Src Arp (Source Arpeggio)

Sets the Split source arpeggio number.

□ **Settings:** 51 ~ 100

■ Src Track (Source Track)

Sets the Split source arpeggio track.

□ **Settings:** 1 ~ 4

■ Dst Arp (Destination Arpeggio)

Sets the Split destination arpeggio number that will be moved to.

□ **Settings:** 51 ~ 100

■ Dst Track (Destination Track)

Sets the Split destination arpeggio track that will be moved to.

□ **Settings:** 1 ~ 4

■ Measure

Sets the measure number in the designated source arpeggio track (this measure number marks the beginning of the latter half data).

□ **Settings:** 1 ~ 16

8. Time Stretch

This job expands or compresses the timing over the designated range on the specified track. The operation affects all note step times, gate times, and event timing, expanding or compressing the entire designated range.

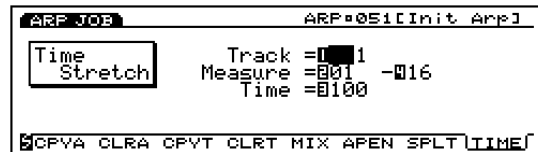

■ Track

Sets the track where Time Stretch is executed.

□ **Settings:** 1 ~ 4

■ Measure

Sets the measure range (beginning measure to the end measure) where Time Stretch is executed.

□ **Settings:** 01 ~ 16 (for the beginning measure and the end measure)

■ Time

Sets the ratio in percentages of the expansion or compression in the designated range.

□ **Settings:** 50 ~ 200 %

[F3]: JOB2

Press [F3] (JOB2) and JOB2 menu will be displayed. There are seven jobs that are executed in measure units.

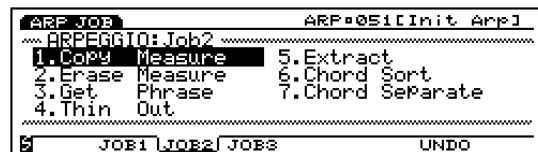

1. Copy Measure (Copies data in the designated range.)
2. Erase Measure (Erases data in the designated range.)
3. Get Phrase (Borrows sequence data from a song track.)
4. Thin Out (Reduces data such as controller data.)
5. Extract (Extracts specific data from the designated range.)
6. Chord Sort (Sorts chordal note events, by pitch, over a designated range of a track.)
7. Chord Separate (Arranges chord notes in order with a specified interval.)

1. Copy Measure

This job copies all data from a specified range on an arpeggio sequence track onto another. It is also possible to copy data within the same track. This operation overwrites any data already existing on the destination track.

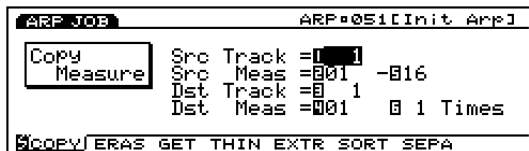

■ Src Trk (Source Track)

Sets the source track that will be copied.

□ **Settings:** 1 ~ 4, all

■ Src Meas (Source Measure)

Sets the range (the beginning measure and the end measure) in the source track.

□ **Settings:** 01 ~ 16 (for the beginning measure and the end measure)

■ Dst Trk (Destination Track)

Sets the destination track that will be copied to.

□ **Settings:** 1 ~ 4, all

■ Dst Meas (Destination Measure)

Sets the first destination measure (the measure where copying will begin) that will be copied to.

□ **Settings:** 01 ~ 16

■ Times

Sets the number of times copy will take place.

□ **Settings:** 1 ~ 16

2. Erase Measure

This job erases all data from a specified range on a track. Even though the data is erased the empty measures still remain.

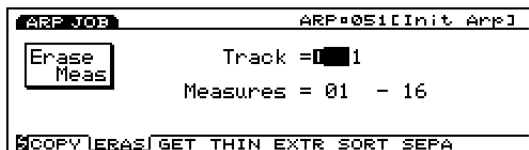

■ Track

Sets the track where Erase Measure will be executed.

□ **Settings:** 1 ~ 4, all

■ Measure

Sets the measure range (beginning measure to the end measure) where Erase Measure is executed.

□ **Settings:** 01 ~ 16 (for the beginning measure and the end measure)

3. Get Phrase

This job borrows sequence data from a song track onto the currently selected arpeggio track. The job overwrites any data already existing in the destination track.

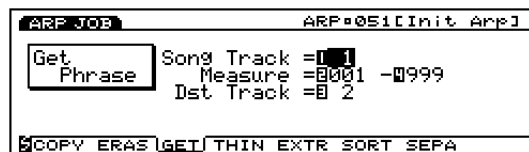

■ Src Song Track (Source Song Track)

Sets the source song sequence track.

□ **Settings:** 1 ~ 16

■ Measure

Sets the measure range (the beginning measure and the end measure) for the phrase that will be taken in.

□ **Settings:** 001 ~ 999 (for the beginning measure and the end measure)

■ Dst Track (Destination Track)

Sets the destination track for the phrase that will be taken in.

□ **Settings:** 1 ~ 4

4. Thin Out

This job removes every other occurrence of a designated non-note event from the specified track range. The purpose is to reduce the amount of data and free up additional memory.

NOTE When the interval of each event is larger than 60 clocks, data is not removed.

```

ARP JOB                               ARP#051[Init App]
Thin Out                               Track = 01
Measures = 01 - 16                    Events = ECC001:ModWheel
COPY ERAS GET THIN|EXTR|SORT SEFA
  
```

Track

Sets the track where Thin Out will be executed.

Settings: 1 ~ 4

Measure

Sets the measure range (beginning measure to the end measure) where Thin Out is executed.

Settings: 001 ~ 999 (for the beginning measure and the end measure)

Events

Sets the type of event that will be reduced. When “Control Change” is selected, a setting parameter will be added, and the control number can be designated there.

Settings: Pitch Bend, Control Change (Control numbers range from 000 ~ 127), Ch After Touch (Channel After Touch), PolyAfter Touch (Polyphonic After Touch)

Track

Selects the track that will be extracted from (Extract source) and the track that will be copied to (Extract destination).

Settings:

Extract source: 1 ~ 4

Extract destination: 1 ~ 4

Measure

Sets the measure range (the beginning measure and the end measure) where Extract is executed.

Settings: 01 ~ 16 (for the beginning measure and the end measure)

Events

Sets the type of event that will be extracted.

When an event other than “Sys. Exclusive” is selected, additional parameters for the event range will be added, and you can designate the range.

Settings: Note, Program Change, Pitch Bend, Control Change, Ch After Touch (Channel After Touch), PolyAfterTouch (Polyphonic After Touch), Sys.Exclusive(System Exclusive)

Event Range

Sets the range you want to extract the event. The unit of the value differs depending on the selected event.

Note: Key = 1 ~ 16, Oct = -4 ~ +3

Program Change, Control Change (Control number), Ch After Touch, PolyAfterTouch: 0 ~ 127

Pitch Bend: -8192 ~ +8192

NOTE For the information about Key number and Octave number see page 240.

5. Extract

This job moves all instances of specific data from a designated range of a sequence track to the same range on a different sequence track. Following the operation, the targeted events no longer exist in the source track. If data already existed at the destination, the extracted data and existing data are mixed.

```

ARP JOB                               ARP#051[Init App]
Extract                               Track = 01 -> 01
Measures = 01 - 16                    Events = Note(Key:Oct)
Range = 1 +0 1 +0
COPY ERAS GET THIN|EXTR|SORT SEFA
  
```

6. Chord Sort

This job “sorts” chordal note events (simultaneous note events) by order of pitch. The notes can be either sorted from the highest pitch to the lowest or from the lowest pitch to the highest. The chords within the designated range of the specified sequence track can be sorted. For example, if notes E3, C3, and G3 all begin at the same time, the job arranges the order to C3, E3, G3 (if set to “up order”) to G3, E3, C3 (if set to “down order”).

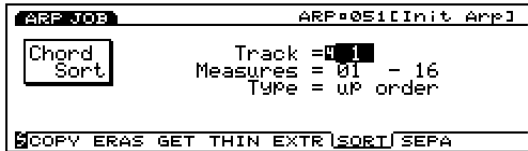

■ Track

Sets the track where Chord Sort will be executed.

❑ **Settings:** 1 ~ 4

■ Measure

Sets the measure range (beginning measure to the end measure) where Chord Sort is executed.

❑ **Settings:** 01 ~ 16 (for the beginning measure and the end measure)

■ Type

Sets the type of Chord Sort. When “up order” is selected, chords are sorted from the lowest pitch to the highest, while selecting “down order” will sort from the highest pitch to the lowest.

❑ **Settings:** up order, down order

7. Chord Separate

This job arranges chord notes in order with a specified interval (within the designated range of the specified arpeggio sequence track). For example, if the Clock value is set to 30, a block chord consisting of C3,E3,G3 will be played as a C3 (at the chords original timing) followed 30 clocks later by the E3, and then another 30 clocks later by the G3. This feature can separate any chord easily and is useful, for example, when you want to simulate guitar strokes.

NOTE It is not possible to break chord over the next measure boundary or into the next chord.

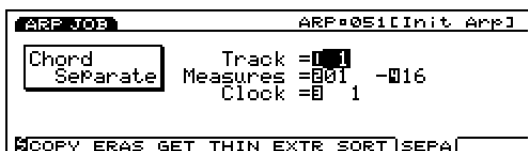

■ Track

Sets the track where Chord Separate will be executed.

❑ **Settings:** 1 ~ 4

■ Measure

Sets the measure range (beginning measure to the end measure) where Chord Separate is executed.

❑ **Settings:** 01 ~ 16 (for the beginning measure and the end measure)

■ Clock

Sets the clock interval inserted between adjacent notes.

❑ **Settings:** 1 ~ 999

[F4]: JOB3

Press [F4] (JOB3) and JOB3 group screen will be displayed. There are eight jobs that are effective for note event data on a specified track.

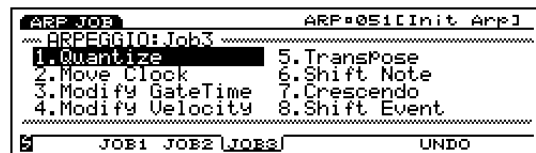

1. Quantize (Corrects the timing of the notes in a designated range.)
2. Move Clock (Moves all of the events in a designated range.)
3. Modify GateTime (Changes the note gate time [length] in a designated range.)
4. Modify Velocity (Changes note velocities in a designated range.)
5. Transpose (Transposes all notes over a selected range.)
6. Shift Note (Replaces all instances of a selected note with the specified replacement, over designated range.)
7. Crescendo (Gradually increases or decreases the note velocities over a designated range.)
8. Shift Event (Changes one event type into another, over a designated range.)

1. Quantize

This job quantizes note events over a specified range of a designated track. You can use this feature, for example, to correct the imperfect timing of a performance you have recorded in real time.

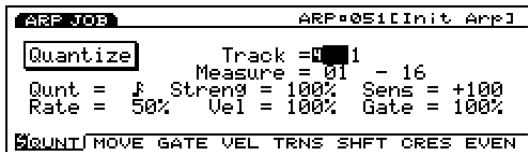

NOTE For more information on functions and each parameter, see page 212, Quantize in Song Job mode.

■ Track

Settings: 1 ~ 4, all

■ Measure

Settings: 01 ~ 16 (for the beginning measure and the end measure)

■ Qunt (Quantize Value)

Settings: ♩, ♩♩, ♩♩♩, ♩♩♩♩, ♩♩♩♩♩, ♩♩♩♩♩♩, ♩♩♩♩♩♩♩

■ Streng (Quantize Strength)

Settings: 0% ~ 100%

■ Sens (Quantize Sensitivity)

Settings: -100% ~ +000% ~ +100%

■ Rate (Swing Rate)

Settings:

When the quantize value is ♩, ♩♩, ♩♩♩, ♩♩♩♩:
50% ~ 75%

When the quantize value is ♩♩♩♩, ♩♩♩♩♩, ♩♩♩♩♩♩:
66% ~ 83%

When the quantize value is ♩♩♩♩♩♩ or ♩♩♩♩♩♩♩:
50% ~ 66%

■ Vel (Swing Velocity)

Settings: 0% ~ 100% ~ 200%

■ Gate (Swing Gate Time)

Settings: 0% ~ 100% ~ 200%

2. Move Clock

This job shifts all event data for the specified range of the designated arpeggio track by clock units. This job will never move an event beyond the specified range's start or end point; any event that would otherwise move beyond this point is instead deposited at the beginning or end of the range.

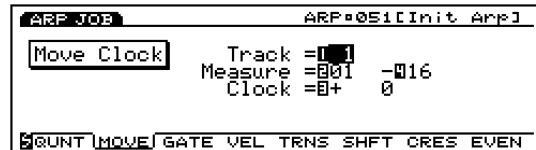

NOTE For more information on functions and each parameter, see page 214, Move Clock in Song Job mode.

■ Track

Settings: 1 ~ 4

■ Measure

Settings: 01 ~ 16 (for the beginning measure and the end measure)

■ Clock

Settings: -9999 ~ +0 ~ +9999

3. Modify GateTime

This job alters the gate time of the notes in the specified range. The gate time indicates the length of time that a note is held. For sustained voices, the gate time is equal to the actual playback time span. You can modify the gate time using two types of parameters: the Rate and Offset.

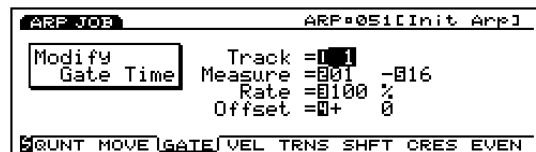

NOTE For more information on functions and each parameter, see page 215, Modify Gate Time in Song Job mode.

■ Track

Settings: 1 ~ 4

■ Measure

- ❑ **Settings:** 01 ~ 16 (for the beginning measure and the end measure)

■ Rate

- ❑ **Settings:** 000% ~ 100% ~ 200%

■ Offset

- ❑ **Settings:** -9999 ~ +0 ~ +9999

4. Modify Velocity

This job alters the velocity of the notes in the specified range. The velocity refers to the strength at which a key is pressed. You can change the velocity using two types of parameters: the Rate and Offset.

NOTE The volume may differ depending on the selected voice that has a different velocity settings in the Voice Edit mode.

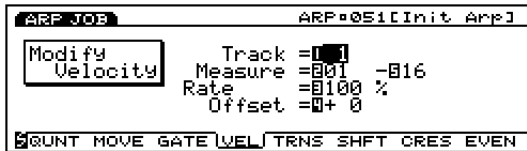

NOTE For more information on functions and each parameter, see page 216, Modify Velocity in Song Job mode.

■ Track

- ❑ **Settings:** 1 ~ 4

■ Measure

- ❑ **Settings:** 01 ~ 16 (for the beginning measure and the end measure)

■ Rate

- ❑ **Settings:** 000% ~ 100% ~ 200%

■ Offset

- ❑ **Settings:** -99 ~ +0 ~ +99

5. Transpose

This job lets you transpose in semitones the notes in the designated range of a specified arpeggio track.

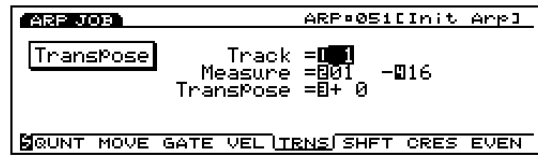

NOTE For more information on functions and each parameter, see page 217, Transpose in Song Job mode.

■ Track

- ❑ **Settings:** 1 ~ 4

■ Measure

- ❑ **Settings:** 01 ~ 16 (for the beginning measure and the end measure)

■ Transpose

- ❑ **Settings:** -99 ~ +0 ~ +99

6. Shift Note

This job replaces all occurrences of a specified pitch (within the designated range of the specified arpeggio track) with some other pitch.

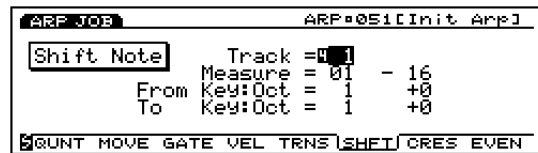

NOTE For more information on functions and each parameter, see page 217, Shift Note in Song Job mode.

■ Track

- ❑ **Settings:** 1 ~ 4

■ Measure

- ❑ **Settings:** 01 ~ 16 (for the beginning measure and the end measure)

■ From Key: Oct

- ❑ **Settings:**
 - Key Number:** 1 ~ 16
 - Octave:** -4 ~ 0 ~ +3

■ To Key: Oct

□ Settings:

Key Number: 1 ~ 16

Octave: -4 ~ 0 ~ +3

NOTE For information on the Key Number and Octave, see page 240.

7. Crescendo

This job gradually increases or decreases the volume of the arpeggio. This job produces the crescendo (increasing) or diminuendo (decreasing) effect by applying a gradual change to the velocity of a designated range of a specified track.

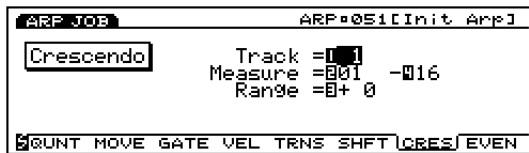

NOTE For more information on functions and each parameter, see page 217, Crescendo in Song Job mode.

■ Track

□ Settings: 1 ~ 4

■ Measure

□ Settings: 01 ~ 16 (for the beginning measure and the end measure)

■ Range

□ Settings: -99 ~ +0 ~ +99

8. Shift Event

This job replaces all occurrences of a specific event type (within the designated range of the specified arpeggio track) with some other designated event type.

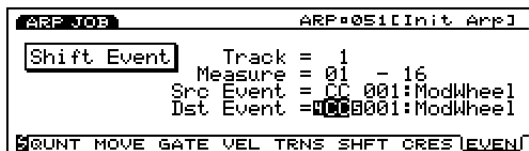

NOTE For more information on functions and each parameter, see page 218, Shift Event in Song Job mode.

■ Track

□ Settings: 1 ~ 4

■ Measure

□ Settings: 01 ~ 16 (for the beginning measure and the end measure)

■ Src Event (Source Event)

□ Settings: Control Change, Ch After Touch (Channel After Touch), Pitch Bend, Note (Note#: note numbers), Note (Vel: velocity values of each note)

■ Dst Event (Destination Event)

Sets the Shift Event event that the source event is changed to.

□ Settings: Control Change, Ch After Touch (Channel After Touch), Pitch Bend, Note (Note#: the data change of the source event will be replaced with note numbers with the fixed velocity 64 and fixed gate time 108), Note (Vel: the data change of the source event will be replaced with velocities with the fixed pitch C3 and fixed gate time 108).

[F7]: UNDO/REDO

Undo/Redo function is assigned to [F7]. Undo cancels the operation you made in your most recent record, edit, or job operation, restoring the data to its previous state. Redo, which becomes available only after you execute an Undo, cancels Undo operation and restores the changes. When you inadvertently execute a job, make a mistake while recording or editing, this job is convenient for restoring important data that would otherwise be lost.

NOTE For more information on Undo/Redo, see page 218.

Disk Mode

In Disk mode you can transfer data between a floppy disk and the EX5/5R/7; you can save data to floppy disk and load data back from floppy disk. Also with installation of the optional SCSI board, data can be transferred between an external SCSI data storage device such as a hard disk and your EX5/5R/7.

Devices That Can Be Used

Floppy Disk

On the left side of the unit there is an internal floppy disk drive. The EX5/5R/7 can use two types of floppy disk, the 3.5 inch 2HD and the 3.5 inch 2DD.

External SCSI Device:

External SCSI devices such as a hard disk, CD-ROM (CD-ROM format: ISO 9660, Mac/ISO Hybrid [ISO data only], Mixed Mode CD [Track1 data only]), ZIP, and JAZ disk drives can be used.

To use an external SCSI device, the optional SCSI board (ASIB1) must be installed. For information about installing the optional SCSI board, see page 278.

Precautions

Handling the Floppy Disk Drive(FDD) and Floppy Disk

- Be sure to handle floppy disks and treat the disk drive with care. Follow the important precautions below.

■ Inserting/Ejecting Floppy Disks

- To insert a floppy disk into the disk drive: Hold the disk so that the label of the disk is facing upward and the sliding shutter is facing forward, towards the disk slot. Carefully insert the disk into the slot, slowly pushing it all the way in until it clicks into place and the eject button pops out.
- To eject a floppy disk: Before ejecting the disk, be sure to confirm that the FDD is stopped (check if the LED below the floppy disk slot is off).
- Press the eject button slowly as far as it will go; the disk will automatically pop out. When the disk is fully ejected, carefully remove it by hand.

- Never attempt to remove the disk or turn the power off during recording, reading and playing back. Doing so can damage the disk and possibly the disk drive.
- If the eject button is pressed too quickly, or if it is not pressed in as far as it will go, the disk may not eject properly. The eject button may become stuck in a half-pressed position with the disk extending from the drive slot by only a few millimeters. If this happens, do not attempt to pull out the partially ejected disk, since using force in this situation can damage the disk drive mechanism or the floppy disk. To remove a partially ejected disk, try pressing the eject button once again, or push the disk back into the slot and then repeat the eject procedure.
- Be sure to remove the floppy disk from the disk drive before turning off the power. A floppy disk left in the drive for extended periods can easily pick up dust and dirt that can cause data read and write errors.

■ Cleaning the Disk Drive Read/Write Head

- Clean the read/write head regularly. This instrument employs a precision magnetic read/write head which, after an extended period of use, will pick up a layer of magnetic particles from the disks used that will eventually cause read and write errors.
- To maintain the disk drive in optimum working order Yamaha recommends that you use a commercially-available dry-type head cleaning disk to clean the head about once a month. Ask your Yamaha dealer about the availability of proper head-cleaning disks.

NOTE Never insert anything but floppy disks into the disk drive. Other objects may cause damage to the disk drive or floppy disks.

About the Floppy Disks

■ To handle floppy disks with care:

- Do not place heavy objects on a disk or bend or apply pressure to the disk in any way. Always keep floppy disks in their protective cases when they are not in use.
- Do not expose the disk to direct sunlight, extremely high or low temperatures, or excessive humidity, dust or liquids.

- Do not open the sliding shutter and touch the exposed surface of the floppy disk inside.
- Do not expose the disk to magnetic fields, such as those produced by televisions, speakers, motors, etc., since magnetic fields can partially or completely erase data on the disk, rendering it unreadable.
- Never use a floppy disk with a deformed shutter or housing.
- Do not attach anything other than the provided labels to a floppy disk. Also make sure that labels are attached in the proper location.

■ To protect your data (Write-protect Tab)

To prevent accidental erasure of important data, slide the disk's write-protect tab to the protect position (tab open).

■ Data backup

For maximum data security Yamaha recommends that you keep two copies of important data on separate floppy disks. This gives you a backup if one disk is lost or damaged.

Types of Data

The Disk mode handles the following nine types of data. The data that can be handled will differ depending on the type of data.

System, Performance, Voice, Wave, Sample, Song, Pattern, Arpeggio, Keymap

Types of Files

The eight types of files below can be saved and loaded by the EX5/5R/7.

■ 1. All Data

An "All Data" file handles all of the data in the internal memory as a single file.

□ Data

System, Performance, Voice, Wave, Sample, Song, Pattern, Arpeggio, Keymap

□ File Extension

.S1A

■ 2. Synth All

A "Synth All" file handles all of the internal voice and performance data (265 voices and 128 performances) and the system data as a single file.

□ Data

System, Performance, Voice

□ Data that can be handled as a single file when loading

1 Performance, 1 Voice

□ File Extension

.S1Y

■ 3. Voice

A "Voice" file handles the 256 voice data (excluding Wave data) as a single file.

□ Data

Voice (Element)

□ Data that can be handled as a single file when loading

1 Voice (Element)

□ File Extension

.S1V

■ 4. Wave

A "SMPL" file handles all of the wave and sample data as a single file.

□ Data

Wave, Sample

□ Data that can be handled as a single file when loading

1 wave and all the samples that wave uses

□ File Extension

.S1M

■ 5. SMF (MIDI File)

An "SMF" file handles the Sequence track (TR1 ~ TR16) and Tempo track data created in the Song mode as a Standard MIDI File (SMF). Play Effects, Output select, and Controller data are not included in an "SMF" file.

□ Data

Save = SMF Format 0

Load = SMF Format 0/1(Note 1) and ESEQ (Note 2)

*Direct Play (Note 3) function(SMF Format 0 file)

□ File Extension

.MID

6. SONG

A “SONG” file handles all of the song data (1 song) created in Song mode as a single file. Play Effects, Track Transmit Channel, and Controller data are included in a “Song” file.

❑ **Data**
Song

❑ **File Extension**
.S1S

7. PTN (Pattern):

A “PTN” file handles all of the User pattern data created in Pattern mode as a single file. Play Effects and Track Transmit Channel data are included in a “PTN” file.

❑ **Data**
Patterns

❑ **Data that can be handled as a single file when loading**
1 Pattern

❑ **File Extension**
.S1P

8. ARP (Arpeggio)

An “ARP” file handles all of the User arpeggio data as a single file. Play Effects and Track Transmit Channel data are included in a “ARP” file.

❑ **Data**
Arpeggio

❑ **Data that can be handled as a single file when loading**
1 Arpeggio

❑ **File Extension**
.S1R

Note 1: SMF (Standard MIDI File) is the common file format for sequence data, supported by many musical instrument manufacturers and computer software companies. If a song file is saved in the Standard MIDI File Format, the data created on one MIDI device can be edited or played on another MIDI device.

There are two types of Standard MIDI File formats.

- **Format 0:** Handles data on one track, then transmits it through multiple MIDI channels.
- **Format 1:** Handles data on multiple tracks, then transmits them through multiple MIDI channels.

Note 2: ESEQ is a sequencer format developed by Yamaha. The song data created by the Yamaha digital musical instruments such as QS300, QY700, Disklavier and Clavanova (excluding the commercially available disks for Disklavier and Clavanova) can be loaded and played back.

Note 3: “Direct Play” function allows you to start the song playback immediately without loading the data from a disk. The EX5/5R/7 plays back a Format 0 song file as it reads the data in a disk. It comes in handy for you to check the contents of the disk.

Auto Load Function

—Filenames that can automatically load the disk data

In Disk mode there is a function that automatically loads a file from a floppy disk when the power is turned on. (For this function a floppy disk should be inserted in the floppy disk drive before turning the power on.)

The file type that can automatically be loaded and played back is an “All Data” file.

- **Auto Load:** A file named “AUTOLOAD.S1A” will automatically be loaded when the power is turned on.

Steps for Disk Mode Operations

- 1 Press [DISK] on the panel to enter Disk mode. The following basic menu with the seven types of operations will be displayed in the screen.

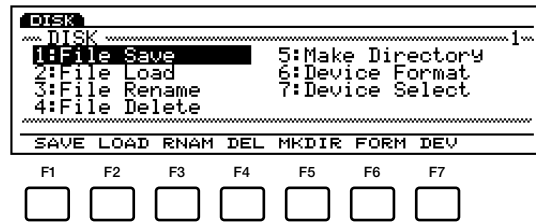

Basic Menu

- [F1]: SAVE (File Save: Saving files to a floppy disk)
- [F2]: LOAD (File Load: Loading a file from a floppy disk)
- [F3]: RNAM (File Rename: Naming or renaming files)
- [F4]: DEL (File Delete: Deleting unnecessary files)
- [F5]: MKDIR (Make Directory: Setting the file directories)
- [F6]: FORM (Device Format: Formatting the floppy disk drive)
- [F7]: DEV (Device Select: Selecting devices to use)

- 2 Move the cursor to one of the seven types in the basic menu, and press [ENTER] to select an operation. Also you can directly select an operation from the basic menu by pressing [F1] ~ [F7] under the screen.

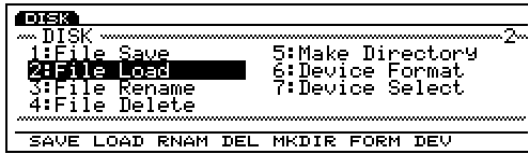

- 3 (When 1: SAVE, 2: LOAD, 3: RENAME or 4: DELETE is first selected) select a file type. Move the cursor to a file type, and press [ENTER] to make a selection. Also, you can directly select a file type by pressing [F1] ~ [F8] under the screen.

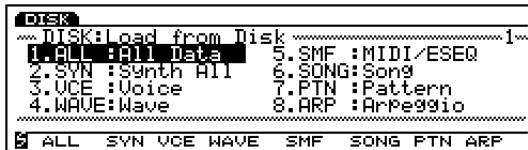

NOTE When the  mark is displayed in the lower left-hand corner of the screen, [SHIFT] key can be used. Press [SHIFT] to access the operations of the previous menu (in this case the basic menu with SAVE, LOAD, RNAM etc.). Hold down [SHIFT] and press a Function key [F1] ~ [F7] to directly select an operation.

NOTE Or press [EXIT] located below the right hand corner of the screen to return to the previous menu.

The Function Keys After Selecting the Basic Menu

In the step 2 above, when one of the basic menu other than [F6]: Device Format and [F7]: Device Select is selected, [F2]: 123..., [F3]: ABC..., [F6]: PLAY, [F7]: NAME, and [F8]: DIR will be displayed at the bottom of the screen.

[F2]: 123... (Chronological order) and [F3]: ABC... (File Name)

Each time you press the Function keys, the file names in the accessed disk will be displayed in order according to the following rule. Press [F2] to display the files of the specified type in the order they were saved, and press [F3] to display the files in alphabetical order. You can search the file you need quickly using these functions.

[F6]: PLAY

When you select “SMF” file type (with Format 0) in the load (File Load) operation, [F6] (PLAY) will be added to the screen indicating that the Direct Play function (page 261) is active. Press [F6] to play back the selected SMF file. After playback begins “PLAY” changes to “STOP.” Press [F6] (STOP) to stop playback (playback will end and “STOP” will change back into “PLAY.”

NOTE Even when [F6] (PLAY) is added to the screen, you cannot use this Direct Play function to play back the “SMF” file type in Format 1.

[F7]: NAME (File Name)

1: When [F1]: SAVE, [F3]: RENAME, or [F5]: Make Directory is selected from the basic menu, [F7] NAME (File Name) is added to the screen. Here you can name the files or change the file names (page 263).

[F8]: DIR (Directory)

Press [F8] DIR to view the Directory screen (a list of files). This function is convenient for selecting files. By pressing [F2] or [F3], it is possible to display the disk directory files (on the screen) in the order they were saved or in the alphabetical order. Move the cursor to the file that you want to select. To return to the previous screen, press EXIT.

- 4 (If necessary,) press the cursor keys to move the cursor to the items and use [INC]/[DEC] or Data Dial to select the desired file.

File Directory

“DIR” displayed in a file name indicates that there is a sub-directory. To access the sub-directory, move the cursor to select the sub-directory name and press [ENTER]. The file sub-directory will be displayed one line below the file name that contained DIR. If you select the file name “up dir” (up directory) that is within the sub-directory, and press [ENTER], the screen will return to the previous directory.

Changing Disks

(When an external disk has been connected)

Move the cursor to Device Name, and use [INC]/[DEC] or the Data Dial to select a device (disk) and press [ENTER]. The current disk drive is replaced with the newly selected disk.

- 5 (If necessary,) press [F7] to show the Name screen to name a file.

- 6 Press [ENTER].
The following pop-up menu will appear, prompting confirmation of the operation.
- 7 Press [YES] (INC) to execute the operation.
Press [NO] to cancel the job.
When the operation is being executed, "Executing..." will be displayed. When the operation is completed "Complete!" will be momentarily displayed.
- 8 When you have completed operations, press EXIT (the number of times will vary) to exit the Disk mode.

You can also exit the Disk mode by pressing another Mode key.

[F1]: SAVE (File Save)

This operation saves the file you have created to the disk.

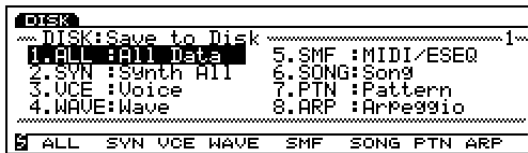

NOTE To save data to floppy disk, it is first necessary to format (initialize) the disk (page 269).

To name a newly saved file, press [F7]: NAME to display the Name screen, and you can name the file (a maximum of eight characters). For information on how to name files, see below.

To write over already existing file names, it is convenient to press [F8]: DIR and display the Directory screen.

Pressing [F2] or [F3] key will display the disk files (on the screen) in the order they were saved or in the alphabetical order. You can search the file you need quickly using these functions.

- NOTE** For information on the selectable types of data, see page 260.
- NOTE** When the size of the file is larger than the available space on the floppy disk, "Disk Full" message will be displayed. In this case, you can either delete unnecessary files to create more available memory on the floppy disk, or start the save operation once more with a different disk.
- NOTE** When you try to save a file which file name already exists, "Overwrite? Are you sure?" confirmation message will be displayed.

Take note that mistaken operations will erase important data from your disk permanently.

Setting a File Name

- 1 Press [F7] and the NAME screen will be displayed.



- 2 Use [INC]/[DEC] or Data Dial to select a number, letter, or symbol.
- 3 Move the cursor and select the next character.
- 4 Repeat the above steps 2 and 3 to set the song file name.

You can also enter numbers, letters, or symbols using the numeric keypad. Several letters or symbols are assigned to each key (available letters or symbols are printed below each key). For example, each time the 0 key is pressed, the available number and letters are displayed in the following order: 0→A→B→C. SPACE (one space) is assigned to [ENTER] key. You can also move through the input locations (numbers, letters, and symbols) using the cursor key.

Available numbers and letters:
Shown in the above illustration.

NOTE Lower case letters are not available. Setting a name is based on MS-DOS specifications. If you use a letter that is not included in MS-DOS, "_" (underline bar) is automatically located in place of the unrecognizable letter that was entered.

[F1]: ALL (All Data)

Saves all of the data in the internal memory as a single file.

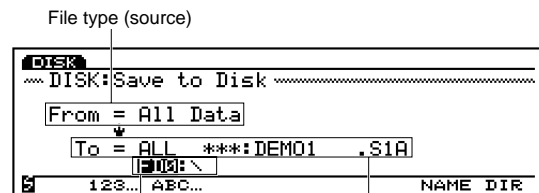

Device name/directory (destination) File number/name (destination)

- Settings:**
 - File number (destination)
 - Device name/directory (destination)

NOTE When there is only one directory layer, the disk directory indication will not be displayed.

[F2]: SYN (Synth All)

Saves all of the internal voice and performance data (265 voices and 128 performances) and the system data as a single file. Sequence and sample data are not included in “SYN” files.

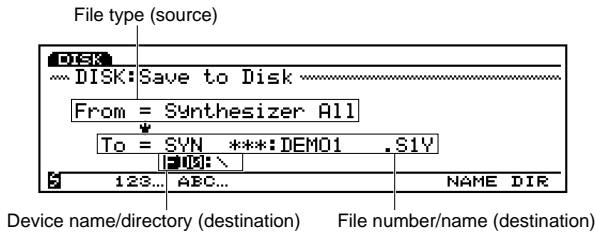

- Settings:
 - File number (destination)
 - Device name/directory (destination)

[F3]: VCE (Voice)

Saves the 256 voice data (excluding wave data) as a single file. Sample data is not included in “VCE” files.

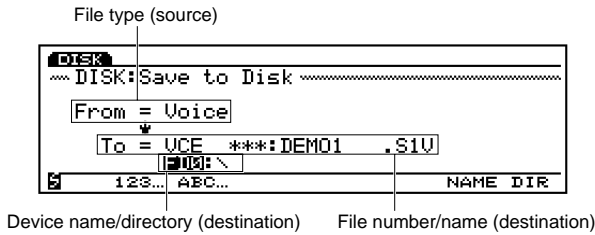

- Settings:
 - File number (destination)
 - Device name/directory (destination)

[F4]: WAVE

Saves all of the wave and sample data as a single file.

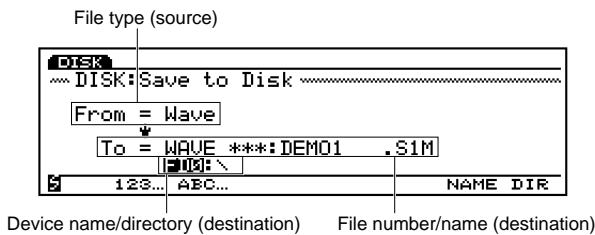

- Settings:
 - File number (destination)
 - Device name/directory (destination)

NOTE When the internal memory has been increased, a floppy disk may not be able to accommodate the wave data. In this case, you cannot save the data by dividing it into several floppy disks. If necessary, install and use an external SCSI data storage device.

[F5]: SMF (MIDI File)

Saves the Sequence track (TR1 ~ TR16) and Tempo track data (created in the Song mode as song data) as a Standard MIDI File (SMF). Data such as Play Effects data is not included in a “SMF” file.

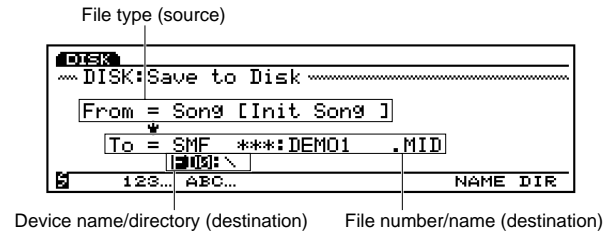

- Settings:
 - File number (destination)
 - Device name/directory (destination)

When saving SMF file, all file types are displayed and selectable at the file destination. Be aware that you may inadvertently overwrite and erase your important data!

[F6]: SONG

Saves all of the song data created in Song mode as a single file. Data such as Play Effects data is included in a Song file.

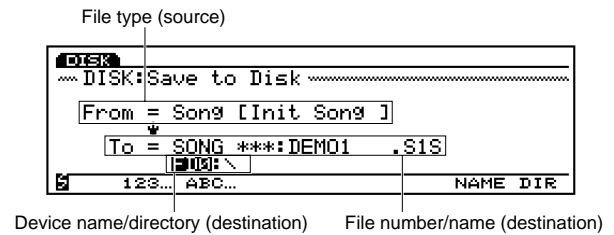

- Settings:
 - File number (destination)
 - Device name/directory (destination)

[F7]: PTN (Pattern)

Saves all of the User pattern data created in Pattern mode as a single file.

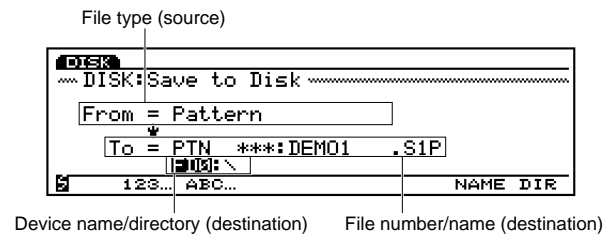

- Settings:
 - File number (destination)
 - Device name/directory (destination)

[F8]: ARP (Arpeggio)

Saves all of the User arpeggio data as a single file.

File type (source)



Device name/directory (destination) File number/name (destination)

Settings:

- File number (destination)
- Device name/directory (destination)

[F2]: LOAD (File Load)

This operation loads a file from disk to the internal memory.

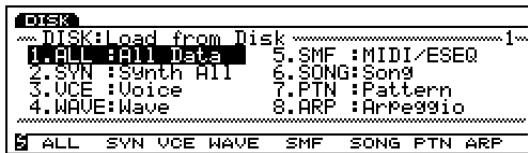

If many files exist on a disk, displaying the Directory screen by pressing [F8]: DIR will help you to find your desired file.

Pressing [F2] or [F3] key will display the disk files (on the screen) in the order they were saved or in the alphabetical order. You can search the file you need quickly using these functions.

While in the Directory screen, it is possible to display the disk directory files (on the screen) in the order they were saved or in the alphabetical order by pressing [F2] or [F3].

NOTE For information on the selectable types of data, see page 260.

NOTE There is a function that automatically loads a file from a floppy disk when the power is turned on. (For this function, a floppy disk should be inserted in the floppy disk drive before turning the power on.) For more information, see Auto Load Function, page 261.

Take note that when data is loaded into the internal memory, the previously existing data will be lost. Please be careful.

Take note that mistaken operations will erase important data from your disk permanently.

NOTE When the remaining memory is not sufficient, “Memory full” message will be displayed. In this case, you can either delete unnecessary data to create more available memory, or start the load operation once more from the beginning.

NOTE When you try to load the file type which is not included in the disk, “File not found!” will be displayed and the operation cannot be executed.

[F1]: ALL (All Data)

Loads an “ALL” file from the disk into the internal memory.

Device name/directory (source)



File type (destination) File type and file number/name (source)

Settings:

- Device name/directory (source)
- File number (source)

[F2]: SYN (Synth All)

Loads a “Synth All” file from the disk into the internal memory. You can load all of the performance and voice data or only a specified performance/voice at a time.



Device name/directory (source) File type and file number/name (source)



The type of destination data

The type of source data

■ Synth All source data (From)

(If necessary select the source data device,) move the cursor to a file number, and select a source file for the load operation. A performance/voice file (128 Performances and 256 Voices) can be loaded. Move the cursor to “All Data” and use [INC]/[DEC] to select “Performance” (128 Performances) or “Voice” (256 Voices). Furthermore, one performance/voice can be designated and loaded. In this case, only a specified performance/voice number will be replaced with the newly loaded data.

■ Synth All destination data (To)

The destination that can be selected will differ depending on the setting designated in “From.”

Settings:

Source data (From):	Destination (To):
All Data	→ All Data
Performance & Voice	→ Performance & Voice
Performance All	→ Performance All
001~128	→ 001~128
Voice All	→ Voice All
Bank I1~I2 (001~128)	→ Bank I1~I2 (001~128)

NOTE In an All Data, System data is included.

[F3]: VCE (Voice)

Loads a “Voice” file from the disk into the internal memory. You can load all of the voices or only a specified voice at a time.



Device name/directory (source) File type and file number/name (source)

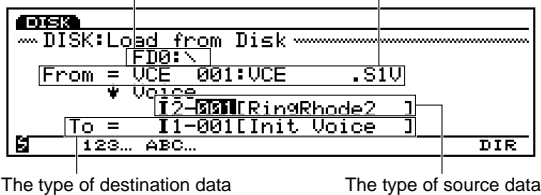

■ Voice source data (From)

(If necessary select the source data device,) move the cursor to a file number, and select a source file for the load operation. A Voice file (256 Voices) can be loaded. Furthermore, one voice can be designated and loaded. In this case, only a specified voice number will be replaced with the newly loaded data.

■ Voice destination data (To)

The destination that can be selected will differ depending on the setting designated in “From.”

Settings:

Source data (From):	Destination (To):
All Data	→ All Data
Voice Bank I1~I2 (001~128)	→ Voice Bank I1~I2 (001~128)

[F4]: WAVE

Loads a wave file from the disk into the internal memory. You can load all of the wave data or only a specified wave at a time.



Device name/directory (source) File type and file number/name (source)



■ Sample source data (From)

(If necessary select the source data device,) move the cursor to a file number, and select a source file for the load operation. All wave data can be loaded at a time. Furthermore, one wave can be designated and loaded. In this case, only a specified wave number will be replaced with the newly loaded data.

■ Sample destination data (To)

The destination that can be selected will differ depending on the setting designated in “From.”

□ Settings:

Source data (From):	Destination (To):
All Data	All Data
0001~1024	Wave DRAM or FLASH (0001~1024)

NOTE The samples of WAV, AIFF and AKAI file types can be loaded. As to the WAV and AIFF files, you can select “1 file” or “all files” as the source. When “1 file” is selected, the currently displayed file will be loaded. When “all files” is selected, all the WAV (or AIFF) files in the designated directory will be loaded.

As to the AKAI files, you can load its data via the floppy disk drive and CD-ROM drive only.

[F5]: SMF (MIDI File)

Loads an ESEQ file with the extension “.ESQ” or a MIDI file with the extension “.MID” from the disk into the internal memory.

NOTE For more information on ESEQ file format, see File Type on page 261.

Device name/directory (source)

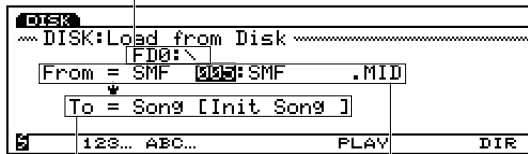

The type of destination data File type and file number/name (source)

When a Standard MIDI file and ESEQ file co-exist on the same disk, both files will be displayed in the same screen.

□ Settings:

- Device name/directory (source)
- File number (source)

Direct Play function

With the SMF format 0 file, a file can be played back without loading. Select a SMF format 0 file, push [F6] and playback will start immediately. In this case the data is not loaded into the internal memory, it is merely read directly from the disk and played back. This is particularly convenient for auditioning songs quickly. For more information on Direct Play, see File Type on page 261.

[F6]: SONG

Loads a song file from the disk into the internal memory. Data such as Play Effects, Track Transmit Channel and Controller data is included in a song file.

Device name/directory (destination)



The type of destination data File type and file number/name (source)

□ Settings:

- Device name/directory (source)
- File number (source)

[F7]: PTN (Pattern)

Loads a pattern file from the disk into the internal memory. Data such as Play Effects, Track Transmit Channel and Controller data is included in a pattern file.



Device name/directory (source) File type and file number/name (source)



The type of destination data The type of source data

■ Pattern source data (From)

(If necessary select the source data device,) move the cursor to a file number, and select a source file for the load operation. A pattern file (50 patterns) can be loaded. Furthermore, one pattern can be designated and loaded. In this case, only a specified pattern number will be replaced with the newly loaded data.

■ Pattern destination data (To)

The destination that can be selected will differ depending on the setting designated in “From.”

□ Settings:

Source data (From):	Destination (To):
All Data	→ All Data
Pattern 1~50	→ Pattern 1~50

[F8]: ARP (Arpeggio)

Loads an arpeggio file from the disk into the internal memory. Data such as Play Effects, Track Transmit Channel and Controller data is included in an arpeggio file.

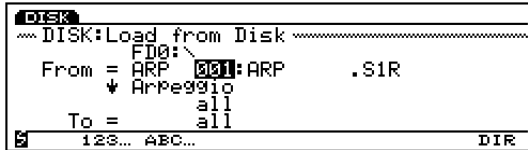

Device name/directory (source) File type and file number/name (source)



The type of destination data

The type of source data

■ Arpeggio source data (From)

(If necessary select the source data device,) move the cursor to a file number, and select a source file for the load operation. An arpeggio file (50 arpeggios) can be loaded. Furthermore, one arpeggio can be designated and loaded. In this case, only a specified arpeggio number will be replaced with the newly loaded data.

■ Arpeggio destination data (To)

The destination that can be selected will differ depending on the setting designated in “From.”

□ Settings:

Source data (From):	Destination (To):
All Data	→ All Data
Arpeggio 51~100	→ Arpeggio 51~100

[F3]: RNAM (File Rename)

This operation renames a file in a disk.

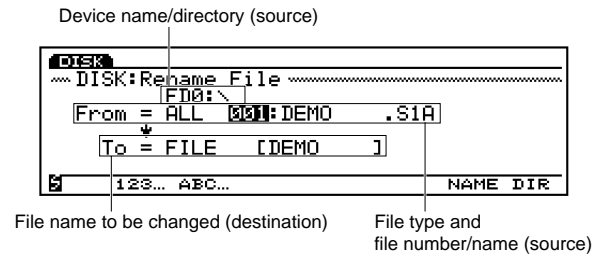

(If necessary, select a device beforehand) select the file type and file number (name) you want to change, and press [F7]: NAME to show the Name screen, then input the new name. For more information on how to name files, see page 263.

Once you input a file name, press [EXIT] to close the Name screen and press [ENTER]. The confirmation message “Rename File: Are you sure?” will be displayed. Press [INC/YES] to execute the Rename function or press [DEC/NO] to abort the operation.

NOTE A file can not be given a name that is identical to an already existing file name.

[F4]: DEL (Delete)

This operation deletes a file in a disk.

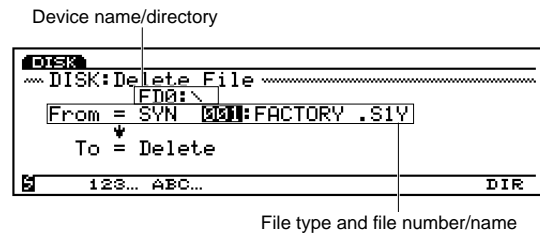

(If necessary, select a device beforehand) select the file type and file number (name) to delete, and press [ENTER]. The confirmation message “Delete File: Are you sure?” will be displayed. Press [INC/YES] to execute the Delete function, or press [DEC/NO] to abort the operation.

[F5]: MKDIR (Make Directory)

This operation creates a directory. It is possible to make directory within a directory which is called a sub-directory. This allows you to do systematic file management.

NOTE Only a maximum of two layers of a sub-directory can be made.

NOTE A directory can not be given a name that is identical to an already existing directory name.

```
DISK
-----
Make Directory
-----
TO = DIR  ***:DIR123
  F00:\
-----
123... ABC...          NAME DIR
```

NOTE When there is only one directory layer, the disk directory indication will not be displayed.

(If necessary, select a device beforehand) after selecting a directory, press [F7]: NAME to show the Name screen, and input the name of the sub-directory that you will create. For more information on how to name directories, see page 263.

Once you input a directory name, press [EXIT] to close the Name screen and press [ENTER]. The confirmation message “Make Directory: Are you sure?” will be displayed. Press [INC/YES] to execute the Make Directory function, or press [DEC/NO] to abort the operation.

NOTE “DIR” displayed in a file name indicates that there is a sub-directory. To access the sub-directory, move the cursor to select the sub-directory name and press [ENTER]. The file sub-directory will be displayed one line below the file name that contained DIR. If you select the file name “up dir” (up directory) that is within the sub-directory, and press [ENTER], the screen will return to the previous directory.

[F6]: FORM (Device Format)

This operation formats (initializes) the disk. It is necessary to first format new floppy disks or external SCSI devices such as hard disk, ZIP, and JAZ disk drives before use.

NOTE For more information on external SCSI devices, see “Devices That Can Be Used” (page 259).

NOTE Since the “TOOL” disk included in the ZIP/JAZ drives has a special type of processing, the EX5/5R/7 cannot format these disks. Therefore use a computer to format the disk using the ZIP/JAZ included software. In general, the EX5/5R/7 can format normal ZIP/JAZ disks. For more information on ZIP/JAZ disks, refer to the owner’s manual for the respective products.

```
DISK
-----
DISK:Format Disk
Device=F00
Please insert a blank disk
and
Press [ENTER]
-----
SAVE LOAD RNAM DEL MKDIR FORM DEV
```

Insert a new disk into the disk drive (when using an external SCSI device confirm that it is connected properly) and press [ENTER]. The LED below the floppy disk drive slot will turn on (blink) and formatting will begin. While formatting is taking place, “Executing...” will be displayed.

NOTE If you re-format a disk that has already been formatted and contains data, all of the data will be erased. Be careful not to erase your important data.

NOTE Do not try to forcefully remove the disk from the disk drive while formatting is taking place. This will damage the disk drive.

NOTE Take proper precautions when more than one external SCSI device are connected, so that you do not format, or erase data on the wrong disk drive.

[F7]: DEV (Device Select)

This operation displays the disk contents on a floppy disk and a connected external SCSI device. Device name, disk name, amount of memory used and amount of available memory are displayed.

```
DISK
-----
DISK:Device Select
Device=F00 [YAMAHA_EX ]
Used    1115 KB   Free    308 KB
-----
SAVE LOAD RNAM DEL MKDIR FORM DEV
```

Utility Mode

In Utility Mode, you can make the settings that are applied to the entire system, excluding [F2] menu for Voice Mode settings.

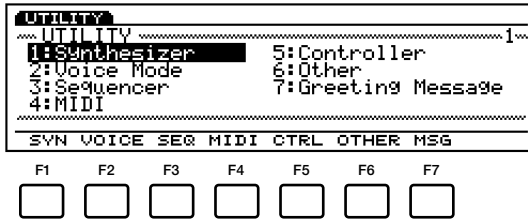

- [F1]: SYN (Settings related to the keyboard)
- [F2]: VOICE (Settings related to Voice Mode)
- [F3]: SEQ (Settings related to the sequencer function)
- [F4]: MIDI (Settings related to MIDI)
- [F5]: SYS (Settings related to the system)
- [F6]: OTHER (Other settings)
- [F7]: MSG (Message that appears when the power is turned on)

Steps for the Utility Mode Operation

1 Press [UTILITY] to enter the Utility Mode.

2 Press [F1] ~ [F7] to select a menu.

NOTE You can also select a menu by moving the cursor over the menu and pressing [ENTER].



3 Move the cursor to a parameter and use the Data Dial, [INC]/[DEC], or the numeric keypad to set the parameter.

NOTE If you select [F2] (Voice) and [F3] (SEQ) menu, each sub-menu will be added. While a sub-menu is displayed, you can select the other menu by holding down [SHIFT] and pressing one of the menu.

NOTE When you enter the Utility Mode, [KNOB] key light on the panel will go out indicating that the Knob function switches to data input. You can use the Knobs 1 ~ 6 to change the values for each parameter.

4 When you are finished setting the values, press another mode key to exit the Utility mode.

[F1]: SYN (Synthesizer Setup)

The Synthesizer Setup allows you to make settings for the entire keyboard such as the volume and pitch.

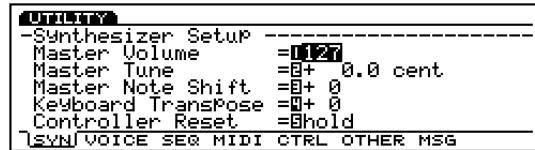

Master Volume

Sets the master volume for the entire keyboard.

Settings: 0 ~ 127

Master Tune

Adjusts the tuning for the entire keyboard. The pitch can be finely adjusted in units of cents.

Settings: -102.4 ~ +102.3

Master Note Shift

Adjusts the pitch in semitones. This setting affects only the internal tone generator and will not be output through MIDI.

Settings: -24 ~ +24

NOTE The settings exceeding the upper or lower limit of the keyboard (C-2 ~ G8) are invalid, therefore the notes exceeding the limit(s) will be replaced with the notes in a different octave.

Keyboard Transpose

Adjusts the keyboard pitch in semitones. This setting is output through MIDI.

Settings: -63 ~ +63

NOTE This parameter is not available on the EX5R.

NOTE The settings exceeding the upper or lower limit of the keyboard (C-2 ~ G8) are invalid, therefore the notes exceeding the limit(s) will be replaced with the notes in a different octave.

■ Controller Reset

Sets whether the controller value is retained (hold) or initialized (reset) when a different voice is selected. The controllers include Modulation Wheel, After Touch, Foot Controller, Breath Controller, Ribbon Controller (except EX5R), and Knobs.

❑ **Settings:** hold, reset

When “reset” is selected, the following controller values will be reset to each default.

Pitch Bend: center

Modulation Wheel: minimum

After Touch: minimum

Foot Controller: maximum

Breath Controller: maximum

Ribbon Controller: center

Knobs1 ~ 6: center

[F2]: VOICE (Voice Mode Setup)

The Voice Mode Setup allows you to make settings for the keyboard and controllers used in the Voice mode. When the Voice Mode Setup is selected, [F7]: CONNECT and [F8]: CTRL (Controller) sub-menus will be displayed.

[F7]: CONNECT

Sets the signal flow how the keyboard and/or controllers are connected to the internal tone generator as well as other settings such as the velocity curve, for the Voice mode.

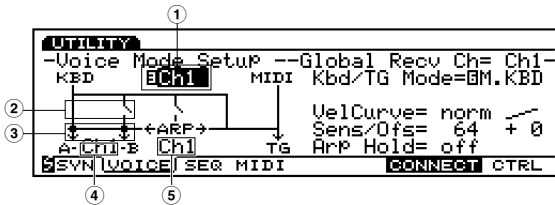

■ ① Global Recv Ch (Global Receive Channel)

Sets the MIDI receive channel for the.

❑ **Settings:** Ch1 ~ Ch16, omn (omni: all channels)

■ ② TrnsMIDI A/B (Transmit MIDI A/B)

Sets whether or not the operations on the keyboard and/or controllers are output from MIDI OUT A/B to an external device.

❑ **Settings:** | (output), ↯ (not output)

■ ③ Arp MIDI A/B (Arpeggio MIDI A/B)

Sets whether or not the arpeggio data is output from MIDI OUT A/B to an external device.

❑ **Settings:** + (output), ↯ (not output)

NOTE MIDI B for the above two parameters is available only with the EX5.

■ ④ MIDI Trans Ch (MIDI Transmit Channel)

Sets which MIDI channel the operations on the keyboard and/or controllers will be sent on.

❑ **Settings:** Ch1 ~ Ch16

■ ⑤ Arp MIDI Ch (Arpeggio MIDI Channel)

Sets which MIDI channel the arpeggio data will be sent on.

❑ **Settings:** Ch1 ~ Ch16

■ Kbd/TG Mode (Keyboard/Tone Generator Mode)

Sets how the tone generator is connected in the Voice mode. When used as a master keyboard, select M.KBD (Master Keyboard). In general this is set to TG (Tone Generator).

❑ **Settings:** M.KBD, TG

■ VelCurve (Velocity Curve)

Sets the velocity curve in the Voice mode. This setting determines how the sound is produced according to the strength at which notes are played on the keyboard. To the right of the selected value, the velocity curve is displayed graphically.

❑ **Settings:** norm (normal), soft, hard, wide, fix (fixed)

■ Vel Sens/Ofst (Velocity Sensitivity/Offset)

Sets the Velocity Sensitivity and Offset value.

❑ **Settings:**

Vel Sens (Velocity Sensitivity): 0 ~ 127

Vel Ofst (Velocity Offset): -64 ~ 0 ~ + 63

■ Arp Hold (Arpeggio Hold)

Sets the Arpeggiator Hold function to “on” or “off” in the Voice mode. When the Arpeggiator Hold function is set to “on,” once the keyboard (a note) is played, even if you release your finger from the keyboard, the Arpeggiator will automatically continue to play until the next note is played.

□ **Settings:** on, off

[F8]: CTRL (Controller)

Sets the parameters related to the controllers in the Voice mode.

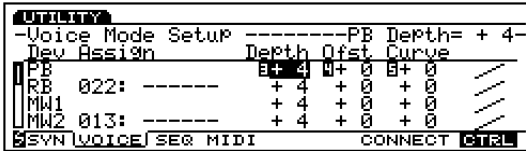

Each of the parameters below can be set for the 13 types of devices (controllers) above.

■ Assign

Sets a control function (MIDI control number) to each controller.

□ **Settings:** 000 ~ 095 (See the Control List in the separate Data List book.)

PB (Pitch Bend Wheel)
RC (Ribbon Controller)
MW1 (Modulation Wheel 1)
MW2 (Modulation Wheel 2)
KN1 (Knobs 1)
KN2 (Knobs 2)
KN3 (Knobs 3)
KN4 (Knobs 4)
KN5 (Knobs 5)
KN6 (Knobs 6)
AT (After Touch)
FC (Foot Controller)
BC (Breath Controller)

NOTE Some of the controllers such as Pitch Bend Wheel are fixed with a specific control function and therefore cannot be changed to another.

■ Depth

Sets the control depth for the currently selected control function.

□ **Settings:** -8 ~ 0 ~ +7

■ Ofst (Offset)

Finely adjusts the control depth that is set in Depth. This value offsets, or increases or decreases the Depth value.

□ **Settings:** -64 ~ 0 ~ +63

■ Curve

Sets and changes the controller curve (displayed to the right of the values).

□ **Settings:** -6 ~ 0 ~ +7

The Control Curve

Displayed to the far right of the screen is the current control curve image for each device. You can refer to this image when selecting the curve.

[F3]: SEQ (Sequencer Setup)

The Sequencer Setup allows you to make settings related to the sequencer functions. When Sequencer Setup is selected, [F6]: CLICK, [F7]: FILT (Filter), and [F8]: SYNC sub-menus will be displayed.

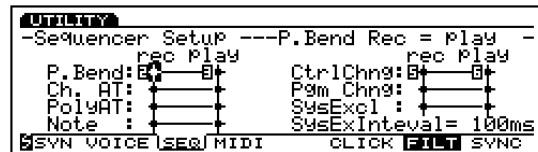

[F6]: CLICK (MIDI Click)

Sets the click sound that is used during recording or playback.

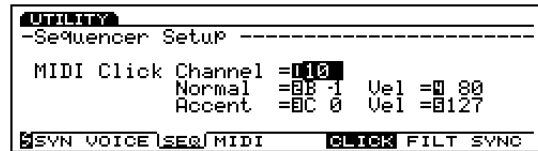

■ Channel

Sets the MIDI channel for the click sound data to be sent to the internal tone generator.

□ **Settings:** 1 ~ 16

■ Normal (Normal: Note name, Velocity)

Selects the note name (percussion) and the velocity for the normal beats.

□ **Settings:** Note Name = C-2 ~ G8, Vel (Velocity) = 1 ~ 127

■ Accent (Accent: Note name, Velocity)

Selects the note name (percussion) and the velocity for the accentuated first beat.

□ **Settings:** Note Name = C-2 ~ G8, Vel (Velocity) = 1 ~ 127

[F7]: FILT (Filter)

Sets whether or not a filter is applied (the signal is not input/output) for each MIDI event.

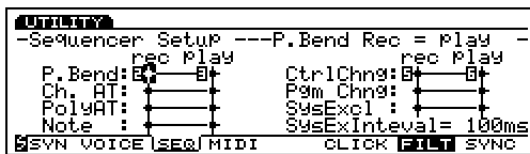

The filter can be applied either when recording or when playing back data. The filtered MIDI events will not be recorded or played back. The following list are MIDI events that can be filtered.

■ Filters

Sys Ex (System Exclusive)
Ch. AT (Channel After Touch)
PolyAT (Polyphonic After Touch)
Note
CtrlChng (Control Change)
Pgm Chng (Program Change)
P. Bend (Pitch Bend)

□ Settings:

rec (record): ÷ (not input/output), + (input/output)
play (playback): ÷ (not input/output), + (input/output)

■ SysEX Interval (System Exclusive Interval)

When playing back the system exclusive data (bulk data) that is recorded on the sequence tracks, this sets the interval that is inserted for each 1KB. When the bulk data is sent from the EX to the external device, a MIDI error may occur because of the inadequate capacity of the external device. This setting sets an interval time that provides enough time for the receiving device to process the bulk data.

□ Settings: 0 ~ 900 (msec)

NOTE The playback may be a little slower depending on the currently set interval. Also when a MIDI error occurs, try to set the interval a little higher and send the data.

[F8]: SYNC

Sets settings related to synchronization between the internal sequencer and external devices.

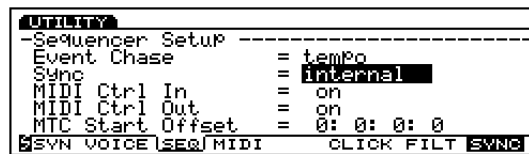

■ Event Chase

Event Chase allows during playback, fast forwarding, or rewinding, for a designated event not to be skipped. When Event Chase is set to a specific event, even if you fast forward or rewind, the playback data will be reproduced correctly.

□ **Settings:** Tempo; Tempo, PC (Tempo, Program Change); Tempo, PC, Ctrl (Tempo, Program Change, Control Change); All (All events)

NOTE When Event Chase is set, even if a song or phrase is played from a mid point (of the song or phrase), the designated event will be detected and played back at a high speed from the beginning of the song. For this reason, it may take some time to start playback or the fast forward/rewind may become slower.

NOTE When set to “ALL,” a large amount of MIDI data may be output through MIDI OUT jack resulting in a MIDI error for the external MIDI device.

■ Sync

When synchronizing a performance with an external MIDI device, this parameter selects whether the EX5/5R/7 uses own internal clock, or the MIDI clock and MTC signals that are received at MIDI IN.

When set to “internal”, the EX uses the internal clock. Select “internal” when using the EX alone, and when using it as a master to control the timing of external MIDI devices.

When set to “MIDI-A” (or “MIDI-B”), the EX will be controlled by the MIDI clock signals that are received at the MIDI IN(-A) jack (or MIDI-B jack). Select “MIDI-A” (or “MIDI-B”) when the EX is used as a slave (controlled by an external MIDI device).

When set to “MTC MIDI-A” (or “MTC MIDI-B”), the EX sends MMC signals from the corresponding MIDI OUT jack. (For “MTC MIDI-A,” the MIDI OUT(-A) jack and for “MTC MIDI-B,” the MIDI OUT-B jack). Select “MTC MIDI-A” (or “MTC MIDI-B”) when the EX is used as a slave (controlled by an external device such as a multi-track recorder corresponding to the MMC standard).

NOTE MTC (MIDI Time Code) is a Time Code that controls the timing of multiple audio devices through MIDI cables. The code is made up of “hour, minute, second, and frame.” The EX itself cannot output MTC and therefore to play in sync using MTC it is necessary to use a device such as the Yamaha MD4 that is capable of outputting MTC.

NOTE MMC (MIDI Machine Control) is a standard used in controlling devices such as a multi-track recorder using a MIDI sequencer. This means that when the operations such as start/stop, fast forward/rewind are activated on a sequencer, the multi-track recorder (that is receiving signals from the sequencer) will automatically move according to the corresponding operation. Therefore the multi-track recorder will keep the same location as that of the sequencer when played back. This setting should be used when the EX is being synced as a slave for performance, or when creating music using an external device corresponding to the MMC standard such as a multi-track recorder.

Settings: internal, MIDI-A, MTC MIDI-A, MIDI-B, MTC MIDI-B

NOTE “MIDI B” and “MTC MIDI-B” are available only with the EX5.

■ MIDI Ctrl In (MIDI Control In)

Sets whether or not the MIDI clock signals (start, stop, continue start, song position pointer) are received.

Settings: on (receive), off (not receive)

■ MIDI Ctrl Out (MIDI Control Out)

Sets whether or not the MIDI clock signals (start, stop, continue start, song position pointer) are sent.

Settings: on (send), off (not send)

■ MTC Start Offset (MTC Start Offset)

Sets the starting location for the internal sequencer in the following units, “hour, minute, second, and frame.” The internal sequencer will start at the predetermined timing when the MTC is received.

Settings: 0 ~ 23 for Hour, 0 ~ 59 for Minute and Second, 0 ~ 29 for Frame

[F4]: MIDI (MIDI Setup)

The MIDI Setup allows you to make settings related to MIDI for the entire keyboard.

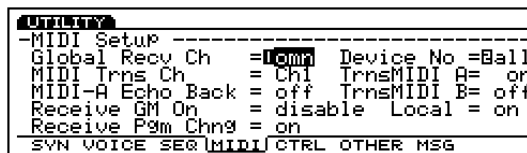

■ Global Recv Ch (Global Receive Channel)

Sets the MIDI receive channel for controlling the EX with an external device such as a MIDI sequencer or computer.

Settings: 1 ~ 16, omni (omni: all channels)

■ MIDI Trns Ch

Sets which MIDI channel the operations on the keyboard and/or controllers will be sent on.

Settings: Ch1 ~ Ch16

■ MIDI Echo Back

Outputs from MIDI OUT all data that is received at MIDI IN(A).

Settings: on (output), off (not output)

NOTE When an external MIDI device’s MIDI IN/OUT are connected to the EX’s MIDI OUT/IN, this setting should be set to “Off.”

NOTE In the case of EX5, this setting is effective only for the MIDI IN-A.

■ Receive GM On

Sets whether or not the GM On is received. When set to “enable,” GM On message can be received.

Settings: disable (not receive GM On), enable (receive GM On)

■ Receive Pgm Chng (Receive Program Change)

Sets whether or not the EX receives program change messages from an external device. When “ignore bank select” is selected, EX5/5R/7 receives the program change message but ignores the bank select message from an external device.

Settings: on, ignore bank select, off (not receive)

NOTE When sequence data is loaded from an external device or a floppy disk, this setting should be set to “on.”

■ Device No (Device Number)

Sets the MIDI device number. When sending or receiving system exclusive messages such as bulk dump or parameter change messages with an external device, you must match the device numbers for both the EX and the external device.

❑ **Settings:** off, 1 ~ 16, all

■ Trns MIDI A/B

Sets whether or not the operations on the keyboard and/or controllers are output from MIDI OUT A/B to an external device.

❑ **Settings:** on, off

NOTE Trns MIDI B parameter is available only with EX5.

■ Local (MIDI Control Out)

Sets the Local to “on” or “off.” When the Local is set to off, the keyboard and/or the controllers of the EX5/5R/7 are disconnected from the internal tone generator, and even if played, the keyboard will not produce sound. However, the EX performance data is sent from the MIDI OUT jack, and the the internal tone generator can receive signals received at the MIDI IN jack.

❑ **Settings:** on (connected), off (disconnected)

[F5]: CTRL (Controller Setup)

The Controller Setup allows you to make settings for various controllers.

```

UTILITY
-----
Controller Setup
Foot Sw Assign      =005:Port Sw
Foot Volume Assign  =011:Express.
Breath Controller Assign=Breath Ctrl
Scene Controller Assign =Mw2
Ribbon Controller Mode =Breset
-----
SYN VOICE SEQ MIDI CTRL OTHER MSG
    
```

As to the Foot Controller, you can set in the Voice mode (page 104) and Performance mode (page 169).

■ Foot SW Assign (Footswitch Assign)

Selects the control change function for the Footswitch. When an optional Yamaha FC4 or FC5 footswitch is properly connected, you can control the function assigned here with your foot.

❑ **Settings:** off, 000 ~ 100

NOTE This parameter is not available with EX5R.

NOTE For more information on the Control Numbers and the Control Change function, see the separate Data List book.

■ Foot Volume Assign

Selects which Control Changes, the Main Volume or Expression, is controlled by the Foot Volume. When an optional Yamaha FC7 or FC9 foot controller is properly connected, you can control the Main Volume or Expression with your foot.

❑ **Settings:** 007: Main Vol (Main Volume), 011: Express. (Expression)

NOTE This parameter is not available with EX5R.

NOTE For more information on Main Volume and Expression, see the separate Data List book.

■ Breath Controller Assign

Sets the controller for Breath Control. When “Breath Ctrl” is selected, Breath Control is accomplished with the Breath Controller, and likewise when “Velocity” is selected it is accomplished by the velocity. Also when “Touch EG” is selected, it is accomplished by the Touch EG.

❑ **Settings:** Breath Ctrl (Breath Control), Velocity, Touch EG

Expressivity of Each Controllers

The expressivity will differ depending on the selected controller.

Original image of breathing



Breath Ctrl

You can accomplish the breathing as you blow the Breath Controller.

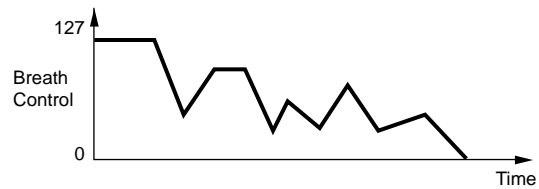

Velocity

The initial attack determines the sustained breath strength from the beginning through the end.

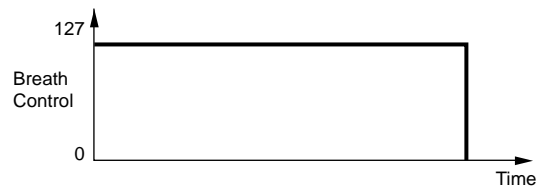

Touch EG

You can express the portion “A” with the velocity and “B” with the aftertouch.

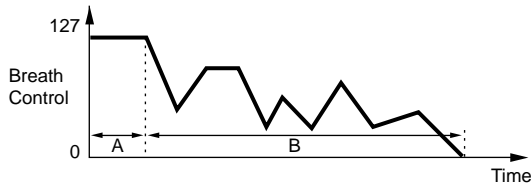

■ Scene Controller Assign

Sets the controller for Scene Control. You can select Modulation Wheel 2 or Foot Controller.

- ❑ **Settings:** MW2 (Modulation Wheel 2), FC (Foot Controller)

NOTE For more information on Scene Control, see page 57.

■ Ribbon Controller Mode

Sets whether the Ribbon Controller value returns to a center value when you release your finger from the Ribbon Controller (reset), or the value is retained at the value that your finger held before releasing (hold).

- ❑ **Settings:** hold, reset

NOTE This parameter is not available with EX5R.

[F6]: OTHER (Other Setup)

The “Other” Setup allows you to make miscellaneous settings that are applied to the entire system.

```
UTILITY
-----
-Other Setup
Effect Bypass  = [ ] Rev [ ] Cho [ ] Ins
Memory Protect = [ ] Off
Edit Confirm   = [ ] On
SCSI ID       = [ ]

SYN VOICE SEQ MIDI CTRL [OTHER] MSG
```

■ Effect Bypass

Selects the type of effect that is by-passed (the effect is not applied) when [EF BYPASS] ([BYPASS] on the EX5R) is pressed on the front panel.

- ❑ **Settings:** Rev (Reverb), Cho (Chorus), Ins (Insertion) each can be set to: (Off: effect is applied), (On: effect is by-passed)

■ Memory Protect

Sets whether or not the current user Voice, Performance, and Pattern data are protected. When set to “on,” it is not possible to store data. This setting is used on a temporary basis when you don’t want to lose user data.

- ❑ **Settings:** on, off

■ Edit Confirm

Sets whether or not the “Are you sure?” confirmation message will be displayed when you execute a Job or store data. You may want to skip the confirmation when you are accustomed to the EX operations. When set to “on,” the message will be displayed, and when set to “off,” the message will not be displayed.

- ❑ **Settings:** on, off

■ SCSI ID

Sets the SCSI ID number for the EX. The EX’s SCSI ID number is set to “2” when shipped from the factory. When connecting the EX to a SCSI device with the same SCSI ID number, it is necessary to change one of the devices’ ID number.

```
UTILITY
-----
-Other Setup
Effect Bypass  = [ ] Rev [ ] Cho [ ] Ins
Memory Protect = [ ] Off
Edit Confirm   = [ ] On
SCSI ID       = [ ]

SYN VOICE SEQ MIDI CTRL [OTHER] MSG
```

NOTE This “SCSI ID” parameter is not displayed or selected unless you install an optional ASIB1 SCSI Interface board.

NOTE To connect an external SCSI device to the EX, it is first necessary to install the separately sold ASIB1 (SCSI board).

NOTE When you change the SCSI ID number, it is necessary for you to turn the power off and back to on again, to make the change effective.

- ❑ **Settings:** 0 ~ 7

Word Clock

Sets whether the EX is used as the Word Clock master or as a slave. “Word Clock” means synchronization of the audio signal that passes through digital devices. It is necessary to use Word Clock when one or more digital audio devices are connected for playback or recording.

When the EX is used as a master, the Word clock is set at a sampling rate of 44.1kHz. When the EX is used as a slave, the Word Clock automatically changes to the clock received at WORD CLOCK IN (WORD CLOCK IN: separately sold EXDGO1 jack).

```
UTILITY
-----
-Other Setup -----
Effect Bypass  = [ ] Rev [ ] Cho [ ] Ins
Memory Protect = [off]
Edit Confirm   = [5on]

Word Clock     = _____
SYN VOICE SEQ MIDI CTRL OTHER MSG
```

□ **Settings:** internal (EX = master), external (EX = slave)

NOTE This “Word Clock” parameter is not displayed or selected unless you install an optional EXDGO1 Digital Output Board.

NOTE For the EX to output a digital signal, it is necessary to install the separately sold EXDGO1 (Digital Output Board).

NOTE When receiving word clock from an external audio device, you will need to connect the EXDGO1 (Word Clock In [BNC] jack) and the external audio device. In this case, use the BNC connector/coaxial cable with the impedance characteristics, 75Ω.

[F7]: MSG (Greeting Message)

Sets the message that will be momentarily displayed in the screen when the power is turned on. The message can be up to a maximum of 20 characters.

```
UTILITY
-----
↓
----->[Welcome To EX World.]-----
[ I am ready !! ]
0123456789!#$%&'()*-@^`{}~"'+,
ABCDEFGHIJKLMNOPQRSTUVWXYZ:;<=>
abcdefghijklmnopqrstuvwxyz?[\]|
SYN VOICE SEQ MIDI CTRL OTHER MSG
```

NOTE For more information or how to input characters, see page 79.

Appendix

Optional Boards/Memories

A variety of optional boards/memories sold separately let you expand the functions of your EX5/5R/7. The following five types of boards/memories can be used with the EX5/5R/7.

● EXIDO1 (Individual Output Board)

The EXIDO1 increases the number of assignable audio output jacks. The EX5/5R comes with four outputs, L/MONO, R, and Individual Output 1, 2. Installing the board which has four Individual Outputs 3 ~ 6 brings the total of outputs to eight. The EX7 with L/MONO and R stereo outputs along with the Individual Out 1 ~ 4 is capable of a total of six outputs.

● EXDGO1 (Digital Output Board)

The EXDGO1 after installation provides an AES/EBU digital out jack and a Word Clock In jack.

IMPORTANT The EXDGO1 and EXIDO1, two boards can not be installed at the same time.

● ASIB1 (SCSI Interface Board)

A SCSI connector can be installed in the EX5/5R/7. This lets you connect external SCSI devices, such as hard disk drives, ZIP, JAZZ disk drives and CD-ROM drives. External SCSI device operations are accomplished in the Disk mode.

● EXFLM1 (Flash Memory Board)

When the power is turned off, all the data in RAM is lost. However, Flash memory data is not volatile and remains recorded. When Flash memory is installed, just like ROM, the data can be used as soon as the system is turned on. In the EX5/5R/7, Flash memory (4MB × 2 = 8MB) can be used to store sample data. Also the data can be overwritten whenever you like.

IMPORTANT Take note that the EXFLM1 should always be used in pairs.

● DRAM SIMM

DRAM SIMM (Single In-line Memory Module) can be used as RAM for recording sample data. You need to use 72-pin DRAM SIMMs (4, 8, 16, 32MB) in pairs. It is possible to increase the 1MB of internal memory, a maximum of 64MB to a total of 65MB. (However, because the data is volatile, it is necessary to backup data to floppy disk or an external SCSI device.)

IMPORTANT Take note that DRAM SIMMs with the same memory capacity should always be used in pairs.

Precautions When Installing the Optional Boards

CAUTION Remember the following precautions and install the boards properly.

- To avoid using the wrong parts and making mistakes during installation, follow the steps as written.
- Before starting installation, be sure that you have a Phillips screwdriver at hand.
- All necessary screws are provided with the optional boards or are installed on the EX5/5R/7. Therefore do not use any screws other than what are installed on the EX5/5R/7 or come with the optional board. Screws that are not the correct size may cause damage or result in a malfunction.
- Be careful not to misplace any of the screws since all of them are used.
- The screw should secure the board so it is completely stable and does not move in any way.
- Handle the boards with care. Dropping or subjecting the board to any kind of shock may cause damage or result in a malfunction.
- When moving a cable, be careful not to let it catch on the circuit board. Forcing the cable in anyway may cut the cable, cause damage, or result in a malfunction.
- Do not touch the exposed metal parts in the circuit board. Touching these parts may result in a faulty contact.
- When connecting cables or directly inserting a board (DRAM SIMM for example), make sure that you check that they are connected or inserted properly. Improperly inserted cables and boards may cause faulty contacts and an electrical short circuit which may cause damage or result in a malfunction.
- Be careful of static electricity. There are times when static electricity affects the IC chips on the main board. Before you lift the optional board, to reduce the possibility of static electricity, touch the metal parts other than the painted area or a ground wire on the devices that are grounded.

Precautions When Purchasing DRAM SIMMs

Some of the commercially available DRAM SIMMs may not work on the EX5/5R/7. Yamaha cannot be held responsible for malfunction of DRAM SIMMs. BEFORE purchasing, please consult (which to buy) the shop where you bought EX5/5R/7 or your nearest Yamaha (or the authorized distributor) listed at the end of this manual.

Important Notices About DRAM SIMM Type/Configuration.

- You need to use 72-pin DRAM SIMMs (4, 8, 16, 32MB) with the same memory capacity in pairs.
- You need to use DRAM SIMMs with access time of 70ns or less.
- Both types, parity and non-parity types can be used. It is also possible to use the EDO type.
- DRAM SIMMs corresponding to ECC cannot be used.
- For the EX5/7 (keyboard), you need to use DRAM SIMM with its height less than 32mm.
- Yamaha recommends to select the DRAM SIMMs that meet the standard specification for internal configuration set by the JEDEC*. However, be aware that the recommendation does NOT always assure that the DRAM SIMMs operate with the EX5/5R/7.

* The JEDEC (Joint Electron Device Engineering Council) is a technical electronic device association. This association sets regulations for standard terminal configuration in electronic devices.

How to Install the Optional Board/Memory (EX5/7)

The installation method is different depending on the instrument types, EX5/7 keyboards and EIA sized module, EX5R. Both methods are explained separately on the following pages. Read the explanation carefully for the instrument that you will use. The board and cable to be used are described in the beginning of each installation procedure.

NOTE For information on how to handle the EX5R, go to page 285.

Preparation

On the EX5/7, there are two types of covers, one is for optional boards and the other is for memories. Remove the appropriate cover according to the board/memory that you will install.

How to Remove the Optional Board Cover (EXID01, EXDGO1, ASIB1)

- 1 Turn the EX power off, and disconnect the power cord.
- 2 Turn over the keyboard so you can have direct access to the underside. To protect the Knobs or Wheels, place the keyboard so the four corners are supported by something that provides sufficient support like magazines or cushions.

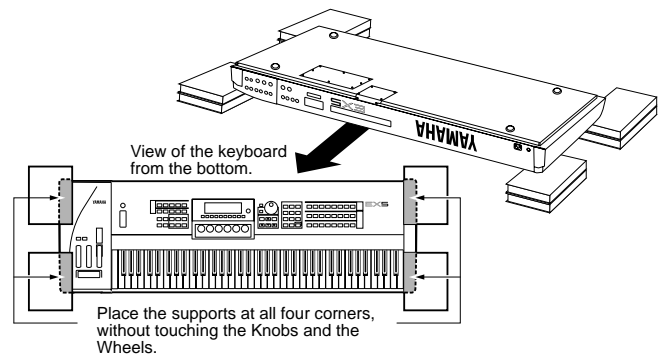

IMPORTANT Be careful not to drop or bump the keyboard and make sure that it is well balanced before proceeding.

- 3 Move to a position facing the rear panel of the EX5/7, and remove the screws from the optional board cover on the left side with a Phillips screwdriver (eight screws). Do not remove the large screw shown in the illustration.

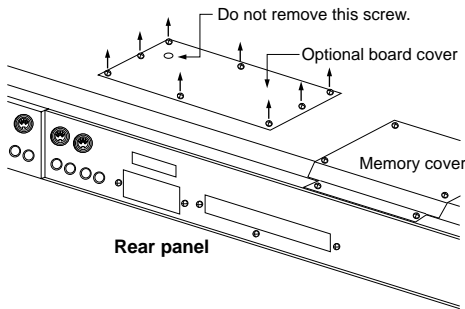

Remove the optional board cover and you will see the installation connectors.

How to Remove the Memory Cover (EXFLM1, DRAM SIMM)

Steps 1 and 2 are the same as those explained in removing the optional board cover.

- 3 Move to a position facing the rear panel of the EX5/7, and remove the screws from the memory cover on the right side with a Phillips screwdriver (six screws).

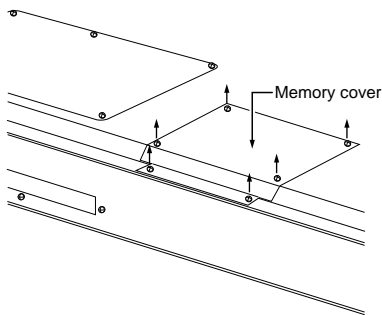

Remove the memory cover and you will see the installation sockets.

NOTE For information on how to handle the EX5R, see page 285.

How to Install the EXIDO1 in the EX5/7

Necessary Items

- EXIDO1 (Individual Output Board) × 1
- Flat cable × 1 (included in the EXIDO1 package)

Installation

You can install the EXIDO1 after removing the optional board cover. For more information on removing the optional board cover, see How to Remove the Optional Board Cover.

IMPORTANT If the ASIB1 (SCSI Interface Board) is already installed, it must first be removed before proceeding. If you want to install the two boards simultaneously, first install the EXIDO1.

CAUTION When installing the optional board (from when you remove the cover to when the cover is replaced securely) all operations must be done with the power cord disconnected.

- 1 Remove the two screws from the EXIDO1/EXDGO1 opening cover (hold the cover from inside the EX5/7 as you remove the cover). The two screws will be used again when securing the EXIDO1. Be careful not to lose them.

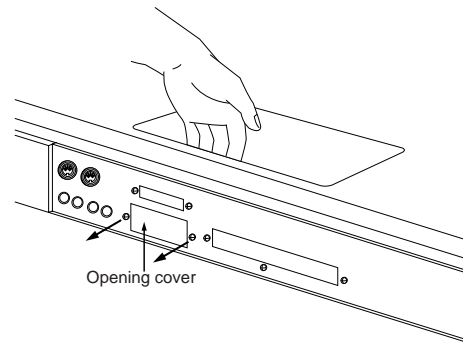

NOTE After you take off the cover, do not leave it inside the EX5/7 and put it in a safe place.

- 2 Remove the EXIDO1/EXDGO1 power cable (1 red and 4 white, 5 pin cable) from the hook-shaped bundle tie in the EX5/7. Make sure not to catch the cable on any other cables or the circuit board while removing it from the hook-shaped bundle tie and set it aside. Place the remaining cable back into the bundle tie.

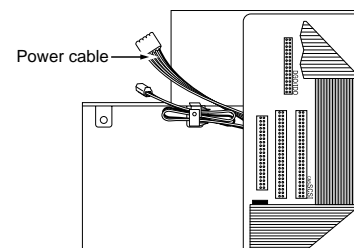

- 3 Support the EXIDO1 with your hand and use the two screws removed in step 1 to attach the board to the rear panel of the EX5/7.

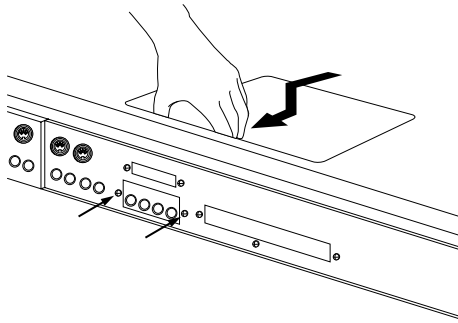

- 4 Use the two screws that are attached to the EXIDO1 to attach the board to the EX5/7 metal fitting.

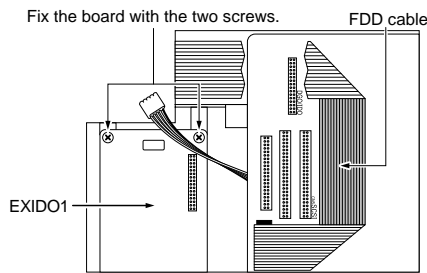

- 5 Connect the EXIDO1/EXDGO1 power cable that was set aside in step 2 to the EXIDO1 connector. Be careful not to connect the connector in the wrong direction.

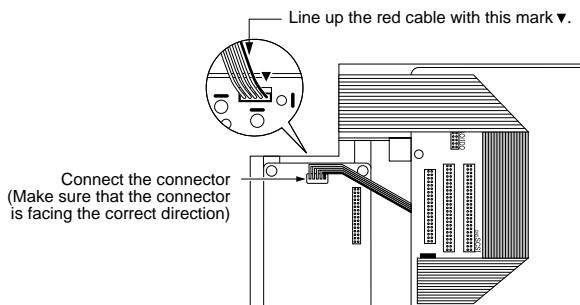

- 6 As shown in the diagram, bend the flat cable to the specified dimensions.

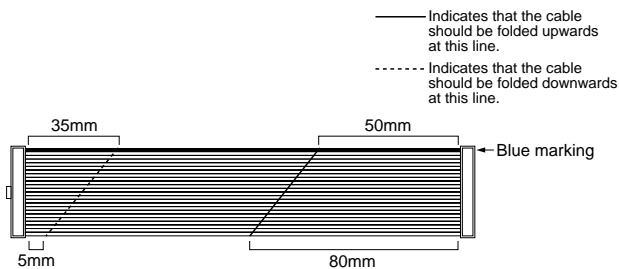

- 7 Check the location of the DGO/IDO connector in the EX5/7 and connect the EXIDO1 and EX5/7 with the flat cable. The DGO/IDO connector is hidden under the FDD cable. "DGO/IDO" is printed on the panel.

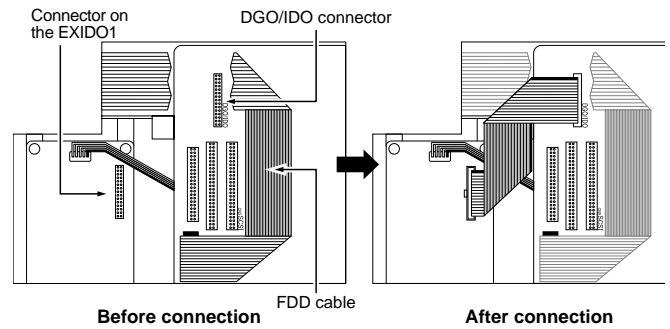

- NOTE** When you lift up the FDD cable to connect the flat cable to the DGO/IDO connector, the FDD cable may inadvertently be pulled out of the connector. Make sure that the FDD cable is securely connected after connecting the optional board.

- 8 Replace the optional board cover by following the steps for removal in the opposite order.

- NOTE** The Individual Output jacks to be added are numbered as follows.
- EX5: INDIVIDUAL OUTPUT 3 ~ 6
 - EX7: INDIVIDUAL OUTPUT 1 ~ 4

- NOTE** For information on Individual Output settings, see page 19.

How to Install the EXDGO1 in the EX5/7

Necessary Items

- EXDGO1 (Digital Output Board) × 1
- Flat cable × 1 (included in the EXDGO1 package)

Installation

You can install the EXDGO1 after removing the optional board cover. For more information on removing the optional board cover, see How to Remove the Optional Board Cover.

IMPORTANT If the ASIB1 (SCSI Interface Board) is already installed, it must first be removed before proceeding. If you want to install the two boards simultaneously, first install the EXDGO1.

CAUTION When installing the optional board (from when you remove the cover to when the cover is replaced securely) all operations must be done with the power cord disconnected.

The procedure for installing the EXDGO1 is the same as for the EXIDO1. Refer to How to Install the EXIDO1 in the EX5/7.

NOTE For information on Word Clock settings, see Utility mode (page 277).

When the EXDGO1 is properly installed, L and R signals will be output digitally.

NOTE When connecting the EXDGO1 (Digital Output AES/EBU [XLR] jack) and an external audio device, use the XLR cable with the impedance characteristics, 110Ω

NOTE When receiving word clock from an external audio device, you are required to connect the EXDGO1 (Word Clock In [BNC] jack) and the external audio device. In this case, use the BNC connector/coaxial cable with the impedance characteristics, 75Ω

How to Install the ASIB1 in the EX5/7

Necessary Items

- ASIB1 (SCSI Interface Board) × 1
- SCSI cable (Flat cable 50P; length: 280mm) × 1 (included in the ASIB1 package)
- Cutting pliers or scissors (to cut a cable)

IMPORTANT When you open the package of the ASIB1 board, you will find two SCSI cables connected to the ASIB1, and two (2-pin) power cables, one is plugged to the ASIB1 and the other is left unplugged. To install the ASIB1 into the EX, only the short (280mm long) SCSI cable is used. First, it is necessary to remove the long (480mm long) SCSI cable and 2-pin power cable from the ASIB1 board.

Installation

You can install the ASIB1 after removing the optional board cover. For more information on removing the optional board cover, see How to Remove the Optional Board Cover.

IMPORTANT When two boards are installed simultaneously such as the ASIB1 and EXIDO1 (or EXDGO1), first install the EXIDO1 (or EXDGO1).

CAUTION When installing the optional board (from when you remove the cover to when the cover is replaced securely) all operations must be done with the power cord disconnected.

- 1 Remove the two screws from the ASIB1 opening cover (hold the cover from inside the EX5/7 as you remove the cover). The two screws will be used again when securing the ASIB1. Be careful not to lose them.

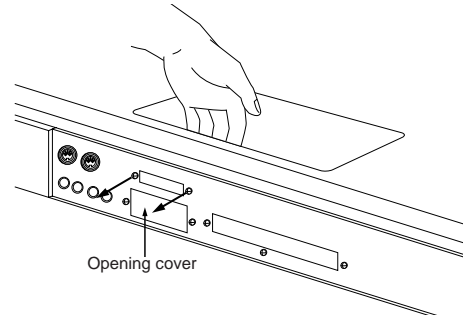

NOTE After you take off the cover, do not leave it inside the EX5/7 and put it in a safe place.

- 2 Disconnect the long (480mm long) SCSI cable from the connector (CN1) on the ASIB1 board.

- 3 Unplug the 2-pin power cable from the ASIB1 and remove it from the ASIB1. To remove the 2-pin power cable, cut the cable and then pull it out from the hoop as shown in the illustration.

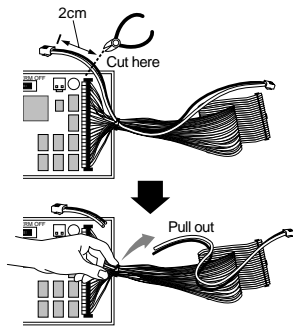

- 4 Remove the ASIB1 power cable (1 red and 1 white, 2 pin cable) from the hook-shaped bundle tie in the EX5/7. Make sure not to catch the cable on any other cables or the circuit board while removing it from the hook-shaped bundle tie and set it aside. Place the remaining cable back into the bundle tie.

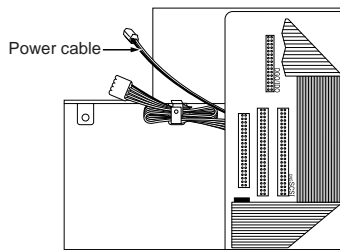

- 5 Set the TERM switch (Terminator) to ON on the ASIB1 board.

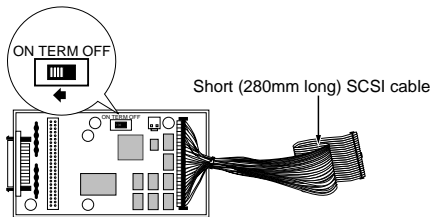

- 6 Connect the ASIB1 power cable that was set aside in step 4 to the CN2 connector (next to the TERM switch) on the ASIB1. Be careful not to connect the connector in the wrong direction.

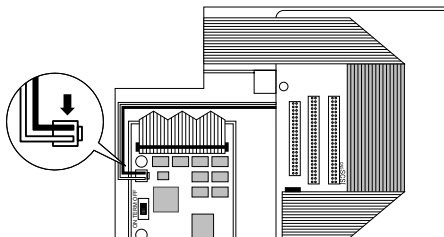

- 7 Check the location of the SCSI connector in the EX5/7 (shown in the illustration) and connect the ASIB1 and the EX5/7 with the SCSI cable. "SCSI" is printed on the panel next to the SCSI connector.

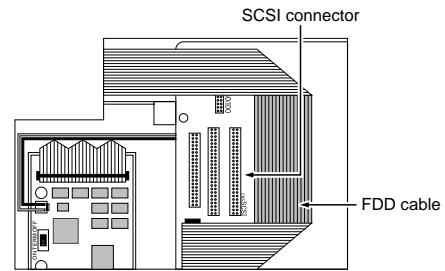

- 8 Support the ASIB1 with your hand and use the two screws removed in step 1 to attach the board to the rear panel of the keyboard.

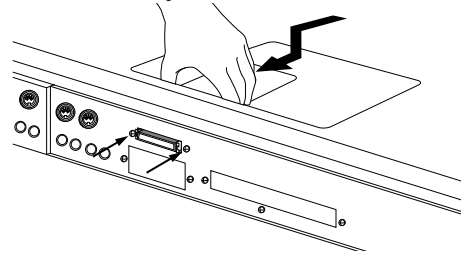

- 9 Arrange the SCSI cable so it sits in between the ASIB1 and the panel.

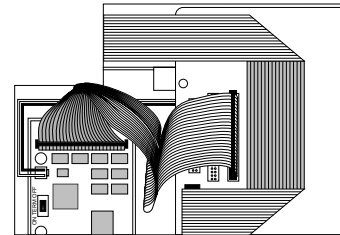

- 10 Replace the optional board cover by following the steps for removal in the opposite order.

NOTE For information on SCSI ID settings, see the Utility mode (page 276).

How to Install the EXFLM1/ DRAM SIMM in the EX5/7

Necessary Items

- EXFLM1 × 2 (use only in pairs)
or
- DRAM SIMM × 2 (use only in pairs)

NOTE Make sure always use the EXFLMs in pairs, also always use the DRAM SIMMs with the same memory capacity in pairs.

Installation

You can install the EXFLM1 and DRAM SIMM after removing the memory cover. For more information on removing the memory cover, see How to Remove the Memory Cover.

CAUTION When installing the memory board (from when you remove the cover to when the cover is replaced securely) all operations must be done with the power cord disconnected.

- 1 Check the location of the memory slots. When facing the rear panel of the EX5/7, on the back of the board in the EX5/7, the two rows (to the right of the sockets “EXFLM1” is printed) are the EXFLM1 sockets. The two rows (to the right of the sockets “DRAM” is printed) before the EXFLM1 are the DRAM SIMM sockets.

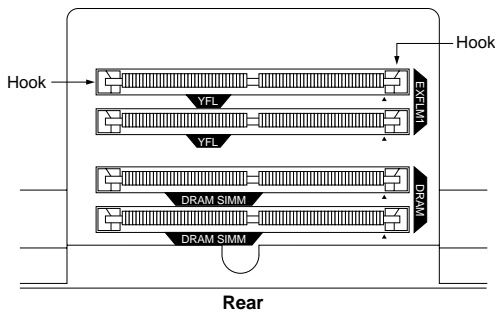

- 2 On the EXFLM1 and the DRAM SIMM memory there is a cut in the board next to 1PIN. Insert the board into the socket so that 1PIN lines up with the 1PIN mark (▲) printed on the board in the EX5/7.

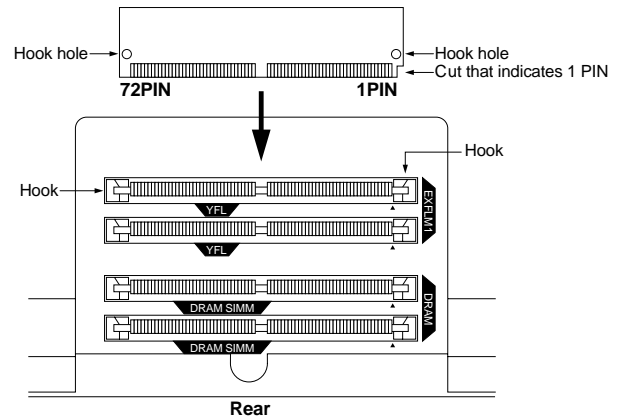

IMPORTANT The sockets for the EXFLM1 and DRAM SIMM look the same. Be careful not to insert the memory into the wrong socket.

- 3 Install the EXFLM1 or DRAM SIMM by inserting the first board into the socket closest to you. Set the EXFLM1 or DRAM SIMM completely into the socket at an angle shown in the illustration. Then push in the direction shown below so that it becomes upright and the hook snaps into place. Repeat this step for the second board.

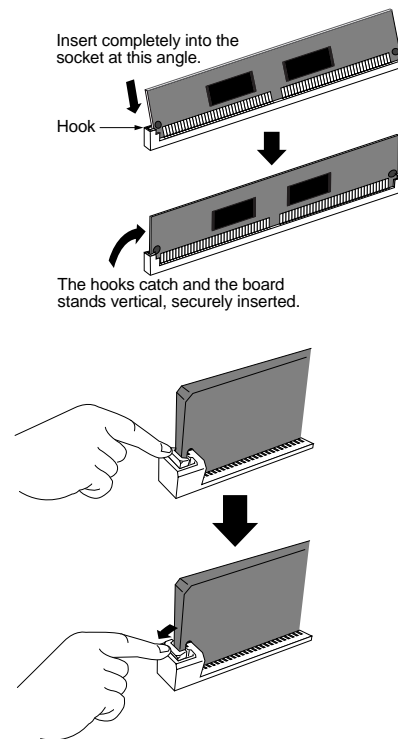

- 4 Replace the memory cover by following the steps for removal in the opposite order.

NOTE To remove a EXFLM1 or DRAM SIMM from a socket, hold open the two hooks on the socket (one at each end) and push on the EXFLM1 or DRAM SIMM so that it is released from the hooks and becomes slanting, and then pull the EXFLM1 or DRAM SIMM out.

How to Install the Optional Board/Memory (EX5R)

Preparation

On the EX5R, remove the main unit top cover for all optional board/memory installations.

NOTE For information on how to handle the EX5/7, go to page 279.

How to Remove the EX5R Top Cover

- 1 Turn the EX power off, and disconnect the power cord.
- 2 Turn over the main unit and remove the six screws on the left and right sides that secure the EX5R top cover.

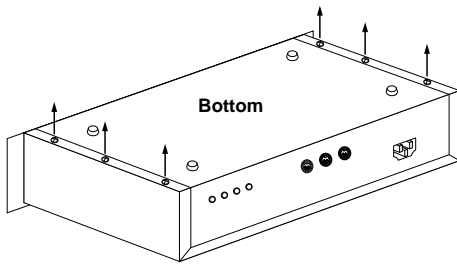

IMPORTANT Do not remove the other screws.

- 3 Return the unit to its original upright position and remove the four screws on the top surface located at the front of the unit and also the seven screws located on the rear.

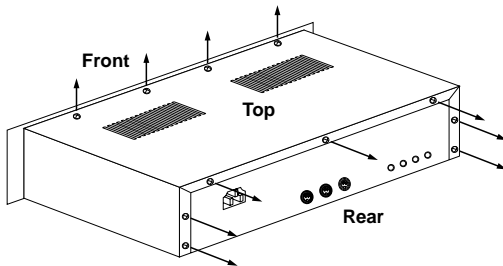

- 4 Remove the EX5R top cover by sliding the cover in a backwards direction and you will see the installation connectors/sockets.

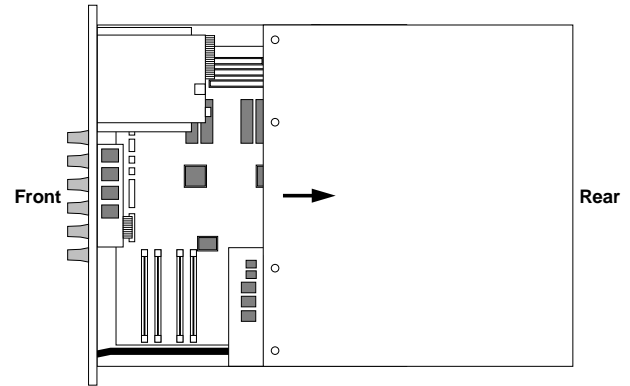

How to Replace the EX5R Top Cover

Replace the top cover by following the steps for removal in the opposite order (First replace the seven rear screws, next the four top screws, and then the bottom six screws).

NOTE For information on how to handle the EX5/7, see page 279.

How to Install the EXIDO1 in the EX5R

Necessary Items

- EXIDO1 (Individual Output Board) × 1
- Flat cable × 1 (included in the EXIDO1 package)

Installation

You can install the EXIDO1 after removing the main unit top cover. For more information on removing the main unit top cover, see above.

CAUTION When installing the optional board (from when you remove the EX5R top cover to when the cover is replaced securely) all operations must be done with the power cord disconnected.

- 1 Remove the two screws from the EXIDO1/EXDGO1 opening cover (hold the cover from inside the EX5R as you remove the cover). The two screws will be used again when securing the EXIDO1. Be careful not to lose them.

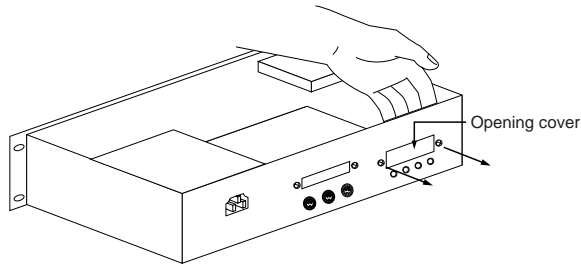

NOTE After you take off the cover, do not leave it inside the EX5R and put it in a safe place.

- 2 Remove the EXIDO1/EXDGO1 power cable (1 red and 4 white, 5 pin cable) from the hook-shaped bundle tie in the EX5R. Make sure not to catch the cable on any other cables or the circuit board while removing it from the hook-shaped bundle tie and set it aside. Place the remaining cable back into the bundle tie.

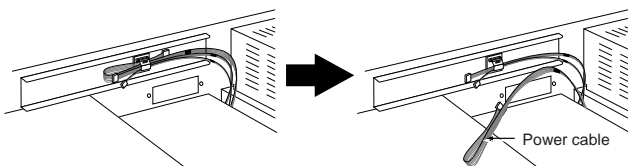

- 3 As shown in the diagram, bend the flat cable to the specified dimensions.

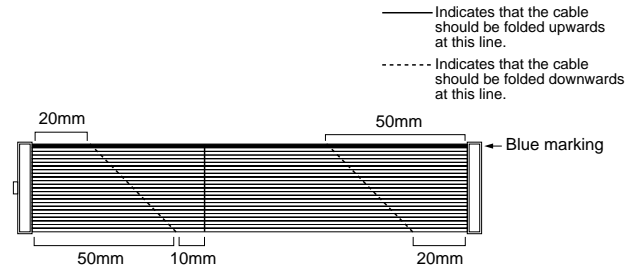

- 4 Connect the flat cable to the EXIDO1.

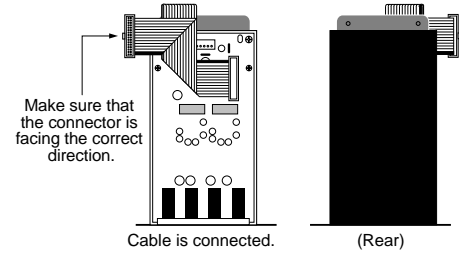

- 5 Connect the EXIDO1/EXDGO1 power cable that was set aside in step 2 to the EXIDO1 connector. Be careful not to connect the connector in the wrong direction.

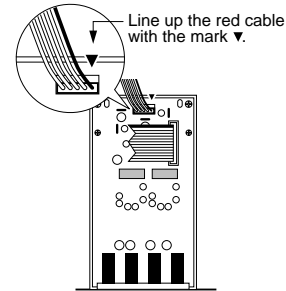

- 6 Check the location of the DGO/IDO connector in the EX5R and connect the EXIDO1 and the EX5R with the flat cable. When facing the rear panel, the DGO/IDO connector is on the right side as shown in the illustration. "DGO/IDO" is printed on the panel.

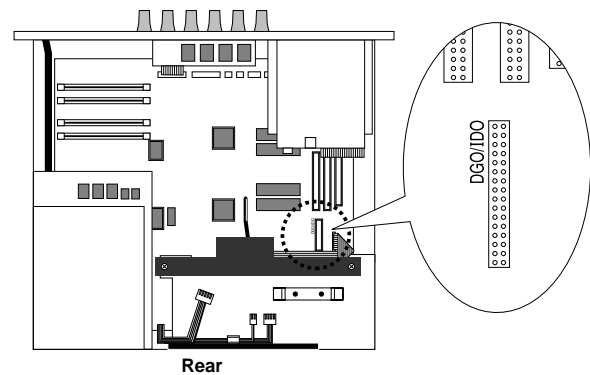

- 7 Turn over the EXIDO1 and place face down into the support arms.

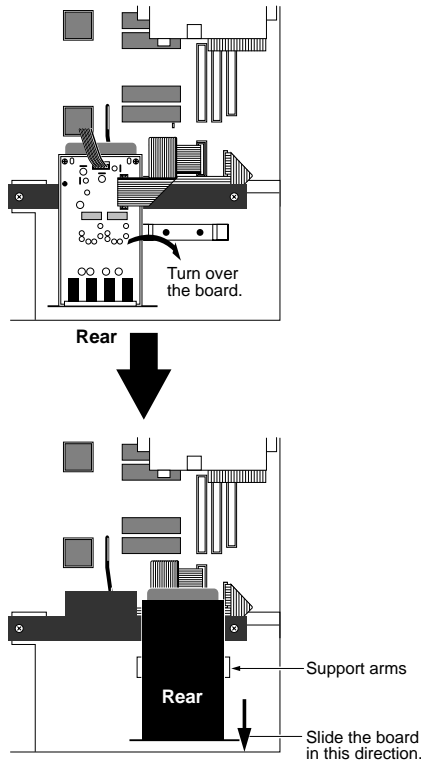

IMPORTANT The EXIDO1 and the EXDGO is installed in the EX5R upside down (with the board facing down). If installed underside down, the output jack numbers will not match the Individual Out settings.

- 8 Slide the EXIDO1 towards the rear panel of the EX5R and use the two screws removed in step 1 to attach the board to the rear panel.

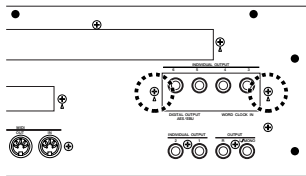

- 9 Replace the EX5R top cover. See How to Replace the EX5R Top Cover on page 285.

NOTE For information on Individual Output settings, see page 19.

How to Install the EXDGO1 (Digital Output Board) in the EX5R

Necessary Items

- EXDGO1 (Digital Output Board) × 1
- Flat cable × 1 (included in the EXDGO1 package)

Installation

You can install the EXDGO1 after removing the EX5R top cover. For more information on removing the EX5R top cover, see How to Remove the EX5R Top Cover.

CAUTION When installing the optional board (from when you remove the top cover to when the top cover is replaced securely) all operations must be done with the power cord disconnected.

The procedure for installing the EXDGO1 is the same as for the EXIDO1. See How to Install the EXIDO1 in the EX5R.

Only the points that are different from the EXIDO1 will be explained.

NOTE Same as the EXIDO1, the EXDGO1 is installed face down.

NOTE For information on Word Clock settings, see Utility mode (page 277).

When the EXDGO1 is properly installed, L and R signals will be output digitally.

NOTE When connecting the EXDGO1 (Digital Output AES/EBU [XLR] jack) and an external audio device, use the XLR cable with the impedance characteristics, 110Ω

NOTE When receiving word clock from an external audio device, you are required to connect the EXDGO1 (Word Clock In [BNC] jack) and the external audio device. In this case, use the BNC connector/coaxial cable with the impedance characteristics, 75Ω

How to Install the ASIB1 (SCSI Interface Board) in the EX5R

Necessary Items

- ASIB1 (SCSI Interface Board) × 1
- SCSI cable (Flat cable 50P; length: 280mm) × 1 (included in the ASIB1 package)
- Cutting pliers or scissors (to cut a cable)

IMPORTANT When you open the package of the ASIB1 board, you will find two SCSI cables connected to the ASIB1, and two (2-pin) power cables, one is plugged to the ASIB1 and the other is left unplugged. To install the ASIB1 into the EX, only the short (280mm long) SCSI cable is used. First, it is necessary to remove the long (480mm long) SCSI cable and 2-pin power cable from the ASIB1 board.

Installation

You can install the ASIB1 after removing the EX5R top cover. For more information on removing the EX5R top cover, see How to Remove the EX5R Top Cover.

CAUTION When installing the optional board (from when you remove the top cover to when the top cover is replaced securely) all operations must be done with the power cord disconnected.

- 1 Remove the two screws from the ASIB1 opening cover (hold the cover from inside the EX5R as you remove the cover). The two screws will be used again when securing the ASIB1. Be careful not to lose them.

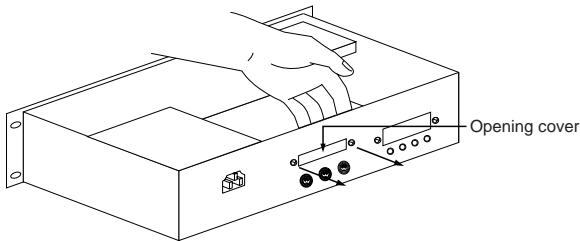

NOTE After you take off the cover, do not leave it inside the EX5R and put it in a safe place.

- 2 Disconnect the long (480mm long) SCSI cable from the connector (CN1) on the ASIB1 board.

- 3 Unplug the 2-pin power cable from the ASIB1 and remove it from the ASIB1. To remove the 2-pin power cable, cut the cable and then pull it out from the hoop as shown in the illustration.

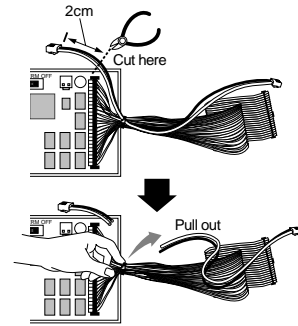

- 4 Remove the ASIB1 power cable (1 red and 1 white, 2 pin cable) from the hook-shaped bundle tie in the EX5R. Make sure not to catch the cable on any other cables or the circuit board while removing it from the hook-shaped bundle tie and set it aside. Place the remaining cable back into the bundle tie.

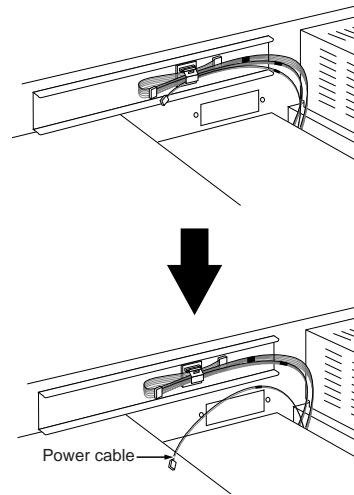

- 5 Set the TERM switch (Terminator) to ON on the ASIB1 board.

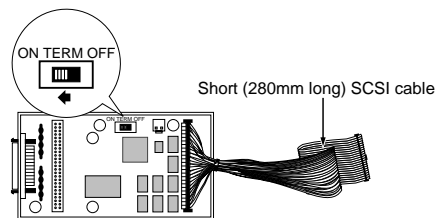

- 6 Connect the ASIB1 power cable that was set aside in step 4 to the CN2 connector (next to the TERM switch) on the ASIB1. Be careful not to connect the connector in the wrong direction.

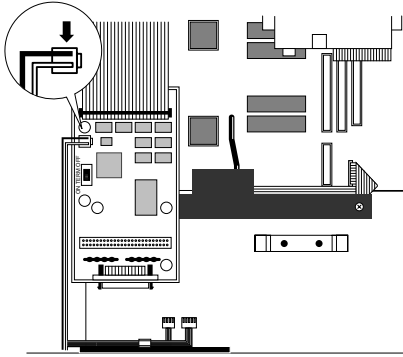

- 7 Check the location of the SCSI connector in the EX5R (shown in the illustration), and connect the ASIB1 and the EX5R with the SCSI cable. "SCSI" is printed on the panel next to the SCSI connector.

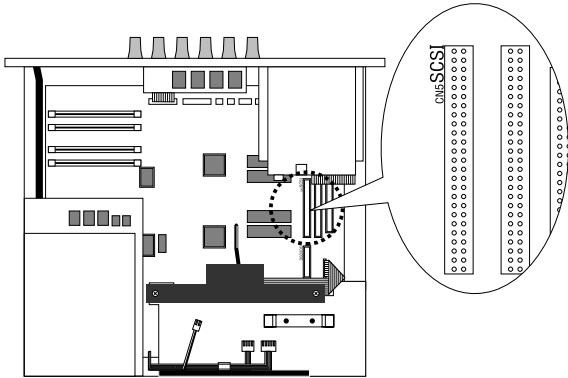

- 8 Support the ASB1 with your hand and use the two screws removed in step 1 to attach the board to the rear panel of the EX5R.

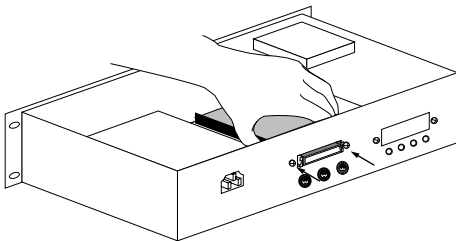

- 9 Use the bundle tie next to the ASIB1 to bundle the cables together.

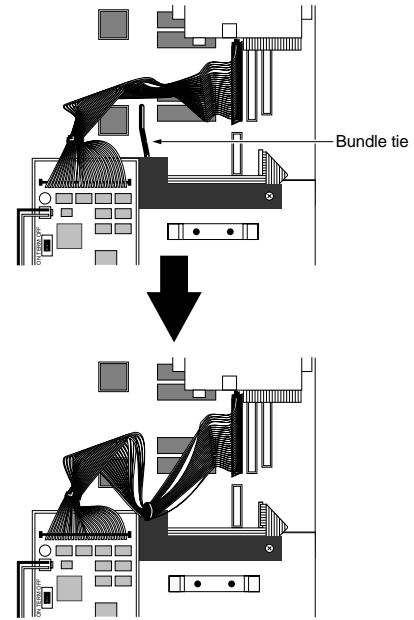

- 10 Replace the EX5R top cover. See How to Replace the EX5R Top Cover.

NOTE For information on SCSI ID settings, see the Utility mode (page 276).

How to Install the EXFLM1 / DRAM SIMM in the EX5R

Necessary Items

- EXFLM1 × 2 (use only in pairs)
- or
- DRAM SIMM × 2 (use only in pairs)

IMPORTANT Make sure always use the EXFLMs in pairs, also always use the DRAM SIMMs with the same memory capacity in pairs.

Installation

You can install the EXFLM1 and DRAM SIMM after removing the EX5R top cover. For more information on removing the EX5R top cover, see How to Remove the EX5R Top Cover.

CAUTION When installing the memory board (from when you remove the top cover to when the top cover is replaced securely) all operations must be done with the power cord disconnected.

- 1 Check the location of the memory slots. When facing the rear panel of the EX5R, the DRAM SIMM two rows (to the left of the sockets DRAM is printed) are on the back of the board on the far left side of the EX5R. The two rows in front of the DRAM SIMM rows (to the left of the sockets EXFLM1 is printed) are the EXFLM1 sockets.

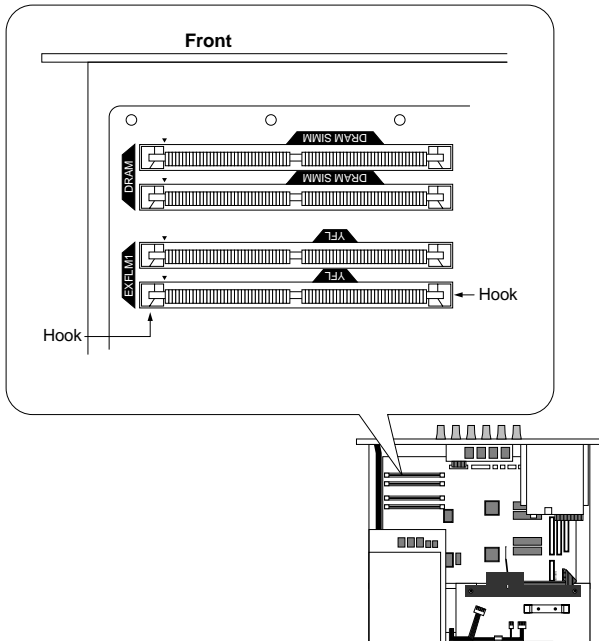

- 2 On the EXFLM1 and the DRAM SIMM memory there is a cut in the board next to 1PIN. Insert the board into the socket so that 1PIN lines up with the 1PIN mark (▲) printed on the board in the EX5R.

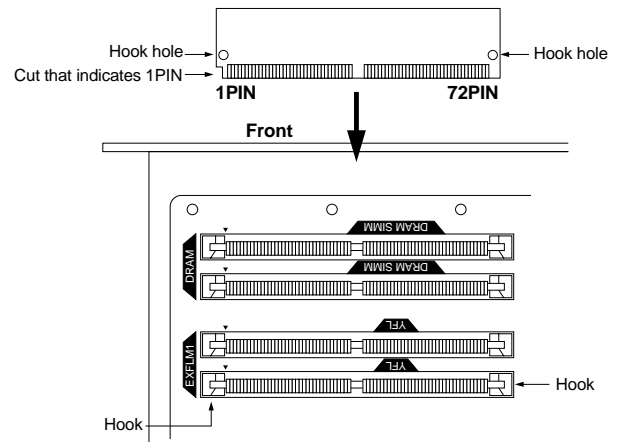

IMPORTANT The sockets for the EXFLM1 and DRAM SIMM look the same. Be careful not insert the memory into the wrong socket.

- 3 Install the EXFLM1 or DRAM SIMM by inserting the first board in the socket farthest from you. Set the EXFLM1 or DRAM SIMM into the socket at an angle shown in the illustration. Then push in the direction shown below so that it becomes upright and the hook snaps into place. Repeat this step for the second board.

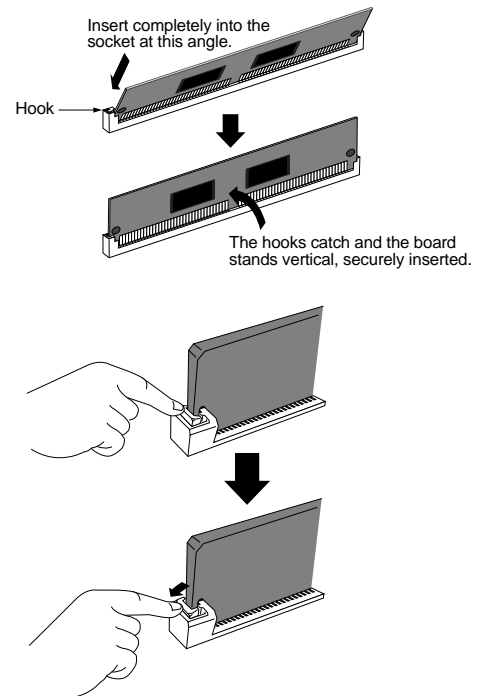

- 4 Replace the EX5R top cover. See How to Replace the EX5R Top Cover.

NOTE To remove a EXFLM1 or DRAM SIMM from a socket, hold open the two hooks on the socket (one at each end) and push on the EXFLM1 or DRAM SIMM so that it is released from the hooks and becomes slanting, and then pull the EXFLM1 or DRAM SIMM out.

Troubleshooting

The following table provides troubleshooting hints and page references for some common problems. Most problems may be simply the result of incorrect settings. Before calling for professional service, refer to the troubleshooting advice below to see if you can find and correct the cause of the problem.

No sound.

- Is the volume set appropriately? (P. 9)
- (On EX5/7) When the Foot Controller is connected to the FOOT VOLUME jack, is the Foot Volume pressed down? (P. 17)
- Is the Volume parameter in PARAM, COM menu (Voice Edit) set appropriately? (P. 77)
- Is the Level parameter in PARAM, AMP menu (Voice Edit) set appropriately? (P. 96)
- Is the Level parameter in MIX, OSC menu (Voice Edit) set appropriately? (P. 81)
- Is the note range/velocity (note) range in ZONE, OSC menu (Voice Edit) set appropriately? (P. 82)
- Isn't each element muted? (P. 77)
- Filters set for each element may inadvertently cut almost all the sound? (P. 86)
- (AN elements) Is the PulseWidth parameter in VCO, OSC menu (Voice Edit) set appropriately? (P. 116)
- Are the effect settings appropriate? (P. 105)
- Are the MIDI receive channels set appropriately? (P. 165, 271)
- Is the audio equipment connected appropriately? (P. 18)
- Isn't Local set to off? (P. 275)
- Are the settings, Velocity Sensitivity, Note Limit and Velocity Limit appropriate? (P. 166, 82)
- (When playing back a song using the internal sequencer or an external MIDI device,) are the volume and expression settings for the song data appropriate?
- (When playing performances using the internal sequencer or an external MIDI device,) Are the MIDI settings, transmit channels of each sequencer track and receive channels of each part of the performance, set appropriately? (P. 171)
- (Performance) Is the volume of each part set enough? (P. 167)
- (Performance) Is the Output Select of each part set appropriately? (P. 167)

No arpeggiator sound.

- Is each part of the arpeggiator muted? (P. 239)
- Are the settings, Velocity Sensitivity and Velocity Limit appropriate? (P. 166)
- Is the note range for the arpeggiator set appropriately? (P. 161)
- (User arpeggio) Are the sequence data properly recorded? (P. 245)
- (Performance mode) Are the Layer Switch and Arpeggio Switch for the part(s) turned on? (P. 171)

Distorted sounds.

- Are the effect settings appropriate? (P. 105)
- Is the volume level set too loud? (P. 79, 96)
- (AN elements) Are the FM parameter and Sync parameter in ALG, OSC menu (Voice Edit) set too high? (P. 114)
- (AN elements) Is the Feedback Level in MIX, AMP menu (Voice Edit) set too high? (P. 120)

Small sounds.

- Is the MIDI volume or MIDI expression set too low?
- Are the Velocity Sens/Offset in the Voice Mode Setup (Utility mode) set too low? (P. 271)
- Is the cutoff frequency of the filters set too high/low? (P. 110, 118)

Wrong pitch.

- Is the Master Tune in the Synthesizer Setup (Utility mode) set appropriately? (P. 270)
- Are the pitch related parameters in PARAM, PITCH menu (Voice Edit) set appropriately? (P. 83)
- Is the appropriate tuning system selected from Micro Tuning parameter in SCALE, PITCH menu (Voice Edit)? (P. 84)
- (AN elements) Is the Sync Pitch parameter in ALG, OSC menu (Voice Edit) set appropriately? (P. 114)
- Is the Pitch Modulation Depth in LFO1, LFO menu (Voice Edit) set too high? (P. 102)
- (Performance) Is the Note Shift for each part in LYR (Layer) set to a value other than 0? (P. 171)
- (Performance) Is the Detune for each part in MIX set to a value other than 0? (P. 171)

Sound is choppy and interrupted.

- Do the total number of notes required to the data exceed the maximum polyphony? (P. 78)
- (User arpeggio) Are the velocity and play effects for the arpeggio set appropriately? (P. 239)

Only one note sounds at a time.

- Is the “mono” selected from Mono/Poly parameter in PARAM, COM menu (Voice Edit)? (P. 79)
- (Performance) Is the "mono" selected from Mono/Poly parameter of each part? (P. 165)

No effect applied.

- Is [EF BYPASS] key turned off? (P. 10)
- Is the InsEF Elem Sw in TYPE, EFCT menu turned on? Also, is the effect type other than 00 (thru) selected for each effect type in TYPE, EFCT menu?(P. 105)
- (Performance) Is the InsEF Elem Sw for each part turned off? Also, is the effect type other than 00 (thru) selected for each effect type in EFCT, COM menu?(P. 165)

LCD Messages

	Messages	Information
1	MIDI buffer full!	Failed to process the MIDI data because too much data is received at one time.
2	Memory full!	Remaining memory of the internal sequencer has been consumed.
3	MIDI data error!	An error occurred when receiving MIDI data.
4	MIDI checksum err!	An error occurred when receiving bulk data.
5	Change internal battery!	The internal backup battery has been consumed. Replace the battery.
6	Data empty!	Sequence data (bulk) has been received, but it contains no data.
7	Illegal data!	Wrong MIDI data was received.
8	Please turn off keymap&arp!	Can't select a mode. Turn the Keymap/Arpeggiator off.
9	Please turn off keymap!	Can't select a mode. Turn the Keymap off.
10	MIDI bulk received!	MIDI bulk data has been received.
11	MIDI bulk receiving!	EX is receiving MIDI bulk data.
12	Preset data!	Can't edit the data because it is a preset data.
13	SCSI error!	SCSI ID is not properly set.
14	Disk full!	There is no more memory available on the disk.
15	File not found!	Can't find the specified type of file.
16	Bad disk!	The disk is faulty.
17	Disk not ready!	The disk has not been inserted.
18	Disk unformatted!	The disk has not been properly formatted.
19	Write protected!	The disk is write protected.
20	Illegal disk!	The format type of the disk is wrong.
21	Already file exist!	The file with the same name already exists.
22	Illegal file!	The file data is faulty.
23	Can't make directory!	Can't make more than two directory levels.
24	Unknown file format!	The file format type is not for EX.
25	SMF illegal timebase!	The timebase of the designated SMF file is wrong.
26	Can't set VL control!	VL controller set cannot be created since the controller sets are full.
27	Can't undo. OK?	It is not possible to execute the undo operation.
28	Device number is off!	Bulk data cannot be transmitted/received since the device number is off.
29	Device number mismatch!	Bulk data cannot be transmitted/received since the device numbers don't match.
30	MIDI bulk transmitting!	EX is transmitting MIDI bulk data.
31	SMDI canceled!	Wave Editor has been canceled.
32	SMDI sample received!	EX has received sample data from Wave Editor.
33	SMDI sample receiving!	EX is receiving sample data from Wave Editor.
34	SMDI sample transmitting!	EX is transmitting sample data to Wave Editor.
35	Too many wave layers!	The number of wave layers are full.
36	Flash memory full!	There is no more memory available on the Flash Memory Board.
37	Sample memory full!	There is no more memory available on the sample (D)RAM.
38	Too many waveforms!	The number of waves are full.
39	Too many samples!	The number of samples are full.
40	DSP resource full!	DSP has been occupied by another use.
41	Element memory full!	The number of elements are full.
42	EL mute - Number Sw [1]..[4]	To mute the elements, press an appropriate number key while holding [SHIFT] key.
43	Press SCENE Sw to store...	To store the scene, press [SCENE] key while holding [STORE] key.
44	Completed!	Displayed when EX has completed an operation.
45	Executing...	Displayed during executing a command.
46	Now working...	Displayed when EX is working using the disk, etc.
47	Now recording...	Displayed during sample recording.
48	Waiting...	Displayed when EX is ready to record a sample.
49	Processing data.	Displayed during processing a sample.
50	Now changing...	Displayed when the disk drive is changed to another.
51	Now playing...	Displayed during playback using the Direct Play function.
52	Too many layers!	More than two layer switches cannot be turned on at one time.

Specifications

		EX5	EX5R	EX7
KEYBOARD	Number of Keys	76	--	61
	Touch	Velocity sensitive, Aftertouch	--	Velocity sensitive, Aftertouch
TONE GENERATION SYSTEM	Tone Generators	AWM2, VL, AN, FDSP; Sampling (44.1kHz)		AWM2, AN, FDSP; Sampling (44.1kHz)
	Polyphony	128		64
VOICE	Voice Types	AWM, VL+AWM, FDSP, AN+AWM (Poly/Layer), AN+FDSP, Drum		AWM, FDSP, AN+AWM, Drum
	Number of Voices	512 (256 Presets, 256Internals[Users]) *Up to 4 elements for each Normal voice / up to 128 elements for Drum voice		
	Modes	Voice Play, Voice Edit, Voice Store, Voice Job		
WAVE	Preset	16MByte		
	User	1MB DRAM *Optionally expanded up to 73MB (64MB SIMM + 8MB Flash Memory)		
	Modes	Wave Edit, Wave Job		
PERFORMANCE	Multi-Timbres	16		
	Number of Performances	128		
	Modes	Performance Play, Performance Edit, Performance Store, Performance Job		
SAMPLE	Sampling	16 bits linear, 44.1KHz		
	Modes	Sample Play, Sample Record, Sample Edit, Sample Job		
EFFECT	Reverb	12		
	Chorus	17		
	Insertion	79		
SCENE	Scene 1, 2, Scene Control, Scene Store			
SONG	Tracks	16 sequence tracks, Pattern, Play Effects, Tempo		
	Note Resolution	1/480 of a quarter note		
	MIDI Sync	Internal, MIDI Clock, MTC		
	Capacity	ca. 30,000 notes		
	Format	Song (Load/Save), SMF Format 0 (Load/Save), SMF Format 1 and ESEQ (Load)		
	Recording Modes	Multi, Overdub, Replace, Punch In, Step		
	Modes	Song Play (Play Effects), Song Record, Song Edit, Song Job		
PATTERN	Tracks	8		
	Number of Patterns	50		
	Recording Modes	Multi, Overdub, Replace, Step		
	Modes	Pattern Play, Pattern Record, Pattern Edit, Pattern Job		
ARPEGGIATOR	Tracks	4		
	Number of Arpeggios	50 Presets, 50 Users		
	Recording Modes	Overdub, Replace, Step		
	Modes	Arpeggio Play, Arpeggio Record, Arpeggio Edit, Arpeggio Job		
KEYMAP	128 assignable keys with Samples and Tracks (1 or all)			
DISK	File Types	All Data, Synth All, Voice, Wave, SMF, Song, Pattern, Arpeggio		
	Functions	Save, Load, Rename, Delete, Make Directory, Format, Device Select		
	Others	Direct Play, Auto Load * The following files can be loaded (not saved): SMF Format 1 and ESEQ, AKAI, AIFF and WAV		
UTILITY	Synthesizer Setup, Voice Mode Setup, Sequencer Setup, MIDI Setup, Controller Setup, Other Setup			
CONTROLS	Octave Up/Down(EX5/7), Pitch(EX5/7), Modulation 1,2(EX5/7), Ribbon Controller(EX5/7), Floppy Disk Drive, Scene1,2, A/D Gain, Volume, 10 Mode keys, Arpeggio, Knob Mode, Keymap, EF Bypass, 6 Sequencer keys, Shift, F1 -F8, Exit, 6 Knobs, Cursor/Data, Data dial, Cancel, Inc/Yes, Dec/No, Cursors, Numeric keypad, Enter, 8 Bank keys(EX5/7), 16 Program/Part/Track keys(EX5/7), Power			
CONNECTORS & TERMINALS	Individual Output 1,2(EX5/5R), A/D Input L/Mono R(EX5/5R), A/D Input(EX7), Footswitch(EX5/7), Sustain(EX5/7), Foot Controller(EX5/7), Foot Volume(EX5/7), Output L/Mono R, Phones,Breath, MIDI In, Out, Thru, MIDI B In, Out(EX5), 2 slots for optional boards, AC Inlet * Input/output jacks are phone types.			
DISPLAY	64 x 240 (Backlit) with Contrast knob			
INCLUDED ACCESSORIES	Owner's Manual, Data List, 4 Demonstration disks (Demonstration songs and Factory Set files), AC Power Cord			
OPTIONAL ACCESSORIES	EXIDO1 Individual Output Board, EXDGO1 Digital Output Board, ASIB1 SCSI Interface Board, EXFLM1 Flash Memory, DRAM SIMM, FC 4/5 Footswitch, FC 7 Foot Controller, BC 3 Breath Controller			
POWER CONSUMPTION	32 watts		30 watts	
OUTPUT IMPEDANCE	Output: +18 dBm (10 k ohms), Phones: +12 dBm (33 ohms)			
DIMENSIONS	1268(W) x 407(D) x 129(H) mm (49 1/8" x 16" x 5 1/12")	480(W) x 397(D) x 138(H) (18 7/8" x 15 2/3" x 5 5/12")	1061(W) x 407(D) x 129(H) mm (41 3/4" x 16" x 5 1/12")	
WEIGHT	20 kg (44 1/8 lbs.)	9.8 kg (21 5/8 lbs.)	15 kg (33 1/8 lbs.)	

* Specifications and descriptions in this owner's manual are for information purposes only. Yamaha Corp. reserves the right to change or modify products or specifications at any time without prior notice. Since specifications, equipment or options may not be the same in every locale, please check with your Yamaha dealer.

Index

0~9

123... (Chronological order)	262
2H Shelf (2-High Shelving Filter)	87
2L Shelf (2-Low Shelving Filter)	87
▽Mark	191

A

ABC... (File Name)	262
About Note/Velocity Limits Graphical Display	166
About Pattern Playback Control	220
About Performance number	156
About the Compare function	159
About the E (Edit) mark	159
About the Floppy Disks	259
About the Location for Each Event	201
About the Loop Lock Function	181
About the MIDI Signal Graphical Display	166
About The Tune Screen	74
About the Unit of the Sample Playback Parameters	180
Accent (Accent: Note name, Velocity)	272
ALL	190, 192, 222
ALG (Algorithm)	113
Algorithm	113
ALL (All Data)	263, 265
All Data	260
Alternate Group	146
Alternate Selection Methods	38
AMD (Amplitude Modulation Depth)	102, 147
AMP (Amplitude)	96, 110, 119, 147
AN (Layer)+AWM Voices	34
AN (Poly)+AWM Voices	34
AN Mono/Poly (AN Monophonic/Polyphonic)	112
AN Priority	113
AN Synthesis (Analog Physical Modeling)	33
AN System Overview	33
AN+FDSP Voices	35
Append Arpeggio	251
Append Pattern	230
Append Sample	183
Appendix	278
ARP (Arpeggio)	79, 160, 238, 245, 261, 265, 268
Arp Hold (Arpeggio Hold)	161, 272
Arp MIDI A/B (Arpeggio MIDI A/B)	271
Arp MIDI A/B (Arpeggio MIDI OUT A/B)	161
Arp MIDI Ch (Arpeggio MIDI Channel)	161, 271
Arp Note LimitH (Note Limit High)	79, 161
Arp Note LimitL (Note Limit Low)	79, 161
Arp Sw (Arpeggio Switch)	79, 161
Arp Tempo (Arpeggio Tempo)	79, 161
Arp Type (Arpeggio Type)	79, 161
ARP-EDIT (Arpeggio Edit)	79, 160
Arpeggiator Accompaniment	51
Arpeggio destination data (To)	268
Arpeggio Edit Mode	247
Arpeggio Hold	61
Arpeggio Job Mode	249
Arpeggio Mode	238
Arpeggio Mode screen	238
Arpeggio Played back as Chords	244
Arpeggio Record Mode	245

Arpeggio source data (From)	268
ArpeggioSw (Arpeggio Switch)	166
ASIB1 (SCSI Interface Board)	278
Assign	163, 272
Assigning Controllers to the Controller Set	105
Atck Level (Attack Level)	85
Atck Time (Attack Time)	85
Atck Time Vel (Attack Time Velocity)	84, 95, 98
Attack Level	96
Attack Mode	99
Attack T.Kf (Attack Time KeyFollow)	132, 140
Attack Time...	96, 99, 109, 111, 119, 120, 132, 140, 167
Audio Connections	18
Auditioning the Arpeggiator	240
Auditioning the Settings Done in the Preset Menu	171
Auto Load Function	261
AWM Synthesis	29
AWM System Overview	29

B

Balance	132
Bank	108, 117
Bank (Voice Bank)	164, 165, 167, 169, 170
Bank (Wave Bank)	80, 81
Bank/PC:MD (Bank/Program Change: MIDI)	170
Basic Steps for Wave Edit (Creating a new wave scratch)	151
Beat Graph	199
Beat Number	221
BEF (Band Elimination Filter)	93
Bend (Pitch Bend)	202
boost 6dB/12dB/18dB	90
BP 1~4 Level	94, 97
BP 1~4 point	94, 97
BP High (Break Point High)	125
BP Low (Break Point Low)	124
BPF (Band Pass Filter)	89, 93
Breath Controller	17
Breath Controller Assign	275
Bright	168

C

Cat (Category)	81
CAT (Channel After Touch)	203
CC (Control Change)	202
Ceiling	137
Center Key	83, 179
Changing Control Data	205
Changing Disks (When an external disk has been connected)	262
Changing Events	204, 226, 248
Changing Tempo Data	206
Changing the Time Signature And Patterns	205
Channel	272
Cho (Chorus)	106, 107, 162
Cho Pan (Chorus Pan)	106, 162
Cho Return (Chorus Return)	106, 162
Cho Send (Chorus Send)	106, 145, 165
Cho Type (Chorus Type)	162
Chord Separate	211, 234, 255
Chord Sort	211, 233, 255
Chorus	65

Cho→Rev (Chorus→Reverb)	106, 162
Cleaning the Disk Drive Read/Write Head	259
Clear Arp	250
Clear Arpeggio	250
Clear Pattern	229
Clear Song	207
Clear Track	208, 229, 251
Clearing Patterns	205
Click (Click Mode)	220, 239
Click (Metronome) (Click Mode)	186
Click (Metronome) Beat	186
CLICK (MIDI Click)	272
Clk (Clock Shift)	189
ClkSft (Clock Shift)	191
Clock	211, 215, 234, 235, 255, 256
Clock Number	222
Coar (Coarse Tune)	153
Coarse	127
Coarse Tune	83, 144
COM (Common)	77, 107, 112, 123, 142, 159
COM Menu	158
Compare & Store	47, 52
Compare and Store	77
Connect	92, 271
Connecting the Source	69
Controller	170
Controller Knob Mode Switching	46
Controller Reset	271
Controller Sets	58
Controller Set Remapping	59
Controllers & Modifiers	31
COPY	162, 192
Copy Arpeggio	250
Copy Measure	209, 231, 253
Copy Pattern	229
Copy Perform (Copy Performance)	173
Copy Sample	183
Copy Track	208, 229, 251
Copy Voice	149
Copy Wave	155
Create Measure	209
Crescendo	217, 236, 258
CTRL (Controller)	103, 111, 123, 141, 147, 163, 272
CTRL (Controller Setup)	275
Ctrl (Controllers)	104, 169
Ctrl To MIDI (Controller To MIDI)	170
Ctrl To TG (Controller To Tone Generator)	170
Curve	163, 272
Cutoff Freq (Cutoff Frequency)	110, 118

D

Data backup	260
DCF (Dynamic Control Filter)	91, 110
DCF1 Type (Filter 1 Type)	91
DCF1/2 EG (F1/2 EG)	92
DCF1/2 Freq (F1/2Frequency)	91
DCF1/2 Gain	91
DCF1/2 LFO (F1/2 LFO)	92
DCF1/2 Reso (F1/2 Resonance)	92
DCF2 Type (Filter 2 Type)	91
Dcy 1 Time Vel (Decay 1 Time Velocity)	98

Dcy 1/2 Level (Decay 1/2 Level)	85, 96
Dcy 1/2 Time (Decay 1/2 Time)	85, 96
Dcy 1~3 Level	99
Dcy 1~3 Time (Decay 1-3 Time)	99
Decay Level Vel (Decay Level Velocity)	99
Decay T.Kf (Decay Time KeyFollow)	133, 140
Decay Time	111, 119, 120, 133, 137, 140, 168
DEL (Delete)	268
Delay	100, 103
Delete Measure	210
Delete Sample	183
Delete Wave	155
Deleting an Element from Each Key	143
Deleting Control Data	205
Deleting Events	204, 227, 248
Deleting Notes	201
Deleting Tempo Data	206
Depth	103, 163, 272
Dest (Destination)	103
Dest Depth (Destination Depth)	105
Dest Param (Destination Parameter)	104
Destination Part	174
Destination Performance Number	174
Detune	81, 83, 164
DEV (Device Select)	269
Device No (Device Number)	275
Devices That Can Be Used	259
Digital Audio (Option)	20
Direct Edit Page Selection	46
Direct Play function	267
Disk Mode	259
Distance	127
DRAM SIMM	278
Drive	124, 127, 135, 137, 140
Drive EG (Drive EG Depth)	135
Drive EG (Drive Envelope Generator Depth)	140
Drive EG Vel (Drive Envelope Generator Velocity)	135, 140
Drive K.FlW (Drive KeyFollow)	135, 137, 140
Drive K.FlW(Drive KeyFollow)	124
Drive Vel (Drive Velocity)	140
Drum Key	143, 144, 145, 146
Drum Layer	143, 144, 145, 146
Drum Voice	141
Dry Level	130, 133, 134, 136, 138
Dry Vel (Dry Level Velocity)	136
DSP Limitations	39, 68, 78
Dst Arp (Destination Arpeggio)	250, 251, 252
Dst Event (Destination Event)	218, 237, 258
Dst Meas (Destination Measure)	209, 231, 253
Dst Ptn (Destination Pattern)	229, 230
Dst Sample (Destination Sample Bank)	183
Dst Sample (Destination Sample Number)	184
Dst Sample (Source Sample Number)	183
Dst Track (Destination Track)	208, 209, 230, 231, 232, 251, 252, 253
Dst Trk (Destination Track)	229, 253
Dst Wave (Destination Wave)	155
E	
Edge Bias	137
Edge EGDepth (Edge Envelope Generator Depth)	137
Edit Confirm	276
Edit the Sample	71
Editing Control	45
EFCT (Effects)	105, 148, 161
Effect Bypass	67, 276
Effects In the Performance Mode	67
Effects In the Voice Mode	66
EG (Amplitude Envelope Generator)	98, 120
EG (Envelope Generator)	110, 117, 167
EG (Filter Envelope Generator)	95, 119
EG (Pitch Envelope Generator)	84, 109
EG Depth	83
EG Depth (Envelope Generator Depth)	132, 134, 137
EG Depth Vel (Envelope Generator Depth Velocity)	132, 134, 137
EG Mode (Envelope Generator Mode)	131, 136, 139
EG Mode(Envelope Generator Mode)	134
EG Pickup (Electric Guitar Pickup)	126
EG Random	83
EG Shape (Envelope Generator Shape)	131
EG Time (Envelope Generator Time)	131, 134, 136, 139
EG Time Kflw (Envelope Generator Time KeyFollow)	132, 134, 139
EG Time Kflw(Envelope Generator Time KeyFollow)	136
Elem Sw (Element Switch)	104
Element Combinations	43
Element Configuration	43
Element Mute	77
Element Muting	46
Element Selection	45
ElmSw (Element Switch)	124
END (End Point)	181
EP Pickup (Electric Piano Pickup)	124
EQ (Equalizer)	109
EQ1~EQ5 Freq (EQ1~EQ5 Frequency)	109
EQ1~EQ5 Gain	109
EQ1~EQ5 Reso (EQ1~EQ5 Resonance)	109
Erase Measure	209, 231, 253
Events	210, 211, 233, 254
Event Chase	273
Event Data That Can Be Edited	202, 226, 247
Event Range	211, 233, 254
EX System Overview	28
Excl (System Exclusive)	203
EXDGO1 (Digital Output Board)	278
EXFLM1 (Flash Memory Board)	278
EXIDO1 (Individual Output Board)	278
Explanation for each FDSP type	124
ExpLowLimit (Expression Low Limit)	97, 145
Expressivity of Each Controllers	275
Extended MIDI Control Capability	56
Extended Synthesis	29
External Controllers	17
External Sampling Sources	21
External SCSI Device	259
Extract	210, 233, 254
Extract Sample	184
F	
[F1]/[F2]/[F3]/[F4]: REST/TIE/DEL(Delete)/ BKDEL(Back Delete)	200
F1/2 Freq EG Depth (Filter 1/2 Frequency EG Depth) ..	94
F1/2 Freq KeyFlw (Filter 1/2 Frequency KeyFollow)	94
F1/2 Freq Random (Filter 1/2 Frequency Random)	94
F1/2 Vel EG (Filter 1/2 Velocity EG)	93
F1/2 Vel Freq (Filter 1/2 Velocity Frequency)	94
F1/2 Vel Gain (Filter 1/2 Velocity Gain)	94
[F3] (ADD) and [F4] (DEL) Keys	151
Fade	101, 103
FDSP	123
FDSP (Formulated Digital Sound Processing)	123
FDSP Synthesis (Formulated Digital Signal Processing)	34
FDSP System Overview	34
FDSP Voice Element Structure	35
Feedback	129, 133, 134
Feedback Kf (Feedback KeyFollow)	129
Feedback Level	120
Feedback Vel (Feedback Velocity)	134
Feedback Vel(Feedback Velocity)	133
File Directory	262
FILT (Filter)	86, 109, 118, 147, 273
Filters	273
Filter Graphic Display	93
FilterBypass	128
FilterType	118
Fine (Fine Tune)	153
Fine Tune	83, 144
Flange	132
Floppy Disk	259
FM (Frequency Modulation)	114
FM Depth	114
FM Modulator	114
FM Src (FM Source)	114
FMD (Filter Modulation Depth)	102, 147
Foot Controllers (EX5 and EX7)	17
Foot SW Assign (Footswitch Assign)	275
Foot Switches (EX5 and EX7)	17
Foot Volume Assign	275
For Pattern Play Effects (PFX) Track	195
For Pattern Track	194
For Tracks 1~16	194
FORM (Device Format)	269
Fraction	181
Fraction (Loop Fraction)	181
Freq (Frequency)	88, 89, 90, 126, 128, 129
Freq EG Depth (Frequency EG Depth)	110, 118
Freq K.FlW (Frequency KeyFollow)	126
Freq K.FlW BP (Frequency KeyFollow Break Point)	110
Freq K.FlW(Frequency KeyFollow)	129
Freq K.Follow (Frequency Key Follow)	110, 118
Freq KeyFollow	88, 90
Freq Mod (Frequency Modulation)	129
Freq Mode (Frequency Mode)	153
Freq Random (Frequency Random)	88, 90
Freq Vel (Frequency Velocity)	88, 90
Freq Vel Sens (Frequency Velocity Sensitivity)	118
From Key: Oct	257
FromNote	236
FromNote (source note)	217
Front Panel	8
G	
Gain	90
Gain Random	90
Gain Vel (Gain Velocity)	90
Gat (Gate Time)	188, 190
Gate (Swing Gate Time)	214, 235, 256
Gate Time Display	199
Get Phrase	232, 253
Global Recv Ch (Global Receive Channel)	271, 274
Grid	191
Groove	188
GROOVE (Groove Template)	190, 222, 242
Groove View	191
GrvTim (Groove Gate Time)	191

H

Handling the Floppy Disk Drive(FDD) and Floppy Disk	259
Harmonic	168
Headphones	18
High Dump	129
High Dump Kf (High Dump KeyFollow)	129
High Freq (High Frequency)	86
High/Low Freq Vel (High/Low Frequency Velocity)	86
High/Low Gain	86
High/Low Gain Vel (High/Low Gain Velocity)	87
High1/2 Freq (High 1/2 Frequency)	87
High1/2 Freq Vel (High1/2 Frequency Velocity)	87
High1/2 Gain	88
High1/2 Gain Vel (High1/2 Gain Velocity)	88
Hold Level	85 , 96
Hold Time	85 , 96
Hold Time Vel (Hold Time Velocity)	84 , 95
How to Enter Song Record mode	193
How to Enter the Arpeggio Record Mode	245
How to Enter the Pattern Record Mode	223
How to Enter the Sample Record Mode	176
How to Install the ASIB1 (SCSI Interface Board) in the EX5R	288
How to Install the ASIB1 in the EX5/7	282
How to Install the EXDGO1 (Digital Output Board) in the EX5R	287
How to Install the EXDGO1 in the EX5/7	282
How to Install the EXFLM1/DRAM SIMM in the EX5R	290
How to Install the EXFLM1/DRAM SIMM in the EX5/7	284
How to Install the EXIDO1 in the EX5R	286
How to Install the EXIDO1 in the EX5/7	280
How to Install the Optional Board/ Memory (EX5R) ..	285
How to Install the Optional Board/ Memory (EX5/7) ..	279
How to Remove the EX5R Top Cover	285
How to Remove the Memory Cover (EXFLM1, DRAM SIMM)	280
How to Remove the Optional Board Cover (EXIDO1, EXDGO1, ASIB1)	279
How to Replace the EX5R Top Cover	285
HPF (High Pass Filter) ..	89 , 93, 125, 128, 129, 137, 141
HPF Freq (High Pass Filter Cutoff Frequency)	118
HPF K.FlW (High Pass Filter KeyFollow)	126 , 128, 137, 141

I

Individual Element Structure	40
Init Level (Initial Level)	99
Init Voice(Initialize Voice)	149
Init Perform (Initialize Performance)	173
Initial Level	109
InitVal KN1-6 (Initial Values KN1-6)	171
InitVal MW1/MW2/AT/FC/BC/RB (Initial Values)	170
InitVal PB (Initial Value Pitch Bend)	170
Input Gain	86
Input Level	140
Input Level Bar	176
Inputting Notes	200
Inputting Rests	201
Inputting Staccato and Slurs	201
Inputting Ties	201
INS1 (Insertion 1)	106
INS2 (Insertion 2)	106
InsEF Connect (Insertion Effects Connect)	105

InsEF Elem Sw (Insertion Effect Element Switch)	105 , 146
InsEF Sw (Insertion Effect Switch)	165
InsEF1 (Insertion Effect 1)	106
InsEF2 (Insertion Effect 2)	106
Inserting Control Data	205
Inserting Events	204 , 226, 248
Inserting Tempo Data	206
Inserting/Ejecting Floppy Disks	259
Insertion Effects	66
Installation	280 , 282, 284, 286, 287, 288, 289
Instrument Amplifier or Stereo Sound System	18
Ins→Cho	148
Ins→Rev	148
Introductory Section	8
InvertLPF (Inverted Low Pass Filter)	89

J

JOB1	207 , 228, 250
JOB2	209 , 231, 252
JOB3	212 , 234, 255

K

K.FlW Coarse (KeyFollow Coarse)	138
K.FlW Fine (KeyFollow Fine)	138
Kbd/TG Mode (Keyboard/Tone Generator Mode)	160 , 271
Key	240
Key Assign	79 , 146, 165
Key Mapping Procedure	72
Keyboard Illustration	200
Keyboard Transpose	270
KeyFollow	83 , 128, 130, 132, 134, 135
KeyOn Delay	81 , 108, 144
Knob	171
Knob To MIDI	171
Knob To TG (Knob To Tone Generator)	171

L

L (Loop)	85 , 96
L/H Shelf (Low/High Shelving Filter)	86
Layer	152
Layers	49
Layer Sw (Layer Switch)	166
Layered AWM Voices	30
LCD Messages	294
Length	117 , 239
Length (Loop Length)	221
Level	81 , 96, 145
Level K.FlW BP (Level Key Follow Break Point)	110
Level K.Follow (Level KeyFollow)	110
Level KeyFollow	97
Level Vel (Level Velocity)	97 , 145
LFO (Low Frequency Oscillator)	100 , 111, 121, 147
LFO Depth (Low Frequency Oscillator Depth)	131 , 133, 134
LFO Mode (Low Frequency Oscillator Mode)	130
LFO Phase (Low Frequency Oscillator Phase)	131
LFO Speed (Low Frequency Oscillator Speed)	131 , 133, 134
LFO Wave (Low Frequency Oscillator Wave)	131
LFO1 (Low Frequency Oscillator1)	100
LFO1 AMD (LFO1 Amplitude Modulation)	123
LFO1 Delay	123
LFO1 FMD (LFO1Frequency Modulation)	123
LFO1 Speed	123

LFO1 Sync	123
LFO1 Wave (Low Frequency Oscillator1 Wave)	121
LFO2 (Low Frequency Oscillator 2)	102
LFO2 Speed	123
LFO2 Wave (Low Frequency Oscillator 2 Wave)	123
LOAD (File Load)	265
Load and Play the Demo Songs	25
LOC1/LOC2 (Location 1/2)	186
Local (MIDI Control Out)	275
Location (Measure, Beat, Clock)	198
LOOP	181 , 186
Loop End	181
Loop Length	180
Loop Length Offset	144
Loop Start/End Point	186
Loop Top	180
LoopTune	179
Low Freq (Low Frequency)	86
Low1/2 Freq (Low 1/2 Frequency)	87
Low1/2 Freq Vel (Low1/2 Frequency Velocity)	87
Low1/2 Gain	87
Low1/2 Gain Vel (Low1/2 Gain Velocity)	87
LPF (Low Pass Filter)	88 , 92, 135, 137
LPF K.FlW (Low Pass Filter KeyFollow)	136 , 137
LpLength (Loop Length)	152
Lvl (Level)	153
LYR (Layer)	165

M

M.FreqCoarse (Main Frequency Coarse)	139
M.FreqFine (Main Frequency Fine)	139
M.Mod Depth (Main Modulation Depth)	139
M.Mod EG (Main Modulation Envelop Generator Depth)	139
M.Mod EG Vel (Main Modulation Envelop Generator Velocity)	139
Master Note Shift	270
Master Tune	270
Master Volume	270
MaxLng (Maximum Length)	220
MD BankLSB (MIDI Bank Select LSB)	170
MD BankMSB (MIDI Bank Select MSB)	170
Meas (Measure)	186 , 220, 224, 239, 246
Meas(Measure)	194
Measure ..	208 , 209, 210, 211, 212, 215, 216, 217, 218, 230, 231, 232, 233, 234, 235, 236, 237, 252, 253, 254, 255, 256, 257, 258
Measure Number	221
Measure/ARP (Arpeggio Type Number/Name)	238
Measure/PTN (Pattern Name)	219
Measure/SONG (Song Name)	185
Memory Protect	276
Metronome (Click) Beat	220 , 239
MIX	81 , 117, 119, 145, 153, 164
Mic/Line Level	176
Micro Tuning	84
MIDI (MIDI Setup)	274
MIDI Ch (MIDI Channel)	165
MIDI Connections	22
MIDI Ctrl In (MIDI Control In)	274
MIDI Ctrl Out (MIDI Control Out)	274
MIDI Echo Back	274
MIDI Pan/Vol (MIDI Pan/Volume)	165
MIDI PC (MIDI Program Change)	170
MIDI to TG (MIDI to Tone Generator)	166
MIDI Trans Ch (MIDI Transmit Channel)	271

MIDI Trns Ch	274
MIDI-A/MIDI-B (MIDI OUT A/B)	192 , 222
Mix Track	208 , 229, 251
Mixing Console	19
MKDIR (Make Directory)	269
MLT (Multi)	171
MODE	242
MOD (Modulation)	116
Mod Smooth (Modulation Smooth)	129
Mod Speed (Modulation Speed)	129
Modify GateTime	215 , 235, 256
Modify Velocity	216 , 235, 257
Mono/Poly	79
Mono/Poly (Monophonic/Polyphonic)	165
Move Clock	214 , 235, 256
MSG (Greeting Message)	277
MTC Start Offset (MTC Start Offset)	274
Multi	63, 195 , 224
MULTI Menu	158
Multi-timbre Tone Generator	51
Mute	185 , 219, 239

N

NAME	79 , 152, 163, 182
NAME (Arpeggio Type Name)	244
NAME (Pattern Name)	222
NAME (Song Name)	192
Necessary Items	280 , 282, 284, 286, 287, 288, 289
No (Pattern Number)	220 , 224
Noise Level	120
Normal (Normal: Note name, Velocity)	272
Normal Voice (AN Element)	112
Normal Voice (AWM Element)	77
Normal Voice (VL Element) (EX5/5R only)	107
Normal Voices & Drum Voices	39
Normalize Effect	208
Normalize Sample	184
Note	202
Note Length	199
Note Limit High	82 , 153
Note Limit L/H (Note Limit Low/High)	166
Note Limit Low	82 , 153
Note Xfade (Note Cross Fade)	82
NoteShift	167
NRPN (Non Registered Parameter Number)	203
Number	80 , 81, 108, 164, 165, 167, 169, 170

O

Offset	188, 215 , 216, 235, 236, 257
Ofst (Offset)	163 , 272
Optional Boards/Memories	278
OSC (Oscillator)	80 , 108, 113, 142
OTHER (Other Setup)	276
Other Time Vel (Other Time Velocity)	84 , 95, 98
Out (Output Select)	146
Out High Kf (Out High KeyFollow)	125
Out Hmid Kf (Out High Mid KeyFollow)	125
Out Level (Output Level)	125
Out Lmid Kf (Out Low Mid KeyFollow)	125
Out Low Kf (Out Low KeyFollow)	125
Out Select (Output Select)	164
Output	128
Output (Output Level)	141
Output KFlw (Output KeyFollow)	128
OVER (Over Dubbing)	195

OVER(Over Dubbing)	224 , 246
Overall System Structure	42
Overdrive	141
Overdub	62
Overtone	137

P

Pan	81 , 97, 126, 128, 130, 132, 133, 134, 136, 138, 140, 141, 145, 153, 164
Pan KeyFollow	97
PART	164 , 165, 167, 169, 170
PARAM (Parameter)	179
PARAM (Parameters)	77 , 83, 96, 107, 108, 110, 112, 117, 119, 142, 159
PART Menu	158
PAT (Polyphonic After Touch)	203
Pattern	186
Pattern destination data (To)	268
Pattern Edit Mode	226
Pattern Job Mode	227
Pattern Mode	219
Pattern Play Mode	219
Pattern Record Mode	223
Pattern source data (From)	267
PC (Program Change)	202
PC To MIDI	170
PEG (Pitch Envelope Generator)	168
PEG Atck (PEG Attack)	168
PEG Decay Time	118
PEG Depth	117
PEG Depth (Pitch Envelope Generator Depth)	139
PEG DepthVel (Pitch Envelope Generator Depth Velocity)	139
PEG Init (PEG Initial)	168
PEG Mode	117
PEG ReL (PEG Release Level)	168
PEG ReIT (PEG Release Time)	168
PEQ (Parametric Equalizer)	90
Performance Category	157
Performance Edit Mode	158
Performance Job Mode	172
Performance Mode	156
Performance Mode DSP Limitations	54
Performance name	157
Performance Play Mode	156
Performance Play Mode screen	156
Performance Store Procedure	53
PFX (Pattern Play Effects Track)	205
PFX (Play Effects)	187 , 220, 241
PFX (Settings related to Play Effects)	195
Phase	103 , 135
Phaser	133
Picking P Kf (Picking Position KeyFollow)	127
Picking Pos (Picking Position)	127
PickingNotch	127
Pickup Notch	127
Pickup P Kf (Pickup Position KeyFollow)	127
Pickup Pos (Pickup Position)	127
Pickup Type	124, 127
PITCH	83 , 111, 146
PITCH (Pitch Control)	103
PITCH (Pitch Parameters)	108 , 117
Pitch Bend Lower	103 , 169
Pitch Bend Upper	103 , 169
Pitch Coarse	128 , 130, 132, 133, 135, 138
Pitch EG Depth	144

Pitch EG VelSens (PEG Velocity Sensitivity)	144
Pitch Fine	128 , 132, 138
Pitch Related Settings for Arpeggio	240
Play Effects & Groove Quantization	64
Play Effects Thru	185 , 220, 239
Play Mode	175
PMD (Pitch Modulation Depth)	102 , 147
PNCH (Punch In)	195
Polarity	135
Polyphony	45, 78
Port (Portamento)	169
Port Mode (Portamento Mode)	104 , 169
Port Sw (Portamento Switch)	103 , 169
Port Time (Portamento Time)	103 , 169
Pos High Kf (Position High KeyFollow)	125
Pos Hmid Kf (Position High Mid KeyFollow)	125
Pos Lmid Kf (Position Low Mid KeyFollow)	125
Pos Low Kf (Position Low KeyFollow)	125
Position	125
Post EQ	109
Power Supply	16
Power-on Procedure	24
PRE (Preset)	170
Pre Gain	136
Pre LPF (Low Pass Filter)	136
Precautions	259
Precautions When Installing the Optional Boards	278
Precautions When Purchasing DRAM SIMMs	279
Preparation	279 , 285
Ptn	229
PTN (Pattern)	219 , 223, 261, 264, 267
PTN (Pattern Track)	205
Ptn No (Pattern Number)	194
Ptn Tr (Pattern Track)	195
Pulse Width	130
Punch	62
Put Phrase	232
PWM (Pulse Width Modulation)	130
PWM Depth (Pulse Width Modulation Depth)	130
PWM DepthVel (Pulse Width Modulation Depth Velocity)	130
PWM Src (Pulse Width Modulation Source)	116

Q

Quant (Quantize value)	191
Quantize	212 , 234, 256
Qunt (Quantize Value)	212 , 234, 256

R

Random Depth	97 , 145
Range	217 , 236, 258
Rate	189 , 215, 216, 235, 236, 257
Rate (Swing Rate)	213 , 235, 256
Real Time Recording	224 , 246
Real Time Recording: Pattern	196
Real Time Recording: PFX	197
Real Time Recording: Tempo	198
Real Time Recording: Tr1-Tr16	196
Rear Panel	14
Rec From-To	194
Rec Mode (Record Mode)	176
Recall Perform (Recall Performance)	173
Recall Voice	149
Receive GM On	274
Receive Pgm Chng (Receive Program Change)	274

Record Mode & Input Settings	70
Recording Mode	195 , 224, 246
Recording the Sample	71
Recv Note Off (Receive Note Off)	145
Reference Section	75
Rel (Rel 1/2) Time	99
Rel1 Level	99
Rel1/Rel2 Level (Release 1/2 Level)	85 , 96
Rel1/Rel2 Time (Release 1/2 Time)	85 , 96
Relative & Absolute Controller Knob Data Entry	47
Release Level	109
Release Mode	99
Release Time	109 , 111, 119, 121, 168
ReleaseTime	129 , 133, 134, 137
REMAP	104
Remaining Memory	185 , 219, 238
Replace	62
Reso (Frequency Characteristics)	90
Reso (Resonance)	88 , 91
Reso Random (Resonance Random)	88
Reso Vel (Resonance Velocity)	88
Reso. Vel (Resonance Velocity)	91
Resonance	110 , 118, 126, 128, 129
Restoring the Factory Set Data	27
Rev (Reverb)	106 , 107, 162
Rev Pan (Reverb Pan)	106 , 162
Rev Return (Reverb Return)	106 , 162
Rev Send (Reverb Send)	106 , 145, 165
Rev Type (Reverb Type)	161
Reverb	65
Ribbon Controller Mode	276
Ribbon Mode	160
Ring Mod (Ring Modulator)	138
Ring Mod Level (Ring Modulation Level)	120
RNAM (File Rename)	268
Rndm (Random)	101
RPLC (Replace)	195 , 246
RPLC(Replace)	224
RPN (Registered Parameter Number)	203

S

S.FreqCoarse (Sub Frequency Coarse)	139
S.FreqFine (Sub Frequency Fine)	139
S.Mod Depth (Sub Modulation Depth)	139
S.Mod EG (Sub Modulation Envelop Generator Depth)	139
S.Mod EG Vel (Sub Modulation Envelop Generator Velocity)	139
Sample Bank	144 , 145, 146, 152, 175
Sample destination data (To)	267
Sample Edit Mode	179
Sample Job Mode	182
Sample Mode	175
Sample Number	144 , 145, 146, 152, 175
Sample Play	145
Sample Play Mode	175
Sample Record Mode	176
Sample source data (From)	266
Sampling	69
SAVE (File Save)	263
Save Samples to Disk	71
SCALE	83 , 94, 97, 108, 117
Scene Control (Scene Morphing)	58
Scene Controller Assign	276
Scene Recall & Switching	57
Scene Switching & Morphing	57

SCF (Static Control Filter)	86
SCSI ID	276
SCSI Interface (Option)	21
SET	111
Seismic	140
Selecting a Performance	157
Selecting By Category	38
Selecting Voices	76
Self FM	135
Sens (Quantize Sensitivity)	213 , 235, 256
SENS (Sensitivity)	93
SEQ (Sequencer Setup)	272
SEQ (Tr1-16: Sequence tracks 1-16)	202
Sequence Editing	63
Sequence Record Modes & Editing	62
Sequencer Functions	60
SET (Controller Set)	104 , 123, 141
SET(Controller Set)	147
Setting a File Name	192, 263
Setting Levels	70
Setting the Amplitude Envelope Generator	99
Setting the Amplitude Scaling	98
Setting the Filter Envelope Generator	96
Setting the Filter Scaling	94
Setting the Pitch Envelope Generator	85
Setting the Voice Name	80
Setting Up	16
Setting Up and Sampling From an External Source	69
Shift Event	218 , 237, 258
Shift Note	217 , 236, 257
Size	210
SMF (MIDI File)	260, 264 , 267
SMPL (Sample)	152
SmpPlay (Sample Play)	152 , 179
SONG	185 , 194, 261, 264, 267
SONDIUS-XG	6
Song Control	187
Song Edit Mode	201
Song Job Mode	206
Song Mode	185
Song Play Mode	185
Song Record Mode	193
SOUND	167
Source	176
Source Part	173
Source Performance Number	173
Specifications	295
Speed	101 , 103, 147
Split Arpeggio	252
Split Keyboard	50
Split Pattern	230
Src Arp (Source Arpeggio)	250 , 251, 252
Src Event (Source Event)	218 , 237, 258
Src Meas (Source Measure)	209 , 231, 253
Src Ptn (Source Pattern)	229 , 230, 232
Src Sample (Source Sample Bank)	183
Src Sample (Source Sample Number)	183 , 184
Src Song Track (Source Song Track)	232 , 253
Src Sw (Source Switch)	104
Src Track (Source Track)	208 , 209, 230, 231, 251, 252
Src Trk (Source Track)	253
Src Wave (Source Wave)	155
Src(Source)	194
Src1 Sample (Source 1 Sample Number)	184
Src2 Sample (Source 2 Sample Number)	184

SrcTrack (Source Track)	230 , 251
SrcTrk (Source Track)	229 , 230
START (Start Point)	181
Start Offset	144
Start/End	184
StartOfs (Start Offset)	152
Step	63, 195 , 224, 246
Step Recording	225 , 246
Step Recording Screen	198 , 225, 246
Step Recording: Tr1~Tr16	198
Steps for Assigning Elements to Each Key, and for Editing	142
Steps for creating a User Template	190
Steps for Disk Mode Operations	261
Steps for Executing a Job	148 , 154, 172, 182, 207, 228, 249
Steps for Executing Undo/Redo	218
Steps for Sampling 1 (Sampling from an external device such as a microphone)	177
Steps for Sampling 2 (Re-sampling from the internal tone generator/memory)	178
Steps for Setting the Play Effects	187 , 221, 241
Steps for the Utility Mode Operation	270
Storing a Scene	57
Str (Quantize Strength)	188
Streng (Quantize Strength)	213 , 235, 256
Sub Pitch	138
Sustain Level	111 , 119, 120
Sustain Lvl (Sustain Level)	133 , 140
Sync	100 , 103, 114, 147, 273
SYN (Synth All)	264 , 265
SYN (Synthesizer Setup)	270
Sync Depth	114
Sync Pitch	114
Sync Src (Sync Source)	114
Synth All	260
SysEX Interval (System Exclusive Interval)	273
System Effects	65
System Initialization	27
System Overview	40
Sythn All destination data (To)	266
Sythn All source data (From)	266

T

T-Ch (Transmit Channel)	192 , 222
TCH (Transmit Channel)	192 , 222
Tempo	186 , 220, 239
TEMPO (Tempo Track)	206
Tempo Ctrl (Tempo Control)	79 , 161
TG (Tone Generator)	192 , 222
The Arpeggiator	61
The Control Curve	163 , 272
The Controllers	55
The Controls & Connectors	8
The EX Controllers	55
The EX Effect System	65
The Function Keys After Selecting the Basic Menu	262
The Key Map Mode	72
The Pattern Mode	60
The Power of the Performance Mode	49
The Procedure for Step Recording	200 , 225, 247
The Song Mode	60
The Supplied Disks, Demos & Factory Set Data	25
The VL "Instrument" or "Wave"	30
The Voice/Performance Directory	38
Thin Out	210 , 232, 254

Thru	90, 93
Thru Gain	92
Time	208, 210, 231, 252
Tim (Timing)	188
Times	209, 231, 253
Time K.Follow (Time KeyFollow)	119, 120
Time Scale	85, 95, 98
Time Signature	186, 194, 199, 220, 224, 239, 246
Time Stretch	208, 231, 252
TOP	181
To handle floppy disks with care	259
To Key: Oct	258
To Note	236
To Note(destination note)	217
To protect your data (Write-protect Tab)	260
Tornado	136
Total Volume	160
Tr (Track Number)	188, 191
TR(Track)	190, 192, 222
Track	194, 208, 209, 210, 211, 212, 215, 216, 217, 218, 224, 229, 231, 232, 233, 234, 235, 236, 237, 246, 251, 252, 253, 254, 255, 256, 257, 258
Track (Source Track)	232
Track Number	185, 198, 219, 239
Track Section	185, 219, 239, 242
Transpose	190, 217, 236, 257
Trigger	176
Trigger Level	177
Trns (Transpose)	190
Trns MIDI A/B	275
Trns MIDI A/B (Transmit to MIDI A/B)	165
Trns Sw (Transmission Switch)	169
TrnsMIDI A/B (Transmit MIDI A/B)	271
Troubleshooting	291
TUNE	143
Type	86, 105, 124, 148, 160, 161, 188, 191, 211, 233, 255
Types of Data	260
Types of Files	260
Types of Source Data	174

U

UNDO/REDO	218, 237, 258
Unit	222, 242
Using the Cursor Keys in Step Recording	198
Utility Mode	270

V

Val (Quantize value)	188
VCE (Voice)	264, 266
VCF (Voltage Controlled Filter)	118
VCO (Voltage Controlled Oscillator)	114
VCO1 Level	119
VCO1 ModSw (VCO1 Modulation Switch)	116
VCO1/2 Edge	115
VCO1/2 Freq Fine (VCO1/2Frequency Fine)	114
VCO1/2 FreqCoarse (VCO1/2Frequency Coarse)	114
VCO1/2 Mod (VCO1/2Modulation)	116
VCO1/2 Mod Src (VCO1/2 Modulation Source)	116
VCO1/2 PitchScale	115
VCO1/2 PulseWidth	116
VCO1/2 PWM (Pulse Width Modulation)	116
VCO1/2 Wave	115
VCO2 Level	120
Vel (Swing Velocity)	214, 235, 256
Vel (Velocity)	101, 188, 189

Vel Depth (Velocity Depth)	79
Vel Limit High (Velocity Limit High)	82, 146, 153
Vel Limit L/H (Vel Limit Low/High)	166
Vel Limit Low (Velocity Limit Low)	82, 146, 153
Vel Offset (Velocity Offset)	79
Vel Sens/Ofst (Velocity Sensitivity/Offset)	167, 271
Vel Xfade (Velocity Cross Fade)	82, 146
Vel(Velocity)	240
VelCurve (Velocity Curve)	166, 271
Velocity	199
Velocity Switching	50
VelOfst (Velocity Offset)	191
Vel→EG (Velocity→EG)	83
Vib (Vibrato)	168
VibDelay (Vibrato Delay)	168
VibDepth (Vibrato Depth)	168
VibRate (Vibrato Rate)	168
Vibrato Delay	111
Vibrato Depth	111
Vibrato Speed	111
Virtual Acoustic Synthesis (EX5 and EX5R only)	30
VL + AWM Voices	32
VL Mono/Poly (VL Monophonic/Polyphonic)	108
VL Priority	108
VL System Overview	32
Voice	260
VOICE (Voice Mode Setup)	271
Voice & Performance Selection	36
Voice destination data (To)	266
Voice Edit Mode	76
Voice Editing From the Performance Mode	52, 159
Voice Job Mode	148
Voice Mode	75
Voice Mode Setup	76
Voice Play Mode	75
Voice Play Mode screen	75
Voice source data (From)	266
Voice Store Procedure	48
Voice Structure & Editing Hints	40
Voice Type	77
Volume	79, 120, 164

W

Water	128
WAVE	80, 100, 102, 108, 116, 144, 147, 155, 260, 264, 266
Wave Display	181
Wave Edit Mode	150
Wave Job Mode	154
Wave Play	81
Wave Start	180
Wave Type	179
WAVE-EDIT	81, 108
WavePlay	108
Waves for Start/Top/End Points and Magnifying Function	181
Wet Gain	138
Wet Level	129, 133, 134, 136, 138
Wet Vel (Wet Level Velocity)	136, 138
Word Clock	277

Z

ZONE	82, 117, 146, 153
Zone Graphical Display	82, 152, 154

For details of products, please contact your nearest Yamaha or the authorized distributor listed below.

Pour plus de détails sur les produits, veuillez-vous adresser à Yamaha ou au distributeur le plus proche de vous figurant dans la liste suivante.

Die Einzelheiten zu Produkten sind bei Ihrer unten aufgeführten Niederlassung und bei Yamaha Vertragshändlern in den jeweiligen Bestimmungsländern erhältlich.

Para detalles sobre productos, contacte su tienda Yamaha más cercana o el distribuidor autorizado que se lista debajo.

NORTH AMERICA

CANADA

Yamaha Canada Music Ltd.
135 Milner Avenue, Scarborough, Ontario,
M1S 3R1, Canada
Tel: 416-298-1311

U.S.A.

Yamaha Corporation of America
6600 Orangethorpe Ave., Buena Park, Calif. 90620,
U.S.A.
Tel: 714-522-9011

CENTRAL & SOUTH AMERICA

MEXICO

Yamaha de Mexico S.A. De C.V.,
Departamento de ventas
Javier Rojo Gomez No.1149, Col. Gpe Del
Moral, Deleg. Iztapalapa, 09300 Mexico, D.F.
Tel: 686-00-33

BRASIL

Yamaha Musical do Brasil LTDA.
Ave. Reboucas 2636, São Paulo, Brasil
Tel: 011-853-1377

ARGENTINA

Yamaha Music Argentina S.A.
Viamonte 1145 Piso2-B 1053,
Buenos Aires, Argentina
Tel: 1-371-7021

PANAMA AND OTHER LATIN AMERICAN COUNTRIES/ CARIBBEAN COUNTRIES

Yamaha de Panama S.A.
Torre Banco General, Piso 7, Urbanización Marbella,
Calle 47 y Aquilino de la Guardia,
Ciudad de Panamá, Panamá
Tel: 507-269-5311

EUROPE

THE UNITED KINGDOM

Yamaha-Kemble Music (U.K.) Ltd.
Sherbourne Drive, Tilbrook, Milton Keynes,
MK7 8BL, England
Tel: 01908-366700

IRELAND

Danfay Ltd.
61D, Sallynoggin Road, Dun Laoghaire, Co. Dublin
Tel: 01-2859177

GERMANY/SWITZERLAND

Yamaha Europa GmbH.
Siemensstraße 22-34, 25462 Rellingen,
F.R. of Germany
Tel: 04101-3030

AUSTRIA

Yamaha Music Austria
Schleiergasse 20, A-1100 Wien Austria
Tel: 01-60203900

THE NETHERLANDS

Yamaha Music Nederland
Kanaalweg 18G, 3526KL, Utrecht, The Netherlands
Tel: 030-2828411

BELGIUM

Yamaha Music Belgium
Keiberg Imperiastraat 8, 1930 Zaventem, Belgium
Tel: 02-7258220

FRANCE

Yamaha Musique France,
Division Professionnelle
BP 70-77312 Marne-la-Vallée Cedex 2, France
Tel: 01-64-61-4000

ITALY

Yamaha Musica Italia S.P.A.,
Combo Division
Viale Italia 88, 20020 Lainate (Milano), Italy
Tel: 02-935-771

SPAIN

Yamaha-Hazen Electronica Musical, S.A.
Jorge Juan 30, 28001, Madrid, Spain
Tel: 91-577-7270

PORTUGAL

Valentim de Carvalho CI SA
Estrada de Porto Salvo, Paço de Arcos 2780 Oeiras,
Portugal
Tel: 01-443-3398/4030/1823

GREECE

Philippe Nakas S.A.
Navarinou Street 13, P.Code 10680, Athens, Greece
Tel: 01-364-7111

SWEDEN

Yamaha Scandinavia AB
J. A. Wettergrens Gata 1
Box 30053
S-400 43 Göteborg, Sweden
Tel: 031 89 34 00

DENMARK

YS Copenhagen Liaison Office
Generatorvej 8B
DK-2730 Herlev, Denmark
Tel: 44 92 49 00

FINLAND

Warner Music Finland OY/Fazer Music
Aleksanterinkatu 11, P.O. Box 260
SF-00101 Helsinki, Finland
Tel: 0435 011

NORWAY

Norsk filial av Yamaha Scandinavia AB
Grini Næringspark 1
N-1345 Østerås, Norway
Tel: 67 16 77 70

ICELAND

Skifan HF
Skeifan 17 P.O. Box 8120
IS-128 Reykjavik, Iceland
Tel: 525 5000

OTHER EUROPEAN COUNTRIES

Yamaha Europa GmbH.
Siemensstraße 22-34, 25462 Rellingen, F.R. of
Germany
Tel: 04101-3030

AFRICA

Yamaha Corporation,
International Marketing Division
Nakazawa-cho 10-1, Hamamatsu, Japan 430-8650
Tel: 053-460-2312

MIDDLE EAST

TURKEY/CYPRUS

Yamaha Europa GmbH.
Siemensstraße 22-34, 25462 Rellingen,
F.R. of Germany
Tel: 04101-3030

OTHER COUNTRIES

Yamaha Corporation,
International Marketing Division
Nakazawa-cho 10-1, Hamamatsu, Japan 430-8650
Tel: 053-460-2312

ASIA

HONG KONG

Tom Lee Music Co., Ltd.
11/F., Silvercord Tower 1, 30 Canton Road,
Tsimshatsui, Kowloon, Hong Kong
Tel: 730-1098

INDONESIA

PT. Yamaha Music Indonesia (Distributor)
PT. Nusantik
Gedung Yamaha Music Center, Jalan Jend. Gatot
Subroto Kav. 4, Jakarta 12930, Indonesia
Tel: 21-520-2577

KOREA

Cosmos Corporation
#131-31, Neung-Dong, Sungdong-Ku, Seoul
Korea
Tel: 02-466-0021~5

MALAYSIA

Yamaha Music Malaysia, Sdn., Bhd.
16-28, Jalan SS 2/72, Petaling Jaya, Selangor,
Malaysia
Tel: 3-717-8977

PHILIPPINES

Yupangco Music Corporation
339 Gil J. Puyat Avenue, P.O. Box 885 MCPO,
Makati, Metro Manila, Philippines
Tel: 819-7551

SINGAPORE

Yamaha Music Asia Pte., Ltd.
Blk 202 Hougang, Street 21 #02-01,
Singapore 530202
Tel: 382-1922

TAIWAN

Yamaha KHS Music Co., Ltd.
10F, 150, Tun-Hwa Northroad,
Taipei, Taiwan, R.O.C.
Tel: 02-717-3812

THAILAND

Siam Music Yamaha Co., Ltd.
121/60-61 RS Tower 17th Floor,
Ratchadaphisek RD., Dindaeng,
Bangkok 10320, Thailand
Tel: 02-641-2951

THE PEOPLE'S REPUBLIC OF CHINA AND OTHER ASIAN COUNTRIES

Yamaha Corporation,
International Marketing Division
Nakazawa-cho 10-1, Hamamatsu, Japan 430-8650
Tel: 053-460-2317

OCEANIA

AUSTRALIA

Yamaha Music Australia Pty. Ltd.
17-33 Market Street, South Melbourne, Vic. 3205,
Australia
Tel: 3-699-2388

NEW ZEALAND

Music Houses of N.Z. Ltd.
146/148 Captain Springs Road, Te Papapa,
Auckland, New Zealand
Tel: 9-634-0099

COUNTRIES AND TRUST TERRITORIES IN PACIFIC OCEAN

Yamaha Corporation,
International Marketing Division
Nakazawa-cho 10-1, Hamamatsu, Japan 430-8650
Tel: 053-460-2317

