

YAMAHA

PERSONAL DIGITAL PIANO

PDP-500

OWNER'S MANUAL

SPECIAL MESSAGE SECTION

PRODUCT SAFETY MARKINGS: Yamaha electronic products may have either labels similar to the graphics shown below or molded/stamped facsimiles of these graphics on the enclosure. The explanation of these graphics appears on this page. Please observe all cautions indicated on this page and those indicated in the safety instruction section.

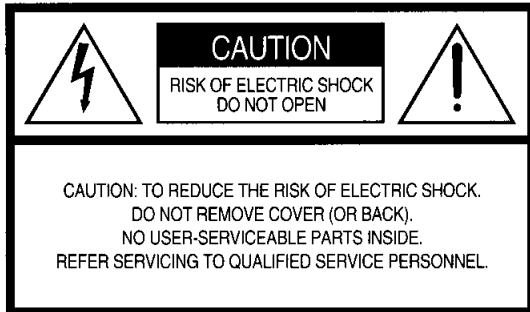

See bottom of Keyboard enclosure for graphic symbol markings



The exclamation point with the equilateral triangle is intended to alert the user to the presence of important operating and maintenance (servicing) instructions in the literature accompanying the product.



The lightning flash with arrowhead symbol within the equilateral triangle is intended to alert the user to the presence of uninsulated "dangerous voltage" within the product's enclosure that may be of sufficient magnitude to constitute a risk of electrical shock.

IMPORTANT NOTICE: All Yamaha electronic products are tested and approved by an independent safety testing laboratory in order that you may be sure that when it is properly installed and used in its normal and customary manner, all foreseeable risks have been eliminated. DO NOT modify this unit or commission others to do so unless specifically authorized by Yamaha. Product performance and/or safety standards may be diminished. Claims filed under the expressed warranty may be denied if the unit is/has been modified. Implied warranties may also be affected.

SPECIFICATIONS SUBJECT TO CHANGE: The information contained in this manual is believed to be correct at the time of printing. However, Yamaha reserves the right to change or modify any of the specifications without notice or obligation to update existing units.

ENVIRONMENTAL ISSUES: Yamaha strives to produce products that are both user safe and environmentally friendly. We sincerely believe that our products and the production methods used to produce them, meet these goals. In keeping with both the letter and the spirit of the law, we want you to be aware of the following:

Battery Notice: This product MAY contain a small non-rechargeable battery which (if applicable) is soldered in place. The average life span of this type of battery is approximately five years. When replacement becomes necessary, contact a qualified service representative to perform the replacement.

Warning: Do not attempt to recharge, disassemble, or incinerate this type of battery. Keep all batteries away from children. Dispose of used batteries promptly and as regulated by applicable laws. Note: In some areas, the servicer is required by law to return the defective parts. However, you do have the option of having the servicer dispose of these parts for you.

Disposal Notice: Should this product become damaged beyond repair, or for some reason its useful life is considered to be at an end, please observe all local, state, and federal regulations that relate to the disposal of products that contain lead, batteries, plastics, etc.

NOTICE: Service charges incurred due to lack of knowledge relating to how a function or effect works (when the unit is operating as designed) are not covered by the manufacturer's warranty, and are therefore the owners responsibility. Please study this manual carefully and consult your dealer before requesting service.

NAME PLATE LOCATION: The graphic below indicates the location of the name plate. The model number, serial number, power requirements, etc., are located on this plate. You should record the model number, serial number, and the date of purchase in the spaces provided below and retain this manual as a permanent record of your purchase.

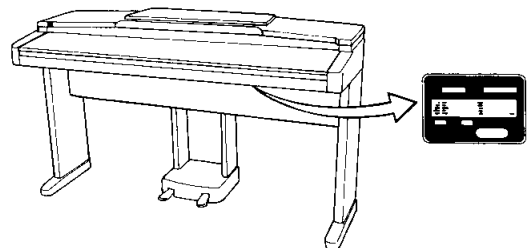

Model _____

Serial No. _____

Purchase Date _____

PRECAUTIONS

Your PDP-500 is a fine musical instrument, and deserves the most careful treatment. Observe the following points and your PDP-500 will sound and look great for many years.

1. Never open the case and touch or tamper with the internal circuitry.
2. Always turn the POWER switch OFF after use, and cover the keyboard with the built-in key cover.
3. Clean the cabinet and keys of your PDP-500 only with a clean, slightly damp cloth. A neutral cleanser may be used if desired. Never use abrasive cleansers, waxes, solvents or chemical dust cloths since these can dull or damage the finish.
4. Never place any vinyl products on your PDP-500. Contact with vinyl can cause irreversible damage to the finish.
5. Install your PDP-500 in a place that is away from direct sunlight, excessive humidity or heat.
6. Never apply excessive force to the controls, connectors or other parts of your PDP-500, and avoid scratching or bumping it with hard objects.
7. To avoid fire and shock hazards, never place the PDP-500 or its bench directly on or over power cords of any type.
8. Never place objects on the PDP-500 power cord, or place the cord where it may be accidentally tripped over or stepped on.

PREPARATION

Check your power supply

Make sure that your local AC mains voltage matches the voltage specified on the name plate on the bottom panel. Make sure that the voltage selector is set for the voltage in your area.

The music stand

If you will be using sheet music with your PDP-500, raise the music stand built into its top panel by lifting the rear edge of the music stand until it clicks into place. The music stand can be lowered after slightly lifting the stand and pressing the two brackets which support it inward.

CONTENTS

PRECAUTIONS	1
PREPARATION	1
ASSEMBLY	2
CONTROLS & CONNECTORS	4
PLAYING THE PDP-500	6
<i>Using the Brilliance Control</i>	6
<i>Using the Digital Reverb Effects</i>	6
<i>Using the Pedals</i>	6
<i>Selecting a Separate Lower Keyboard Voice</i>	7
TRANSPPOSITION	8
PITCH CONTROL	8
RHYTHM	9
<i>The RHYTHM VOLUME Control</i>	9
<i>Selecting Rhythm Patterns</i>	9
<i>Starting and Stopping the Selected Rhythm</i>	9
<i>Tempo Control</i>	9
<i>Adding Fill-ins</i>	10
<i>SYNCHRO START Operation</i>	10
KEYBOARD PERCUSSION	10
PIANO ABC	11
<i>Single-finger Accompaniment</i>	11
<i>Fingered Accompaniment</i>	11
<i>Selecting Different Bass and Chord Voices</i>	12
<i>"Normal" Piano ABC Volume Balance</i>	12
SOLO STYLEPLAY	12
DISK ORCHESTRA	12
<i>Automatic Performance</i>	13
<i>Guided Right- and Left-Hand Practice</i>	14
<i>Phrase Repeat</i>	14
<i>Special Pedal Functions</i>	14
PERFORMANCE MEMORY	14
<i>Formatting a New Disk</i>	14
<i>Recording</i>	15
<i>Recording a New Track</i>	16
<i>Memory Capacity and Display</i>	16
<i>Playback</i>	16
<i>Copying Songs</i>	17
<i>Deleting a Song</i>	17
<i>Error Messages</i>	17
REGISTRATION MEMORY	17
<i>Memory Store</i>	17
<i>Recall</i>	17
MIDI FUNCTIONS	18
MIDI DATA FORMAT	21
TROUBLESHOOTING	22

FCC INFORMATION (U.S.A.)

1. IMPORTANT NOTICE: DO NOT MODIFY THIS UNIT!

This product, when installed as indicated in the instructions contained in this manual, meets FCC requirements. Modifications not expressly approved by Yamaha may void your authority, granted by the FCC, to use the product.

2. IMPORTANT: When connecting this product to accessories and/or another product use only high quality shielded cables. Cable/s supplied with this product MUST be used. Follow all installation instructions. Failure to follow instructions could void your FCC authorization to use this product in the USA.

3. NOTE: This product has been tested and found to comply with the requirements listed in FCC Regulations, Part 15 for Class "B" digital devices. Compliance with these requirements provides a reasonable level of assurance that your use of this product in a residential environment will not result in harmful interference with other electronic devices. This equipment generates/uses radio frequencies and, if not installed and used according to the instructions found in the users manual, may cause interference harmful to the operation of other electronic devices. Compliance with FCC regulations does not guarantee that interference will not occur in all installations. If this product is found to be the source of interference, which can be determined by turning the unit "OFF" and "ON", please try to eliminate the problem by using one of the following measures:

Relocate either this product or the device that is being affected by the interference.

Utilize power outlets that are on different branch (circuit breaker or fuse) circuits or install AC line filter/s.

In the case of radio or TV interference, relocate/reorient the antenna. If the antenna lead-in is 300 ohm ribbon lead, change the lead-in to co-axial type cable.

If these corrective measures do not produce satisfactory results, please contact the local retailer authorized to distribute this type of product. If you can not locate the appropriate retailer, please contact Yamaha Corporation of America, Electronic Service Division, 6600 Orangethorpe Ave, Buena Park, CA90620.

The above statements apply ONLY to those products distributed by Yamaha Corporation of America or its subsidiaries.

ASSEMBLY

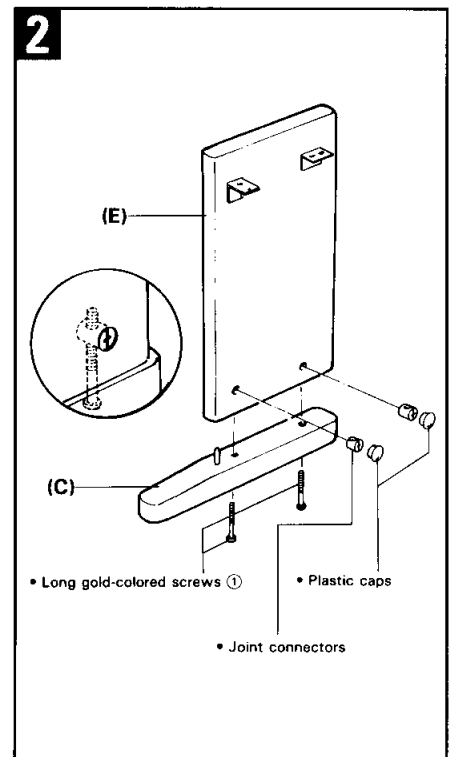
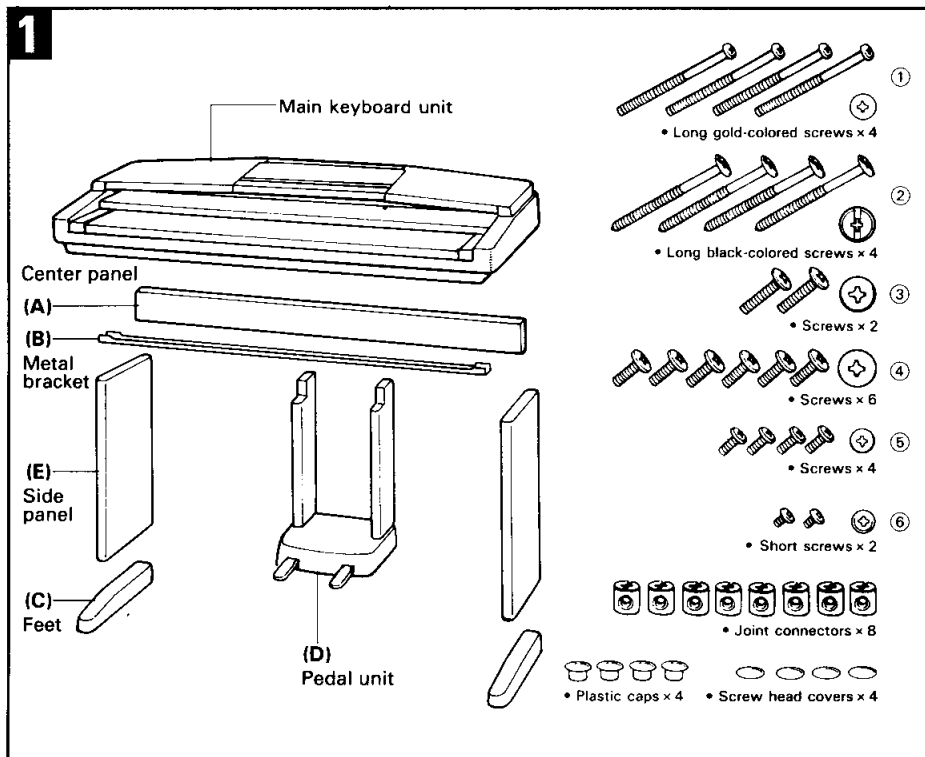

NOTE: We do not recommend attempting to assemble the PDP-500 alone. The job can be easily accomplished, however, with only two people.

1 Open the box and remove all the parts.

On opening the box you should find the parts shown in the illustration. Check to make sure that all the required parts are provided.

2 Assemble the side panels (E) and feet (C).

Install the joint connectors in side panels (E) as shown in the illustration, then secure the feet (C) to the side panels (E) with the long gold-colored screws ①. Once secure, push in the plastic caps provided.

* When installing the joint connectors in the holes in the side panels (E), make sure that they are rotated to the position shown in the illustration.

3 Attach the side panels (E) to the center panel (A).

Install four joint connectors in the holes provided in the center panel (A), and attach to the side panels (E) using the four long black-colored screws ② as shown in the illustration. Cover the screw heads with the screw head covers.

4 Attach the metal bracket (B) between side panels (E).

Attach the long black metal bracket (B) to the corresponding brackets on the side panels using two short screws ⑥, as shown in the illustration. The flanged edges of bracket (B) should face upwards.

5 Install the main keyboard unit.

As shown in the illustration, gently lower the main keyboard unit onto the stand assembly so that the two black plastic cones protruding from the bottom of the keyboard fit into the larger holes in the brackets near the rear edge of the side panels (E). Secure the main keyboard unit to the stand assembly using two screws ④ screwed through the rear brackets and two screws ③ through the front bracket.

* When disassembling the PBP-500 unscrew the black cones using a "+" (Phillips) screwdriver.

* Keep your fingers away from the area marked "Danger Zone" in the illustration when lowering the main keyboard unit onto the stand assembly.

6 Attach the pedal unit.

Before actually attaching the pedal unit (D), be sure to plug the pedal cord connector which is protruding from the top of the pedal unit into the corresponding connector in the bottom of the main keyboard unit. Once the pedal cord has been connected, align the pedal unit with the screw holes on the main unit and center panel (A), making sure that the slack section of pedal cord fits into the recess in the top of the pedal unit, and screw the four screws ⑤ into the center panel (A), and the four screws ④ into the main keyboard unit.

* Check to make sure that all screws have been securely tightened.

7 Be sure to set the pedal adjusters.

For stability, two adjusters are provided on the bottom of the pedal unit (D). Rotate the adjusters until they come in firm contact with the floor surface. The adjusters ensure stable pedal operation and facilitate pedal effect control.

* If the adjusters are not in firm contact with the floor surface, distorted sound may result.

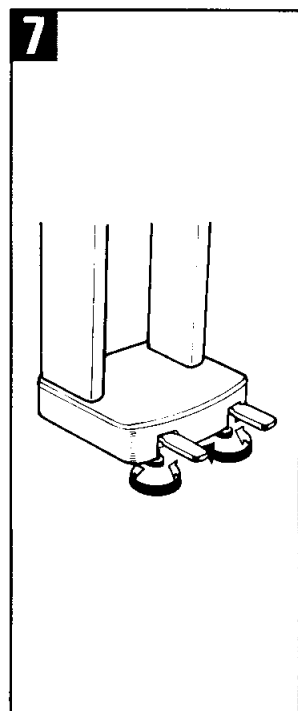
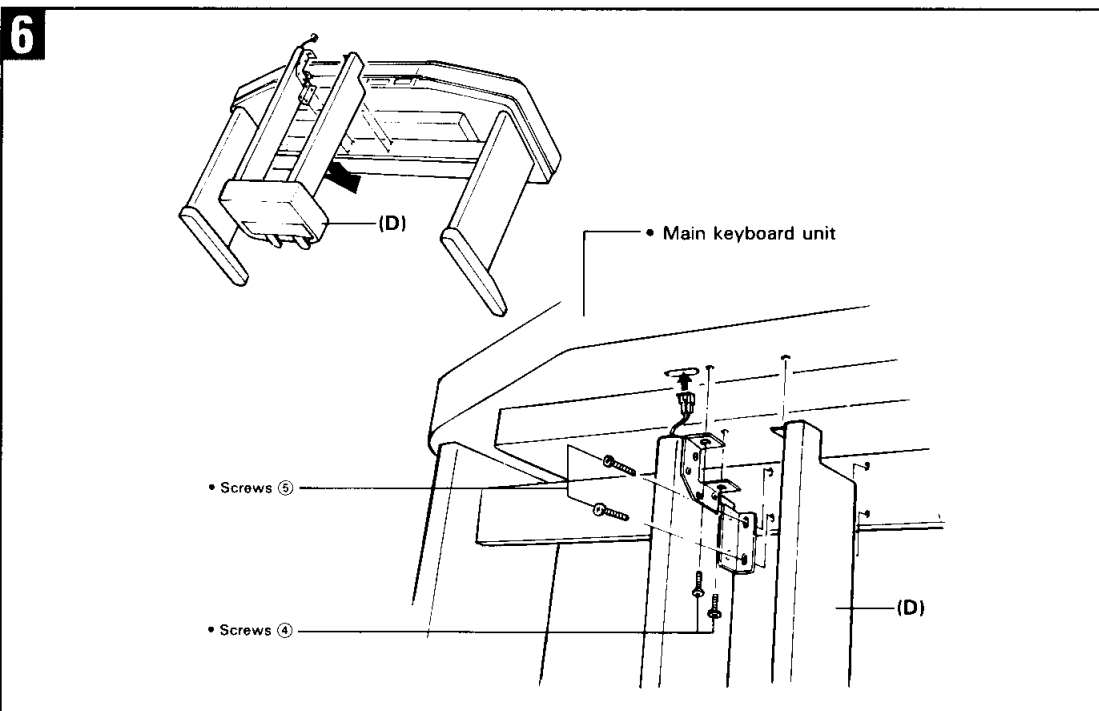
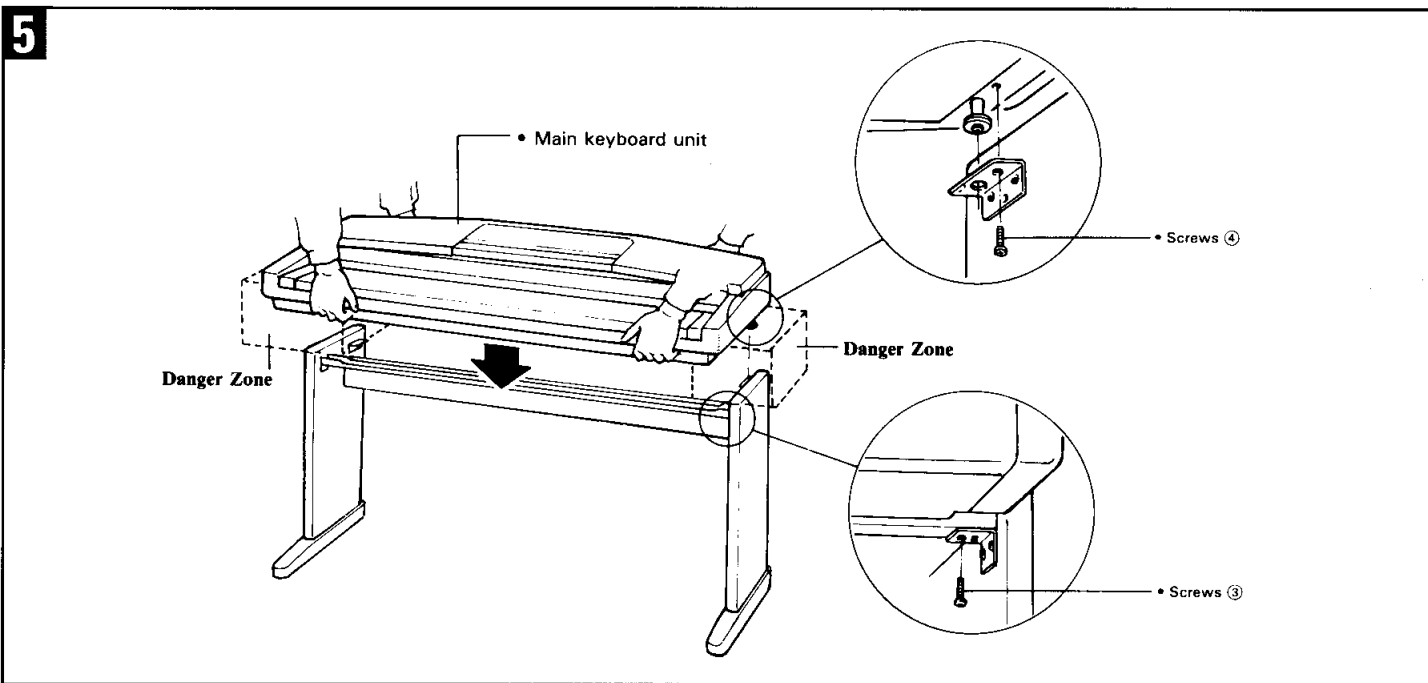
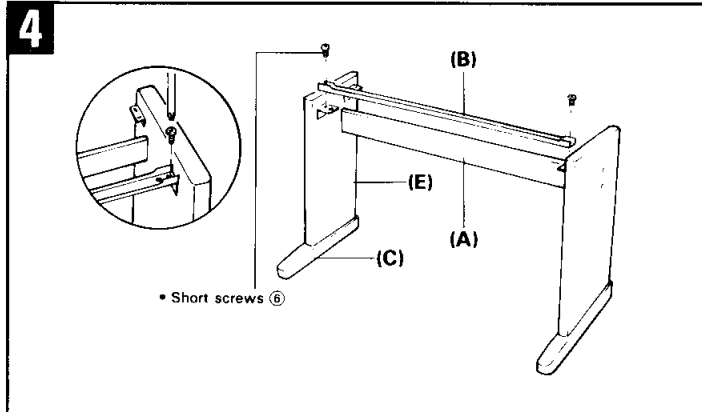
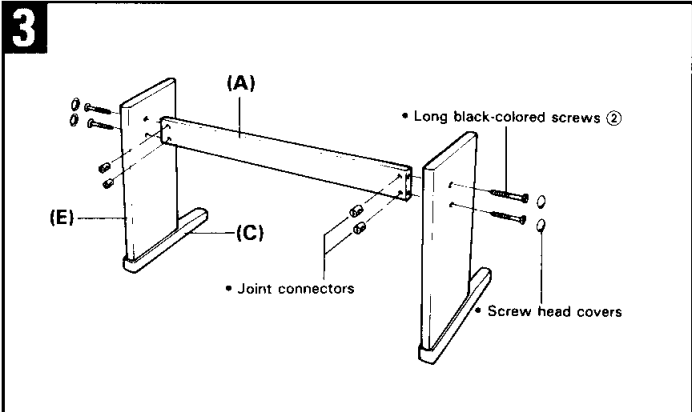

CONTROLS & CONNECTORS

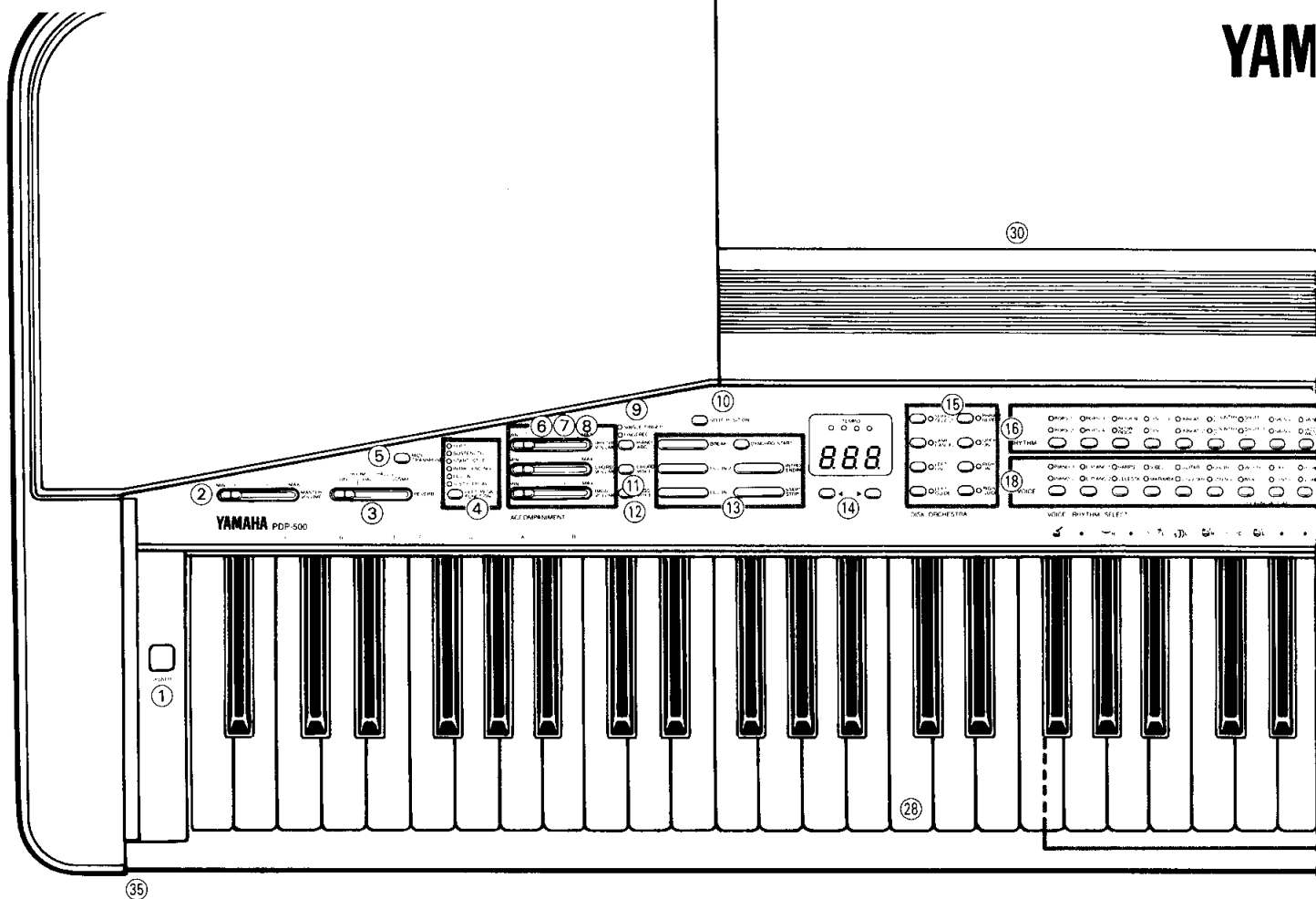

Control Panel

- ① POWER Switch [see page 6]
- ② MASTER VOLUME Control [see page 6]
- ③ REVERB Selector [see page 6]
- ④ LEFT PEDAL FUNCTION Button & Indicators ... [see page 7]
- ⑤ MIDI/TRANPOSE Button [see pages 8,18]
- ⑥ RHYTHM VOLUME Control [see pages 9,12]
- ⑦ CHORD VOLUME Control [see pages 11,12]
- ⑧ BASS VOLUME Control [see pages 11,12]
- ⑨ PIANO ABC Button & Indicators [see page 11]
- ⑩ SPLIT POSITION Button [see page 7]
- ⑪ CHORD VOICE Button [see page 12]
- ⑫ BASS VOICE Button [see page 12]
- ⑬ Rhythm Controls (START/STOP, SYNCHRO START, INTRO/ENDING, BREAK, FILL IN 1 and FILL IN 2 Buttons) [see page 9]
- ⑭ Beat/Tempo/Song Number Display & Buttons (< and >) [see pages 9,13,14]
- ⑮ DISK ORCHESTRA Controls (SONG SELECT, PHRASE REPEAT, LAMP CANCEL, ORCH ON, LEFT ON, RIGHT ON, LEFT GUIDE, RIGHT GUIDE Buttons) [see page 13]
- ⑯ Rhythm Selectors & Indicators [see page 9]
- ⑰ VARIATION Button [see page 9]
- ⑱ Voice Selectors & Indicators [see page 6]
- ⑲ LOWER VOICE Button [see page 7]
- ⑳ LOWER ON Button & Indicator [see page 7]
- ㉑ MANUAL VOLUME Control [see pages 7,12]
- ㉒ BRILLIANCE Control [see page 6]
- ㉓ 3.5" Disk Drive Unit [see page 13]
- ㉔ SOLO STYLEPLAY Selectors [see page 12]
- ㉕ REGISTRATION Buttons [see page 17]
- ㉖ Performance Memory Controls & Indicators (RECORD 1/2/3-10 and PLAYBACK 1/2/3-10) [see page 14]

- ㉗ DISC CONTROL Buttons (COPY, FORMAT) [see pages 14, 17]
- ㉘ Keyboard [see pages 7, 8, 11]
- ㉙ Keyboard Percussion Keys [see page 10]
- ㉚ Music Stand [see page 1]

Rear/Front Panel

- ㉛ OPTIONAL IN L/R and OUT L/R Jacks
The Optional Out jacks can be used to deliver the output of the PDP-500 to an external keyboard amplifier or stereo sound system. On the contrary, the Optional In jacks can be used to reproduce the output of another instrument such as cassette tape recorder through the PDP-500's built in speaker.

YAMAHA

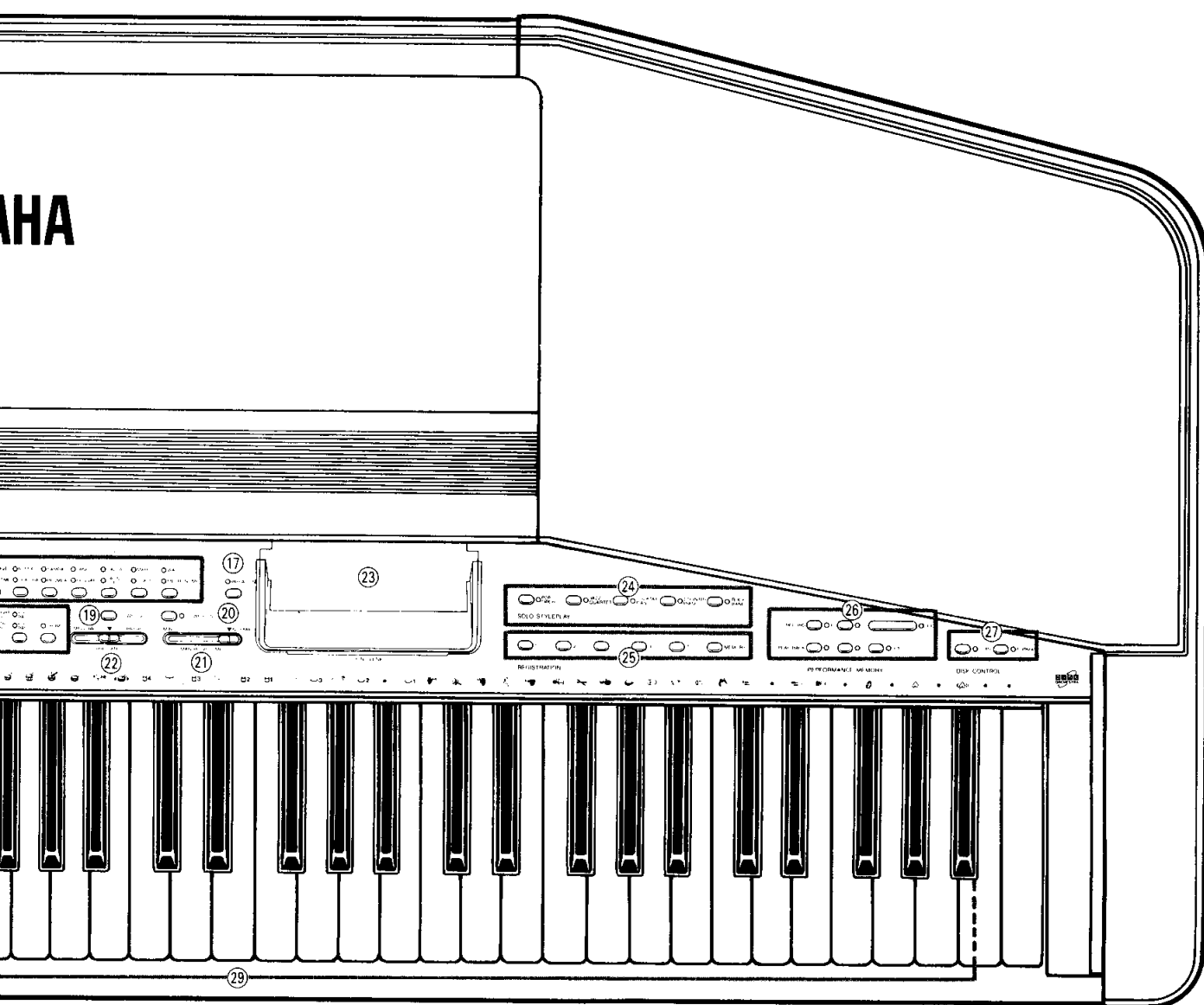

32 AUX OUT L/R Jacks

The AUX OUT L and R jacks deliver the output of the PDP-500 for connection to a stereo sound system, a mixing console or a tape recorder.

Note: The AUX OUT jack signal must never be returned to the OPTIONAL IN jacks, either directly or through external equipment.

33 MIDI IN, THRU and OUT Connectors

The MIDI IN connector receives MIDI data from an external MIDI device which can be used to control the PDP-500. The MIDI THRU connector re-transmits any data received at the MIDI IN connector, allowing "chaining" of several MIDI instruments or other devices. The MIDI OUT connector transmits MIDI data generated by the PDP-500.

More details on MIDI are given in "MIDI FUNCTIONS" on page 18.

34 EXPRESSION PEDAL Jack

An optional Yamaha EP-1 Expression Pedal can be connected to this jack to allow foot expression (swell) control.

35 HEADPHONE Jack

A standard pair of stereo headphones can be plugged in here for private practice or late-night playing. The internal speaker system is automatically shut off when a pair of headphones is plugged into the HEADPHONE jack.

Rear Panel

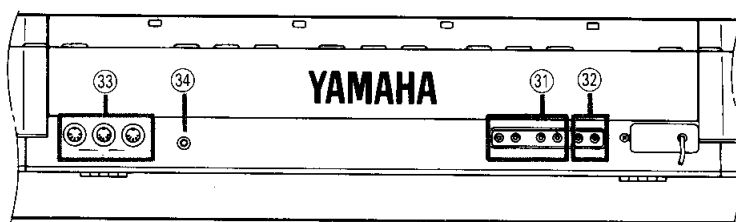

Internal

Stereo Amplifier & Speaker System

The PDP-500 features a powerful stereo amplifier delivering 30 watts per channel, driving a unique new Yamaha speaker system that puts out exceptionally rich sound with natural response from powerful lows to shimmering highs.

PLAYING THE PDP-500

After making sure that the PDP-500's AC plug is properly inserted into a convenient AC wall outlet:

1. Turn Power ON

Press the POWER switch located to the left of the keyboard to turn the power ON. When the power is turned ON, the PIANO 1 voice selector LED will light (the PIANO 1 voice is automatically selected whenever the power is turned ON). Press the POWER switch again when you want to turn the PDP-500 OFF.



2. Set Volume

Initially set the MASTER VOLUME control about three quarters of the way towards the "MAX" setting. Then, when you start playing, adjust the MASTER VOLUME control for the most comfortable listening level.

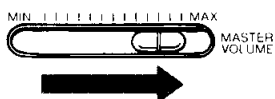

The MASTER VOLUME control adjusts the volume (level) of sound produced by the PDP-500. It also adjusts headphone volume when a pair of headphones is plugged into the HEADPHONE jack.

3. Select a Voice

Select the desired voice by pressing one of the voice selectors. The 22 PDP-500 voices are selected using 11 voice selectors. Note that each voice selector has two LED indicators and voice labels above it. The voices indicated by the upper and lower indicators are selected alternately each time the corresponding selector is pressed. For example, if the PIANO 1 voice is selected and you press the same selector a second time, the PIANO 2 voice will be selected. Each press on the PIANO 1/PIANO 2 selector alternately selects the PIANO 1 and PIANO 2 voices.

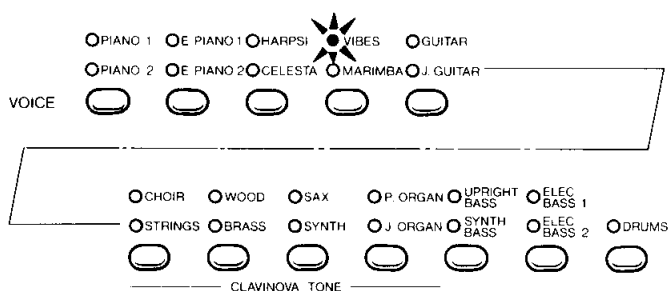

In this example the indicator LEDs show that the VIBES voice is selected.

4. Play

The PDP-500 offers 16-note polyphony. The PDP-500 also offers keyboard touch response, so the volume and timbre of notes played can be controlled according to how "hard" you play the keys. The amount of variation available depends on the selected voice.

Using the Brilliance Control

The BRILLIANCE control can be used to change the tonality or "timbre" of the selected voice. It has three settings: MELLOW, center (NORMAL) and BRIGHT. The center setting produces the "normal" tone of the selected voice. If you want a brighter or "sharper" tone, slide the control to the BRIGHT position. For a "rounder" more mellow tone, slide the control to the MELLOW position.

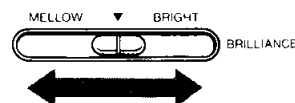

- The BRILLIANCE control has no intermediate settings. If you slide the control to a position between one of its three settings, the sound of the last setting will be retained.

Using the Digital Reverb Effects

The REVERB control provides a number of digital effects that you can use for extra depth and expressive power. Simply slide the REVERB control to the required position:

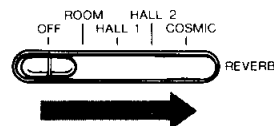

OFF

No effect is produced.

ROOM

This setting adds a reverb effect to the sound that is similar to the type of acoustic reverberation you would hear in a medium-size room.

HALL 1

For a more spacious reverb sound, use the HALL setting. This effect simulates the natural reverberation of a medium-size concert hall.

HALL 2

HALL 2 simulates the reverb of a very large concert hall.

COSMIC

"COSMIC" is an echo effect in which the sound seems to "bounce" around in the stereo sound field.

Using the Pedals

Right Pedal (Damper Pedal)

The damper pedal functions in the same way as a damper pedal on an acoustic piano. When the damper pedal is pressed notes played have a long sustain. Releasing the pedal immediately stops (damps) any sustained notes.

- When the keyboard is split (see "Selecting a Separate Lower Keyboard Voice" on page 7), the damper pedal affects only the upper section of the keyboard.

Left Pedal (Multi-function)

The left pedal has a number of functions which can be selected using the LEFT PEDAL FUNCTION button and indicators. Each time the LEFT PEDAL FUNCTION button is pressed the next function on the LEFT PEDAL function "list" is selected and the corresponding indicator will light. The SOFT and SOSTENUTO functions are described below. For details on the START/STOP, INTRO/ENDING and FILL IN functions refer to the "RHYTHM" section on page 9. For details on the S.STYLEPLAY function see "SOLO STYLEPLAY" on page 12 (the S.STYLEPLAY pedal function can only be selected when the SOLO STYLE PLAY feature is in use).

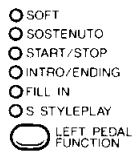

SOFT Pedal

Pressing the soft pedal reduces the volume and slightly changes the timbre of notes played. The SOFT left-pedal function is automatically selected when the power is initially turned on.

SOSTENUTO Pedal

If you play a note or chord on the keyboard and press the sostenuto pedal while the note(s) are held, those notes will be sustained as long as the pedal is held (as if the damper pedal had been pressed) but all subsequently played notes will not be sustained. This makes it possible to sustain a chord, for example, while other notes are played "staccato."

Selecting a Separate Lower Keyboard Voice

The PDP-500 allows you to play two voices at once—one with the left hand and one with the right. The lower voice can be played on the lowest keys, up to the "split position" set using the SPLIT POSITION button.

1. Press the LOWER ON Button

This turns the LOWER VOICE ON and automatically selects STRINGS as the lower voice.

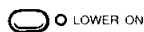

2. Set the Split Position

Hold down the SPLIT POSITION button and press the key on the PDP-500 keyboard at which you want the split position to be set. The split position is now set, and you can release the SPLIT POSITION button and key. If you do not specifically select a split position, the split position is automatically set to F#2. An LED indicator will light above the selected split position key.

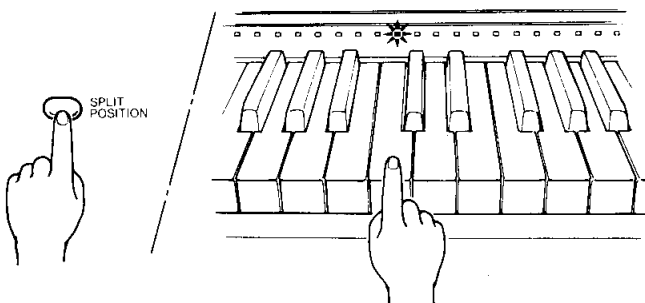

3. Select the LOWER VOICE

Press and hold the LOWER VOICE button while selecting a voice in the normal way.

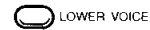

4. Adjust the MANUAL VOLUME Control

The MANUAL VOLUME control is used to adjust the volume of the melody voice in relation to the lower voice. At the "NORMAL" position maximum melody voice volume is produced. By sliding the MANUAL VOLUME control toward the MIN position, the volume of the melody voice can be reduced in relation to the lower voice.

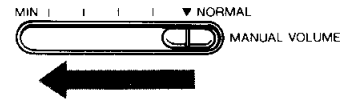

- The SPLIT POSITION can be changed at any time while the LOWER VOICE is ON.
- A lower voice cannot be assigned when the SOLO STYLEPLAY function is in use.
- When LOWER ON is selected, lower voices other than the four bass voices will be transposed up one octave.

TRANSPOSITION

The PDP-500's TRANSPOSE function makes it possible to shift the pitch of the entire keyboard up or down in semitone intervals up to a maximum of six semitones. "Transposing" the pitch of the PDP-500 keyboard makes it easier to play in difficult key signatures, and you can simply match the pitch of the keyboard to the range of a singer or other instrumentalist. The MIDI/TRANSPOSE button is used in conjunction with the ◀ and ▶ buttons (below the tempo display) for transposition.



1. Press and hold the MIDI/TRANSPOSE button.
2. Press either the ◀ or ▶ button, according to the desired direction of transposition (◀ transposes down and ▶ transposes up). The pitch is transposed by one semitone (100 cents) each time the ◀ or ▶ button is pressed.*
3. Release the MIDI/TRANSPOSE button.

The amount of transposition selected is shown on the Beat/Tempo/Song Number display as follows:

Display	Transposition	Display	Transposition
-6	-6 semitones	1	+1 semitone
-5	-5 semitones	2	+2 semitones
-4	-4 semitones	3	+3 semitones
-3	-3 semitones	4	+4 semitones
-2	-2 semitones	5	+5 semitones
-1	-1 semitone	6	+6 semitones

* Pressing the ◀ and ▶ buttons simultaneously while holding the MIDI/TRANSPOSE button produces normal keyboard pitch.

PITCH CONTROL

Pitch control makes it possible to tune the PDP-500 over a ± 50 -cent range in approximately 3-cent intervals. A hundred "cents" equals one semitone, so the tuning range provided allows fine tuning of overall pitch over a range of approximately a semitone. Tuning values are shown on the Beat/Tempo/Song Number display in Hertz (cycles per second), where the standard "concert pitch" of the A₃ key is 440 Hertz. The tuning range of the A₃ key is from 427 to 452 Hertz. Pitch control is useful for tuning the PDP-500 to match other instruments or recorded music.

Tuning Up

1. To tune up (raise pitch), hold the A-1 and B-1 keys simultaneously (A-1 and B-1 are the two lowest white keys on the keyboard).
2. Press any key between C₃ and B₃. Each time a key in this range is pressed the pitch is increased by approximately 3 cents, up to a maximum of 50 cents above standard pitch.
3. Release the A-1 and B-1 keys.

Tuning Down

1. To tune down (lower pitch), hold the A-1 and A[#]-1 keys simultaneously.
2. Press any key between C₃ and B₃. Each time a key in this range is pressed the pitch is decreased by approximately 3 cents, up to a maximum of 50 cents below standard pitch.
3. Release the A-1 and A[#]-1 keys.

To Restore Standard Pitch*

1. To restore standard pitch (A₃=440 Hz), hold the A-1, A[#]-1 and B-1 keys simultaneously.
2. Press any key between C₃ and B₃.
3. Release the A-1, A[#]-1 and B-1 keys.

* Standard pitch (A₃=440 Hz) is automatically set whenever the POWER switch is initially turned ON.

- The pitch control function has no effect when the ABC mode is active or the keyboard is split (i.e. LOWER VOICE ON).

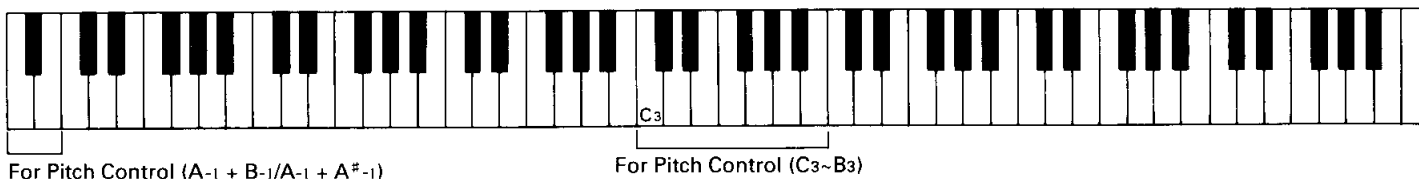

RHYTHM

The RHYTHM VOLUME Control

Begin by setting the RHYTHM VOLUME control to a position about three-quarters of the way toward the "MAX" end of the scale. Then, when you actually begin playing the rhythm, you can set the best VOLUME control level "by ear."

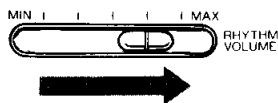

Selecting Rhythm Patterns

The 32 rhythm patterns are selected using 16 rhythm selectors. Note that each rhythm selector has two LEDs and rhythm labels above it. The rhythm patterns indicated by the upper and lower labels are selected alternately each time the corresponding selector is pressed. For example, if the DISCO 1 rhythm is selected and you press the same selector a second time, the DISCO 2 rhythm will be selected. Each press on the DISCO 1 / DISCO 2 selector alternately selects the DISCO 1 and DISCO 2 rhythm patterns.

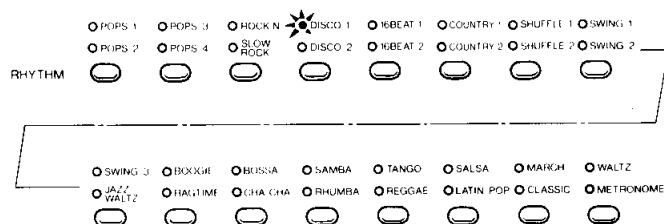

In this example the indicator LEDs show that the DISCO 1 rhythm is selected.

Each rhythm pattern also has a variation which can be selected by pressing the VARIATION button. When the VARIATION button LED is off, the standard rhythm pattern will play, and when the VARIATION LED is on, the variation will play.



- The POPS 1 rhythm is automatically selected when the power is initially turned ON.

Starting and Stopping the Selected Rhythm

Using the START/STOP Button

The most straightforward way to start and stop the selected rhythm is to use the START/STOP button. Simply press the START/STOP button to start the rhythm, then press the START/STOP button again when you want to stop the rhythm. Different rhythms can be selected at any time during playback.



- If the left pedal is switched to START/STOP operation, it performs the same function as the panel START/STOP button (press to START, press again to STOP).

Using the INTRO/ENDING Button

This button can be used to both start and stop the selected rhythm, with a little more "style" than the START/STOP button provides. If you press the INTRO/ENDING button while rhythm playback is stopped, the selected rhythm will start after an appropriate 2-measure introduction. When you're ready to end rhythm, press the INTRO/ENDING button again—the PDP-500 will create an appropriate 2-measure rhythmic ending for the currently selected rhythm pattern.

If you press the INTRO/ENDING button during the first half of a measure, the ending pattern will begin during that measure. If you press the INTRO/ENDING button during the second half of a measure, the ending pattern will begin on the first beat of the next measure.

Rhythm playback started by pressing the START/STOP button can be ended by pressing the INTRO/ENDING button. In the same way, rhythm playback started by pressing the INTRO/ENDING button can be ended at any time by pressing the START/STOP button.

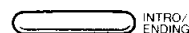

- If the left pedal is switched to INTRO/ENDING operation, it performs the same function as the panel INTRO/ENDING button.
- Only the metronome sound will be produced if the INTRO/ENDING button is used to start the METRONOME rhythm. No change in the METRONOME rhythm occurs if the INTRO/ENDING button is used to stop the rhythm.

Tempo Control

The ◀ and ▶ buttons located below the Beat/Tempo/Song Number display can be used to modify the tempo of the selected rhythm. Tempo can be varied from 32 beats per minute up to 280 beats per minute. When the power is initially turned ON a tempo of 120 is automatically selected. A "normal" tempo for the currently selected rhythm can be recalled by pressing the tempo ◀ and ▶ buttons simultaneously. The set tempo does not change when switching between different rhythms.

Pressing the ◀ button decreases the tempo, while pressing the ▶ button increases the tempo. Holding either of these buttons down causes a continuous increase or decrease in the tempo setting. The current tempo setting is displayed on the Beat/Tempo/Song Number display while either the ◀ or ▶ button is pressed during rhythm playback, and the display reverts to measure number display about one second after either the ◀ or ▶ button is released. The tempo setting is also displayed, and can be changed, while rhythm playback is stopped.

- The beat indicators at the top of the Beat/Tempo display flash in sequence to indicate the current beat. The leftmost indicator flashes on the first beat of each measure, the second indicator flashes on the second beat, and so on. When a 3/4-time rhythm is selected, only the first three beat indicators will flash.

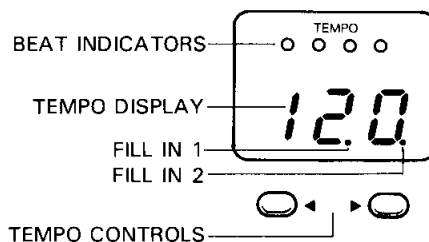

Adding Fill-ins

Simply touch the FILL IN 1 or FILL IN 2 button at any time during rhythm playback to insert a rhythm variation that lasts until the end of the current measure. If the FILL IN button is pressed at the end of the last beat of a measure, however, the fill in will start at the next measure. The fill-in can be terminated at any time during the same measure by pressing the FILL IN button a second time. For example, if you press FILL IN on the first beat of a measure and then again on the third beat, the fill-in will last from the first until the third beat of the measure. Further, the selected fill-in pattern will play as long as the FILL IN button is held.

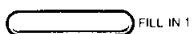
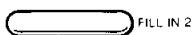

Fill-in Start

You can start a rhythm pattern with a fill-in on the very first measure by first pressing either of the FILL IN buttons while rhythm playback is stopped, and then pressing the START/STOP button. If FILL IN 1 button is pressed (while rhythm playback is stopped), the second LED dot from the left at the bottom of the Beat/Tempo/Song Number display will light, and if FILL IN 2 button is pressed, the third LED dot will light, indicating that the first measure of the rhythm pattern will be the selected fill-in.

- If the left pedal is switched to FILL IN operation, it performs the same function as the panel FILL IN buttons. FILL IN 1 or FILL IN 2 can be assigned to the left pedal by pressing the left pedal while holding the desired FILL IN button. FILL IN 1 is automatically selected if no fill in is specifically assigned.
- The FILL IN buttons produce no change in the METRONOME rhythm.
- The LATIN POP FILL IN 2 variation (i.e. the fill in produced when the VARIATION button LED is lit) and the 16 BEAT FILL IN 2 variation are one-measure breaks.

Break

Pressing the BREAK button during the rhythm playback temporarily mutes the rhythm (for one measure). The rhythm automatically starts again at the beginning of next measure.

SYNCHRO START Operation

This function causes the selected rhythm to be started automatically when you play the first note on your keyboard, thus synchronizing the beginning of the rhythm to your performance. After selecting the desired rhythm, press the SYNCHRO START button. The first LED of the Beat Display will begin to flash, indicating that the SYNCHRO START mode is READY. Then, as soon as you play a key on your keyboard (on the lower keyboard when ABC is active or the keyboard is split), playback of the selected rhythm will begin.



You can have the rhythm begin with a fill-in in the SYNCHRO START mode by pressing the SYNCHRO START button and then the FILL IN buttons before playing on the keyboard.

KEYBOARD PERCUSSION

This function allows you to directly play a range of different percussion instruments on the highest notes of the keyboard. Simply press the DRUMS button (the DRUMS indicator will light), and play the appropriate keys. The percussion instruments played by the various keys are marked by symbols above the keys.

DRUMS



PERCUSSION INSTRUMENT/KEY ASSIGNMENTS

Key	Instrument
F#2	BRUSH ROLL
G#2	HI-HAT CLOSED HEAVY
A#2	CRASH CYMBAL LIGHT
B2	BASS DRUM LIGHT
C3	SNARE DRUM + RIM HEAVY
C#3	RIDE CYMBAL CUP
D3	SNARE DRUM + RIM LIGHT
F3	BASS DRUM
F#3	RIM SHOT
G3	SNARE DRUM HEAVY
G#3	BRUSH SHOT
A3	SNARE DRUM LIGHT
A#3	HI-HAT PEDAL
B3	SNARE DRUM ECHO
C4	TOM 4
C#4	HI-HAT CLOSED
D4	TOM 3
D#4	HI-HAT OPEN
E4	TOM 2
F4	TOM 1
F#4	RIDE CYMBAL
G4	ELECTRONIC TOM 3
G#4	CRASH CYMBAL
A4	ELECTRONIC TOM 2
B4	ELECTRONIC TOM 1
C5	CONGA LOW
C#5	CABASA
D5	CONGA HIGH
D#5	METRONOME
E5	BONGO
F5	TIMBALE LOW
F#5	CLAVES
G5	TIMBALE HIGH
G#5	CASTANETS
A5	CUICA LOW
A#5	COWBELL
B5	CUICA HIGH
C6	HAND CLAPS
C#6	AGOGO LOW
D#6	AGOGO HIGH
E6	BONGO LOW
F#6	TAMBOURINE
G#6	TRIANGLE CLOSED
A#6	TRIANGLE OPEN

- When Keyboard Percussion is in use, notes to the left of F#2 will not sound unless the LOWER VOICE or PIANO ABC feature is used. In this case, notes between the selected SPLIT POSITION and F#2 will not sound if the SPLIT POSITION is set at a key lower than F#2.

PIANO ABC

The PDP-500 includes a sophisticated auto-accompaniment system that can provide automated rhythm, bass and chord backing in a number of ways.

- Although the PDP-500 has 16-note polyphony, the total number of notes that can be played simultaneously is actually less when the PIANO ABC feature is used.

Single-finger Accompaniment

SINGLE FINGER accompaniment makes it simple to produce accompaniment using major, seventh, minor and minor-seventh chords by pressing a minimum number of keys in the Auto Accompaniment section of the keyboard. The automatic accompaniment consists of rhythm, bass and chords.

1. Select the SINGLE FINGER Mode

Press the PIANO ABC button to select the SINGLE FINGER mode (the SINGLE FINGER indicator will light).



2. Select a Rhythm

Select the desired rhythm pattern (except METRONOME) using the rhythm selectors.

3. Press a Key in the Lower Keyboard

Pressing any key on the lower keyboard (up to the selected SPLIT POSITION) will cause the automatic chord and bass accompaniment to begin. If you press a "C" key, for example, a C-major accompaniment will be played. Press another key in the Auto Accompaniment Keys section to select a new chord. The key you press will always determine the "root" of the chord played (i.e. "C" for a C chord).

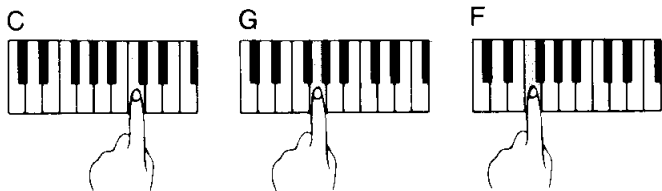

Playing Minor, Seventh, and Minor-seventh Chords in the Single-finger Mode

- For a minor chord, press the root key and the first black key to its left.

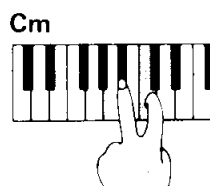

- For a seventh chord, press the root key and the next white key to its left.

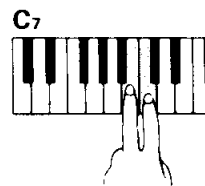

- For a minor-seventh chord, press the root key and both the next white and black keys to its left.

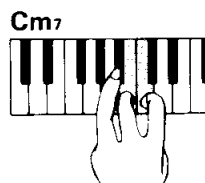

4. Adjust the BASS VOLUME and CHORD VOLUME Controls

Set the ideal balance between the bass and chord volume using these controls.

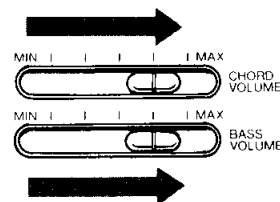

5. Set the Tempo

Use the ◀ and ▶ tempo controls to set the desired accompaniment tempo (see "Tempo Control" on page 9 for more details).

6. Stop the Auto Accompaniment

Press the START/STOP button to stop the Auto Accompaniment.

Fingered Accompaniment

The FINGERED mode is ideal if you already know how to play chords on a keyboard, since it allows you to supply your own chords for the Auto Accompaniment feature.

1. Select the FINGERED Mode

Press the PIANO ABC button to select the FINGERED mode (the FINGERED indicator will light).



2. Select a Rhythm

Select the desired rhythm pattern (except METRONOME) using the rhythm selectors.

3. Play a Chord on the Lower Keyboard

As soon as you play any chord on the lower keyboard (up to the selected SPLIT POSITION button), the PDP-500 will automatically begin to play the chord along with the selected rhythm and an appropriate bass line.

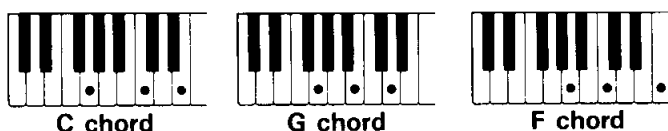

The PDP-500 will accept the following chord types:

- Major
- Minor
- Major seventh
- Sixth
- Minor sixth
- Minor seventh
- Minor seventh flat five
- Seventh
- Seventh flat five
- Seventh suspended fourth
- Suspended fourth
- Augmented
- Diminished

• The INTRO/ENDING and FILL IN buttons can be used in the PIANO ABC mode to create pattern variations in exactly the same way that they are used with rhythm patterns (refer to the "RHYTHM" section on page 9 for details).

• The LATIN POP FILL IN 2 variation (i.e. the fill in produced when the VARIATION button LED is lit) and the 16 BEAT FILL IN 2 variation are one-measure breaks (no ABC sound will be produced).

Selecting Different Bass and Chord Voices

The bass and chord voices used for PIANO ABC accompaniment can be changed by selecting the desired voice in the normal way while holding either the BASS VOICE or CHORD VOICE button, as required. The current bass or chord voice can be confirmed by simply pressing the BASS VOICE or CHORD VOICE button (the appropriate voice indicator will light as long as the button is held).



"Normal" Piano ABC Volume Balance

Although the ideal balance between the melody, rhythm, chord and bass volume depends on your personal preferences, the following settings provide a "normal balance" reference point.

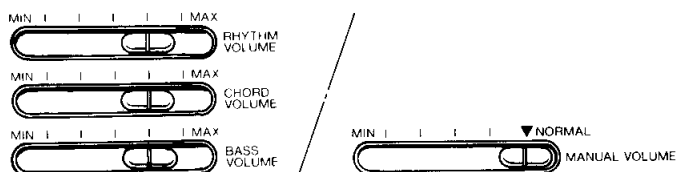

SOLO STYLEPLAY

This sophisticated feature automatically adds appropriate harmony notes and effects to a melody you play on the upper keyboard according to the selected accompaniment style.

- Only a single note can be played at a time on the upper keyboard section when the SOLO STYLEPLAY feature is used.

1. Select the Desired SOLO STYLEPLAY Style

Press the SOLO STYLEPLAY button corresponding to the desired style. The LED of the selected style button will light indicating that the SOLO STYLEPLAY feature is ON. The SINGLE FINGER Auto Bass Chord mode will be automatically selected when one of the SOLO STYLEPLAY buttons is pressed. If you want to use the FINGERED mode instead of the SINGLE FINGER mode, select it using the PIANO ABC button.



SOLO STYLEPLAY

2. Play

The SYNCHRO START mode is automatically selected when a SOLO STYLEPLAY style is selected, so all you have to do is play the required chords (SINGLE FINGER or FINGERED) on the lower keyboard while playing a single-note melody line on the upper keyboard. The SOLO STYLEPLAY feature automatically selects the appropriate rhythm pattern as well as chord and bass voices for the style you select.

3. Stop the Accompaniment

Stop the accompaniment using the STOP or INTRO/ENDING button (and turn SOLO STYLEPLAY OFF, if necessary, by pressing the SOLO STYLEPLAY button again so that its LED goes out).

- PIANO ABC cannot be turned OFF while any of the SOLO STYLEPLAY styles is selected.

DISK ORCHESTRA

Using special DISK ORCHESTRA disks (available from Yamaha), the PDP-500 will let you enjoy listening to automated performances, or function as your "private music tutor," allowing you to practice various parts of a piece while the others are played automatically. The PDP-500 even shows you which keys to play with guide lamps that light up above each key.

- In addition to Disk Orchestra Collection disks, the following disks can be played back.

* Some Yamaha Disklavier disks (PianoSoft) — refer to the Yamaha Disk Orchestra Collection catalogue for details.

Automatic Performance

1. Load the Disk

Insert the DISK ORCHESTRA disk into the disk drive with the metallic door facing the drive slot and the label side facing upward. The disk should click into place and the disk lamp will light briefly while the PDP-500 reads and identifies the disk.

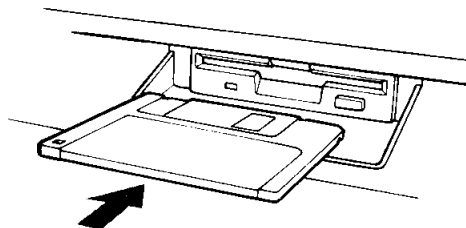

2. Select the Desired Song

Press the SONG SELECT button to activate the DISK ORCHESTRA mode. When this is done the SONG SELECT, RIGHT ON, LEFT ON and ORCHESTRA ON indicators will light, and the Beat/Tempo/Song Number display will function as the song number display. Use the ◀ and ▶ buttons below the display to select the desired song number. If you select song number "0" all songs on the disk will be played and repeated until playback is stopped.

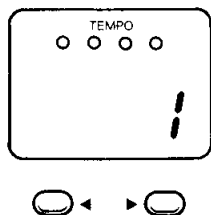

3. Begin Playback

Start playback of the selected song by pressing either the START/STOP button or the INTRO/ENDING button. Unless song number "0" is selected, the selected song will play through to the end and playback will stop automatically. Playback can be stopped at any time by pressing the START/STOP button.

- Please note that playback cannot be started while the leftmost dot in the display is lit.

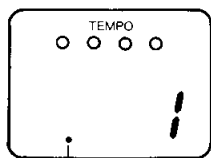

PLAYBACK WILL NOT START WHILE THIS DOT IS LIT (SEARCHING FOR SELECTED SONG).

4. Playing Back only Specific Parts

The LEFT ON, RIGHT ON and ORCHESTRA ON buttons can be used to select playback of specific parts. The LEFT ON button turns the left-hand part on or off, the RIGHT ON button turns the right-hand part on or off, and the ORCHESTRA ON button turns the ORCHESTRA part on or off. When a part is ON, the corresponding LED indicator lights. Use the LEFT ON, RIGHT ON and ORCHESTRA ON buttons to select the parts you want to play back. You can, for example, turn OFF a part you want to practice on the keyboard. When a part is turned ON, the guide lamps for that part are turned OFF, and when a part is turned OFF, the guide lamps for that part are turned ON and will appear above the keyboard.



- In some Disk Orchestra Collection and Disklavier (PianoSoft) disks, both the left and right-hand piano parts are recorded together on the right track. In such a case the left track cannot be turned ON.
- Use the MANUAL VOLUME control to adjust the volume of the right-hand part in relation to the left-hand part, the CHORD VOLUME control to adjust the level of the orchestra sound, and the RHYTHM VOLUME control to adjust the volume of the rhythm part if one is included.

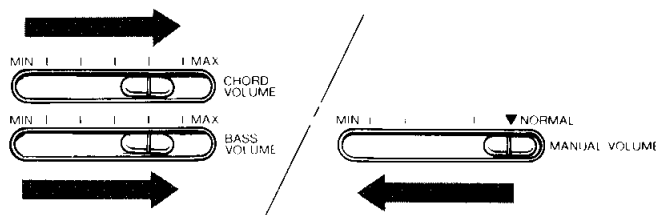

5. Cancel the Guide Lamps if Desired

If the guide lamps flashing above the keyboard distract you, or you want to try playing along without them, simply press the LAMP CANCEL button causing its indicator LED to light. Press the LAMP CANCEL button again (its indicator will go out) when you want to see the guide lamps.



6. Remove the Disk

When you've finished with the currently loaded disk, simply press the disk drive EJECT button to remove it.

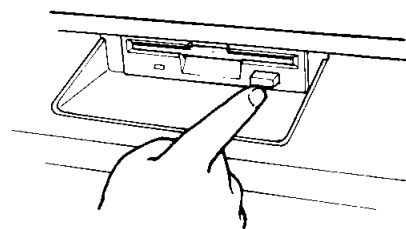

CAUTION: NEVER eject a disk or turn the power off while:
1) the disk drive lamp is ON.
2) the DISK ORCHESTRA function is playing.

- The positions of the guide lamps do not change if the transpose function is used to transpose the pitch of the keyboard.
- Some Disk Orchestra software does not produce a tempo display (e.g. free-tempo phrases, etc.). In this case, three lit bars appear along the bottom of the tempo display area.

Guided Right- and Left-hand Practice

With this feature, the PDP-500 waits for you to play the appropriate keys before playing ahead, so you can learn to play the piece at your own pace. To practice the right-hand part, for example, press the RIGHT GUIDE button (its indicator LED will light) before starting playback. When you press the START/STOP button to begin playback, the introduction will play automatically but then the PDP-500 will stop and wait for you to play the key(s) indicated by the guide lamps above the keyboard. As you play the indicated keys, the piece will continue, pausing until you play the right keys each time. You can practice the left-hand part using the LEFT GUIDE button in the same way. As with automated performance, the song will stop automatically when the end is reached, or it can be stopped at any time by pressing the START/STOP button.

- Disk Orchestra playback tempo can be set to any desired value after a song has been selected by using the ◀ and ▶ buttons while holding the SPLIT POSITION button.

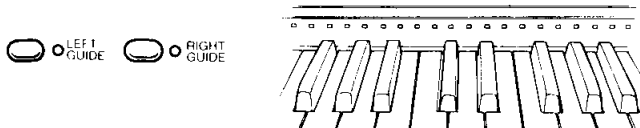

Phrase Repeat

Use this function if you want to practice a specific phrase within a song.

1. Select the Desired Song

Press the SONG SELECT button and select the desired song as described in "Automatic Performance," above.

2. Select the Desired Phrase

Press the PHRASE REPEAT button (its LED indicator will light). When this is done the Beat/Tempo/Song Number display will function as the phrase number display. Use the ◀ and ▶ buttons below the display to select the desired phrase number (refer to the DISK MUSIC BOOK that comes with the Disk Orchestra Collection disk).



3. Start Playback

Press the START/STOP button to begin playback of the selected phrase. Phrase playback will repeat until the START/STOP button is pressed a second time.

Special Pedal Functions

Pause/Continue

If the left pedal is set for START/STOP operation using the LEFT PEDAL FUNCTION button, and RIGHT GUIDE and LEFT GUIDE are both OFF, the left pedal functions as a pause/continue control: press once to pause, and again to continue from the same point.

Pause/Cue

If the left pedal is set for INTRO/ENDING operation using the LEFT PEDAL FUNCTION button, and RIGHT GUIDE and LEFT GUIDE are both OFF, the left pedal functions as a pause/cue control: press once to pause, and again to continue from the beginning of the next phrase (refer to the DISK MUSIC BOOK that comes with the Disk Orchestra Collection disk for phrase locations). There may be a slight delay after the pedal is pressed to "cue" to the beginning of the next phrase.

- The tempo display may not be accurate after the Pause/Continue or Pause/Cue function is used.

PERFORMANCE MEMORY

The PDP-500 features a built-in "sequencer" which can be used to independently record up to ten separate parts of a single musical composition. The Performance Memory has three RECORD and three PLAYBACK buttons, corresponding to track 1, track 2, and tracks 3 through 10. The music data that you record is stored on a 3.5" floppy disk loaded into the PDP-500's disk drive unit. Before you can record, however, you must "format" a new disk, as described below.

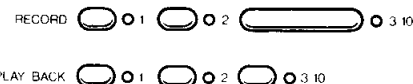

Formatting a New Disk

The PDP-500 uses only 3.5" 2DD 9-sector format type floppy disks. We recommend that you use Yamaha 2DD disks. Before you can use a new disk for recording, the disk must be "formatted" so that the PDP-500 can recognize it and correctly write the music data onto it.

1. Insert the New Blank Disk

Make sure that the disk's write protect tab is set to the "write" position (tab closed), and insert the new disk into the disc drive unit with the metallic door facing the drive slot and the label side of the disk facing upward. The disk should click securely into place, and the disk drive lamp should light briefly.

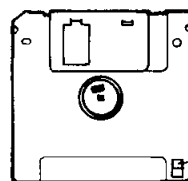

Write Protect tab

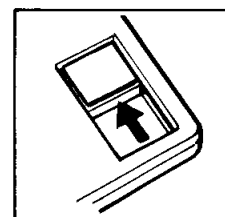

Write Protect OFF

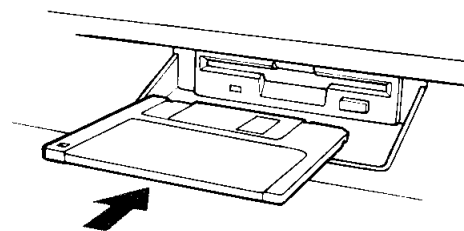

2. Press the DISK CONTROL FORMAT Button

The FORMAT button LED will light.



3. Confirm the Format Operation

Use the Tempo ◀ and ▶ buttons to select either "Y" (YES) or "N" (NO) on the display. "Y" if you intend to execute the format operation or "N" if you wish to cancel the operation. This step is necessary because formatting completely erases any data that is already on the disk—make sure that the disk you're about to format does not contain any important data!

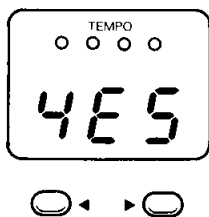

4. Begin Formatting

Press the **FORMAT** button again and formatting will begin. The number of each "track" on the disk will be shown on the display as the format process continues. When formatting is complete (the Beat/Tempo/Song Number display will revert to the normal tempo display), you can go ahead and record.

- The format operation can be aborted at any time by pressing the **START/STOP** button. In this case, the disk will only be partly formatted and will have to be properly formatted again before use.
- When using the floppy disk format function, a write protect error (Er 2) will be generated with the following three disk types regardless of the disk's write protect status. This has been done to ensure that the music software cannot be accidentally erased.
 1. YAMAHA Disklavier software (PianoSoft).
 2. Disks formatted on the YAMAHA Disklavier.
 3. Disk Orchestra Collection.

Recording

1. Load Formatted Disk

If you haven't already done so, make sure that a properly formatted disk is loaded into the disk drive, and that the disk's write protect tab is set to the "write" position (tab closed).

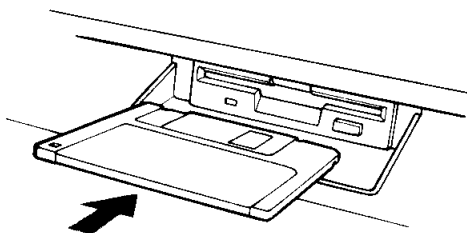

2. Select a Song Number

Press the **SONG SELECT** button and select a **SONG NUMBER** between 1 and 60 for the piece you are about to record (up to 60 different songs, each with a different song number, can be recorded on a single disk). Make sure the song number you select has not already been used for a song previously recorded on the disk you are using.

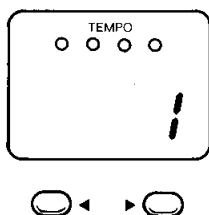

3. Press One of the RECORD Buttons

Only one track can be recorded at a time. If you press **RECORD 1** you will record on track number 1. If you press **RECORD 2** you will record on track number 2. If you press **RECORD 3**, you can choose to record on track 3, 4, 5, 6, 7, 8, 9, or 10 by selecting the desired track number using the ◀ and ▶ buttons below the Beat/Tempo/Song Number display while holding the **RECORD 3-10** button (the selected track number will appear on the Beat/Tempo/Song Number display).

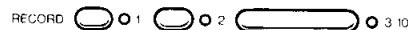

4. Select a Voice

Select a voice (and a **LOWER VOICE** is desired) in the normal way.

5. Select the Required Performance Features, Tempo, etc.

The Performance Memory feature is capable of recording rhythms or **PIANO ABC** accompaniment with any bass and chord voices you select. If you want to record without rhythm accompaniment, turn the **RHYTHM VOLUME** control all the way down. Set a tempo at which you can comfortably record the piece. The tempo can be confirmed visually by watching the flashing beat indicator.

- If you intend to use **PIANO ABC** and/or a **LOWER VOICE**, the necessary **ABC** and **LOWER** functions must be selected after pressing the desired **RECORD** button.
- If you will be using **PIANO ABC**, it's probably best to record the **ABC** accompaniment on the first track you record. Then you can record subsequent tracks while listening to playback of the **ABC** sound you recorded on the first track. If you attempt to record **ABC** on more than one track, the two **ABC** tracks will compete with each other and you may not get the sound you expected.

6. Play

The **SYNCHRO START** mode is automatically selected when a **RECORD** button is pressed, so recording will begin automatically as soon as a key is pressed or the **START** or **INTRO/ENDING** button is pressed. The current measure number is shown on the Beat/Tempo display as you record. Changes in the following parameters will be recorded in addition to notes you play:

- Keys Played (note & velocity)
- Voice
- Brilliance Control
- Reverb
- Rhythm Pattern
- Rhythm Pattern Variation
- Lower ON/OFF
- Fill In
- Intro/Ending
- Rhythm Volume
- Tempo
- Piano ABC Mode
- Split Position
- Manual/Lower Volume
- Bass Voice
- Chord Voice
- Bass Volume
- Expression (pedal)
- Registration Memory Number
- Chord Volume or Lower Volume
- Damper, Sostenuato and Soft Pedal

7. Stop Recording

Press the RECORD button a second time, or the START/STOP button to stop recording. Recording will stop automatically if the disk memory capacity is reached (see "Memory Capacity and Display," below).

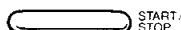

Recording a New Track

When you've finished recording the first track, you can simply play it back as described in "playback," below, or record a new track. To record a new track, press a RECORD button other than the one you used to record the previous track (and select a new track between 3 and 10 if you press RECORD 3-10), and start recording (if you press the same RECORD button again, the previously recorded material will be erased and the new material will be recorded in its place). If you press the PLAYBACK button of the previously recorded track, you'll be able to record the new track while listening to the previously recorded track (for tracks 3 through 10, all previously recorded tracks will play back while a new track is being recorded).

- The guide lamps above the keyboard provide a recorded-track display while any of the RECORD (1, 2 or 3-10) buttons are held. The guide lamps above the keys E^b6 through C7 correspond to tracks 1 through 10. When a guide lamp is on, the corresponding tracks contains recorded data. Guide-lamps that are off represent empty tracks.
- The initial settings of the parameters listed below will be automatically applied to all tracks from the beginning of the recording. Changes made to these parameters during recording will be recorded and reproduced when the piece is played back. It is also possible to change the settings of the initial parameters (listed below) after one or more tracks have been recorded by pressing a RECORD button, changing the settings, and then turning the RECORD button OFF again.
 - Tempo
 - Reverb
 - Voice (Lower, Bass, Chord)
 - Rhythm/Variation
 - Fill In/Break/Intro
 - Volume (Lower, Bass Chord, Rhythm)
- Tempo changes made during recording apply to all tracks, and cancel all tempo changes previously made at any point following the new tempo change.

Memory Capacity and Display

A single disk can record a total of approximately 688 kilobytes (a kilobyte is 1,024 bytes) of data—sufficient for many long and complicated performances. In terms of notes, approximately 50,000 notes can be recorded continuously if no other PDP-500 functions are used. If you actually bothered to sit down and record this many notes without stopping, however, there wouldn't be enough room left on the disk for any more tracks. The remaining memory capacity is shown in kilobytes on the Beat/Tempo display immediately after the RECORD button is pressed. Due to the way that the PDP-500 stores the music data, however, the display will show less than the actual memory usage when the second track is recorded. This is because the original track 1 data is temporarily retained in addition to the new track 1+2 data. The display is designed to work this way so you can judge (roughly) whether you have enough capacity left to record a subsequent track. Recording will stop automatically if the disk and internal memory become full.

- The PDP-500 has enough internal RAM memory to allow recording for a while even if a disk is not loaded. If accidentally record without loading a disk, make sure you use the COPY function (described later) to copy the recorded data to disk if you want to keep the recorded data (the internal RAM memory is not backed up). This is necessary because the internal RAM memory is cleared automatically when a new performance disk is loaded.
- Registration Memory data to be used in a recording must be stored to the disk prior to recording by pressing a REC button while holding the SPLIT button. This data must then be recalled (if the Registration Memory has subsequently been altered) prior to playback by pressing a PLAY button while holding the SPLIT button. Recalled Registration Memory data will overwrite any current data.

Playback

1. Select the Desired Song Number

Make sure that the disk containing the song you wish to play is properly loaded in the PDP-500 disk drive. Press the SONG SELECT button and use the ◀ and ▶ buttons below the Beat/Tempo/Song Number display to select the song number (1—60) you wish to play.

2. Press the PLAYBACK Button(s)

Press the PLAYBACK buttons corresponding to the track or tracks you want to play back. If the PLAYBACK 3 button is pressed, all material that was recorded on tracks 3 through 10 will be played back.

3. Press the START Button

Playback of the selected tracks begins as soon as the START button is pressed.

4. Adjust the Playback Volume

Use the MASTER VOLUME, RHYTHM VOLUME, BASS VOLUME and CHORD VOLUME controls to set the desired playback volume and balance.

5. Stop Playback

Press the STOP button to stop playback. Playback will stop automatically when the end of the recording is reached. Playback will also stop if a RECORD button is pressed during playback.

- PIANO ABC and SPLIT POSITION settings can not be changed during playback.
- You can play along with Performance Memory playback on the keyboard, using any voice you select in the normal way.
- If Registration Memory changes are included in the piece being played back, Solo Styleplay and Left Pedal Function data included in the Registration Memory setting will not be reproduced.

Disks recorded on the Yamaha DOM-30 Disk Orchestra Module and piano solo disks recorded on the Yamaha DRC-20 Disk Recorder can be reproduced in the same way as the performance memory. (DOM-30 disks recorded with voices other than piano can generally be reproduced on the PDP-500 with the same voices if a special DOM-30 format conversion function is used. Refer to the DOM-30 operation manual for details.)

Copying Songs

Song data can be "backed up" by copying to a new song number or a different disk, as follows:

1. Select the Song Number to be Copied.

Press the SONG SELECT button and use the ◀ and ▶ buttons below the Beat/Tempo/Song Number display to select the number of the song you wish to copy.

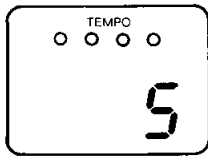

2. Press the SONG SELECT Button Again.

This exits the SONG SELECT mode, causing the display to revert to its normal tempo display function.

3. Press the COPY Button.

The COPY button LED will flash.



4. Select the Destination Song Number.

Use the ◀ and ▶ buttons below the Beat/Tempo/Song Number display to select the song number you wish to copy to (i.e. the destination song number). If you select a song number that already contains data, that data will be overwritten by the new song data. If you select a song number greater than 60, the copy will be made to a different disk.

Copy in the same disk

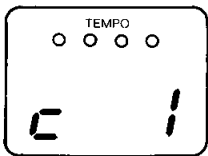

Copy to a different disk

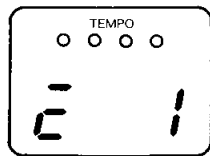

5. Start the Copy Operation.

Press the COPY button again to begin the actual copy operation (the COPY LED will light continuously during the copy operation). If you chose to copy to a different disk, you may have to exchange the source and destination disks a few times if the song being copied is long and complex. In this case, the PDP-500 will prompt you to insert the source and destination disks with the following displays:

d 1 Insert source disk.

d 2 Insert destination disk.

- If you copy to a song number that already contains data, or to another disk, the PDP-500 will ask you to confirm the copy operation. Use the Tempo ◀ and ▶ buttons to select either "Y" (YES) or "N" (NO) on the display. "Y" if you intend to execute the copy operation or "N" if you wish to cancel the operation. The copy operation will begin automatically if you select "Y."

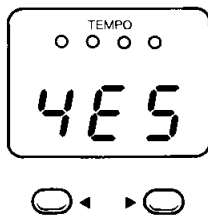

- The copy operation can be aborted at any time by pressing the START/STOP button.

Deleting a Song

You can delete any song from a loaded disk as follows:

1. Press the COPY button while holding the MIDI/TRANPOSE button.

The COPY LED will flash.



2. Select the Song to Delete.

Use the ◀ and ▶ buttons below the Beat/Tempo/Song Number display to select the song number you wish to delete.

3. Start the Delete Operation.

Press the COPY button a second time to actually delete the selected song.

Error Messages

If an error related to the disk occurs, one of the following messages may appear. If this happens, try the operation that caused the error message again. If the error persists, you may be attempting to use a write-protected disk, a disk that has not been properly formatted, or the disk itself may be at fault. If all else fails, try a different disk. If this doesn't clear up the problem, contact your Yamaha dealer.

Er1: Disk read or write error (e.g. unformatted disk).

Er2: Disk write-protected.

Er3: Attempt to record to song number 0.

REGISTRATION MEMORY

The Registration Memory feature can be used to memorize 5 complete control-panel setups that you can recall whenever needed.



Memory Store

1. Set Up the Controls as Required

Make the desired control settings: voice, lower voice, rhythm, rhythm variation, Brilliance, Reverb mode, Keyboard Percussion, Piano ABC, bass and chord voices, split position, left pedal function, tempo, Solo Styleplay, rhythm volume, chord volume, bass volume and manual volume.

2. Store in Memory

Press and hold the MEMORY button, then press one of the REGISTRATION buttons (1—5).

Recall

Simply press the desired REGISTRATION button (1—5) at any time to recall the memorized settings.

- Only one set of control settings can be stored in each REGISTRATION button at a time.
- Registration data is retained in the PDP-500 memory for about one week even if the POWER is not turned on. To keep the data in memory for longer periods, turn the POWER switch ON briefly at least once a week.

MIDI FUNCTIONS

A Brief Introduction to MIDI

MIDI, the Musical Instrument Digital Interface, is a world-standard communication interface that allows MIDI-compatible musical instruments and equipment to share musical information and control one another. This makes it possible to create "systems" of MIDI instruments and equipment that offer far greater versatility and control than is available with isolated instruments. For example, most MIDI keyboards transmit note and velocity (touch response) information via the MIDI OUT connector whenever a note is played on the keyboard. If the MIDI OUT connector is connected to the MIDI IN connector of a second keyboard (synthesizer, etc.) or a tone generator, the second keyboard or tone generator will respond precisely to notes played on the original transmitting keyboard. The result is that you can effectively play two instruments at once, providing thick multi-instrument sounds.

This same type of musical information transfer is used for MIDI sequence recording. A sequencer can be used to "record" MIDI data received from PDP-500, for example. When the recorded data is played back, the PDP-500 automatically "plays" the recorded performance in precise detail.

- Always use a high-quality MIDI cable to connect MIDI OUT to MIDI IN terminals. Never use MIDI cables longer than about 15 meters, since cables longer than this can pick up noise which can cause data errors.

MIDI "Messages" Transmitted & Received by the PDP-500

The most important MIDI information (messages) transmitted and received by the PDP-500 is as follows:

Note and Velocity Data

This information tells the receiving keyboard or tone generator to play a certain note (specified by the MIDI note number) at a certain dynamic level (specified by the MIDI velocity value). Note and velocity data is transmitted by the PDP-500 whenever a key is pressed, and the PDP-500's internal AWM tone generator will "play" the corresponding note(s) whenever note and velocity data is received from an external MIDI device.

Program Change Numbers

The PDP-500 transmits a MIDI program number between 0 and 22 when one of its voice selectors is pressed. This normally causes the correspondingly numbered voice or program to be selected on a receiving MIDI device. The PDP-500 will respond in the same way, automatically selecting the appropriate voice when a MIDI program change number is received. See "Program Change ON/OFF" on page 19 for information on turning program change number reception and transmission ON or OFF.

Control Change Numbers

Control Change data representing Soft, Sostenuto, Damper, volume and other operations is transmitted by the PDP-500 whenever one of these pedals is used. If the receiving device is a tone generator or another keyboard, it will respond in the same way as the PDP-500's internal tone generator when one of the pedals is used. The PDP-500 also receives and responds to the appropriate control change data. See "Control Change ON/OFF" on page 19 for information on turning control change number reception and transmission ON or OFF.

AVAILABLE MIDI FUNCTIONS

Function	Voice Selector
Send Channel Select	PIANO 1/2
Receive Channel Select	E.PIANO 1/2
Local ON/OFF	HARPSI/CELESTA
Program Change ON/OFF	VIBES/MARIMBA
Control Change ON/OFF	GUITAR/J.GUITAR
Multi-Timbre Mode ON/OFF	CHOIR/STRINGS
Split Send Mode	WOOD/BRASS
MIDI Clock Select	SAX/SYNTH
Panel Data Transmit	P.ORGAN/J.ORGAN

- * The MIDI functions listed above are engaged by holding down the MIDI/TRANSCOPE button and pressing the corresponding voice selector. Full details are given in the following pages. A special MIDI mode that is currently intended for internal Yamaha use only is accessed by holding MIDI/TRANSCOPE and pressing the ELEC BASS 1/2 selector. If you accidentally turn this mode ON (ELEC BASS 1/2 LED is lit when the ELEC BASS 1/2 selector is pressed while MIDI/TRANSCOPE is held), turn it OFF by holding MIDI/TRANSCOPE and pressing the ELEC BASS 1/2 selector again (ELEC BASS 1/2 LED should go out).

MIDI Transmit & Receive Channel Selection

The MIDI system allows transmission and reception of MIDI data on 16 different channels. Multiple channels have been implemented to allow selective control of certain instruments or devices connected in series. For example, a single MIDI sequencer could be used to "play" two different instruments or tone generators. One of the instruments or tone generators could be set to receive only on channel 1, while the other is set to receive on channel 2. In this situation the first instrument or tone generator will respond only to channel-1 information transmitted by the sequencer, while the second instrument or tone generator will respond only to channel-2 information. This allows the sequencer to "play" two completely different parts on the receiving instruments or tone generators.

In any MIDI control setup, the MIDI channels of the transmitting and receiving equipment must be matched for proper data transfer. An "OMNI" receive mode is also available, which allows reception on all 16 MIDI channels. In the OMNI mode it is not necessary to match the receive channel of the receiving device to the transmit channel of the transmitting device (except when receiving mode messages).

Setting the MIDI Channels

1. Press and hold the MIDI/TRANSCOPE button, then press the PIANO 1/2 voice selector to set the send channel or the E.PIANO 1/2 voice selector to set the receive channel.
2. Use the tempo ◀ and ▶ buttons to select the desired channel (the selected channel number is shown on the Beat/Tempo display—the OMNI receive mode is indicated by "ALL" on the display).
 - When the power is initially turned ON, MIDI receive is set to the OMNI mode and the transmit channel is set to 1.

Local Control ON/OFF _____

“Local Control” refers to the fact that, normally, the PDP-500 keyboard controls its internal tone generator, allowing the internal voices to be played directly from the keyboard. This situation is “Local Control ON” since the internal tone generator is controlled locally by its own keyboard.

Local control can be turned OFF, however, so that the PDP-500 keyboard does not play the internal voices, but the appropriate MIDI information is still transmitted via the MIDI OUT connector when notes are played on the keyboard. At the same time, the internal tone generator responds to MIDI information received via the MIDI IN connector. This means that while an external MIDI sequencer plays the PDP-500’s internal voices, an external tone generator can be played from the PDP-500 keyboard. Local Control is automatically turned ON when the power is initially turned ON.

Turning Local Control ON or OFF

1. Hold down the MIDI/TRANPOSE button.
2. Press the HARPSI/CELESTA voice selector. If the HARPSI/CELESTA LED is lit when the voice selector is pressed, you have turned local control OFF. If the HARPSI/CELESTA LED is not lit when the voice selector is pressed, you have turned local control ON.
3. Release the MIDI/TRANPOSE button.

Program Change ON/OFF _____

Normally the PDP-500 will respond to MIDI program change numbers received from an external keyboard or other MIDI device, causing the correspondingly numbered PDP-500 voice to be selected. The PDP-500 will normally also send a MIDI program change number whenever one of its voices is selected, causing the correspondingly numbered voice or program to be selected on the external MIDI device if the device is set up to receive and respond to MIDI program change numbers.

This function makes it possible to cancel program change number reception and transmission so that voices can be selected on the PDP-500 without affecting the external MIDI device, and vice versa. Program Change is automatically turned ON when the power is initially turned ON.

1. Hold down the MIDI/TRANPOSE button.
2. Press the VIBES/MARIMBA voice selector. If the VIBES/MARIMBA LED is lit when the voice selector is pressed, you have turned program change reception/transmission OFF. If the VIBES/MARIMBA LED is not lit when the voice selector is pressed, you have turned program change reception/transmission ON.
3. Release the MIDI/TRANPOSE button.

Control Change ON/OFF _____

Normally the PDP-500 will respond to MIDI control change data received from an external MIDI device or keyboard, causing the selected PDP-500 voice to be affected by pedal and other “control” settings received from the controlling device. The PDP-500 also transmits MIDI control change information when either of its pedals are operated.

This function makes it possible to cancel control change data reception and transmission if you do not want the PDP-500 voices to be affected by control change data received from an external device or vice versa. Control Change is automatically turned ON when the power is initially turned ON.

1. Hold down the MIDI/TRANPOSE button.
2. Press the GUITAR/J.GUITAR voice selector. If the GUITAR/J.GUITAR LED is lit when the voice selector is pressed, you have turned control change reception/transmission OFF. If the GUITAR/J.GUITAR LED is not lit when the voice selector is pressed, you have turned control change reception/transmission ON.
3. Release the MIDI/TRANPOSE button.

The Multi-Timbre Mode _____

The Multi-Timbre mode is a special mode in which the PDP-500 voices can be independently controlled on different MIDI channel numbers (1 through 10 and 15) by an external MIDI device. The Multi-Timbre mode is automatically turned OFF when the power is initially turned ON. The Multi-Timbre mode can be activated as follows:

1. Hold down the MIDI/TRANPOSE button.
 2. Press the CHOIR/STRINGS voice selector. If the CHOIR/STRINGS LED is lit when the voice selector is pressed, you have turned the Multi-Timbre mode ON. If the CHOIR/STRINGS LED is not lit when the voice selector is pressed, you have turned the Multi-Timbre mode OFF.
 3. Release the MIDI/TRANPOSE button.
- The PDP-500’s rhythm instruments are controlled via MIDI channel 15. The note assignments for the various rhythm instruments are given below:

RHYTHM INSTRUMENT NOTE ASSIGNMENTS

Note (MIDI Note No.)	Instrument
F# ₂ (54)	BRUSH ROLL
G# ₂ (56)	HI-HAT CLOSED HEAVY
A# ₂ (58)	CRASH CYMBAL LIGHT
B ₂ (59)	BASS DRUM LIGHT
C ₃ (60)	SNARE DRUM + RIM HEAVY
C# ₃ (61)	RIDE CYMBAL CUP
D ₃ (62)	SNARE DRUM + RIM LIGHT
F ₃ (65)	BASS DRUM
F# ₃ (66)	RIM SHOT
G ₃ (67)	SNARE DRUM HEAVY
G# ₃ (68)	BRUSH SHOT
A ₃ (69)	SNARE DRUM LIGHT
A# ₃ (70)	HI-HAT PEDAL
B ₃ (71)	SNARE DRUM ECHO
C ₄ (72)	TOM 4
C# ₄ (73)	HI-HAT CLOSED
D ₄ (74)	TOM 3
D# ₄ (75)	HI-HAT OPEN
E ₄ (76)	TOM 2
F ₄ (77)	TOM 1
F# ₄ (78)	RIDE CYMBAL
G ₄ (79)	ELECTRONIC TOM 3
G# ₄ (80)	CRASH CYMBAL
A ₄ (81)	ELECTRONIC TOM 2
B ₄ (83)	ELECTRONIC TOM 1
C ₅ (84)	CONGA LOW
C# ₅ (85)	CABASA
D ₅ (86)	CONGA HIGH
D# ₅ (87)	METRONOME
E ₅ (88)	BONGO
F ₅ (89)	TIMBALE LOW
F# ₅ (90)	CLAVES
G ₅ (91)	TIMBALE HIGH
G# ₅ (92)	CASTANETS
A ₅ (93)	CUICA LOW
A# ₅ (94)	COWBELL
B ₅ (95)	CUICA HIGH
C ₆ (96)	HAND CLAPS
C# ₆ (97)	AGOGO LOW
D# ₆ (99)	AGOGO HIGH
E ₆ (100)	BONGO LOW
F# ₆ (102)	TAMBOURINE
G# ₆ (104)	TRIANGLE CLOSED
A# ₆ (106)	TRIANGLE OPEN

The Split Send Mode

In the split send mode note played on the lower section of the PDP-500 keyboard are transmitted on MIDI channel 2, while the upper keyboard section transmits on the MIDI channel set using the Send Channel Select function described earlier. In this mode the left- and right-hand sections of the keyboard can be used to play separate external keyboards or tone generators set to receive on the appropriate channels. The split position (the key that divides the left- and right-hand sections of the keyboard) is determined by the SPLIT POSITION button in the normal way. The Split Send Mode is automatically turned OFF when the power is initially turned ON.

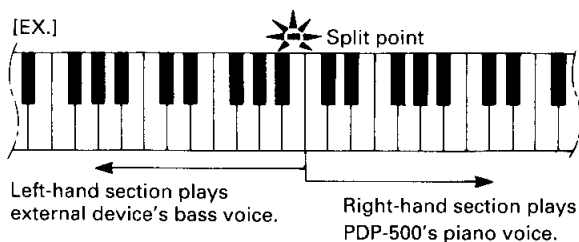

Activating the Split Send Mode

1. Hold down the MIDI/TRANSCOPE button.
2. Press the WOOD/BRASS voice selector. If the WOOD/BRASS LED is lit when the voice selector is pressed, you have turned the Split Send Mode ON. If the WOOD/BRASS LED is not lit when the voice selector is pressed, you have turned the Split Send Mode OFF.
3. Release the MIDI/TRANSCOPE button.

MIDI Clock Select

This function determines whether the PDP-500's rhythm and PIANO ABC timing is controlled by the PDP-500's own internal clock or an external MIDI clock signal received from external equipment connected to the MIDI IN connector. The Clock Mode is automatically set to INTERNAL when the power is initially turned ON.

1. Hold down the MIDI/TRANSCOPE button.
2. Press the SAX/SYNTH voice selector. If the SAX/SYNTH LED is lit when the voice selector is pressed, you have set the Clock Mode to EXTERNAL. If the SAX/SYNTH LED is not lit when the voice selector is pressed, you have set the Clock Mode to INTERNAL.
3. Release the MIDI/TRANSCOPE button.
 - If the Clock Mode is set to EXTERNAL and a MIDI clock signal is not being received from an external source, the PDP-500 rhythm, PIANO ABC and other clock-dependent features will not operate.

Panel Data Send

This function causes all the current PDP-500 control settings (selected voice, etc) to be transmitted via the MIDI OUT terminal. This is particularly useful if you will be recording performances to a MIDI sequencer which will be used to control the PDP-500 on playback. By transmitting the PDP-500 panel settings and recording them on the MIDI sequencer prior to the actual performance data, the PDP-500 will be automatically restored to the same settings when the performance is played back.

1. Hold down the MIDI/TRANSCOPE button.
2. Press the P.ORGAN/J.ORGAN voice selector.
3. Release the MIDI/TRANSCOPE button.

MIDI Specifications for Other Equipment

When using the PDP-500 with other MIDI equipment, always refer to the MIDI specifications (implementation chart and MIDI data format) of the equipment used to ensure compatibility.

MIDI DATA FORMAT

If you're already very familiar with MIDI, or are using a computer to control your music hardware with computer-generated MIDI messages, the data provided in this section can help you to control the PDP-500.

1. NOTE ON/OFF

Data format: [9xH] → [kk] → [vv]

9xH= Note ON/OFF event (x= channel number)

kk= Note number (21~108= A-1~C7)

vv= Velocity (Key ON= 1~127. Key OFF= 0)

* Note OFF event format [8xH] → [kk] → [vv] also recognized (reception only, vv=0~127).

2. CONTROL CHANGE & MODE MESSAGES

Data format: [BxH] → [cc] → [dd]

BxH= Control event (x= channel number)

cc= Control number (or mode message number)

dd= Control value

cc	PARAMETER	dd
01H	Modulation/ Vibrato (Receive only)	0~0FH= OFF 0 (OFF)~7FH (MAX), 8 steps (LFO speed fixed for each voice)
07H	Volume (Manual Volume)	00000000= -∞ 01101111= -3 dB 01111111= ±0 dB
0BH	Expression	00000000= -∞ 01101111= -3 dB 01111111= ±0 dB
40H	Damper pedal	0~7FH, maximum 8 steps.
42H	Sostenuto pedal	0~3FH= OFF; 40H~7FH= ON
43H	Soft pedal	0~3FH= OFF; 40H~7FH= ON
5CH	Tremolo	0~3FH= OFF; 40H~7FH= ON
5DH	Chorus	0~3FH= OFF; 40H~7FH= ON
5EH	Ensemble	0~3FH= OFF; 40H~7FH= ON
5FH	Flanger	0~3FH= OFF; 40H~7FH= ON
79H	Reset all controllers	0
7AH	Local ON/OFF	0= OFF; 7FH= ON
7BH	All notes OFF	0
7CH	OMNI OFF/All notes OFF	0
7DH	OMNI ON/All notes OFF	0

* 79H, 7AH, 7BH, 7CH and 7DH are receive only.

3. PROGRAM CHANGE

Data format: [CxH] → [dd]

CxH= program event (x = channel number)

dd= Program number

Panel Voices

dd	VOICE	dd	VOICE
00H	PIANO 1	0CH	WOOD
01H	PIANO 2	0DH	BRASS
02H	E.PIANO 1	0EH	SAX
03H	E.PIANO 2	0FH	SYNTH
04H	HARPSICHORD	10H	P.ORGAN
05H	CELESTA	11H	J.ORGAN
06H	VIBES	12H	UP.BASS
07H	MARIMBA	13H	SY. BASS
08H	GUITAR	14H	EL.BASS 1
09H	J.GUITAR	15H	EL.BASS 2
0AH	CHOIR	16H	DRUMS
0BH	STRINGS		

Accompaniment Voices

dd	VOICE	RANGE
17H	SOLO STRINGS	C0~C6
18H	PIZZICATO	C3~C6
19H	TIMPANI & STEEL. DR	C0~F#2
1AH	OBOE	A#2~G6
1BH	CLARINET	G2~A#5
1CH	ROCK GUITAR 1	D2~A5
1DH	ROCK GUITAR 2	D2~A5
1EH	MUTE TRUMPET	F#2~A5
1FH	ACCORDION	F2~A5

20H	HORN	A#0~F4
21H	SY.PIANO	A-1~C7
22H	SY. VOCAL	C2~E5
23H	SY.CRYSTAL	C2~C6
24H	SY.LEAD	C2~F#6
25H	HARMONICA	C3~C6
26H	BANJO	C3~A5
27H	BASSOON	A0~F#4
28H	HARP	A0~C7

Special Sustained Voices Selected when Expression Pedal Pressed

29H	CHOIR	2DH	SAX
2AH	STRINGS	2EH	SYNTH
2BH	WOOD	2FH	P.ORGAN
2CH	BRASS	30H	J.ORGAN

* No voice change is made when dd > 30H.

* When the Multi-Timbre mode is ON, program change numbers received on channel 15 select the following rhythm patterns rather than voices:

Multi-Timbre Mode Rhythms

dd	VOICE	dd	VOICE
00H	POPS 1	12H	BOOGIE
01H	POPS 2	13H	RAGTIME
02H	POPS 3	14H	BOSSANOVA
03H	POPS 4	15H	CHA-CHA
04H	ROCK' N ROLL	16H	SAMBA
05H	SLOW ROCK	17H	RHUMBA
06H	DISCO 1	18H	TANGO
07H	DISCO 2	19H	REGGAE
08H	16 BEAT 1	1AH	SALSA
09H	16 BEAT 2	1BH	LATIN POP
0AH	COUNTRY 1	1CH	MARCH
0BH	COUNTRY 2	1DH	CLASSIC
0CH	SHUFFLE 1	1EH	WALTZ
0DH	SHUFFLE 2	1FH	METRONOME
0EH	SWING 1	62H	3/4 time, no rhythm
0FH	SWING 2	63H	4/4 time, no rhythm
10H	SWING 3		
11H	JAZZ WALTZ		

4. BASS BENDER CHANGE DATA

Data format: [ExH] → [cc] → [dd]

ExH= Bender event (x= channel number)

cc= LSB

dd= MSB

	MSB	LSB
MAX:	01111111	01111110
	01111110	01111100
	01111101	01111010
	01000001	00000010
CENTER:	01000000	00000000
	00111111	00000000
	00000001	00000000
MIN:	00000000	00000000

5. SYSTEM REALTIME MESSAGES

Active Sensing (FEH)

Transmitted every 200 milliseconds. If no data received for more than 400 milliseconds after FE received a NOTE OFF occurs.

Timing Clock (F8H)

Start (FAH)

Stop (FBH)

6. SYSTEM EXCLUSIVE MESSAGES

(1) PDP-500 Messages

DATA FORMAT: [F0H] → [43H] → [73H] → [ID CODE] → [nn] → [F7H]

43H=YAMAHA ID

73H =Model ID

1EH =Substatus

nn SEND/RECEIVE DATA

02H Internal Clock (receive only)

03H External Clock (receive only)

13H Multi-Timbre mode OFF

15H Multi-Timbre mode ON

7nH Receive channel change (receive only, n= channel number)

TROUBLESHOOTING

(2) Special Control Messages

DATA FORMAT: [F0H] → [43H] → [73H] → [1EH] → [11H]
 → [0xH] → [cc] → [dd] → [F7H]
 43H= YAMAHA ID
 73H =Model ID
 1EH =Model ID
 11H= PDP-500 special control code
 0xH= MIDI channel number
 cc= Control number
 dd= Control value

cc	SEND/RECEIVE DATA	dd
10H	ABC Mode	00H= OFF 01H= ABC Single Finger 02H=ABC Fingered 00H= OFF
11H	Rhythm Variation	01H= Variation ON
12H	Fill In Switch Event	00H= OFF Event 01H-02H= Fill in switch ON event
13H	Intro/Ending Switch Event	00H= INTRO/ ENDING OFF 01H= Intro switch on 02H= Ending switch on 03H= Break switch off 04H= Break switch on
14H	Split	[dd]= Split key
15H	Rhythm Number	[dd]= Rhythm number
17H	Lower Voice Mode	00H= OFF 01H= Lower on
18H	Voice Number	[dd]= Voice number
19H	Volume	[dd]= Volume value (0xH: x=1 for LOWER, x=2 for BASS, x=4 for CHORD)
1AH	Rhythm Volume	[dd]= Volume value
20H	Registration Number	00H-04H= Registration number
21H	Solo Styleplay Number	00H=OFF 01H-05H= Style number
58H	Brilliance	00H= Normal 01H= Mellow 02H= Bright
59H	Reverb	00H= OFF 01H= Room 02H= Hall 1 03H= Hall 2 04H= Cosmic
5BH	Pedal Function	[dd]= Function number
7FH	Performance Memory	20H= Rec on 21H= Rec off 22H= Play on 23H= Play off (0xH: x= 0 for track 1, x=1 for track 2, x= 2 for track 3-10)

(3) Panel Dump

a) Panel Dump Request

DATA FORMAT: [F0H] → [43H] → [2nH] → [7CH] → [F7H]

Panel data is transmitted when the above data is received.
 2nH= Panel dump request ("n" is channel number).

b) Panel Dump

DATA FORMAT: [F0H] → [43H] → [0nH] → [7CH][F7H]

0nH= Panel dump ("n" is channel number).
 7CH= Format code.

Panel Data Transmitted

Manual Voice	Manual Volume
Brilliance Control	Effect
Rhythm Number	Rhythm Variation
Rhythm Volume	Tempo (Absolute, LSB)
Tempo (Absolute, MSB)	Lower Voice
Chord Voice	Bass Voice
Chord/Lower Volume	Bass Volume
ABC (OFF/SF/FC)	Lower ON/OFF
Solo Styleplay Number	Split Point
Pedal Function	Reverb
Foot Fill In Number	

If you encounter what appears to be a malfunction, please check the following points before assuming that your PDP-500 is faulty.

1. No Sound When the Power is Turned ON

Is the AC plug properly connected to an AC wall outlet? Check the AC connection carefully. Is the MASTER VOLUME control turned up to a reasonable listening level?

2. The PDP-500 Reproduces Radio or TV Sound

This can occur if there is a high-power transmitter in your vicinity. Contact your Yamaha dealer.

3. Intermittent Static Noise

This is usually due to turning ON or OFF a household appliance or other electronic equipment which is fed by the same AC mains line as your PDP-500.

4. Interference Appears on Radio or TV Sets Located Near the PDP-500

The PDP-500 contains digital circuitry which can generate radio-frequency noise. The solution is to move the PDP-500 further away from the affected equipment, or vice versa.

5. Distorted Sound When the PDP-500 is Connected to An External Amplifier/Speaker System

If the PDP-500 is connected to a stereo system or instrument amplifier and the sound is distorted, reduce the setting of the PDP-500 volume control to a level at which the distortion ceases.

Personal Digital Piano PDP-500 MIDI Implementation Chart

Date : Jul. 22, 1993
Version : 1.0

Function	Transmitted	Recognized	Remarks
Basic Channel Default Changed	1 1-16	1 1-16	
Mode Default Messages Altered	3 × *****	1 OMNI on, OMNI off ×	
Note Number True Voice	21-108 *****	21-108 21-108	
Velocity Note ON Note OFF	○ 9nH, v=1-127 × 9nH, v=0	○ 9nH, v=1-127 ×	
After Touch Key's CH's	× ×	× ×	
Pitch Bend	○	○	
Control Change	01 ○ 07 ○ 11 ○ 64 ○ 66 ○ 67 ○ 121 ×	○ ○ ○ ○ ○ ○ ○	Modulation Volume Expression Damper Sostenuto Soft Pedal Reset ALL Controllers
Program Change True #	○ 0-22 *****	○ 0-48 0-48	
System Exclusive	○	○	
System Common Song Position Song Select Tune	× × ×	× × ×	
System Real Time Clock Commands	○ ○	○ ○	
Aux Messages Local ON/OFF All Notes OFF Active Sense Reset	× × ○ ×	○ ○ ○ ×	(123-125) * 1
Notes	* 1= receive (123) if omni off or multi-timbre on		

Mode 1 : OMNI ON, POLY
Mode 3 : OMNI OFF, POLY

Mode 2 : OMNI ON, MONO
Mode 4 : OMNI OFF, MONO

○ : Yes
× : No

SPECIFICATIONS

* Specifications subject to change without notice.

KEYBOARD	88 KEYS (A-1~C7)	
TONE GENERATOR	AWM (Advanced Wave Memory)	
VOICE SELECTORS & CONTROLS	PIANO 1/2, E.PIANO 1/2, HARPSI, CELESTA, VIBES, MARIMBA, GUITAR, J.GUITAR, CHOIR, STRINGS, WOOD, BRASS, SAX, SYNTH, P.ORGAN, J.ORGAN, UPRIGHT BASS, SYNTH BASS, ELEC BASS 1/2, DRUMS, LOWER VOICE, LOWER ON	
PIANO ABC & SELECTORS	SINGLE FINGER, FINGERED, CHORD VOICE, CHORD VOLUME, BASS VOICE, BASS VOLUME, SPLIT POSITION	
RHYTHM SELECTORS & CONTROLS	POPS 1/2/3/4, ROCK'N, SLOW ROCK, DISCO 1/2, 16BEAT 1/2, COUNTRY 1/2, SHUFFLE 1/2, SWING 1/2/3, JAZZ WALTZ, BOOGIE, RAGTIME, BOSSA, CHA-CHA, SAMBA, RHUMBA, TANGO, REGGAE, SALSA, LATIN POP, MARCH, CLASSIC, WALTZ, METRONOME, VARIATION, RHYTHM VOLUME, START/STOP, SYNCHRO START, INTRO/ENDING, BREAK, FILL IN 1/2, ◀, ▶, Beat/Tempo/Song Number Display	
KEYBOARD PERCUSSION	BRUSH ROLL, HI-HAT CLOSED HEAVY, CRASH CYMBAL LIGHT, BASS DRUM LIGHT, SNARE DRUM + RIM HEAVY, RIDE CYMBAL CUP, SNARE DRUM + RIM LIGHT, BASS DRUM, RIM SHOT, SNARE DRUM HEAVY, BRUSH SHOT, SNARE DRUM LIGHT, HI-HAT PEDAL, SNARE DRUM ECHO, TOM 4, HI-HAT CLOSED, TOM 3, HI-HAT OPEN, TOM 2, TOM 1, RIDE CYMBAL, ELECTRONIC TOM 3, CRASH CYMBAL, ELECTRONIC TOM 2, ELECTRONIC TOM 1, CONGA LOW, CABASA, CONGA HIGH, METRONOME, BONGO, TIMBALE HIGH, CASTANETS, CUICA LOW, COWBELL, CUICA HIGH, HAND CLAPS, AGOGO LOW, AGOGO HIGH, BONGO LOW, TAMBOURINE, TRIANGLE CLOSED, TRIANGLE OPEN	
SOLO STYLEPLAY	POP ORCH, JAZZ QUARTET, COCKTAIL PIANO, COUNTRY PIANO, ROCK BAND	
REVERB	ROOM, HALL 1/2, COSMIC	
PERFORMANCE MEMORY	PRECORD 1/2/3-10, PLAY BACK 1/2/3-10	
REGISTRATION MEMORY	MEMORY, RECALL 1/2/3/4/5	
DISK ORCHESTRA	SONG SELECT, PHRASE REPEAT, LAMP CANCEL, ORCH ON, LEFT ON, RIGHT ON, LEFT GUIDE, RIGHT GUIDE	
DISK DRIVE & CONTROLS	3.5" Micro Floppy Disk, built-in. 2DD 1M. COPY, FORMAT	
PEDAL CONTROLS	RIGHT	DAMPER
	LEFT	SOFT, SOSTENUTO, START/STOP, INTRO/ENDING, FILL IN, S.STYLEPLAY
OTHER CONTROLS	MASTER VOLUME, MANUAL VOLUME, BRILLIANCE, MIDI/TRANPOSE, POWER	
JACKS & CONNECTORS	HEADPHONES, AUX OUT L/R, OPTIONAL IN L/R, OPTIONAL OUT L/R, MIDI IN/OUT/THRU, EXP.PEDAL	
INPUT & OUTPUT LEVEL/IMPEDANCE	OPTIONAL IN: 22k Ω -10dB nominal. AUX OUT: 600 Ω -7dB when OPTIONAL IN level is -10dB. OPTIONAL OUT: 600 /1~4Vpp (normal output level).	
MAIN AMPLIFIER	60W (30W \times 2)	
SPEAKERS	13cm (5-1/8") \times 2, 5cm (1-8/9") \times 2	
DIMENSIONS	141.6cm (W) \times 56.2cm (D) \times 79.5cm (H) (55-3/4" \times 22-1/8" \times 31-1/3")	
WEIGHT	59.0kg (130.1 lbs)	
FINISH	BLACK METALLIC	
INCLUDED ACCESSORIES	BENCH, DISK ORCHESTRA COLLECTION DO-002W (DISK, MUSIC BOOK), 3.5" FLOPPY DISK	

IMPORTANT SAFETY INSTRUCTIONS

INFORMATION RELATING TO PERSONAL INJURY, ELECTRICAL SHOCK, AND FIRE HAZARD POSSIBILITIES HAS BEEN INCLUDED IN THIS LIST.

WARNING- When using any electrical or electronic product, basic precautions should always be followed. These precautions include, but are not limited to, the following:

- 1.** Read all Safety Instructions, Installation Instructions, Special Message Section items, and any Assembly Instructions found in this manual **BEFORE** marking any connections, including connection to the main supply.
- 2.** Main Power Supply Verification: Yamaha products are manufactured specifically for the supply voltage in the area where they are to be sold. If you should move, or if any doubt exists about the supply voltage in your area, please contact your dealer for supply voltage verification and (if applicable) instructions. The required supply voltage is printed on the name plate. For name plate location, please refer to the graphic found in the Special Message Section of this manual.
- 3.** This product may be equipped with a polarized plug (one blade wider than the other). If you are unable to insert the plug into the outlet, turn the plug over and try again. If the problem persists, contact an electrician to have the obsolete outlet replaced. Do **NOT** defeat the safety purpose of the plug.
- 4.** Some electronic products utilize external power supplies or adapters. Do **NOT** connect this type of product to any power supply or adapter other than one described in the owners manual, on the name plate, or specifically recommended by Yamaha.
- 5.** **WARNING:** Do not place this product or any other objects on the power cord or place it in a position where anyone could walk on, trip over, or roll anything over power or connecting cords of any kind. The use of an extension cord is not recommended! If you must use an extension cord, the minimum wire size for a 25' cord (or less) is 18 AWG. **NOTE:** The smaller the AWG number, the larger the current handling capacity. For longer extension cords, consult a local electrician.
- 6.** Ventilation: Electronic products, unless specifically designed for enclosed installations, should be placed in locations that do not interfere with proper ventilation. If instructions for enclosed installations are not provided, it must be assumed that unobstructed ventilation is required.
- 7.** Temperature considerations: Electronic products should be installed in locations that do not significantly contribute to their operating temperature. Placement of this product close to heat sources such as; radiators, heat registers and other devices that produce heat should be avoided.
- 8.** This product was **NOT** designed for use in wet/damp locations and should not be used near water or exposed to rain. Examples of wet/damp locations are; near a swimming pool, spa, tub, sink, or wet basement.
- 9.** This product should be used only with the components supplied or; a cart, rack, or stand that is recommended by the manufacturer. If a cart, rack, or stand is used, please observe all safety markings and instructions that accompany the accessory product.
- 10.** The power supply cord (plug) should be disconnected from the outlet when electronic products are to be left unused for extended periods of time. Cords should also be disconnected when there is a high probability of lightening and/or electrical storm activity.
- 11.** Care should be taken that objects do not fall and liquids are not spilled into the enclosure through any openings that may exist.
- 12.** Electrical/electronic products should be serviced by a qualified service person when:
 - a. The power supply cord has been damaged; or
 - b. Objects have fallen, been inserted, or liquids have been spilled into the enclosure through openings; or
 - c. The product has been exposed to rain; or
 - d. The product does not operate, exhibits a marked change in performance; or
 - e. The product has been dropped, or the enclosure of the product has been damaged.
- 13.** Do not attempt to service this product beyond that described in the user-maintenance instructions. All other servicing should be referred to qualified service personnel.
- 14.** This product, either alone or in combination with an amplifier and headphones or speaker/s, may be capable of producing sound levels that could cause permanent hearing loss. **DO NOT** operate for a long period of time at a high volume level or at a level that is uncomfortable. If you experience any hearing loss or ringing in the ears, you should consult an audiologist. **IMPORTANT:** The louder the sound, the shorter the time period before damage occurs.
- 15.** Some Yamaha products may have benches and/or accessory mounting fixtures that are either supplied as a part of the product or as optional accessories. Some of these items are designed to be dealer assembled or installed. Please make sure that benches are stable and any optional fixtures (where applicable) are well secured **BEFORE** using. Benches supplied by Yamaha are designed for seating only. No other uses are recommended.

PLEASE KEEP THIS MANUAL

For details of products, please contact your nearest Yamaha/
or the authorized distributor listed below.

Pour plus de détails sur les produits, veuillez-vous adresser à
Yamaha ou au distributeur le plus proche de vous figurant
dans la liste suivante.

Die Einzelheiten zu Produkten sind bei Ihrer unten aufgeführ-
ten Niederlassung und bei Yamaha-Vertragshändlern in den
jeweiligen Bestimmungsländern erhältlich.

Para detalles sobre productos, contacte su tienda Yamaha más
cercana o el distribuidor autorizado que se lista debajo.

NORTH AMERICA

CANADA

Yamaha Canada Music Ltd.
135 Milner Avenue, Scarborough, Ontario,
M1S 3R1, Canada
Tel: 416-298-1311

U.S.A.

**Yamaha Corporation of America,
Keyboard Division**
6600 Orangethorpe Ave., Buena Park, Calif. 90620,
U.S.A.
Tel: 714-522-9910

MIDDLE & SOUTH AMERICA

MEXICO

**Yamaha De Mexico S.A. De C.V.,
Departamento de ventas**
Javier Rojo Gomez No.1149, Col. Gpe Del
Moral, Deleg. Iztapalapa, 09300 Mexico, D.F.
Tel: 686-00-33

BRASIL

Yamaha Musical Do Brasil LTDA.
Ave. Reboucas 2636, São Paulo, Brasil
Tel: 55-11 853-1377

PANAMA

Yamaha De Panama S.A.
Edificio Interseco, Calle Elvira Mendez no.10, Piso
3, Oficina #105, Ciudad de Panama, Panama
Tel: 507-69-5311

OTHER LATIN AMERICAN COUNTRIES AND CARIBBEAN COUNTRIES

Yamaha Music Latin America Corp.
6101 Blue Lagoon Drive, Miami, Florida 33126,
U.S.A.
Tel: 305-261-4111

EUROPE

THE UNITED KINGDOM

Yamaha-Kemble Music(U.K.) Ltd.
Sherbourne Drive, Tilbrook, Milton Keynes,
MK7 8BL England
Tel: 0908-366700

IRELAND

Danfay Ltd.
61D, Sallynoggin Road, Dun Laoghaire, Co. Dublin
Tel: 01-2859177

GERMANY/SWITZERLAND

Yamaha Europa GmbH.
Siemensstraße 22-34, D-2084 Rellingen, F.R. of
Germany
Tel: 04101-3030

AUSTRIA/HUNGARY/SLOVENIA/ ROMANIA/BULGARIA

Yamaha Music Austria GesmbH.
Schleiergasse 20, A-1100 Wien Austria
Tel: 0222-60203900

THE NETHERLANDS

**Yamaha Music Benelux B.V.,
Verkoop Administratie**
Kanaalweg 18G, 3526 KL Utrecht, The Netherlands
Tel: 030-828411

BELGIUM/LUXEMBOURG

**Yamaha Music Benelux B.V.,
Brussels-office**
Keiberg Imperiastraat 8, 1930 Zaventem, Belgium
Tel: 02-7258220

FRANCE

**Yamaha Musique France, Division
Instruments Electroniques et de Scène**
BP 70-77312 Marne-la-Vallée Cedex 2, France
Tel: 01-64-61-4000

ITALY

**Yamaha Musica Italia S.P.A.,
Home Keyboard Division**
Viale Italia 88, 20020 Lainate(Milano), Italy
Tel: 02-935-771

SPAIN

Yamaha-Hazen Electronica Musical, S.A.
Jorge Juan 30, 28001, Madrid, Spain
Tel: 91-577-7270

PORTUGAL

Valentim de Carvalho CI SA
Estrada de Porto Salvo, Paco de Arcos 2780 Oeiras,
Portugal
Tel: 01-443-3398/4030/1823

GREECE

Philippe Nakas S.A.
Navarinou Street 13, P.Code 10680, Athens, Greece
Tel: 01-364-7111

SWEDEN

Yamaha Scandinavia AB
J. A. Wettergrens gate 1, Box 30053, 400 43
Göteborg, Sweden
Tel: 031-496090

DENMARK

YS Copenhagen Liaison Office
Finsensvej 86, DK-2000 Frederiksberg, Denmark
Tel: 31-87 30 88

FINLAND

Fazer Music Inc.
Aleksanterinkatu 11, SF 00100 Helsinki, Finland
Tel: 0435 011

NORWAY

Narud Yamaha AS
Østerdalen 29, 1345 Østerås
Tel: 02-24 47 90

ICELAND

Páll H. Pálsson
P.O. Box 85, 121 Reykjavik, Iceland
Tel: 01-19440

OTHER EUROPEAN COUNTRIES

Yamaha Europa GmbH.
Siemensstraße 22-34, D-2084 Rellingen, F.R. of
Germany
Tel: 04101-3030

AFRICA

**Yamaha Corporation,
International Marketing Division**
Nakazawa-cho 10-1, Hamamatsu, Japan 430
Tel: 053-460-2311

MIDDLE EAST

TURKEY/CYPRUS

Yamaha Musique France, Division Export
BP70-77312 Marne-la-Vallée Cedex 2, France
Tel: 01-64-61-4000

OTHER COUNTRIES

**Yamaha Corporation,
International Marketing Division**
Nakazawa-cho 10-1, Hamamatsu, Japan 430
Tel: 053-460-2311

ASIA

HONG KONG

Tom Lee Music Co., Ltd.
11/F., Silvercord Tower 1, 30 Canton Road,
Tsimshatsui, Kowloon, Hong Kong
Tel: 730-1098

INDONESIA

**PT. Yamaha Music Indonesia (Distributor)
PT. Nusantik**
Gedung Yamaha Music Center, Jalan Jend. Gatot
Subroto Kav. 4, Jakarta 12930, Indonesia
Tel: 21-520-2577

MALAYSIA

Yamaha Music Malaysia Sdn., Bhd.
16-28, Jalan SS 2/72, Petaling Jaya, Selangor,
Malaysia
Tel: 3-717-8977

PHILIPPINES

Yupangco Music Corporation
339 Gil J. Puyat Avenue, P.O. Box 885 MCPO,
Makati, Metro Manila, Philippines
Tel: 819-7551

SINGAPORE

Yamaha Music Asia Pte., Ltd.
Blk 17A Toa Payoh #01-190 Lorong 7
Singapore, 1231
Tel: 354-0133

TAIWAN

Kung Hsue She Trading Co., Ltd.
No. 322, Section 1, Fu Hsing S. Road,
Taipei 106, Taiwan. R.O.C.
Tel: 02-709-1266

THAILAND

Siam Music Yamaha Co., Ltd.
865 Phornprapha Building, Rama 1 Road,
Patumwan, Bangkok 10330, Thailand
Tel: 2-215-3443

THE PEOPLE'S REPUBLIC OF CHINA AND OTHER ASIAN COUNTRIES

**Yamaha Corporation,
International Marketing Division**
Nakazawa-cho 10-1, Hamamatsu, Japan 430
Tel: 053-460-2311

OCEANIA

AUSTRALIA

Yamaha Music Australia Pty. Ltd.
17-33 Market Street, South Melbourne, Vic. 3205,
Australia
Tel: 3-699-2388

NEW ZEALAND

Music Houses of N.Z. Ltd.
146/148 Captain Springs Road, Te Papapa,
Auckland, New Zealand
Tel: 9-634-0099

COUNTRIES AND TRUST TERRITORIES IN PACIFIC OCEAN

**Yamaha Corporation,
International Marketing Division**
Nakazawa-cho 10-1, Hamamatsu, Japan 430
Tel: 053-460-2311

HEAD OFFICE Yamaha Corporation, Electronic Musical Instrument Division

Nakazawa-cho 10-1, Hamamatsu, Japan 430
Tel: 053-460-3255

YAMAHA
YAMAHA CORPORATION