



Clavinova[®]

CLP-970

CLP-970M

CLP-970C

Owner's manual

IMPORTANT

Check your power supply

Make sure that your local AC mains voltage matches the voltage specified on the name plate on the bottom panel. In some areas a voltage selector may be provided on the bottom panel of the main keyboard unit near the power cord. Make sure that the voltage selector is set for the voltage in your area. The voltage selector is set at 240V when the unit is initially shipped. To change the setting use a "minus" screwdriver to rotate the selector dial so that the correct voltage appears next to the pointer on the panel.



YAMAHA

SPECIAL MESSAGE SECTION

PRODUCT SAFETY MARKINGS: Yamaha electronic products may have either labels similar to the graphics shown below or molded/stamped facsimiles of these graphics on the enclosure. The explanation of these graphics appears on this page. Please observe all cautions indicated on this page and those indicated in the safety instruction section.

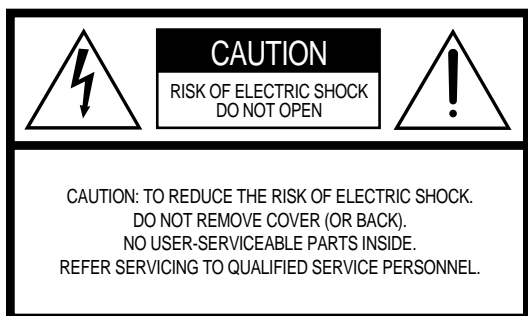

See bottom of Keyboard enclosure for graphic symbol markings



The exclamation point within the equilateral triangle is intended to alert the user to the presence of important operating and maintenance (servicing) instructions in the literature accompanying the product.

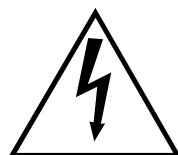

The lightning flash with arrowhead symbol, within the equilateral triangle, is intended to alert the user to the presence of uninsulated “dangerous voltage” within the product’s enclosure that may be of sufficient magnitude to constitute a risk of electrical shock.

IMPORTANT NOTICE: All Yamaha electronic products are tested and approved by an independent safety testing laboratory in order that you may be sure that when it is properly installed and used in its normal and customary manner, all foreseeable risks have been eliminated. DO NOT modify this unit or commission others to do so unless specifically authorized by Yamaha. Product performance and/or safety standards may be diminished. Claims filed under the expressed warranty may be denied if the unit is/has been modified. Implied warranties may also be affected.

SPECIFICATIONS SUBJECT TO CHANGE: The information contained in this manual is believed to be correct at the time of printing. However, Yamaha reserves the right to change or modify any of the specifications without notice or obligation to update existing units.

ENVIRONMENTAL ISSUES: Yamaha strives to produce products that are both user safe and environmentally friendly. We sincerely believe that our products and the production methods used to produce them, meet these goals. In keeping with both the letter and the spirit of the law, we want you to be aware of the following:

Battery Notice: This product MAY contain a small non-rechargeable battery which (if applicable) is soldered in place. The average life span of this type of battery is approximately five years. When replacement becomes necessary, contact a qualified service representative to perform the replacement.

Warning: Do not attempt to recharge, disassemble, or incinerate this type of battery. Keep all batteries away from children. Dispose of used batteries promptly and as regulated by applicable laws. Note: In some areas, the servicer is required by law to return the defective parts. However, you do have the option of having the servicer dispose of these parts for you.

Disposal Notice: Should this product become damaged beyond repair, or for some reason its useful life is considered to be at an end, please observe all local, state, and federal regulations that relate to the disposal of products that contain lead, batteries, plastics, etc.

NOTICE: Service charges incurred due to lack of knowledge relating to how a function or effect works (when the unit is operating as designed) are not covered by the manufacturer’s warranty, and are therefore the owners responsibility. Please study this manual carefully and consult your dealer before requesting service.

NAME PLATE LOCATION: The graphic below indicates the location of the name plate. The model number, serial number, power requirements, etc., are located on this plate. You should record the model number, serial number, and the date of purchase in the spaces provided below and retain this manual as a permanent record of your purchase.

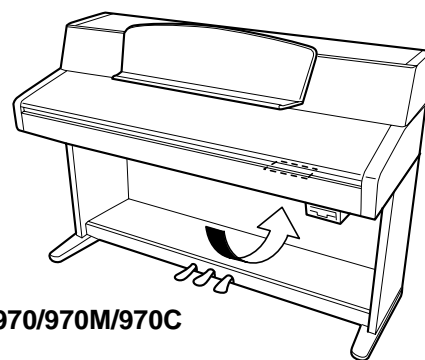

CLP-970/970M/970C

Model _____

Serial No. _____

Purchase Date _____

PRECAUTIONS

PLEASE READ CAREFULLY BEFORE PROCEEDING

* Please keep these precautions in a safe place for future reference.



WARNING

Always follow the basic precautions listed below to avoid the possibility of serious injury or even death from electrical shock, short-circuiting, damages, fire or other hazards. These precautions include, but are not limited to, the following:

- Do not open the instrument or attempt to disassemble the internal parts or modify them in any way. The instrument contains no user-serviceable parts. If it should appear to be malfunctioning, discontinue use immediately and have it inspected by qualified Yamaha service personnel.
- Do not expose the instrument to rain, use it near water or in damp or wet conditions, or place containers on it containing liquids which might spill into any openings.
- If the power cord or plug becomes frayed or damaged, or if there is a sudden loss of sound during use of the instrument, or if any unusual smells or smoke should appear to be caused by it, immediately turn off the power switch, disconnect the electric plug from the outlet, and have the instrument inspected by qualified Yamaha service personnel.
- Only use the voltage specified as correct for the instrument. The required voltage is printed on the name plate of the instrument.
- Before cleaning the instrument, always remove the electric plug from the outlet. Never insert or remove an electric plug with wet hands.
- Check the electric plug periodically and remove any dirt or dust which may have accumulated on it.

PRECAUTIONS



CAUTION

Always follow the basic precautions listed below to avoid the possibility of physical injury to you or others, or damage to the instrument or other property. These precautions include, but are not limited to, the following:

- Do not place the power cord near heat sources such as heaters or radiators, and do not excessively bend or otherwise damage the cord, place heavy objects on it, or place it in a position where anyone could walk on, trip over, or roll anything over it.
- When removing the electric plug from the instrument or an outlet, always hold the plug itself and not the cord. Pulling by the cord can damage it.
- Do not connect the instrument to an electrical outlet using a multiple-connector. Doing so can result in lower sound quality, or possibly cause overheating in the outlet.
- Remove the electric plug from the outlet when the instrument is not to be used for extended periods of time, or during electrical storms.
- Before connecting the instrument to other electronic components, turn off the power for all components. Before turning the power on or off for all components, set all volume levels to minimum. Also, be sure to set the volumes of all components at their minimum levels and gradually raise the volume controls while playing the instrument to set the desired listening level.
- Do not expose the instrument to excessive dust or vibrations, or extreme cold or heat (such as in direct sunlight, near a heater, or in a car during the day) to prevent the possibility of panel disfiguration or damage to the internal components.
- Do not use the instrument near other electrical products such as televisions, radios, or speakers, since this might cause interference which can affect proper operation of the other products.
- Do not place the instrument in an unstable position where it might accidentally fall over.
- Before moving the instrument, remove all connected cables.
- When cleaning the instrument, use a soft, dry or slightly damp cloth. Do not use paint thinners, solvents, cleaning fluids, or chemical-impregnated wiping cloths. Also, do not place vinyl, plastic or rubber objects on the instrument, since this might discolor the panel or keyboard.
- Do not rest your weight on, or place heavy objects on the instrument, and do not use excessive force on the buttons, switches or connectors.
- Take care that the key cover does not pinch your fingers, and do not insert a finger or hand in the key cover gap.
- Never insert or drop paper or metallic or other objects between the slits of the key cover and the keyboard. If this happens, immediately turn off the power and remove the electric plug from the outlet and have the instrument inspected by qualified Yamaha service personnel.
- Do not place the instrument against a wall (allow at least 3 cm/one-inch from the wall), since this can cause inadequate air circulation, and possibly result in the instrument overheating.
- Read carefully the attached documentation explaining the assembly process. Failure to assemble the instrument in the proper sequence might result in damage to the instrument or even injury.
- Do not operate the instrument for a long period of time at a high or uncomfortable volume level, since this can cause permanent hearing loss. If you experience any hearing loss or ringing in the ears, consult a physician.

PRECAUTIONS

■ USING THE BENCH (If included)

- Do not play carelessly with or stand on the bench. Using it as a tool or step-ladder or for any other purpose might result in accident or injury.
- Only one person should sit on the bench at a time, in order to prevent the possibility of accident or injury.
- If the bench screws become loose due to extensive long-term use, tighten them periodically using the included tool.

■ SAVING USER DATA

- Always save data to a floppy disk or an external device such as the Yamaha MIDI Data Filer MDF3 frequently, in order to help prevent the loss of important data due to a malfunction or user operating error.

Yamaha cannot be held responsible for damage caused by improper use or modifications to the instrument, or data that is lost or destroyed.

Always turn the power off when the instrument is not in use.

Clavinova[®]



YAMAHA

Thank you for choosing the Yamaha Clavinova CLP-970/970M/970C. In order to make the most of your Clavinova's performance potential and features, please read this Owner's Manual thoroughly, and keep it in a safe place for later reference.

About this Owner's Manual and Reference Booklet

This manual consists of four main sections: "Introduction," "Basic Operation," "Detailed Settings," and "Appendix." Also, a separate "Reference Booklet" is provided.

Introduction: Please read this section first. In the "Application Index" section on page 11 and "Features" on page 16, you can learn how to use the Clavinova and its functions in particular situations.

Basic Operation: This main section explains how to use the basic functions. Refer to this section while you play the Clavinova. If you have questions or come across the words you do not know, refer to the section entitled "Questions about Operations and Functions" on page 97, or the "Index" on page 109.

Detailed Settings: This section explains how to make detailed settings for the Clavinova's various functions. Refer to this section as necessary.

Appendix: This section introduces troubleshooting, a description of preset voices, and other reference material.

Reference Booklet: XG Voice List, MIDI Data Format, etc.

* The models CLP-970M and CLP-970C will be referred to as the CLP-970 in this Owner's Manual.

- The illustrations and LCD screens as shown in this Owner's Manual are for instructional purposes only, and may appear somewhat different from those on your instrument.
- Unauthorized copying of copyrighted software for purposes other than the purchaser's personal use is prohibited.

■ Trademarks

- Apple and Macintosh are trademarks of Apple Computer, Inc., registered in the U.S. and other countries.
- IBM-PC/AT is a trademark of International Business Machines Corporation.
- Windows is the registered trademark of Microsoft[®] Corporation.

All other trademarks are the property of their respective holders.

"The Clavinova-Computer Connection" is a supplementary guidebook that describes, for beginners, what you can do with your Clavinova and a personal computer and how to set up a Clavinova-Computer system (the manual is not written for any specific models). The document is available as a PDF file (in English) at the following Internet address:

Clavinova Web site:

<http://www.yamaha.co.jp/english/product/cl/>

Yamaha Manual Library (Electronic Musical Instruments)

<http://www2.yamaha.co.jp/manual/english/>

Table of contents

Introduction..... 2

PRECAUTIONS 3

About this Owner's Manual and Reference Booklet..... 6

Table of contents 7

Application Index

Use this index to find reference pages that may be helpful for your application and situation. 11

Handling the Floppy Disk Drive(FDD) and Floppy Disk 13

Maintenance 14

Included Accessories 15

Features 16

Before Using the Clavinova..... 18

Key cover 18

Music stand 18

Turning the power on..... 19

Adjusting the display contrast 20

Setting the volume 20

Using headphones..... 20

Basic Operation 21

Part Names 22

Listening to the Demonstration Tunes..... 24

Listening to 50 Piano Preset Songs 26

Playing the 50 piano preset songs 26

Practicing a one-hand part using 50 preset songs 28

Selecting and Playing Voices 30

Selecting Voices..... 30

Using the pedals 31

Adding variation to the sound [BRILLIANCE]/[REVERB]/[CHORUS] 32

Transposition ... [TRANSPOSE]..... 34

Combining two voices (Dual mode)..... 35

Splitting the keyboard range and playing two different voices (Split mode) 37

Using the metronome 40

Recording Your Performance..... 41

Recording a New Song..... 41

Recording to [TRACK 1] 41

Re-recording TRACK 1..... 43

Re-recording TRACK 1 partially..... 44

Recording to [TRACK2]..... 45

Recording to the third or more tracks [EXTRA TRACKS] 46

Other recording techniques..... 46

Adding data to or recording over an existing song 46

Table of contents

Changing a voice or tempo after recording	47
Adjusting the volume balance between playback and your performance [SONG BALANCE]	48
Recording in Dual or Split mode	49
Saving Recorded Songs and Handling the Files...[FILE]	50
Clavinova memory	50
Basic file operation	51
Saving recorded or other songs to Clavinova Storage memory...[SaveToMemory]	52
Saving recorded or other songs to floppy disk...[SaveToDisk]	53
Deleting songs in Clavinova Storage memory or a floppy disk...[DeleteSong]	53
Renaming a song...[RenameSong]	54
Copying data from one floppy disk to another...[CopyDisk]	55
Formatting a floppy disk...[FormatDisk]	56
Changing the type of characters on screen...[CharacterCode]	56
Playing Back Recorded Songs and Commercially-available Music Data	57
Playing back a song	57
Turning track playback on and off.....	59
Supported song data type	59
Connections	61
Connectors	61
Connecting a personal computer	63

Detailed Settings 69

Detailed Settings.....	70
Parameter List	70
Making detailed settings	72
Detailed settings for recording and playback [SONG SETTING]	74
Correcting note timing [Quantize]	74
Specifying whether playback starts immediately along with the first voicing [QuickPlay]	75
Auditioning the channels [ChannelListen]	75
Deleting data from each channel [ChannelClear].....	75
Specifying the range and playing back repeatedly [FromToRepeat]	75
Playing back the phrase specified by the phrase number [PhraseMark]	76
Playing back a song repeatedly [SongRepeat]	76
Detailed settings for the metronome METRONOME [SETTING]	77
Setting the metronome time signature [TimeSignature].....	77
Setting the metronome volume level [MetronomeVolume].....	77
Selecting the metronome voice [MetronomeSound]	77
Detailed settings for the voices [VOICE SETTING]	78
Setting the octave [Octave]*	78
Setting the volume level [Volume]*	78
Setting the position of right and left channels [Pan]*	79
Fine tuning the pitch (only in Dual mode) [Detune]	79
Selecting the reverb type [ReverbType]	79
Setting the reverb depth [ReverbSend]*	79

Selecting the chorus type [Chorus Type].....	80
Setting the chorus depth [ChorusSend]*.....	80
Setting the chorus on/off [ChorusOnOff].....	80
Selecting the variation effect type [VariationType]	80
Setting the variation effect depth [VariationSend]*	81
Setting the touch sensitivity [TouchSense]*.....	81
Setting the right pedal function [RPedal].....	81
Setting the center pedal function [MPedal]	82
Setting the left pedal function [LPedal]	82
Setting the auxiliary pedal function [AuxPedal]	82
MIDI [MIDI SETTING].....	83
About MIDI.....	83
Setting the MIDI transmit channel [MidiOutChannel]	84
Setting the MIDI receive channel (Port A) [MidiInAChannel]	84
Setting the MIDI receive channel (Port B) [MidiInAChannel]	85
Setting Local control on/off [LocalControl].....	85
Selecting performance from the keyboard or song data for MIDI transmission [MidiOutSelect]	85
Selecting a type of data received via MIDI [ReceiveParameter].....	85
Selecting a type of data transmitted via MIDI [TransmitParameter]	86
Executing song data bulk dump [SongBulkDump].....	86
Transmitting the initial settings on the panel [InitialSetup]	86
Executing voice data bulk dump [VoiceBulkDump].....	86
Other settings	87
Selecting a touch response [TouchResponse]	87
Fine tuning the pitch [Tune].....	87
Selecting a tuning curve for a piano voice [PianoTuningCurve]	87
Selecting a scale [Scale].....	88
Depth of string resonance [StringResonanceDepth]	88
Depth of sustain sampling for the damper pedal [SustainSamplingDepth].....	88
Setting the speed of vibraphone's vibrato effect [VibraphoneRotorSpeed]	89
Selecting a pedal function for vibraphone [VibraphonePedalMode]	89
Assigning the START/PAUSE function to a pedal [PedalStart/Pause].....	89
Selecting a type of auxiliary pedal [AuxPedalType].....	89
Setting the point at which the damper pedal starts to affect the sound [HalfPedalPoint]	90
Pitch bend range [PitchBendRange].....	90
Replacing the XG voices with preset voices [XGAlternative]	90
Selecting items saved at shutdown [MemoryBackUp]	91
Restoring the normal (default) settings [FactorySet]	91
Other method for restoring the normal settings	91
Message List.....	92
Questions about Operations and Functions.....	97

Appendix	99
Troubleshooting.....	100
Data Compatibility	101
Preset Voice List	103
Voice Combination Examples (Dual and Split)	105
CLP-970/970M/970C: Keyboard Stand Assembly	106
Index.....	109

Application Index

Use this index to find reference pages that may be helpful for your application and situation.

Settings

- Making detailed settings for recording and playback
..... “Detailed settings for recording and playback [SONG SETTING]” on page 74
- Making detailed settings for the metronome
..... “Detailed settings for the metronome METRONOME [SETTING]” on page 77
- Making detailed settings for the voices
..... “Detailed settings for the voices [VOICE SETTING]” on page 78
- Making detailed settings for MIDI “MIDI [MIDI SETTING]” on page 83
- Making detailed settings for the Clavinova “Other settings” on page 87

Connecting the Clavinova to other devices

- What is MIDI?..... “MIDI [MIDI SETTING]” on page 83
- Recording your performance “AUX OUT [R], [L/L+R] jacks” on page 61
- Raising the volume “AUX OUT [R], [L/L+R] jacks” on page 61
- Outputting other instruments’ sound from the Clavinova “AUX IN [R], [L/L+R] jacks” on page 62
- Connecting a computer..... “Connecting a personal computer” on page 63

Assembling

- Assembling and disassembling the Clavinova
..... “CLP-970/970M/970C: Keyboard Stand Assembly” on page 106

Quick solution

- What the Clavinova offers..... “Application Index” on page 11
..... “Features” on page 16
- Returning to the main screen..... “[EXIT] button” on page 23
- Resetting the Clavinova to the default setting
..... “Restoring the normal (default) settings [FactorySet]” on page 91
- Meaning of the messages..... “Message List” on page 92
- If you have questions about operations and functions
..... “Questions about Operations and Functions” on page 97
- Troubleshooting..... “Troubleshooting” on page 100

Handling the Floppy Disk Drive(FDD) and Floppy Disk

Precautions

Be sure to handle floppy disks and treat the disk drive with care. Follow the important precautions below.

Compatible Disk Type

3.5" 2DD and 2HD type floppy disks can be used.

Inserting/Ejecting Floppy Disks

To insert a floppy disk into the disk drive:

Hold the disk so that the label of the disk is facing upward and the sliding shutter is facing forward, towards the disk slot. Carefully insert the disk into the slot, slowly pushing it all the way in until it clicks into place and the eject button pops out.

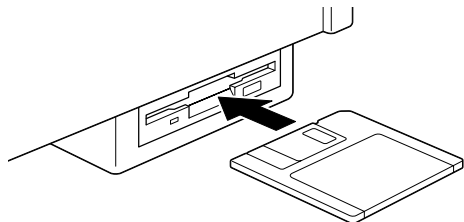

To eject a floppy disk:

Before ejecting the disk, be sure to confirm that the floppy disk drive is stopped. If the disk drive is operating (during the [SaveToDisk] (P53), [DeleteSong] (P53), [RenameSong] (P54), [CopyDisk] (P55), or [FormatDisk] (P56) operation), the Clavinova displays [Executing].

Never attempt to remove the disk or turn the power off when the disk drive is operating. Doing so can damage the disk and possibly the disk drive.

Press the eject button slowly as far as it will go; the disk will automatically pop out. When the disk is fully ejected, carefully remove it by hand.

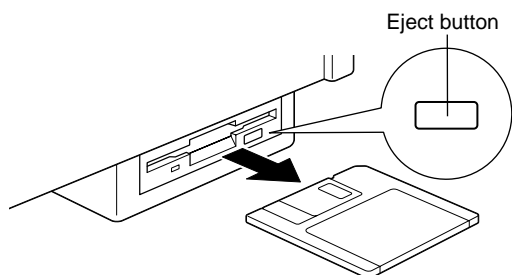

If the eject button is pressed too quickly, or if it is not pressed in as far as it will go, the disk may not eject properly. The eject button may become stuck in a half-pressed position with the disk extending from the drive slot by only a few millimeters. If this happens, do not attempt to pull out the partially ejected disk, since using force in this situation can damage the disk drive mechanism or the floppy disk. To remove a partially ejected disk, try pressing the eject button once again, or push the disk back into the slot and then repeat the eject procedure.

Be sure to remove the floppy disk from the disk drive before turning off the power. A floppy disk left in the drive for extended periods can easily pick up dust and dirt that can cause data read and write errors.

Cleaning the Disk Drive Read/Write Head

- Clean the read/write head regularly. This instrument employs a precision magnetic read/write head which, after an extended period of use, will pick up a layer of magnetic particles from the disks used that will eventually cause read and write errors.
- To maintain the disk drive in optimum working order Yamaha recommends that you use a commercially-available dry-type head cleaning disk to clean the head about once a month. Ask your Yamaha dealer about the availability of proper head-cleaning disks.
- Never insert anything but floppy disks into the disk drive. Other objects may cause damage to the disk drive or floppy disks.

Handling the Floppy Disk Drive(FDD) and Floppy Disk

About the Floppy Disks

- **To handle floppy disks with care:**
- Do not place heavy objects on a disk or bend or apply pressure to the disk in any way. Always keep floppy disks in their protective cases when they are not in use.
- Do not expose the disk to direct sunlight, extremely high or low temperatures, or excessive humidity, dust or liquids.
- Do not open the sliding shutter and touch the exposed surface of the floppy disk inside.
- Do not expose the disk to magnetic fields, such as those produced by televisions, speakers, motors, etc., since magnetic fields can partially or completely erase data on the disk, rendering it unreadable.
- Never use a floppy disk with a deformed shutter or housing.
- Do not attach anything other than the provided labels to a floppy disk. Also make sure that labels are attached in the proper location.

- **To protect your data (Write-protect Tab):**
- To prevent accidental erasure of important data, slide the disk's write-protect tab to the "protect" position (tab open).

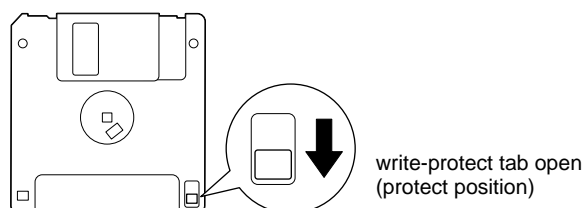

- **Data backup**
- For maximum data security Yamaha recommends that you keep two copies of important data on separate floppy disks. This gives you a backup if one disk is lost or damaged. To make a backup disk use the Copy Disk function on page 55.

Maintenance

Clean the instrument using a dry, soft cloth or slightly damp, soft cloth (wring well).



Do not use benzine, thinner, detergent, or chemical cloth for cleaning. Do not place vinyl, plastic, or rubber products on the instrument.

Otherwise, the panel or keys may be discolored or degraded.

Before using the Clavinova, be sure to read "Precautions" on pages 3-5.

Tuning

Unlike an acoustic piano, the Clavinova does not need to be tuned. It always stays perfectly in tune.

Transporting

If you move to another location, you can transport the Clavinova along with other stuff. You can move the unit as it is (assembled) or you can disassemble the unit down to the condition when you first open the package. Transport the keyboard horizontally. Do not lean it to the wall and the like.

Included Accessories

"50 greats for the Clavinova" Score Collection



Recording disk

Save your recorded performance to this disk. (page 53)

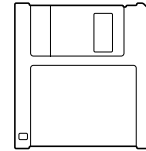

Owner's Manual



Bench

(included or optional depending on locale)

Reference Booklet



Features

The Yamaha Clavinova CLP-970 digital piano offers unmatched sonic realism and natural grand-piano type playability as well as Yamaha's original "AWM Dynamic Stereo Sampling" tone generation technology for rich, musical voices, and a special "Graded Hammer" keyboard that provides graded key weight and response throughout the keyboard range. The CLP-970 GrandPiano1 voice features totally new samples painstakingly recorded from a full concert grand piano. The CLP-970 GrandPiano1 voice features five velocity-switched samples (**Dynamic Sampling**), a "Soundboard Reverb" (page 33) effect that accurately simulates the resonance of a piano soundboard, "String Resonance" (page 88) that recreates resonance of piano strings, special "Sustain Sampling" (page 88) that samples the unique resonance of an acoustic grand piano's soundboard and strings when the damper pedal is pressed, and "Key-off Samples" that add the subtle sound produced when the keys are released. The CLP-970 comes much closer to the sound of a true acoustic piano.

The music stand can be removed to allow placement of a laptop-type personal computer or other equipment on top of the instrument. (page 18)

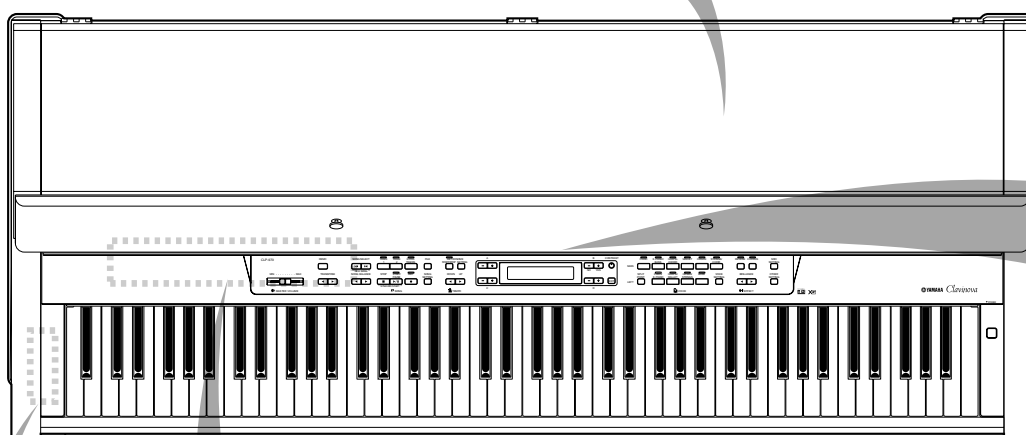

Connect an optional pedal here and assign one of the various functions to the pedal. (page 62)

Connect the pedal cord here to use the Clavinova's pedals. (page 63)

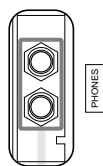

A set of standard stereo headphones can be plugged in here for private practice. (page 20)

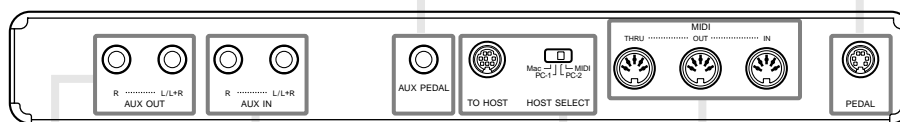

These jacks allow you to connect an external tone generator to reproduce the sound via the Clavinova's internal sound system and speakers. (page 62)

Connect a MIDI device here to use various MIDI functions. (page 63, 66) (About MIDI—page 83)

Connect recording equipment (such as a cassette tape recorder) here to record your performance. (page 61)

This jack and selector switch allow direct connection to a personal computer for sequencing and other music applications. (page 62-67)

The Clavinova includes 50 preset songs.
This section enables you to listen to these songs, practice using a convenient practice function, play back Clavinova music data (sold in music stores), and record and play back your performance. (page 26, 41, 57)

The display allows accurate control and operation. (page 23)

[MIDI SETTING]
Make detailed MIDI settings, such as MIDI receive/transmit channels. (page 83)

[FILE]
Save recorded songs and manage song files. (page 50)

MAIN voice group buttons
Select voices from 25 internal sounds including Grand Piano 1. (page 30)
You can also combine two voices at a time. (page 35)

[DEMO]
Demonstration playback is available for each voice. (page 24)

[METRONOME]
Use the metronome functions. (page 40)

[CONTRAST]
Adjust the brightness of the display using this control. (page 20)

[REVERB]/[CHORUS]
Add reverb (reverberation) and spread (chorus) to the sound. (page 33)

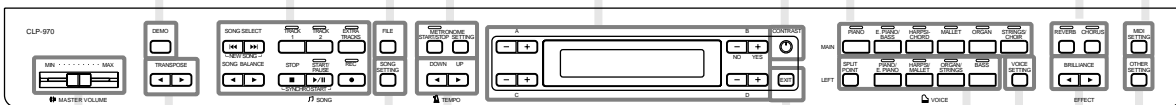

[MASTER VOLUME]
Adjust the volume level using this slider. (page 20)

[SONG SETTING]
Make detailed settings for song recording and playback. (page 74)

[EXIT]
The screen returns to its main display when you press this button. (page 23)

TRANSPOSE [◀] [▶]
You can shift the pitch of the entire keyboard up or down so that the pitch will match that of another instrument or singer, while you play the same keys. (page 34)

TEMPO [DOWN] [UP]
You can change the song tempo (speed). (page 27, 40, 42, 58)

[VOICE SETTING]
You can make detailed settings for tone and effects. (page 78)

BRILLIANCE [◀] [▶]
Adjust the brightness of the tone using these buttons. (page 32)

LEFT voice group buttons/[SPLIT POINT]
You can play different voices on the left- and right-hand sections of the keyboard. (page 37)

[OTHER SETTING]
Fine-tune the touch response and pitch, etc. (page 87)

Before Using the Clavinova

Key cover

To open the key cover:

Lift the cover slightly, then push and slide it open.

To close the key cover:

Slide the cover toward you and gently lower the cover over the keys.

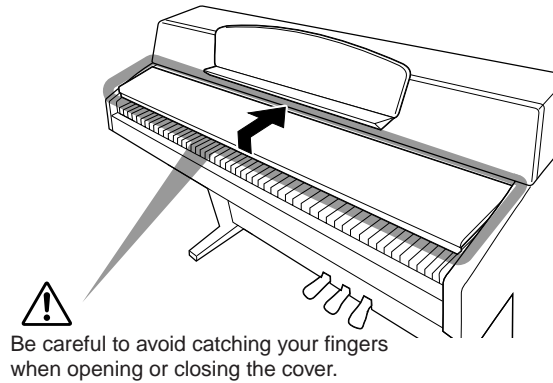

Be careful to avoid catching your fingers when opening or closing the cover.

⚠ CAUTION

Hold the cover with both hands when opening or closing it. Do not release it until it is fully opened or closed. Be careful to avoid catching fingers (yours or others, especially children's between the cover and the unit).

Do not place objects such as a piece of metal or paper on top of the key cover. Small objects placed on the key cover may fall inside the unit when the cover is opened and may be nearly impossible to remove. This could cause electric shock, short circuit, fire or other serious damage to the instrument.

Music stand

To install the music stand:

Hold the upper and bottom sides of the music stand with both hands and insert the peg on the speaker box into the holes on the rear of the stand.

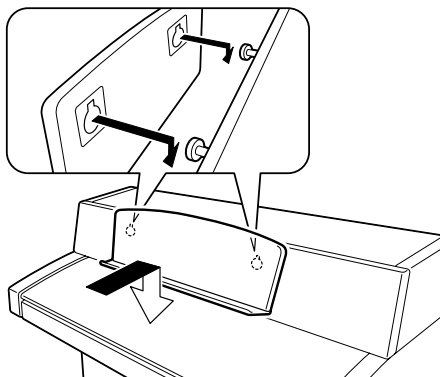

- The music stand can be removed to allow placement of a laptop personal computer or other equipment on top of the instrument.

To remove the music stand:

Lift the music stand slightly, then pull it toward you to remove it.

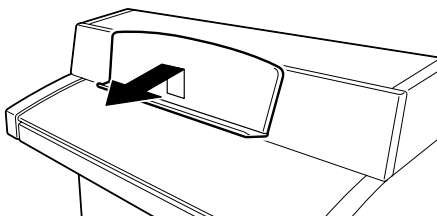

Turning the power on

1. Connect the power cable.

First insert the plug of the power cable into the AC connector on the Clavinova, then plug the other end of the cable into the proper AC outlet on the wall.

In some areas a plug adaptor may be provided to match the pin configuration of the AC wall outlets in your area.

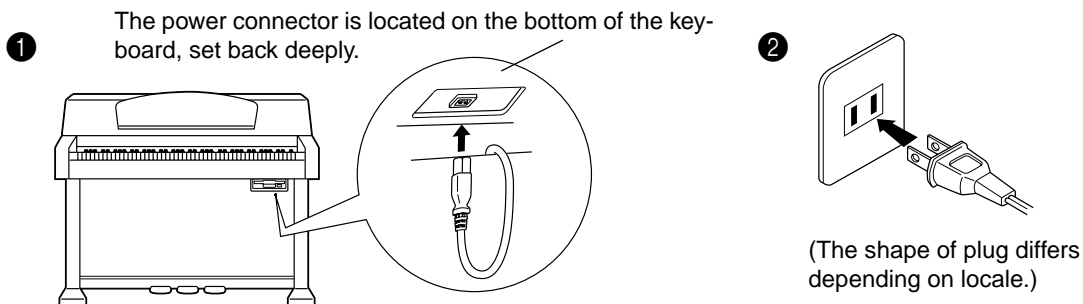

WARNING!

Make sure your CLP-970 is rated for the AC voltage supplied in the area in which it is to be used (voltage rating appears on the name plate on the bottom panel). In some areas, a voltage selector may be provided on the bottom panel of the main keyboard unit near the power cord. Make sure that the voltage selector is set for the voltage in your area. Connecting the unit to the wrong AC supply can cause serious damage to the internal circuitry and may even pose a shock hazard!

Use only the AC power cord supplied with the CLP-970. If the supplied cord is lost or damaged and needs to be replaced, contact your Yamaha dealer. The use of an inappropriate replacement can pose a fire and shock hazard!

The type of AC power cord provided with the CLP-970 may be different depending on the country in which it is purchased. (In some areas a plug adaptor may be provided to match the pin configuration of the AC wall outlets in your area.) Do NOT modify the plug provided with the CLP-970. If the plug will not fit the outlet, have a proper outlet installed by a qualified electrician.

2. Turn on the power to the Clavinova.

Press the [POWER] switch located on the right of the keyboard to turn the power on.

- The screen located in the center of the front panel and the power indicator located below the left end of the keyboard lights up.

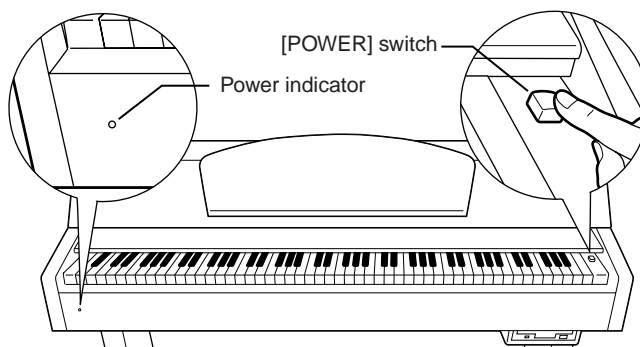

TIP

Power indicator

If you close the key cover without turning the power off, the power indicator remains lit, indicating that the power is still on.



When you turn on the power to the Clavinova, a voice name appears on the screen.

Press the [POWER] switch again to turn off the power to the Clavinova.

- The screen and the power indicator turn off.

Adjusting the display contrast

You can adjust the contrast of the display by turning the [CONTRAST] knob located to the right of the LCD.

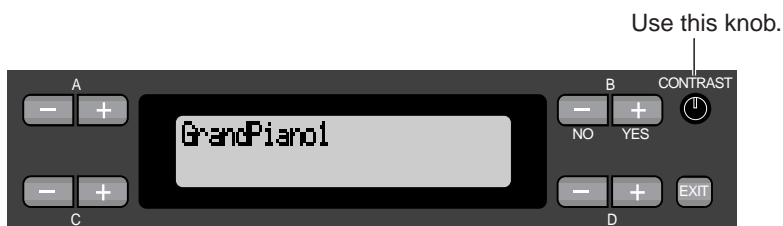

TERMINOLOGY

CONTRAST:
difference between brightness and darkness

Setting the volume

While playing the keyboard, adjust the volume level by moving the [MASTER VOLUME] slider on the left of the front panel to the left or right.

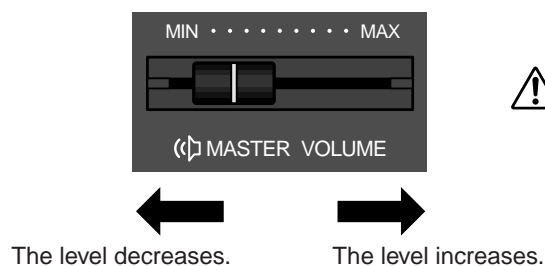

⚠ Do not use the Clavinova at a high volume level for a long period of time, or your hearing may be damaged.

TERMINOLOGY

MASTER VOLUME:
The volume level of the entire keyboard sound

TIP

You can also adjust the [PHONES] output level and the AUX IN input level using the [MASTER VOLUME] slider.

Using headphones

Connect a pair of headphones to one of the [PHONES] jacks. When the headphones are plugged into either of the [PHONES] jacks, the internal speaker system is automatically shut off.

Two [PHONES] jacks are provided. Two sets of standard stereo headphones can be plugged in. (If you are using only one pair of headphones, you can plug them into either of these jacks.)

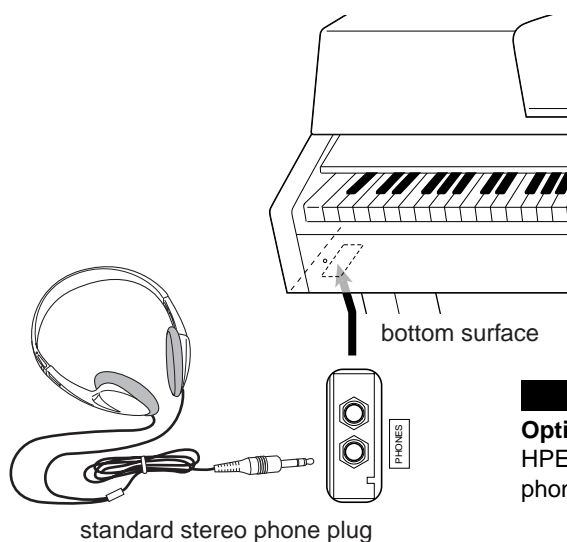

TIP

Optional headphones
HPE-160 Yamaha headphones.

Basic Operation

Part Names

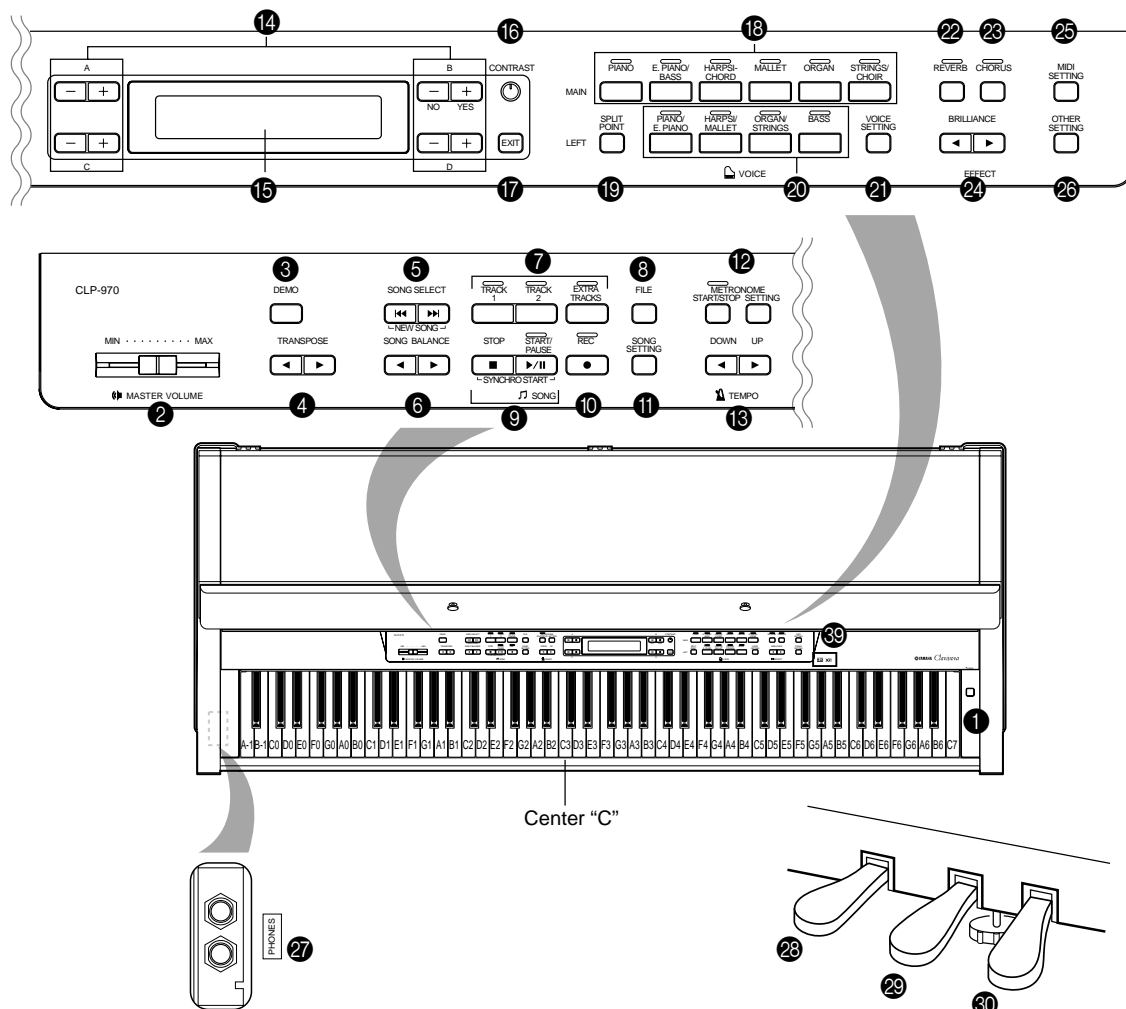

Top panel

- | | |
|---|--|
| ① [POWER]..... P19 | ⑮ LCD screen P23 |
| ② [MASTER VOLUME]..... P20 | ⑯ [CONTRAST] knob..... P20 |
| ③ [DEMO] P24 | ⑰ [EXIT]..... P23 |
| ④ TRANSPOSE [◀] [▶] P34 | ⑱ Voice group buttons for the MAIN section P30 |
| ⑤ SONG SELECT [◀◀] [▶▶]..... P26, 41, 57 | ⑲ [SPLIT POINT] P38 |
| ⑥ SONG BALANCE [◀] [▶]..... P48 | ⑳ Voice group buttons for the LEFT section P37 |
| ⑦ [TRACK1] [TRACK2] / [EXTRA TRACKS] P28, 41–46, 59 | ㉑ [VOICE SETTING] P78 |
| ⑧ [FILE] P50 | ㉒ [REVERB]..... P33 |
| ⑨ SONG [STOP] / [START/PAUSE] P26, 42, 58 | ㉓ [CHORUS]..... P33 |
| ⑩ [REC]..... P42 | ㉔ BRILLIANCE [◀] [▶] P32 |
| ⑪ [SONG SETTING] P74 | ㉕ [MIDI SETTING]..... P83 |
| ⑫ METRONOME [START/STOP] / [SETTING]..... P40, 77 | ㉖ [OTHER SETTING] P87 |
| ⑬ TEMPO [DOWN] [UP] P27, 40, 42, 58 | ㉗ [PHONES] P20 |
| ⑭ LCD buttons A [-] [+] / B [- (NO)] [+ (YES)] / C [-] [+] / D [-] [+]..... P23 | ㉘ Soft pedal P31 |
| | ㉙ Sostenuto pedal P31 |
| | ㉚ Damper pedal P31 |

Connectors

- ① AUX OUT [R] [L/L+R] P61
- ② AUX IN [R] [L/L+R] P62
- ③ [AUX PEDAL] P62
- ④ [TO HOST] P62
- ⑤ HOST SELECT P62
- ⑥ MIDI [IN] [OUT] [THRU] P63
- ⑦ [PEDAL] P63

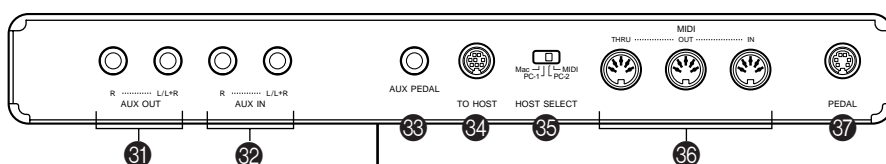

- ⑩ Floppy disk drive P13

⑪ Panel logos



GM System Level 1

“GM System Level 1” is an addition to the MIDI standard which guarantees that any data conforming to the standard will play accurately on any GM-compatible tone generator or synthesizer from any manufacturer.



XG Format

XG is a new Yamaha MIDI specification which significantly expands and improves on the “GM System Level 1” standard with greater voice handling capacity, expressive control, and effect capability while retaining full compatibility with GM.

⑫ LCD buttons

⑬ LCD

Use the LCD button A, B, C, or D to select the contents displayed on the LCD. Check the screen located in the center of the top panel after every operation. A voice name appears on the screen when you turn on the power to the unit.



⑭ [EXIT] button

When you press this button, the unit returns to the default screen (the screen that indicates a voice name(s) and is displayed when the power is turned on).

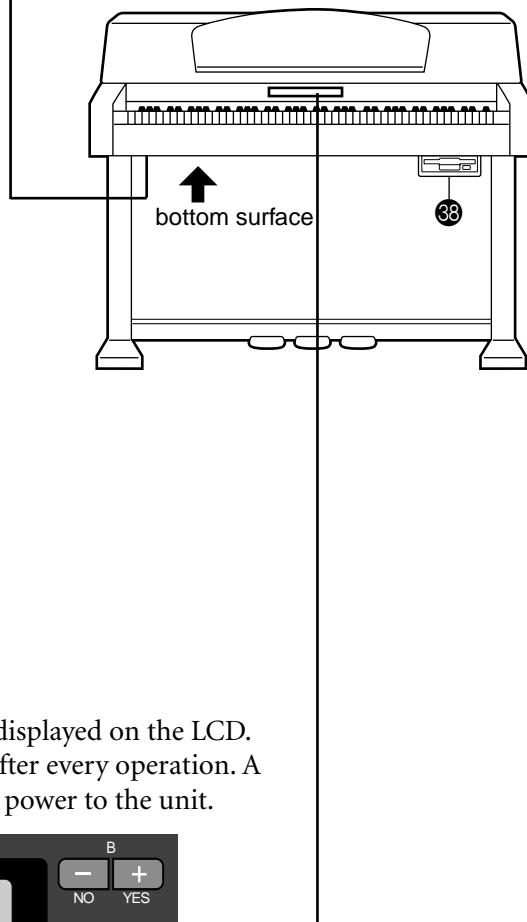

Listening to the Demonstration Tunes

The Clavinova provides demonstration tunes that effectively demonstrate each of the MAIN voice groups. Refer to the table below for voice names and corresponding demo songs.

Demonstration tunes

Voice group	Tunes	Composer
PIANO	Chanson de l'adieu	F.F. Chopin
E.PIANO/BASS	Original	—
HARPSICHORD	Le Coucou	L.C. Daguin
MALLET	Original	—
ORGAN	Organ Concerto Op.4 No.2	G.F. Händel
STRINGS/CHOIR	Original	—



Procedure

1. Engage the demo mode.

Press the [DEMO] button to engage the demo mode.

The MAIN voice group (upper row) button indicators light up in sequence.



2. Select a tune and start playback.

Press the voice group button (upper row) of the desired demonstration tune.

The corresponding voice button indicator lights up and playback starts. Until you stop playback, the selected tune will be played repeatedly using different voices (in the following order: PIANO → E. PIANO/BASS → HARPSICHORD → MALLET → ORGAN → STRINGS/CHOIR).

TERMINOLOGY

Mode:

A mode is a status under which you can execute a certain function. In demo mode, you can play back demonstration tunes.

NOTE

To adjust the volume level of the demo songs, use the [MASTER VOLUME] slider.

- 3.** Stop the playback.
Press the button of the voice group being played or the [STOP] button.
- 4.** Exit from demo mode.
Press the [DEMO] or [EXIT] button to exit from demo mode.

Listening to 50 Piano Preset Songs

The Clavinova provides performance data of 50 piano songs. You can just listen to these songs (page 26) or use them for practice (page 28). You can also refer to the included “50 greats for the Clavinova” that contains the scores for 50 piano preset songs.

Playing the 50 piano preset songs

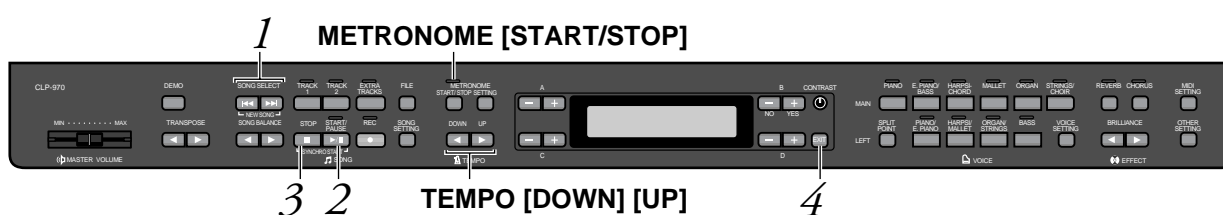

Procedure

1. Select a song.

Press one of the [SONG SELECT] buttons repeatedly to select the desired piano song from P-001 to P-050.

Song select screen



The song number appears on the display.

2. Play a preset song.

Press the [START/PAUSE] button to start playback.

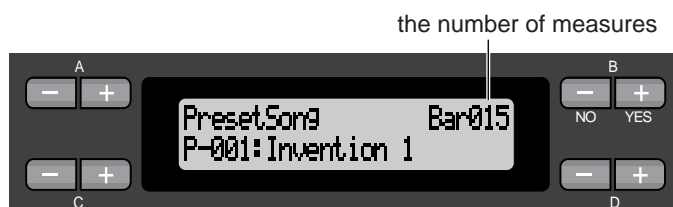

TERMINOLOGY

Song:

On the Clavinova, performance data is called a “Song.” This includes demonstration tunes and piano preset tunes.

TIP

- You can also use the C [-]/[+] buttons to select a song after pressing the [SONG SELECT] button.
- [P-000: NewSong] is a blank song provided for you to record your performance. (See page 41.)
- Use the SongRepeat parameter in the “SONG SETTING” menu to select repeat playback of all songs or repeat playback of a single song. (See page 76.)

TIP

You can play the keyboard along with the preset song playback. You can change the voice playing on the keyboard.

Adjusting the tempo

You can use the TEMPO [DOWN]/[UP] buttons to adjust the playback tempo as required. The default tempo (the song's original tempo) is set when you press the [DOWN] and [UP] buttons simultaneously. Press either of the SONG SELECT [◀◀]/[▶▶] buttons to return to the song select screen.



3. Stop the song playback.

When playback is complete, it automatically stops and the Clavinova locates the top of the song. To stop playback in the middle of a song, press the [STOP] button. You can also pause playback by pressing the [START/PAUSE] button. Playback stops when you press the button.

Fast forward and rewind

You can perform the following operations in the song select screen:

- Use the B [-]/[+] buttons to move back and forth (rewind and fast forward) through the song while the song is played or stopped.
- Press the SONG SELECT [◀◀] or the C [-] button during playback to restart playback from the top of the song.
- Press the SONG SELECT [▶▶] or the C [+] button during playback to start playback from the next song.
- Press the SONG SELECT [◀◀] or the C [-] button while playback is stopped in the middle of the song to locate the top of the song.

4. Return to the default screen.

Press the [EXIT] button.

TIP

You can also use the D[-]/[+] buttons to change the tempo.

NOTE

Resetting the tempo

Whenever you select a new preset song, the tempo is automatically reset to the song's original value.

TERMINOLOGY

Default screen:

The default screen is a voice select screen (page 30) that appears when you turn on the power to the Clavinova.

Practicing a one-hand part using 50 preset songs

The 50 preset songs have separate left- and right-hand parts on individual tracks. You can turn the left- and right-hand parts on or off as required so you can practice the corresponding part (the part that is turned off) on the keyboard. The right-hand part is played by [TRACK 1] and the left-hand part is played by [TRACK 2].

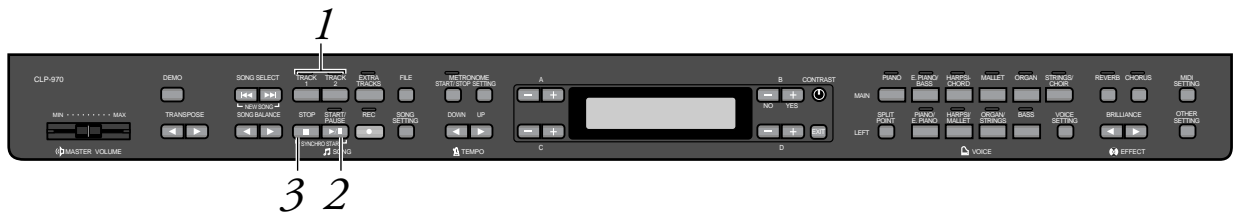

procedure

1. Turn off the playback part you wish to practice.
After you select a song to practice, press the [TRACK1] or [TRACK2] button to turn off the corresponding part.

When you first select a song, both [TRACK1] and [TRACK2] indicators light up, indicating that you can play back both parts. When you press one of the buttons to turn off playback, the corresponding button indicator turns off and the corresponding part playback is muted. Pressing the buttons repeatedly toggles between playback on and off.

2. Start playback and playing.
Press the [START/PAUSE] button to start playback. Play the part you just turned off.

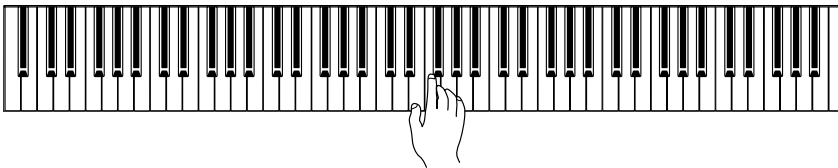

Starting playback automatically as you start playing the keyboard (Synchro Start)

You can start playback as soon as you start playing the keyboard. This is called the “Synchro Start” function.

To enter Synchro Start standby mode, press and hold down the [STOP] button and press the [START/PAUSE] button. The [START/PAUSE] indicator flashes.

Now play the keyboard. Playback starts simultaneously.

To cancel the Synchro Start function, press the [STOP] button while the Clavinova is in Synchro Start standby mode.

TIP

You can turn parts on or off, even during playback.

TERMINOLOGY

Synchro:
Synchronous; occurring at the same time

3. Stop playback.

When playback is complete, it automatically stops and the Clavinova locates the top of the song. If you wish to stop playback in the middle of a song, press the [STOP] button. You can also pause playback by pressing the [START/PAUSE] button. Playback stops when you press the button.

You can also assign a phrase in a song to repeatedly practice that part. Refer to the [FromToRepeat] option in the "SONG SETTING" menu on page 75.

TIP

Resetting the part playback

Both parts are automatically turned ON whenever you select a new song.

Selecting and Playing Voices

Selecting Voices

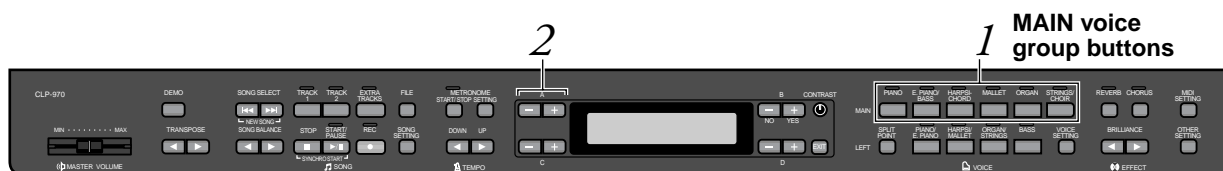

Procedure

1. Select a voice group.
Press one of the MAIN voice group buttons (upper row).
2. Select a voice.
Use the A [-]/[+] buttons to select a voice.

Voice group	Voice name	Voice group	Voice name
PIANO	GrandPiano1	MALLET	Vibraphone
	GrandPiano2		Marimba
E.PIANO/ BASS	E.Piano1		Celesta
	E.Piano2	PipeOrganPrincipal	
	SynthPiano	PipeOrganFlute1	
	WoodBass	PipeOrganFlute2	
	ElectricBass	PipeOrganTutti	
	Bass&Cymbal	JazzOrgan	
HARPSI- CHORD	Harpsichord8'	STRINGS/ CHOIR	Strings
	Harpsichord8'+4'		SynthStrings
	ElectricClavichord		SlowStrings
			Choir
			SlowChoir
			Scat

TIP

To learn characteristics of the voices, listen to demo songs for each voice group (page 24). Refer to "Preset Voice List" on page 103 for more information on characteristics of each preset voice.

TERMINOLOGY

Voice

On the Clavinova, a voice means "tone" or "tonal color."

TIP

You can control the loudness of a voice by how hard you play the keyboard, although different playing styles (touch sensitivities) have little or no effect with the sound of certain musical instruments. Refer to "Preset Voice List" on page 103.

Using the pedals

The Clavinova has three foot pedals: damper pedal (right), sostenuto pedal (center), and soft pedal (left) that produce a range of expressive effects similar to those produced by the pedals on an acoustic piano.

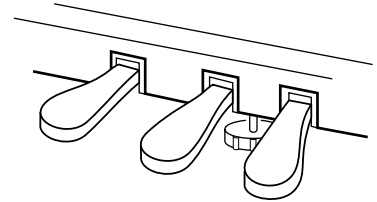

Damper (right) pedal

When you press the damper pedal, the notes you play have a longer sustain. When you select Grand Piano 1, pressing the damper pedal activates the instrument's special "Sustain Samples" to accurately recreate the unique resonance of an acoustic grand piano's soundboard and strings.

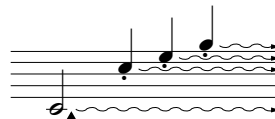

When you press the damper pedal here, the notes you play before you release the pedal have a longer sustain.

TIP

If the damper pedal doesn't work, or notes are sustained even when the pedal is not pressed, make sure that the pedal cord is properly plugged into the PEDAL jack on the unit (see step 5 on page 107). Also, make sure that the RPedal parameter in the "VOICE SETTING" menu is set to ON (see page 81).

Sostenuto (center) pedal

If you play a note or chord on the keyboard and press the sostenuto pedal while holding the note(s), the notes will sustain as long as the pedal is held. All subsequent notes will not sustain.

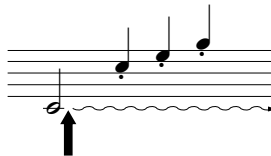

When you press the sostenuto pedal here while holding the note(s), the notes will sustain as long as you hold the pedal.

TIP

You can adjust the depth of the resonance produced by the "Sustain Samples" using the Sustain Sampling Depth parameter in the "OTHER SETTING" menu. (See page 88.)

Soft pedal (left)

The soft pedal reduces the volume and slightly changes the timbre of notes played while the pedal is pressed. (The soft pedal will not affect notes that are already playing when it is pressed. Press the pedal immediately before you play the target notes.)

With the Vibraphone and Jazz Organ voices, this pedal turns vibrato on and off or toggles the speed of vibrato. (See page 82.)

TIP

You can assign a function to each pedal via the "R Pedal", "M Pedal", and "L Pedal" parameters in the "VOICE SETTING" menu. (See page 81, 82.)

TIP

The center and left pedals can also be assigned to song start/stop operation (START/PAUSE function) via the "PedalStart/Pause" parameter in the "OTHER SETTING" menu (on page 89).

Adding variation to the sound [BRILLIANCE]/[REVERB]/[CHORUS]

The Effect function enables you to add expression to the sound. The Clavinova effects include Brilliance, Reverb, and Chorus.

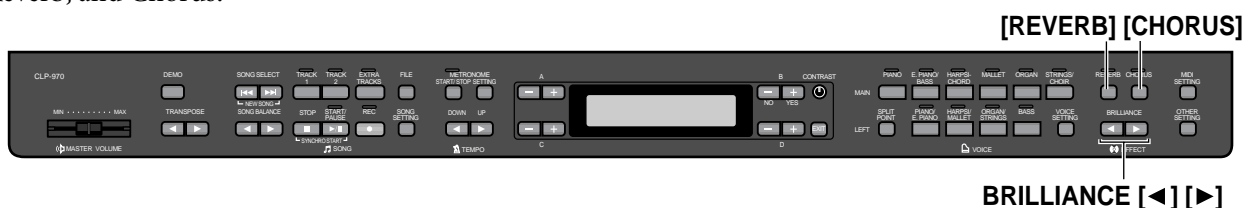

[BRILLIANCE]

You can use this control to adjust the brilliance of the tone and change the tonality to suit your preference.

Procedure

Press one of the **BRILLIANCE** [◀]/[▶] buttons to select the desired tonality.



- Dark**..... Dark tone
- Mellow** Soft and mellow tone
- Normal** Standard tone
- Bright** Bright tone
- Metallic**..... Sharp metallic tone

Press the **[EXIT]** button to return to the main screen.

TIP

You can also use the **D** [-]/[+] buttons after you press one of the **[BRILLIANCE]** buttons to select the desired option.

TIP

Normal setting = Normal

TERMINOLOGY

Normal setting:
The "Normal setting" refers to the default setting (factory setting) obtained when you first turn on the power to the Clavinova.

NOTE

If you select **[Bright]** or **[Metallic]** as the type of brilliance, the volume level will increase slightly. Under this condition, if you raise the **[MASTER VOLUME]** slider setting, the sound may become distorted. In this case, lower the volume accordingly.

[REVERB]

This control adds reverberation to the sound by simulating the natural reverberation of a concert hall.

Procedure

Pressing the [REVERB] button repeatedly toggles the reverb on and off.

Even if the reverb effect is turned off, a “soundboard reverb” effect will be applied when the GrandPiano1 or GrandPiano2 voice is selected.

TIP

You can select a reverb type via the Reverb Type parameter in the “VOICE SETTING” menu, and adjust the reverb depth for the selected voice via the Reverb Send parameter. (See page 79.)

TIP

Normal setting = ON

[CHORUS]

This control adds spread and spaciousness to the sound.

Procedure

Pressing the [CHORUS] button repeatedly toggles the chorus on and off.

You can turn the chorus effect on and off by pressing the [CHORUS] ON/OFF buttons on the panel and by setting the Chorus On Off parameter in the VOICE SETTING menu (see page 80). The [CHORUS] ON/OFF button setting on the panel is temporary. That is, if you select another voice, the chorus setting for the previous voice is cancelled. The Chorus On Off parameter setting is saved for each voice. That is, if you select a given voice, the chorus setting is automatically turned on or off according to the saved chorus setting.

TIP

You can select a chorus type via the Chorus Type parameter in the “VOICE SETTING” menu, and adjust the chorus depth for the selected voice via the Reverb Send parameter. You can also turn chorus on or off via the Chorus On Off parameter. (See page 80.)

TIP

Normal Setting

The normal chorus on/off setting is different for each voice.

Transposition ... [TRANSPOSE]

The Clavinova's Transpose function makes it possible to shift the pitch of the entire keyboard up or down in semitone intervals to facilitate playing in difficult key signatures, and to let you easily match the pitch of the keyboard to the range of a singer or other instruments. For example, if you set the transposition amount to "5," playing key C produces pitch F. In this way, you can play the song as if it were in C major, and the Clavinova will transpose it to the key of F.

You can also change the key signature of playback songs, in addition to your own performance.

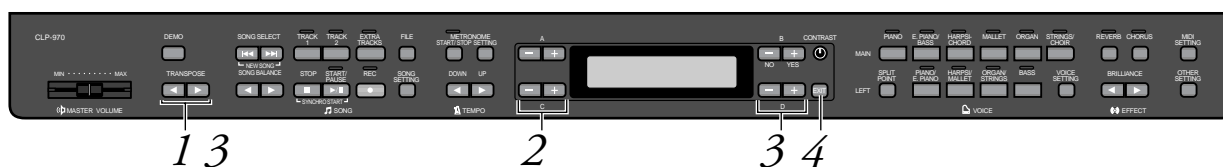

Procedure

1. Display the Transpose screen.
Press one of the **TRANSPOSE** [◀] and [▶] buttons.



2. Select a type of transposition from Manual or Song.
Use the **C** [-] and [+] buttons to select Manual or Song.

Manual Your manual performance
Song Playback song

3. Set the transposition amount.
Use the **D** [-] and [+] or **TRANSPOSE** [◀] and [▶] buttons to set the transposition amount.

To set the amount of transposition to "0," press the **D** [-] and [+] buttons or the **TRANSPOSE** [◀] and [▶] buttons simultaneously.

4. Return to the main screen.
Press the **EXIT** button.

TERMINOLOGY

Transpose:
Changing the key signature of a song. On the Clavinova, transposing shifts the pitch of the entire keyboard.

TIP

The transposition range is from "-12 semitones" (down one octave) through "0" (normal pitch) to "12 semitones" (up one octave).

Combining two voices (Dual mode)

You can play two voices simultaneously across the entire range of the keyboard. In this way, you can simulate a melody duet or combine two similar voices to create a thicker sound. Refer to “Voice Combination Examples (Dual and Split)” on page 105 for examples of effective voice combinations.

The numbers on the upper row indicate the steps in Dual mode using voices from different groups.

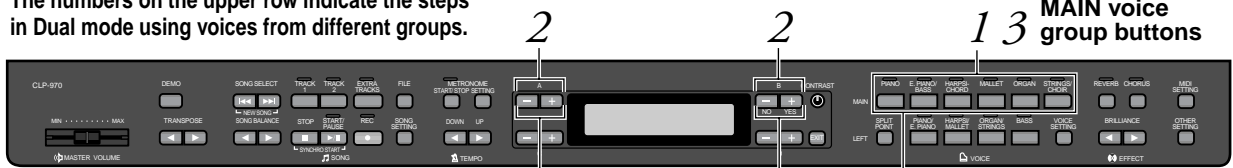

The numbers on the bottom row indicate the steps in Dual mode using voices from the same group.

Dual mode using voices in different voice groups

Procedure

1. Enter Dual mode.
Press two MAIN voice group buttons (upper row) simultaneously.

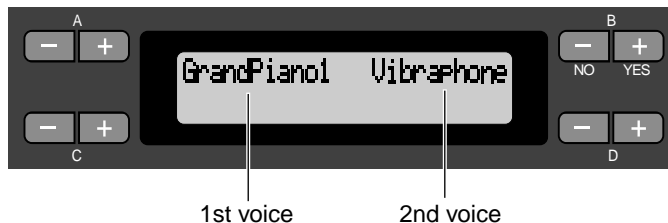

2. Select a voice.
Use the A [-]/[+] buttons and B [-]/[+] buttons to select a voice.

The voices listed in the upper row in “Preset Voice List” on page 103 are called 1st voices, and those listed in the bottom row are called 2nd voices.

3. Exit Dual mode and return to normal play mode.
Press any MAIN voice group button.

Dual mode using voices in the same voice group

Procedure

- 1.** Select a voice group.
In normal play mode, press the desired MAIN voice group button.
- 2.** Select a voice.
Use the A [-]/[+] buttons to select a voice.
- 3.** Select another voice.
Use the B [-]/[+] buttons to select another voice in the same voice group.

To use the identical voices, press the B [-]/[+] buttons once. To use different voices within the same voice group, press the B [-]/[+] buttons repeatedly.



- 4.** Exit Dual mode and return to normal play mode.
Press any MAIN voice group button.

Splitting the keyboard range and playing two different voices (Split mode)

Split mode enables you to play two different voices on the keyboard — one with the left hand and another with the right hand. For example, you can play a bass part using the Wood Bass or Electric Bass voice with the left hand, and a melody with the right hand. Refer to “Voice Combination Examples (Dual and Split)” on page 105 for examples of effective voice combinations.

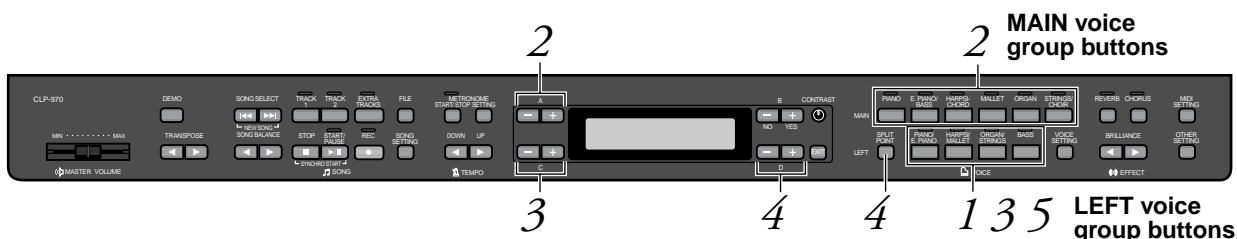

Procedure

1. Enter Split mode.
Press one of the LEFT voice group buttons (bottom row).



2. Select a voice for the right hand.
Use the MAIN voice group buttons (upper row) and the A [-]/[+] buttons.
3. Select a voice for the left hand.
Use the LEFT voice group buttons (bottom row) and the C [-]/[+] buttons.

Voice group		Voice name
MAIN	LEFT	
PIANO	PIANO/E.PIANO	GrandPiano1
E.PIANO/BASS		GrandPiano2
	BASS	E.Piano1
		E.Piano2
		SynthPiano
		WoodBass
		ElectricBass
		Bass&Cymbal
HARPSICHORD	HARPSICHORD/MALLET	Harpsichord8'
		Harpsichord8'+4'
		EcelctricClavichord
		Vibraphone
MALLET		Marimba
		Celesta
ORGAN	ORGAN/STRINGS	PipeOrganPrincipal
		PipeOrganFlute1
		PipeOrganFlute2
		PipeOrganTutti
		JazzOrgan
		Strings
		SynthStrings
		SlowStrings
		Choir
		SlowChoir
STRINGS/CHOIR		Scat

4. Specify the split point (the border between the right- and left-hand range).

The normal setting of the split point is “F#2.”

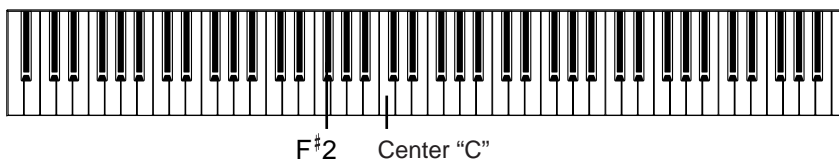

TIP

A specified “split point” key is included in the left-hand range.

To change the split point setting:

Press the [SPLIT POINT] button, then use the D [-]/[+] buttons to specify the split point.

(Optional) Press and hold down the [SPLIT POINT] button and play the key you wish to assign as the split point.

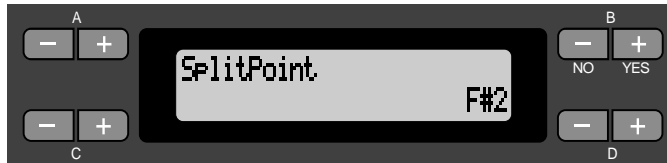

Press the [EXIT] button to return to the main screen.

5. Exit Split mode and return to normal play mode.

Press the voice group button that you pressed for the left-hand range.

In Split mode, you can use Dual mode (see page 35) for the MAIN and LEFT ranges respectively.



Using the metronome

The Clavinova is built-in metronome (a device that keeps an accurate tempo) is a convenient feature for practice.

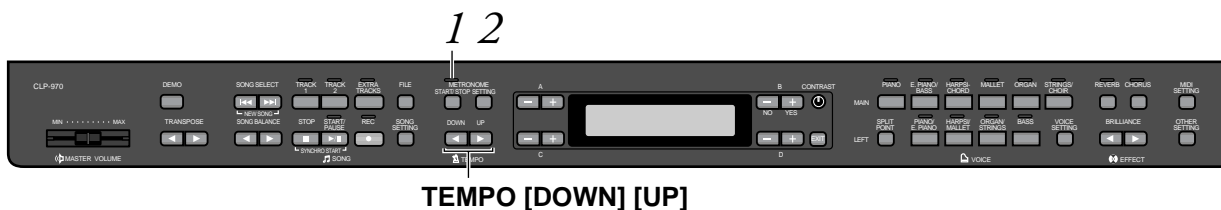

Procedure

1. Start the metronome.
Press the **METRONOME [START/STOP] button**.

When the metronome is sounding, the beat indicator flashes at the current tempo.

Adjusting the tempo

Press the TEMPO [DOWN] or [UP] button.



To adjust the tempo (number of beats per minute: 10–400), use the TEMPO [DOWN]/[UP] or the D [-]/[+] buttons. To reset the tempo to the normal (default) setting, press the [DOWN] and [UP] keys or the D [-] and [+] keys simultaneously.

Press the [EXIT] button to return to the normal screen.

2. Stop the metronome.
Press the **METRONOME [START/STOP] button**.

TIP

The default tempo is 120. (If a song has been selected, the song tempo is used.)

TIP

You can set the time signature, metronome volume, and metronome tone using the METRONOME [SETTING] button. (See page 77.)

Recording Your Performance

This chapter explains how to record your performance using the Clavinova recording function.

You can, for example, play back what you have played on the Clavinova keyboard for an effective practice aid. You can also record just the left-hand part, then practice the right-hand part while playing back the recorded left-hand part.

Since you can record up to sixteen tracks separately, you could record the left- and right-hand parts separately, or record each part of a four-handed performance or ensemble song one by one to build a song.

TIP

You can record your performance (audio data) to a cassette tape recorder or other recording devices via the AUX OUT connector. (see page 61.)

TERMINOLOGY Recording vs. Saving:

The format of performance data recorded on a cassette tape differs from that of data recorded on the Clavinova. A cassette tape records audio signals. On the other hand, the Clavinova “saves” information regarding note timing, voices, and a tempo value, but not audio signals. When you play back recorded songs, the Clavinova produces sound based on the saved information. Therefore, recording on the Clavinova may be more accurately called “saving information.” However, this book often uses the word “recording” because it seems to make more sense.

A message (information or confirmation dialog) sometimes appears on the screen to facilitate operation. Refer to the “Message List” on page 92 for an explanation of each message, appropriate actions to take, and troubleshooting information.

Recording a New Song

Recording to [TRACK 1]



Procedure

1. Select “NewSong” for recording.

Press the **SONG SELECT** [**◀◀**] [**▶▶**] buttons simultaneously.

New Song screen



NOTE

If you select a song other than “P-000: NewSong” and record on a track that already has data, the existing data on the track will be lost.

2. Select a voice.

Select a voice (or voices) for recording (see page 30).

Set the other parameters, such as reverb and chorus.

Adjust the [MASTER VOLUME] slider to set the volume level to suit your preference. You can also use the slider to adjust the level during playback.

After you set the tempo or if the record standby screen does not appear, press one of the SONG SELECT [◀◀] [▶▶] buttons once to return to the New Song screen.

3. Enter record mode and select a recording track.

Press and hold down the [REC] button and press the [TRACK 1] button.

The [TRACK 1] indicator flashes in red. (To cancel recording, press the [REC] or [STOP] button.)

Record standby screen



Set the tempo, if necessary.

If this record standby screen does not appear, press one of the SONG SELECT [◀◀] [▶▶] buttons once.

4. Start and stop recording.

Recording begins automatically as soon as you play a note on the keyboard.

(Optional) Press the [START/PAUSE] button to start recording. The recording screen displays the current measure number.

Record screen



Measure number in recording

To stop recording, press the [STOP] button. The Clavinova locates the top of the song.

The [TRACK 1] indicator lights up in green. (Record mode is automatically cancelled.)

NOTE

Set the tempo in Step 3.

NOTE

See page 49 for more information on recording in Dual/Split mode.

TIP

You can record data while using the metronome. The metronome is not recorded.

TIP

When you press the [START/PAUSE] button during recording, recording is paused. To resume recording, press the [START/PAUSE] button again or play a note on the keyboard.

TIP

When you press the [REC] button, recording pauses.

- 5. Play back the recorded performance.**
Press the [START/PAUSE] button to play back the recorded performance.

When playback is complete, it automatically stops and the Clavinova locates the top of the song. To stop playback in the middle of a song, press the [STOP] button. You can also pause playback by pressing the [START/PAUSE] button. Playback stops when you press the button.

When you turn off the power to the Clavinova, the recorded performance data will be lost. If you wish to keep the recording, save the data using the SaveToMemory parameter (page 52) or SaveToDisk parameter (page 53) in the File menu.

NOTE

To erase recorded data from a track, use the Channel Clear parameter in the "SONG SETTING" menu. (See page 75.)

Re-recording TRACK 1

This section explains how to record again in case your performance was not satisfactory.

Procedure

- 1. Select a voice or voices for recording, if necessary.**
Repeat Step 2 on page 42 if you wish to change the previous settings.

Follow the procedure from Step 3 on page 42 to re-record.

The original performance data will be overwritten by new performance data.

Re-recording TRACK 1 partially

This section explains how to record part of a song again.

Procedure

1. **Pause the song at the beginning of the part you wish to re-record.**
Use the B [-]/[+] buttons while the playback screen is displayed to move through the measures or play back the recording and press the [START/PAUSE] button to locate a point slightly prior to the beginning of the part you wish to re-record.

Playback screen



2. **Select a voice or voices for recording, if necessary.**
Repeat Step 2 on page 42 if you wish to change the previous settings.
3. **Select the recording method and enter record mode.**
- 3-1 **Press and hold down the [REC] button, and press the C [-]/[+] buttons repeatedly to specify how the recording should start and press the D [-]/[+] buttons repeatedly to specify how the recording should end.**
 While you are holding down the [REC] button, the following recording method select screen appears.



Starting methods:

Norm (Normal) — The existing data will be erased after re-recording starts.

Key On — Data that exists prior to the point where you start playing a note will not be erased.

NOTE

If the playback screen is not displayed, press one of the SONG SELECT [◀] [▶] buttons once.

Ending methods:

Replace – The data after the point you stop recording will also be erased.

Punch Out — The data after the point you stop recording will remain.

3-2 Keep holding down the [REC] button and press the [TRACK 1] button.

The [TRACK 1] indicator flashes in red.

(To stop recording, press the [REC] button again or press the [STOP] button.)

Follow the procedure beginning with Step 4 on page 42.

TIP

If you cancel recording by pressing the [REC] button, recording stops when you press the button. If you cancel recording by pressing the [STOP] button, the Clavinova locates the top of the song.

Recording to [TRACK2]

This section explains how to record another part on the second track.

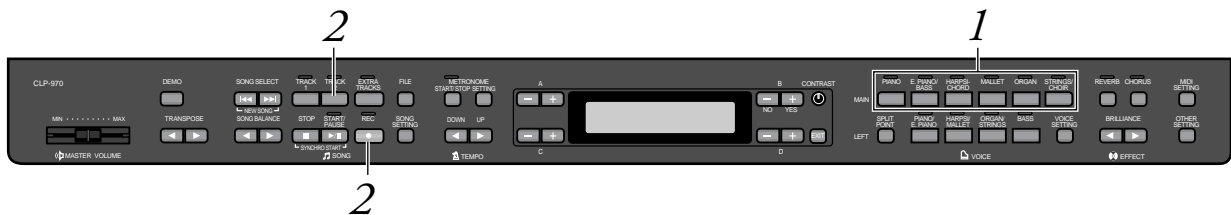

Procedure

1. **Select a voice.**
Select a voice (or voices) for recording.
Repeat Step 2 on page 42.
2. **Enter record mode and select a recording track.**
Press and hold down the [REC] button and press the [TRACK 2] button.

The [TRACK 2] indicator flashes in red. (To cancel recording, press the [REC] or [STOP] button.)

TIP

Pressing the [TRACK 1] button repeatedly toggles between playback on (the indicator lights up in green) and off (the indicator turns off).

Make the recording by following the procedure beginning with Step 4 on page 42.

You can record a new part while listening to playback of the recorded [TRACK 1] data.

Recording to the third or more tracks [EXTRA TRACKS]

You can continue recording other parts into tracks 3–16 [EXTRA TRACKS] one by one.

Procedure

1. Hold down the [REC] button in step 2 in the “Recording to [TRACK2]” on page 45 and use the B [-]/[+] buttons to select a recording track (3–16).

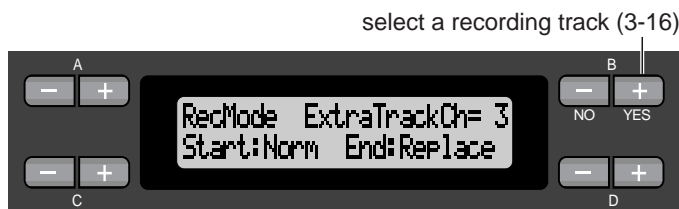

2. While holding down the [REC] key, press the [EXTRA TRACKS] button.

Then, follow the procedure beginning with Step 4 on page 42.

Other recording techniques

Adding data to or recording over an existing song

The previous section explains how to record your performance from the beginning by selecting a blank “P-000: NewSong.” You can also add your performance to or overwrite existing songs (such as 50 preset songs [P-001—P-050], commercially-available music data [see page 60], or your old recorded performances [see page 50]).

Procedure

1. **Select a song for recording (P-001 – P-050).**
Select one of the preset songs (P-001–P-050) instead of “P-000: NewSong” as described in Step 1 of “Recording to [TRACK1]” on page 41. To select a song from commercial music data sold in stores or from already-recorded data, see Steps 1 and 2 on page 57.

NOTE

If you record on a track that already has data, the existing data on the track will be lost.

To continue recording, follow the procedure described in “Recording a New Song” from page 41 to 46.

Changing a voice or tempo after recording

You can change the voice and tempo after recording to change a song's feel or to set a more suitable tempo. You can also change these elements in the middle of a song.

Procedure

1. Select a song you wish to change by using the SONG SELECT [◀◀] [▶▶] buttons.
2. To change the voice or tempo in the middle of the song, specify the measure to change using the B [-]/[+] buttons.
3. Change the settings (voice, reverb, etc.).
For example, if you wish to change the recorded E.Piano1 voice to E. Piano2, use the MAIN voice group buttons and the A [-]/[+] buttons to select E.Piano2.
When the setting is complete, press one of the SONG SELECT [◀◀] [▶▶] buttons once to return to the song select screen.
4. Press and hold down the [REC] button and select the track to change.
The indicator for the selected track lights up in red.
Change the tempo setting now, if necessary.

At this point, do not play the keyboard or press the [START/PAUSE] button. Otherwise, recording will start, erasing the recorded data.
5. Press the [STOP] or [REC] button to exit record mode.

TIP

Refer to "Questions about Operations and Functions" on page 97 for information on the settings that can be changed here.

TIP

Change the tempo in Step 4.

CAUTION

The edited settings (except for the tempo setting) will be saved in memory and you will not be able to restore the previous settings. Proceed with caution.

Adjusting the volume balance between playback and your performance [SONG BALANCE]

While recording multiple parts into tracks one by one, you can adjust the volume balance between the playback of the recorded parts and your current performance.

Procedure

1. Press one of the SONG BALANCE [◀] [▶] buttons.



2. Adjust the song balance using the SONG BALANCE [◀] [▶] or D [-]/[+] buttons.

To lower the volume of the playback sound, press the SONG BALANCE [◀] or D [-] button.

To lower the volume of the performance sound, press the SONG BALANCE [▶] or D [+] button.

Setting range:

127:127 – 1:127 (Lowering the volume of the playback sound)

127:127 – 127:1 (Lowering the volume of the performance sound)

Normal setting: 127:127

TIP

Commercially-available song data contains a large amount of data. If you are using such songs, be sure to adjust the song balance.

TIP

The song balance setting is also used during playback. (See page 57.)

Recording in Dual or Split mode

When you record in Dual or Split mode, the Clavinova records each voice onto a separate track. The following table shows how tracks are assigned to each voice.

CAUTION

When you record multiple parts into tracks one by one, or when you record new data over an existing song (see page 46), the existing data will be erased. Proceed with caution.

In the following example, Tracks 1, 2, and EXTRA TRACKn have been selected for recording.

Tracks assigned for recording	Dual			Split			Split+Dual		
	TRACK1	TRACK2	EXTRA TRACKn	TRACK1	TRACK2	EXTRA TRACKn	TRACK1	TRACK2	EXTRA TRACKn
	↓	↓	↓	↓	↓	↓	↓	↓	↓
Tracks used for recording	MAIN (1st voice)	TRACK1	TRACK2	TRACKn	TRACK1	TRACKn	TRACK1	TRACKn	
	LEFT (1st voice)	—			TRACK2	TRACKn+1	TRACK2	TRACKn +1	
	MAIN (2nd voice)	TRACK3	TRACK4	TRACKn +2	—		TRACK3	TRACKn +2	
	LEFT (2nd voice)	—			—		TRACK4	TRACKn +3	

Note: TRACKn = TRACK 3 – TRACK 16
 If “n+1,” “n+2,” and “n+3” exceed 16, TRACKs 1, 2, and 3 are used.

TIP

Switching between Dual and Split mode in a song is not recorded.

Saving Recorded Songs and Handling the Files...[FILE]

File screens (accessed via the [FILE] button) enables you to handle song files (e.g., save, delete, and rename recorded songs), copy and format disks, and change the characters on the screen.

The following parameters are provided for these operations:

Settings	Parameter name	Reference page
Saves recorded and other songs in Clavinova memory	SaveToMemory	52
Saves recorded and other songs on floppy disks	SaveToDisk	53
Deletes song data from Clavinova memory or floppy disk	DeleteSong	53
Changes the title of songs	RenameSongs	54
Copies data from floppy disk to floppy disk	CopyDisk	55
Formats a floppy disk	FormatDisk	56
Change the type of characters on the screen	CharacterCode	56

Clavinova memory

The Clavinova has the following three types of memory:

- **Current memory:**
This is a temporary memory area where you can temporarily place and edit the currently-selected song before playback or recording.
- **Preset song memory:**
This read-only memory area saves 50 piano preset songs.
- **Storage memory:**
This memory area enables you to save recorded songs or song data loaded from floppy disk.

When you select a song in the song select screen, it is loaded from Preset song memory, Storage memory, or floppy disk, into Current memory.

You will use Current memory to play back and record songs. When you turn off the power to the Clavinova, songs saved in Preset song memory and Storage memory are not erased. On the other hand, songs in Current memory are lost. If you wish to keep a song in Current memory, you must save it in Storage memory or on a floppy disk (see page 52, 53).

In this manual, a song located in a song recorded in Current memory, is referred to as a “**Current song**,” a song in Storage memory is a “**Memory song**,” and a song on a floppy disk is a “**Disk song**.”

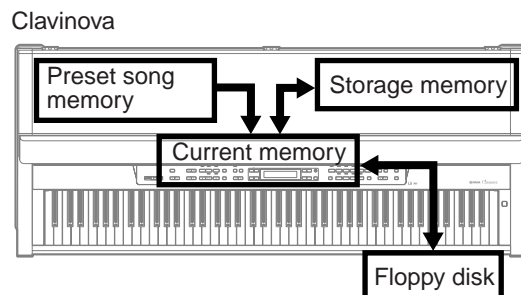

TERMINOLOGY

File

A file contains a group of data. On the Clavinova, a song file includes song data and a song number.

Memory

Memory is a location inside the Clavinova in which you can save and edit data.

Formatting (Initializing)

Floppy disks are a convenient media that allow you to save various data for personal computers and other devices. There are many ways (formats) to save data on floppy disks, depending on the device. Therefore, you need to prepare a floppy disk by assigning a format before you can use it on a particular type of device. This operation is called “formatting.”

Character code

Type of characters

Basic file operation

A message (information or confirmation dialog) sometimes appears on the screen to facilitate operation. Refer to the “Message List” on page 92 for an explanation of each message, appropriate actions to take, and troubleshooting information.

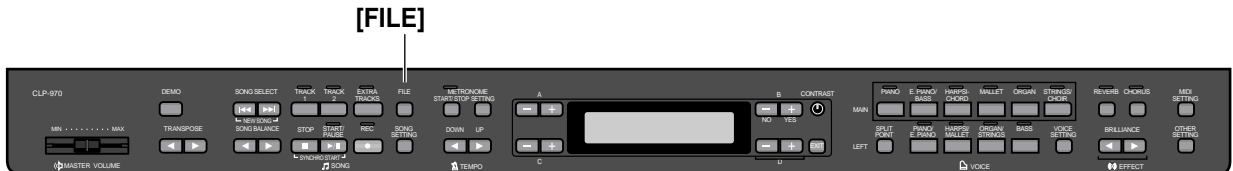

Procedure

- 1. Select a song, or have a floppy disk ready.**
Select a song you wish to save or rename.
(Optional) Insert a floppy disk for copying or formatting into the disk drive.

- 2. Access the File menu.**
Press the [FILE] button.



To close the File menu, press the [EXIT] button once or twice.

- 3. Select the desired parameter.**
Press the [FILE] or A [-]/[+] buttons repeatedly to display the desired item from the following:
“SaveToMemory”, “SaveToDisk”, “DeleteSong”, “RenameSong”,
“CopyDisk”, “FormatDisk”, “CharCode”.
- 4. Set the parameter or execute the command.**
Use the B [- (NO)]/[+ (YES)], C [-]/[+], D [-]/[+] buttons.
For more information regarding this procedure, refer to the corresponding section below.
- 5. Close the File menu.**
Press the [EXIT] button.

Saving recorded or other songs to Clavinova Storage memory...[SaveToMemory]

If you record a song, then turn off the power to the Clavinova, the song will be erased. To save the recorded song, you must save it into the Clavinova Storage memory or to a floppy disk. (To save a song to a floppy disk, refer to the next section [SaveToDisk].) You can also save the preset songs, disk songs, and additional or overwriting recordings (page 46) to Storage memory.



Procedure

See page 51 the basic operation information. The following is a detailed procedure of Step 4.

4-1 Name the song.

- To move the cursor (a small underline), use the C [-]/[+] buttons.
- To insert a space, press the C [-]/[+] buttons simultaneously.
- To select a character on the cursor, use the D [-]/[+] buttons.
- To delete a character, press the D [-]/[+] buttons simultaneously.

You can use up to 58 characters for a song name. If the name is longer than the screen, use the C [-]/[+] buttons to move the cursor and scroll the name.

4-2 Execute the operation.

- Press the B [+ (YES)] button located next to “Execute?→”
- “Sure?→.” appears on the screen. Press the B [+ (YES)] button again to confirm the operation. (To cancel the operation, press the B [- (NO)] button.)
- The Clavinova displays “Executing” on the screen during the operation. When the operation is complete, “Completed” appears.
- The song is automatically numbered as “Mxx,” where “M” means “Memory” and “xx” is a number.

TIP

If Storage memory contains one or more songs, and you save a new song, the Clavinova automatically sorts the songs alphabetically and renumbers them.

TIP

- You can change the type of characters on the screen using the CharacterCode parameter.
- When you select a saved song later, the name with an extension “.MID” will appear.

TERMINOLOGY

“Execute?→”: Do you wish to execute the operation?

“Sure?→”: Are you sure?

“Executing”: The Clavinova is executing the operation.

“Completed”: The operation is complete.

CAUTION

Do not turn off the power while the screen displays “Executing.”

Saving recorded or other songs to floppy disk...[SaveToDisk]

You can save recorded songs, preset songs, Memory songs, and additional or overwriting recordings (page 46) songs onto a floppy disk.



Procedure

See page 51 for basic operation information. The following is a detailed procedure of Step 4.

4. Make sure that a formatted floppy disk (page 56) is inserted in the disk drive.

Follow the steps for the [SaveToMemory] operation (see page 52) to name and save the song.

The song is automatically numbered as “Dxx,” where “D” means “Disk” and “xx” is a number.

TIP

The song data is saved in the SMF format (format 0). Therefore, you can play the disk on instruments that support the SMF format.

CAUTION

Do not turn off the power or eject the floppy disk while the screen displays “Executing.”

Deleting songs in Clavinova Storage memory or a floppy disk...[DeleteSong]

You can delete Memory songs and Disk songs, but not Preset songs or Current songs.



Procedure

See page 51 for basic operation information. The following is a detailed procedure of Step 4.

TIP

To delete a Current song, select “ALL” for the Channel-Clear parameter in the “SONG SETTING” menu (page 75). Alternatively, press the SONG SELECT [◀◀]/[▶▶] buttons simultaneously to display “Song Changed Save?”. This means “A song has been edited. Do you wish to save the change?” Press the B [–] (NO) button. The Current song is deleted and a blank “NewSong” is selected.

4-1 Select a song to delete.

Use the C [-]/[+] buttons to select a song.

4-2 Execute the operation.

Press the B [+ (YES)] button located next to "Execute?→."
Follow the instructions on screen.

TIP

If you select a Memory song or Disk song, deleting the song does not erase song data from Current memory. However, if you return to the song select screen, song information other than the song name is replaced by "-----".

TIP

After you delete a song, the Clavinova automatically updates the song numbers.

CAUTION

Do not turn off the power or eject the floppy disk while the screen displays "Executing."

Renaming a song...[RenameSong]

You can change a song's title (except for the preset songs and [P-000: NewSong].

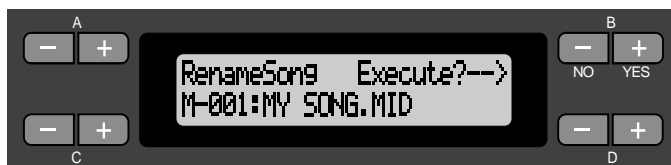

Procedure

See page 51 for basic operation information. The following is a detailed procedure for Step 4.

4. Name the song as described in the [SaveToMemory] section (page 52).

CAUTION

Do not turn off the power or eject the floppy disk while the screen displays "Executing."

TIP

After you rename a song, the Clavinova sorts songs alphabetically and renumbers them.

Copying data from one floppy disk to another...[CopyDisk]

You can copy the entire contents of one floppy disk to another floppy disk.



Procedure

See page 51 for basic operation information. The following is a detailed procedure for Step 4.

- 4-1** Make sure that a formatted floppy disk is inserted in the disk drive.
- 4-2** Press the B [+ (YES)] button located next to "Execute?->."
- 4-3** When the screen indicates "Insrt Target Disk", eject the source disk and insert the destination disk.
When the copy operation is complete, the Clavinova displays "Completed."

TIP

Use the same type of disk (2DD or 2HD) for the destination disk as the source disk.

TERMINOLOGY

Insrt Target Disk:
Insert the destination (target) disk.

CAUTION

Do not turn off the power or eject the floppy disk while the screen displays "Executing."

Formatting a floppy disk...[FormatDisk]

You can format a floppy disk so that it can be used with the Clavinova.



Procedure

See page 51 for basic operation information. The following is a detailed procedure for Step 4.

4-1 Make sure that the formatted floppy disk is inserted in the disk drive.

4-2 Press the B [+ (YES)] button located next to “Execute?→.”

Follow the instructions on screen.

CAUTION

Do not turn off the power or eject the floppy disk while the screen displays “Executing.”

Changing the type of characters on screen...[CharacterCode]

You can change the type of characters that appear on screen.

The default setting is “International.” To input katakana, change this setting to “Japanese.”



Options: International, Japanese

Character list

[International]

0~9	A~Z	a~z	Ä	Ë	Ï	Ö	Ü	ä	ë	ï	ö	ü	à	è	ì	ò	ù	á	é	í	ó	ú	â	ê	î	ô	û	Ñ	ñ	ß	Ç	ç	°	ı	ı	!	#	\$	%	&	'	()												
																												+	,	-	.	;	=	@	[]	^	_	`	{	}	~													

[Japanese]

0~9	A~Z	a~z	ア	ン	ア	オ	ヤ	ユ	ヨ	ツ	ッ	°	-	。	「	」	,	・	!	#	\$	%	&	'	()	+	,	-	.	;	=	@	[]	^	_	`	{	}	~
-----	-----	-----	---	---	---	---	---	---	---	---	---	---	---	---	---	---	---	---	---	---	----	---	---	---	---	---	---	---	---	---	---	---	---	---	---	---	---	---	---	---	---

Playing Back Recorded Songs and Commercially-available Music Data

You can play back songs recorded using the Record function (page 41) as well as commercially-available music data. You can also play the keyboard along with the playback.

TIP

See page 59 for information on the types of song data that can be played on the Clavinova.

Playing back a song

To play back a song from a floppy disk, insert the disk into the disk drive.

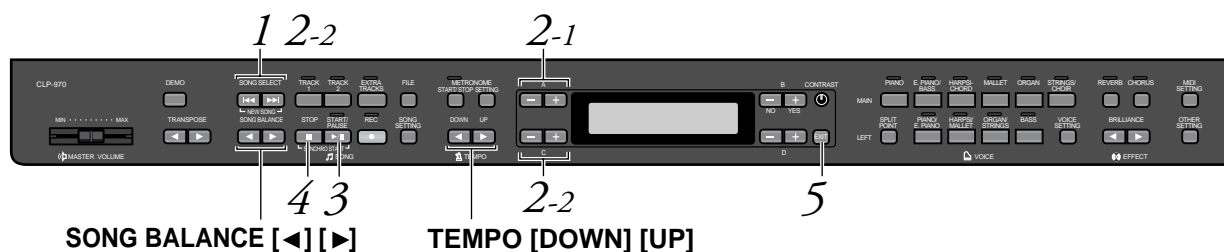

Procedure

1. Display the song select screen.
Press either the **SONG SELECT** [◀◀]/[▶▶] buttons.

Song select screen



2. Select the desired song.
- 2-1 Use the **A** [-]/[+] buttons to select the song type: "PresetSong," "MemorySong," or "DiskSong."
If the internal Storage memory contains one or more songs, the Clavinova displays "MemorySong." If a floppy disk that contains song data is inserted in the drive, the Clavinova displays "DiskSong."
- 2-2 Use the **C** [-]/[+] or **SONG SELECT** [◀◀]/[▶▶] buttons to select a song.

TIP

You can enjoy ensemble performance by yourself. Record the parts for a four-handed song or a piano duet, then play the recorded part while playing the other part on the keyboard.

TIP

Use the SongRepeat parameter in the "SONG SETTING" menu (page 76) to select repeat playback of all songs or repeat playback of a single song.

3. Start playback.

Press the [START/PAUSE] button.

Starting playback automatically as you start playing the keyboard (Synchro Start)

You can start playback as soon as you start playing the keyboard. This is called the “Synchro Start” function.

To enter Synchro Start standby mode, press and hold down the [STOP] button and press the [START/PAUSE] button. The [START/PAUSE] indicator flashes.

Now play the keyboard. Playback starts simultaneously.

To cancel the Synchro Start function, press the [STOP] button while the Clavinova is in Synchro Start standby mode.

You can move back and forth (rewind and fast forward) through the bars by using the B [-]/[+] buttons in the song select screen while the Clavinova is playing or stopped.

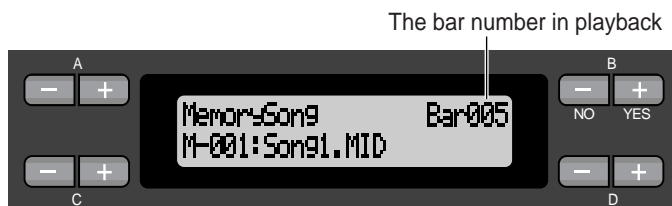

You can play the keyboard while the Clavinova is playing back a song. You can also play the notes in a voice different from the playback voice by selecting the voice from the panel, and adjusting the volume balance between the playback parts and your current performance using the SONG BALANCE [◀] [▶] buttons. (See page 48.)

Press either of the SONG SELECT [◀◀]/[▶▶] buttons to return to the song select screen.

Adjusting the tempo

You can use the TEMPO [DOWN]/[UP] buttons to adjust the playback tempo as required before or during playback. The default tempo (the song’s original tempo) is set when you press the [DOWN] and [UP] buttons simultaneously.

Press either of the SONG SELECT [◀◀]/[▶▶] buttons to return to the song select screen.

4. Stop playback.

When playback is complete, the Clavinova automatically stops and locates the top of the song. To stop playback in the middle of a song, press the [STOP] button. You can also pause playback by pressing the [START/PAUSE] button. Playback stops when you press the button.

TERMINOLOGY

Bar: measure

TIP

You can play the metronome along with the song playback. When you stop playback, the metronome is also stopped.

TIP

In the song select screen:

- Press the SONG SELECT [◀◀] or the C[-] button while playback is stopped in the middle of the song to locate the top of the song.
- Press the SONG SELECT [◀◀] or the C[-] button during playback to restart playback from the top of the song.
- Press the SONG SELECT [▶▶] or the C[+] button during playback to start playback from the next song.

- 5. Return to the main screen.**
Press the [EXIT] button.

Eject the floppy disk from the disk drive if you have been playing a disk song.

Turning track playback on and off

When you select a song on the Clavinova, the indicators for tracks that contain data ([TRACK 1], [TRACK 2], [EXTRA TRACKS]) are lit in green. While the Clavinova is playing or stopped, pressing these track buttons turn off the indicators, and the data on those tracks will not be played. Pressing the track buttons toggles track playback on and off. You can play the part that is turned off.

TIP

When the Clavinova plays back commercially-available music data or recordings from other instruments, all track indicators may light up green regardless of whether or not all tracks contains data.

TIP

You can practice a part or phrase using the FromToRepeat (page 75) and Phrase-Mark parameters (page 76) in the "SONG SETTING" menu.

Supported song data type

Data formats that can be played on the CLP-970

The Clavinova CLP-970 plays song data in the following formats:

Floppy disk format

- 3.5-inch 2DD disks in the MS-DOS 720KB format
- 3.5-inch 2HD disks in the MS-DOS 1.44MB format

Sequence format

- SMF (Standard MIDI File) formats 0 and 1
- ESEQ
- Performance data recorded on the CLP-970 is saved in the SMF format 0 in a floppy disk.

TERMINOLOGY

Disk format:

A structured method for writing data to disk.

TERMINOLOGY

Sequence format:

A structured method for recording performance data.

Voice arrangement format

- XG voice arrangement
- GM system level 1 voice arrangement
- DOC voice arrangement

Performance data recorded with preset voices on the CLP-970 can be played on other XG-compatible instruments.

The CLP-970 provides XG voices for song playback, as well as preset voices. See page 6 of the separate “Reference Booklet” for the XG voice list.

Refer to “Data compatibility” on page 101 for more information on formats.

Song data recorded on other instruments

When you play on the CLP-970 song data recorded on the Clavinova CVP-109, 107, 105, 103, 98, 96, 94, 92, or CLP-870, you may notice a slight difference in volume balance, although the voices sound almost identical. You can also play back song data from the Yamaha Disklavier player piano.

TERMINOLOGY

Voice arrangement format:

A structured method for numbering the voices for assignment.

Connections

Connectors

⚠ CAUTION

Before connecting the Clavinova to other electronic components, turn off the power to all the components. Before turning the power on or off to all components, set all volume levels to minimum (0). Otherwise, electrical shock or damage to the components may occur.

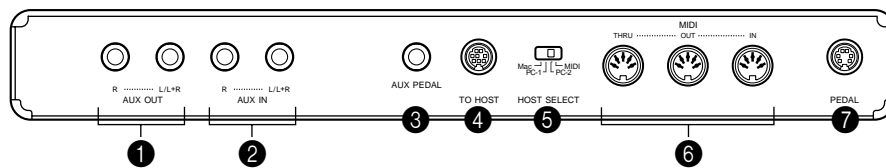

1 AUX OUT [R], [L/L+R] jacks

You can connect these jacks to a stereo system to amplify the Clavinova or to a cassette tape recorder to record your performance. Refer to the diagram below and use audio cables for connection.

Adjust the volume level on the stereo system or cassette tape recorder, not using the Clavinova's [MASTER VOLUME] slider.

⚠ CAUTION

When the Clavinova's AUX OUT jacks are connected to an external audio system, first turn on the power to the Clavinova, then to the external audio system. Reverse this order when you turn the power off.

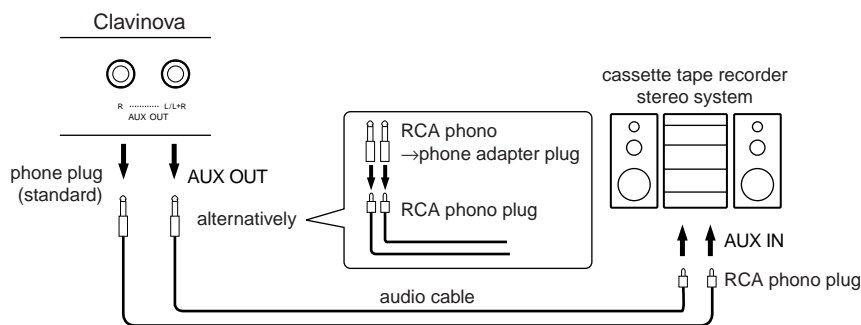

⚠ CAUTION

Do not route the output from the AUX OUT jacks to the AUX IN jacks. That is, when you connect an external audio device to the AUX OUT jacks, do not connect the audio device to the Clavinova's AUX IN jacks. If you make this connection, the signal input at the AUX IN jacks is output from the AUX OUT. This creates an audio loop, causing audio oscillation and abnormal playback, leading to malfunction of both pieces of equipment.

TIP

Use audio cables and adapter plugs with no resistance.

TIP

The Clavinova's [MASTER VOLUME] slider setting does not affect the signal output from the AUX OUT jacks.

2 AUX IN [R], [L/L+R] jacks

The stereo outputs from another instrument can be connected to these jacks, allowing the sound of an external instrument to be reproduced via the Clavinova's speakers. Refer to the diagram below and use audio cables for connection.

⚠ CAUTION

When the Clavinova's AUX IN jacks are connected to an external device, first turn on the power to the external device, then to the Clavinova. Reverse this order when you turn the power off.

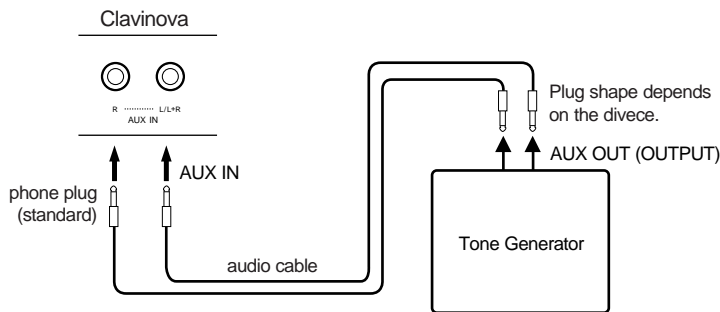

3 AUX PEDAL jack

Connect an optional foot controller FC7 or foot switch FC4 or FC5 here. Using the FC7 enables you to add expression to your performance by controlling the volume level of the notes you play. Using the FC4 or FC5 enables you to turn the assigned function on and off. Use the AuxPedal parameter in the "VOICE SETTING" menu. You can also assign the [START/PAUSE] button function to this foot switch. (See page 89.)

4 TO HOST jack

This jack allows direct connection to a personal computer. (Refer to "Connecting a personal computer" on page 63 for more information.)

5 HOST SELECT switch

This switch should be set according to the type of connected MIDI device or personal computer. (Refer to "Connecting a personal computer" on page 63 for more information.)

TIP

The Clavinova's [MASTER VOLUME] slider setting affects the input signal from the AUX IN jacks, but the [REVERB], [CHORUS], and [BRILLIANCE] (page 32) settings do not.

TIP

If you connect the Clavinova to a monaural device, use only the AUX IN [L/L+R] jack or AUX OUT [L/L+R] jack.

6 MIDI [IN], [OUT], [THRU] connectors

Use MIDI cables to connect external MIDI devices to these connectors. Make sure you set the HOST SELECT switch (described on the previous page) to MIDI when you use these connectors.

7 PEDAL jack

Connect the pedal cord from the pedal box. (Refer to “Keyboard Stand Assembly” on pages 106-108.)

Connecting a personal computer

You can enjoy computer music data on the Clavinova by connecting a computer to the TO HOST (or MIDI) jack.

“The Clavinova-Computer Connection” is a supplementary guidebook that describes, for beginners, what you can do with your Clavinova and a personal computer and how to set up a Clavinova-Computer system (the manual is not written for any specific models). The document is available as a PDF file (in English) at the following Internet address:

Clavinova Web site:

<http://www.yamaha.co.jp/english/product/cl/>

Yamaha Manual Library (Electronic Musical Instruments):

<http://www2.yamaha.co.jp/manual/english/>

(You need to register first. Check the Clavinova web page.)

There are the three methods by which to connect the Clavinova to a personal computer:

1. Connecting the serial port on the computer to the Clavinova’s TO HOST jack (page 64)
2. Using a MIDI interface and the Clavinova’s MIDI connectors (page 66)
3. Using the USB port on the computer and the UX256, a USB interface (page 67)

For more information, refer to the following pages.

TIP

When connecting the Clavinova to a personal computer, first turn off the power to both the Clavinova and the computer before connecting any cables and setting the HOST SELECT switch. After making connections and switch settings, turn on the power to the computer first, then to the Clavinova.

TIP

If you do not use the TO HOST jack of the Clavinova, make sure you disconnect the cable from the jack. If the cable is left connected, the Clavinova may not function properly.

TIP

When the HOST SELECT switch is set to “PC-1,” “PC-2,” or “Mac,” you can use the TO HOST jack, but the MIDI connectors are disabled since no data transfer occurs via the MIDI connectors. On the other hand, when the HOST SELECT switch is set to “MIDI,” you can use the MIDI connectors, but not the TO HOST jack since no data is transferred via the TO HOST jack.

1. Connecting the serial port on the computer to the Clavinova's TO HOST jack

Connect the computer's serial port (RS-232C or RS-422) to the Clavinova's TO HOST jack. In this connection, the Clavinova functions as a MIDI interface. Therefore, you do not need a special MIDI interface.

Connection

Use a special serial cable (page 65) to connect the computer's serial port (RS-232C or RS-422) to the Clavinova's TO HOST jack.

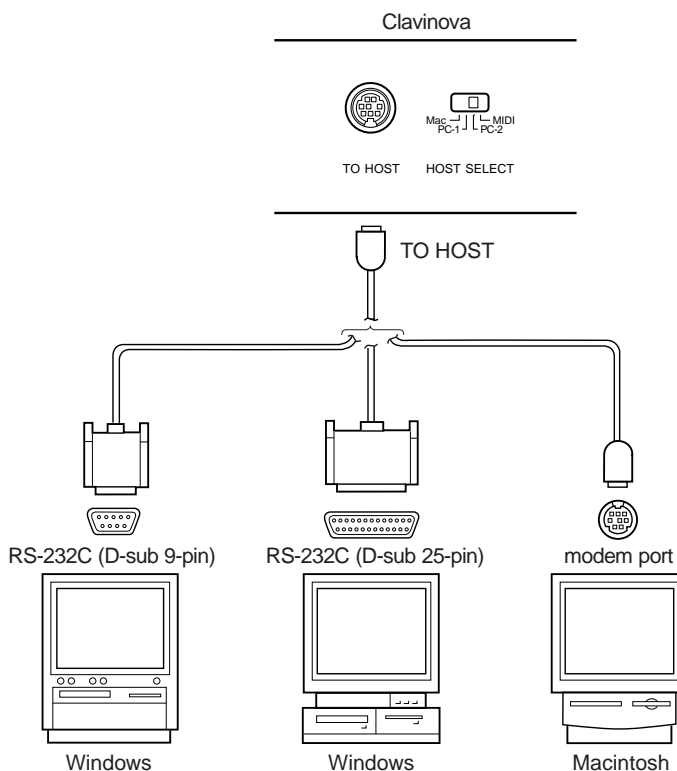

Note for Windows 95/98 users (regarding MIDI driver)

To transfer data via the computer's serial port and the Clavinova's TO HOST jack, you need to install a specified MIDI driver (Yamaha CBX driver for Windows 95/98). You can download this driver from the following XG Library on the Yamaha Web site:

<http://www.yamaha-xg.com>

Type of serial cables and connection pin assignments

According to the type of computer you connect, use one of the following serial cables.

- **Windows (with a serial port of D-sub 9-pin)**

8-pin mini DIN plug → D-sub 9-pin plug
(Yamaha CCJ-PC2 or equivalent)



- **Macintosh**

System peripheral plug → 8-pin plug
(Yamaha CCJ-MAC or equivalent)

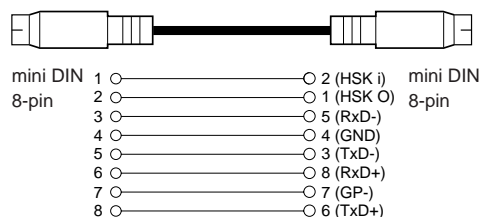

- **Windows (with a serial port of D-sub 25-pin)**

8-pin mini DIN plug → D-sub 25-pin plug
(Yamaha CCJ-PC1NF or equivalent)

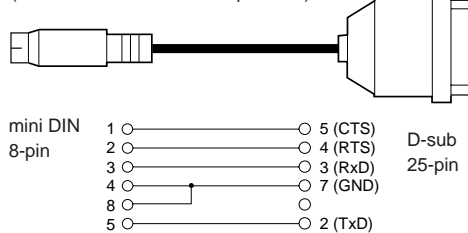

- **Pin assignment**

The following diagram shows the pin assignments for each cable.

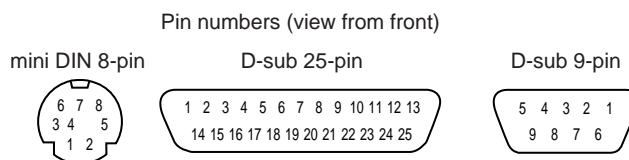

Clavinova HOST SELECT switch setting

Set the Clavinova HOST SELECT switch properly according to the type of connected computer.

- **Macintosh:** “Mac” (data transfer rate: 31,250bps, 1MHz clock)
- **Windows:** “PC-2” (data transfer rate: 38,400bps)

TIP

If your system does not work properly with the connections and settings listed above, your software may require different settings. Check your software operation manual and set the HOST SELECT switch to the proper data transfer rate. (Data transfer rate of “PC-1” is 31,250bps.)

2. Using a MIDI interface and the Clavinova's MIDI connectors

Connection

Use a MIDI interface device to connect a computer to the Clavinova using special MIDI cables.

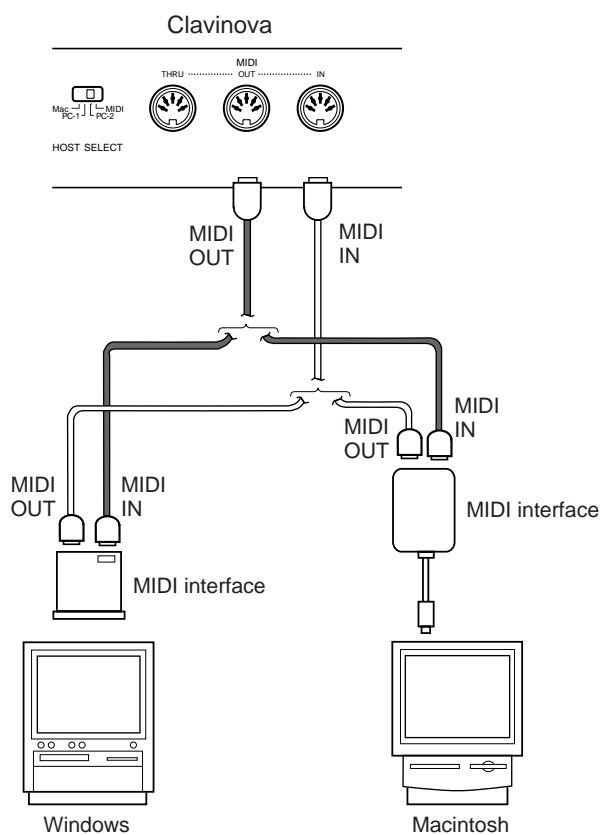

Clavinova HOST SELECT switch setting

Set the Clavinova HOST SELECT switch to "MIDI."

3. Using the USB port on the computer and the UX256, a USB interface

Connect the USB port of the computer to the UX256 using a USB cable, install the driver (that came with the UX256) on the computer, and connect the UX256 to the Clavinova using a serial cable or MIDI cables.

For more information, refer to the instruction manual for the UX256.

UX256 Yamaha USB-MIDI interface.

Connecting the UX256 to the Clavinova using a serial cable

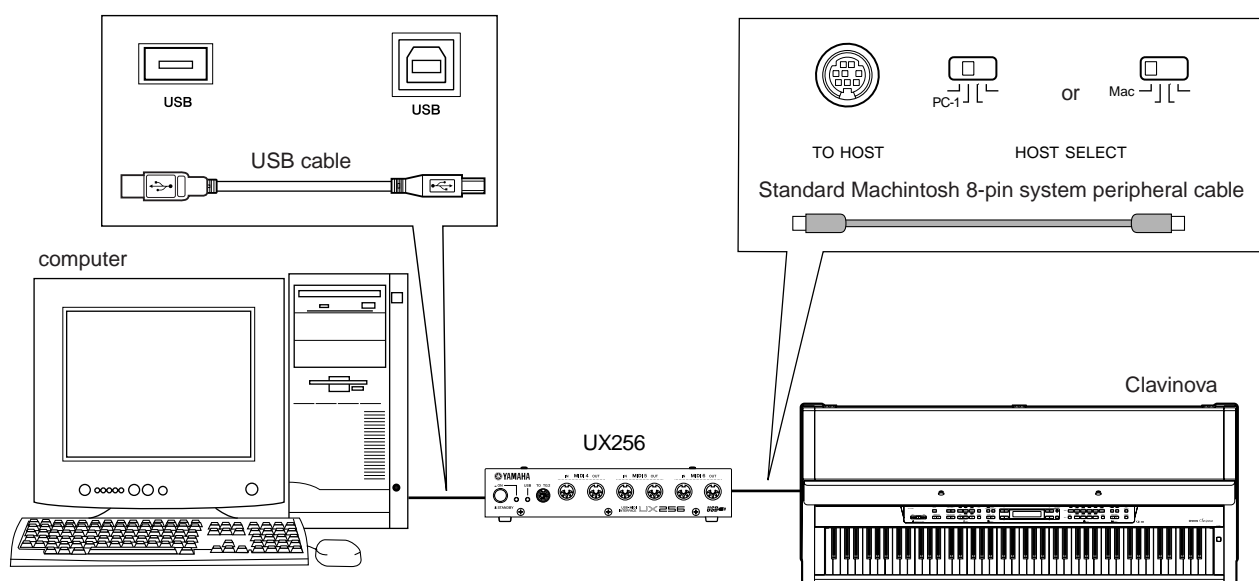

Connecting the UX256 to the Clavinova using MIDI cables

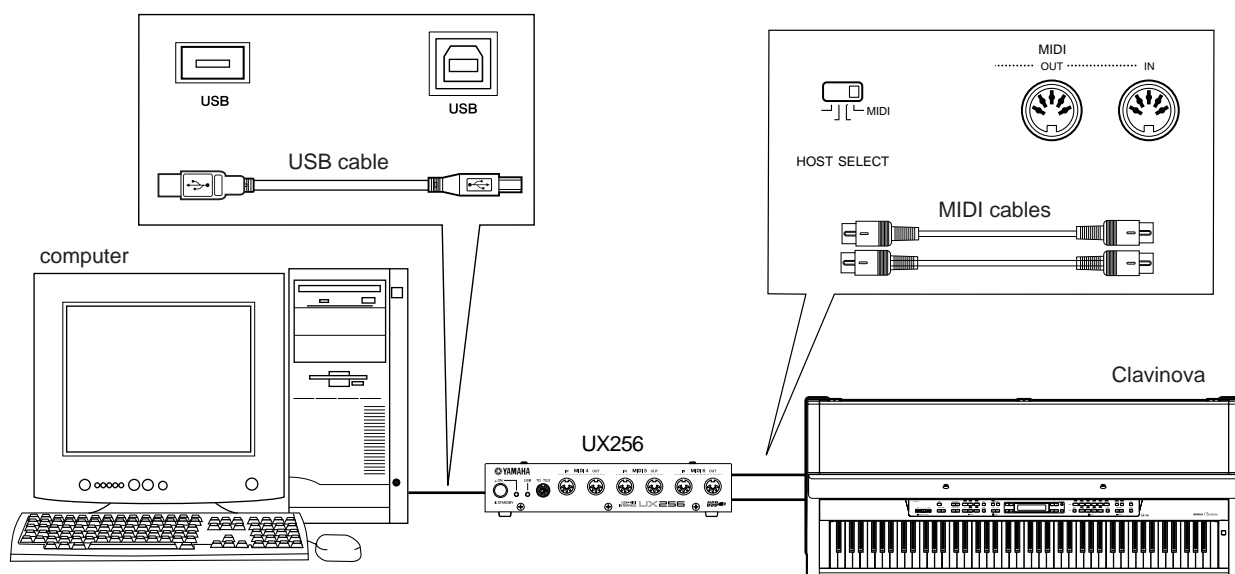

Detailed Settings

Detailed Settings

You can set various parameters to make the best use of Clavinova functions, such as fine tuning the pitch, selecting a voice for the metronome, repeating playback, etc. See page 72 for the normal (default) setting for each parameter.

Parameter List

The following parameters are available.

Recording and playback [SONG SETTING]

Settings	Parameter name	Reference page
Correcting note timing	Quantize	74
Specifying whether playback starts immediately along with the first voicing	QuickPlay	75
Auditioning the channels	ChannelListen	75
Deleting data by each channel	ChannelClear	75
Specifying the range and playing back repeatedly	FromToRepeat	75
Playing back the phrase specified by the phrase number	PhraseMark	76
Playing back a song repeatedly	SongRepeat	76

Metronome METRONOME [SETTING]

Settings	Parameter name	Reference page
Metronome time signature	TimeSignature	77
Metronome volume level	MetronomeVolume	77
Metronome voice	MetronomeSound	77

Voices [VOICE SETTING]

In Dual mode, parameters with the “*” mark are set for Voice 1 and Voice 2 individually.

Settings	Parameter name	Reference page
Octave*	Octave	78
Volume level*	Volume	78
Position of right and left channels*	Pan	79
Fine pitch adjustment (only in Dual mode)	Detune	79
Reverb type	ReverbType	79
Reverb depth*	ReverbSend	79
Chorus type	ChorusType	80
Chorus depth*	ChorusSend	80
Chorus on/off	ChorusOnOff	80
Variation effect type	VariationType	80
Variation effect depth*	VariationSend	81
Touch sensitivity*	TouchSense	81

Right pedal function	RPedal	81
Center pedal function	MPedal	82
Left pedal function	LPedal	82
Auxiliary pedal function	AuxPedal	82

MIDI [MIDI SETTING]

Settings	Parameter name	Reference page
MIDI transmit channel	MidiOutChannel	84
MIDI receive channel (Port A)	MidiInAChannel	84
MIDI receive channel (Port B)	MidiInBChannel	85
Local control on/off	LocalControl	85
Selecting performance from the keyboard or song data for MIDI transmission	MidiOutSelect	85
Type of data received via MIDI	ReceiveParameter	85
Type of data transmitted via MIDI	TransmitParameter	86
Song data bulk dump	SongBulkDump	86
Transmitting the initial settings	InitialSetup	86
Voice data bulk dump	VoiceBulkDump	86

[OTHER SETTING]

Settings	Parameter name	Reference page
Selecting a touch response	TouchResponse	87
Fine tuning of the pitch	Tune	87
Selecting a tuning curve for a piano voice	PianoTuningCurve	87
Selecting a scale	Scale	88
Depth of string resonance	StringResonanceDepth	88
Depth of sustain sampling for the damper pedal	SustainSamplingDepth	88
Setting the speed of vibraphone's vibrato effect	VivraphoneRotorSpeed	89
Selecting a pedal function for vibraphone	VivraphonePedalMode	89
Assigning the START/PAUSE function to a pedal	PedalStart/Pause	89
Selecting a type of auxiliary pedal	AuxPedalType	89
Setting the point at which the damper pedal starts to affect the sound	HalfPedalPoint	90
Pitch bend range	PitchBendRange	90
Replacing the preset voices with XG voices	XGAlternative	90
Selecting the items saved at the time of shutdown	MemoryBackUp	91
Restoring the normal (default) settings	FactorySet	91

Making detailed settings

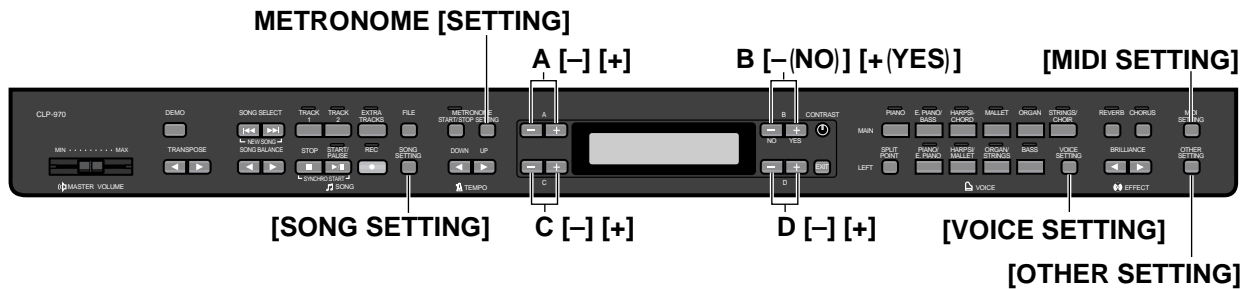

Procedure

- 1. Access a setting menu.**
Press the desired setting button ([SONG SETTING], METRONOME [SETTING], [VOICE SETTING], [MIDI SETTING], or [OTHER SETTING]) to access the corresponding setting menu.

Press the [EXIT] button any time to close the setting menu.

- 2. Select the desired parameter or part.**
Press the setting button, A [-]/[+], and/or C [-]/[+] buttons repeatedly as required.

- 3. Set the parameter or part.**
Some parameters or parts lead you to more options. Use the B [- (NO)]/[+ (YES)], C [-]/[+], and D [-]/[+] buttons to select or set the option.

To restore the normal parameter value, press the [-] and [+] buttons simultaneously.

4. Write, execute, or save the data.

There are two ways to respond to the messages.

If "Execute?→" or "Start?→" appears:

Press the B [+ (YES)] button to display confirmation ([Sure?→]). To proceed, press the B [+ (YES)] button again. The Clavinova displays "Executing" and writes the data. When the operation is complete, it displays "Completed" for three seconds, then returns to the previous screen.

To cancel the operation, press the B [- (NO)] button instead of the B [+ (YES)] button.



If "Set?→" appears:

Press the B [+ (YES)] button to execute the setting. The Clavinova displays "Executing" and saves the data. When the operation is complete, it displays "Completed" for three seconds, then returns to the previous screen.



5. Close the setting menu.

Press the [EXIT] button.

Detailed settings for recording and playback [SONG SETTING]

You can make detailed settings for the selected song. First, select the desired song from preset songs (“PresetSong”), memory songs (“MemorySong”), or disk songs (“DiskSong”) (see page 57).

Procedure

Select the desired song and press the [SONG SETTING] button to access the “Song Setting” menu.

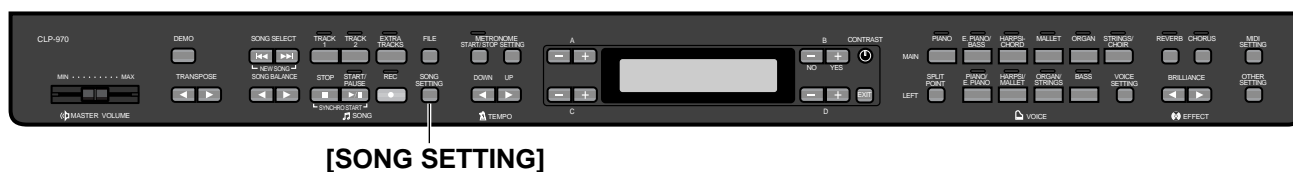

Correcting note timing [Quantize]

You can correct the timing of notes. For example, you can adjust recorded notes to precise eighth or sixteenth notes, or make the entire feel of a song more lively (with a swing type of rhythm).

- Changes are made by song.
- You can also listen to the sound while changing the setting. To change the data, you need to respond to “Execute?→”

See the procedure on page 72.

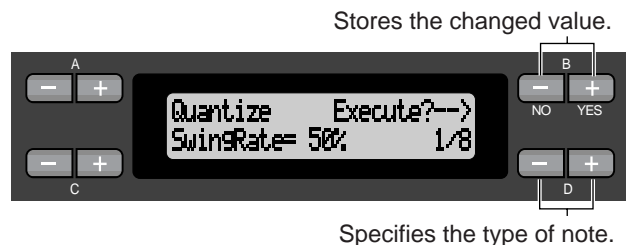





Stores the changed value.

Specifies the type of note.

Notes for which you can adjust the timing:

[OFF]

- [1/4]  quarter note
- [1/8]  eighth note
- [1/16]  sixteenth note
- [1/12]  eighth note triplets
- [1/24]  sixteenth note triplets

If you select “1/8” or “1/16” for correction, the Clavinova displays “SwingRate=xx%”, which enables you to make the entire feel of a song more lively and swinging.

Setting range:

0% - 100%

If you select “1/8” for correction:

Performance data



Swing rate = 50% : not swinging

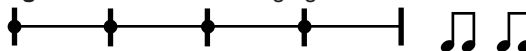

Swing rate = 75% (51% or higher) :

The timing of even beat notes is slightly delayed.

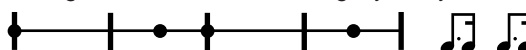

Swing rate = 25% (49% or lower) :

The timing of even beat notes is slightly early.

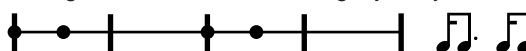

Swing rate = 67% :

The timing of the even beat notes is moved to the third beat of the triplets.

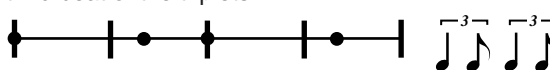

TIP

Save the edited song data to memory or a disk. (See page 50.)

Specifying whether playback starts immediately along with the first voicing [QuickPlay]

This parameter enables you to specify whether a song that starts from the middle of a bar, or a song with a silence prior to the first note, should be played from the first note or from the top of the bar (rest or blank). See the procedure on page 72.



Setting range:

- [On] Playing from the first note
- [Off] Playing from the top of the bar (including a rest or blank)

Auditioning the channels [ChannelListen]

You can select a single channel to listen to its contents. Playback starts from the first note. See the procedure on page 72.

Playback continues as long as you press and hold down this button.



Use these buttons to select the desired channel for playback.

Setting range:

Ch1 - Ch16

TIP

Usually, channels that do not contain any data are not displayed. However, for some songs, all channels (including the channels that contain no data) may be displayed.

Deleting data from each channel [ChannelClear]

You can delete data from each of 16 channels. See the procedure on page 72.

Press this button to delete data.



Use these buttons to select the desired channel for deletion.

Setting range:

Ch1 - Ch16, ALL (all channels)

TIP

- Channels that do not contain any data are not displayed. However, for some songs, all channels (including the channels that contain no data) may be displayed.
- Save the edited song data to memory or disk. (See page 50.)

Specifying the range and playing back repeatedly [FromToRepeat]

You can specify a range (in steps of beats) in a song to play back repeatedly.

- Playback repeats after it reaches just prior to the beat specified as the end point.
 - If you start playing back a song with “Repeat On” selected, the count down starts, followed by the repeated playback of the specified part until you press the [STOP] button.
 - If you select “Repeat Off,” normal playback starts.
- See the procedure on page 72.

Use these buttons to select “Repeat On.”



Use these buttons to specify the start point of the repeated range.

Use these buttons to specify the end point of the repeated range.

NOTE

When you select another song, the specified range is automatically cancelled and the Repeat function is turned off.

Playing back the phrase specified by the phrase number [Phrase-Mark]

If you select a song from an ensemble collection disk, such as the “Disk Orchestra Collection” or one of the “XG for Piano” disks, you can specify phrase numbers in the score to play back from the score from the mark point, or to play back the phrase repeatedly.

- If you start playing back a song with “Repeat On” selected, the count down starts, followed by the repeated playback of the specified phrase until you press the [STOP] button.
- If you select “Repeat Off,” normal playback starts from the specified phrase.

See the procedure on page 72.

Use these buttons to select “Repeat On.”



Use these buttons to specify the phrase number.

Setting range of the phrase number:

Off (not specified)

1 - the last phrase number of the song

If you select any song other than those from the “Disk Orchestra Collection” or one of the “XG for Piano” disks, you can select only “Off.”

Playing back a song repeatedly [SongRepeat]

You can repeatedly play back all songs or a single song selected from the 50 preset songs or from the floppy disks.

- When you start playback, the Clavinova plays the song you selected using the front panel, then starts repeat playback of the specified songs until you press the [STOP] button.

See the procedure on page 72.

Use these buttons to select “On.”



Use these buttons to specify the repeated songs.

Setting range:

- [DiskSongs] All songs in the floppy disk inserted in the disk drive
- [MemorySongs] All songs in the Clavinova’s memory
- [Disk+Memory] All songs from “DiskSongs” and “MemorySongs”
- [PresetSongs] All 50 preset songs
- [ALL] All songs from “DiskSongs,” “MemorySongs,” and “PresetSongs”
- [OneSong] One song selected from the front panel

Detailed settings for the metronome METRONOME [SETTING]

You can set the time signature, volume level, and voice of the Clavinova metronome.

Procedure

Press the [METRONOME SETTING] button to access the Metronome Setting menu.

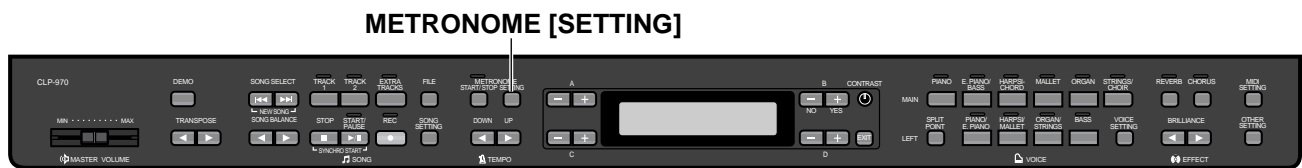

Setting the metronome time signature [TimeSignature]

See the procedure on page 72.

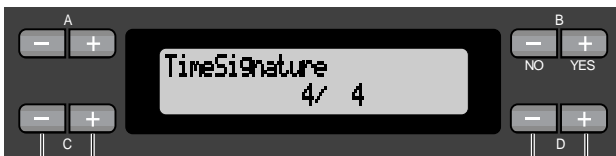

Use these buttons to set the numerator of the time signature.

Use these buttons to set the denominator of the time signature.

For example, to specify “3/4,” use the C [-]/[+] buttons to select “3” and the D [-]/[+] buttons to select “4.”

Setting range for the numerator:

1 - 16

Setting options for the denominator:

2, 4, and 8

Setting the metronome volume level [MetronomeVolume]

See the procedure on page 72.



Setting range:

0-127

Selecting the metronome voice [MetronomeSound]

See the procedure on page 72.



Setting range:

- | | |
|-----------------|------------------------------------|
| [BellOff] | Click (standard metronome sound) |
| [EnglishVoice] | Click and “1, 2, 3, 4” in English |
| [GermanVoice] | Click and “1, 2, 3, 4” in German |
| [JapaneseVoice] | Click and “1, 2, 3, 4” in Japanese |
| [FrenchVoice] | Click and “1, 2, 3, 4” in French |
| [SpanishVoice] | Click and “1, 2, 3, 4” in Spanish |
| [BellOn] | Click and bell |

TIP

To mute the beat count, select “BellOff.”

Detailed settings for the voices [VOICE SETTING]

This menu enables you to make various detailed settings for the voices in Dual or Split mode and the effects. You can make these settings for each voice (or each combination of voices) individually. You can listen to the notes you play on the keyboard while changing the settings.

Procedure

1. Select a voice and press the [VOICE SETTING] button to access the "Voice Setting" menu.

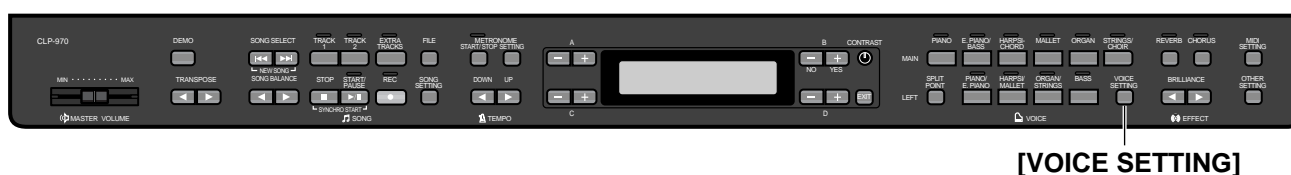

2. Press the A [-]/[+] buttons to select the part for which you wish to change the voice.

The range of the displayed part varies depending on the selected voice.

- [Main] MAIN voices (displayed with a single voice or in Split mode)
- [Main × Layer] MAIN Voice 1 and Voice 2 (displayed when the MAIN side is in Dual mode)
- [Left] LEFT voice (displayed in Split mode)
- [Left × Layer] LEFT Voice 1 and Voice 2 (displayed when the LEFT side is in Dual mode)

TIP

In Dual mode, parameters with the "*" mark are set for Voice 1 and Voice 2 individually.

Setting the octave [Octave]*

You can shift the pitch up and down in octave steps. See the procedure on page 72.

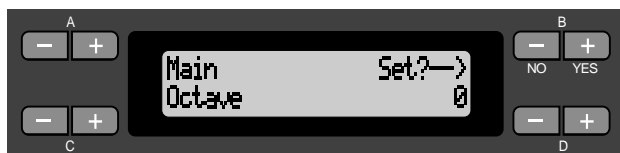

In Dual mode:



Voice for editing (Voice 1 or Voice 2)

Setting range:

-2 (two octaves lower) - 0 (no pitch shift) - +2 (two octaves higher)

Setting the volume level [Volume]*

You can set the volume level for each voice part. See the procedure on page 72.



In Dual mode:



Voice for editing (Voice 1 and Voice 2)

Setting range:

0 - 127

Setting the position of right and left channels [Pan]*

You can specify the position in the stereo image from which you hear the sound.

See the procedure on page 72.



In Dual mode:



Voice for editing (Voice 1 or Voice 2)

Setting range:

L64 (hard left) - C (center) - R63 (hard right)

Fine tuning the pitch (only in Dual mode) [Detune]

You can slightly shift the pitch of two voices selected for Dual mode.

See the procedure on page 72.



Setting range:

-20 - +20 (With positive values, the pitch of Voice 1 is raised and the pitch of Voice 2 is lowered. With negative values, the pitch of Voice 1 is lowered and the pitch of Voice 2 is raised.)

Selecting the reverb type [ReverbType]

TIP

You cannot set this parameter for the voice parts "Left" and "LeftXLayer."

See the procedure on page 72.

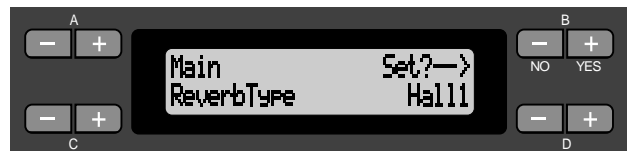

Setting range:

Room Simulates reverberation in a room.

Hall Simulates reverberation in a concert hall.

Hall2 Reverberation is slightly longer than that of "Hall1."

Stage Reverberation suitable for a solo instrument sound.

Plate Reverberation from the vibration of a metal plate.

Setting the reverb depth [ReverbSend]*

TIP

The reverb effect is not applied if the ReverbSend parameter is set to "0."

See the procedure on page 72.



Detailed settings for the voices [VOICE SETTING]

In Dual mode:



Voice for editing (Voice 1 or Voice 2)

Setting range:

0 - 127

Selecting the chorus type [Chorus Type]

TIP

You cannot set this parameter for the voice parts "Left" and "Left x Layer."

See the procedure on page 72.



Setting range:

- Chorus Adds a rich, spacious sound.
- Celeste Adds swell and a spacious sound.
- Flanger Adds swell effects of an ascending or descending jet plane.

Setting the chorus depth [ChorusSend]*

See the procedure on page 72.



In Dual mode:



Voice for editing (Voice 1 or Voice 2)

Setting range:

0 - 127

Setting the chorus on/off [ChorusOnOff]

You can set the [CHORUS] button on or off for each voice. When you select a voice, the chorus on/off setting for the voice automatically changes according to this parameter.

TIP

Even if this parameter is turned on, the chorus effect is disabled if the ChorusSend parameter is set to 0.

See the procedure on page 72.



Setting range:

On/Off

Selecting the variation effect type [VariationType]

You can select other effects (than reverb and chorus). See the procedure on page 72.



Setting range:

DelayLCR	Delay applied at left, center, and right positions.
DelayLR	Delay applied at left and right positions.
Echo	Echo-like delay
CrossDelay	Left and right delays are crossed.
Symphonic	Adds a rich and deep acoustic effect.
RotarySpeaker	Adds the vibrato effect of a rotary speaker.
Tremolo	The volume level changes in rapid cycles.
VibeRotor	The vibrato effect of a vibraphone.
AutoPan	The sound pans left to right and back and forth.
Phaser	The phase changes periodically, swelling the sound.
AutoWah	The center frequency of the wah filter changes periodically.
SoundBoardRev	Simulates the reverberation of a piano soundboard.
Off	No effect.

Setting the variation effect depth [VariationSend]*

See the procedure on page 72.



In Dual mode:



Voice for editing (Voice 1 or Voice 2)

Setting range:

0 - 127

Setting the touch sensitivity [TouchSense]*

This parameter enables/determines the manner and degree to which the volume level changes in response to your touch on the keyboard (how hard you play). Since the volume level of the harpsichords and pipe organs do not change regardless of how you play the keyboard, the normal setting for these voices is 127. (See the setting range below.)
See the procedure on page 72.



In Dual mode:



Voice for editing (Voice 1 or Voice 2)

Setting range:

0 (softest) - 64 (largest changes in the level) - 127 (loudest and fixed)

Setting the right pedal function [RPedal]

See the procedure on page 72.



Setting range:

SustainCont	Damper function that sustains the sound longer as you press the pedal deeper.
Sustain	On/Off switch type damper function.
PitchBend	Changes the pitch continuously.
Off	No function.

Normal setting:

SustainCount

Setting the center pedal function [MPedal]

See the procedure on page 72.



Setting range:

- Sostenuto** Sostenuto pedal function. (See page 31.)
- RotarySpeed** Changes the number of rotations of the rotary speaker effect in the JazzOrgan voice. (Pressing the pedal repeatedly toggles between fast and slow rotation speeds.)
- VibeRotor** Turns vibrato of the Vibraphone voice on and off. (Pressing the pedal repeatedly toggles between on and off.)
- Off** No function.

Normal Setting:

Sostenuto

Setting the left pedal function [LPedal]

See the procedure on page 72.



Setting range:

- Soft** Soft pedal function. (See page 31.)
- RotarySpeed** Changes the number of rotations of the rotary speaker effect in the JazzOrgan voice. (Pressing the pedal repeatedly toggles between fast and slow rotation speeds.)
- VibeRotor** Turns the vibrato of the Vibraphone voice on and off. (Pressing the pedal repeatedly toggles between on and off.)
- Off** No function.

Normal Setting:

Soft (for all voices other than JazzOrgan and Vibraphone)
 Rotary Speed (JazzOrgan), Vibraphone (VibeRotor)

Setting the auxiliary pedal function [AuxPedal]

You can assign a function to the pedal connected to the Clavinova's AUX PEDAL jack. See the procedure on page 72.



Setting range:

- Expression** Makes the sound softer or louder.
- Sustain** On/Off switch type damper function. (See page 31.)
- SustainCont** Damper function that sustains the sound longer as you press the pedal deeper. (See page 31.)
- PitchBend** Changes the pitch continuously.
- Sostenuto** Sostenuto pedal function. (See page 31.)
- Soft** Soft pedal function. (See page 31.)
- RotarySpeed** Changes the number of rotations of the rotary speaker effect in the JazzOrgan voice. (Pressing the pedal repeatedly toggles between fast and slow rotation speeds.)
- VibeRotor** Turns the vibrato of the Vibraphone voice on and off. (Pressing the pedal repeatedly toggles between on and off.)
- Off** No function.

Normal setting:

Expression

TIP

Optional pedals

- Yamaha FC7 foot controller
This foot controller is suitable for controlling Expression, SustainCont, and PitchBend.
- Yamaha FC4 foot controller
Yamaha FC5 foot controller
These foot switches are suitable for controlling Sustain, Sostenuto, Soft, RotarySpeed, and VibeRotor.

MIDI [MIDI SETTING]

You can make detailed MIDI settings, such as setting up MIDI transmit/receive channels.

About MIDI

MIDI (Musical Instrument Digital Interface) is a standard format for data transmission/reception. It enables the transfer of performance data and commands between MIDI devices and personal computers.

Using MIDI, you can control a connected MIDI device from the Clavinova, or control the Clavinova from a connected MIDI device or computer.

MIDI connectors

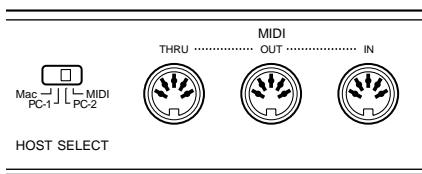

MIDI [IN]: Receives MIDI data.

MIDI [OUT]: Transmits MIDI data.

MIDI [THRU]: Transmits data received at the MIDI [IN] connector as it is.

TIP

Prepare dedicated MIDI cables.

[TO HOST] connector

Use this connector to connect the Clavinova to a computer.

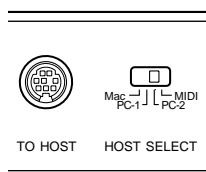

TIP

The type connecting cable varies depending on the computer. Refer to "Connecting a Personal Computer" on page 63 for more information.

TIP

MIDI performance data and commands are transferred in the form of numeric values.

Since MIDI data that can be transmitted or received varies depending on the type of MIDI device, check the "MIDI Implementation Chart" to find out what MIDI data and commands your devices can transmit or receive. The Clavinova's MIDI Implementation Chart is listed on pages 31 and 32 in the "Reference Booklet" for the CLP-970.

When you are using the MIDI connectors, set the [HOST SELECT] switch to "MIDI." (See page 63.)

TIP

When you are using the [TO HOST] connector, set the [HOST SELECT] switch correctly, according to the type of computer you are using. (See page 63.)

You can also obtain detailed information about MIDI from various music magazines and books.

Procedure

Press the [MIDI SETTING] button to enter MIDI setting mode.



Setting the MIDI transmit channel [MidiOutChannel]

This parameter enables you to specify the channel on which the Clavinova transmits MIDI data. See the procedure on page 72.



Select a voice part.

Specify the channel.

Setting for:

Main, Left, Layer, Left Layer

Setting range:

Ch1 - Ch16, Off (Not transmitted.)

Normal setting:

Main — Ch1

Left — Ch2

Layer — Ch3

Left Layer— Ch4

Setting the MIDI receive channel (Port A) [MidiInAChannel]

This parameter enables you to specify for each channel whether the Clavinova receives data at the MIDI [IN] connector or the [TO HOST] port A (CBX driver's port A).

TIP

The received data is played back using the XG voices (page 6 in the "Reference Booklet" for the CLP-970). You can also assign the Clavinova's preset voices to part of the data. (See "XG Alternative" on page 90.)

See the procedure on page 72.



Select a channel.

Select On or Off.

Setting for:

Ch1 - Ch16

Setting range:

On/Off

Normal setting:

On for all channels

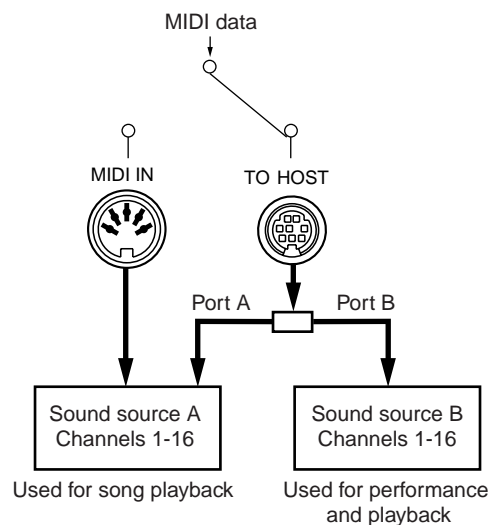

Setting the MIDI receive channel (Port B) [MidiInAChannel]

This parameter enables you to specify for each channel whether the Clavinova receives data at the MIDI [IN] connector or the [TO HOST] port B (CBX driver's port B).

TIP

The received data is played back using the preset voices (page 103).

See the procedure on page 72.



Setting for:

Ch1 - Ch16

Setting range:

On/Off

Normal setting:

On for all channels

Setting Local control on/off [LocalControl]

“Local Control On” is a state in which the Clavinova produces the sound from its tone generator when you play the keyboard. In “Local Control Off” state, the keyboard and the tone generator are cut off from each other. This means that even if you play the keyboard, the Clavinova will not produce the sound. Instead, the keyboard data can be transmitted via MIDI to a connected MIDI device, which can produce the sound. The “Local Control Off” setting is useful when you wish to play an external sound source while playing the keys on the Clavinova.

See the procedure on page 72.



Setting range:

On/Off

Normal setting:

On

Selecting performance from the keyboard or song data for MIDI transmission [MidiOutSelect]

You can select whether your performance data or song playback data (including demo songs) is sent via MIDI.

See the procedure on page 72.



Setting range:

Keyboard (performance data played on the keyboard)
Song (song playback data)

Normal setting:

Keyboard

Selecting a type of data received via MIDI [ReceiveParameter]

This parameter enables you to specify which MIDI data the Clavinova can receive.

See the procedure on page 72.

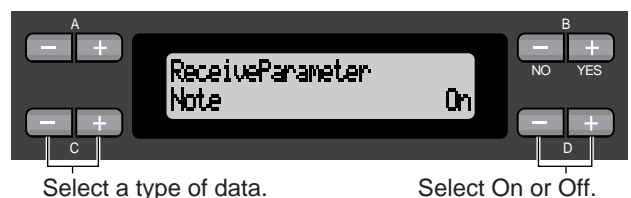

Type of data:

Note, Control, Program, Pitch Bend, SysEx (System Exclusive)

Setting range:

On/Off

Normal setting:

On for all types of data

Selecting a type of data transmitted via MIDI [TransmitParameter]

This parameter enables you to specify which MIDI data the Clavinova can transmit. See the procedure on page 72.



Type of data:

Note, Control, Program, Pitch Bend, SystemRealTime, SysEx (System Exclusive)

Setting range:

On/Off

Normal setting:

On for all types of data

Executing song data bulk dump [SongBulkDump]

You can save current song data on the Clavinova as MIDI bulk data by transferring it to a connected MIDI data file (such as an MDF3) or a sequencer. To play back the saved song data, send the bulk data back from the storage device to the Clavinova and follow the usual playback procedure.

You can interrupt song data bulk dump transmission by pressing the B [- (NO)] button.

See the procedure on page 72.



Transmitting the initial settings on the panel [InitialSetup]

You can transmit the panel data, such as voice selection, to a connected sequencer. Before you record performance data to a connected MDF3 or sequencer, it is useful if you first send and record (at the beginning of the performance data) the panel setup data for your performance during playback. See the procedure on page 72.



Executing voice data bulk dump [VoiceBulkDump]

You can transmit the voice data specified in the “Voice Setting” menu (page 78) as MIDI bulk data. You can interrupt voice data bulk dump transmission by pressing the B [- (NO)] button.

See the procedure on page 72.



Other settings

You can make detailed settings for touch, tuning, scale, etc.

Procedure

Press the [OTHER SETTING] button to enter Other Setting mode.

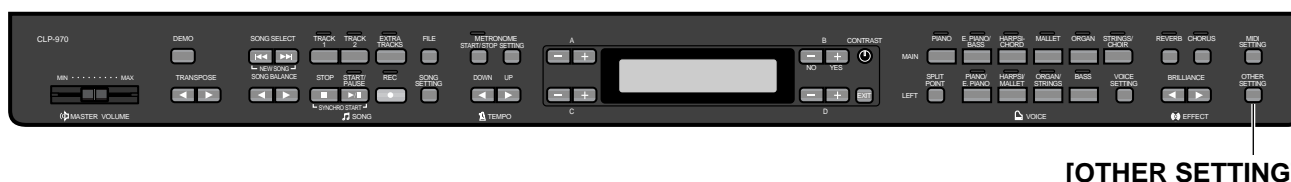

Selecting a touch response [TouchResponse]

You can specify a touch response (how the sound responds to the way you play the keys). See the procedure on page 72.



Setting range:

- Light** With a soft touch, the Clavinova produces a loud sound. The volume level of tones tends to be consistent.
- Medium** Standard touch response.
- Heavy** You must hit the key very hard to generate a loud volume. This allows for versatile expression, from pianissimo to fortissimo tones.
- Fixed** No touch response. The volume level will be the same regardless of how hard you play the keys. Use the B [-]/[+] buttons to set the volume level.

Setting range of the "Fixed" volume level:

1 - 127

Fine tuning the pitch [Tune]

You can fine tune the pitch of the entire instrument. This function is useful when you play the Clavinova along with other instruments or CD music. See the procedure on page 72.



Setting range:

A3=427.0Hz - 453.0Hz (0.1Hz steps)

Selecting a tuning curve for a piano voice [PianoTuningCurve]

You can select a tuning curve from "GrandPiano1" and "GrandPiano2." Select "Flat" if you feel the tuning curve of the piano voice does not quite match that of other instruments voices. See the procedure on page 72.



Setting range:

- Stretch** Tuning curve particularly for pianos
- Flat** Tuning curve in which the frequency is octave doubled over the entire keyboard range

Selecting a scale [Scale]

You can select various scales.

Equal Temperament is the most common contemporary piano tuning scale. However, history has known numerous other scales, many of which serve as the basis for certain genres of music. You can experience the tunings of these genres.

See the procedure on page 72.



Setting range:

Equal One octave is divided into twelve equal intervals. Currently most popular piano tuning scale.

PureMajor/PureMinor

Based on natural overtones, three major chords using these scales produce a beautiful, pure sound. They are sometimes used for chorus parts.

Pythagorean

This scale, designed by Pythagoras, a Greek philosopher, is composed of only five pitches. The 3rd produces swells, but the 4th and 5th are beautiful and suitable for some leads.

MeanTone

This scale is an improvement of the Pythagorean in that the swell of the 3rd has been eliminated. It spread during the late 16th century through the late 18th century. Handel used this scale.

WerckMeister/KirnBerger

These scales combine Mean Tone and Pythagorean in different ways. With these scales, modulation changes the impression and feel of the songs. They were often used in the era of Bach and Beethoven. They are also often used now to reproduce the music of that era on harpsichords.

Normal setting:

Equal

If you select a scale other than Equal, you need to specify the root note using the B [-]/[+] buttons.



Setting range:

C, C[♯], D, E[♭], E, F, F[♯], G, A[♭], A, B[♭], B

Depth of string resonance [StringResonanceDepth]

This parameter is effective only on “GrandPiano1.” See the procedure on page 72.



Setting range:

1 - 10, Off

Depth of sustain sampling for the damper pedal [SustainSamplingDepth]

This parameter is effective only on “GrandPiano1.” See the procedure on page 72.



Setting range:

1 - 10, Off

Setting the speed of vibraphone's vibrato effect [VibraphoneRotorSpeed]

This parameter enables you to set the speed of vibrato when you select the Vibraphone voice and use a vibrate pedal.

See the procedure on page 72.



Setting range:

1 - 10, Off

Selecting a pedal function for vibraphone [VibraphonePedalMode]

This parameter enables you to select whether the sound is sustained while you press the keys on the keyboard ("PianoLike") or the sound is sustained only while you press and hold down the sustain pedal, like playing a real vibraphone ("Normal").

See the procedure on page 72.



Setting range:

PianoLike, Normal

Normal setting:

PianoLike

Assigning the START/PAUSE function to a pedal [PedalStart/Pause]

TIP

If you assign the START/PAUSE function to a pedal and turn the function On, the pedal function assigned to the pedal in the Voice Setting menu (pages 81 and 82) is disabled.

See the procedure on page 72.



Select a pedal to assign the function. Set to On or Off.

Setting for:

Left, Middle, AUX

Setting range:

On/Off

Normal setting:

Off for all pedals

Selecting a type of auxiliary pedal [AuxPedalType]

A pedal connected to the [AUX PEDAL] connector may switch on and off differently. For example, some pedals turn on the effects and others turn them off when you press them.

Use this parameter to reverse this mechanism.

See the procedure on page 72.



Setting range:

Make, Break

Setting the point at which the damper pedal starts to affect the sound [HalfPedalPoint]

You can specify how far down you should press on the right pedal until the damper effect (page 31) starts working. This setting is effective when the right pedal function (page 81) is set to either SustainCont or Sustain.

See the procedure on page 72.



Setting range:

-2 (effective with the shallowest press) - 0 - +2 (effective with the deepest press)

Pitch bend range [PitchBendRange]

This parameter enables you to set the range of continuous pitch change made by the Pitch Bend function.

- This parameter is effective only on the keyboard performance sound.
- You can set the range in semitone steps.

See the procedure on page 72.



Setting range:

-12 (Pitch is lowered by 12 semitones [one octave] when you press the pedal.) - +12 (Pitch is raised by 12 semitones [one octave] when you press the pedal.)

Normal setting:

-2

Replacing the XG voices with preset voices [XGAlternative]

The CLP-970 provides the XG tone generator for the purpose of playing GM, XG, or DOC music data (page 60). You can replace some XG voices with the preset voices on the panel for playback. This parameter enables you to select "Native" (using the preset voices) or "XG" (using the XG voices).

See the procedure on page 72.



Select the desired item.

Select on or off.

Setting for:

All preset voices on the panel

Setting range:

Native Using the preset voices

XG Using the XG voices

Normal setting:

GrandPiano1 Native (using the preset voices)

Other voices XG (using the XG voices)

Selecting items saved at shut-down [MemoryBackUp]

You can back up some settings, such as voice selection and metronome setting, so that they will not be lost after you turn off the power to the Clavinova.

- Memory songs (saved in the Clavinova's memory), the backup on/off setting (this parameter setting), and the "CharacterCode" parameter setting (page 56) are always backed up.

See the procedure on page 72.



Select the desired item.

Select on or off.

Setting for:

Transpose, Brilliance, ReverbOnOff, SplitPoint, Main/LeftVoice, MetronomeSetting, SongSetting, SongBalance, MidiSetting, and OtherSetting

Setting range:

On/Off

Normal setting:

The Transpose, Main/LeftVoice, and MetronomeSetting parameters are set to Off. Other parameters are set to On.

Restoring the normal (default) settings [FactorySet]

You can reset the Clavinova to its normal (factory default) settings.

- The CharacterCode parameter setting in the File menu does not change.
- The MemoryBackUp parameter setting (On/Off) (left column) is reset to the normal setting.
- You can specify whether the memory songs are erased or kept.

See the procedure on page 72.

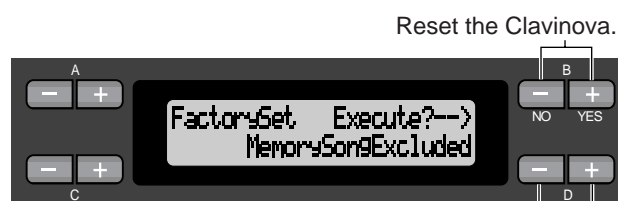

Select a value for memory songs.

Selecting for "MemorySong":

MemorySongExcluded Memory songs are kept.

MemorySongIncluded Memory songs are erased.

Other method for restoring the normal settings

Press and hold down the white key on the right end (C7) and press the [POWER] switch to turn on the power to the Clavinova. In this case, the Memory songs saved in the storage memory are not erased.

If you wish to erase Memory songs at this time, press and hold down the right-most white key (C7) and black key (B^b6) and press the [POWER] switch to turn on the power to the Clavinova.

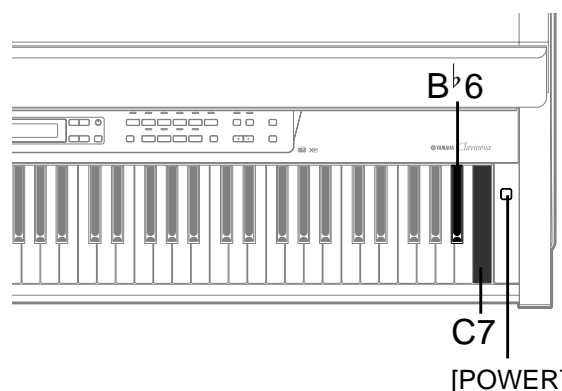

Message List

The messages are listed in alphabetical order.

Message	Meaning
BulkDataReceiving Completed	This message is displayed following the message “BulkDataReceiving Song/Voice.” Receiving bulk data is complete. After this message appears, you can proceed to the next step.
BulkDataReceiving Error	Receiving bulk data has failed. Check the parameter settings and try again.
BulkDataReceiving Song	The Clavinova is receiving the song bulk data while this message is displayed. Wait until the message disappears, then proceed to the next step.
BulkDataReceiving Voice	The Clavinova is receiving the voice setting bulk data while this message is displayed. Wait until the message disappears, then proceed to the next step.
Canceled	You have cancelled the “SongBulkDump” (page 86) or “VoiceBulkDump” (page 86) transmission by pressing the B [–(NO)] button.
Completed	This message is displayed following the message “Executing.” The Clavinova’s internal processing is complete. You may proceed to the next step.
DiskError	Writing or reading data from the disk has failed. Try again. If you still see this message, the disk may be damaged or the disk drive may have malfunctioned. If you see this message while using a brand new disk, it is more likely that the disk drive is malfunctioning. Ask your Yamaha dealer for repair.
DiskFull	The floppy disk space is full and can no longer record data. Use a new disk (page 53) or delete unnecessary files from the disk (page 53) to make room for new data.
DiskRemoved	You attempted to eject a floppy disk from the disk drive while the drive was writing or reading. The writing or reading operation is not complete yet. Try it again.

Message	Meaning
DuplicateName	You tried to save a song by changing its title (using the “RenameSong” (page 54), “SaveToMemory” (page 52), or “SaveToDisk” (page 53) parameter), but a song with the same name already exists in memory or on the floppy disk. Three seconds after this message appears, the previous screen is restored. Rename the song.
Execute?-->	This message prompts you to execute a file-related operation. Press the B [+ (YES)] button to proceed, or press the [EXIT] button to cancel.
Executing	The Clavinova is processing the data internally. Wait until the message disappears, then proceed to the next step.
FactorySet Completed MemorySongExcluded	The normal (factory default) settings (except for the memory song setting) (“FactorySet” on page 91) have been restored. This message also appears if you press and hold down the C7 key and turn on the power to the Clavinova (page 91).
FactorySet Completed MemorySongIncluded	The normal (factory default) settings (including the memory song setting) (“FactorySet” on page 91) have been restored. This message also appears if you press and hold down the C7 and B ^b 6 keys and turn on the power to the Clavinova (page 91).
FlashMemoryLifeTime Exit-->	The Clavinova’s flash memory (storage memory) has expired. Consult your Yamaha dealer. If this message appears, the Clavinova will not back up the songs and settings in memory. Press the [EXIT] button to return to the previous screen.
InsrtSourceDisk	In the CopyDisk operation (page 55), the copy source disk has not been inserted to the disk drive. Insert the disk.
InsrtTargetDisk	In the CopyDisk operation (page 55), the copy destination disk has not been inserted into the disk drive. Insert the disk.
LastPowerOffIllegal MemorySongChecking	You turned off the power to the Clavinova while it was writing a song to storage memory. This message appears next time you turn on the power. The Clavinova checks if the contents of storage memory can be recovered.
LastPowerOffIllegal MemorySongErrorRecovered	This message appears following the message “LastPowerOffIllegalMemorySongChecking,” indicating that the Clavinova recovered data in the storage memory as much as possible.

Message List

Message	Meaning
LastPowerOffIllegalMemorySongsErased	This message appears following the message “LastPowerOffIllegalMemorySongChecking,” indicating that the Clavinova could not recover data in the storage memory and that all memory songs were deleted.
MemoryFull	There is not enough memory space left and you cannot save any more songs. Save songs to a floppy disk (page 53) or delete some songs in the storage memory, then save new data to memory.
NoDisk	A floppy disk has not been inserted into the disk drive for a disk-related operation. Insert the disk and continue.
NoSongsToDelete	You tried to delete a song that does not exist in the storage memory or on disk. You cannot delete the song.
OverWrite?	This message prompts you to select whether you wish to overwrite the existing data with new data when you add recordings to a song. Press the B [+ (YES)] button to allow overwriting. Press the B [- (NO)] button to cancel.
PleaseWait	You tried to start playing a song or perform another operation right after you select the song. Wait until the message disappears.
ProtectedDisk	<ol style="list-style-type: none">1. You tried to write, copy, or delete data on a disk that has its “write protect” tab on, or a disk that is internally protected against writing. Set the protect tab to off (unprotected) (page 14) and try again. If you still see this message, the disk is internally protected (such as commercially available music data). You cannot write or copy to such a disk.2. This message also appears when you try to copy data on an internally-protected disk onto another disk using the CopyDisk function (page 55). You cannot duplicate such a disk.
ProtectedFile	You tried to copy or delete data in internally-protected files (such as commercially available music data). You cannot write to, copy, or delete such files.

Message	Meaning
ProtectedSong	<ol style="list-style-type: none"> 1. After you load an internally-protected song into the Clavinova's Current memory or storage memory, you tried to save the song to a floppy disk. You cannot save such a song to another disk. You cannot write or copy to such a disk. 2. This message also appears if you try to transmit bulk data (page 86) of an internally-protected song (such as commercially available music data). You cannot transmit bulk data of such songs.
Set?-->	<p>This message prompts you to select whether you wish to save the edited settings. Press the B [+ (YES)] button to save the settings. Press the [EXIT] button to cancel.</p>
SongChanged Save?	<p>You tried to perform another operation before saving the recorded song to storage memory or a floppy disk. If you continue the operation, the recorded song will be lost. To delete the new recording, press the B [- (NO)] button. To keep the recording, press the B [+ (YES)] button. The Clavinova displays the "SaveToMemory" (page 52) or "SaveToDisk" (page 53) parameter screen. If necessary, select "SaveToMemory" or "SaveToDisk" accordingly and save the recorded song, then proceed to another operation.</p>
SongError	<p>The Clavinova has found some defects in the selected (or playing) song. Select the song and play it again. If you still see this message, the song data may be damaged.</p>
SongTooBig	<p>The Current memory space is full during recording. Recording stops automatically. The data recorded up to that point remains. This message also appears when you try to enter recording mode to make an additional recording but the song data already fills the Current memory. In this case, you cannot make an additional recording. Use the "ChannelClear" parameter (page 75) to delete unnecessary tracks (if any) to make more room in memory.</p>
SongTooBig	<p>The size of the selected song is larger than the Current memory (page 97). The CLP-970 cannot read the song. Select another song.</p>
Start?-->	<p>This message prompts you to start the operation. To start, press the B [+ (YES)] button. Press the [EXIT] button to cancel the operation.</p>

Message List

Message	Meaning
<code>Sure?--></code>	This message prompts you to confirm the execution. Press the B [+ (YES)] button to continue. Press the B [- (NO)] button to cancel.
<code>ToHostError</code>	<p>There is a malfunction with the TO HOST connector.</p> <p>When you are using the CLP-970 with a connected computer: The power to the computer is turned off, the cables are connected incorrectly, the [HOST SELECT] switch is set incorrectly, or the driver or MIDI application on the computer works incorrectly. Turn off the power to the CLP-970 and the computer, then check the cable connections and the [HOST SELECT] switch setting. Then, turn on the power to the computer and the CLP-970 in this order and check to see if the driver and MIDI application on the computer work properly.</p> <p>When you are using only the CLP-970: This message appears if a cable is connected to the TO HOST connector on the CLP-970. In this case, turn off the power to the CLP-970, remove the cable from the TO HOST connector, then turn on the power to the CLP-970. If the cable is left connected to the TO HOST connector, the CLP-970 may not work correctly.</p>
<code>UnformattedDisk</code>	You tried to perform a file- or disk-related operation using an unformatted disk. Eject the disk, format it using the "FormatDisk" parameter (page 56), and try again.
<code>UnformattedDisk Format?</code>	You tried to perform a file- or disk-related operation using an unformatted disk. To cancel the operation, press the B [- (NO)] button. To format the disk and try again, press the B [+ (YES)] button to display the "FormatDisk" parameter (page 56).
<code>WrongDisk</code>	You tried to copy data to a different type of disk (e.x.: 2DD→2HD, 2HD→2DD) during the CopyDisk operation (page 55). Eject the disk and insert an appropriate disk.
<code>WrongName</code>	You used a period or space at the beginning of a song name or you tried to change a song name that includes a character (or characters) not supported by the CLP-970, and the CLP-970 could not process the name. The Clavinova displays the previous screen in three seconds. Rename the song correctly.

Questions about Operations and Functions

■ The buttons do not respond.

While you are using a function, some buttons not used for the function are disabled. If the song is playing, stop the playback. Otherwise, press the [EXIT] button to return to the main screen. Then, perform the desired operation.

■ The sound sustains and does not decay when I press the sostenuto pedal.

With the voices in the ORGAN or STRINGS/CHOIR group, the sound continues sustaining while you are holding down the sostenuto pedal.

■ Higher or lower notes does not sound correctly when the transpose or octave setting is made.

The setting range for the transposition and octave setting is C2 - G8. (With the normal setting, the Clavinova's 88 keys covers the range of A1 - C7.) If the lowest key is set to a note lower than C2, it will produce a sound one octave higher. If the highest key is set to a note higher than G8, it will produce a sound one octave lower.

■ How can I return to the recording or song select screen during song recording or playback?

Press one of the SONG SELECT [◀◀] and [▶▶] buttons once.

■ The tempo does not change even though I recorded with tempo changes.

Depending on the timing of tempo changes, the changed tempo may not be recorded. In this case, the recording will be played back at the original tempo.

Make tempo changes when the recording track is selected and a red track indicator is flashing. The same trick applies to editing the tempo after recording.

■ Performance in Dual or Split mode is not recorded.

Track data is lost unexpectedly.

For Dual or Split mode recording, the recording track for the second voice (that is, the voice for the left-hand part) is automatically assigned (page 48). Therefore, if the track already has data, the data will be overwritten during recording. Also, switching to Dual mode or Split mode in the middle of the song is not recorded. Therefore, the notes you played with the second voice (or the notes lower than the Split point) are not recorded.

■ What type of data is recorded?

Data recorded in the tracks:

- Note data (notes you play)
- Voice selection
- Clavinova pedals and external pedals on/off
- Reverb depth "ReverbSend"
- Chorus depth "ChorusSend"
- Variation effect depth "VariationSend"
- Voice octave setting "Octave"
- Voice volume level "Volume"
- Stereo image of each voice "Pan"
- Fine tuning of two voice pitch (Dual mode) "Detune"
- Volume level changes for each voice with response to the way you play "TouchSense"

Data recorded globally in all tracks:

- Tempo
- Time signature
- Reverb type
- Chorus type
- Variation effect type

You can change all data except for note data after recording.

You can change the time signature at the beginning of the song, or at a position in the song to which you move, by using the B [-]/[+] buttons while the song is stopped.

■ **I cannot change the key signature in the song after recording.**

Press the [STOP] button to locate the top of the song, use the B [-]/[+] buttons to locate the measure in which you wish to change the key signature, then change it.

■ **How much data can I record?**

- Current memory (page 50): About 600KB
- Storage memory (page 50): About 750KB
- 2DD floppy disk (page 13): about 720KB
- 2HD floppy disk (page 13): about 1.4MB

■ **The on/off setting of the pedal connected to the AUX PEDAL jack is reversed.**

Some types of pedals may turn on and off in opposite fashion. Use the “AuxPedalType” parameter (page 89) in the “OTHER SETTING” menu to change the external pedal setting.

■ **The song title is not correct.**

The “CharacterCode” setting may be different than that used when you named the song. Also, if the song was recorded on another instrument, the title might be displayed incorrectly. Use the “CharacterCode” parameter (page 56) in the FILE menu to change the setting. However, if the song was recorded on another instrument, changing the “CharacterCode” parameter setting may not resolve the problem.

■ **What is the difference between “TouchSense” and “TouchResponse” MIDI data?**

“TouchSense” determines the manner and degree to which the volume level changes in response to your touch on the keyboard. It causes MIDI exclusive data (that controls the tone generator) to be output.

“TouchResponse” determines the touch sensitivity as an instrument and causes MIDI note-on velocity data to be output.

Appendix

Troubleshooting

Problem	Cause	Solution
The Clavinova does not turn on.	The Clavinova has not been plugged in properly.	Securely insert the female plug into the socket on the Clavinova, and the male plug into a proper AC outlet. (See page 19.)
A click or pop is heard when the power is turned on or off.	Electrical current is being applied to the instrument.	This is normal, and is no cause for concern.
Noise is heard from the Clavinova's speakers.	The noise may be due to interference caused by the use of a mobile phone in close proximity to the Clavinova.	Turn off the mobile phone, or use it further away from the Clavinova.
The overall volume is low, or no sound is heard.	The [MASTER VOLUME] is set too low.	Raise the [MASTER VOLUME] level. (See page 20.)
	Headphones are connected.	Unplug the headphones. (See page 20.)
	The Local Control function is turned off.	Turn the Local Control function on. (See page 85.)
The damper pedal has no effect, or the sound continuously sustains even when the damper pedal is not pressed.	The pedal cord plug is not connected.	Securely insert the pedal cord plug into the proper jack. (See step 5 on page 107.)
The pitch and/or tone of the piano voices in certain ranges do not sound right.	The Clavinova's piano voices attempt to precisely simulate actual piano sounds. However, as a result of sampling algorithms, overtones in some ranges may sound exaggerated, producing a somewhat different pitch or tone.	This is normal.
Mechanical noise is heard during performance.	The Clavinova's keyboard mechanism simulates the keyboard mechanism of a piano. Mechanical noise is also heard on a piano.	This is normal.

Data Compatibility

This section covers basic information on data compatibility: whether or not other MIDI devices can playback the data recorded by CLP-970, and whether or not the CLP-970 can playback commercially available song data or song data created for other instruments or on a computer.

Depending on the MIDI device or data characteristics, you may be able to play back the data without any problem, or you may have to perform some special operations before the data can be played back. If you run into problems playing back data, please refer to the information below.

Basic Check Points

The data and the MIDI device must match in regards to the items below.

- Disk Format
- Sequence format
- Voice allocation format

Disk format

Floppy disks are the main storage medium for data used with various devices, including computers. Different devices have different systems of saving data, therefore it is necessary to first configure the floppy disk to the system of the device being used. This operation is called “formatting.”

- There are two types of floppy disks: MF2DD (double sided, double density) and MF2HD (double sided, high density), and each type has different formatting systems.
- CLP-970 can record and playback with both types of floppy disks.
- When formatted by the CLP-970, a 2DD disk saves up to 720 KB (kilobytes) and a 2HD disk saves up to 1.44 MB (megabytes). (The figures “720 KB” and “1.44 MB” indicate the data memory capacity. They are also used to indicate the format type of disk.)
- Playback is only possible when the MIDI device to be used is compatible with the format of the disk.

Sequence Format

The system which records song data is called “sequence format.”

- Playback is only possible when the sequence format of the disk matches that of the MIDI device.

[Common Sequence Formats]

■ SMF (Standard MIDI File)

This is the most common sequence format.

- Standard MIDI Files are generally available as one of two types: Format 0 or Format 1.
- Many MIDI devices are compatible with Format 0, and most commercially available software is recorded as Format 0.
- The CLP-970 is compatible with both Format 0 and Format 1 (for Format 1, up to a maximum of 17 chunks).
- Performance data recorded on the CLP-970 is saved in the SMF format 0 in a floppy disk.

■ ESEQ

This sequence format is compatible with many of Yamaha’s MIDI devices, including the Clavinova series instruments. This is a common format used with various Yamaha software.

- The CLP-970 is compatible with ESEQ.

Voice Allocation Format

With MIDI, voices are assigned to specific numbers, called “program numbers.” The numbering standard (order of voice allocation) is referred to as the “voice allocation format.”

- Voices may not play back as expected unless the voice allocation format of the song data matches that of the compatible MIDI device used for playback.

[Main Voice Allocation Formats]

■ GM System Level 1

This is one of the most common voice allocation formats.

- Many MIDI devices are compatible with GM System Level 1, as is most commercially available software.
- The CLP-970 is compatible with GM System Level 1.

■ XG

XG is a major enhancement of the GM System Level 1 format, and was developed by Yamaha specifically to provide more voices and variations, as well as greater expressive control over voices and effects, and to ensure compatibility of data well into the future.

- The CLP-970 is compatible with XG.
- Performance data recorded with preset voices on the CLP-970 can be played on other XG-compatible instruments.

■ DOC (Disk Orchestra Collection)

This voice allocation format is compatible with many of Yamaha’s MIDI devices, including the Clavinova series instruments.

This is also common format used with various Yamaha software.

The CLP-970 is compatible with DOC.

- Even if the devices and data used satisfy all the conditions above, the data may still not be completely compatible, depending on the specifications of the devices and particular data recording methods.

Preset Voice List

Voice name	Stereo sampling	Touch Sense	Dynamic sampling	Key-off samples	String resonance	Voice description
GrandPiano1	○	○	○	○	○	This voice has been sampled from a full concert grand piano. It features five-stage dynamic sampling, tone changes with damper pedal operation, and a subtle voicing at the release of the keys. It simulates the ultimate acoustic piano sound. It also reproduces a string resonance that is typical of acoustic pianos. This voice is suitable not only for classical music but for piano music of any genre.
GrandPiano2	○	○	×	×	×	A bright, expansive piano sound which is ideal for rock and popular genres.
E.Piano1	○	○	○	×	×	An electronic piano sound created by FM synthesis. Extremely "musical" response with varying timbre according to keyboard dynamics.
E.Piano2	×	○	○	○	×	The sound of an electric piano using hammer-struck metallic "tines." Soft tone when played lightly, and an aggressive tone when played hard.
SynthPiano	×	○	×	×	×	This voice simulates the electric piano sound produced by synthesizers in popular music. It also goes well with the acoustic piano sound.
WoodBass	○	○	○	○	×	This voice simulates the sound of an upright bass played with the fingers, and is suitable for jazz and Latin music. Stereo sampling has improved the acoustic feel.
ElectricBass	×	○	○	×	×	Electric bass for a wide range of music styles, jazz, rock, popular, and more.
Bass&Cymbal	○	○	○	×	×	WoodBass sound and stereo-sampled cymbal sound are layered. This voice is very effective for a jazz walking bass.
Harpsichord8'	○	×	×	○	×	The harpsichord is often used for Baroque music. The volume level is always consistent regardless of how you play. The instrument generates a peculiar voice when you release the keys. "8'" means that it produces the same octave sound as the keys.
Harpsichord8'+4'	○	×	×	○	×	This voice combines the 8' and 4' harpsichord sounds. "4'" means that it produces a sound one octave higher than the actual keys.
ElectricClavichord	×	○	×	○	×	This is the voice of a keyboard that produces sound by striking the strings with magnetic pickups. This funky sound is popular in black contemporary music. Because of its unique structure, the instrument produces a peculiar sound when you release the keys.
Vibraphone	○	○	○	×	×	This voice simulates a vibraphone played with a soft mallet. The harder you play, the more metallic it sounds. Use the "VibraphonePedalMode" parameter in the "OTHER SETTING" menu to select whether the sound sustains while you hold down the keys, or the sound sustains only when you press the pedal. An actual vibraphone has a rotor inside the resonance tube, which rotates via the motor to create the vibrato effect. Pressing the left pedal applies this effect; pressing the pedal again turns the effect off.

Preset Voice List

Voice name	Stereo sampling	Touch Sense	Dynamic sampling	Key-off samples	String resonance	Voice description
Marimba	○	○	○	×	×	This voice simulates a concert-type marimba sound. Stereo sampling helps reproduce a real acoustic spread.
Celesta	○	○	○	×	×	A celesta is a percussive instrument. When you play the keyboard, the hammer hits a metallic board to produce the sound. This instrument is famous for the impressive sound in "Dance of the Sugar-Plum Fairy" of The Nutcracker Suite by Tchaikovsky.
PipeOrganPrincipal	○	×	×	×	×	This voice features the combination of pipes (8'+4'+2') of a principal (brass instrument) organ. It is suitable for Baroque church music.
PipeOrganFlute1	○	×	×	×	×	This voice features the combination of pipes (8'+4') of a flute (woodwind instrument) organ. Its soft sound is suitable for the accompaniment of hymns.
PipeOrganFlute2	○	×	×	×	×	This voice features the combination of pipes (8'+4'+1 1/3') of a flute organ. It sounds more brilliant than PipeOrganFlute1 and is suitable for solo performance.
PipeOrganTutti	○	×	×	×	×	This voice features a full coupler of a pipe organ, famous for the sound used in Toccata and Fugue by Bach.
JazzOrgan	×	×	×	×	×	The sound of a "tonewheel" type electric organ. Often heard in jazz and rock idioms.
Strings	○	○	×	×	×	This voice features a string ensemble that accurately simulates all string instruments, including contrabass, cello, viola, and violin.
SynthStrings	○	○	×	×	×	Sampled strings, processed for spread and warmth. This voice is suitable for a pad in ensemble music.
SlowStrings	○	○	×	×	×	This voice features a string ensemble sound with a slow attack. It is suitable for a duet with piano or electric piano.
Choir	○	○	×	×	×	A big, spacious choir voice. Perfect for creating rich harmonies in slow pieces.
SlowChoir	○	○	×	×	×	This voice features a chorus sound with a slow attack. It is suitable for a duet with piano or electric piano.
Scat	○	○	○	×	×	You can enjoy jazz "scatting" with this voice. Depending on how hard and what note range you play, different sounds will be produced.

Voice Combination Examples (Dual and Split)

Dual

MAIN + MAIN	GrandPiano1 + E.Piano1 GrandPiano1 + E.Piano2	This combination is often used in popular music.
MAIN + MAIN	GrandPiano1 + SynthPiano	This produces a fantasy, spacious piano sound.
MAIN + MAIN	GrandPiano2 + GrandPiano2	This combination sounds as if you are playing two notes that are two octaves apart. It is suitable for the accompaniment of Salsa music.
MAIN + MAIN	E.Piano1 + SlowChoir	This is suitable for romantic ballads.
MAIN + MAIN	E.Piano2 + ElectricClavichord	This is suitable for funk, rhythm & blues, and soul music.
MAIN + MAIN	Harpsichord8' + Strings	This combination is very suitable for Baroque music.
MAIN + MAIN	Celesta + SynthStirngs	This combination adds strings and bell sound. A delay effect is automatically applied.

Split

MAIN / LEFT	GrandPiano1 / WoodBass or Bass&Cymbal	This is recommended for light Jazz music. The damper pedal is effective on the voice assigned to the right-hand range.
MAIN / LEFT	Celesta / Choir	This is suitable for a peaceful, somewhat cute song.
MAIN / LEFT	Choir / GrandPiano1	Play these voices elegantly along with piano arpeggio. Playing the Choir voice in chords would be more effective.
MAIN / LEFT	Scat / WoodBass	This combination features a cool (stylish) jazz chorus. The Scat voice is touch sensitive, adding a variety of expressions.
MAIN / LEFT	E.Piano2 / Scat	Playing the Scat voice for a bass part may create an interesting sound.

Dual + Split

MAIN + MAIN / LEFT	GrandPiano1 + SynthString / GrandPiano1	This combination creates the thick sound of a layered piano and strings.
MAIN + MAIN / LEFT	GrandPiano2 + E.Piano1 / ElectricBass	This sound is suitable for fusion. Deeper reverb and chorus (pages 79 and 80) will improve the groove. The damper pedal is effective on the voice assigned to the right-hand range.
MAIN + MAIN / LEFT + LEFT	Harpsichord8' + 4' + Strings / Harpsichord8' + Strings	This combination makes a very brilliant sound.

CLP-970/970M/970C: Keyboard Stand Assembly

CAUTION

- Be careful not to confuse parts, and be sure to install all parts in the correct direction. Please assemble in accordance with the sequence given below.
- Assembly should be carried out by at least two persons.
- Be sure to use the correct screw size, as indicated below. Use of incorrect screws can cause damage.
- Be sure to tighten up all screws upon completing assembly of each unit.
- To disassemble, reverse the assembly sequence given below.

Have a Phillips-head (+) screwdriver ready.

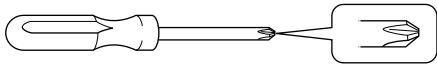

The parts shown in the "Assembly Parts" illustration will be used. Follow the assembly instructions and select the parts as needed.

Assembly Parts

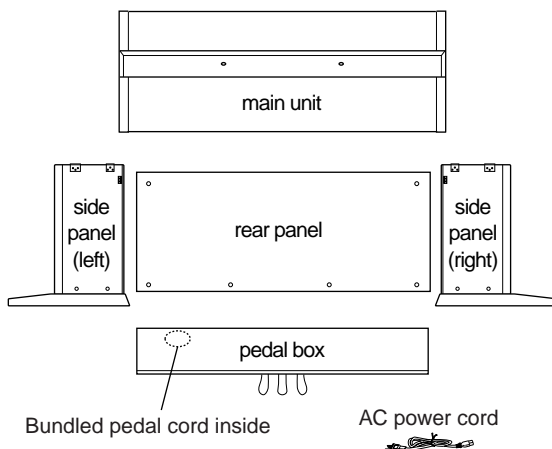
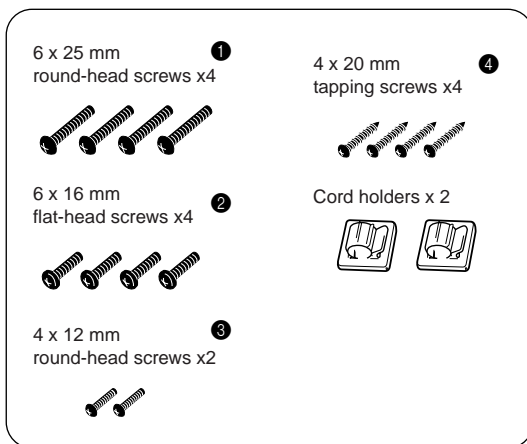

- 1. Attach the side panels to the pedal box.** Place the plastic bag that contained the side panels on the floor when assembling the stand to prevent scratches to the floor or stand.

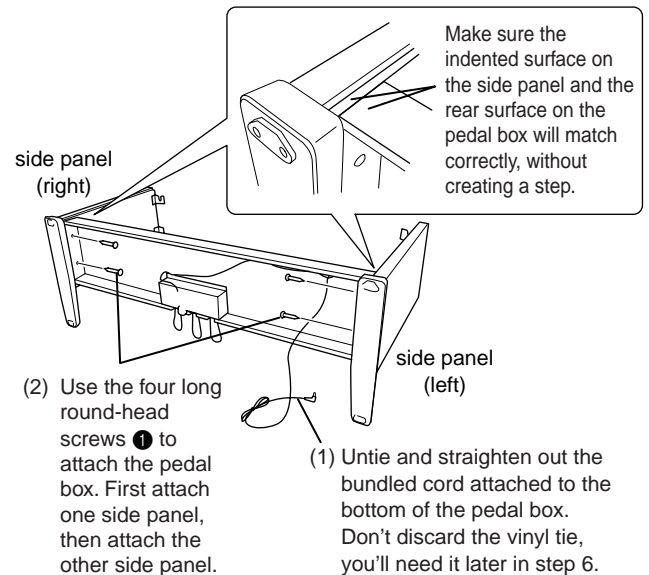

- 2. Attach the rear panel.**

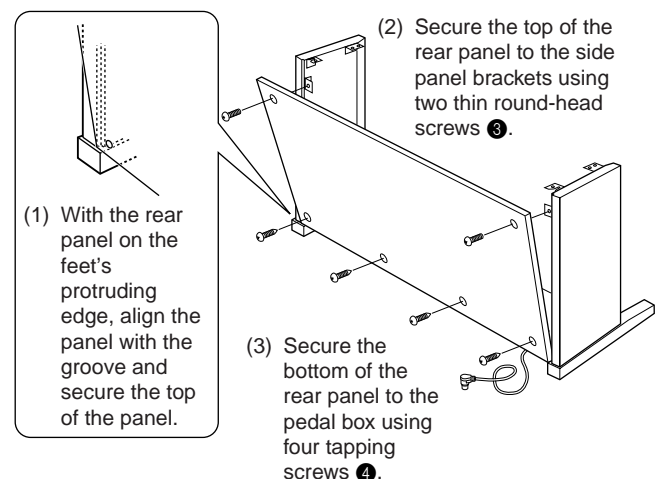

3. Mount the main unit.

⚠ CAUTION

- Fingers can become pinched between the main unit and the rear or side panels, be extra careful so as not to drop the main unit.
- Do not hold the keyboard in any position other than the position shown in the above illustration.

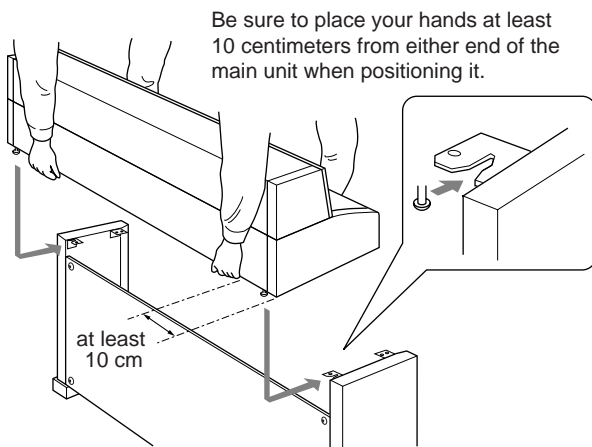

4. Fix the main unit.

- (1) Center the main unit to produce equal clearance on the left and right sides.

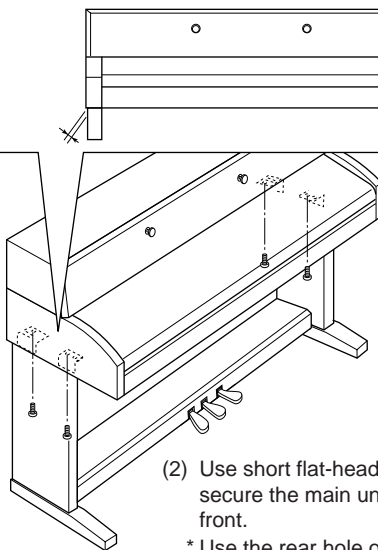

- (2) Use short flat-head screws ② to secure the main unit from the front.

* Use the rear hole on the front brackets to attach the screws.

5. Connect the pedal cord.

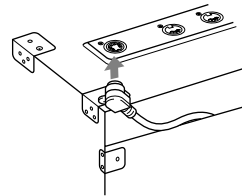

- (1) Pass the pedal cord plug from the rear as shown, and insert the plug into the PEDAL jack.

6. Secure the pedal cord.

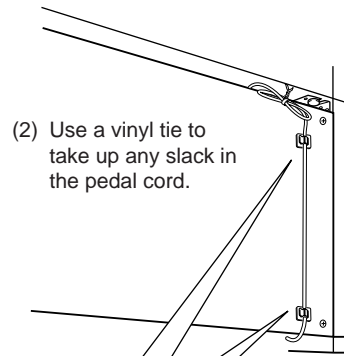

- (2) Use a vinyl tie to take up any slack in the pedal cord.

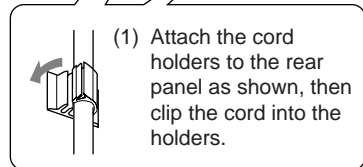

- (1) Attach the cord holders to the rear panel as shown, then clip the cord into the holders.

7. Set the voltage selector and connect the power cord.

Voltage Selector

Before connecting the AC power cord, check the setting of the voltage selector which is provided in some areas. To set the selector for 110V, 127V, 220V or 240V main voltages, use a “minus” screwdriver to rotate the selector dial so that the correct voltage for your region appears next to the pointer on the panel. The voltage selector is set at 240V when the unit is initially shipped.

After the proper voltage has been selected, connect the AC power cord to the AC INLET and an AC wall outlet. A plug adaptor may be also provided in some areas to match the pin configuration of the AC wall outlets in your area.

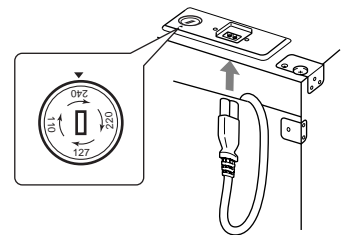

⚠ CAUTION

- An improper voltage setting can cause serious damage to the Clavinova or result in improper operation.

8. Set the adjuster.

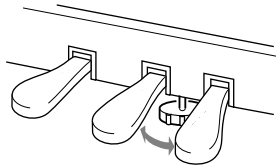

Rotate the adjuster until it comes in firm contact with the floor surface.

After completing the assembly, please check the following.

- **Are there any parts left over?**
 - Review the assembly procedure and correct any errors.
- **Is the Clavinova clear of doors and other movable fixtures?**
 - Move the Clavinova to an appropriate location.
- **Does the Clavinova make a rattling noise when you shake it?**
 - Tighten all screws.
- **Does the pedal box rattle or give way when you step on the pedals?**
 - Turn the adjuster so that it is set firmly against the floor.
- **Are the pedal and power cords inserted securely into the sockets?**
 - Check the connection.
- **If the main unit creaks or is otherwise unsteady when you play on the keyboard, refer to the assembly diagrams and retighten all screws.**

When moving the instrument after assembly, always hold the bottom of the main unit. Do not hold the keyboard cover or speaker box. Improper handling can result in damage to the instrument or personal injury.

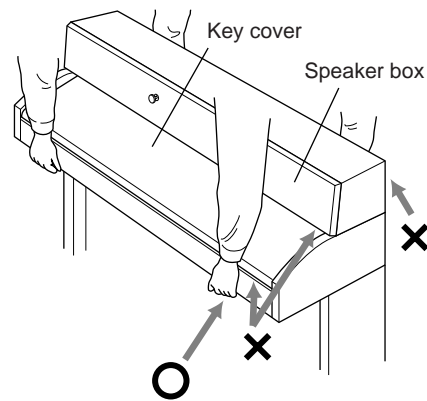

Index

You can search the desired section using not only the terminology in this manual but also commonly-used words. The * mark indicates that the corresponding page includes the terminology explanation in the right column.

Numerics

- 50 greats for the Clavinova 15
- 50 Piano Preset Songs 26
 - Practicing a one-hand part 28

A

- Adding reverberation to the sound
 - REVERB 33
- Adding variation to the sound
 - Effect function 32
- Assembly 106
- Assigning the START/PAUSE function to a pedal 89
- AUX IN jacks 62
- AUX OUT jacks 61
- AUX PEDAL jacks 62
- Auxiliary pedal function 82

B

- BackUp 91
- Bench 15
- BRILLIANCE 32

C

- Center pedal 31
- Center pedal function 82
- Character Code 56
- Characters 56
- CHORUS 33
- combining two voices
 - Dual mode 35
- computer 63
- Connection
 - Audio 61
 - MIDI 66
 - Other Components 61
 - Serial 64
 - Speaker 62
 - USB 67
- Connectors
 - MIDI IN/OUT/THRU 63, 66
- CONTRAST 20

D

- Damper (right) pedal 31
- Data Compatibility 101
- Data type 59
- Default (Normal) setting* 32
- Demonstration tunes 24
- Detailed Settings 70
 - Metronome 77
 - MIDI 83
 - Other settings 87
 - recording and playback 74
 - voices 78
- Disk
 - Copy 55
 - Format 56
- Disk song 50
- Display contrast 20
- DOWN (TEMPO)
 - 50 Piano Preset Songs 27
 - metronome 40
- Dual
 - Detailed settings 78
 - Recording 49
- Dual mode
 - combining two voices 35

E

- Effect function 32
- EXIT 23
- EXTRA TRACKS
 - the third or more tracks 46

F

- FactorySet 91
- Fast forward 27, 58
- FILE 50
- Floppy Disk 13, 14
- Formatting a floppy disk 56

H

- Headphones 20
- HOST SELECT switch 62

J

- Jacks
 - AUX IN 62
 - AUX OUT 61
 - AUX PEDAL 62
 - PEDAL 63
 - PHONES 20
 - TO HOST 62, 64

L

- LCD → Screen 23
 - Contrast 20
- Left pedal 31
- Left pedal function 82
- LEFT voice group buttons 37
- List
 - Demonstration tunes 24
 - Detailed Settings 70
 - Message 92
 - Preset Voice 103

M

- MAIN voice group buttons 30
 - Maintenance 14
 - MASTER VOLUME 20
 - Memory 50
 - Memory song 50
 - MemoryBackUp 91
 - Message List 92
 - Metronome 40
 - Detailed settings 77
 - METRONOME SETTING 77
 - MIDI 83
 - Detailed settings 83
 - MIDI cables 66
 - MIDI connectors 63, 66
 - MIDI driver 64
 - MIDI SETTING 83
 - Music Data 57
 - Music stand 18
-
- New Song 41
 - Normal setting* 32

O

Other settings 87

P

Pedal Function

- Auxiliary 82
- Center 82
- Left 82
- Right 81

PEDAL jack 63

Pedals 31

Personal computer 63

PHONES jacks 20

Playback

- 50 Piano Preset Songs 26
- Demo Songs 24
- Recorded Songs and Music Data 58

Playing back repeatedly (song) 76

Playing back repeatedly
(specifying the range) 75

playing two voices → Split mode 37

POWER 19

Practicing a one-hand part
(50 preset songs) 28

PRECAUTIONS 3

Preset song memory 50

Preset Voice List 103

R

Recording

- Tape Recorder 61
- Recording in Dual 49
- Recording in Split 49
- Recording Your Performance 41

Re-recording 43

REVERB 33

Rewind 27, 58

Right pedal 31

Right pedal function 81

S

Scale 88

Screen 23

Select

- 50 piano preset songs 26
- Demo Songs 24
- Recorded Songs and Music Data 57

Selecting a touch response 87

SETTING

- metronome 77
- Volume 20

SMF (Standard MIDI File) 101

Soft (left) pedal 31

Song

- Data Type 59
- Delete 53
- Detailed settings 74
- Playing back repeatedly 76
- Rename 54
- Store 50
- Store (Floopy disk) 53
- Store (Storage memory) 53

SONG BALANCE 48

SONG SELECT

- 50 Piano Preset Songs 26
- Recorded Songs and Music Data 57
- Recording 41

SONG SETTING 74

Sostenuto (center) pedal 31

Sound

- brilliance 32
- expression 32
- reverberation 33
- spread and spaciousness 33

Soundboard reverb 33

Split

- Detailed settings 78
- Recording 49

Split mode → playing two voices 37

Split point 38

Splitting the keyboard range and
playing two different voices 37

START/PAUSE

- 50 Piano Preset Songs 26
- Recorded Songs and Music Data 58
- Recording 42

START/STOP

- metronome 40

STOP

- 50 Piano Preset Songs 27
- Recorded Songs and Music Data 58
- Recording 42

Storage memory 50

StringResonance 88

SustainSampling 88

Synchro Start

- 50 preset songs 28
- Recorded Songs and Music Data 58

T

TEMPO

- 50 Piano Preset Songs 27
- metronome 40
- Recorded Songs and Music Data 58

the third or more tracks
→ EXTRA TRACKS 46

TO HOST jack 62, 64

TouchResponse 87

Track playback on and off 59

TRACK1/TRACK2

- 50 Piano Preset Songs 28
- Recording 41, 45

TRANSPOSE 34

Transposition 34

Troubleshooting 100

Tune 87

Type of characters 56

Type of data (recorded) 97

U

UP (TEMPO)

- 50 Piano Preset Songs 27
- metronome 40

V

VOICE SETTING 78

Voices 30
Detailed settings 78

Volume

- Balance (SONG BALANCE) 48
- Setting 20

X

XG 102

IMPORTANT SAFETY INSTRUCTIONS

INFORMATION RELATING TO PERSONAL INJURY, ELECTRICAL SHOCK, AND FIRE HAZARD POSSIBILITIES HAS BEEN INCLUDED IN THIS LIST.

WARNING- When using any electrical or electronic product, basic precautions should always be followed. These precautions include, but are not limited to, the following:

- 1.** Read all Safety Instructions, Installation Instructions, Special Message Section items, and any Assembly Instructions found in this manual **BEFORE** making any connections, including connection to the main supply.
- 2.** Main Power Supply Verification: Yamaha products are manufactured specifically for the supply voltage in the area where they are to be sold. If you should move, or if any doubt exists about the supply voltage in your area, please contact your dealer for supply voltage verification and (if applicable) instructions. The required supply voltage is printed on the name plate. For name plate location, please refer to the graphic found in the Special Message Section of this manual.
- 3.** This product may be equipped with a polarized plug (one blade wider than the other). If you are unable to insert the plug into the outlet, turn the plug over and try again. If the problem persists, contact an electrician to have the obsolete outlet replaced. Do **NOT** defeat the safety purpose of the plug.
- 4.** Some electronic products utilize external power supplies or adapters. Do **NOT** connect this type of product to any power supply or adapter other than one described in the owners manual, on the name plate, or specifically recommended by Yamaha.
- 5.** **WARNING:** Do not place this product or any other objects on the power cord or place it in a position where anyone could walk on, trip over, or roll anything over power or connecting cords of any kind. The use of an extension cord is not recommended! If you must use an extension cord, the minimum wire size for a 25' cord (or less) is 18 AWG. **NOTE:** The smaller the AWG number, the larger the current handling capacity. For longer extension cords, consult a local electrician.
- 6.** Ventilation: Electronic products, unless specifically designed for enclosed installations, should be placed in locations that do not interfere with proper ventilation. If instructions for enclosed installations are not provided, it must be assumed that unobstructed ventilation is required.
- 7.** Temperature considerations: Electronic products should be installed in locations that do not significantly contribute to their operating temperature. Placement of this product close to heat sources such as; radiators, heat registers and other devices that produce heat should be avoided.
- 8.** This product was **NOT** designed for use in wet/damp locations and should not be used near water or exposed to rain. Examples of wet/damp locations are; near a swimming pool, spa, tub, sink, or wet basement.
- 9.** This product should be used only with the components supplied or; a cart, rack, or stand that is recommended by the manufacturer. If a cart, rack, or stand is used, please observe all safety markings and instructions that accompany the accessory product.
- 10.** The power supply cord (plug) should be disconnected from the outlet when electronic products are to be left unused for extended periods of time. Cords should also be disconnected when there is a high probability of lightning and/or electrical storm activity.
- 11.** Care should be taken that objects do not fall and liquids are not spilled into the enclosure through any openings that may exist.
- 12.** Electrical/electronic products should be serviced by a qualified service person when:
 - a. The power supply cord has been damaged; or
 - b. Objects have fallen, been inserted, or liquids have been spilled into the enclosure through openings; or
 - c. The product has been exposed to rain; or
 - d. The product does not operate, exhibits a marked change in performance; or
 - e. The product has been dropped, or the enclosure of the product has been damaged.
- 13.** Do not attempt to service this product beyond that described in the user-maintenance instructions. All other servicing should be referred to qualified service personnel.
- 14.** This product, either alone or in combination with an amplifier and headphones or speaker/s, may be capable of producing sound levels that could cause permanent hearing loss. **DO NOT** operate for a long period of time at a high volume level or at a level that is uncomfortable. If you experience any hearing loss or ringing in the ears, you should consult an audiologist. **IMPORTANT:** The louder the sound, the shorter the time period before damage occurs.
- 15.** Some Yamaha products may have benches and/or accessory mounting fixtures that are either supplied as a part of the product or as optional accessories. Some of these items are designed to be dealer assembled or installed. Please make sure that benches are stable and any optional fixtures (where applicable) are well secured **BEFORE** using. Benches supplied by Yamaha are designed for seating only. No other uses are recommended.

PLEASE KEEP THIS MANUAL

FCC INFORMATION (U.S.A.)

1. **IMPORTANT NOTICE: DO NOT MODIFY THIS UNIT!**

This product, when installed as indicated in the instructions contained in this manual, meets FCC requirements. Modifications not expressly approved by Yamaha may void your authority, granted by the FCC, to use the product.

2. **IMPORTANT:** When connecting this product to accessories and/or another product use only high quality shielded cables. Cable/s supplied with this product **MUST** be used. Follow all installation instructions. Failure to follow instructions could void your FCC authorization to use this product in the USA.
3. **NOTE:** This product has been tested and found to comply with the requirements listed in FCC Regulations, Part 15 for Class "B" digital devices. Compliance with these requirements provides a reasonable level of assurance that your use of this product in a residential environment will not result in harmful interference with other electronic devices. This equipment generates/uses radio frequencies and, if not installed and used according to the instructions found in the users manual, may cause interference harmful to the operation of

other electronic devices. Compliance with FCC regulations does not guarantee that interference will not occur in all installations. If this product is found to be the source of interference, which can be determined by turning the unit "OFF" and "ON", please try to eliminate the problem by using one of the following measures:

Relocate either this product or the device that is being affected by the interference.

Utilize power outlets that are on different branch (circuit breaker or fuse) circuits or install AC line filter/s.

In the case of radio or TV interference, relocate/reorient the antenna. If the antenna lead-in is 300 ohm ribbon lead, change the lead-in to co-axial type cable.

If these corrective measures do not produce satisfactory results, please contact the local retailer authorized to distribute this type of product. If you can not locate the appropriate retailer, please contact Yamaha Corporation of America, Electronic Service Division, 6600 Orangethorpe Ave, Buena Park, CA90620

The above statements apply **ONLY** to those products distributed by Yamaha Corporation of America or its subsidiaries.

* This applies only to products distributed by YAMAHA CORPORATION OF AMERICA.

(class B)

IMPORTANT NOTICE FOR THE UNITED KINGDOM

Connecting the Plug and Cord

IMPORTANT. The wires in this mains lead are coloured in accordance with the following code:

BLUE : NEUTRAL
BROWN : LIVE

As the colours of the wires in the mains lead of this apparatus may not correspond with the coloured markings identifying the terminals in your plug proceed as follows:

The wire which is coloured BLUE must be connected to the terminal which is marked with the letter N or coloured BLACK.

The wire which is coloured BROWN must be connected to the terminal which is marked with the letter L or coloured RED.

Making sure that neither core is connected to the earth terminal of the three pin plug.

(2 wires)

- This applies only to products distributed by Yamaha-Kemble Music (U.K.) Ltd.

CAUTION: TO PREVENT ELECTRIC SHOCK, MATCH WIDE BLADE OF PLUG TO WIDE SLOT, FULLY INSERT.

ATTENTION: POUR ÉVITER LES CHOCS ÉLECTRIQUES, INTRODUIRE LA LAME LA PLUS LARGE DE LA FICHE DANS LA BORNE CORRESPONDANTE DE LA PRISE ET POUSSER JUSQU' AU FOND.

(polarity)

- This applies only to products distributed by Yamaha Canada Music Ltd.
- Ceci ne s'applique qu'aux produits distribués par Yamaha Canada Musique Ltée.

For details of products, please contact your nearest Yamaha or the authorized distributor listed below.

Pour plus de détails sur les produits, veuillez-vous adresser à Yamaha ou au distributeur le plus proche de vous figurant dans la liste suivante.

Die Einzelheiten zu Produkten sind bei Ihrer unten aufgeführten Niederlassung und bei Yamaha Vertragshändlern in den jeweiligen Bestimmungsländern erhältlich.

Para detalles sobre productos, contacte su tienda Yamaha más cercana o el distribuidor autorizado que se lista debajo.

NORTH AMERICA

CANADA

Yamaha Canada Music Ltd.
135 Milner Avenue, Scarborough, Ontario,
M1S 3R1, Canada
Tel: 416-298-1311

U.S.A.

**Yamaha Corporation of America,
Keyboard Division**
6600 Orangethorpe Ave., Buena Park, Calif. 90620,
U.S.A.
Tel: 714-522-9011

CENTRAL & SOUTH AMERICA

MEXICO

**Yamaha de Mexico S.A. De C.V.,
Departamento de ventas**
Javier Rojo Gomez No.1149, Col. Gpe Del
Moral, Deleg. Iztapalapa, 09300 Mexico, D.F.
Tel: 686-00-33

BRAZIL

Yamaha Musical do Brasil LTDA.
Av. Rebouças 2636, São Paulo, Brasil
Tel: 011-853-1377

ARGENTINA

Yamaha Music Argentina S.A.
Viamonte 1145 Piso2-B 1053,
Buenos Aires, Argentina
Tel: 1-4371-7021

PANAMA AND OTHER LATIN AMERICAN COUNTRIES/ CARIBBEAN COUNTRIES

Yamaha de Panama S.A.
Torre Banco General, Piso 7, Urbanización Marbella,
Calle 47 y Aquilino de la Guardia,
Ciudad de Panamá, Panamá
Tel: 507-269-5311

EUROPE

THE UNITED KINGDOM

Yamaha-Kemble Music (U.K.) Ltd.
Sherbourne Drive, Tilbrook, Milton Keynes,
MK7 8BL, England
Tel: 01908-366700

IRELAND

Danfay Ltd.
61D, Sallynoggin Road, Dun Laoghaire, Co. Dublin
Tel: 01-2859177

GERMANY/SWITZERLAND

Yamaha Europa GmbH.
Siemensstraße 22-34, 25462 Rellingen,
F.R. of Germany
Tel: 04101-3030

AUSTRIA

Yamaha Music Austria
Schleiergasse 20, A-1100 Wien Austria
Tel: 01-60203900

THE NETHERLANDS

Yamaha Music Nederland
Kanaalweg 18G, 3526KL, Utrecht, The Netherlands
Tel: 030-2828411

BELGIUM

Yamaha Music Belgium
Keiberg Imperiastraat 8, 1930 Zaventem, Belgium
Tel: 02-7258220

FRANCE

**Yamaha Musique France,
Division Claviers**
BP 70-77312 Marne-la-Vallée Cedex 2, France
Tel: 01-64-61-4000

ITALY

**Yamaha Musica Italia S.P.A.,
Home Keyboard Division**
Viale Italia 88, 20020 Lainate (Milano), Italy
Tel: 02-935-771

SPAIN/PORTUGAL

Yamaha-Hazen Electronica Musical, S.A.
Ctra. de la Coruna km. 17, 200, 28230
Las Rozas (Madrid) Spain
Tel: 91-201-0700

GREECE

Philippe Nakas S.A.
Navarinou Street 13, P.Code 10680, Athens, Greece
Tel: 01-364-7111

SWEDEN

Yamaha Scandinavia AB
J. A. Wettergrens Gata 1
Box 30053
S-400 43 Göteborg, Sweden
Tel: 031 89 34 00

DENMARK

YS Copenhagen Liaison Office
Generatorvej 8B
DK-2730 Herlev, Denmark
Tel: 44 92 49 00

FINLAND

F-Musiikki Oy
Kluuvikatu 6, P.O. Box 260,
SF-00101 Helsinki, Finland
Tel: 09 618511

NORWAY

Norsk filial av Yamaha Scandinavia AB
Grini Næringspark 1
N-1345 Østerås, Norway
Tel: 67 16 77 70

ICELAND

Skifan HF
Skeifan 17 P.O. Box 8120
IS-128 Reykjavik, Iceland
Tel: 525 5000

OTHER EUROPEAN COUNTRIES

Yamaha Europa GmbH.
Siemensstraße 22-34, 25462 Rellingen,
F.R. of Germany
Tel: 04101-3030

AFRICA

**Yamaha Corporation,
Asia-Pacific Music Marketing Group**
Nakazawa-cho 10-1, Hamamatsu, Japan 430-8650
Tel: 053-460-2312

MIDDLE EAST

TURKEY/CYPRUS

Yamaha Europa GmbH.
Siemensstraße 22-34, 25462 Rellingen,
F.R. of Germany
Tel: 04101-3030

OTHER COUNTRIES

Yamaha Music Gulf FZE
LB21-128 Jebel Ali Freezone
P.O.Box 17328, Dubai, U.A.E.
Tel: 971-4-881-5868

ASIA

HONG KONG

Tom Lee Music Co., Ltd.
11/F, Silvercord Tower 1, 30 Canton Road,
Tsimshatsui, Kowloon, Hong Kong
Tel: 2737-7688

INDONESIA

**PT. Yamaha Music Indonesia (Distributor)
PT. Nusantik**
Gedung Yamaha Music Center, Jalan Jend. Gatot
Subroto Kav. 4, Jakarta 12930, Indonesia
Tel: 21-520-2577

KOREA

Cosmos Corporation
1461-9, Seocho Dong, Seocho Gu, Seoul, Korea
Tel: 02-3486-0011

MALAYSIA

Yamaha Music Malaysia, Sdn., Bhd.
Lot 8, Jalan Perbandaran, 47301 Kelana Jaya,
Petaling Jaya, Selangor, Malaysia
Tel: 3-703-0900

PHILIPPINES

Yupango Music Corporation
339 Gil J. Puyat Avenue, P.O. Box 885 MCPO,
Makati, Metro Manila, Philippines
Tel: 819-7551

SINGAPORE

Yamaha Music Asia Pte., Ltd.
11 Ubi Road #06-00, Meiban Industrial Building,
Singapore
Tel: 65-747-4374

TAIWAN

Yamaha KHS Music Co., Ltd.
10F, 150, Tun-Hwa Northroad,
Taipei, Taiwan, R.O.C.
Tel: 02-2713-8999

THAILAND

Siam Music Yamaha Co., Ltd.
121/60-61 RS Tower 17th Floor,
Ratchadaphisek RD., Dindaeng,
Bangkok 10320, Thailand
Tel: 02-641-2951

THE PEOPLE'S REPUBLIC OF CHINA AND OTHER ASIAN COUNTRIES

**Yamaha Corporation,
Asia-Pacific Music Marketing Group**
Nakazawa-cho 10-1, Hamamatsu, Japan 430-8650
Tel: 053-460-2317

OCEANIA

AUSTRALIA

Yamaha Music Australia Pty. Ltd.
Level 1, 99 Queensbridge Street, Southbank, Victoria
3006, Australia
Tel: 3-9693-5111

NEW ZEALAND

Music Houses of N.Z. Ltd.
146/148 Captain Springs Road, Te Papapa,
Auckland, New Zealand
Tel: 9-634-0099

COUNTRIES AND TRUST TERRITORIES IN PACIFIC OCEAN

**Yamaha Corporation,
Asia-Pacific Music Marketing Group**
Nakazawa-cho 10-1, Hamamatsu, Japan 430-8650
Tel: 053-460-2312

HEAD OFFICE Yamaha Corporation, Pro Audio & Digital Musical Instrument Division
Nakazawa-cho 10-1, Hamamatsu, Japan 430-8650
Tel: 053-460-3273

