



MUSIC SEQUENCER

Data List

CONTENTS

XG Normal Voice List	2
XG Drum Voice List	4
Effect Type List	10
Effect Parameter List	11
Data/Value Tables	14
Preset Style List	15
Preset Phrase List	16
Fingered Chord List	35
Chord Type List	36
Chord Template List	38
Drum Table	40
Amp Simulator List	41
MIDI Data Format	42
MIDI Implementation Chart	68

XG Normal Voice List

Bank Select MSB=000, LSB=Bank Number

* A "+" is displayed to the right of the program number except for when Bank Number = 0(G/M)

Category	Program #	Bank #	Voice Name	Element	
P1 (Piano)	1	0	GrandPno	1	
			GrndPnoK	1	
		18	MelloGrP	2	
		40	PianoStr	2	
		41	Dream	2	
		2	0	BritePno	1
			1	BritPnoK	1
		3	0	El.Grand	2
			1	ElGrPnoK	2
		32	Det.CP80	2	
		40	LayerCP1	2	
		41	LayerCP2	2	
		4	0	HnkyTonk	2
			1	HnkyTrnk	2
		5	0	E.PIano1	2
			1	EL.PIanoK	2
		18	MelloEP1	2	
		32	Chor.EP1	2	
		40	HardEL.P	2	
		45	VX_EL.P1	2	
		64	60sEL.P	1	
		6	0	E.PIano2	2
			1	El.Pno2K	2
		32	Chor.EP2	2	
		33	DX_Hard	2	
	34	DX.Legend	2		
	40	DX.Phase	2		
	41	DX_Analg	2		
	42	DX.KoteEP	2		
	46	VX_EL.P2	2		
	7	0	Harpsi.	1	
		1	Harpsi.K	1	
	25	Harpsi.2	2		
	35	Harpsi.3	2		
	8	0	Clavi	1	
		1	Clavi K	1	
	27	ClavWah	2		
	64	PulseClv	1		
	65	PierceCl	2		
Cp (Chromatic)	9	0	Celesta	1	
	10	0	Glocken	1	
			1	Glocken	1
	11	0	MusicBox	2	
		64	Orgel	2	
	12	0	Vibes	1	
			1	Vibes K	1
		45	HardVibe	2	
	13	0	Marimba	1	
			1	MarimbaK	2
		64	SineMrmb	2	
		97	Balimba	2	
		98	Log Drum	2	
	14	0	Xylophon	1	
			1	Xylophon	1
	15	0	TubuBel	1	
			96	ChrchBel	2
97		Caillon	2		
16	0	Dulcimer	1		
		35	Dulcimer2	2	
		96	Cimbalom	2	
		97	Santur	2	
		97	Santur	2	

Category	Program #	Bank #	Voice Name	Element		
Or (Organ)	17	0	DrawOrgn	1		
		32	DelDrwOr	2		
		33	60sDrOr1	2		
		34	60sDrOr2	2		
		35	70sDrOr1	2		
		36	DrawOrg2	2		
		37	60sDrOr3	2		
		38	EverOrg	2		
		40	16+2/3	2		
		64	Organ Ba	1		
		65	70sDrOr2	2		
		66	CheezOrg	2		
		67	DrawOrg3	2		
		18	0	PercOrgn	1	
			24	70sPcOr1	2	
			33	DelPcOr	2	
			33	Lite Org	2	
			37	FrgOrg2	2	
		19	0	RockOrgn	1	
			64	RotaryOr	2	
			65	SlsRotar	2	
			66	FstRotar	2	
		20	0	ChrchOrg	2	
			32	ChurOrg3	2	
			35	ChurOrg2	2	
		40	NotreDam	2		
		64	OrgFlute	2		
		65	TrrmOrgFl	2		
	21	0	ReedOrgn	1		
		30	Puff Org	2		
	22	0	Acordion	1		
		32	Accordtt	2		
	23	0	Harmnica	1		
		32	Harmo	2		
	24	0	TangoAcD	1		
		64	TngoAcD2	2		
Gt (Guitar)	25	0	NylonGtr	1		
		16	NylonGt2	1		
		25	NylonGt3	2		
		42	VelGtHrm	2		
		96	Ukulele	1		
	26	0	SteelGtr	1		
			16	SteelG2	1	
			35	12StrGtr	2	
			40	NyIn&Stl	2	
			41	Sl&Body	2	
			96	Mandolin	2	
		27	0	Jazz Gtr	1	
				18	MelloGtr	1
				32	JazzAmp	2
				96	PdStrum	2
			28	0	CleanGtr	1
					32	ChorusGt
				65	MidT_Gtr	1
		66		MidTcGt	2	
		66		Mute_Gtr	2	
		113		Oct_Bass	1	
	29	0	FunkGtr1	1		
		41	MuteSIG	2		
		40	FunkGtr2	2		
		45	Jazz Man	2		
		96	Mu.DstGt	2		
30		0	Ovrdrive	1		
			43	Gt_Pinch	1	
31	0	Dist.Gtr	1			
		12	DstrRthmG	2		
		24	DistGtr2	2		
		35	DistGtr3	2		
		36	PowerGt2	2		
		37	PowerGt1	2		
		38	Dst.Slts	2		
		40	FeedbkGt	2		
		41	FeedbkG2	2		
		43	RckRthm2	2		
		45	RckRthm1	2		
	32	0	GtrHarmo	1		
			65	GtFeedbk	1	
		66	GtrHrmo2	1		

Category	Program #	Bank #	Voice Name	Element		
Ba (Bass)	33	0	Acc.Bass	1		
			40	JazzRthm	2	
			45	VXJLight	2	
			34	0	FngBass	1
			18	FngDrk	2	
			27	FlangeBa	2	
			40	BaKDatEG	2	
			43	FngSlap	1	
			45	FngBass2	2	
			64	Jazzy Ba	1	
			65	Mod.Bass	2	
			112	FW EBass	1	
		35	0	PickBass	1	
				28	MutePcBa	1
			36	0	Fretless	1
				32	Fretless2	2
				33	Fretless3	2
		34		Fretless4	2	
		96	SynFretL	2		
		97	SmthFretL	2		
	37	0	SlapBas1	1		
			27	ResoSlap	2	
			32	PunchThm	2	
			64	Slapper	1	
			65	Thum&Stp	1	
	38	0	SlapBas2	1		
			43	VeloSlap	1	
	39	0	SynBass1	1		
			18	SynBassDK	1	
			20	FastRtsB	1	
			24	AcidBass	1	
			27	ResoBass	1	
			35	Cv Bass	2	
			40	TechnoBa	2	
			64	Orbiter	2	
			65	Sqr.Bass	1	
			66	RubberBa	2	
			67	Fish	1	
			68	HardReso	1	
			96	Hammer	2	
		112	AnlgBass	2		
		113	RezoBass	2		
	40	0	SynBass2	2		
			6	MelloSBa	1	
			12	Seq Bass	2	
		18	ClkSynBa	2		
		19	SynBa2DK	1		
		32	SmthSynB	2		
		40	ModulBa	2		
		41	DX Bass	2		
		64	X WireBa	2		
		65	AikPulse	1		
		66	CS Light	1		
		67	MelBass	1		
		112	SmoothB	2		
		113	Oct_Bass	1		
		114	PowerBas	4		
St (Strings)	41	0	Violin	1		
		8	Slow Vln	1		
		42	0	Viola	1	
		43	0	Cello	1	
		44	0	Contrabs	1	
	45	0	Trem.Str	1		
			8	SlwTrStr	1	
		40	Susp. Str	2		
	46	0	Pizz. Str	1		
	47	0	Harp	1		
	40	YangChin	2			
48	0	Timpani	1			

Category	Program #	Bank #	Voice Name	Element		
En (Ensemble)	49	0	Strings1	1		
			3	S.Strngs	2	
			8	Slw Str	1	
			24	AccStr	2	
			35	60sStrng	2	
			40	Orchstr	2	
			41	Orchstr2	2	
			42	TremOrch	2	
			45	Velo.Str	2	
		50	0	Strings2	1	
				3	S.SlwStr	2
				8	LegatoSt	2
				40	Warm Str	2
				41	Kingdom	2
				64	70s Str	2
	51	0	Strings3	1		
			0	Syn Str1	2	
			27	Reso Str	2	
			64	Syn Str4	2	
			65	Syn Str5	2	
	52	0	Syn Str2	2		
	53	0	ChoirAah	1		
			3	S.Choir	2	
			16	Ch.Aahs2	2	
			32	MelChoir	2	
		40	ChoirStr	2		
54	0	VoiceOoh	1			
55	0	SynVoice	1			
		40	SynVoice2	2		
		32	Choral	1		
		64	AnaVoice	1		
	56	0	Orch.Hit	2		
			35	OrchHit2	2	
			64	Impact	2	
			68	Bass Hit	1	
			70	6th Hit	1	
			71	6thHit +	2	
		72	Euro Hit	1		
	73	EuroHit+	2			
Br (Brass)	57	0	Trumpet	1		
			16	Trumpet2	1	
			17	BriteTtp	2	
		32	Warm Ttp	2		
	58	0	Trombone	1		
			18	Trrbone2	2	
	59	0	Tuba	1		
			16	Tuba 2	1	
	60	0	Mute Ttp	1		
	61	0	Fr.Horn	1		
			6	FrrHSolo	1	
		32	FrrHorn 2	2		
		32	HornOrch	2		
		37	HornOrch	2		
62	0	BrssSect	1			
		3	SBrssSect	2		
		35	Tpk&Ttp	2		
		40	SmrSsSect	2		
		41	Hi Brass	2		
		42	MelloBrS	2		
63	0	SynBrss1	2			
		12	Quack Br	2		
		20	RezSynBr	2		
		24	PolyBrss	2		
		27	SynBrss3	2		
		32	JumpBrss	2		
		40	SyBrssSub	2		
		45	AnVelBr1	2		
	64	AnaBrss1	2			
64	0	SynBrss2	1			
		18	Soft Brs	2		
		40	SynBrss4	2		
		41	ChoirBrS	2		
		45	AnVelBr2	2		
		64	AnaBrss2	2		

X G Normal Voice List

- Bank 0 : (GM)
 Bank 1 : Key Scale Panning
 Bank 3 : Stereo
 Bank 6 : Single
 Bank 8 : Slow
 Bank 12 : Fast Decay
 Bank 14 : Double Attack
 Bank 16 : Bright
 Bank 17 : Bright
 Bank 18 : Dark
 Bank 19 : Dark

- Bank 20 : Resonant
 Bank 24 : Attack
 Bank 25 : Release
 Bank 27 : Reso Sweep
 Bank 28 : Muted
 Bank 32 : Detune 1
 Bank 33 : Detune 2
 Bank 34 : Detune 3
 Bank 35 : Octave 1
 Bank 36 : Octave 2
 Bank 37 : 5th 1

- Bank 38 : 5th 2
 Bank 39 : Bend
 Bank 40 : Tutti
 Bank 41 : Tutti
 Bank 42 : Tutti
 Bank 43 : Velo-Switch
 Bank 45 : Velo-Xfade
 Bank 64 : Other wave
 Bank 65 : Other wave
 Bank 66 : Other wave
 Bank 67 : Other wave

- Bank 68 : Other wave
 Bank 69 : Other wave
 Bank 70 : Other wave
 Bank 71 : Other wave
 Bank 72 : Other wave
 Bank 95 : Other wave
 Bank 97 : Other wave
 Bank 98 : Other wave
 Bank 99 : Other wave
 Bank 100 : Other wave
 Bank 101 : Other wave

Bank Select MSB=064, LSB=000 SFX Voice (The category display is Sfx.)

Category	Program #	Bank #	Voice Name	Element	
Rd (Reed)	65	0	SprnoSax	1	
	66	0	Alto Sax	1	
	40	40	Sax Sect	2	
	43	43	HyrAlto	2	
	67	0	TenorSax	1	
	40	40	BrthTrnSx	2	
	41	41	SoftFnr	2	
	64	64	TrnSax 2	1	
	68	0	Bari.Sax	1	
	69	0	Oboe	1	
	70	0	Eng.Horn	1	
	71	0	Bassoon	1	
	72	0	Clarinet	1	
	73	0	Piccolo	1	
	PI (Pipe)	74	0	Flute	1
		75	0	Recorder	1
		76	0	PanFlute	1
		77	0	Bottle	2
		78	0	Shakchi	1
		79	0	Whistle	1
		80	0	Ocarina	1
Ld (Synth Lead)		81	0	SquareLd	2
		6	6	Square 2	1
		8	8	LMSquare	1
		18	18	Hollow	1
		19	19	Shroud	2
		64	64	Mellow	2
		65	65	SoloSine	2
		66	66	SineLead	2
	67	67	Pulse Ld	1	
	82	0	Saw Ld	2	
	6	6	Saw Ld 2	1	
	8	8	ThickSaw	1	
	18	18	Dyna Saw	1	
	19	19	Digi Saw	2	
	20	20	Big Lead	2	
	24	24	HeavySyn	2	
	25	25	WaspySyn	2	
	27	27	RezySaw	1	
	32	32	DoubiSaw	2	
	35	35	Toy Lead	2	
	36	36	Dim Saw	2	
	40	40	PulseSaw	2	
	41	41	Dr. Lead	2	
	45	45	VeloLead	2	
	64	64	Digger	1	
	96	96	Seq Ana.	2	
	83	0	CaliopLd	2	
	65	65	Pure Pad	2	
84	0	Chiff Ld	2		
64	64	Rubby	2		
65	65	HardSync	1		
85	0	CharanLd	2		
64	64	DisLead	2		
65	65	WireLead	2		
66	66	WiredLead	1		
86	0	Voices Ld	2		
24	24	SynthAah	2		
64	64	VoxLead	2		
87	0	Fifth Ld	2		
35	35	Big Five	2		
88	0	Bass&Ld	2		
16	16	Big&Low	2		
64	64	Fat&Prky	2		
65	65	Soft Wri	2		
Pd (Synth Pad)	89	0	NewAgePd	2	
	64	64	Fantasy	2	
	90	0	Warm Pad	2	
	16	16	ThickPad	2	
	17	17	Soft Pad	2	
	18	18	SinePad	2	
	64	64	Horn Pad	2	
	65	65	RotarStr	2	

Category	Program #	Bank #	Voice Name	Element
Pd (Synth Pad)	91	0	PolySynPd	2
	64	64	PolyPd90	2
	65	65	ClickPad	2
	66	66	Ana. Pad	2
	67	67	SuarPad	2
	92	0	ChoirPad	2
	64	64	Heaven	2
	66	66	Itopia	2
	67	67	CC Pad	2
	93	0	BowedPad	2
	64	64	Glacier	2
	65	65	GlassPad	2
	94	0	MetalPad	2
	64	64	Tine Pad	2
	65	65	Pan Pad	2
	95	0	Halo Pad	2
	96	0	RecorderPad	2
	20	20	Swimmer	2
27	27	Converge	2	
64	64	PolarPad	2	
66	66	Celstial	2	
Fx (Synth Effects)	97	0	Rain	2
	45	45	ClaviPd	2
	64	64	HrmoRain	2
	65	65	AFrcvWind	2
	66	66	Carib	2
	98	0	SoundTrk	2
	27	27	Prologue	2
	64	64	Anacastf	2
	99	0	Crystal	2
	12	12	SynDrCmp	2
	14	14	Popecm	2
	18	18	TinyBell	2
	35	35	RndGlock	2
	40	40	GlockChi	2
	41	41	ClearBell	2
	42	42	ChorBell	2
	64	64	SynMalet	1
	65	65	SitCryst	2
66	66	LoudGlock	2	
67	67	ChrsBell	2	
68	68	VibeBell	2	
69	69	DigiBell	2	
70	70	AirBells	2	
71	71	BellHarp	2	
72	72	Gamelmba	2	
100	0	Atmosphr	2	
18	18	WarmAtms	2	
19	19	HoliwRls	2	
40	40	Nylon EP	2	
64	64	NylnHarp	2	
65	65	Harp Vox	2	
66	66	AtmosPad	2	
67	67	Planet	2	
101	0	Bright	2	
64	64	FannedBel	2	
96	96	Smockey	2	
102	0	Goblins	2	
64	64	GobSynth	2	
65	65	Creeper	2	
66	66	Ring Pad	2	
67	67	Ritual	2	
68	68	ToHeaven	2	
70	70	Night	2	
71	71	Giisten	2	
96	96	BelChoir	2	
103	0	Echoes	2	
8	8	Echoes 2	2	
14	14	Echo Pan	2	
64	64	EchoBell	2	
65	65	Big Pan	2	
66	66	SynPiano	2	
67	67	Creation	2	
68	68	StarDust	2	
69	69	Reso&Pan	2	
104	0	Sci-Fi	2	
64	64	Starz	2	

Category	Program #	Bank #	Voice Name	Element
Et (Ethnic)	105	0	Sitar	1
	35	35	DevSitar	2
	36	36	Sitar 2	2
	96	96	Tambra	2
	97	97	Tamboura	2
	106	0	Banjo	1
	28	28	MuteBnio	1
	96	96	Rabab	2
	97	97	Gopichnt	2
	98	98	Oud	2
	107	0	Shamisen	1
	108	0	Koto	1
	96	96	Taisho- K	2
	97	97	Kanon	2
	109	0	Kalimba	1
	110	0	Biagiope	2
	16	16	80	80
	111	0	Fiddle	1
112	0	Shanai	1	
64	64	Shanai 2	1	
96	96	Pungi	1	
97	97	Hichnri	2	
Pc (Percussive)	113	0	TrikkBell	2
	96	96	Bonang	2
	97	97	Altair	2
	98	98	Gamelan	2
	99	99	S. Gamelan	2
	100	100	Rama Cym	2
	101	101	AsianBel	2
	28	28	92	92
	114	0	Agogo	1
	115	0	SteelDrum	1
	97	97	GlasPerc	2
	98	98	ThaiBell	2
	116	0	Woodblok	1
	96	96	Castanok	1
	117	0	TalkoDrum	1
	96	96	Gr.Cassa	1
	118	0	MelodTom	1
	64	64	Mei Tom2	1
65	65	Real Tom	2	
66	66	Rock Tom	2	
119	0	Syn Drum	1	
64	64	Ana Tom	1	
65	65	ElecPerc	2	
120	0	RevCymbal	1	
121	0	FretNoiz	1	
122	0	BrthNoiz	1	
123	0	Seashore	2	
124	0	Tweet	2	
49	49	Dog	1	
50	50	Horse	1	
51	51	Tweet 2	1	
52	52	116	116	
53	53	117	117	
54	54	118	118	
55	55	Ghost	2	
56	56	Maou	2	
57	57	121	121	
58	58	122	122	
59	59	123	123	
60	60	124	124	
61	61	125	125	
62	62	126	126	
63	63	127	127	
64	64	128	128	
Se (Sound Effects)	125	0	Telephone	1
	126	0	Helicptr	1
	127	0	Applause	1
	128	0	Gunshot	1

Program #	MSB=064 LSB=000	Element	Program #	MSB=064 LSB=000	Element
1	CuttingNz	1	65	PhonCall	1
2	ClingNz2	2	66	DoorSzek	1
3	DisCutNz	2	67	DoorSlam	1
4	Str Stap	1	68	ScratchC	1
5	B.Slide	2	69	ScratchS	1
6	P.Scrape	1	70	WindChim	1
7			71	Telphon2	1
8			72		
9			73		
10			74		
11			75		
12			76		
13			77		
14			78		
15			79		
16			80		
17	FLKClk	1	81	CarEingt	1
18			82	CarTSpel	1
19			83	Car Pass	1
20			84	CarCrash	1
21			85	Siren	2
			86	Train	1
22			87	JetPlane	2
23			88	Starburst	2
24			89	Shrap	2
25			90	Coaster	2
26			91	Submarin	1
27			92		
28			93		
29			94		
30			95		
31			96		
32			97	Laugh	1
33	Shower	1	98	Screen	1
34	Thunder	1	99	Punch	1
35	Wind	1	100	Heart	1
36	Stream	2	101	Footstep	1
37	Bubble	2	102		
38	Feed	2	103		
39			104		
40			105		
41			106		
42			107		
43			108		
44			109		
45			110		
46			111		
47			112		
48			113		
49	Dog	1	114	MchinGun	1
50	Horse	1	115	LaserGun	2
51	Tweet 2	1	116	Xplosion	2
52			117	FireWork	2
53			118		
54			119		
55	Ghost	2	120		
56	Maou	2	121		
57			122		
58			123		
59			124		
60			125		
61			126		
62			127		
63			128		
64					

▄ No sound

XG Drum Voice List

Bank Select MSB=Bank Number, LSB=000

Bank Select MSB		127		127		127		127		127			
Bank Select LSB		0		0		0		0		0			
Pgm# (1-128)		1		2		3		4		9			
Note#	Note	Key	Alternate Group	Standard Kit	E	Standard Kit 2	E	Dry Kit	E	Bright Kit	E	Room Kit	E
13	C#	-1	3	Surdo Mute	1					Surdo Mute B	1		
14	D	-1	3	Surdo Open	1					Surdo Open B	1		
15	D#	-1		Hi Q	1					Hi Q B	1		
16	E	-1		Whip Slap	1					Whip Slap B	1		
17	F	-1	4	Scratch H	1					Scratch H B	1		
18	F#	-1	4	Scratch L	1					Scratch L B	1		
19	G	-1		Finger Snap	1					Finger Snap B	1		
20	G#	-1		Click Noise	1					Click Noise B	1		
21	A	-1		Metronome Click	1					Metronome Click B	1		
22	A#	-1		Metronome Bell	1					Metronome Bell B	1		
23	B	-1		Seq Click L	1					Seq Click L B	1		
24	C	0		Seq Click H	1					Seq Click H B	1		
25	C#	0		Brush Tap	1					Brush Tap B	1		
26	D	0	O	Brush Swirl	1					Brush Swirl B	1		
27	D#	0		Brush Slap	1					Brush Slap B	1		
28	E	0	O	Brush Tap Swirl	1					Brush Tap Swirl B	1		
29	F	0	O	Snare Roll	1					Snare Roll B	1		
30	F#	0		Castanet	1					Castanet B	1		
31	G	0		Snare Soft	1	Snare Soft 2	1	Snare Dry Soft	1	Snare Soft B	1		
32	G#	0		Sticks	1					Sticks B	1		
33	A	0		Kick Soft	1			Kick Dry Soft	1	Kick Soft B	1		
34	A#	0		Open Rim Shot	1	Open Rim Shot H Short	1	Open Rim Shot Dry	1	Open Rim Shot B	1		
35	B	0		Kick Tight	1			Kick Dry Tight	1	Kick Tight B	1		
36	C	1		Kick	1	Kick Short	1	Kick Dry Mute	1	Kick B	1		
37	C#	1		Side Stick	1	Side Stick Light	1	Side Stick Dry	1	Side Stick B	1		
38	D	1		Snare	1	Snare Short	1	Snare Dry	1	Snare B	1	Snare Snappy	1
39	D#	1		Hand Glap	1			Hand Glap	1	Hand Glap B	1		
40	E	1		Snare Tight	1	Snare Tight H	1	Snare Dry Mute	1	Snare Tight B	1	Snare Tight Snappy	1
41	F	1		Floor Tom L	1			Floor Tom L Short	1	Floor Tom L B	1	Tom Room 1	1
42	F#	1	1	Hi-Hat Closed	1			Hi-Hat Closed L	1	Hi-Hat Closed L B	1		
43	G	1		Floor Tom H	1			Floor Tom H Short	1	Floor Tom H B	1	Tom Room 2	1
44	G#	1	1	Hi-Hat Pedal	1			Hi-Hat Pedal	1	Hi-Hat Pedal B	1		
45	A	1		Low Tom	1			Low Tom Short	1	Low Tom B	1	Tom Room 3	1
46	A#	1	1	Hi-Hat Open	1			Hi-Hat Open	1	Hi-Hat Open B	1		
47	B	1		Mid Tom L	1			Mid Tom L Short	1	Mid Tom L B	1	Tom Room 4	1
48	C	2		Mid Tom H	1			Mid Tom H Short	1	Mid Tom H B	1	Tom Room 5	1
49	C#	2		Crash Cymbal 1	1			Crash Cymbal 1 B	1	Crash Cymbal 1 B	1		
50	D	2		High Tom	1			High Tom Short	1	High Tom B	1	Tom Room 6	1
51	D#	2		Ride Cymbal 1	1			Ride Cymbal 1 B	1	Ride Cymbal 1 B	1		
52	E	2		Chinese Cymbal	1			Chinese Cymbal B	1	Chinese Cymbal B	1		
53	F	2		Ride Cymbal Cup	1			Ride Cymbal Cup Short	1	Ride Cymbal Cup Short	1		
54	F#	2		Tambourine	1			Tambourine B	1	Tambourine B	1		
55	G	2		Splash Cymbal	1			Splash Cymbal B	1	Splash Cymbal B	1		
56	G#	2		Cowbell	1			Cowbell L	1	Cowbell L	1		
57	A	2		Crash Cymbal 2	1			Crash Cymbal 2 B	1	Crash Cymbal 2 B	1		
58	A#	2		Vibraslap	1			Vibraslap B	1	Vibraslap B	1		
59	B	2		Ride Cymbal 2	1			Ride Cymbal 2 B	1	Ride Cymbal 2 B	1		
60	C	3		Bongo H	1			Bongo H B	1	Bongo H B	1		
61	C#	3		Bongo L	1			Bongo L B	1	Bongo L B	1		
62	D	3		Conga H Mute	1			Conga H Mute B	1	Conga H Mute B	1		
63	D#	3		Conga H Open	1			Conga H Open B	1	Conga H Open B	1		
64	E	3		Conga L	1			Conga L B	1	Conga L B	1		
65	F	3		Timbale H	1			Timbale H B	1	Timbale H B	1		
66	F#	3		Timbale L	1			Timbale L B	1	Timbale L B	1		
67	G	3		Agogo H	1			Agogo H B	1	Agogo H B	1		
68	G#	3		Agogo L	1			Agogo L B	1	Agogo L B	1		
69	A	3		Cabasa	1			Cabasa B	1	Cabasa B	1		
70	A#	3		Maracas	1			Maracas B	1	Maracas B	1		
71	B	3	O	Samba Whistle H	1			Samba Whistle H B	1	Samba Whistle H B	1		
72	C	4	O	Samba Whistle L	1			Samba Whistle L B	1	Samba Whistle L B	1		
73	C#	4		Güiro Short	1			Güiro Short B	1	Güiro Short B	1		
74	D	4	O	Güiro Long	1			Güiro Long B	1	Güiro Long B	1		
75	D#	4		Claves	1			Claves B	1	Claves B	1		
76	E	4		Wood Block H	1			Wood Block H B	1	Wood Block H B	1		
77	F	4		Wood Block L	1			Wood Block L B	1	Wood Block L B	1		
78	F#	4		Cuica Mute	1			Cuica Mute B	1	Cuica Mute B	1		
79	G	4		Cuica Open	1			Cuica Open B	1	Cuica Open B	1		
80	G#	4	2	Triangle Mute	1			Triangle Mute B	1	Triangle Mute B	1		
81	A	4	2	Triangle Open	1			Triangle Open B	1	Triangle Open B	1		
82	A#	4		Shaker	1			Shaker B	1	Shaker B	1		
83	B	4		Jingle Bells	1			Jingle Bells B	1	Jingle Bells B	1		
84	C	5		Bell Tree	1			Bell Tree B	1	Bell Tree B	1		
85	C#	5											
86	D	5											
87	D#	5											
88	E	5											
89	F	5											
90	F#	5											
91	G	5											

Same as Standard Kit
 No sound

* The Alternate Group is a function that prevents voices in the same group from being played simultaneously. For example, Hi-Hat Closed and Hi-Hat Open voices will not simultaneously sound in group 1.

X G D r u m V o i c e L i s t

Bank Select MSB			127	127	127	127	127						
Bank Select LSB			0	0	0	0	0						
Pgmr (1-120)			1	10	17	18	25						
Note#	Note	Key Off	Alternate Group	Standard Kit	E	Dark Room Kit	E	Rock Kit	E	Rock Kit 2	E	Electro Kit	E
13	C# -1		3	Surdo Mute	1								
14	D -1		3	Surdo Open	1								
15	D# -1			Hi Q	1								
16	E -1			Whip Slap	1								
17	F -1		4	Scratch H	1								
18	F# -1		4	Scratch L	1								
19	G -1			Finger Snap	1								
20	G# -1			Click Noise	1								
21	A -1			Metronome Click	1								
22	A# -1			Metronome Bell	1								
23	B -1			Seq Click L	1								
24	C 0			Seq Click H	1								
25	C# 0			Brush Tap	1								
26	D 0	O		Brush Swirl	1								
27	D# 0			Brush Slap	1								
28	E 0	O		Brush Tap Swirl	1								
29	F 0	O		Snare Roll	1							Reverse Cymbal	1
30	F# 0			Castanet	1								
31	G 0			Snare Soft	1			Snare Noisy	1	Snare Noisy 5	1	Snare Snappy Electro	1
32	G# 0			Sticks	1								
33	A 0			Kick Soft	1					Kick Tight 2	1	Kick 3	1
34	A# 0			Open Rim Shot	1								
35	B 0			Kick Tight	1	Kick Dark	1	Kick 2	1	Kick 4	1	Kick Gate	1
36	C 1			Kick	1	Kick Room Gate	1	Kick Gate	1	Kick Gate 2	1	Kick Gate Heavy	1
37	C# 1			Side Stick	1								
38	D 1			Snare	1	Snare Snappy 2	1	Snare Rock	1	Snare Rock 2	1	Snare Noisy 2	1
39	D# 1			Hand Clap	1								
40	E 1			Snare Tight	1	Snare Tight Snappy 2	1	Snare Rock Tight	1	Snare Rock Rim Q	1	Snare Noisy 3	1
41	F 1			Floor Tom L	1	Tom Room 1 Q	1	Tom Rock 1	1	Tom Rock Hard 1	1	Tom Electro 1	1
42	F# 1		1	Hi-Hat Closed	1	Hi-Hat Closed Q	1			Hi-Hat Closed 2	1		
43	G 1			Floor Tom H	1	Tom Room 2 Q	1	Tom Rock 2	1	Tom Rock Hard 2	1	Tom Electro 2	1
44	G# 1		1	Hi-Hat Pedal	1	Hi-Hat Pedal Q	1			Hi-Hat Pedal 2	1		
45	A 1			Low Tom	1	Tom Room 3 Q	1	Tom Rock 3	1	Tom Rock Hard 3	1	Tom Electro 3	1
46	A# 1		1	Hi-Hat Open	1	Hi-Hat Open L	1			Hi-Hat Open 2	1		
47	B 1			Mid Tom L	1	Tom Room 4 Dark	1	Tom Rock 4	1	Tom Rock Hard 4	1	Tom Electro 4	1
48	C 2			Mid Tom H	1	Tom Room 5 L Dark	1	Tom Rock 5	1	Tom Rock Hard 5	1	Tom Electro 5	1
49	C# 2			Crash Cymbal 1	1								
50	D 2			High Tom	1	Tom Room 6 L Dark	1	Tom Rock 6	1	Tom Rock Hard 6	1	Tom Electro 6	1
51	D# 2			Ride Cymbal 1	1								
52	E 2			Chinese Cymbal	1								
53	F 2			Ride Cymbal Cup	1								
54	F# 2			Tambourine	1								
55	G 2			Splash Cymbal	1								
56	G# 2			Cowbell	1								
57	A 2			Crash Cymbal 2	1								
58	A# 2			Vibraslap	1								
59	B 2			Ride Cymbal 2	1								
60	C 3			Bongo H	1								
61	C# 3			Bongo L	1								
62	D 3			Conga H Mute	1								
63	D# 3			Conga H Open	1								
64	E 3			Conga L	1								
65	F 3			Timbale H	1								
66	F# 3			Timbale L	1								
67	G 3			Agogo H	1								
68	G# 3			Agogo L	1								
69	A 3			Cabasa	1								
70	A# 3			Maracas	1								
71	B 3	O		Samba Whistle H	1								
72	C 4	O		Samba Whistle L	1								
73	C# 4			Güiro Short	1								
74	D 4	O		Güiro Long	1								
75	D# 4			Claves	1								
76	E 4			Wood Block H	1								
77	F 4			Wood Block L	1								
78	F# 4			Cuica Mute	1							Scratch H 2	1
79	G 4			Cuica Open	1							Scratch L 2	1
80	G# 4		2	Triangle Mute	1								
81	A 4		2	Triangle Open	1								
82	A# 4			Shaker	1								
83	B 4			Jingle Bells	1								
84	C 5			Bell Tree	1								
85	C# 5												
86	D 5												
87	D# 5												
88	E 5												
89	F 5												
90	F# 5												
91	G 5												

Same as Standard Kit
 No sound

* The Alternate Group is a function that prevents voices in the same group from being played simultaneously. For example, Hi-Hat Closed and Hi-Hat Open voices will not simultaneously sound in group 1.

X G D r u m V o i c e L i s t

Bank Select MSB=Bank Number, LSB=000

Bank Select MSB			127		127		127		127		
Bank Select LSB			0		0		0		0		
Pg#s# (1-126)			1		26		27		28		
Note#	Note	Key Off	Alternate Group	Standard Kit	E	Analog Kit	E	Analog Kit 2	E	Dance Kit	E
13	C# -1		3	Surdo Mute	1						
14	D -1		3	Surdo Open	1						
15	D# -1			Hi Q	1						
16	E -1			Whip Slap	1						
17	F -1		4	Scratch H	1						
18	F# -1		4	Scratch L	1						
19	G -1			Finger Snap	1						
20	G# -1			Click Noise	1						
21	A -1			Metronome Click	1						
22	A# -1			Metronome Bell	1						
23	B -1			Seq Click L	1						
24	C 0			Seq Click H	1						
25	C# 0			Brush Tap	1						
26	D 0	O		Brush Swirl	1						
27	D# 0			Brush Slap	1						
28	E 0	O		Brush Tap Swirl	1	Reverse Cymbal	1	Reverse Cymbal	1	Reverse Cymbal	1
29	F 0	O		Snare Roll	1						
30	F# 0			Castanet	1	Hi Q 2	1	Hi Q 2	1	Hi Q 2	1
31	G 0			Snare Soft	1	Snare Noisy 4	1	Snare Analog 3	1	Snare Techno	1
32	G# 0			Sticks	1						
33	A 0			Kick Soft	1	Kick 3	1	Kick Techno Soft	1	Kick Techno Q	1
34	A# 0			Open Rim Shot	1			Open Rim Shot Dry	1	Rim Gate	1
35	B 0			Kick Tight	1	Kick Analog Short	1	Kick Techno Tight	1	Kick Techno L	1
36	C 1			Kick	1	Kick Analog	1	Kick Techno	1	Kick Techno 2	1
37	C# 1			Side Stick	1	Side Stick Analog	1	Side Stick Analog	1	Side Stick Analog	1
38	D 1			Snare	1	Snare Analog	1	Snare Techno	1	Snare Clap	1
39	D# 1			Hand Clap	1						
40	E 1			Snare Tight	1	Snare Analog 2	1	Snare Techno 2	1	Snare Dry	1
41	F 1			Floor Tom L	1	Tom Analog 1	1	Tom Analog 1	1	Tom Analog 1	1
42	F# 1	1		Hi-Hat Closed	1	Hi-Hat Closed Analog	1	Hi-Hat Closed Analog	1	Hi-Hat Closed 3	1
43	G 1			Floor Tom H	1	Tom Analog 2	1	Tom Analog 2	1	Tom Analog 2	1
44	G# 1	1		Hi-Hat Pedal	1	Hi-Hat Closed Analog 2	1	Hi-Hat Closed Analog 2	1	Hi-Hat Closed Analog 3	1
45	A 1			Low Tom	1	Tom Analog 3	1	Tom Analog 3	1	Tom Analog 3	1
46	A# 1	1		Hi-Hat Open	1	Hi-Hat Open Analog	1	Hi-Hat Open Analog	1	Hi-Hat Open 3	1
47	B 1			Mid Tom L	1	Tom Analog 4	1	Tom Analog 4	1	Tom Analog 4	1
48	C 2			Mid Tom H	1	Tom Analog 5	1	Tom Analog 5	1	Tom Analog 5	1
49	C# 2			Crash Cymbal 1	1	Crash Analog	1	Crash Analog	1	Crash Analog	1
50	D 2			High Tom	1	Tom Analog 6	1	Tom Analog 6	1	Tom Analog 6	1
51	D# 2			Ride Cymbal 1	1						
52	E 2			Chinese Cymbal	1						
53	F 2			Ride Cymbal Cup	1						
54	F# 2			Tambourine	1						
55	G 2			Splash Cymbal	1						
56	G# 2			Cowbell	1	Cowbell Analog	1	Cowbell Analog	1	Cowbell Analog	1
57	A 2			Crash Cymbal 2	1						
58	A# 2			Vibraslap	1						
59	B 2			Ride Cymbal 2	1						
60	C 3			Bongó H	1						
61	C# 3			Bongó L	1						
62	D 3			Conga H Mute	1	Conga Analog H	1	Conga Analog H	1	Conga Analog H	1
63	D# 3			Conga H Open	1	Conga Analog M	1	Conga Analog M	1	Conga Analog M	1
64	E 3			Conga L	1	Conga Analog L	1	Conga Analog L	1	Conga Analog L	1
65	F 3			Timbale H	1						
66	F# 3			Timbale L	1						
67	G 3			Agogo H	1						
68	G# 3			Agogo L	1						
69	A 3			Cabasa	1						
70	A# 3			Maracas	1	Maracas 2	1	Maracas 2	1	Maracas 2	1
71	B 3	O		Samba Whistle H	1						
72	C 4	O		Samba Whistle L	1						
73	C# 4			Güiro Short	1						
74	D 4	O		Güiro Long	1						
75	D# 4			Claves	1	Claves 2	1	Claves 2	1	Claves 2	1
76	E 4			Wood Block H	1						
77	F 4			Wood Block L	1						
78	F# 4			Cuica Mute	1	Scratch H 2	1	Scratch H 2	1	Scratch H 2	1
79	G 4			Cuica Open	1	Scratch L 2	1	Scratch L 2	1	Scratch L 2	1
80	G# 4	2		Triangle Mute	1						
81	A 4	2		Triangle Open	1						
82	A# 4			Shaker	1						
83	B 4			Jingle Bells	1						
84	C 5			Bell Tree	1						
85	C# 5										
86	D 5										
87	D# 5										
88	E 5										
89	F 5										
90	F# 5										
91	G 5										

Same as Standard Kit
 No sound

* The Alternate Group is a function that prevents voices in the same group from being played simultaneously. For example, Hi-Hat Closed and Hi-Hat Open voices will not simultaneously sound in group 1.

X G D r u m V o i c e L i s t

Bank Select MSB			127		127		127		127		127		
Bank Select LSB			0		0		0		0		0		
Pgmr# (1-126)			1		29		30		33		34		
Notes#	Note	Key Off	Alternate Group	Standard Kit	E	Hip Hop Kit	E	Jungle Kit	E	Jazz Kit	E	Jazz Kit 2	E
13	C#	-1	3	Surdo Mute	1								
14	D	-1	3	Surdo Open	1								
15	D#	-1		Hi Q	1								
16	E	-1		Whip Slap	1								
17	F	-1	4	Scratch H	1								
18	F#	-1	4	Scratch L	1								
19	G	-1		Finger Snap	1								
20	G#	-1		Click Noise	1								
21	A	-1		Metronome Click	1								
22	A#	-1		Metronome Bell	1								
23	B	-1		Seq Click L	1								
24	C	0		Seq Click H	1								
25	C#	0		Brush Tap	1								
26	D	0	O	Brush Swirl	1								
27	D#	0		Brush Slap	1								
28	E	0	O	Brush Tap Swirl	1								
29	F	0	O	Snare Roll	1								
30	F#	0		Castanet	1								
31	G	0		Snare Soft	1	Open Rim Shot 2 Soft	1	Rim Gate 2	1	Snare Jazz H	1	Snare Jazz H	1
32	G#	0		Sticks	1								
33	A	0		Kick Soft	1	Kick Dry Soft 2	1	Kick Cough	1				
34	A#	0		Open Rim Shot	1	Open Rim Shot 2	1	Rim Gate 3	1				
35	B	0		Kick Tight	1	Kick Dim	1	Kick Zap	1				
36	C	1		Kick	1	Kick Boon	1	Kick Dawn	1	Kick Jazz	1	Kick Jazz L	1
37	C#	1		Side Stick	1	Side Stick Dry	1	Side Stick Dry	1	Side Stick Light	1	Side Stick Light	1
38	D	1		Snare	1	Snare Dry Mute	1	Snare Tin	1	Snare Jazz L	1	Snare Jazz H 2	1
39	D#	1		Hand Glap	1								
40	E	1		Snare Light	1	Snare White	1	Snare Can	1	Snare Jazz M	1	Snare Tight L	1
41	F	1		Floor Tom L	1	Floor Tom L Short	1	Floor Tom L Short	1				
42	F#	1	1	Hi-Hat Closed	1	Hi-Hat Closed 2 H	1	Hi-Hat Closed 2 Soft	1			Hi-Hat Closed L	1
43	G	1		Floor Tom H	1	Floor Tom H Short	1	Floor Tom H Short	1				
44	G#	1	1	Hi-Hat Pedal	1	Hi-Hat Pedal 2 H	1	Hi-Hat Pedal 2 Soft	1				
45	A	1		Low Tom	1	Low Tom Short	1	Low Tom Short	1			Hi-Hat Pedal L	1
46	A#	1	1	Hi-Hat Open	1	Hi-Hat Open 2 L	1	Hi-Hat Open 2 Short	1			Hi-Hat Open L	1
47	B	1		Mid Tom L	1	Mid Tom L Short	1	Mid Tom L Short	1				
48	C	2		Mid Tom H	1	Mid Tom H Short	1	Mid Tom H Short	1				
49	C#	2		Crash Cymbal 1	1								
50	D	2		High Tom	1	High Tom Short	1	High Tom Short	1				
51	D#	2		Ride Cymbal 1	1								
52	E	2		Chinese Cymbal	1								
53	F	2		Ride Cymbal Cup	1							Ride Cymbal Cup H	1
54	F#	2		Tambourine	1								
55	G	2		Splash Cymbal	1								
56	G#	2		Cowbell	1								
57	A	2		Crash Cymbal 2	1								
58	A#	2		Vibraslap	1								
59	B	2		Ride Cymbal 2	1								
60	C	3		Bongo H	1								
61	C#	3		Bongo L	1								
62	D	3		Conga H Mute	1								
63	D#	3		Conga H Open	1								
64	E	3		Conga L	1								
65	F	3		Timbale H	1								
66	F#	3		Timbale L	1								
67	G	3		Agogo H	1								
68	G#	3		Agogo L	1								
69	A	3		Cabasa	1								
70	A#	3		Maracas	1								
71	B	3	O	Samba Whistle H	1								
72	C	4	O	Samba Whistle L	1								
73	C#	4		Güiro Short	1								
74	D	4	O	Güiro Long	1								
75	D#	4		Claves	1								
76	E	4		Wood Block H	1								
77	F	4		Wood Block L	1								
78	F#	4		Cuica Mute	1								
79	G	4		Cuica Open	1								
80	G#	4	2	Triangle Mute	1								
81	A	4	2	Triangle Open	1								
82	A#	4		Shaker	1								
83	B	4		Jingle Bells	1								
84	C	5		Bell Tree	1								
85	C#	5											
86	D	5											
87	D#	5											
88	E	5											
89	F	5											
90	F#	5											
91	G	5											

Same as Standard Kit
 No sound

* The Alternate Group is a function that prevents voices in the same group from being played simultaneously. For example, Hi-Hat Closed and Hi-Hat Open voices will not simultaneously sound in group 1.

X G D r u m V o i c e L i s t

Bank Select MSB=Bank Number, LSB=000

Bank Select MSB			127			127			127			127			127		
Bank Select LSB			0			41			0			113			0		
Pg#s# (1-120)			1			49			0			113			114		
Note#	Note	Key Off	Alternate Group	Standard Kit	E	Brush Kit	E	Symphony Kit	E	R&B Kit	E	Rock Kit 3	E				
13	C#	-1	3	Surdo Mute	1												
14	D	-1	3	Surdo Open	1												
15	D#	-1		Hi Q	1												
16	E	-1		Whip Slap	1												
17	F	-1	4	Scratch H	1												
18	F#	-1	4	Scratch L	1												
19	G	-1		Finger Snap	1												
20	G#	-1		Click Noise	1												
21	A	-1		Metronome Click	1												
22	A#	-1		Metronome Bell	1												
23	B	-1		Seq Click L	1												
24	C	0		Seq Click H	1												
25	C#	0		Brush Tap	1												
26	D	0	O	Brush Swirl	1												
27	D#	0		Brush Slap	1												
28	E	0	O	Brush Tap Swirl	1					Reverse Cymbal	1						
29	F	0	O	Snare Roll	1												
30	F#	0		Castanet	1					Hi Q 2	1						
31	G	0		Snare Soft	1	Brush Slap 2	1			Snare R&B 1	1	Snare Rock 3	1				
32	G#	0		Sticks	1												
33	A	0		Kick Soft	1			Kick Soft 2	1	Kick R&B 1	1	Kick Rock 1	1				
34	A#	0		Open Rim Shot	1	Open Rim Shot Light	1			Snare R&B 2	1	Open Rim Shot Rock	1				
35	B	0		Kick Trigh	1			Gran Cassa	1	Kick R&B 2	1	Kick Rock 2	1				
36	C	1		Kick Jazz	1	Kick Jazz	1	Gran Cassa Mute	1	Kick R&B 3	1	Kick Rock 3	1				
37	C#	1		Side Stick	1	Side Stick Light	1			Side Stick Analog 2	1	Side Stick Rock	1				
38	D	1		Snare	1	Brush Slap 3	1	Band Snare	1	Snare R&B 3	1	Snare Rock 4	1				
39	D#	1		Hand Glap	1												
40	E	1		Snare Light	1	Brush Tap 2	1	Band Snare 2	1	Snare R&B 4	1	Snare Rock 5	1				
41	F	1		Floor Tom L	1	Tom Brush 1	1			Floor Tom L Dark	1	Floor Tom L Rock	1				
42	F#	1	1	Hi-Hat Closed	1					Hi-Hat Closed 4	1	Hi-Hat Closed 5	1				
43	G	1		Floor Tom H	1	Tom Brush 2	1			Floor Tom H Dark	1	Floor Tom H Rock	1				
44	G#	1	1	Hi-Hat Pedal	1					Hi-Hat Closed Analog 2	1	Hi-Hat Pedal 5	1				
45	A	1		Low Tom	1	Tom Brush 3	1			Low Tom Dark	1	Low Tom Rock	1				
46	A#	1	1	Hi-Hat Open	1					Hi-Hat Open 4	1	Hi-Hat Open 5	1				
47	B	1		Mid Tom L	1	Tom Brush 4	1			Mid Tom L Dark	1	Mid Tom L Rock	1				
48	C	2		Mid Tom H	1	Tom Brush 5	1			Mid Tom H Dark	1	Mid Tom H Rock	1				
49	C#	2		Crash Cymbal 1	1					Crash Analog	1						
50	D	2		High Tom	1	Tom Brush 6	1			High Tom Dark	1	High Tom Rock	1				
51	D#	2		Ride Cymbal 1	1												
52	E	2		Chinese Cymbal	1												
53	F	2		Ride Cymbal Cup	1												
54	F#	2		Tambourine	1					Tambourine 2	1						
55	G	2		Splash Cymbal	1												
56	G#	2		Cowbell	1					Cowbell Analog	1						
57	A	2		Crash Cymbal 2	1			Hand Cymbal 2	1								
58	A#	2		Vibraslap	1												
59	B	2		Ride Cymbal 2	1			Hand Cymbal 2 Short	1								
60	C	3		Bongo H	1												
61	C#	3		Bongo L	1												
62	D	3		Conga H Mute	1					Conga Analog H	1						
63	D#	3		Conga H Open	1					Conga Analog M	1						
64	E	3		Conga L	1					Conga Analog L	1						
65	F	3		Timbale H	1												
66	F#	3		Timbale L	1												
67	G	3		Agogo H	1												
68	G#	3		Agogo L	1												
69	A	3		Cabasa	1					Cabasa 2	1						
70	A#	3		Maracas	1					Maracas 2	1						
71	B	3	O	Samba Whistle H	1												
72	C	4	O	Samba Whistle L	1												
73	C#	4		Güiro Short	1												
74	D	4	O	Güiro Long	1												
75	D#	4		Claves	1					Claves 2	1						
76	E	4		Wood Block H	1												
77	F	4		Wood Block L	1												
78	F#	4		Cuica Mute	1					Scratch H 2	1						
79	G	4		Cuica Open	1					Scratch L 2	1						
80	G#	4	2	Triangle Mute	1												
81	A	4	2	Triangle Open	1												
82	A#	4		Shaker	1												
83	B	4		Jingle Bells	1					Tambourine 3	1						
84	C	5		Bell Tree	1					Wind Chime	1						
85	C#	5															
86	D	5															
87	D#	5															
88	E	5															
89	F	5															
90	F#	5															
91	G	5															

Same as Standard Kit
 No sound

* The Alternate Group is a function that prevents voices in the same group from being played simultaneously. For example, Hi-Hat Closed and Hi-Hat Open voices will not simultaneously sound in group 1.

X G D r u m V o i c e L i s t

Bank Select MSB		127		126		126			
Bank Select LSB		0		0		0			
Pgms# (1-126)		1		1		2			
Notes#	Note	Key Off	Alternate Group	Standard Kit	E	SFX Kit 1	E	SFX Kit 2	E
13	C#	-1	3	Surdo Mute	1				
14	D	-1	3	Surdo Open	1				
15	D#	-1		Hi Q	1				
16	E	-1		Whip Slap	1				
17	F	-1	4	Scratch H	1				
18	F#	-1	4	Scratch L	1				
19	G	-1		Finger Snap	1				
20	G#	-1		Click Noise	1				
21	A	-1		Metronome Click	1				
22	A#	-1		Metronome Bell	1				
23	B	-1		Seq Click L	1				
24	C	0		Seq Click H	1				
25	C#	0		Brush Tap	1				
26	D	0	O	Brush Swirl	1				
27	D#	0		Brush Slap	1				
28	E	0	O	Brush Tap Swirl	1				
29	F	0	O	Snare Roll	1				
30	F#	0		Castanet	1				
31	G	0		Snare Soft	1				
32	G#	0		Sticks	1				
33	A	0		Kick Soft	1				
34	A#	0		Open Rim Shot	1				
35	B	0		Kick Tight	1				
36	C	1		Kick	1	Cutting Noise	1	Phone Call	1
37	C#	1		Side Stick	1	Cutting Noise 2	1	Door Squeak	1
38	D	1		Snare	1	Distorted Cutting Noise	2	Door Slam	1
39	D#	1		Hand Clap	1	String Slap	1	Scratch Cut	1
40	E	1		Snare Tight	1	Bass Slide	2	Scratch H 3	2
41	F	1		Floor Tom L	1	Pick Scrape	1	Wind Chime	1
42	F#	1	1	Hi-Hat Closed	1			Telephone 2	1
43	G	1		Floor Tom H	1				
44	G#	1	1	Hi-Hat Pedal	1				
45	A	1		Low Tom	1				
46	A#	1	1	Hi-Hat Open	1				
47	B	1		Mid Tom L	1				
48	C	2		Mid Tom H	1				
49	C#	2		Crash Cymbal 1	1				
50	D	2		High Tom	1				
51	D#	2		Ride Cymbal 1	1				
52	E	2		Chinese Cymbal	1	Flute Key Click	1	Car Engine Ignition	1
53	F	2		Ride Cymbal Cup	1			Car Tires Squeal	1
54	F#	2		Tambourine	1			Car Passing	1
55	G	2		Splash Cymbal	1			Car Crash	1
56	G#	2		Cowbell	1			Siren	2
57	A	2		Crash Cymbal 2	1			Train	1
58	A#	2		Vibraslap	1			Jet Plane	2
59	B	2		Ride Cymbal 2	1			Starship	2
60	C	3		Bongo H	1			Burst	2
61	C#	3		Bongo L	1			Roller Coaster	2
62	D	3		Conga H Mute	1			Submarine	2
63	D#	3		Conga H Open	1				
64	E	3		Conga L	1				
65	F	3		Timbale H	1				
66	F#	3		Timbale L	1				
67	G	3		Agogo H	1				
68	G#	3		Agogo L	1	Shower	2	Laugh	1
69	A	3		Cabasa	1	Thunder	1	Scream	1
70	A#	3		Maracas	1	Wind	1	Punch	1
71	B	3	O	Samba Whistle H	1	Stream	2	Heart Beat	1
72	C	4	O	Samba Whistle L	1	Bubble	2	Foot Steps	1
73	C#	4		Guiro Short	1	Feed	2		
74	D	4	O	Guiro Long	1				
75	D#	4		Claves	1				
76	E	4		Wood Block H	1				
77	F	4		Wood Block L	1				
78	F#	4		Cuica Mute	1				
79	G	4		Cuica Open	1				
80	G#	4	2	Triangle Mute	1				
81	A	4	2	Triangle Open	1				
82	A#	4		Shaker	1				
83	B	4		Jingle Bells	1				
84	C	5		Bell Tree	1	Dog	1	Machine Gun	1
85	C#	5				Horse	1	Laser Gun	2
86	D	5				Bird Tweet 2	1	Explosion	2
87	D#	5						Firework	2
88	E	5							
89	F	5							
90	F#	5				Ghost	2		
91	G	5				Maou	2		

Same as Standard Kit
 No sound

* The Alternate Group is a function that prevents voices in the same group from being played simultaneously. For example, Hi-Hat Closed and Hi-Hat Open voices will not simultaneously sound in group 1.

Effect Type List

REVERB

Exclusive		Effect Type	Description
MSB	LSB		
00	00	NO EFFECT	Effect turned off.
01	00	HALL1	Reverb simulating the resonance of a hall.
01	01	HALL2	Reverb simulating the resonance of a hall.
02	00	ROOM1	Reverb simulating the resonance of a room.
02	01	ROOM2	Reverb simulating the resonance of a room.
02	02	ROOM3	Reverb simulating the resonance of a room.
03	00	STAGE1	Reverb appropriate for a solo instrument.
03	01	STAGE2	Reverb appropriate for a solo instrument.
04	00	PLATE	Reverb simulating a metal plate reverb unit.
10	00	WHITE ROOM	A unique short reverb with a bit of initial delay.
11	00	TUNNEL	Simulation of a tunnel space expanding to left and right.
13	00	BASEMENT	A bit of initial delay followed by reverb with a unique resonance.

CHORUS

Exclusive		Effect Type	Description
MSB	LSB		
00	00	NO EFFECT	Effect turned off.
41	00	CHORUS1	Conventional chorus program that adds natural spaciousness.
41	01	CHORUS2	Conventional chorus program that adds natural spaciousness.
41	02	CHORUS3	Conventional chorus program that adds natural spaciousness.
41	08	CHORUS4	Chorus with stereo input. The pan setting specified for the Part will also apply to the effect sound.
42	00	CELESTE1	A 3-phase LFO adds modulation and spaciousness to the sound.
42	01	CELESTE2	A 3-phase LFO adds modulation and spaciousness to the sound.
42	02	CELESTE3	A 3-phase LFO adds modulation and spaciousness to the sound.
42	08	CELESTE4	Celeste with stereo input. The pan setting specified for the Part will also apply to the effect sound.
43	00	FLANGER1	Adds a jet-airplane effect to the sound.
43	01	FLANGER2	Adds a jet-airplane effect to the sound.
43	08	FLANGER3	Adds a jet-airplane effect to the sound.

VARIATION

Exclusive		Effect Type	Description
MSB	LSB		
00	00	NO EFFECT	Effect turned off.
01	00	HALL1	Reverb simulating the resonance of a hall.
01	01	HALL2	Reverb simulating the resonance of a hall.
02	00	ROOM1	Reverb simulating the resonance of a room.
02	01	ROOM2	Reverb simulating the resonance of a room.
02	02	ROOM3	Reverb simulating the resonance of a room.
03	00	STAGE1	Reverb appropriate for a solo instrument.
03	01	STAGE2	Reverb appropriate for a solo instrument.
04	00	PLATE	Reverb simulating a metal plate reverb unit.
05	00	DELAY L, C, R	A program that creates three delay sounds; L, R, and C (center).
06	00	DELAY L, R	A program that creates two delay sounds; L and R. Two feedback delays are provided.
07	00	ECHO	Two delays (L and R) and independent feedback delays for L and R.
08	00	CROSS DELAY	A program that crosses the feedback of two delays.
09	00	EARLY REF1	An effect that produces only the early reflection component of reverb.
09	01	EARLY REF2	An effect that produces only the early reflection component of reverb.
0A	00	GATE REVERB	A simulation of gated reverb.
0B	00	REVERSE GATE	A program that simulates gated reverb played backwards.
14	00	KARAOKE 1	A delay with feedback of the same types as used for karaoke reverb.
14	01	KARAOKE 2	A delay with feedback of the same types as used for karaoke reverb.
14	02	KARAOKE 3	A delay with feedback of the same types as used for karaoke reverb.
41	00	CHORUS1	Conventional chorus program that adds natural spaciousness.
41	01	CHORUS2	Conventional chorus program that adds natural spaciousness.
41	02	CHORUS3	Conventional chorus program that adds natural spaciousness.
41	08	CHORUS4	Chorus with stereo input.
42	00	CELESTE1	A 3-phase LFO adds modulation and spaciousness to the sound.
42	01	CELESTE2	A 3-phase LFO adds modulation and spaciousness to the sound.
42	02	CELESTE3	A 3-phase LFO adds modulation and spaciousness to the sound.
42	08	CELESTE4	Celeste with stereo input.
43	00	FLANGER1	Adds a jet-airplane effect to the sound.
43	01	FLANGER2	Adds a jet-airplane effect to the sound.
43	08	FLANGER3	Adds a jet-airplane effect to the sound.
44	00	SYMPHONIC	A multi-phase version of CELESTE.
45	00	ROTARY SPEAKER	A simulation of a rotary speaker. You can use AC1 (assignable controller) etc. to control the speed of rotation.
46	00	TREMOLO	An effect that cyclically modulates the volume.
47	00	AUTO PAN	A program that cyclically moves that sound image to left and right, front and back.
48	00	PHASER1	Cyclically changes the phase to add modulation to the sound.
48	08	PHASER2	Phaser with stereo input.
49	00	DISTORTION	Adds a sharp-edged distortion to the sound.
4A	00	OVER DRIVE	Adds mild distortion to the sound.
4B	00	AMP SIMULATOR	A simulation of a guitar amp.
4C	00	3BAND EQ(MONO)	A mono EQ with adjustable LOW, MID, and HIGH equalizing.
4D	00	2BAND EQ(STEREO)	A stereo EQ with adjustable LOW and HIGH. Ideal for drum Parts.
4E	00	AUTO WAH(LFO)	Cyclically modulates the center frequency of a wah filter. With an AC1 etc. this can function as a pedal wah.
40	00	THRU	Bypass without applying an effect.

* Both MSB, LSB are hexadecimal. * The effect for LSB=0 is the basic type.

Effect Parameter List

● Reverb Type

HALL1,2, ROOM1,2,3, STAGE1,2, PLATE

No.*	Parameter	Range	Value	→ Tbl	Control
1	Reverb Time	0.3 - 30.0s	0-69	table#4	
2	Diffusion	0 - 10	0-10		
3	Initial Delay	0 - 63	0-63	table#5	
4	HPF Cutoff	Thru - 8.0kHz	0-52	table#3	
5	LPF Cutoff	1.0k - Thru	34-60	table#3	
6					
7					
8					
9					
10	Dry/Wet	D63>W - D=W - D<W63	1-127		●
11	Rev Delay	0 - 63	0-63	table#5	
12	Density	0 - 3	0-3		
13	Er/ Rev Balance	E63> R - E=R - E<R63	1-127		
14					
15	Feedback Level	-63 - +63	1-127		
16					

WHITE ROOM, TUNNEL, BASEMENT

No.*	Parameter	Range	Value	→ Tbl	Control
1	Reverb Time	0.3 - 30.0s	0-69	table#4	
2	Diffusion	0 - 10	0-10		
3	Initial Delay	0 - 63	0-63	table#5	
4	HPF Cutoff	Thru - 8.0kHz	0-52	table#3	
5	LPF Cutoff	1.0k - Thru	34-60	table#3	
6	Width	0.5 - 10.2m	0-37	table#8	
7	Height	0.5 - 20.2m	0-73	table#8	
8	Depth	0.5 - 30.2m	0-104	table#8	
9	Wall Vary	0 - 30	0-30		
10	Dry/Wet	D63>W - D=W - D<W63	1-127		●
11	Rev Delay	0 - 63	0-63	table#5	
12	Density	0 - 3	0-3		
13	Er/ Rev Balance	E63> R - E=R - E<R63	1-127		
14					
15	Feedback Level	-63 - +63	1-127		
16					

● Chorus Type

CHORUS1,2,3,4, CELESTE1,2,3,4

No.*	Parameter	Range	Value	→ Tbl	Control
1	LFO Frequency	0.00 - 39.7Hz	0-127	table#1	
2	LFO PM Depth	0 - 127	0-127		
3	Feedback Level	-63 - +63	1-127		
4	Delay Offset	0 - 127	0-127	table#2	
5					
6	EQ Low Frequency	50Hz - 2.0kHz	8-40	table#3	
7	EQ Low Gain	-12 - +12dB	52-76		
8	EQ High Frequency	500Hz - 16.0kHz	28-58	table#3	
9	EQ High Gain	-12 - +12dB	52-76		
10	Dry/Wet	D63>W - D=W - D<W63	1-127		●
11					
12					
13					
14					
15	Input Mode	mono/stereo	0-1		
16					

FLANGER1,2,3

No.*	Parameter	Range	Value	→ Tbl	Control
1	LFO Frequency	0.00 - 39.7Hz	0-127	table#1	
2	LFO Depth	0 - 127	0-127		
3	Feedback Level	-63 - +63	1-127		
4	Delay Offset	0 - 63	0-63	table#2	
5					
6	EQ Low Frequency	50Hz - 2.0kHz	8-40	table#3	
7	EQ Low Gain	-12 - +12dB	52-76		
8	EQ High Frequency	500Hz - 16.0kHz	28-58	table#3	
9	EQ High Gain	-12 - +12dB	52-76		
10	Dry/Wet	D63>W - D=W - D<W63	1-127		●
11					
12					
13					
14	LFO Phase Difference	-180 - +180deg	4-124	resolution=3deg	
16					

● Variation Type

HALL1,2, ROOM1,2,3, STAGE1,2, PLATE

No.*	Parameter	Range	Value	→ Tbl	Control
1	Reverb Time	0.3 - 30.0s	0-69	table#4	
2	Diffusion	0 - 10	0-10		
3	Initial Delay	0 - 63	0-63	table#5	
4	HPF Cutoff	Thru - 8.0kHz	0-52	table#3	
5	LPF Cutoff	1.0k - Thru	34-60	table#3	
6					
7					
8					
9					
10	Dry/Wet	D63>W - D=W - D<W63	1-127		●
11	Rev Delay	0 - 63	0-63	table#5	
12	Density	0 - 3	0-3		
13	Er/ Rev Balance	E63> R - E=R - E<R63	1-127		
14					
15	Feedback Level	-63 - +63	1-127		
16					

DELAY L,C,R

No.*	Parameter	Range	Value	→ Tbl	Control
1	Lch Delay	0.1 - 715.0ms	1-7150		
2	Rch Delay	0.1 - 715.0ms	1-7150		
3	Cch Delay	0.1 - 715.0ms	1-7150		
4	Feedback Delay	0.1 - 715.0ms	1-7150		
5	Feedback Level	-63 - +63	1-127		
6	Cch Level	0 - 127	0-127		
7	High Damp	0.1 - 1.0	1-10		
8					
9					
10	Dry/Wet	D63>W - D=W - D<W63	1-127		●
11					
12					
13	EQ Low Frequency	50Hz - 2.0kHz	8-40	table#3	
14	EQ Low Gain	-12 - +12dB	52-76		
15	EQ High Frequency	500Hz - 16.0kHz	28-58	table#3	
16	EQ High Gain	-12 - +12dB	52-76		

DELAY L,R

No.*	Parameter	Range	Value	→ Tbl	Control
1	Lch Delay	0.1 - 715.0ms	1-7150		
2	Rch Delay	0.1 - 715.0ms	1-7150		
3	Feedback Delay 1	0.1 - 715.0ms	1-7150		
4	Feedback Delay 2	0.1 - 715.0ms	1-7150		
5	Feedback Level	-63 - +63	1-127		
6	High Damp	0.1 - 1.0	1-10		
7					
8					
9					
10	Dry/Wet	D63>W - D=W - D<W63	1-127		●
11					
12					
13	EQ Low Frequency	50Hz - 2.0kHz	8-40	table#3	
14	EQ Low Gain	-12 - +12dB	52-76		
15	EQ High Frequency	500Hz - 16.0kHz	28-58	table#3	
16	EQ High Gain	-12 - +12dB	52-76		

ECHO

No.*	Parameter	Range	Value	→ Tbl	Control
1	Lch Delay1	0.1 - 355.0ms	1-3550		
2	Lch Feedback Level	-63 - +63	1-127		
3	Rch Delay1	0.1 - 355.0ms	1-3550		
4	Rch Feedback Level	-63 - +63	1-127		
5	High Damp	0.1 - 1.0	1-10		
6	Lch Delay2	0.1 - 355.0ms	1-3550		
7	Rch Delay2	0.1 - 355.0ms	1-3550		
8	Delay2 Level	0 - 127	0-127		
9					
10	Dry/Wet	D63>W - D=W - D<W63	1-127		●
11					
12					
13	EQ Low Frequency	50Hz - 2.0kHz	8-40	table#3	
14	EQ Low Gain	-12 - +12dB	52-76		
15	EQ High Frequency	500Hz - 16.0kHz	28-58	table#3	
16	EQ High Gain	-12 - +12dB	52-76		

* ● mark : Indicates that AC1 (Assignable Controller 1) can be used to control the parameter when VARIATION = INS.

* No.* : This number corresponds to the PARAMETER numbers in <Table 1-4> (-> page 59)

* →Tbl** : Refer to the "Data/Value Tables" on page 14.

Effect Parameter List

CROSS DELAY

No.*	Parameter	Range	Value	→ Tbl	Control
1	L→R Delay	0.1 – 355.0ms	1-3550		
2	R→L Delay	0.1 – 355.0ms	1-3550		
3	Feedback Level	-63 – +63	1-127		
4	Input Select	L,R,L&R	0-2		
5	High Damp	0.1 – 1.0	1-10		
6					
7					
8					
9					
10	Dry/Wet	D63>W – D=W – D<W63	1-127		●
11					
12					
13	EQ Low Frequency	50Hz – 2.0kHz	8-40	table#3	
14	EQ Low Gain	-12 – +12dB	52-76		
15	EQ High Frequency	500Hz – 16.0kHz	28-58	table#3	
16	EQ High Gain	-12 – +12dB	52-76		

EARLY REF1,2

No.*	Parameter	Range	Value	→ Tbl	Control
1	Type	S-H, L-H, Rdm, Rvs, Plt, Spr	0-5		
2	Room Size	0.1 – 7.0	0-44	table#6	
3	Diffusion	0 – 10	0-10		
4	Initial Delay	0 – 63	0-63	table#5	
5	Feedback Level	-63 – +63	1-127		
6	HPF Cutoff	Thru – 8.0kHz	0-52		
7	LPF Cutoff	1.0k – Thru	34-60		
8					
9					
10	Dry/Wet	D63>W – D=W – D<W63	1-127		●
11	Liveness	0 – 10	0-10		
12	Density	0 – 3	0-3		
13	High Damp	0.1 – 1.0	1-10		
14					
15					
16					

GATE REVERB, REVERSE GATE

No.*	Parameter	Range	Value	→ Tbl	Control
1	Type	TypeA, TypeB	0-1		
2	Room Size	0.1 – 7.0	0-44	table#6	
3	Diffusion	0 – 10	0-10		
4	Initial Delay	0 – 63	0-63	table#5	
5	Feedback Level	-63 – +63	1-127		
6	HPF Cutoff	Thru – 8.0kHz	0-52		
7	LPF Cutoff	1.0k – Thru	34-60		
8					
9					
10	Dry/Wet	D63>W – D=W – D<W63	1-127		●
11	Liveness	0 – 10	0-10		
12	Density	0 – 3	0-3		
13	High Damp	0.1 – 1.0	1-10		
14					
15					
16					

KARAOKE1,2,3

No.*	Parameter	Range	Value	→ Tbl	Control
1	Delay Time	0 – 127	0-127	table#7	
2	Feedback Level	-63 – +63	1-127		
3	HPF Cutoff	Thru – 8.0kHz	0-52		
4	LPF Cutoff	1.0k – Thru	34-60		
5					
6					
7					
8					
9					
10	Dry/Wet	D63>W – D=W – D<W63	1-127		●
11					
12					
13					
14					
15					
16					

CHORUS1,2,3,4, CELESTE1,2,3,4

No.*	Parameter	Range	Value	→ Tbl	Control
1	LFO Frequency	0.00 – 39.7Hz	0-127	table#1	
2	LFO PM Depth	0 – 127	0-127		
3	Feedback Level	-63 – +63	1-127		
4	Delay Offset	0 – 127	0-127	table#2	
5					
6	EQ Low Frequency	50Hz – 2.0kHz	8-40	table#3	
7	EQ Low Gain	-12 – +12dB	52-76		
8	EQ High Frequency	500Hz – 16.0kHz	28-58	table#3	
9	EQ High Gain	-12 – +12dB	52-76		
10	Dry/Wet	D63>W – D=W – D<W63	1-127		●
11					
12					
13					
14					
15	Input Mode	mono/stereo	0-1		
16					

FLANGER1,2,3

No.*	Parameter	Range	Value	→ Tbl	Control
1	LFO Frequency	0.00 – 39.7Hz	0-127	table#1	
2	LFO Depth	0 – 127	0-127		
3	Feedback Level	-63 – +63	1-127		
4	Delay Offset	0 – 63	0-63	table#2	
5					
6	EQ Low Frequency	50Hz – 2.0kHz	8-40	table#3	
7	EQ Low Gain	-12 – +12dB	52-76		
8	EQ High Frequency	500Hz – 16.0kHz	28-58	table#3	
9	EQ High Gain	-12 – +12dB	52-76		
10	Dry/Wet	D63>W – D=W – D<W63	1-127		●
11					
12					
13					
14					
15	LFO Phase Difference	-180 – +180deg	4-124	resolution=3step	
16					

SYMPHONIC

No.*	Parameter	Range	Value	→ Tbl	Control
1	LFO Frequency	0.00 – 39.7Hz	0-127	table#1	
2	LFO Depth	0 – 127	0-127		
3	Delay Offset	0 – 127	0-127	table#2	
4					
5					
6	EQ Low Frequency	50Hz – 2.0kHz	8-40	table#3	
7	EQ Low Gain	-12 – +12dB	52-76		
8	EQ High Frequency	500Hz – 16.0kHz	28-58	table#3	
9	EQ High Gain	-12 – +12dB	52-76		
10	Dry/Wet	D63>W – D=W – D<W63	1-127		●
11					
12					
13					
14					
15					
16					

ROTARY SPEAKER

No.*	Parameter	Range	Value	→ Tbl	Control
1	LFO Frequency	0.00 – 39.7Hz	0-127	table#1	●
2	LFO Depth	0 – 127	0-127		
3					
4					
5					
6	EQ Low Frequency	50Hz – 2.0kHz	8-40	table#3	
7	EQ Low Gain	-12 – +12dB	52-76		
8	EQ High Frequency	500Hz – 16.0kHz	28-58	table#3	
9	EQ High Gain	-12 – +12dB	52-76		
10	Dry/Wet	D63>W – D=W – D<W63	1-127		●
11					
12					
13					
14					
15					
16					

* ● mark : Indicates that AC1 (Assignable Controller 1) can be used to control the parameter when VARIATION = INS.

* No.* : This number corresponds to the PARAMETER numbers in <Table 1-4> (-> page 59)

* →Tbl** : Refer to the "Data/Value Tables" on page 14.

Effect Parameter List

● Variation Type

TREMOLO

No.*	Parameter	Range	Value	→ Tbl	Control
1	LFO Frequency	0.00 – 39.7Hz	0-127	table#1	●
2	AM Depth	0 – 127	0-127		
3	PM Depth	0 – 127	0-127		
4					
5					
6	EQ Low Frequency	50Hz – 2.0kHz	8-40	table#3	
7	EQ Low Gain	-12 – +12dB	52-76		
8	EQ High Frequency	500Hz – 16.0kHz	28-58	table#3	
9	EQ High Gain	-12 – +12dB	52-76		
10					
11					
12					
13					
14	LFO Phase Difference	-180 – +180deg	4-124	resolution=3deg	
15	Input Mode	mono/stereo	0-1		
16					

AUTO PAN

No.*	Parameter	Range	Value	→ Tbl	Control
1	LFO Frequency	0.00 – 39.7Hz	0-127	table#1	●
2	L/R Depth	0 – 127	0-127		
3	F/R Depth	0 – 127	0-127		
4	PAN Direction	L<->R,L>->R,L<->R,Lturn,Rturn,L/R	0-5		
5					
6	EQ Low Frequency	50Hz – 2.0kHz	8-40	table#3	
7	EQ Low Gain	-12 – +12dB	52-76		
8	EQ High Frequency	500Hz – 16.0kHz	28-58	table#3	
9	EQ High Gain	-12 – +12dB	52-76		
10					
11					
12					
13					
14					
15					
16					

PHASER1,2

No.*	Parameter	Range	Value	→ Tbl	Control
1	LFO Frequency	0.00 – 39.7Hz	0-127	table#1	
2	LFO Depth	0 – 127	0-127		
3	Phase Shift Offset	0 – 127	0-127		
4	Feedback Level	-63 – +63	1-127		
5					
6	EQ Low Frequency	50Hz – 2.0kHz	8-40	table#3	
7	EQ Low Gain	-12 – +12dB	52-76		
8	EQ High Frequency	500Hz – 16.0kHz	28-58	table#3	
9	EQ High Gain	-12 – +12dB	52-76		
10	Dry/Wet	D63>W – D<W – D<W63	1-127		●
11	Stage	6 – 10(phaser1) / 3 – 5(phaser2)	3-10		
12					
13					
14					
15					
16					

DISTORTION, OVERDRIVE

No.*	Parameter	Range	Value	→ Tbl	Control
1	Drive	0 – 127	0-127		●
2	EQ Low Frequency	50Hz – 2.0kHz	8-40	table#3	
3	EQ Low Gain	-12 – +12dB	52-76		
4	LPF Cutoff	1.0k – Thru	34-60	table#3	
5	Output Level	0 – 127	0-127		
6					
7	EQ Mid Frequency	500Hz – 10.0kHz	28-54	table#3	
8	EQ Mid Gain	-12 – +12dB	52-76		
9	EQ Mid Width	1.0 – 12.0	10-120		
10	Dry/Wet	D63>W – D=W – D<W63	1-127		
11	Edge(Clip Curve)	0 – 127	0-127	mild – sharp	
12					
13					
14					
15					
16					

GUITAR AMP SIMULATOR

No.*	Parameter	Range	Value	→ Tbl	Control
1	Drive	0 – 127	0-127		●
2	AMP Type	Off,Stack,Combo,Tube	0-3		
3	LPF Cutoff	1.0k – Thru	34-60	table#3	
4	Output Level	0 – 127	0-127		
5					
6					
7					
8					
9					
10	Dry/Wet	D63>W – D=W – D<W63	1-127		
11	Edge(Clip Curve)	0 – 127	0-127	mild – sharp	
12					
13					
14					
15					
16					

3-BAND EQ

No.*	Parameter	Range	Value	→ Tbl	Control
1	EQ Low Gain	-12 – +12dB	52-76		
2	EQ Mid Frequency	500Hz – 10.0kHz	28-54	table#3	
3	EQ Mid Gain	-12 – +12dB	52-76		
4	EQ Mid Width	1.0 – 12.0	10-120		
5	EQ High Gain	-12 – +12dB	52-76		
6	EQ Low Frequency	50Hz – 2.0kHz	8-40	table#3	
7	EQ High Frequency	500Hz – 16.0kHz	28-58	table#3	
8					
9					
10					
11					
12					
13					
14					
15					
16					

2-BAND EQ

No.*	Parameter	Range	Value	→ Tbl	Control
1	EQ Low Frequency	50Hz – 2.0kHz	8-40	table#3	
2	EQ Low Gain	-12 – +12dB	52-76		
3	EQ High Frequency	500Hz – 16.0kHz	28-58	table#3	
4	EQ High Gain	-12 – +12dB	52-76		
5					
6					
7					
8					
9					
10					
11					
12					
13					
14					
15					
16					

AUTO WAH

No.*	Parameter	Range	Value	→ Tbl	Control
1	LFO Frequency	0.00 – 39.7Hz	0-127	table#1	
2	LFO Depth	0 – 127	0-127		●
3	Cutoff Frequency Offset	0 – 127	0-127		
4	Resonance	1.0 – 12.0	10-120		
5					
6	EQ Low Frequency	50Hz – 2.0kHz	8-40	table#3	
7	EQ Low Gain	-12 – +12dB	52-76		
8	EQ High Frequency	500Hz – 16.0kHz	28-58	table#3	
9	EQ High Gain	-12 – +12dB	52-76		
10	Dry/Wet	D63>W – D=W – D<W63	1-127		
11					
12					
13					
14					
15					
16					

* ● mark : Indicates that AC1 (Assignable Controller 1) can be used to control the parameter when VARIATION = INS.

* No.* : This number corresponds to the PARAMETER numbers in <Table 1-4> (-> page 59)

* →Tbl** : Refer to the "Data/Value Tables" on page 14.

Preset Style List

No.	Category	Display	Full Name
001	Rock	Mixture	Hardcore Mixture
002		80sMxt	80's Mixture Rock
003		HardCore	Hard Core Punk
004		MeloCore	Melodious Core
005		SkaCore	Ska Core
006		RkBoogie	Rock Boogie
007		GrungeRk	Grunge Rock
008		MondoRk	Mondo Rock
009		IrishRk	80's Irish Rock
010		BritRock	British Rock
011		RckShuffl	80's Rock Shuffle
012		CollgeRk	College Rock
013		GlamRock	Glam Rock
014		70sRock	70's Rock
015		FolkRock	70's 8-beat Folk Rock
016		ArtRock	70's Art Rock
017		PunkRock	70's Punk Rock
018		PubRock	Pub Rock
019		FunkRock	Funk Rock
020		LatinRk	Latin Rock
021	Hard Rock	60sHard	60's Hard Rock
022		70sHard1	70's Hard Rock1
023		70sHard2	70's Hard Rock2
024		70sHR&R	70's Hard Rock & Roll
025		16btHard	16-beat Hard Rock
026		AmercHR1	American Hard Rock1
027		AmercHR2	American Hard Rock2
028		ProgHard	90's Progressive Hard
029	Metal	SpeedMtl	Speed Metal
030		PowerMtl	Power Metal
031		Thrash	Thrash Metal
032		DoomMtl	Doom Metal
033		MtlBoogie	Metal Boogie
034	Hip Hop	Hip Hop1	Hip Hop1
035		Hip Hop2	Hip Hop2
036		Pop Hip	Pop Hip Hop
037		Gangsta	Gangsta
038		Rap	Rap
039		Jazz Hip	Jazz Hip Hop
040	Dance	DanceSwg	Dance Swing
041		House	House
042		GrgHouse	Garage House
043		R&BSwing	90's R&B Swing
044		Slow Jam	90's R&B Slow Jam
045		Pop R&B	90's Pop R&B
046		Smooth	90's R&B Smooth
047		PopTekno	Pop Techno
048		EuroTek	Euro Techno
049		Eurobeat	Eurobeat
050		ElectrRk	Electro Rock
051		Bigbeat	Bigbeat
052		DigiRk1	Digital Rock1
053		DigiRk2	Digital Rock2
054		IndustrRk	Industrial Rock
055	PsychRk	Psychedelic Rock	
056	Pop	Lite Pop	Light Pop
057		AOR Pop	A.O.R. Pop
058		LatinPop	Latin Pop
059		BritPop	80's British Pop
060		16bt Pop	16-beat Pop
061		24bt Pop	24-beat Pop
062		TechFusn	80's Technical Fusion
063		DetroPop	Detroit Pop Shuffle
064		Mid8btRk	Med-tempo 8-beat Rock Pop
065		Acoustic	Acoustic Pop

No.	Category	Display	Full Name
066	Rhythm & Blues	R&B	R&B
067		6/8 R&B	6/8 R&B
068		SoulShf	Soul Shuffle
069		Motown	Motown
070		SlwBlues	Slow Blues
071		R&B Wlz	R&B Waltz
072		Rock R&B	Rock R&B
073	Rock & Roll	RocknRol	Rock'n' Roll
074		TrainTm	Train Time
075		Rockably	Rockability
076		Oldies	Oldies
077		Liverpol	Liverpool Pop
078	SurfRock	Surf Rock	
079	Funk	DscFunk	Disco Funk
080		70sDisco	70's Disco
081		FP Funk	FP Funk
082		JB Funk	JB Funk
083	JazzFunk	Jazz Funk	
084	Jazz	ComboJz	Combo Jazz
085		Big Band	Big Band Jazz
086		JazBalld	Jazz Ballad
087		JazWaltz	Jazz Waltz
088		Bebop	Fast Bebop
089		CoolJazz	Cool Jazz
090	AfroJazz	Afro Jazz	
091	Ballad	OrgBalld	Organ Ballad
092		PnoBalld	Piano Ballad
093		ArpBalld	Arpeggio Ballad
094		LatinBid	Latin Ballad
095		6/8Balld	6/8 Modern Ballad
096	HR Balld	Hard Rock Ballad	
097	6/8HRBid	6/8 Hard Rock Ballad	
098	Country & Western	CW Rock	Country Rock
099		CW Pop	Country Pop
100		16Contry	16-beat Country Rock
101		CW Balld	Country Ballad
102		CW Waltz	Country Waltz
103	Bluegras	Bluegrass	
104	Latin	Samba	Samba
105		Mambo	Mambo
106		Rhumba	Rhumba
107		Merengue	Merengue
108		Cha Cha	Cha Cha
109		Salsa	Salsa
110		Bossa	Bossa Nova
111		Beguín	Beguín
112	Tango	Tango	
113	Reggae	Reggae	Reggae
114		SwReggae	Swing Reggae
115		DHRReggae	Dance Hall Reggae
116		LoversRk	Lovers Rock
117		Ska	Ska
118	World	Hawaiian	Hawaiian
119		Soca	Soca
120		Klezmer	Klezmer
121		Enka	Enka
122		Polka	Polka
123		Dixie	Dixieland
124		Foxtrot	Foxtrot
125		ViennaWlz	Vienna Waltz
126		SlowWalz	Slow Waltz
127		March	March
128	6/8March	6/8 March	
000		--OFF--	OFF

Preset Phrase List

Phrase Category=Ba: Bass-a (Pop&Rock) Beat=8 beat

Phrase Category	Description
Ba	Bass-a (Pop&Rock)
Bb	Bass-b (Specific)
BR	Brass
Da	Drum-a (Pop&Rock)
Db	Drum-b (Specific)
Fa	Drum Fill-a (Pop&Rock)
Fb	Drum Fill-b (Specific)
Ga	Guitar Chord-a (Pop&Rock)
Gb	Guitar Chord-b (Specific)
GR	Guitar Riff
KC	Keyboard Chord
KR	Keyboard Riff
PC	Percussion
PD	Pad
SE	Sound Effects

Note: Phrases that have "I" or "E" as the last character of the Phrase Name cannot be converted to chord types.

No.	Name	No.	Name	No.	Name
001	Mixt -I	065	ArtRk-I	129	SlwJm-a
002	Mixt -a	066	ArtRk-a	130	SlwJm-b
003	Mixt -b	067	ArtRk-b	131	SlwJm-c
004	Mixt -c	068	ArtRk-c	132	SlwJm-d
005	Mixt -d	069	ArtRk-d	133	SlwJm-E
006	Mixt -E	070	ArtRk-E	134	PpR&B-I
007	HdCor-a	071	PnkRk-I	135	PpR&B-a
008	HdCor-b	072	PnkRk-a	136	PpR&B-b
009	HdCor-c	073	PnkRk-b	137	PpR&B-c
010	HdCor-d	074	PnkRk-c	138	PpR&B-d
011	HdCor-E	075	PnkRk-d	139	PpR&B-E
012	MICor-I	076	PnkRk-E	140	Bigbt-a
013	MICor-a	077	PubRk-I	141	Bigbt-b
014	MICor-b	078	PubRk-a	142	Bigbt-c
015	MICor-c	079	PubRk-b	143	PycRk-I
016	MICor-E	080	PubRk-c	144	PycRk-a
017	SkCor-I	081	PubRk-d	145	PycRk-b
018	SkCor-a	082	PubRk-E	146	PycRk-c
019	SkCor-b	083	60Hd -I	147	PycRk-d
020	SkCor-c	084	60Hd -a	148	PycRk-E
021	SkCor-d	085	60Hd -b	149	LitPp-I
022	SkCor-E	086	60Hd -c	150	LitPp-a
023	RkBgy-I	087	60Hd -d	151	LitPp-b
024	RkBgy-a	088	60Hd -E	152	LitPp-c
025	RkBgy-b	089	70Hd2-I	153	LitPp-d
026	RkBgy-c	090	70Hd2-a	154	LitPp-E
027	RkBgy-d	091	70Hd2-b	155	AORPp-I
028	RkBgy-E	092	70Hd2-c	156	AORPp-a
029	MndRk-I	093	70Hd2-d	157	AORPp-b
030	MndRk-a	094	70Hd2-E	158	AORPp-c
031	MndRk-b	095	70H&R-I	159	AORPp-d
032	MndRk-c	096	70H&R-a	160	AORPp-E
033	MndRk-d	097	70H&R-b	161	BrtPp-I
034	MndRk-E	098	70H&R-c	162	BrtPp-a
035	BrtRk-I	099	70H&R-d	163	BrtPp-b
036	BrtRk-a	100	70H&R-E	164	BrtPp-c
037	BrtRk-b	101	AmHR1-I	165	BrtPp-d
038	BrtRk-c	102	AmHR1-a	166	BrtPp-E
039	BrtRk-d	103	AmHR1-b	167	DtrPp-I
040	BrtRk-E	104	AmHR1-c	168	DtrPp-a
041	RkShf-I	105	AmHR1-d	169	DtrPp-b
042	RkShf-a	106	AmHR1-E	170	DtrPp-c
043	RkShf-b	107	AmHR2-I	171	DtrPp-d
044	RkShf-c	108	AmHR2-a	172	DtrPp-E
045	RkShf-d	109	AmHR2-b	173	Md8Rk-I
046	RkShf-E	110	AmHR2-c	174	Md8Rk-a
047	GlmRk-I	111	AmHR2-d	175	Md8Rk-b
048	GlmRk-a	112	AmHR2-E	176	Md8Rk-c
049	GlmRk-b	113	HipH2-I	177	Md8Rk-d
050	GlmRk-c	114	HipH2-a	178	Acost-I
051	GlmRk-d	115	HipH2-b	179	Acost-a
052	GlmRk-E	116	HipH2-c	180	Acost-b
053	70sRk-I	117	HipH2-d	181	Acost-c
054	70sRk-a	118	HipH2-E	182	Acost-d
055	70sRk-b	119	Rap -1I	183	Acost-E
056	70sRk-c	120	Rap -2I		
057	70sRk-d	121	Rap -a		
058	70sRk-E	122	Rap -b		
059	FlkRk-I	123	Rap -1c		
060	FlkRk-a	124	Rap -2c		
061	FlkRk-b	125	Rap -d		
062	FlkRk-c	126	Rap -1E		
063	FlkRk-d	127	Rap -2E		
064	FlkRk-E	128	SlwJm-I		

Beat=16 beat

No.	Name	No.	Name	No.	Name
001	80MRk-l	065	PwrMt-E	129	Smoth-c
002	80MRk-a	066	Thrsh-l	130	Smoth-d
003	80MRk-b	067	Thrsh-a	131	Smoth-E
004	80MRk-c	068	Thrsh-b	132	PpTek-l
005	80MRk-d	069	Thrsh-c	133	PpTek-a
006	80MRk-E	070	Thrsh-d	134	PpTek-d
007	GrnRk-l	071	Thrsh-E	135	PpTek-E
008	GrnRk-a	072	DooMt-l	136	EuTek-l
009	GrnRk-b	073	DooMt-a	137	EuTek-a
010	GrnRk-c	074	DooMt-b	138	EuTek-c
011	GrnRk-d	075	DooMt-c	139	EuTek-E
012	GrnRk-E	076	DooMt-d	140	Eurbt-a
013	IrsRk-l	077	DooMt-E	141	Eurbt-c
014	IrsRk-a	078	MtBgy-l	142	ElcRk-a
015	IrsRk-b	079	MtBgy-a	143	ElcRk-b
016	IrsRk-c	080	MtBgy-b	144	ElcRk-c
017	IrsRk-d	081	MtBgy-c	145	ElcRk-d
018	IrsRk-E	082	MtBgy-d	146	ElcRk-E
019	ClgRk-l	083	MtBgy-E	147	DgRk1-l
020	ClgRk-a	084	HipH1-l	148	DgRk1-a
021	ClgRk-c	085	HipH1-a	149	DgRk1-b
022	ClgRk-d	086	HipH1-b	150	DgRk1-E
023	ClgRk-E	087	HipH1-c	151	DgRk2-l
024	FnkRk-l	088	HipH1-d	152	DgRk2-a
025	FnkRk-a	089	HipH1-E	153	DgRk2-b
026	FnkRk-b	090	PpHip-a	154	DgRk2-c
027	FnkRk-c	091	PpHip-b	155	DgRk2-d
028	FnkRk-d	092	PpHip-c	156	DgRk2-E
029	FnkRk-E	093	PpHip-d	157	IndRk-l
030	LtnRk-l	094	PpHip-E	158	IndRk-a
031	LtnRk-a	095	Gngst-l	159	IndRk-b
032	LtnRk-b	096	Gngst-a	160	IndRk-c
033	LtnRk-c	097	Gngst-c	161	IndRk-d
034	LtnRk-d	098	Gngst-E	162	LtnPp-l
035	LtnRk-E	099	JzHip-l	163	LtnPp-a
036	70Hd1-l	100	JzHip-a	164	LtnPp-b
037	70Hd1-a	101	JzHip-b	165	LtnPp-c
038	70Hd1-b	102	JzHip-c	166	LtnPp-d
039	70Hd1-c	103	JzHip-d	167	LtnPp-E
040	70Hd1-d	104	JzHip-E	168	16bPp-l
041	70Hd1-E	105	DncSw-l	169	16bPp-a
042	16bHd-l	106	DncSw-a	170	16bPp-b
043	16bHd-a	107	DncSw-b	171	16bPp-c
044	16bHd-b	108	DncSw-c	172	16bPp-d
045	16bHd-c	109	DncSw-d	173	16bPp-E
046	16bHd-d	110	DncSw-E	174	24bPp-l
047	16bHd-E	111	House-l	175	24bPp-a
048	PrgHd-l	112	House-a	176	24bPp-b
049	PrgHd-a	113	House-c	177	24bPp-c
050	PrgHd-b	114	House-E	178	24bPp-d
051	PrgHd-c	115	GrgHs-a	179	24bPp-E
052	PrgHd-d	116	GrgHs-b	180	TcFsn-l
053	PrgHd-E	117	GrgHs-c	181	TcFsn-a
054	SpdMt-l	118	GrgHs-d	182	TcFsn-b
055	SpdMt-a	119	GrgHs-E	183	TcFsn-c
056	SpdMt-b	120	R&BSw-l	184	TcFsn-d
057	SpdMt-c	121	R&BSw-a	185	TcFsn-E
058	SpdMt-d	122	R&BSw-b		
059	SpdMt-E	123	R&BSw-c		
060	PwrMt-l	124	R&BSw-d		
061	PwrMt-a	125	R&BSw-E		
062	PwrMt-b	126	Smoth-l		
063	PwrMt-c	127	Smoth-a		
064	PwrMt-d	128	Smoth-b		

Beat=3/4 beat

No.	Name
001	R&BWz-l
002	R&BWz-a
003	R&BWz-b
004	R&BWz-c
005	R&BWz-d
006	R&BWz-E

Phrase Category=Bb: Bass-b (Specific)
Beat=8 beat

Beat=16 beat

No.	Name	No.	Name	No.	Name
001	R&B -I	065	JzBlD-b	129	ChaCh-a
002	R&B -a	066	JzBlD-c	130	ChaCh-b
003	R&B -b	067	JzBlD-d	131	ChaCh-c
004	R&B -c	068	JzBlD-E	132	ChaCh-d
005	R&B -d	069	PnBlD-I	133	ChaCh-E
006	R&B -E	070	PnBlD-a	134	Bossa-I
007	68R&B-I	071	PnBlD-b	135	Bossa-a
008	68R&B-a	072	PnBlD-c	136	Bossa-b
009	68R&B-b	073	PnBlD-d	137	Bossa-c
010	68R&B-E	074	PnBlD-E	138	Bossa-d
011	Motwn-I	075	ArpBd-I	139	Bossa-E
012	Motwn-a	076	ArpBd-a	140	Begin-I
013	Motwn-b	077	ArpBd-b	141	Begin-a
014	Motwn-c	078	ArpBd-c	142	Begin-b
015	Motwn-d	079	ArpBd-d	143	Begin-c
016	Motwn-E	080	ArpBd-E	144	Begin-d
017	SIBlu-I	081	68BlD-I	145	Begin-E
018	SIBlu-a	082	68BlD-a	146	Tango-I
019	SIBlu-b	083	68BlD-b	147	Tango-a
020	SIBlu-c	084	68BlD-c	148	Tango-b
021	SIBlu-d	085	68BlD-d	149	Tango-c
022	SIBlu-E	086	68BlD-E	150	Tango-d
023	RkR&B-I	087	HRBlD-I	151	Tango-E
024	RkR&B-a	088	HRBlD-a	152	Ska -I
025	RkR&B-b	089	HRBlD-b	153	Ska -a
026	RkR&B-c	090	HRBlD-c	154	Ska -c
027	RkR&B-d	091	HRBlD-d	155	Ska -d
028	RkR&B-E	092	HRBlD-E	156	Ska -E
029	RknRI-I	093	68HBd-I	157	Hwian-I
030	RknRI-a	094	68HBd-a	158	Hwian-a
031	RknRI-b	095	68HBd-b	159	Hwian-b
032	RknRI-c	096	68HBd-c	160	Hwian-c
033	RknRI-d	097	68HBd-d	161	Hwian-d
034	RknRI-E	098	68HBd-E	162	Hwian-E
035	Rcbly-I	099	CWRk -I	163	Klzmr-a
036	Rcbly-a	100	CWRk -a	164	Klzmr-b
037	Rcbly-b	101	CWRk -b	165	Klzmr-c
038	Rcbly-c	102	CWRk -c	166	Klzmr-d
039	Rcbly-d	103	CWRk -d	167	Klzmr-E
040	Rcbly-E	104	CWRk -E	168	Enka -I
041	Oldis-I	105	CWPop-I	169	Enka -a
042	Oldis-a	106	CWPop-a	170	Enka -b
043	Oldis-c	107	CWPop-c	171	Enka -c
044	Oldis-E	108	CWPop-d	172	Enka -d
045	Liver-I	109	CWPop-E	173	Enka -E
046	Liver-a	110	CWBlD-I	174	Polka-I
047	Liver-b	111	CWBlD-a	175	Polka-a
048	Liver-c	112	CWBlD-b	176	Polka-b
049	Liver-d	113	CWBlD-c	177	Polka-c
050	Liver-E	114	CWBlD-d	178	Polka-d
051	SufRk-I	115	CWBlD-E	179	Polka-E
052	SufRk-a	116	Blgrs-I	180	Dixie-I
053	SufRk-b	117	Blgrs-a	181	Dixie-a
054	SufRk-c	118	Blgrs-b	182	Dixie-b
055	SufRk-d	119	Blgrs-c	183	Dixie-c
056	SufRk-E	120	Blgrs-d	184	Dixie-E
057	DscFk-I	121	Blgrs-E	185	Foxtr-I
058	DscFk-a	122	Rumba-I	186	Foxtr-a
059	DscFk-b	123	Rumba-a	187	Foxtr-b
060	DscFk-c	124	Rumba-b	188	Foxtr-c
061	DscFk-d	125	Rumba-c	189	Foxtr-d
062	DscFk-E	126	Rumba-d	190	Foxtr-E
063	JzBlD-I	127	Rumba-E	191	March-I
064	JzBlD-a	128	ChaCh-I	192	March-a

No.	Name	No.	Name	No.	Name
001	SoShf-I	065	AfrJz-E	129	Soca-I
002	SoShf-a	066	OrgBd-I	130	Soca -a
003	SoShf-b	067	OrgBd-a	131	Soca -b
004	SoShf-c	068	OrgBd-b	132	Soca -c
005	SoShf-d	069	OrgBd-c	133	Soca -d
006	SoShf-E	070	OrgBd-d	134	Soca -E
007	TrnTm-I	071	OrgBd-E		
008	TrnTm-a	072	LtnBd-I		
009	TrnTm-b	073	LtnBd-a		
010	TrnTm-c	074	LtnBd-b		
011	TrnTm-d	075	LtnBd-c		
012	TrnTm-E	076	LtnBd-d		
013	70Dsc-I	077	LtnBd-E		
014	70Dsc-a	078	16Cnt-I		
015	70Dsc-b	079	16Cnt-a		
016	70Dsc-c	080	16Cnt-b		
017	70Dsc-d	081	16Cnt-c		
018	70Dsc-E	082	16Cnt-d		
019	FPFnk-I	083	16Cnt-E		
020	FPFnk-a	084	Samba-a		
021	FPFnk-b	085	Samba-b		
022	FPFnk-c	086	Samba-c		
023	FPFnk-d	087	Samba-d		
024	FPFnk-E	088	Samba-E		
025	JBfNk-I	089	Mambo-I		
026	JBfNk-a	090	Mambo-a		
027	JBfNk-b	091	Mambo-b		
028	JBfNk-c	092	Mambo-c		
029	JBfNk-d	093	Mambo-d		
030	JBfNk-E	094	Merng-I		
031	JzFnk-I	095	Merng-a		
032	JzFnk-a	096	Merng-b		
033	JzFnk-b	097	Merng-c		
034	JzFnk-c	098	Merng-d		
035	JzFnk-d	099	Salsa-I		
036	JzFnk-E	100	Salsa-a		
037	Combz-I	101	Salsa-b		
038	Combz-a	102	Salsa-c		
039	Combz-b	103	Salsa-d		
040	Combz-c	104	Salsa-E		
041	Combz-d	105	Regae-I		
042	Combz-E	106	Regae-a		
043	BgBnd-I	107	Regae-b		
044	BgBnd-a	108	Regae-c		
045	BgBnd-b	109	Regae-d		
046	BgBnd-c	110	Regae-E		
047	BgBnd-d	111	SwRge-I		
048	BgBnd-E	112	SwRge-a		
049	Bebop-I	113	SwRge-b		
050	Bebop-a	114	SwRge-c		
051	Bebop-b	115	SwRge-d		
052	Bebop-c	116	SwRge-E		
053	Bebop-d	117	DHRge-I		
054	Bebop-E	118	DHRge-a		
055	ColJz-I	119	DHRge-b		
056	ColJz-a	120	DHRge-c		
057	ColJz-b	121	DHRge-d		
058	ColJz-c	122	DHRge-E		
059	ColJz-d	123	LvsRk-I		
060	ColJz-E	124	LvsRk-a		
061	AfrJz-I	125	LvsRk-b		
062	AfrJz-a	126	LvsRk-c		
063	AfrJz-b	127	LvsRk-d		
064	AfrJz-c	128	LvsRk-E		

Phrase Category=BR: Brass
Beat=8 beat

Beat=3/4 beat

No.	Name
001	JzWlz-I
002	JzWlz-a
003	JzWlz-b
004	JzWlz-c
005	JzWlz-d
006	JzWlz-E
007	CWWlz-I
008	CWWlz-a
009	CWWlz-b
010	CWWlz-c
011	CWWlz-d
012	CWWlz-E
013	VnWlz-I
014	VnWlz-a
015	VnWlz-b
016	VnWlz-c
017	VnWlz-d
018	VnWlz-E
019	SIWlz-I
020	SIWlz-a
021	SIWlz-b
022	SIWlz-c
023	SIWlz-d
024	SIWlz-E
025	68Mrc-I
026	68Mrc-a
027	68Mrc-c
028	68Mrc-d
029	68Mrc-E

No.	Name	No.	Name
001	70sRk-E	065	Ska -2c
002	R&B -1I	066	Ska -3c
003	R&B -2I	067	Ska -1d
004	R&B -1b	068	Ska -2d
005	R&B -2b	069	Ska -1E
006	R&B -1c	070	Ska -2E
007	R&B -2c	071	Ska -3E
008	R&B -1d	072	Klzmr-1a
009	R&B -2d	073	Klzmr-2a
010	R&B -1E	074	Klzmr-1b
011	R&B -2E	075	Klzmr-2b
012	68R&B-I	076	Klzmr-1c
013	68R&B-b	077	Klzmr-2c
014	68R&B-c	078	Klzmr-1d
015	68R&B-d	079	Klzmr-2d
016	68R&B-E	080	Klzmr-1E
017	Motwn-I	081	Klzmr-2E
018	Motwn-a	082	Polka-I
019	Motwn-b	083	Polka-a
020	Motwn-c	084	Polka-b
021	Motwn-d	085	Polka-c
022	Motwn-E	086	Polka-d
023	SIBlu-1I	087	Polka-E
024	SIBlu-2I	088	Dixie-1I
025	SIBlu-1d	089	Dixie-2I
026	SIBlu-2d	090	Dixie-1a
027	SIBlu-1E	091	Dixie-2a
028	SIBlu-2E	092	Dixie-1b
029	RkR&B-I	093	Dixie-2b
030	RkR&B-b	094	Dixie-1c
031	RkR&B-d	095	Dixie-2c
032	RkR&B-E	096	Dixie-1d
033	Oldis-I	097	Dixie-2d
034	Oldis-a	098	Dixie-1E
035	Oldis-c	099	Dixie-2E
036	Oldis-E	100	Foxtr-I
037	DscFk-I	101	Foxtr-b
038	DscFk-c	102	Foxtr-c
039	DscFk-d	103	Foxtr-E
040	DscFk-E	104	March-1I
041	ChaCh-1I	105	March-2I
042	ChaCh-2I	106	March-3I
043	ChaCh-1b	107	March-I
044	ChaCh-2b	108	March-1a
045	ChaCh-c	109	March-2a
046	ChaCh-1d	110	March-3a
047	ChaCh-2d	111	March-a
048	ChaCh-1E	112	March-1b
049	ChaCh-2E	113	March-2b
050	Begin-I	114	March-3b
051	Begin-b	115	March-b
052	Begin-c	116	March-1c
053	Begin-d	117	March-2c
054	Begin-E	118	March-3c
055	Tango-I	119	March-c
056	Tango-E	120	March-1d
057	Ska -1I	121	March-2d
058	Ska -2I	122	March-3d
059	Ska -3I	123	March-d
060	Ska -1a	124	March-1E
061	Ska -2a	125	March-2E
062	Ska -1b	126	March-3E
063	Ska -2b	127	March-E
064	Ska -1c		

Beat=16 beat

No.	Name	No.	Name
001	FnkRk-I	065	ColJz-2b
002	FnkRk-b	066	ColJz-1c
003	FnkRk-d	067	ColJz-2c
004	FnkRk-E	068	ColJz-1d
005	PpHip-a	069	ColJz-2d
006	LtnPp-I	070	ColJz-1E
007	LtnPp-a	071	ColJz-2E
008	LtnPp-b	072	AfrJz-1I
009	LtnPp-c	073	AfrJz-2I
010	LtnPp-d	074	AfrJz-3I
011	LtnPp-E	075	AfrJz-1b
012	TcFsn-I	076	AfrJz-2b
013	TcFsn-b	077	AfrJz-3b
014	TcFsn-c	078	AfrJz-1d
015	TcFsn-d	079	AfrJz-2d
016	TcFsn-E	080	AfrJz-3d
017	SoShf-b	081	AfrJz-1E
018	SoShf-c	082	AfrJz-2E
019	SoShf-E	083	AfrJz-3E
020	70Dsc-I	084	Mambo-1I
021	70Dsc-b	085	Mambo-2I
022	70Dsc-c	086	Mambo-1a
023	70Dsc-d	087	Mambo-2a
024	70Dsc-E	088	Mambo-1b
025	JBFnk-1I	089	Mambo-2b
026	JBFnk-2I	090	Mambo-1c
027	JBFnk-1a	091	Mambo-2c
028	JBFnk-2a	092	Mambo-1d
029	JBFnk-1b	093	Mambo-2d
030	JBFnk-2b	094	Mambo-1E
031	JBFnk-1c	095	Mambo-2E
032	JBFnk-2c	096	Merng-1I
033	JBFnk-1d	097	Merng-2I
034	JBFnk-2d	098	Merng-3I
035	JBFnk-1E	099	Merng-1a
036	JBFnk-2E	100	Merng-2a
037	JzFnk-I	101	Merng-3a
038	JzFnk-b	102	Merng-1b
039	JzFnk-c	103	Merng-2b
040	JzFnk-d	104	Merng-3b
041	JzFnk-E	105	Merng-1c
042	BgBnd-1I	106	Merng-2c
043	BgBnd-2I	107	Merng-3c
044	BgBnd-3I	108	Merng-1d
045	BgBnd-1a	109	Merng-2d
046	BgBnd-2a	110	Merng-3d
047	BgBnd-3a	111	Merng-1E
048	BgBnd-1b	112	Merng-2E
049	BgBnd-2b	113	Merng-3E
050	BgBnd-3b	114	Salsa-I
051	BgBnd-1c	115	Salsa-a
052	BgBnd-2c	116	Salsa-b
053	BgBnd-3c	117	Salsa-E
054	BgBnd-1d	118	Regae-I
055	BgBnd-2d	119	Regae-c
056	BgBnd-3d	120	Regae-d
057	BgBnd-1E	121	Regae-E
058	BgBnd-2E	122	Soca -1I
059	BgBnd-3E	123	Soca -2I
060	ColJz-1I	124	Soca -1b
061	ColJz-2I	125	Soca -2b
062	ColJz-1a	126	Soca -1c
063	ColJz-2a	127	Soca -2c
064	ColJz-1b		

Phrase Category=Da: Drum-a (Pop&Rock)

Beat=3/4 beat

No.	Name
001	68Mrc-1l
002	68Mrc-2l
003	68Mrc-3l
004	68Mrc-4l
005	68Mrc-1a
006	68Mrc-2a
007	68Mrc-1b
008	68Mrc-2b
009	68Mrc-3b
010	68Mrc-1c
011	68Mrc-2c
012	68Mrc-3c
013	68Mrc-4c
014	68Mrc-1d
015	68Mrc-2d
016	68Mrc-3d
017	68Mrc-4d
018	68Mrc-1E
019	68Mrc-2E
020	68Mrc-3E
021	68Mrc-4E

Beat=8 beat

No.	Name	No.	Name	No.	Name
001	Mixt -1l	065	FlkRk-E	129	Rap -1b
002	Mixt -2l	066	ArtRk-l	130	Rap -2b
003	Mixt -1a	067	ArtRk-a	131	Rap -c
004	Mixt -2a	068	ArtRk-b	132	Rap -d
005	Mixt -1b	069	ArtRk-E	133	Rap -1E
006	Mixt -2b	070	PnkRk-l	134	Rap -2E
007	Mixt -1E	071	PnkRk-a	135	SlwJm-l
008	Mixt -2E	072	PnkRk-b	136	SlwJm-a
009	HdCor-l	073	PnkRk-E	137	SlwJm-b
010	HdCor-1a	074	PubRk-l	138	SlwJm-E
011	HdCor-2a	075	PubRk-a	139	PpR&B-1l
012	HdCor-1b	076	PubRk-b	140	PpR&B-2l
013	HdCor-2b	077	PubRk-E	141	PpR&B-1a
014	HdCor-1E	078	60Hd -l	142	PpR&B-2a
015	HdCor-2E	079	60Hd -1a	143	PpR&B-1b
016	MICor-l	080	60Hd -2a	144	PpR&B-2b
017	MICor-a	081	60Hd -1b	145	PpR&B-c
018	MICor-b	082	60Hd -2b	146	PpR&B-1d
019	MICor-E	083	60Hd -c	147	PpR&B-2d
020	SkCor-l	084	60Hd -E	148	PpR&B-1E
021	SkCor-a	085	70Hd2-1l	149	PpR&B-2E
022	SkCor-b	086	70Hd2-2l	150	Bigbt-l
023	SkCor-E	087	70Hd2-1a	151	Bigbt-1a
024	RkBgy-1l	088	70Hd2-2a	152	Bigbt-2a
025	RkBgy-2l	089	70Hd2-1b	153	Bigbt-1b
026	RkBgy-a	090	70Hd2-2b	154	Bigbt-2b
027	RkBgy-b	091	70Hd2-1E	155	Bigbt-d
028	RkBgy-1E	092	70Hd2-2E	156	Bigbt-1E
029	RkBgy-2E	093	70H&R-1l	157	Bigbt-2E
030	MndRk-l	094	70H&R-2l	158	PycRk-1l
031	MndRk-1a	095	70H&R-1a	159	PycRk-2l
032	MndRk-2a	096	70H&R-2a	160	PycRk-1a
033	MndRk-b	097	70H&R-1b	161	PycRk-2a
034	MndRk-E	098	70H&R-2b	162	PycRk-1b
035	BrtRk-l	099	70H&R-c	163	PycRk-2b
036	BrtRk-a	100	70H&R-1E	164	PycRk-c
037	BrtRk-b	101	70H&R-2E	165	PycRk-1E
038	BrtRk-E	102	AmHR1-1l	166	PycRk-2E
039	RkShf-l	103	AmHR1-2l	167	LitPp-l
040	RkShf-1a	104	AmHR1-1a	168	LitPp-a
041	RkShf-2a	105	AmHR1-2a	169	LitPp-b
042	RkShf-b	106	AmHR1-1b	170	LitPp-E
043	RkShf-1E	107	AmHR1-2b	171	AORPp-l
044	RkShf-2E	108	AmHR1-c	172	AORPp-a
045	GlmRk-1l	109	AmHR1-d	173	AORPp-b
046	GlmRk-2l	110	AmHR1-1E	174	AORPp-E
047	GlmRk-1a	111	AmHR1-2E	175	BrtPp-l
048	GlmRk-2a	112	AmHR2-l	176	BrtPp-a
049	GlmRk-b	113	AmHR2-a	177	BrtPp-b
050	GlmRk-c	114	AmHR2-b	178	BrtPp-E
051	GlmRk-d	115	AmHR2-E	179	DtrPp-l
052	GlmRk-1E	116	HipH2-1l	180	DtrPp-a
053	GlmRk-2E	117	HipH2-2l	181	DtrPp-b
054	70sRk-1l	118	HipH2-1a	182	DtrPp-E
055	70sRk-2l	119	HipH2-2a	183	Md8Rk-l
056	70sRk-1a	120	HipH2-1b	184	Md8Rk-a
057	70sRk-2a	121	HipH2-2b	185	Md8Rk-E
058	70sRk-1b	122	HipH2-c	186	Acost-l
059	70sRk-2b	123	HipH2-1E	187	Acost-b
060	70sRk-1E	124	HipH2-2E	188	Acost-E
061	70sRk-2E	125	Rap -1l		
062	FlkRk-l	126	Rap -2l		
063	FlkRk-a	127	Rap -1a		
064	FlkRk-b	128	Rap -2a		

P r e s e t P h r a s e L i s t

Beat=16 beat

No.	Name	No.	Name	No.	Name
001	80MRk-1l	065	PwrMt-2l	129	JzHip-2E
002	80MRk-2l	066	PwrMt-1a	130	DncSw-1l
003	80MRk-1a	067	PwrMt-2a	131	DncSw-2l
004	80MRk-2a	068	PwrMt-1b	132	DncSw-1a
005	80MRk-1b	069	PwrMt-2b	133	DncSw-2a
006	80MRk-2b	070	PwrMt-c	134	DncSw-1b
007	80MRk-d	071	PwrMt-d	135	DncSw-2b
008	80MRk-1E	072	PwrMt-1E	136	DncSw-1c
009	80MRk-2E	073	PwrMt-2E	137	DncSw-2c
010	GrnRk-1l	074	Thrsh-1l	138	DncSw-d
011	GrnRk-2l	075	Thrsh-2l	139	DncSw-1E
012	GrnRk-a	076	Thrsh-1a	140	DncSw-2E
013	GrnRk-1b	077	Thrsh-2a	141	House-l
014	GrnRk-2b	078	Thrsh-1b	142	House-1a
015	GrnRk-1E	079	Thrsh-2b	143	House-2a
016	GrnRk-2E	080	Thrsh-1E	144	House-b
017	IrsRk-l	081	Thrsh-2E	145	House-c
018	IrsRk-a	082	DooMt-l	146	House-1E
019	IrsRk-b	083	DooMt-a	147	House-2E
020	IrsRk-E	084	DooMt-b	148	GrgHs-l
021	ClgRk-l	085	DooMt-c	149	GrgHs-a
022	ClgRk-a	086	DooMt-E	150	GrgHs-b
023	ClgRk-b	087	MTBgy-1l	151	GrgHs-E
024	ClgRk-1E	088	MTBgy-2l	152	R&BSw-l
025	ClgRk-2E	089	MtBgy-1a	153	R&BSw-a
026	FnkRk-l	090	MtBgy-2a	154	R&BSw-b
027	FnkRk-a	091	MtBgy-b	155	R&BSw-E
028	FnkRk-b	092	MtBgy-c	156	Smoth-1l
029	FnkRk-E	093	MtBgy-1E	157	Smoth-2l
030	LtnRk-l	094	MtBgy-2E	158	Smoth-1a
031	LtnRk-a	095	HipH1-1l	159	Smoth-2a
032	LtnRk-b	096	HipH1-2l	160	Smoth-1b
033	LtnRk-E	097	HipH1-1a	161	Smoth-2b
034	70Hd1-1l	098	HipH1-2a	162	Smoth-1c
035	70Hd1-2l	099	HipH1-1b	163	Smoth-2c
036	70Hd1-1a	100	HipH1-2b	164	Smoth-d
037	70Hd1-2a	101	HipH1-1E	165	Smoth-1E
038	70Hd1-1b	102	HipH1-2E	166	Smoth-2E
039	70Hd1-2b	103	PpHip-1l	167	PpTek-1l
040	70Hd1-d	104	PpHip-2l	168	PpTek-2l
041	70Hd1-1E	105	PpHip-1a	169	PpTek-1a
042	70Hd1-2E	106	PpHip-2a	170	PpTek-2a
043	16bHd-1l	107	PpHip-b	171	PpTek-b
044	16bHd-2l	108	PpHip-c	172	PpTek-c
045	16bHd-1a	109	PpHip-d	173	PpTek-E
046	16bHd-2a	110	PpHip-1E	174	EuTek-1l
047	16bHd-1b	111	PpHip-2E	175	EuTek-2l
048	16bHd-2b	112	Gngst-1l	176	EuTek-1a
049	16bHd-1E	113	Gngst-2l	177	EuTek-2a
050	16bHd-2E	114	Gngst-1a	178	EuTek-b
051	PrgHd-l	115	Gngst-2a	179	EuTek-c
052	PrgHd-a	116	Gngst-1b	180	EuTek-d
053	PrgHd-b	117	Gngst-2b	181	EuTek-1E
054	PrgHd-E	118	Gngst-1E	182	EuTek-2E
055	SpdMt-1l	119	Gngst-2E	183	Eurbt-1l
056	SpdMt-2l	120	JzHip-1l	184	Eurbt-2l
057	SpdMt-1a	121	JzHip-2l	185	Eurbt-1a
058	SpdMt-2a	122	JzHip-1a	186	Eurbt-2a
059	SpdMt-1b	123	JzHip-2a	187	Eurbt-b
060	SpdMt-2b	124	JzHip-1b	188	Eurbt-c
061	SpdMt-c	125	JzHip-2b	189	Eurbt-d
062	SpdMt-1E	126	JzHip-c	190	Eurbt-1E
063	SpdMt-2E	127	JzHip-d	191	Eurbt-2E
064	PwrMt-1l	128	JzHip-1E	192	ElcRk-1l

Beat=3/4 beat

No.	Name
001	R&BWz-l
002	R&BWz-a
003	R&BWz-b
004	R&BWz-E

P r e s e t P h r a s e L i s t

Phrase Category=Db: Drum-b (Specific)
Beat=8 beat

No.	Name	No.	Name
001	R&B -I	065	ArpBd-a
002	R&B -a	066	ArpBd-b
003	R&B -b	067	ArpBd-E
004	R&B -E	068	68Bld-I
005	68R&B-1I	069	68Bld-a
006	68R&B-2I	070	68Bld-b
007	68R&B-1a	071	68Bld-E
008	68R&B-2a	072	HRBld-I
009	68R&B-1b	073	HRBld-a
010	68R&B-2b	074	HRBld-b
011	68R&B-c	075	HRBld-E
012	68R&B-d	076	68HBd-I
013	68R&B-1E	077	68HBd-a
014	68R&B-2E	078	68HBd-b
015	Motwn-I	079	68HBd-E
016	Motwn-a	080	CWRk -I
017	Motwn-b	081	CWRk -a
018	Motwn-E	082	CWRk -b
019	SIBlu-I	083	CWRk -E
020	SIBlu-a	084	CWPop-1I
021	SIBlu-b	085	CWPop-2I
022	SIBlu-E	086	CWPop-1a
023	RkR&B-I	087	CWPop-2a
024	RkR&B-a	088	CWPop-1b
025	RkR&B-b	089	CWPop-2b
026	RkR&B-E	090	CWPop-1E
027	RknRI-I	091	CWPop-2E
028	RknRI-a	092	CWBld-I
029	RknRI-b	093	CWBld-a
030	RknRI-E	094	CWBld-b
031	Rcbly-1I	095	CWBld-E
032	Rcbly-2I	096	BlgRS-I
033	Rcbly-1a	097	BlgRS-a
034	Rcbly-2a	098	BlgRS-b
035	Rcbly-1b	099	BlgRS-E
036	Rcbly-2b	100	Rumba-I
037	Rcbly-1E	101	Rumba-a
038	Rcbly-2E	102	Rumba-E
039	Oldis-I	103	ChaCh-I
040	Oldis-a	104	ChaCh-a
041	Oldis-b	105	ChaCh-b
042	Oldis-E	106	ChaCh-E
043	Liver-I	107	Bossa-I
044	Liver-a	108	Bossa-a
045	Liver-b	109	Bossa-b
046	Liver-c	110	Bossa-E
047	Liver-E	111	Begin-I
048	SufRk-I	112	Begin-a
049	SufRk-a	113	Begin-b
050	SufRk-b	114	Begin-E
051	SufRk-E	115	Tango-1I
052	DscFk-I	116	Tango-2I
053	DscFk-a	117	Tango-1a
054	DscFk-b	118	Tango-2a
055	DscFk-E	119	Tango-1b
056	JzBld-I	120	Tango-2b
057	JzBld-a	121	Tango-c
058	JzBld-b	122	Tango-d
059	JzBld-E	123	Tango-1E
060	PnBld-I	124	Tango-2E
061	PnBld-a	125	Ska -I
062	PnBld-b	126	Ska -a
063	PnBld-E	127	Ska -b
064	ArpBd-I	128	Ska -E

Beat=16 beat

No.	Name	No.	Name
001	SoShf-I	065	16Cnt-a
002	SoShf-a	066	16Cnt-b
003	SoShf-b	067	16Cnt-E
004	SoShf-E	068	Samba-1I
005	TrnTm-I	069	Samba-2I
006	TrnTm-a	070	Samba-1a
007	TrnTm-b	071	Samba-2a
008	TrnTm-c	072	Samba-1b
009	TrnTm-d	073	Samba-2b
010	TrnTm-E	074	Samba-1E
011	70Dsc-I	075	Samba-2E
012	70Dsc-a	076	Mambo-1I
013	70Dsc-b	077	Mambo-2I
014	70Dsc-E	078	Mambo-1a
015	FPFnk-I	079	Mambo-2a
016	FPFnk-a	080	Mambo-1b
017	FPFnk-b	081	Mambo-2b
018	FPFnk-E	082	Mambo-1E
019	JBFnk-I	083	Mambo-2E
020	JBFnk-a	084	Salsa-I
021	JBFnk-b	085	Salsa-a
022	JBFnk-E	086	Salsa-b
023	JzFnk-I	087	Salsa-E
024	JzFnk-a	088	Regae-1I
025	JzFnk-b	089	Regae-2I
026	JzFnk-1E	090	Regae-a
027	JzFnk-2E	091	Regae-b
028	Combz-1I	092	Regae-1E
029	Combz-2I	093	Regae-2E
030	Combz-1a	094	SwRge-I
031	Combz-2a	095	SwRge-a
032	Combz-1b	096	SwRge-b
033	Combz-2b	097	SwRge-E
034	Combz-1E	098	DHRge-I
035	Combz-2E	099	DHRge-a
036	BgBnd-I	100	DHRge-b
037	BgBnd-a	101	DHRge-E
038	BgBnd-b	102	LvsRk-1I
039	BgBnd-E	103	LvsRk-2I
040	Bebop-I	104	LvsRk-1a
041	Bebop-a	105	LvsRk-2a
042	Bebop-b	106	LvsRk-b
043	Bebop-E	107	LvsRk-1E
044	ColJz-I	108	LvsRk-2E
045	ColJz-a	109	Soca -1I
046	ColJz-b	110	Soca -2I
047	ColJz-E	111	Soca -1a
048	AfrJz-1I	112	Soca -2a
049	AfrJz-2I	113	Soca -b
050	AfrJz-a	114	Soca -c
051	AfrJz-b	115	Soca -d
052	AfrJz-1E	116	Soca -1E
053	AfrJz-2E	117	Soca -2E
054	OrgBd-a		
055	OrgBd-1b		
056	OrgBd-2b		
057	OrgBd-d		
058	OrgBd-E		
059	LtnBd-I		
060	LtnBd-a		
061	LtnBd-b		
062	LtnBd-c		
063	LtnBd-E		
064	16Cnt-I		

Beat=3/4 beat

No.	Name
001	JzWlz-I
002	JzWlz-a
003	JzWlz-b
004	JzWlz-E
005	CWWlz-I
006	CWWlz-a
007	CWWlz-b
008	CWWlz-E
009	VnWlz-1E
010	VnWlz-2I
011	VnWlz-a
012	VnWlz-1b
013	VnWlz-2b
014	VnWlz-c
015	VnWlz-d
016	VnWlz-E
017	SIWlz-I
018	SIWlz-a
019	SIWlz-b
020	SIWlz-E
021	68Mrc-I
022	68Mrc-a
023	68Mrc-b
024	68Mrc-E

Phrase Category=Fa: Drum Fill-a (Pop&Rock)
Beat=8 beat

No.	Name	No.	Name
001	Mixt -1c	065	SlwJm-d
002	Mixt -2c	066	PpR&B-c
003	Mixt -1d	067	Bigbt-l
004	Mixt -2d	068	Bigbt-1c
005	HdCor-1c	069	Bigbt-2c
006	HdCor-2c	070	Bigbt-d
007	HdCor-1d	071	PycRk-c
008	HdCor-2d	072	PycRk-1d
009	MICor-c	073	PycRk-2d
010	MICor-d	074	LitPp-c
011	SkCor-c	075	LitPp-d
012	SkCor-d	076	AORPp-c
013	RkBgy-c	077	AORPp-d
014	RkBgy-1d	078	BrtPp-c
015	RkBgy-2d	079	BrtPp-d
016	MndRk-b	080	DtrPp-c
017	MndRk-1c	081	DtrPp-d
018	MndRk-2c	082	Md8Rk-c
019	MndRk-d	083	Md8Rk-d
020	MndRk-E	084	Acost-c
021	BrtRk-c	085	Acost-d
022	BrtRk-d		
023	RkShf-1c		
024	RkShf-2c		
025	RkShf-1d		
026	RkShf-2d		
027	GlmRk-c		
028	GlmRk-d		
029	70sRk-1c		
030	70sRk-2c		
031	70sRk-1d		
032	70sRk-2d		
033	FlkRk-l		
034	FlkRk-a		
035	FlkRk-b		
036	FlkRk-1c		
037	FlkRk-2c		
038	FlkRk-d		
039	FlkRk-E		
040	ArtRk-c		
041	ArtRk-d		
042	PnkRk-c		
043	PnkRk-d		
044	PubRk-c		
045	PubRk-d		
046	60Hd -c		
047	60Hd -d		
048	70Hd2-1c		
049	70Hd2-2c		
050	70Hd2-1d		
051	70Hd2-2d		
052	70H&R-c		
053	70H&R-1d		
054	70H&R-2d		
055	AmHR1-c		
056	AmHR1-d		
057	AmHR2-c		
058	AmHR2-d		
059	HipH2-c		
060	HipH2-1d		
061	HipH2-2d		
062	Rap -c		
063	Rap -d		
064	SlwJm-c		

Beat=16 beat

No.	Name	No.	Name
001	80MRk-1c	065	Eurbt-c
002	80MRk-2c	066	Eurbt-d
003	80MRk-d	067	ElcRk-c
004	GrnRk-1c	068	ElcRk-d
005	GrnRk-2c	069	DgRk1-1c
006	GrnRk-1d	070	DgRk1-2c
007	GrnRk-2d	071	DgRk1-1d
008	IrsRk-c	072	DgRk1-2d
009	IrsRk-d	073	DgRk2-c
010	ClgRk-1c	074	DgRk2-d
011	ClgRk-2c	075	IndRk-1c
012	ClgRk-1d	076	IndRk-2c
013	ClgRk-2d	077	IndRk-1d
014	FnkRk-c	078	IndRk-2d
015	FnkRk-d	079	LtnPp-1c
016	LtnRk-c	080	LtnPp-2c
017	LtnRk-d	081	LtnPp-1d
018	70Hd1-1c	082	LtnPp-2d
019	70Hd1-2c	083	16bPp-c
020	70Hd1-d	084	16bPp-d
021	16bHd-1c	085	24bPp-1c
022	16bHd-2c	086	24bPp-2c
023	16bHd-1d	087	24bPp-1d
024	16bHd-2d	088	24bPp-2d
025	PrgHd-c	089	TcFsn-c
026	PrgHd-d	090	TcFsn-d
027	SpdMt-c		
028	SpdMt-1d		
029	SpdMt-2d		
030	PwrMt-c		
031	PwrMt-d		
032	Thrsh-1c		
033	Thrsh-2c		
034	Thrsh-1d		
035	Thrsh-2d		
036	DooMt-d		
037	MtBgy-b		
038	MtBgy-c		
039	MtBgy-1d		
040	MtBgy-2d		
041	HipH1-1c		
042	HipH1-2c		
043	HipH1-1d		
044	HipH1-2d		
045	PpHip-c		
046	PpHip-d		
047	Gngst-1c		
048	Gngst-2c		
049	Gngst-1d		
050	Gngst-2d		
051	JzHip-c		
052	JzHip-d		
053	House-c		
054	House-d		
055	GrgHs-c		
056	GrgHs-d		
057	R&BSw-c		
058	R&BSw-d		
059	Smoth-d		
060	PpTek-c		
061	PpTek-1d		
062	PpTek-2d		
063	EuTek-c		
064	EuTek-d		

Beat=3/4 beat

No.	Name
001	R&BWZ-c
002	R&BWZ-d

Phrase Category=Fb: Drum Fill-b (Specific)

Beat=8 beat

No.	Name	No.	Name
001	R&B -c	065	Polka-c
002	R&B -d	066	Polka-1d
003	68R&B-c	067	Polka-2d
004	68R&B-d	068	Dixie-c
005	Motwn-c	069	Dixie-d
006	Motwn-d	070	Foxtr-c
007	SIBlu-c	071	Foxtr-d
008	SIBlu-d	072	March-c
009	RKR&B-c	073	March-d
010	RKR&B-d		
011	RknRI-c		
012	RknRI-d		
013	Rcbly-1c		
014	Rcbly-2c		
015	Rcbly-1d		
016	Rcbly-2d		
017	Oldis-c		
018	Oldis-d		
019	Liver-d		
020	SufRk-c		
021	SufRk-d		
022	DscFk-c		
023	DscFk-d		
024	JzBl-d-c		
025	JzBl-d-d		
026	PnBl-d-c		
027	PnBl-d-d		
028	ArpBd-c		
029	ArpBd-d		
030	68Bl-d-c		
031	68Bl-d-d		
032	HRBl-d-c		
033	HRBl-d-d		
034	68HBd-c		
035	68HBd-d		
036	CWRk -c		
037	CWRk -d		
038	CWPop-1c		
039	CWPop-2c		
040	CWPop-1d		
041	CWPop-2d		
042	CWBld-c		
043	CWBld-d		
044	Blgrs-c		
045	Blgrs-d		
046	Rumba-b		
047	Rumba-c		
048	Rumba-d		
049	ChaCh-c		
050	ChaCh-d		
051	Bossa-c		
052	Bossa-d		
053	Begin-c		
054	Begin-d		
055	Tango-c		
056	Tango-d		
057	Ska -c		
058	Ska -d		
059	Hwian-c		
060	Hwian-d		
061	Klzmr-c		
062	Klzmr-d		
063	Enka -c		
064	Enka -d		

Beat=16 beat

No.	Name
001	SoShf-c
002	SoShf-d
003	70Dsc-c
004	70Dsc-d
005	FPFnk-c
006	FPFnk-d
007	JBFnk-c
008	JBFnk-d
009	JzFnk-c
010	JzFnk-d
011	Combz-1c
012	Combz-2c
013	Combz-d
014	BgBnd-c
015	BgBnd-d
016	Bebop-c
017	Bebop-d
018	ColJz-c
019	ColJz-d
020	AfrJz-1c
021	AfrJz-2c
022	AfrJz-1d
023	AfrJz-2d
024	OrgBd-c
025	OrgBd-d
026	LtnBd-d
027	16Cnt-c
028	16Cnt-d
029	Samba-1c
030	Samba-2c
031	Samba-1d
032	Samba-2d
033	Mambo-1c
034	Mambo-2c
035	Mambo-1d
036	Mambo-2d
037	Salsa-c
038	Salsa-d
039	Regae-1c
040	Regae-2c
041	Regae-1d
042	Regae-2d
043	SwRge-c
044	SwRge-d
045	DHRge-c
046	DHRge-d
047	LvsRk-1c
048	LvsRk-2c
049	LvsRk-1d
050	LvsRk-2d
051	Soca -c
052	Soca -d

Beat=3/4 beat

No.	Name
001	JzWlz-c
002	JzWlz-d
003	CWWlz-c
004	CWWlz-d
005	VnWlz-c
006	VnWlz-d
007	SIWlz-c
008	SIWlz-d
009	68Mrc-c
010	68Mrc-d

P r e s e t P h r a s e L i s t

Phrase Category=Ga: Guitar Chord-a (Pop&Rock)

Beat=8 beat

No.	Name	No.	Name	No.	Name
001	Mixt -b	065	FkRk-b	129	Bigbt-2E
002	Mixt -c	066	FkRk-1c	130	PycRk-l
003	Mixt -d	067	FkRk-2c	131	PycRk-a
004	Mixt -E	068	FkRk-d	132	PycRk-b
005	HdCor-l	069	FkRk-1E	133	PycRk-c
006	HdCor-a	070	FkRk-2E	134	PycRk-d
007	HdCor-b	071	ArtRk-l	135	PycRk-E
008	HdCor-c	072	ArtRk-d	136	BrtpP-l
009	HdCor-E	073	ArtRk-E	137	BrtpP-1a
010	MICor-l	074	PnkRk-1l	138	BrtpP-2a
011	MICor-a	075	PnkRk-2l	139	BrtpP-1b
012	MICor-b	076	PnkRk-1b	140	BrtpP-2b
013	MICor-c	077	PnkRk-2b	141	BrtpP-3b
014	MICor-d	078	PnkRk-1c	142	BrtpP-1c
015	MICor-E	079	PnkRk-2c	143	BrtpP-2c
016	SkCor-l	080	PnkRk-d	144	BrtpP-3c
017	SkCor-a	081	PnkRk-1E	145	BrtpP-1d
018	SkCor-c	082	PnkRk-2E	146	BrtpP-2d
019	SkCor-E	083	PubRk-l	147	BrtpP-E
020	RkBgY-l	084	PubRk-1l	148	BrtpP-3E
021	RkBgY-b	085	PubRk-2l	149	DtrPp-1l
022	RkBgY-c	086	PubRk-a	150	DtrPp-2l
023	RkBgY-d	087	PubRk-1b	151	DtrPp-1a
024	MndRk-l	088	PubRk-2b	152	DtrPp-2a
025	MndRk-b	089	PubRk-3b	153	DtrPp-1b
026	MndRk-d	090	PubRk-d	154	DtrPp-2b
027	MndRk-E	091	PubRk-E	155	DtrPp-1c
028	BrtRk-l	092	60Hd -l	156	DtrPp-2c
029	BrtRk-1a	093	60Hd -a	157	DtrPp-1d
030	BrtRk-2a	094	60Hd -b	158	DtrPp-2d
031	BrtRk-b	095	60Hd -c	159	DtrPp-1E
032	BrtRk-1c	096	70Hd2-l	160	DtrPp-2E
033	BrtRk-2c	097	70Hd2-a	161	Md8Rk-b
034	BrtRk-1d	098	70Hd2-b	162	Md8Rk-c
035	BrtRk-2d	099	70Hd2-c	163	Md8Rk-d
036	BrtRk-E	100	70Hd2-d	164	Acost-a
037	RkShf-l	101	70Hd2-E	165	Acost-b
038	RkShf-a	102	70H&R-l	166	Acost-c
039	RkShf-c	103	70H&R-a	167	Acost-d
040	RkShf-d	104	70H&R-b	168	68HBd-l
041	RkShf-E	105	70H&R-c		
042	GlmRk-l	106	70H&R-d		
043	GlmRk-1a	107	70H&R-E		
044	GlmRk-2a	108	AmHR1-l		
045	GlmRk-b	109	AmHR1-a		
046	GlmRk-1c	110	AmHR1-b		
047	GlmRk-2c	111	AmHR2-l		
048	GlmRk-1E	112	AmHR2-1a		
049	GlmRk-2E	113	AmHR2-2a		
050	70sRk-l	114	AmHR2-1b		
051	70sRk-1a	115	AmHR2-2b		
052	70sRk-2a	116	AmHR2-c		
053	70sRk-1b	117	AmHR2-1d		
054	70sRk-2b	118	AmHR2-2d		
055	70sRk-1c	119	AmHR2-E		
056	70sRk-2c	120	Bigbt-1l		
057	70sRk-1d	121	Bigbt-2l		
058	70sRk-2d	122	Bigbt-1a		
059	70sRk-1E	123	Bigbt-2a		
060	70sRk-2E	124	Bigbt-1b		
061	FkRk-1l	125	Bigbt-2b		
062	FkRk-2l	126	Bigbt-1c		
063	FkRk-1a	127	Bigbt-2c		
064	FkRk-2a	128	Bigbt-1E		

Beat=16 beat

No.	Name	No.	Name
001	80MRk-l	065	SpdMt-2l
002	80MRk-a	066	SpdMt-1a
003	80MRk-b	067	SpdMt-2a
004	80MRk-c	068	SpdMt-3a
005	80MRk-d	069	SpdMt-1b
006	GrnRk-1l	070	SpdMt-2b
007	GrnRk-2l	071	SpdMt-c
008	GrnRk-3l	072	SpdMt-1c
009	GrnRk-1a	073	SpdMt-2c
010	GrnRk-2a	074	SpdMt-1d
011	GrnRk-1b	075	SpdMt-2d
012	GrnRk-2b	076	PwrMt-l
013	GrnRk-3b	077	PwrMt-b
014	GrnRk-c	078	Thrsh-l
015	GrnRk-1d	079	Thrsh-a
016	GrnRk-2d	080	Thrsh-1b
017	GrnRk-3d	081	Thrsh-2b
018	GrnRk-1E	082	Thrsh-c
019	GrnRk-2E	083	Thrsh-1d
020	GrnRk-3E	084	Thrsh-2d
021	IrsRk-1l	085	Thrsh-E
022	IrsRk-2l	086	DooMt-l
023	IrsRk-1b	087	DooMt-a
024	IrsRk-2b	088	DooMt-b
025	IrsRk-1c	089	DooMt-c
026	IrsRk-2c	090	DooMt-d
027	IrsRk-d	091	MtBgY-a
028	IrsRk-1E	092	MtBgY-b
029	IrsRk-2E	093	MtBgY-c
030	CigRk-1l	094	JzHip-l
031	CigRk-2l	095	JzHip-b
032	CigRk-a	096	JzHip-c
033	CigRk-b	097	JzHip-d
034	CigRk-c	098	JzHip-E
035	CigRk-1d	099	ElcRk-l
036	CigRk-2d	100	ElcRk-b
037	CigRk-1E	101	ElcRk-c
038	CigRk-2E	102	DgRk1-a
039	FnkRk-a	103	IndRk-a
040	FnkRk-b	104	IndRk-b
041	FnkRk-c	105	LtnPp-a
042	FnkRk-d	106	LtnPp-c
043	LtnRk-l	107	LtnPp-d
044	LtnRk-a	108	LtnPp-E
045	LtnRk-b	109	16bPp-b
046	LtnRk-c	110	16bPp-d
047	LtnRk-d	111	24bPp-l
048	LtnRk-E	112	24bPp-a
049	70Hd1-a	113	24bPp-b
050	70Hd1-b	114	24bPp-c
051	16bHd-l	115	24bPp-d
052	16bHd-1a	116	24bPp-E
053	16bHd-2a	117	TcFsn-b
054	16bHd-1b	118	TcFsn-d
055	16bHd-2b	119	TcFsn-E
056	16bHd-1c	120	Combz-l
057	16bHd-2c	121	LtnBd-E
058	16bHd-1d		
059	16bHd-2d		
060	16bHd-1E		
061	16bHd-2E		
062	PrgHd-b		
063	PrgHd-E		
064	SpdMt-1l		

Beat=3/4 beat

No.	Name
001	R&BWZ-a
002	R&BWZ-d

Phrase Category=Gb: Guitar Chord-b (Specific)

Beat=8 beat

No.	Name	No.	Name
001	Motwn-a	065	68HBd-a
002	Motwn-b	066	68HBd-b
003	Motwn-c	067	68HBd-1c
004	Motwn-d	068	68HBd-2c
005	SIBlu-l	069	68HBd-E
006	SIBlu-a	070	CWRk-l
007	SIBlu-c	071	CWRk-1a
008	SIBlu-d	072	CWRk-2a
009	SIBlu-E	073	CWRk-1b
010	RkR&B-a	074	CWRk-2b
011	RkR&B-c	075	CWRk-b
012	RkR&B-1d	076	CWRk-c
013	RkR&B-2d	077	CWRk-d
014	RkR&B-E	078	CWRk-E
015	RknRI-a	079	CWPop-l
016	RknRI-b	080	CWPop-1a
017	RknRI-c	081	CWPop-2a
018	Rcbly-1l	082	CWPop-1b
019	Rcbly-2l	083	CWPop-2b
020	Rcbly-3l	084	CWPop-2b
021	Rcbly-a	085	CWPop-2d
022	Rcbly-1b	086	CWPop-1E
023	Rcbly-2b	087	CWPop-2E
024	Rcbly-3b	088	CWBld-l
025	Rcbly-c	089	CWBld-a
026	Rcbly-1d	090	CWBld-1b
027	Rcbly-2d	091	CWBld-2b
028	Rcbly-1E	092	CWBld-1c
029	Rcbly-2E	093	CWBld-2c
030	Rcbly-3E	094	CWBld-d
031	Oldis-l	095	CWBld-1E
032	Oldis-a	096	CWBld-2E
033	Oldis-c	097	Blgrs-l
034	Oldis-E	098	Blgrs-1a
035	Liver-l	099	Blgrs-2a
036	Liver-1a	100	Blgrs-1b
037	Liver-2a	101	Blgrs-2b
038	Liver-b	102	Blgrs-1c
039	Liver-c	103	Blgrs-2c
040	Liver-1d	104	Blgrs-1d
041	Liver-2d	105	Blgrs-2d
042	Liver-1E	106	Blgrs-E
043	Liver-2E	107	Rumba-l
044	SufRk-l	108	Rumba-a
045	SufRk-a	109	Rumba-b
046	SufRk-1b	110	Rumba-c
047	SufRk-2b	111	Rumba-d
048	SufRk-c	112	Rumba-E
049	SufRk-d	113	ChaCh-l
050	JzBld-a	114	ChaCh-a
051	JzBld-b	115	ChaCh-b
052	JzBld-c	116	ChaCh-c
053	PnBld-b	117	ChaCh-E
054	PnBld-c	118	Bossa-l
055	PnBld-d	119	Bossa-a
056	68Bld-a	120	Bossa-b
057	68Bld-c	121	Bossa-c
058	HRBld-b	122	Bossa-d
059	HRBld-1c	123	Bossa-E
060	HRBld-2c	124	Begin-l
061	HRBld-3c	125	Begin-a
062	HRBld-1d	126	Begin-b
063	HRBld-2d	127	Begin-c
064	HRBld-3d	128	Begin-d

Beat=16 beat

No.	Name	No.	Name
001	SoShf-b	065	Regae-2d
002	SoShf-c	066	Regae-E
003	SoShf-E	067	SwRge-l
004	TrnTm-l	068	SwRge-a
005	TrnTm-a	069	SwRge-b
006	TrnTm-1b	070	SwRge-c
007	TrnTm-2b	071	SwRge-d
008	TrnTm-c	072	SwRge-E
009	TrnTm-1d	073	LvsRk-l
010	TrnTm-2d	074	LvsRk-b
011	TrnTm-1E	075	LvsRk-E
012	TrnTm-2E		
013	70Dsc-b	013	70Dsc-b
014	70Dsc-d	014	70Dsc-d
015	70Dsc-E	015	70Dsc-E
016	FPFnk-l	016	FPFnk-l
017	FPFnk-a	017	FPFnk-a
018	FPFnk-b	018	FPFnk-b
019	FPFnk-c	019	FPFnk-c
020	FPFnk-d	020	FPFnk-d
021	FPFnk-E	021	FPFnk-E
022	JBFnk-b	022	JBFnk-b
023	JBFnk-c	023	JBFnk-c
024	JBFnk-d	024	JBFnk-d
025	JBFnk-E	025	JBFnk-E
026	Combz-a	026	Combz-a
027	Combz-b	027	Combz-b
028	Combz-c	028	Combz-c
029	Combz-d	029	Combz-d
030	Combz-E	030	Combz-E
031	BgBnd-l	031	BgBnd-l
032	BgBnd-a	032	BgBnd-a
033	BgBnd-b	033	BgBnd-b
034	BgBnd-c	034	BgBnd-c
035	BgBnd-d	035	BgBnd-d
036	Bebop-a	036	Bebop-a
037	Bebop-b	037	Bebop-b
038	Bebop-c	038	Bebop-c
039	Bebop-d	039	Bebop-d
040	OrgBd-b	040	OrgBd-b
041	OrgBd-E	041	OrgBd-E
042	LtnBd-a	042	LtnBd-a
043	LtnBd-b	043	LtnBd-b
044	LtnBd-c	044	LtnBd-c
045	LtnBd-d	045	LtnBd-d
046	16Cnt-1l	046	16Cnt-1l
047	16Cnt-2l	047	16Cnt-2l
048	16Cnt-1a	048	16Cnt-1a
049	16Cnt-2a	049	16Cnt-2a
050	16Cnt-1b	050	16Cnt-1b
051	16Cnt-2b	051	16Cnt-2b
052	16Cnt-1c	052	16Cnt-1c
053	16Cnt-2c	053	16Cnt-2c
054	16Cnt-1d	054	16Cnt-1d
055	16Cnt-2d	055	16Cnt-2d
056	16Cnt-1E	056	16Cnt-1E
057	16Cnt-2E	057	16Cnt-2E
058	Regae-1l	058	Regae-1l
059	Regae-2l	059	Regae-2l
060	Regae-1a	060	Regae-1a
061	Regae-2a	061	Regae-2a
062	Regae-1b	062	Regae-1b
063	Regae-2b	063	Regae-2b
064	Regae-1d	064	Regae-1d

Beat=3/4 beat

No.	Name
001	JzWlz-l
002	JzWlz-a
003	JzWlz-b
004	JzWlz-E
005	CWWlz-l
006	CWWlz-1a
007	CWWlz-2a
008	CWWlz-1b
009	CWWlz-2b
010	CWWlz-1c
011	CWWlz-2c
012	CWWlz-1d
013	CWWlz-2d
014	CWWlz-E
015	SIWlz-1l
016	SIWlz-2l
017	SIWlz-a
018	SIWlz-b
019	SIWlz-1c
020	SIWlz-2c
021	SIWlz-1d
022	SIWlz-2d
023	SIWlz-1E
024	SIWlz-2E

Phrase Category=GR: Guitar Riff
Beat=8 beat

No.	Name	No.	Name	No.	Name
001	Mixt -I	065	BrIPp-I	129	CWRk -2d
002	SkCor-I	066	BrIPp-E	130	CWRk -1E
003	SkCor-E	067	Md8Rk-I	131	CWRk -2E
004	RkBgY-I	068	Md8Rk-a	132	CWPop-1I
005	RkBgY-a	069	Md8Rk-c	133	CWPop-2I
006	RkBgY-1E	070	Md8Rk-E	134	CWPop-a
007	RkBgY-2E	071	Acost-1I	135	CWPop-1c
008	MndRk-I	072	Acost-2I	136	CWPop-2c
009	MndRk-a	073	Acost-3I	137	CWPop-3c
010	MndRk-1c	074	Acost-a	138	CWPop-d
011	MndRk-2c	075	Acost-b	139	CWPop-E
012	MndRk-d	076	Acost-c	140	CWBld-1I
013	MndRk-E	077	Acost-d	141	CWBld-2I
014	BrIRk-I	078	Acost-1E	142	CWBld-a
015	BrIRk-1E	079	Acost-2E	143	CWBld-b
016	BrIRk-2E	080	Acost-3E	144	CWBld-d
017	70sRk-I	081	Motwn-I	145	CWBld-E
018	ArtRk-a	082	Motwn-E	146	Blgrs-I
019	ArtRk-b	083	RkR&B-1I	147	Blgrs-a
020	ArtRk-c	084	RkR&B-2I	148	Blgrs-b
021	PnkRk-I	085	RkR&B-1b	149	Blgrs-c
022	PnkRk-1a	086	RkR&B-2b	150	Blgrs-d
023	PnkRk-2a	087	RkR&B-E	151	Blgrs-1E
024	PnkRk-b	088	RknRI-I	152	Blgrs-2E
025	PnkRk-1d	089	RknRI-E	153	Hwian-1I
026	PnkRk-2d	090	Rcoby-a	154	Hwian-2I
027	PnkRk-E	091	Rcoby-c	155	Hwian-c
028	PubRk-c	092	Rcoby-d	156	Hwian-E
029	PubRk-1d	093	Rcoby-E	157	Klzmr-E
030	PubRk-2d	094	Liver-I	158	Enka -I
031	PubRk-1E	095	Liver-b	159	Enka -a
032	PubRk-2E	096	Liver-c	160	Enka -d
033	60Hd -I	097	SufRk-1I	161	Enka -E
034	60Hd -a	098	SufRk-2I		
035	60Hd -c	099	SufRk-a		
036	60Hd -d	100	SufRk-c		
037	60Hd -1E	101	SufRk-1E		
038	60Hd -2E	102	SufRk-2E		
039	AmHR1-c	103	SufRk-3E		
040	AmHR1-1d	104	JzBld-I		
041	AmHR1-2d	105	JzBld-E		
042	AmHR1-1E	106	PnBld-I		
043	AmHR1-2E	107	PnBld-a		
044	AmHR2-I	108	ArpBd-I		
045	AmHR2-c	109	ArpBd-b		
046	AmHR2-E	110	ArpBd-d		
047	HipH2-I	111	ArpBd-E		
048	HipH2-a	112	HRBld-1I		
049	HipH2-b	113	HRBld-2I		
050	HipH2-c	114	HRBld-1a		
051	HipH2-d	115	HRBld-2a		
052	HipH2-E	116	HRBld-1b		
053	SlwJm-I	117	HRBld-2b		
054	SlwJm-a	118	HRBld-1E		
055	SlwJm-b	119	HRBld-2E		
056	SlwJm-c	120	68HBd-b		
057	SlwJm-d	121	68HBd-c		
058	SlwJm-E	122	68HBd-E		
059	PpR&B-I	123	CWRk -1I		
060	PpR&B-a	124	CWRk -2I		
061	PpR&B-b	125	CWRk -a		
062	PpR&B-c	126	CWRk -1c		
063	PpR&B-d	127	CWRk -2c		
064	PpR&B-E	128	CWRk -1d		

Beat=16 beat

No.	Name	No.	Name	No.	Name
001	80MRk-E	065	Gngst-2d	129	LvsRk-d
002	GrnRk-I	066	Gngst-1E		
003	GrnRk-b	067	Gngst-2E		
004	GrnRk-1c	068	JzHip-a		
005	GrnRk-2c	069	DncSw-I		
006	GrnRk-3c	070	DncSw-a		
007	GrnRk-d	071	DncSw-b		
008	GrnRk-E	072	DncSw-c		
009	IrsRk-a	073	DncSw-d		
010	IrsRk-b	074	DncSw-E		
011	IrsRk-c	075	ElcRk-d		
012	IrsRk-1d	076	ElcRk-E		
013	IrsRk-2d	077	DgRk1-I		
014	IrsRk-E	078	DgRk1-c		
015	CigRk-I	079	IndRk-1I		
016	CigRk-1c	080	IndRk-2I		
017	CigRk-2c	081	IndRk-a		
018	CigRk-E	082	IndRk-b		
019	FnkRk-I	083	IndRk-1c		
020	FnkRk-E	084	IndRk-2c		
021	LtnRk-I	085	IndRk-1d		
022	LtnRk-E	086	IndRk-2d		
023	70Hd1-I	087	IndRk-E		
024	70Hd1-a	088	LtnPp-I		
025	70Hd1-c	089	LtnPp-b		
026	70Hd1-d	090	16bPp-a		
027	70Hd1-d	091	16bPp-c		
028	70Hd1-E	092	TcFsn-I		
029	70Hd1-E	093	TcFsn-a		
030	16bHd-I	094	TcFsn-c		
031	16bHd-E	095	TcFsn-E		
032	PrgHd-I	096	SoShf-I		
033	PrgHd-a	097	SoShf-a		
034	PrgHd-c	098	SoShf-d		
035	PrgHd-d	099	TrnTm-I		
036	SpdMt-I	100	70Dsc-I		
037	SpdMt-1E	101	70Dsc-a		
038	SpdMt-2E	102	70Dsc-c		
039	SpdMt-3E	103	FPFnk-I		
040	PwrMt-a	104	FPFnk-a		
041	PwrMt-c	105	FPFnk-b		
042	PwrMt-d	106	FPFnk-c		
043	PwrMt-E	107	FPFnk-d		
044	Thrsh-I	108	FPFnk-E		
045	Thrsh-a	109	JBFnk-I		
046	Thrsh-c	110	JBFnk-1a		
047	Thrsh-E	111	JBFnk-2a		
048	DooMt-E	112	JBFnk-d		
049	MtBgY-I	113	JzFkn-I		
050	MtBgY-d	114	JzFkn-a		
051	MtBgY-E	115	JzFkn-b		
052	HipH1-I	116	JzFkn-E		
053	HipH1-a	117	BgBnd-E		
054	HipH1-b	118	Bebop-I		
055	HipH1-c	119	Bebop-E		
056	HipH1-d	120	OrgBd-d		
057	HipH1-E	121	SwRge-I		
058	Gngst-I	122	SwRge-a		
059	Gngst-1a	123	SwRge-b		
060	Gngst-2a	124	SwRge-c		
061	Gngst-b	125	SwRge-d		
062	Gngst-1c	126	SwRge-E		
063	Gngst-2c	127	LvsRk-a		
064	Gngst-1d	128	LvsRk-c		

Beat=3/4 beat

No.	Name
01	R&BWz-l
002	R&BWz-b
003	R&BWz-c
004	R&BWz-E
005	JzWlz-c
006	JzWlz-d
007	CWWlz-l
008	CWWlz-E
009	SIWlz-a
010	SIWlz-b

**Phrase Category=KC: Keyboard Chord
Beat=8 beat**

No.	Name	No.	Name	No.	Name	No.	Name
001	SkCor-b	065	LitPp-1l	129	RknRI-d	193	Ska -c
002	RkBggy-a	066	LitPp-2l	130	RknRI-E	194	Ska -d
003	RkBggy-b	067	LitPp-a	131	Oldis-l	195	Ska -E
004	RkBggy-E	068	LitPp-1b	132	Oldis-a	196	Klzmr-l
005	RkShf-l	069	LitPp-2b	133	Oldis-c	197	Klzmr-a
006	RkShf-a	070	LitPp-1c	134	Oldis-E	198	Klzmr-b
007	RkShf-1b	071	LitPp-2c	135	DscFk-a	199	Klzmr-c
008	RkShf-2b	072	LitPp-1d	136	DscFk-b	200	Klzmr-d
009	RkShf-c	073	LitPp-2d	137	DscFk-c	201	Enka -l
010	RkShf-1d	074	LitPp-E	138	DscFk-d	202	Enka -a
011	RkShf-2d	075	AORPp-l	139	JzBld-a	203	Enka -b
012	RkShf-E	076	AORPp-a	140	JzBld-b	204	Enka -c
013	GlmRk-a	077	AORPp-1b	141	JzBld-c	205	Enka -d
014	GlmRk-b	078	AORPp-2b	142	JzBld-d	206	Enka -E
015	GlmRk-c	079	AORPp-1c	143	JzBld-E	207	Dixie-l
016	GlmRk-d	080	AORPp-2c	144	PnBld-a	208	Dixie-a
017	GlmRk-E	081	AORPp-1d	145	PnBld-b	209	Dixie-b
018	70sRk-b	082	AORPp-2d	146	PnBld-c	210	Dixie-c
019	70sRk-E	083	AORPp-E	147	PnBld-d	211	Dixie-d
020	FkRk-l	084	DtrPp-a	148	ArpBd-a	212	Dixie-E
021	FkRk-b	085	DtrPp-c	149	ArpBd-1b		
022	FkRk-E	086	R&B -l	150	ArpBd-2b		
023	ArtRk-l	087	R&B -1a	151	ArpBd-1c		
024	ArtRk-a	088	R&B -2a	152	ArpBd-2c		
025	ArtRk-b	089	R&B -1b	153	ArpBd-1d		
026	ArtRk-c	090	R&B -2b	154	ArpBd-2d		
027	70Hd2-l	091	R&B -1c	155	68Bld-a		
028	70Hd2-a	092	R&B -2c	156	68Bld-b		
029	70Hd2-b	093	R&B -d	157	68Bld-c		
030	70Hd2-c	094	R&B -E	158	68Bld-d		
031	70Hd2-d	095	68R&B-1l	159	68Bld-E		
032	70Hd2-E	096	68R&B-2l	160	68HBd-l		
033	70H&R-a	097	68R&B-a	161	CWRk -l		
034	70H&R-b	098	68R&B-1b	162	CWRk -a		
035	70H&R-E	099	68R&B-2b	163	CWRk -b		
036	AmHR2-l	100	68R&B-c	164	CWRk -c		
037	AmHR2-a	101	68R&B-1d	165	CWRk -d		
038	AmHR2-b	102	68R&B-2d	166	CWPop-l		
039	AmHR2-c	103	68R&B-1E	167	CWPop-1b		
040	AmHR2-d	104	68R&B-2E	168	CWPop-1d		
041	AmHR2-E	105	Motwn-1l	169	CWPop-E		
042	HipH2-a	106	Motwn-2l	170	Rumba-a		
043	HipH2-c	107	Motwn-1a	171	Rumba-b		
044	HipH2-d	108	Motwn-2a	172	Rumba-c		
045	Rap -l	109	Motwn-1b	173	Rumba-d		
046	Rap -b	110	Motwn-2b	174	Bossa-l		
047	Rap -c	111	Motwn-c	175	Bossa-a		
048	Rap -d	112	Motwn-1d	176	Bossa-b		
049	Rap -E	113	Motwn-2d	177	Bossa-c		
050	SlwJm-l	114	Motwn-1E	178	Bossa-d		
051	SlwJm-a	115	Motwn-2E	179	Bossa-E		
052	SlwJm-b	116	SIblu-a	180	Begin-l		
053	SlwJm-c	117	SIblu-b	181	Begin-E		
054	SlwJm-d	118	SIblu-c	182	Tango-1a		
055	SlwJm-E	119	RkR&B-l	183	Tango-2a		
056	PpR&B-l	120	RkR&B-a	184	Tango-1b		
057	PpR&B-a	121	RkR&B-b	185	Tango-2b		
058	PpR&B-b	122	RkR&B-c	186	Tango-1c		
059	PpR&B-c	123	RkR&B-d	187	Tango-2c		
060	PpR&B-d	124	RkR&B-E	188	Tango-1d		
061	PpR&B-E	125	RknRI-l	189	Tango-2d		
062	Bigbt-a	126	RknRI-a	190	Tango-E		
063	Bigbt-b	127	RknRI-b	191	Ska -l		
064	Bigbt-c	128	RknRI-c	192	Ska -a		

P r e s e t P h r a s e L i s t

Beat=16 beat

No.	Name	No.	Name	No.	Name
001	FnkRk-a	065	R&BSw-E	129	70Dsc-d
002	FnkRk-b	066	Smoth-a	130	FPFnk-l
003	FnkRk-c	067	Smoth-b	131	FPFnk-a
004	FnkRk-d	068	Smoth-c	132	FPFnk-b
005	LtnRk-1l	069	Smoth-d	133	FPFnk-c
006	LtnRk-2l	070	Smoth-E	134	FPFnk-d
007	LtnRk-a	071	PpTek-c	135	FPFnk-E
008	LtnRk-1b	072	PpTek-d	136	JzFnk-a
009	LtnRk-2b	073	EuTek-l	137	JzFnk-1b
010	LtnRk-c	074	EuTek-E	138	JzFnk-2b
011	LtnRk-1d	075	Eurbt-l	139	JzFnk-d
012	LtnRk-2d	076	Eurbt-1a	140	JzFnk-1E
013	LtnRk-1E	077	Eurbt-2a	141	JzFnk-2E
014	LtnRk-2E	078	Eurbt-3a	142	Combz-a
015	PrgHd-a	079	Eurbt-1c	143	Combz-b
016	PrgHd-b	080	Eurbt-2c	144	Combz-d
017	PrgHd-c	081	Eurbt-3c	145	Combz-E
018	PrgHd-d	082	Eurbt-E	146	Bebop-l
019	PpHip-1l	083	ElcRk-l	147	Bebop-a
020	PpHip-2l	084	ElcRk-1a	148	Bebop-1b
021	PpHip-a	085	ElcRk-2a	149	Bebop-2b
022	PpHip-1b	086	ElcRk-b	150	Bebop-d
023	PpHip-2b	087	ElcRk-1c	151	Bebop-E
024	PpHip-c	088	ElcRk-2c	152	ColJz-l
025	PpHip-1d	089	ElcRk-E	153	ColJz-a
026	PpHip-2d	090	DgRk2-b	154	ColJz-b
027	PpHip-1E	091	DgRk2-d	155	ColJz-c
028	PpHip-2E	092	LtnPp-l	156	ColJz-d
029	JzHip-1l	093	LtnPp-a	157	ColJz-E
030	JzHip-2l	094	LtnPp-b	158	AfrJz-a
031	JzHip-1a	095	LtnPp-c	159	AfrJz-b
032	JzHip-2a	096	LtnPp-d	160	AfrJz-c
033	JzHip-b	097	LtnPp-E	161	AfrJz-d
034	JzHip-1c	098	16bPp-1l	162	AfrJz-E
035	JzHip-2c	099	16bPp-2l	163	OrgBd-a
036	JzHip-d	100	16bPp-a	164	OrgBd-b
037	JzHip-1E	101	16bPp-1b	165	OrgBd-c
038	JzHip-2E	102	16bPp-2b	166	OrgBd-d
039	DncSw-l	103	16bPp-c	167	LtnBd-b
040	DncSw-a	104	16bPp-1d	168	LtnBd-d
041	DncSw-b	105	16bPp-2d	169	Samba-l
042	DncSw-c	106	16bPp-1E	170	Samba-1a
043	DncSw-d	107	16bPp-2E	171	Samba-2a
044	DncSw-E	108	24bPp-l	172	Samba-1b
045	House-1a	109	24bPp-a	173	Samba-2b
046	House-2a	110	24bPp-b	174	Samba-1c
047	House-b	111	24bPp-c	175	Samba-2c
048	House-c	112	24bPp-d	176	Samba-1d
049	House-d	113	24bPp-E	177	Samba-2d
050	House-1E	114	TcFsn-l	178	Samba-E
051	House-2E	115	TcFsn-a	179	Mambo-l
052	GrgHs-l	116	TcFsn-b	180	Mambo-a
053	GrgHs-a	117	TcFsn-c	181	Mambo-b
054	GrgHs-b	118	TcFsn-d	182	Mambo-c
055	GrgHs-c	119	TcFsn-E	183	Mambo-d
056	GrgHs-d	120	SoShf-l	184	Mambo-E
057	GrgHs-1E	121	SoShf-a	185	Merng-a
058	GrgHs-2E	122	SoShf-b	186	Merng-b
059	R&BSw-1l	123	SoShf-c	187	Merng-c
060	R&BSw-2l	124	SoShf-d	188	Merng-d
061	R&BSw-a	125	SoShf-E	189	SwRge-l
062	R&BSw-b	126	70Dsc-a	190	SwRge-a
063	R&BSw-c	127	70Dsc-b	191	SwRge-b
064	R&BSw-d	128	70Dsc-c	192	SwRge-c

Beat=3/4 beat

No.	Name
001	R&BWz-a
002	R&BWz-b
003	R&BWz-c
004	R&BWz-d
005	JzWlz-l
006	JzWlz-a
007	JzWlz-b
008	JzWlz-c
009	JzWlz-d
010	JzWlz-E
011	CWWlz-l
012	CWWlz-1a
013	CWWlz-2a
014	CWWlz-b
015	CWWlz-1c
016	CWWlz-2c
017	CWWlz-d
018	CWWlz-E
019	VnWlz-l
020	VnWlz-E
021	SiWlz-a
022	SiWlz-d

Phrase Category=KR: Keyboard Riff

Beat=8 beat

Beat=16 beat

Beat=3/4 beat

No.	Name	No.	Name
001	Mixt -1a	065	SIBlu-I
002	Mixt -2a	066	SIBlu-d
003	Mixt -b	067	SIBlu-E
004	Mixt -c	068	RknRI-I
005	Mixt -d	069	RknRI-E
006	Mixt -1E	070	DscFk-I
007	Mixt -2E	071	DscFk-E
008	SkCor-I	072	JzBlId-I
009	SkCor-c	073	JzBlId-E
010	SkCor-d	074	PnBlId-I
011	SkCor-E	075	PnBlId-E
012	RkBggy-c	076	ArpBd-I
013	RkBggy-d	077	ArpBd-a
014	RkShf-I	078	ArpBd-E
015	RkShf-c	079	68BlId-1I
016	RkShf-E	080	68BlId-2I
017	GlmRk-I	081	68BlId-c
018	FlkRk-b	082	68BlId-d
019	FlkRk-c	083	68BlId-E
020	FlkRk-d	084	CWRk -E
021	ArtRk-d	085	Blgrs-I
022	ArtRk-E	086	Rumba-I
023	PubRk-I	087	Rumba-E
024	PubRk-E	088	Begin-c
025	70H&R-c	089	Tango-1I
026	70H&R-d	090	Tango-2I
027	HipH2-1I	091	Tango-E
028	HipH2-2I	092	Klzmr-E
029	HipH2-1b	093	Enka -b
030	HipH2-2b	094	Polka-I
031	HipH2-c	095	Polka-a
032	HipH2-d	096	Polka-b
033	HipH2-1E	097	Polka-c
034	HipH2-2E	098	Polka-d
035	SlwJm-I	099	Polka-E
036	SlwJm-b		
037	SlwJm-d		
038	SlwJm-E		
039	Bigbt-I		
040	Bigbt-a		
041	Bigbt-b		
042	Bigbt-d		
043	Bigbt-1E		
044	Bigbt-2E		
045	LitPp-I		
046	LitPp-a		
047	LitPp-b		
048	LitPp-c		
049	LitPp-d		
050	LitPp-1E		
051	LitPp-2E		
052	AORPp-I		
053	AORPp-a		
054	AORPp-E		
055	DtrPp-I		
056	DtrPp-E		
057	Md8Rk-I		
058	Md8Rk-b		
059	Md8Rk-d		
060	Md8Rk-E		
061	68R&B-I		
062	68R&B-c		
063	68R&B-d		
064	68R&B-E		

No.	Name	No.	Name
001	ClgRk-b	065	DgRk2-b
002	ClgRk-E	066	DgRk2-1c
003	FnkRk-I	067	DgRk2-2c
004	FnkRk-E	068	DgRk2-d
005	PrgHd-I	069	DgRk2-1E
006	PrgHd-E	070	DgRk2-2E
007	Gngst-1I	071	IndRk-1I
008	Gngst-2I	072	IndRk-2I
009	DncSw-I	073	IndRk-1a
010	DncSw-b	074	IndRk-2a
011	DncSw-c	075	IndRk-1b
012	DncSw-d	076	IndRk-2b
013	DncSw-E	077	IndRk-1E
014	R&BSw-I	078	IndRk-2E
015	R&BSw-a	079	SoShf-I
016	R&BSw-b	080	SoShf-a
017	R&BSw-c	081	SoShf-b
018	R&BSw-d	082	SoShf-c
019	R&BSw-1E	083	SoShf-d
020	R&BSw-2E	084	SoShf-E
021	Smoth-1I	085	70Dsc-I
022	Smoth-2I	086	70Dsc-E
023	Smoth-b	087	FPFNk-I
024	Smoth-c	088	FPFNk-a
025	Smoth-d	089	FPFNk-b
026	Smoth-E	090	FPFNk-c
027	PpTek-1I	091	FPFNk-d
028	PpTek-2I	092	FPFNk-E
029	PpTek-3I	093	JzFnk-I
030	PpTek-1a	094	Combz-I
031	PpTek-2a	095	Bebop-a
032	PpTek-b	096	Bebop-c
033	PpTek-1c	097	Bebop-d
034	PpTek-2c	098	AfrJz-I
035	PpTek-1d	099	OrgBd-I
036	PpTek-2d	100	OrgBd-E
037	PpTek-1E	101	LtnBd-I
038	PpTek-2E	102	LtnBd-E
039	PpTek-3E	103	Samba-I
040	EuTek-I	104	Samba-E
041	EuTek-a	105	Merng-I
042	EuTek-b	106	Merng-E
043	EuTek-c	107	Salsa-I
044	EuTek-d	108	Salsa-a
045	EuTek-E	109	Salsa-b
046	Eurbt-1I	110	Salsa-c
047	Eurbt-2I	111	Salsa-d
048	Eurbt-b	112	Salsa-E
049	Eurbt-d	113	SwRge-I
050	Eurbt-1E	114	SwRge-c
051	Eurbt-2E	115	SwRge-d
052	ElcRk-I	116	DHRge-I
053	ElcRk-b	117	DHRge-b
054	ElcRk-d	118	DHRge-c
055	ElcRk-E	119	DHRge-d
056	DgRk1-I	120	DHRge-1E
057	DgRk1-a	121	DHRge-2E
058	DgRk1-1b	122	Soca -1I
059	DgRk1-2b	123	Soca -2I
060	DgRk1-E	124	Soca -a
061	DgRk2-1I	125	Soca -b
062	DgRk2-2I	126	Soca -c
063	DgRk2-1a	127	Soca -1d
064	DgRk2-2a	128	Soca -2d

No.	Name
129	Soca -1E
130	Soca -2E

No.	Name
001	R&BWz-I
002	R&BWz-E
003	CWWlz-I
004	CWWlz-E
005	VnWlz-I
006	VnWlz-a
007	VnWlz-b
008	VnWlz-c
009	VnWlz-E
010	SIWlz-I
011	SIWlz-E

Phrase Category=PC: Percussion

Beat=8 beat

No.	Name	No.	Name	No.	Name
001	BrtRk-l	065	R&B -d	129	ChaCh-c
002	BrtRk-a	066	R&B -E	130	ChaCh-d
003	BrtRk-b	067	Motwn-l	131	ChaCh-E
004	BrtRk-c	068	Motwn-a	132	Bossa-l
005	BrtRk-d	069	Motwn-b	133	Bossa-a
006	BrtRk-E	070	Motwn-c	134	Bossa-b
007	RkShf-l	071	Motwn-d	135	Bossa-c
008	RkShf-a	072	Motwn-E	136	Bossa-d
009	RkShf-b	073	SIBlu-l	137	Bossa-E
010	RkShf-E	074	SIBlu-E	138	Begin-l
011	HipH2-l	075	Rcbly-l	139	Begin-a
012	HipH2-a	076	Rcbly-a	140	Begin-b
013	HipH2-b	077	Rcbly-c	141	Begin-c
014	HipH2-c	078	Rcbly-E	142	Begin-d
015	HipH2-d	079	Oldis-l	143	Begin-E
016	HipH2-E	080	Oldis-a	144	Hwian-l
017	SlwJm-l	081	Oldis-c	145	Hwian-a
018	SlwJm-a	082	Oldis-E	146	Hwian-b
019	SlwJm-b	083	DscFk-l	147	Hwian-c
020	SlwJm-c	084	DscFk-a	148	Hwian-d
021	SlwJm-d	085	DscFk-b	149	Hwian-E
022	SlwJm-E	086	DscFk-c	150	Klzmr-b
023	PpR&B-l	087	DscFk-d	151	Klzmr-d
024	PpR&B-a	088	DscFk-E	152	Klzmr-E
025	PpR&B-b	089	PnBld-l	153	Enka -l
026	PpR&B-c	090	PnBld-a	154	Enka -a
027	PpR&B-d	091	PnBld-b	155	Enka -b
028	PpR&B-E	092	PnBld-c	156	Enka -d
029	Bigbt-l	093	PnBld-E	157	Polka-d
030	Bigbt-d	094	68Bld-l	158	Foxtr-l
031	Bigbt-E	095	68Bld-a	159	Foxtr-a
032	AORPp-l	096	68Bld-b	160	Foxtr-b
033	AORPp-a	097	68Bld-c	161	Foxtr-c
034	AORPp-b	098	68Bld-d	162	Foxtr-d
035	AORPp-c	099	68Bld-E	163	Foxtr-E
036	AORPp-d	100	CWRk -l		
037	AORPp-E	101	CWRk -a		
038	BrtPp-l	102	CWRk -b		
039	BrtPp-a	103	CWRk -c		
040	BrtPp-b	104	CWRk -d		
041	BrtPp-c	105	CWRk -E		
042	BrtPp-d	106	CWPop-l		
043	BrtPp-E	107	CWPop-b		
044	DtrPp-l	108	CWPop-d		
045	DtrPp-a	109	CWPop-E		
046	DtrPp-b	110	CWBld-l		
047	DtrPp-c	111	CWBld-a		
048	DtrPp-d	112	CWBld-c		
049	DtrPp-E	113	CWBld-d		
050	Md8Rk-l	114	CWBld-E		
051	Md8Rk-b	115	Blgrs-l		
052	Md8Rk-c	116	Blgrs-b		
053	Md8Rk-d	117	Blgrs-c		
054	Md8Rk-E	118	Blgrs-d		
055	Acost-l	119	Blgrs-E		
056	Acost-a	120	Rumba-l		
057	Acost-b	121	Rumba-a		
058	Acost-c	122	Rumba-b		
059	Acost-d	123	Rumba-c		
060	Acost-E	124	Rumba-d		
061	R&B -l	125	Rumba-E		
062	R&B -a	126	ChaCh-l		
063	R&B -b	127	ChaCh-a		
064	R&B -c	128	ChaCh-b		

Beat=16 beat

No.	Name	No.	Name	No.	Name
001	IrsRk-l	065	DgRk2-1b	129	LtnBd-c
002	IrsRk-a	066	DgRk2-2b	130	LtnBd-d
003	IrsRk-b	067	DgRk2-c	131	LtnBd-E
004	IrsRk-c	068	DgRk2-1d	132	16Cnt-a
005	IrsRk-d	069	DgRk2-2d	133	16Cnt-c
006	IrsRk-E	070	DgRk2-1E	134	16Cnt-E
007	ClgRk-l	071	DgRk2-2E	135	Samba-l
008	ClgRk-a	072	IndRk-l	136	Samba-a
009	ClgRk-b	073	IndRk-a	137	Samba-b
010	ClgRk-c	074	IndRk-b	138	Samba-c
011	ClgRk-d	075	IndRk-d	139	Samba-E
012	ClgRk-E	076	IndRk-E	140	Mambo-l
013	FnkRk-l	077	LtnPp-l	141	Mambo-a
014	FnkRk-a	078	LtnPp-a	142	Mambo-b
015	FnkRk-c	079	LtnPp-b	143	Mambo-c
016	FnkRk-E	080	LtnPp-d	144	Mambo-d
017	LtnRk-l	081	LtnPp-E	145	Mambo-E
018	LtnRk-a	082	24bPp-l	146	Merng-1l
019	LtnRk-b	083	24bPp-a	147	Merng-2l
020	LtnRk-c	084	24bPp-b	148	Merng-3l
021	LtnRk-d	085	24bPp-c	149	Merng-1a
022	LtnRk-E	086	24bPp-d	150	Merng-2a
023	HipH1-l	087	24bPp-E	151	Merng-3a
024	HipH1-a	088	TcFsn-l	152	Merng-1b
025	HipH1-b	089	TcFsn-b	153	Merng-2b
026	HipH1-c	090	TcFsn-d	154	Merng-1c
027	HipH1-d	091	TcFsn-E	155	Merng-2c
028	HipH1-E	092	SoShf-l	156	Merng-3c
029	PpHip-l	093	SoShf-a	157	Merng-1d
030	PpHip-a	094	SoShf-b	158	Merng-2d
031	PpHip-c	095	SoShf-c	159	Merng-3d
032	PpHip-E	096	SoShf-d	160	Merng-1E
033	JzHip-l	097	SoShf-E	161	Merng-2E
034	JzHip-a	098	TrnTm-l	162	Merng-3E
035	JzHip-b	099	TrnTm-a	163	Salsa-l
036	JzHip-c	100	TrnTm-b	164	Salsa-a
037	JzHip-d	101	TrnTm-c	165	Salsa-b
038	JzHip-E	102	TrnTm-d	166	Salsa-c
039	DncSw-l	103	TrnTm-E	167	Salsa-d
040	DncSw-a	104	70Dsc-l	168	Salsa-E
041	DncSw-b	105	70Dsc-b	169	Regae-l
042	DncSw-c	106	70Dsc-d	170	Regae-a
043	DncSw-d	107	70Dsc-E	171	Regae-b
044	DncSw-E	108	JzFnk-l	172	Regae-c
045	House-l	109	JzFnk-b	173	Regae-d
046	House-a	110	JzFnk-c	174	Regae-E
047	House-c	111	JzFnk-d	175	SwRge-l
048	House-E	112	JzFnk-E	176	SwRge-a
049	R&BSw-l	113	ColJz-l	177	SwRge-b
050	R&BSw-a	114	ColJz-1b	178	SwRge-c
051	R&BSw-b	115	ColJz-2b	179	SwRge-d
052	R&BSw-c	116	ColJz-c	180	SwRge-E
053	R&BSw-d	117	ColJz-d	181	DHRge-l
054	R&BSw-E	118	ColJz-1E	182	DHRge-a
055	PpTek-l	119	ColJz-2E	183	DHRge-b
056	PpTek-b	120	AfrJz-l	184	DHRge-c
057	PpTek-d	121	AfrJz-a	185	DHRge-d
058	Eurbt-a	122	AfrJz-b	186	DHRge-E
059	Eurbt-c	123	AfrJz-c	187	LvsRk-l
060	Eurbt-E	124	AfrJz-d	188	LvsRk-a
061	DgRk2-1l	125	AfrJz-E	189	LvsRk-b
062	DgRk2-2l	126	LtnBd-l	190	LvsRk-d
063	DgRk2-1a	127	LtnBd-a	191	LvsRk-E
064	DgRk2-2a	128	LtnBd-b	192	Soca -l

Beat=3/4 beat

No.	Name
001	CWWlZ-l
002	CWWlZ-a
003	CWWlZ-b
004	CWWlZ-c
005	CWWlZ-d
006	VnWlZ-a
007	SIWlZ-l
008	SIWlZ-a
009	SIWlZ-b
010	SIWlZ-c
011	SIWlZ-d
012	SIWlZ-E
013	68Mrc-l
014	68Mrc-a
015	68Mrc-b
016	68Mrc-c
017	68Mrc-d
018	68Mrc-E

Phrase Category=PD: Pad
Beat=8 beat

No.	Name	No.	Name
001	BrtRk-l	065	DscFk-E
002	BrtRk-a	066	PnBld-l
003	BrtRk-b	067	PnBld-a
004	BrtRk-c	068	PnBld-b
005	BrtRk-d	069	PnBld-c
006	BrtRk-E	070	PnBld-d
007	GlmRk-E	071	PnBld-1E
008	HipH2-l	072	PnBld-2E
009	HipH2-a	073	ArpBd-a
010	HipH2-b	074	ArpBd-E
011	HipH2-c	075	68Bld-l
012	HipH2-d	076	68Bld-a
013	HipH2-E	077	68Bld-b
014	Rap -1l	078	68Bld-c
015	Rap -2l	079	68Bld-d
016	Rap -a	080	68Bld-E
017	Rap -1b	081	CWBld-l
018	Rap -2b	082	CWBld-a
019	Rap -c	083	CWBld-b
020	Rap -1d	084	CWBld-c
021	Rap -2d	085	CWBld-E
022	Rap -1E	086	Rumba-l
023	Rap -2E	087	Rumba-a
024	SlwJm-l	088	Rumba-b
025	SlwJm-a	089	Rumba-c
026	SlwJm-b	090	Rumba-E
027	SlwJm-c	091	ChaCh-a
028	SlwJm-d	092	ChaCh-b
029	SlwJm-E	093	ChaCh-c
030	PpR&B-b	094	ChaCh-E
031	PpR&B-c	095	Bossa-1l
032	PpR&B-d	096	Bossa-2l
033	PpR&B-E	097	Bossa-1b
034	LitPp-l	098	Bossa-2b
035	LitPp-b	099	Bossa-1c
036	LitPp-d	100	Bossa-2c
037	LitPp-E	101	Bossa-d
038	AORPp-b	102	Bossa-1E
039	AORPp-d	103	Bossa-2E
040	AORPp-E	104	Begin-l
041	DtrPp-l	105	Begin-a
042	DtrPp-b	106	Begin-b
043	DtrPp-d	107	Begin-c
044	DtrPp-E	108	Begin-d
045	Md8Rk-l	109	Begin-E
046	Md8Rk-a	110	Tango-b
047	Md8Rk-b	111	Tango-c
048	Md8Rk-c	112	Enka -1l
049	Md8Rk-E	113	Enka -2l
050	Acost-l	114	Enka -c
051	Acost-a	115	Enka -d
052	Acost-b	116	Enka -1E
053	Acost-c	117	Enka -2E
054	Acost-d	118	Foxtr-a
055	Acost-E	119	Foxtr-b
056	Oldis-l	120	Foxtr-c
057	Oldis-a	121	Foxtr-d
058	Oldis-b	122	Foxtr-E
059	Oldis-c		
060	Oldis-d		
061	Oldis-E		
062	DscFk-l		
063	DscFk-b		
064	DscFk-d		

Beat=16 beat

No.	Name	No.	Name
001	IrsRk-l	065	24bPp-E
002	IrsRk-a	066	70Dsc-l
003	IrsRk-b	067	70Dsc-b
004	IrsRk-c	068	70Dsc-d
005	IrsRk-d	069	70Dsc-E
006	IrsRk-E	070	OrgBd-b
007	PrgHd-b	071	OrgBd-d
008	PrgHd-d	072	OrgBd-E
009	PrgHd-E	073	Regae-l
010	HipH1-l	074	Regae-b
011	HipH1-b	075	Regae-d
012	HipH1-c	076	Regae-E
013	HipH1-d	077	DHRge-l
014	HipH1-E	078	DHRge-b
015	Gngst-a	079	DHRge-c
016	Gngst-b	080	DHRge-E
017	Gngst-c	081	LvsRk-l
018	Gngst-d	082	LvsRk-b
019	Gngst-E	083	LvsRk-c
020	House-l	084	LvsRk-d
021	House-b	085	LvsRk-E
022	House-d		
023	GrgHs-l		
024	GrgHs-b		
025	GrgHs-d		
026	R&BSw-l		
027	R&BSw-a		
028	R&BSw-b		
029	R&BSw-c		
030	R&BSw-d		
031	R&BSw-E		
032	Smoth-1l		
033	Smoth-2l		
034	Smoth-1a		
035	Smoth-2a		
036	Smoth-1b		
037	Smoth-2b		
038	Smoth-1c		
039	Smoth-2c		
040	Smoth-1d		
041	Smoth-2d		
042	Smoth-1E		
043	Smoth-2E		
044	EuTek-l		
045	EuTek-a		
046	EuTek-b		
047	EuTek-c		
048	EuTek-d		
049	EuTek-E		
050	DgRk2-l		
051	DgRk2-a		
052	DgRk2-b		
053	DgRk2-c		
054	DgRk2-d		
055	DgRk2-E		
056	16bPp-l		
057	16bPp-b		
058	16bPp-d		
059	16bPp-E		
060	24bPp-l		
061	24bPp-a		
062	24bPp-b		
063	24bPp-c		
064	24bPp-d		

Beat=3/4 beat

No.	Name
001	VnWlz-l
002	VnWlz-a
003	VnWlz-1b
004	VnWlz-2b
005	VnWlz-1c
006	VnWlz-2c
007	VnWlz-1d
008	VnWlz-2d
009	VnWlz-1E
010	VnWlz-2E
011	SlWlz-l
012	SlWlz-a
013	SlWlz-b
014	SlWlz-c
015	SlWlz-d
016	SlWlz-E

Phrase Category=SE: Sound Effects
Beat=8 beat

No.	Name
001	60Hd -l
002	60Hd -E
003	AmHR1-1l
004	AmHR1-2l
005	AmHR1-c
006	AmHR1-E
007	Rap -l
008	Rap -a
009	Rap -b
010	Rap -c
011	Rap -d
012	Rap -E
013	PpR&B-l
014	PpR&B-a
015	PpR&B-b
016	PpR&B-c
017	PpR&B-d
018	PpR&B-E
019	PycRk-l
020	PycRk-1c
021	PycRk-2c
022	PycRk-d
023	PycRk-1E
024	PycRk-2E
025	SufRk-l
026	SufRk-b
027	SufRk-E

Beat=16 beat

No.	Name
001	SpdMt-l
002	SpdMt-d
003	PwrMt-b
004	DooMt-l
005	DooMt-d
006	MtBgy-l
007	MtBgy-d
008	MtBgy-E
009	HipH1-l
010	HipH1-a
011	HipH1-c
012	HipH1-1E
013	HipH1-2E
014	PpHip-b
015	PpHip-c
016	PpHip-d
017	Gngst-b
018	Gngst-d
019	Gngst-1E
020	Gngst-2E
021	GrgHs-l
022	GrgHs-E
023	Smoth-l
024	Smoth-c
025	Smoth-d
026	Smoth-E
027	DgRk1-l
028	DgRk1-a
029	DgRk1-1b
030	DgRk1-2b
031	DgRk1-c
032	DgRk1-d
033	DgRk1-1E
034	DgRk1-2E
035	DgRk2-l
036	DgRk2-b
037	DgRk2-d
038	DgRk2-E
039	IndRk-c

Beat=3/4 beat

No.	Name
001	Wonder

Fingered Chord List

■ Using the Fingered Chord function, press the keyboard keys, as shown in the chart, to input chord types.
(Notes in chord when root is C.)

C

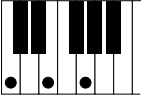

Cadd9

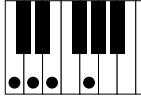

CM7



CM7(9)

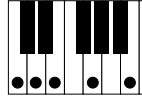

C6

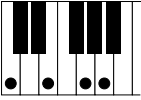

Caug

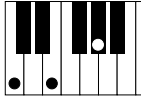

C7

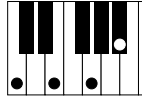

C7(9)

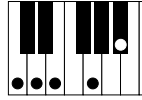

C7(b9)

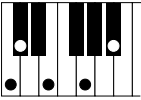

C7(#9)

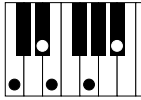

C7(13)

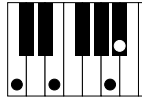

C7(b13)



C7(#5)

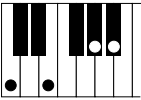

C7(#11)

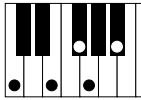

Cm

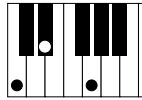

Cmadd9

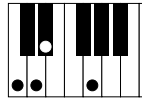

Cm7

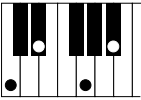

Cm7(9)

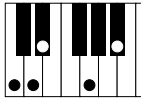

Cm6

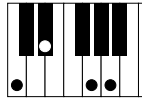

CmM7

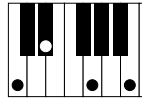

Cm7(b5)

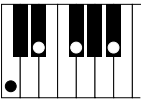

Cm7(11)

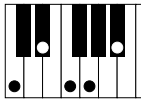

Csus4

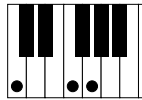

C7sus4

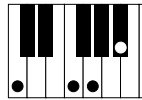

Cdim

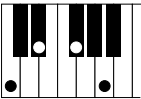

Chord Type List

Chord Type

M
major

1, 3, 5

Read

Scale degrees
1:Root
3:3rd above root
5:5th above root

Notes in chord when root is C.
1:C, 3:E, 5:G

7(#9)
seventh sharp ninth

1, 3, 5, ♭7, #9

7(♭9)
seventh flatted ninth

1, 3, 5, ♭7, ♭9

7(♭13)
seventh added flatted thirteenth

1, 3, 5, ♭7, ♭13

7(13)
seventh added thirteenth

1, 3, 5, ♭7, 13

7(#11)
seventh added sharp eleventh

1, 3, 5, ♭7, #11

7(#5)
seventh sharp fifth

1, 3, #5, ♭7

add9
added ninth

1, 3, 5, 9

M
major

1, 3, 5

M7(9)
major seventh ninth

1, 3, 5, 7, 9

M7
major seventh

1, 3, 5, 7

aug
augmented

1, 3, #5

6
sixth



1, 3, 5, 6









7(9)
seventh ninth

1, 3, 5, ♭7, 9

7
seventh

1, 3, 5, ♭7

<p style="text-align: center;">7sus4 seventh suspended fourth</p> <p style="text-align: center;">1, 4, 5, ♭7</p> 	<p style="text-align: center;">*2 --- non-ABC</p> <p>The "---" chord type marking is a special "non-ABC" type that can be used to transpose accompaniment patterns to the selected chord root without re-harmonization.</p>
<p style="text-align: center;">sus4 suspended fourth</p> <p style="text-align: center;">1, 4, 5</p> 	<p style="text-align: center;">dim diminished</p> <p style="text-align: center;">1, ♭3, ♭5, 6</p> 

<p style="text-align: center;">*1 madd9 minor added ninth</p> <p style="text-align: center;">1, ♭3, 5, 9</p> 	<p style="text-align: center;">m7(9) minor seventh ninth</p> <p style="text-align: center;">1, ♭3, 5, ♭7, 9</p> 	<p style="text-align: center;">mM7 minor major seventh</p> <p style="text-align: center;">1, ♭3, 5, 7</p> 	<p style="text-align: center;">m7(11) minor seventh added eleventh</p> <p style="text-align: center;">1, ♭3, 5, ♭7, 11</p> 
<p style="text-align: center;">m minor</p> <p style="text-align: center;">1, ♭3, 5</p> 	<p style="text-align: center;">m7 minor seventh</p> <p style="text-align: center;">1, ♭3, 5, ♭7</p> 	<p style="text-align: center;">m6 minor sixth</p> <p style="text-align: center;">1, ♭3, 5, 6</p> 	<p style="text-align: center;">m7(♭5) minor seventh flatted fifth</p> <p style="text-align: center;">1, ♭3, ♭5, ♭7</p> 

*1 Due to space limitations, "add9", for madd9 (minor added ninth) chords, is indicated above "m" on the micro keyboard.

*2 Some preset patterns have their own chord progressions. Use the "---" (non-ABC) to retain the "character" of the chord progressions when playing these patterns.

Chord Template List

#	Name	Chord Progression Type	Chord Progression (when the key is C)
00	USR	User	
Pops type			
01	POPS-M01		C Am Dm G7
02	POPS*M01	(Double time feel)	C/Am Dm/G7 C/Am Dm/G7
03	POPS-M02		C F C G7
04	POPS-m02	(Double time feel) (Minor)	Cm Fm Cm G7
05	POPS*M02	(Double time feel)	C/F C/G7 C/F C/G7
06	POPS*m02	(Minor) (Double time feel)	Cm/Fm Cm/G7 Cm/Fm Cm/G7
07	POPS-M03		C Em F G7
08	POPS*M03	(Double time feel)	C/Em F/G7 C/Em F/G7
09	POPS-M04		C Am F G Em Am Dm G7
10	POPS*M04	(Double time feel)	C/Am F/G Em/Am Dm/G7
11	POPS-M05	Starts with 4th	F Em Dm C
12	POPS*M05	Starts with 4th (Double time feel)	F/Em Dm/C F/Em Dm/C
13	POPS-M06	Starts with minor 6th	Am D G7 C
14	POPS*M06	Starts with minor 6th (Double time feel)	Am/D G7/C Am/D G7/C
15	POPS-m07	Progresses in 4ths	Cm Fm Bb Eb Ab Dm7(b5) G G7
16	POPS*m07	Progresses in 4ths (Double time feel)	Cm/Fm Bb/Eb Ab/Dm7(b5) G/G7
17	POPS-M08	J-Techno	C Ab Bb G7
18	POPS*M08	J-Techno (Double time feel)	C/Ab Bb/G7 C/Ab Bb/G7
19	POPS-M09		C C Am Am F G C G7
20	POPS*M09	(Double time feel)	C Am F/G C/G7
21	POPS-M10		C G Am F C G F C
22	POPS*M10	(Double time feel)	C/G Am/F C/G F/C
23	POPS-M11		C Dm Em F
24	POPS*M11	(Double time feel)	C/Dm Em/F C/Dm Em/F
Ballad type			
25	BALAD-M1		CM7 CM7 FM7 FM7
26	BALAD-m1	(Minor)	Cm7 Cm7 Fm7 Fm7
27	BALAD*M1	(Double time feel)	CM7 FM7 CM7 FM7
28	BALAD*m1	(Minor) (Double time feel)	Cm7 Fm7 Cm7 Fm7
29	BALAD-M2		FM7 Em7 Dm7 CM7
30	BALAD*M2	(Double time feel)	FM7/Em7 Dm7/CM7 FM7/Em7 Dm7/CM7
31	BALAD-M3		CM7 Em7 FM7 G7
32	BALAD*M3	(Double time feel)	CM7/Em7 FM7/G7 CM7/Em7 FM7/G7
33	BALAD-M4		CM7 Cm6 Bm7 Em7 Am7 D7 GM7 G7
34	BALAD*M4	(Double time feel)	CM7/Cm6 Bm7/Em7 Am7/D7 GM7/G7
35	BALAD-M5		CM7 FM7 Bm7(b5) E7 Am7 D7 F onG G7
36	BALAD*M5	(Double time feel)	CM7/FM7 Bm7(b5)/E7 Am7/D7 F onG/G7
37	BALAD-m6	Progresses in 4ths	Cm7 Fm7 Bb7 EbM7 AbM7 Dm7(b5) G7 Cm7
38	BALAD*m6	Progresses in 4ths (Double time feel)	Cm7/Fm7 Bb7/EbM7 AbM7/Dm7(b5) G7/Cm7
Blues			
39	BLUES-M1	for Rock and Blues	C7 C7 C7 C7 F7 F7 C7 C7 G7 F7 C7 G7
40	BLUES-m1	for Rock and Blues (Minor)	Cm7 Cm7 Cm7 Cm7 Fm7 Fm7 Cm7 Cm7 G7 Fm7 Cm7 G7
41	BLUES*M1	for Rock and Blues (Double time feel)	C7 C7 F7 C7 G7/F7 C7/G7 C7 C7 F7 C7 G7/F7 C7/G7
42	BLUES*m1	for Rock and Blues (Minor) (Double time feel)	Cm7 Cm7 Fm7 Cm7 G7/Fm7 Cm7/G7 Cm7 Cm7 Fm7 Cm7 G7/Fm7 Cm7/G7
43	BLUES-M2	for Jazz	C7(9) F7(9) C7(9) C7(9) F7(9) F7(9) C7(9) A7(b13) D7(9) G7(9) C7(9)/E7(9) D7(9)/C7#(9)
44	BLUES*M2	for Jazz (Double time feel)	C7(9)/F7(9) C7(9) F7(9) C7(9)/A7(b13) D7(9)/G7(9) C7(9)/E7(9)/D7(9)/C7#(9) C7(9)/F7(9) C7(9) F7(9) C7(9)/A7(b13) D7(9)/G7(9) C7(9)/E7(9)/D7(9)/C7#(9)
45	BLUES-m3	for Jazz	Cm7(9) Fm7(9) Cm7(9) Cm7(9) Fm7(9) Fm7(9) Cm7(9) Cm7(9) G7 Fm7(9) Cm7(9)/Fm7(9) Cm7(9)/G7
46	BLUES*m3	for Jazz (Double time feel)	Cm7(9)/Fm7(9) Cm7(9) Fm7(9) Cm7(9) G7/Fm7(9) Cm7(9)/Fm7(9) Cm7(9) Fm7(9) Cm7(9) G7/Fm7(9) Cm7(9)/G7
47	BLUES-M4	for Blues	C7 F7 C7/C#7 C7 F7 F7 C7/Dm7 Em7/Eb7m7 Dm7 Ebm7/D7 C7/F7 C7/G aug
48	BLUES*M4	for Blues (Double time feel)	C7/F7 C7/C#7/C7 F7 C7/Dm7/Em7/Eb7m7 Dm7/Eb7m7/D7 C7/F7/C7/G aug C7/F7 C7/C#7/C7 F7 C7/Dm7/Em7/Eb7m7 Dm7/Eb7m7/D7

Chord Template List

#	Name	Chord Progression Type	Chord Progression (when the key is C)
On Bass			
49	OnBAS-M1		C F onC Fm onC C
50	OnBAS*M1	(Double time feel)	C/F onC Fm onC/C C/F onC Fm onC/C
51	OnBAS-M2		C B \flat onC F onC C
52	OnBAS-m2	(Minor)	Cm B \flat onC Fm onC Cm
53	OnBAS*M2	(Double time feel)	C/B \flat onC F onC/C C/B \flat onC F onC/C
54	OnBAS*m2	(Minor) (Double time feel)	Cm/B \flat onC Fm onC/Cm Cm/B \flat onC Fm onC/Cm
55	OnBAS-M3		C G onC B \flat onC F onC
56	OnBAS*M3	(Double time feel)	C/G onC B \flat onC/F onC C/G onC B \flat onC/F onC
57	OnBAS-M4		C G onC F onC Fm onC
58	OnBAS*M4	(Double time feel)	C/G onC F onC/Fm onC C/G onC F onC/Fm onC
59	OnBAS-M5		C E \flat onC Dm onC C
60	OnBAS-m5	(Minor)	Cm E \flat onC Dm onC Cm
61	OnBAS*M5	(Double time feel)	C/E \flat onC Dm onC/C C/E \flat onC Dm onC/C
62	OnBAS*m5	(Minor) (Double time feel)	Cm/E \flat onC Dm onC/Cm Cm/E \flat onC Dm onC/Cm
63	OnBAS-M6		B \flat onC F onC C C
64	OnBAS*M6	(Double time feel)	B \flat onC/F onC C C B \flat onC/F onC C C
65	OnBAS-M7		C A \flat onC B \flat onC C
66	OnBAS-m7	(Minor)	Cm A \flat onC B \flat onC Cm
67	OnBAS*M7	(Double time feel)	C/A \flat onC B \flat onC/C C/A \flat onC B \flat onC/C
68	OnBAS*m7	(Minor) (Double time feel)	Cm/A \flat onC B \flat onC/Cm Cm/A \flat onC B \flat onC/Cm
Cliché type			
69	CLCHE-M1		C G onB Am C7 onG F C onE Dm7 G7
70	CLCHE*M1	(Double time feel)	C/G onB Am/C7 onG F/C onE Dm7/G7
71	CLCHE-M2		C G onB C7 onB \flat F onA Fm onA \flat C onG D onF# G7
72	CLCHE-m2	(Minor)	Cm G onB Cm7 onB \flat F onA Fm onA \flat Cm onG D onF# G7
73	CLCHE*M2	(Double time feel)	C/G onB C7 onB \flat /F onA Fm onA \flat /C onG D onF# G7
74	CLCHE*m2	(Minor) (Double time feel)	Cm/G onB Cm7 onB \flat /F onA Fm onA \flat /Cm onG D onF# G7
75	CLCHE-M3		C C7 onB \flat F onA Fm onA \flat C onG F#m7(♭5) Gsus4 G7
76	CLCHE-m3	(Minor)	Cm Cm7 onB \flat F onA Fm onA \flat Cm onG F#dim Gsus4 G7
77	CLCHE*M3	(Double time feel)	C/C7 onB \flat F onA/Fm onA \flat C onG/F#m7(♭5) Gsus4/G7
78	CLCHE*m3	(Minor) (Double time feel)	Cm/Cm7 onB \flat F onA/Fm onA \flat Cm onG/F#dim Gsus4/G7
79	CLCHE-m4		Cm/Cm7 onB \flat F onA/Fm onA \flat Cm onG/F#dim Gsus4/G7
80	CLCHE*M4	(Double time feel)	Cm/Cm7 onB \flat F onA/Fm onA \flat Cm onG/F#dim Gsus4/G7
81	CLCHE-m5		C C# dim Dm7 E \flat dim Em7 Am7 Dm7 G7
82	CLCHE*M5	(Double time feel)	C/C# dim Dm7/E \flat dim Em7/Am7 Dm7/G7
83	CLCHE-m6		Cm G onD E \flat C7 onE Fm F# dim Gsus4 G7
84	CLCHE*m6	(Double time feel)	Cm/G onD E \flat /C7 onE Fm/F# dim Gsus4/G7
Tension type			
85	TENSN-M1		C7(13) C7(13) F7(13) F7(13) C7(13) C7(13) F7(13) F7(13)
86	TENSN-m1	(Minor)	Cm7(11) Cm7(11) Fm7(11) Fm7(11)
87	TENSN*M1	(Double time feel)	C7(13) F7(13) C7(13) F7(13)
88	TENSN*m1	(Minor) (Double time feel)	Cm7(11) Fm7(11) Cm7(11) Fm7(11)
89	TENSN-M2		C7(13) C7(13) B \flat 7(13) B \flat 7(13)
90	TENSN-m2	(Minor)	Cm7(11) Cm7(11) Bm \flat 7(11) Bm \flat 7(11)
91	TENSN*M2	(Double time feel)	C7(13) B \flat 7(13) C7(13) B \flat 7(13)
92	TENSN*m2	(Minor) (Double time feel)	Cm7(11) Bm \flat 7(11) Cm7(11) Bm \flat 7(11)
93	TENSN-m3		Cm7(11) Csus4 onA D7(#9) G7(♭13)
94	TENSN*M3	(Double time feel)	Cm7(11)/Csus4 onA D7(#9)/G7(♭13) Cm7(11)/Csus4 onA D7(#9)/G7(♭13)
95	TENSN-m4		Cm7(11) F7(♭13) Dm7(9) G7(13)
96	TENSN*m4	(Double time feel)	Cm7(11)/F7(♭13) Dm7(9)/G7(13) Cm7(11)/F7(♭13) Dm7(9)/G7(13)
97	TENSN-M5		CM7(9) Cm7(9) Dm7 onC Fm6 onC
98	TENSN*M5	(Double time feel)	CM7(9)/Cm7(9) Dm7 onC/Fm6 onC CM7(9)/Cm7(9) Dm7 onC/Fm6 onC
Diatonic chord			
99	DIATONIC		CM7 Dm7 Em7 FM7 G7 Am7 Bm7(♭5) CM7

Drum Table

No.	Category	Instrument
1	Bass Drum	Bass Drum L
2		Bass Drum M
3		Bass Drum H
4	Snare	Snare L
5		Snare M
6		Snare H
7		Open Rimshot
8		Brush Slap
9		Side Stick
10		Hand Clap
11		Mid Tom
12	Hi Hat	Ride Cymbal
13		Cabasa
14		Maracas
15		Triangle
16		Shaker
17		Tambourine
18	Bongo-Conga	Bongo-Conga
19	Solo	Solo BassDr
20		Solo SnareDr
21		Solo Hi-Hat
22	Mute	Mute BassDr
23		Mute SnareDr
24		Mute Hi-Hat

Amp Simulator List

● Amp Simulator Setups

No.	Setup Name	Preamp Block Type	Chorus Block Type	Reverb Block Type
G01	MultiDrive	AMP SIMULATOR	NO EFFECT	ROOM1
G02	LightCrunch	AMP SIMULATOR	NO EFFECT	ROOM3
G03	StudioLead	OVER DRIVE	CHORUS2	STAGE1
G04	CleanLead	OVER DRIVE	CELESTE1	HALL2
G05	HardBlues	AMP SIMULATOR	NO EFFECT	ROOM1
G06	JetFlange	DISTORTION	FLANGER3	STAGE1
G07	PopRhythm	DISTORTION	CHORUS1	WHITE ROOM
G08	HeavyRock	DISTORTION	NO EFFECT	ROOM3
G09	StackLead	OVER DRIVE	CHORUS4	ROOM1
G10	FunkyCut	DISTORTION	FLANGER1	HALL2
G11	TradBlues	AMP SIMULATOR	NO EFFECT	ROOM1
G12	StageLead	OVER DRIVE	CELESTE1	STAGE2
G13	AirDrive	OVER DRIVE	CHORUS3	NO EFFECT
G14	CityLead	DISTORTION	CHORUS1	WHITE ROOM
G15	PopChorus	OVER DRIVE	CHORUS3	ROOM2
G16	FuzzyMod	DISTORTION	CELESTE2	ROOM2
G17	JazzyNight	OVER DRIVE	CHORUS2	HALL1
G18	Ghost	DISTORTION	CHORUS1	ROOM3

No.	Setup Name	Delay Block Type	Chorus Block Type	Reverb Block Type
M01	PopVocal	DELAY LR	CELESTE1	TUNNEL
M02	RockVocal	DELAY LR	NO EFFECT	NO EFFECT
M03	DelayVocal	DELAY LR	NO EFFECT	PLATE
M04	RoomVocal	DELAY LR	NO EFFECT	ROOM3
M05	Rap	DELAY LR	FLANGER3	NO EFFECT

● Amp Simulator Block Types

AMP SIMULATOR

Parameter	Value
Drive	0 - 127
-----	-----
-----	-----
-----	-----
-----	-----
-----	-----

DELAY LR

Parameter	Value
Lch Deley	0.1ms - 715.0ms
Rch Delay	0.1ms - 715.0ms
FB Delay1	0.1ms - 715.0ms
FB Delay2	0.1ms - 715.0ms
FB Dly Lvl	-63 - +63

DISTORTION, OVERDRIVE

Parameter	Value
Drive	0 - 127
EQ LowGain	-12db - +12db
EQ Hi Gain	-12db - +12db
-----	-----
-----	-----

CHORUS 1, 2, 3, 4

CELESTE 1, 2

FLANGER 1, 3

Parameter	Value
Mod Speed	0.00Hz - 39.7Hz
Mod Depth	0 - 127
FB Level	-63 - 63

HALL1, 2 ROOM1, 2, 3 STAGE1, 2, PLATE WHITE ROOM,TUNNEL

Parameter	Value
Reverb Lvl	0 - 127

MIDI Data Format

■ Tone generator part

(1) TRANSMIT FLOW

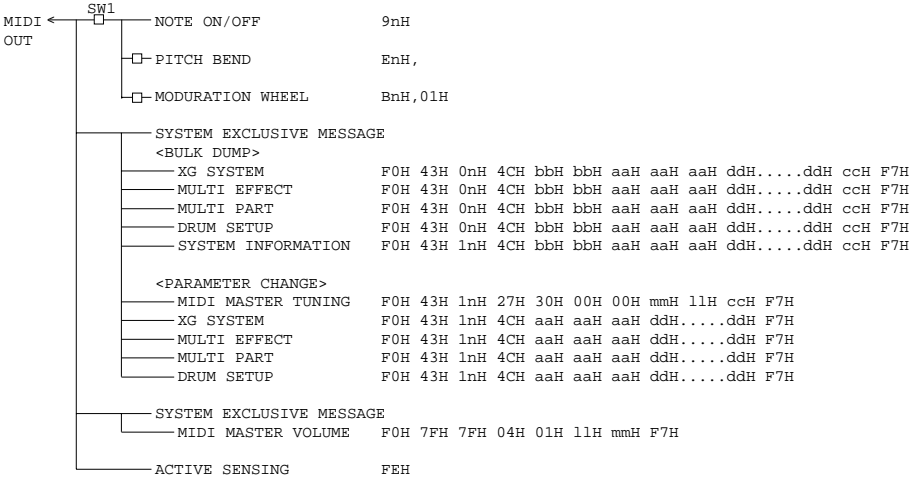

SW1 MIDI Transmit Channel
 The MIDI Transmit Channel is selected with track select.

(2) RECEIVE FLOW

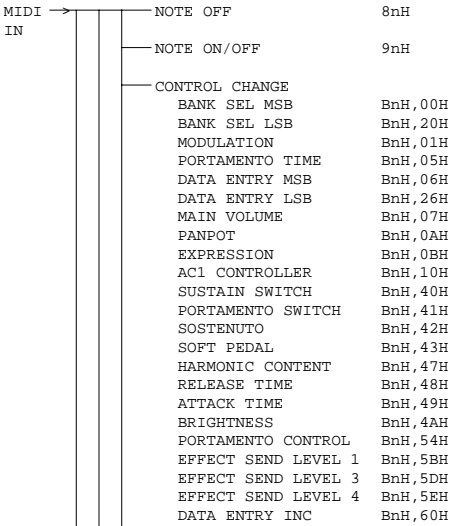

M I D I D a t a F o r m a t

DATA ENTRY DEC	BnH, 61H
NRPN	
VIBRATO RATE	BnH, 63H, 01H, 62H, 08H, 06H, mmH
VIBRATO DEPTH	BnH, 63H, 01H, 62H, 09H, 06H, mmH
VIBRATO DELAY	BnH, 63H, 01H, 62H, 0AH, 06H, mmH
FILTER CUTOFF FREQ.	BnH, 63H, 01H, 62H, 20H, 06H, mmH
FILTER RESONANCE	BnH, 63H, 01H, 62H, 21H, 06H, mmH
AEG ATTACK TIME	BnH, 63H, 01H, 62H, 63H, 06H, mmH
AEG DECAY TIME	BnH, 63H, 01H, 62H, 64H, 06H, mmH
AEG RELEASE TIME	BnH, 63H, 01H, 62H, 66H, 06H, mmH
DRUM INST	
CUTOFF FREQ.	BnH, 63H, 14H, 62H, rrH, 06H, mmH
FILTER RESONANCE	BnH, 63H, 15H, 62H, rrH, 06H, mmH
AEG ATTACK RATE	BnH, 63H, 16H, 62H, rrH, 06H, mmH
AEG DECAY RATE	BnH, 63H, 17H, 62H, rrH, 06H, mmH
PITCH COARSE	BnH, 63H, 18H, 62H, rrH, 06H, mmH
LEVEL	BnH, 63H, 1AH, 62H, rrH, 06H, mmH
PANPOT	BnH, 63H, 1CH, 62H, rrH, 06H, mmH
REVERB SEND	BnH, 63H, 1DH, 62H, rrH, 06H, mmH
CHORUS SEND	BnH, 63H, 1EH, 62H, rrH, 06H, mmH
VARIATION SEND	BnH, 63H, 1FH, 62H, rrH, 06H, mmH
RPN	
PITCH BEND SENS.	BnH, 64H, 00H, 65H, 00H, 06H, mmH
FINE TUNING	BnH, 64H, 01H, 65H, 00H, 06H, mmH, 26H, 11H
COARSE TUNING	BnH, 64H, 02H, 65H, 00H, 06H, mmH
RPN RESET	BnH, 64H, 7FH, 65H, 7FH
ALL SOUND OFF	BnH, 78H, 00H
RESET ALL CONTROLLERS	BnH, 79H, 00H
ALL NOTE OFF	BnH, 7BH
OMNI MODE OFF	BnH, 7CH
OMNI MODE ON	BnH, 7DH
MONO MODE	BnH, 7EH
POLY MODE	BnH, 7FH
PROGRAM CHANGE	CnH
CHANNEL AFTER TOUCH	DnH
PITCH BEND CHANGE	EnH
SYSTEM EXCLUSIVE MESSAGE	
<BULK DUMP>	
— XG SYSTEM	F0H 43H 0nH 4CH bbH bbH aaH aaH aaH ddH....ddH ccH F7H
— MULTI EFFECT	F0H 43H 0nH 4CH bbH bbH aaH aaH aaH ddH....ddH ccH F7H
— MULTI PART	F0H 43H 0nH 4CH bbH bbH aaH aaH aaH ddH....ddH ccH F7H
— DRUM SETUP	F0H 43H 0nH 4CH bbH bbH aaH aaH aaH ddH....ddH ccH F7H
<PARAMETER CHANGE>	
— MIDI MASTER TUNING	F0H 43H 1nH 27H 30H 00H 00H mmH 11H ccH F7H
— XG SYSTEM ON	F0H 43H 1nH 4CH 00H 00H 7EH 00H F7H
— XG SYSTEM	F0H 43H 1nH 4CH aaH aaH aaH ddH....ddH F7H
— MULTI EFFECT	F0H 43H 1nH 4CH aaH aaH aaH ddH....ddH F7H
— MULTI PART	F0H 43H 1nH 4CH aaH aaH aaH ddH....ddH F7H
— DRUM SETUP	F0H 43H 1nH 4CH aaH aaH aaH ddH....ddH F7H
<BULK DUMP REQUEST>	
— XG SYSTEM	F0H 43H 2nH 4CH aaH aaH aaH F7H
— MULTI EFFECT	F0H 43H 2nH 4CH aaH aaH aaH F7H
— MULTI PART	F0H 43H 2nH 4CH aaH aaH aaH F7H
— DRUM SETUP	F0H 43H 2nH 4CH aaH aaH aaH F7H
— SYSTEM INFORMATION	F0H 43H 2nH 4CH aaH aaH aaH F7H
<PARAMETER REQUEST>	
— XG SYSTEM	F0H 43H 3nH 4CH aaH aaH aaH F7H
— MULTI EFFECT	F0H 43H 3nH 4CH aaH aaH aaH F7H
— MULTI PART	F0H 43H 3nH 4CH aaH aaH aaH F7H
— DRUM SETUP	F0H 43H 3nH 4CH aaH aaH aaH F7H
SYSTEM EXCLUSIVE MESSAGE	
GM MODE ON	F0H 7EH 7FH 09H 01H F7H
MIDI MASTER VOLUME	F0H 7FH 7FH 04H 01H 11H mmH F7H
ACTIVE SENSING	FEH

(3) TRANSMIT/RECEIVE DATA

(3-1) CHANNEL VOICE MESSAGES

(3-1-1) NOTE OFF

STATUS	1000nnnn (8nH)	n = 0 ~ 15 VOICE CHANNEL NUMBER
NOTE NUMBER	0kkkkkkk	k = 0 (C-2) ~ 127 (G8)
VELOCITY	0vvvvvvv	v is ignored

Received only.

(3-1-2) NOTE ON/OFF

STATUS	1001nnnn (9nH)	n = 0 ~ 15 VOICE CHANNEL NUMBER
NOTE NUMBER	0kkkkkkk	k = 0 (C-2) ~ 127 (G8)
VELOCITY	0vvvvvvv	(v≠0) NOTE ON
	00000000	(v=0) NOTE OFF

(3-1-3) PROGRAM CHANGE

STATUS	1100nnnn (CnH)	n = 0 ~ 15 VOICE CHANNEL NUMBER
PROGRAM NUMBER	0ppppppp	p = 0 ~ 127

* The XG DRUM VOICE NUMBER corresponds to the PROGRAM NUMBER.

P = 1	DR1	Standard
P = 2	DR2	Standard2
P = 3	DR3	Dry
P = 4	DR4	Bright
P = 9	DR5	Room
P = 10	DR6	Dark
P = 17	DR7	Rock
P = 18	DR8	Rock2
P = 25	DR9	Electro
P = 26	DR10	Analog
P = 27	DR11	Analog2
P = 28	DR12	Dance
P = 29	DR13	HipHop
P = 30	DR14	Jungle
P = 33	DR15	Jazz
P = 34	DR16	Jazz2
P = 41	DR17	Brush
P = 49	DR18	Symphony
P = 113	DR19	R&B
P = 114	DR20	Rock3

* The XG SFX KIT NUMBER corresponds to the PROGRAM NUMBER.

P = 1	DR21	SFX1
P = 2	DR22	SFX2

If while a Drum Voice being selected, a Program Change for a different Drum Voice is received, the Drum Setup that was currently being used by the Drum Voice will be reset to the setting of new Drum Voice.

(3-1-4) CHANNEL AFTER TOUCH

STATUS	1101nnnn (DnH)	n = 0 ~ 15 VOICE CHANNEL NUMBER
VALUE	0vvvvvvv	v = 0 ~ 127 AFTER TOUCH VALUE

(3-1-5) PITCH BEND CHANGE

STATUS	1110nnnn (EnH)	n = 0 ~ 15 VOICE CHANNEL NUMBER
LSB	0vvvvvvv	PITCH BEND CHANGE LSB
MSB	0vvvvvvv	PITCH BEND CHANGE MSB

14 bit resolution

MSB	
0000000B (00H)	minimum value
01000000B (40H)	center value
01111111B (7FH)	maximum Value

(3-1-6) CONTROL CHANGE

STATUS 1011nnnn (BnH) n = 0 ~ 15 VOICE CHANNEL NUMBER
 CONTROL NUMBER 0ccccccc
 CONTROL VALUE 0vvvvvvv

* The CONTROL NUMBER to be transmitted.

c = 0	BANK SEL MSB	; v = 0 :XG NORMAL, 64 :SFX NORMAL, 126 :XG SFX KIT, 127 :XG DRUM	
c = 32	BANK SEL LSB	; v = 0 - 127	*3
c = 1	MODULATION	; v = 0 - 127	*2
c = 7	MAIN VOLUME	; v = 0 - 127	
c = 10	PANPOT	; v = 0 - 127	
c = 71	HARMONIC CONTENT	; v = 0-64 - 64:0 - 127:+63	*2
c = 72	RELEASE TIME	; v = 0-64 - 64:0 - 127:+63	*2
c = 73	ATTACK TIME	; v = 0-64 - 64:0 - 127:+63	*2
c = 74	BRIGHTNESS	; v = 0-64 - 64:0 - 127:+63	*2
c = 91	EFFECT SEND LEVEL 1	; v = 0 - 127	
c = 93	EFFECT SEND LEVEL 3	; v = 0 - 127	
c = 94	EFFECT SEND LEVEL 4	; v = 0 - 127 (Only when Connection = 1 (System))	

* The CONTROL NUMBER to be received.

c = 0	BANK SEL MSB	; v = 0 :XG NORMAL, 64 :SFX NORMAL, 126 :XG SFX KIT, 127 :XG DRUM	
c = 32	BANK SEL LSB	; v = 0 - 127	
c = 1	MODULATION	; v = 0 - 127	*2
c = 5	PORTAMENTO TIME	; v = 0 - 127	*2
c = 6	DATA ENTRY MSB	; v = 0 - 127	*1
c = 38	DATA ENTRY LSB	; v = 0 - 127	*1
c = 7	MAIN VOLUME	; v = 0 - 127	
c = 10	PANPOT	; v = 0 - 127	
c = 11	EXPRESSION	; v = 0 - 127	
c = 16	AC1 CONTROLLER	; v = 0 - 127	*2
c = 64	SUSTAIN SWITCH	; v = 0-63:OFF , 64-127:ON	*2
c = 65	PORTAMENTO SWITCH	; v = 0-63:OFF , 64-127:ON	*2
c = 66	SOSTENUTO	; v = 0-63:OFF , 64-127:ON	*2
c = 67	SOFT PEDAL	; v = 0-63:OFF , 64-127:ON	*2
c = 71	HARMONIC CONTENT	; v = 0-64 - 64:0 - 127:+63	*2
c = 72	RELEASE TIME	; v = 0-64 - 64:0 - 127:+63	*2
c = 73	ATTACK TIME	; v = 0-64 - 64:0 - 127:+63	*2
c = 74	BRIGHTNESS	; v = 0-64 - 64:0 - 127:+63	*2
c = 84	PORTAMENTO CONTROL	; v = 0 - 127	*2
c = 91	EFFECT SEND LEVEL 1	; v = 0 - 127	
c = 93	EFFECT SEND LEVEL 3	; v = 0 - 127	
c = 94	EFFECT SEND LEVEL 4	; v = 0 - 127(Only when Connection = 1 (System))	
c = 96	DATA ENTRY INC	; v = 127	*1
c = 97	DATA ENTRY DEC	; v = 127	*1

*1 Used only to set the parameter specified by RPN

*2 Not valid for rhythm voices.

*3 When MSB is other than 0 or 127, this is 0.

When MSB = 0, this is 0,1,3,5,8,12,14,16,17,18,19,20,24,25,27,28,32,33,34,35,36,37,38,39,40,
41,42,43,45,64,65,66,67,68,69,70,71,72,73,96,97,98,99,100,101

When MSB = 127, this is 0.

MODULATION controls the depth of vibrato.

PORTAMENTO TIME adjusts the speed of the pitch change if the Portamento Switch = ON. A setting of 0 produces the shortest portamento time, and 127 produces the longest portamento time.

For consistency with the GMx Portamento Control Standard, this value is valid only for the Portamento Switch (Ctr#65).

PANPOT produces change relative to the preset value of the voice, both for melody voices and for rhythm voices.

For PORTAMENTO CONTROL, the portamento time is always fixed at 0.

EFFECT SEND LEVEL 1 controls the Reverb send.
 EFFECT SEND LEVEL 3 controls the Chorus send.
 EFFECT SEND LEVEL 4 controls the Variation send.

HARMONIC CONTENT adjusts the resonance specified by the Voice. This is a relative parameter, and specifies an increase or decrease centered at 64. Higher values will produce a more distinctive tone. For some voices, the effective range maybe less than the range of the setting.

RELEASE TIME adjusts the envelope release time specified by the Voice. This is a relative parameter, and specifies an increase or decrease centered at 64.

ATTACK TIME adjusts the envelope attack time specified by the Voice. This is a relative parameter, and specifies an increase or decrease centered at 64.

BRIGHTNESS adjusts the cutoff frequency specified by the Voice. This is a relative parameter, and specifies an increase or decrease centered at 64. Decreasing the value will make the sound more mellow. For some voices, the effective range may be less than the range of the setting.

The following Bank Select related operations will all occur when a Program Change is received. Bank Select MSB:60h-6Fh are not sounded on models which do not support GMx, but since on the QY100 these are for future expansion of melodic voices, they will be sounded for the present by MSB00h.

If Bank Select MSB is other than 0,40H, 60H-6FH, 7EH, or 7FH, voice Off will be selected. If Bank Select MSB = 0,40H, 60H-60FH, 7EH or 7FH is selected, unsupported BANK SELECT LSB numbers will be ignored.

(3-2) CHANNEL MODE MESSAGES

STATUS	1011nnnn (BnH)	n = 0 ~ 15 VOICE CHANNEL NUMBER
CONTROL NUMBER	0cccccc	c = CONTROL NUMBER
CONTROL VALUE	0vvvvvv	v = DATA VALUE

(3-2-1) ALL SOUND OFF (CONTROL NUMBER = 78H , DATA VALUE = 0)

Turns off the sound of all currently sounding notes on the corresponding channel. The status of channel messages such as Note On and Hold On is also turned off.

(3-2-2) RESET ALL CONTROLLERS (CONTROL NUMBER = 79H , DATA VALUE = 0)

Resets the values of the following controllers.

PITCH BEND CHANGE	0 (center)
AFTER TOUCH	0 (minimum)
MODULATION	0 (off)
AC1 CONTROLLER	0 (minimum)
EXPRESSION	127 (maximum)
SUSTAIN SWITCH	0 (off)
PORTAMENTO SWITCH	1 (on)
SOSTENUTO SWITCH	0 (off)
SOFT PEDAL	0 (off)
NRPN	Un-set status. Internal data will not change.
RPN	Un-set status. Internal data will not change.
PORTAMENT CONTROL	reset

The following data will not change.
 PROGRAM CHANGE, BANK SELECT MSB/LSB, VOLUME, PAN,
 HARMONIC CONTENT, RELEASE TIME, ATTACK TIME, BRIGHTNESS, DRY SEND LEVEL,
 EFFECT SEND LEVEL 1, EFFECT SEND LEVEL 3, EFFECT SEND LEVEL 4,
 PITCH BEND SENSITIVITY, FINE TUNING, COURSE TUNING

(3-2-3) ALL NOTE OFF (CONTROL NUMBER = 7BH , DATA VALUE = 0)

Turns off all notes of the corresponding channel which are on. However if Sustain or Sostenuto are on, the sound will continue until these are turned off.

(3-2-4) OMNI MODE OFF (CONTROL NUMBER = 7CH , DATA VALUE = 0)

Performs the same processing as when ALL NOTE OFF is received. Sets the VOICE RECEIVE CHANNEL to OMNI OFF and CHANNEL = 1.

(3-2-5) OMNI MODE ON (CONTROL NUMBER = 7DH , DATA VALUE = 0)

Performs the same processing as when ALL NOTE OFF is received. Does not set OMNI ON. Sets the VOICE RECEIVE CHANNEL to OMNI ON.

(3-2-6) MONO (CONTROL NUMBER = 7EH , DATA VALUE = 0)

Performs the same processing as when All SOUND OFF is received, and if the 3rd byte (mono number) is in the range 0—16, sets the corresponding channel to Mode 4 (m=1).
If in the VOICE MODE, Mode 2 (m=1) is also possible, according to the VOICE RECEIVE CHANNEL.

(3-2-7) POLY (CONTROL NUMBER = 7FH , DATA VALUE = 0)

Performs the same processing as when ALL SOUND OFF is received, and sets the corresponding channel to Mode 3.
When in the VOICE MODE, Mode 1 is also possible, according to the VOICE RECEIVE CHANNEL.

(3-3) REGISTERED PARAMETER NUMBER

STATUS	1011nnnn (BnH)	n = 0 ~ 15 VOICE CHANNEL NUMBER
LSB	01100100 (64H)	
RPN LSB	0ppppppp	p = RPN LSB (Refer to the table on the following page.)
MSB	01100101 (65H)	
RPN MSB	0qqqqqqq	q = RPN MSB (Refer to the table on the following page.)
DATA ENTRY MSB	00000110 (06H)	
DATA VALUE	0mmmmmmm	m = Data Value
DATA ENTRY LSB	00100011 (26H)	
DATA VALUE	0lllllll	l = Data Value

First transmit an RPN MSB and RPN LSB to specify the parameter that is to be controlled, then use Data Entry to set the value of the specified parameter.

RPN LSB MSB	D.ENTRY MSB LSB	PARAMETER NAME	DATA RANGE
00H 00H	mmH —	PITCH BEND SENSITIVITY	00H - 18H (0 - 24 semitones)
01H 00H	mmH llH	MASTER FINE TUNE	(mmH,llH) = {00H,00H} - {40H,00H} - {7FH,7FH} (-8192*100/8192) - 0 - (+8192*100/8192)
02H 00H	mmH —	MASTER COARSE TUNE	28H - 40H - 58H (-24 - 0 - +24 semitones)
7FH 7FH	— —	RPN RESET	Set to a condition in which the RPN number is unspecified. Internal settings will not change.

(3-4) NON-REGISTERED PARAMETER NUMBER

STATUS	1011nnnn (BnH)	n = 0 ~ 15 VOICE CHANNEL NUMBER
LSB	01100010 (62H)	
RPN LSB	0ppppppp	p = NRPN LSB (Refer to the table on the following page.)
MSB	01100011 (63H)	
RPN MSB	0qqqqqqq	q = NRPN MSB (Refer to the table on the following page.)
DATA ENTRY MSB	00000110 (06H)	
DATA VALUE	0mmmmmmm	m = Data Value

First transmit an NRPN MSB and NRPN LSB to specify the parameter that is to be controlled, then use Data Entry to set the value of the specified parameter.

NRPN MSB LSB	D.ENTRY MSB LSB	PARAMETER NAME	DATA RANGE
01H 08H	mmH —	VIBRATO RATE	00H - 40H - 7FH (-64 - 0 - +63)
01H 09H	mmH —	VIBRATO DEPTH	00H - 40H - 7FH (-64 - 0 - +63)
01H 0AH	mmH —	VIBRATO DELAY	00H - 40H - 7FH (-64 - 0 - +63)

01H 20H	mmH	—	FILTER CUTOFF FREQUENCY	00H - 40H - 7FH (-64 - 0 - +63)
01H 21H	mmH	—	FILTER RESONANCE	00H - 40H - 7FH (-64 - 0 - +63)
01H 63H	mmH	—	EG ATTACK TIME	00H - 40H - 7FH (-64 - 0 - +63)
01H 64H	mmH	—	EG DECAY TIME	00H - 40H - 7FH (-64 - 0 - +63)
01H 66H	mmH	—	EG RELEASE TIME	00H - 40H - 7FH (-64 - 0 - +63)
14H rrH	mmH	—	DRUM INST FILTER CUTOFF FREQ.	00H - 40H - 7FH (-64 - 0 - +63)
15H rrH	mmH	—	DRUM INST FILTER RESONANCE	00H - 40H - 7FH (-64 - 0 - +63)
16H rrH	mmH	—	DRUM INST AEG ATTACK RATE	00H - 40H - 7FH (-64 - 0 - +63)
17H rrH	mmH	—	DRUM INST AEG DECAY RATE	00H - 40H - 7FH (-64 - 0 - +63)
18H rrH	mmH	—	DRUM INST PITCH COARSE	00H - 40H - 7FH (-64 - 0 - +63)
19H rrH	mmH	—	DRUM INST PITCH FINE	00H - 40H - 7FH (-64 - 0 - +63)
1AH rrH	mmH	—	DRUM INST LEVEL	00H - 7FH (0 - maximum)
1CH rrH	mmH	—	DRUM INST PANPOT	00H, 01H - 40H - 7FH (random, left - center - right)
1DH rrH	mmH	—	DRUM INST REVERB SEND LEVEL	00H - 7FH (0 - maximum)
1EH rrH	mmH	—	DRUM INST CHORUS SEND LEVEL	00H - 7FH (0 - maximum)
1FH rrH	mmH	—	DRUM INST VARIATION SEND LEVEL	00H - 7FH (0 - maximum)

MSB 14h-1Fh (for drum) are valid only if the channel is set to Drum Set Mode.
 rrH : drum instrument note number

(3-5) SYSTEM REAL TIME MESSAGES

(3-5-1) ACTIVE SENSING

STATUS 11111110 (FEH)

Transmitted at intervals of approximately 200 msec.

Once this message is received, SENSING will begin. If neither STATUS nor DATA messages are received for an interval longer than approximately 350 msec, the MIDI RECEIVE BUFFER will be cleared, and all sounding notes and SUSTAIN SWITCH will be forced off. Also, data for each of the controls will be reset to specific values.

(3-6) SYSTEM EXCLUSIVE MESSAGE

(3-6-1) UNIVERSAL NON REALTIME MESSAGE

(3-6-1-1) GENERAL MIDI MODE ON

F0H 7EH 7FH 09H 01H F7H

The following controller values will be reset.

VOLUME	100
PAN	Center
PROGRAM CHANGE	1 (Grandpno)
BANK SELECT MSB	0
REVERB DEPTH	40
PITCH BEND CHANGE	0 (center)
MODULATION	0 (off)
EXPRESSION	127 (maximum)
SUSTAIN SWITCH	0 (off)
SOSTENUTO SWITCH	0 (off)
RPN	Un-set status.
PORTAMENT CONTROL	reset
MIDI MASTER VOLUME	127 (maximum)
PITCH BEND SENSITIVITY	02 (2 semitones)
FINE TUNING	0
COURSE TUNING	0

(3-6-2) UNIVERSAL REALTIME MESSAGE

(3-6-2-1) MIDI MASTER VOLUME

F0H 7FH 7FH 04H 01H IIH mmH F7H

Modifies the MASTER VOLUME value.
 The value of mm is used as the MIDI Master Volume (the II value is ignored).

(3-6-3) PARAMETER CHANGE

(3-6-3-1) MIDI MASTER TUNING

F0H 43H 1nH 27H 30H 00H 00H mmH lIH ccH F7H

Modifies the MASTER TUNE value.
The values of mm and ll are used as the MIDI Master Tuning.
(n and cc values are ignored.)

$$T = M * 200 / 256 - 100$$

Where T : actual tuning value (-99 — +99)
M : a one-byte value with MSB of "mm" bits 0-3, and LSB of "ll" bits 0-3.

(3-6-3-2) XG SYSTEM ON

11110000	F0	Exclusive status
01000011	43	YAMAHA ID
0001nnnn	1n	device Number
01001100	4C	Model ID
0aaaaaaa	00	Address High
0aaaaaaa	00	Address Mid
0aaaaaaa	7E	Address Low
00000000	00	Data
11110111	F7	End of Exclusive

When On is received, the SYSTEM MODE will be changed to XG.
Since approximately 50 ms is required in order to execute this message, an appropriate interval must be allowed before the next message.
Controllers will be reset, and all Multi Part and Effect data of the attached table, together with the values of all data of All System that are noted as (XG), will be reset to the Default values.

(3-6-3-3) XG PARAMETER CHANGE

11110000	F0	Exclusive status
01000011	43	YAMAHA ID
0001nnnn	1n	device Number
01001100	4C	Model ID
0aaaaaaa	aaaaaaa	Address High
0aaaaaaa	aaaaaaa	Address Mid
0aaaaaaa	aaaaaaa	Address Low
0ddddd	ddddddd	Data
11110111	F7	End of Exclusive

For parameters with a Data Size of 2 or 4, the corresponding amount of data will be transmitted.
For Addresses and Byte Counts, refer to the attached tables.

The following four types are transmitted and received. (Transmitted only if a Parameter Change Request is received.)

- System Data
- Multi Effect Data (ignored in Voice Mode)
- Multi Part Data (ignored in Voice Mode)
- Drums Setup Data

(3-6-4) BULK DUMP

(3-6-4-1) XG BULK DUMP

11110000	F0	Exclusive status
01000011	43	YAMAHA ID
0000nnnn	0n	device Number
01001100	4C	Model ID
0bbbbbbb	bbbbbbb	ByteCount
0bbbbbbb	bbbbbbb	ByteCount
0aaaaaaa	aaaaaaa	Address High
0aaaaaaa	aaaaaaa	Address Mid
0aaaaaaa	aaaaaaa	Address Low

00000000	00	Data
0ccccccc	ccccccc	Check-sum
11110111	F7	End of Exclusive

For Addresses and Byte Counts, refer to the attached tables.
 Check sum is the value which produces a lower 7 bits of zero when the Byte Count, Start Address, Data, and the Check-sum itself are added.
 513 bytes or more must not be transmitted at once. Thus, if a Dump Request for 513 or more bytes is received, the date will be divided into packets of 512 bytes or less, and transmitted at an appropriate timing interval (120 msec or longer).

The following five types are transmitted and received. (Transmitted only if a Bulk Dump Request is received.)

- System Data
- Multi Effect Data (for each module)
- Multi Part Data (for each part)
- Drums Setup Data (for each note)
- System Information (transmitted only)

(3-6-5) DUMP REQUEST

(3-6-5-1) XG DUMP REQUEST

11110000	F0	Exclusive status
01000011	43	YAMAHA ID
0010nnnn	2n	device Number
01001100	4C	Model ID
0aaaaaaa	aaaaaaa	Address High
0aaaaaaa	aaaaaaa	Address Mid
0aaaaaaa	aaaaaaa	Address Low
11110111	F7	End of Exclusive

For Addresses and Byte Counts, refer to the attached tables.

The following four types are received.

- System Data
- Multi Effect Data (for each module)
- Multi Part Data (for each part)
- Drums Setup Data (for each note)

(3-6-6) XG PARAMETER REQUEST

11110000	F0	Exclusive status
01000011	43	YAMAHA ID
0011nnnn	3n	device Number
01001100	4C	Model ID
0aaaaaaa	aaaaaaa	Address High
0aaaaaaa	aaaaaaa	Address Mid
0aaaaaaa	aaaaaaa	Address Low
11110111	F7	End of Exclusive

For Addresses and Byte Counts, refer to the attached tables.

The following four types are received.

- System Data
- Multi Effect Data
- Multi Part Data
- Drums Setup Data

(4) Diagram of connections between the Keyboard/ Switch block, Sequencer block, and Tone Generator block

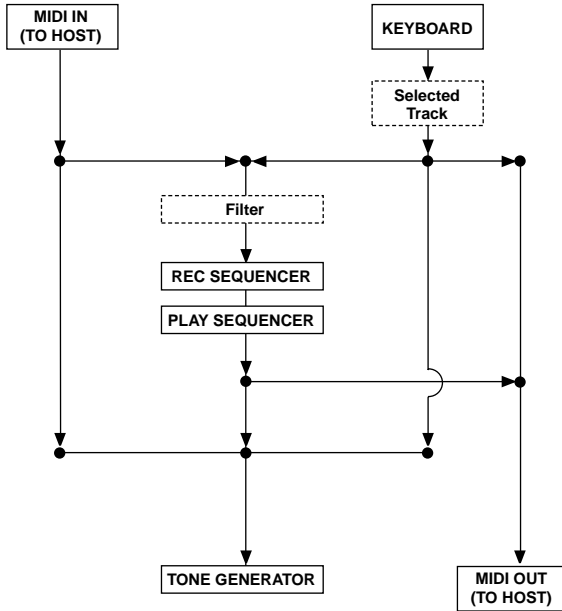

When PC1, PC2 or, Mac is selected with the HOST SELECT switch, data will be transmitted and received via the TO HOST connector.
 In this case, MIDI data received via the MIDI IN connector will re-transmitted to the TO HOST connector, data received via the TO HOST connector will be re-transmitted to the MIDI OUT connector.

■ Sequencer part

(1) TRANSMIT FLOW

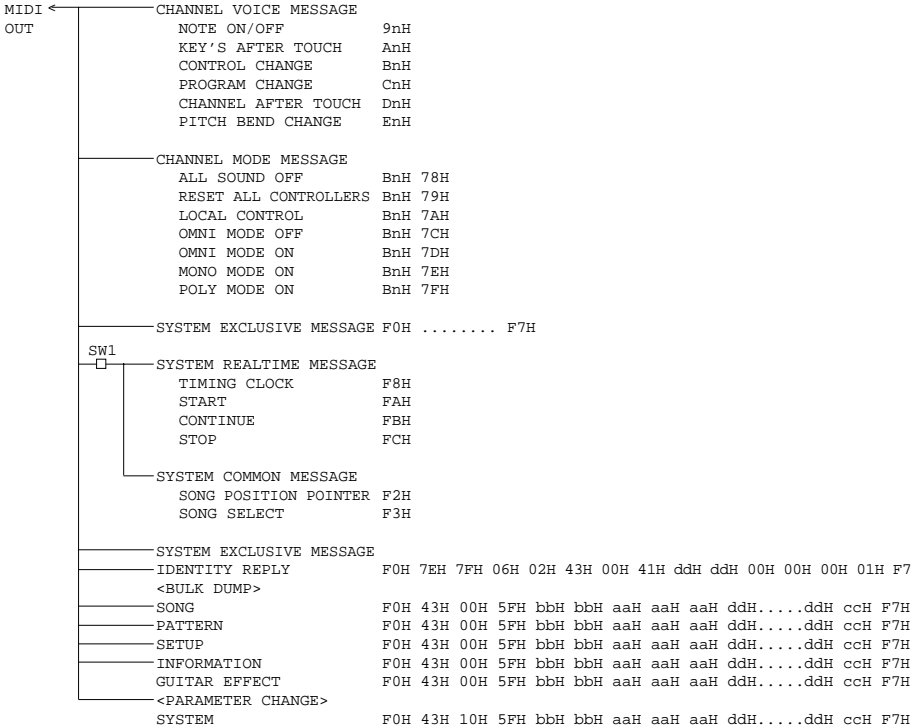

SW1 MIDI Control
 Transmission can be turned On/Off.

(2) RECEIVE FLOW

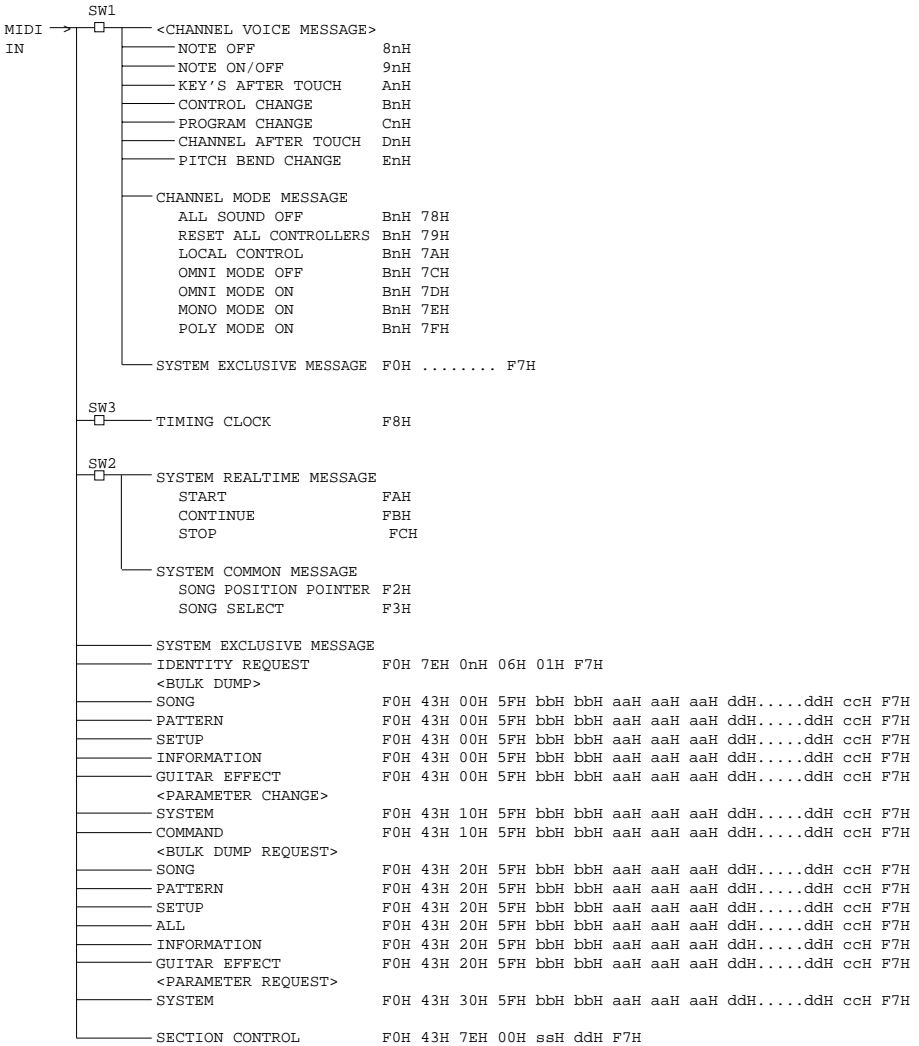

SW1 Input Filter
Reception can be turned on/off according to the Input Filter settings.

SW2 MIDI Control
Reception can be turned On/Off.

SW3 MIDI Sync
Select whether timing will be determined by the Internal clock, or by MIDI Clock messages received at MIDI IN.

(3) TRANSMIT/RECEIVE DATA

(3-1) CHANNEL VOICE MESSAGE

Transmitted only during recording and playback.
Transmission channel can be turned On/Off and the transmit channel set for each track.

Received only during recording. All Channel are always received.
During MULTI TRACK RECORD, data of MIDI CH 0-15 will be recorded separately onto tracks 1-16.

* In RECORD MODE, recording is normally omni on.
However, during MULTI TRACK RECORD, this will be omni off, and data of MIDI CH 0-15 will be recorded separately onto tracks 1-16.

(3-1-1) NOTE OFF

STATUS	100nnnn (8nH)	n = 0 ~ 15 TRACK CHANNEL NUMBER
NOTE NUMBER	0kkkkkkk	k = 0 (C-2) ~ 127 (G8)
VELOCITY	0vvvvvvv	v is ignored

Only recorded.
During playback, converted into 9nH kkH 00H.

(3-1-2) NOTE ON/OFF

STATUS	1001nnnn (9nH)	n = 0 ~ 15 TRACK CHANNEL NUMBER
NOTE NUMBER	0kkkkkkk	k = 0 (C-2) ~ 127 (G8)
VELOCITY	0vvvvvvv	(v≠0) NOTE ON (v=0) NOTE OFF
	00000000	

(3-1-3) POLYPHONIC KEY PRESSURE

STATUS	1010nnnn (AnH)	n = 0 ~ 15 TRACK CHANNEL NUMBER
NOTE NUMBER	0kkkkkkk	k = 0 (C-2) ~ 127 (G8)
VALUE	0vvvvvvv	v = 0 - 127

(3-1-4) CONTROL CHANGE

STATUS	1011nnnn (BnH)	n = 0 ~ 15 TRACK CHANNEL NUMBER
CONTROL NUMBER	0ccccccc	
CONTROL VALUE	0vvvvvvv	

All Control Change messages are recorded and played back.

(3-1-5) PROGRAM CHANGE

STATUS	1100nnnn (CnH)	n = 0 ~ 15 TRACK CHANNEL NUMBER
PROGRAM NUMBER	0ppppppp	p = 0 ~ 127

(3-1-6) CHANNEL PRESSURE

STATUS	1101nnnn (DnH)	n = 0 ~ 15 TRACK CHANNEL NUMBER
VALUE	0vvvvvvv	v = 0 ~ 127

(3-1-7) PITCH BEND CHANGE

STATUS	1110nnnn (EnH)	n = 0 ~ 15 TRACK CHANNEL NUMBER
LSB	0vvvvvvv	PITCH BEND LSB 0 ~ 127
MSB	0vvvvvvv	PITCH BEND MSB 0 ~ 127

(3-2) CHANNEL MODE MESSAGE

The following messages are recorded and played back.

RESET ALL CONTROLLERS	BnH 78H
LOCAL CONTROL	BnH 7AH
OMNI MODE OFF	BnH 7CH

OMNI MODE ON	BnH 7DH
MONO MODE ON	BnH 7EH
POLY MODE ON	BnH 7FH

(3-3) SYSTEM COMMON MESSAGE

These are transmitted and received as Control Messages for QY100 functions.
They are not recorded as SEQUENCE DATA.

(3-3-1) SONG POSITION POINTER

STATUS	11110010 (F2H)	
LSB	0vvvvvv	SONG POSITION LSB
MSB	0vvvvvv	SONG POSITION MSB

Transmitted when you move to a different measure in the SONG PLAY Mode.
Received when in SONG PLAY Standby.

(3-3-2) SONG SELECT

STATUS	11110011 (F3H)	
SONG NUMBER	0sssssss	SONG NUMBER (PATTERN NUMBER in the PATTERN Mode)

In the SONG PLAY Mode, this will be transmitted when a SONG is switched.
In the PATTERN PLAY Mode, this will be transmitted when a PATTERN is switched.
When in SONG PLAY Mode Standby, PATTERN PLAY Mode Standby, and PLAY, this message is received.
When received in the PATTERN PLAY Mode, the PATTERN will change.

(3-4) SYSTEM REAL TIME MESSAGE

Not recorded as Sequence Data.

(3-4-1) TIMING CLOCK

STATUS	11111000 (F8H)
--------	----------------

You can select whether the internal clock will be used as the Timing Clock, or whether Timing Clock messages from the MIDI IN will be used.
Transmission and reception can be turned On/Off.

(3-4-2) START

STATUS	11111010 (FAH)
--------	----------------

Transmission/Reception can be turned On/Off.

(3-4-3) CONTINUE

STATUS	11111011 (FBH)
--------	----------------

Transmission/Reception can be turned On/Off.

(3-4-4) STOP

STATUS	11111100 (FCH)
--------	----------------

Transmission/Reception can be turned On/Off.

(3-5) SYSTEM EXCLUSIVE MESSAGE

All System Exclusive Messages are recorded and played back.
Even if time intervals existed within the actual data that was received, the entire message between F0 and F7 will be recorded into one timing location.
For playback, an interval time can be specified for each 1K bytes.

(3-6-3-2) Bulk Dump DATA

The format for transmission and reception of SETUP DATA, SONG INFORMATION and PATTERN INFORMATION.

Refer to <Table 1-9> for Address and Data size.

11110000	F0	Exclusive status
01000011	43	YAMAHA ID
00000000	00	substatus
01011111	5F	model ID
0bbbbbbb	bbbbbbb	ByteCount MSB
0bbbbbbb	bbbbbbb	ByteCount LSB
0aaaaaaa	aaaaaaa	Address High
0aaaaaaa	aaaaaaa	Address Mid
0aaaaaaa	aaaaaaa	Address Low
0ddddddd	ddddddd	data
0ddddddd	ddddddd	data
0ccccccc	ccccccc	Check-sum
11110111	F7	End Of Exclusive

(3-6-3-3) Parameter Change

The format for executing BULK MODE ON/OFF, CLEAR SONG and CLEAR PATTERN.

11110000	F0	Exclusive status
01000011	43	YAMAHA ID
00010000	10	substatus
01011111	5F	model ID
0aaaaaaa	aaaaaaa	Address High
0aaaaaaa	aaaaaaa	Address Mid
0aaaaaaa	aaaaaaa	Address Low
0ddddddd	ddddddd	data
11110111	F7	End Of Exclusive

(3-6-3-4) Bulk Dump Request

The Bulk Data request of SONG DATA, PATTERN DATA, SETUP DATA, SONG INFORMATION, and PATTERN INFORMATION.

11110000	F0	Exclusive status
01000011	43	YAMAHA ID
00100000	20	substatus
01011111	5F	model ID
0aaaaaaa	aaaaaaa	Address High
0aaaaaaa	aaaaaaa	Address Mid
0aaaaaaa	aaaaaaa	Address Low
11110111	F7	End Of Exclusive

(3-6-3-5) Parameter Change Request

Parameter request for BULK MODE ON/OFF.

11110000	F0	Exclusive status
01000011	43	YAMAHA ID
00110000	30	substatus
01011111	5F	model ID
0aaaaaaa	aaaaaaa	Address High
0aaaaaaa	aaaaaaa	Address Mid
0aaaaaaa	aaaaaaa	Address Low
11110111	F7	End Of Exclusive

<Table 1-1>

Parameter Base Address

	Parameter Change Address			Description
	(H)	(M)	(L)	
SYSTEM	00	00	00	System
	00	00	7D	Drum Setup Reset
	00	00	7E	XG System On
	00	00	7F	All Parameter Reset
INFORMATION	01	00	00	System Information
EFFECT 1	02	01	00	Effect1 (Reverb,Chorus,Variation)
	02	40	00	Reserved
	:	:	:	:
MULTI PART	08	00	00	Multi Part 1
	:	:	:	:
	08	0F	00	Multi Part 32
	:	:	:	:
DRUM	08	10	00	Reserved
	:	:	:	:
	30	18	00	Drum Setup 1 → Address
	31	18	00	Drum Setup 2 → Parameter
	:	:	:	:
	32	18	00	Reserved
	:	:	:	:
	3F	nn	nn	Reserved

Address	Parameter	Parameter
3n 18 00	note number 24	
3n 19 00	note number 25	
:	:	:
3n 54 00	note number 84	

< Table 1-2 >

MIDI Parameter Change table (SYSTEM)

Address (H)	Size (H)	Data (H)	Parameter Name	Description	Default value (H)
00 00 00	4	0000	Master Tune	-102.4..+102.3[cent]	00 04 00 00
01		..07FF		1st bit3-0→bit15-12	(0400)
02				2nd bit3-0→bit11-8	(not reset by XG or GM on)
03				3rd bit3-0→bit7-4	
				4th bit3-0→bit3-0	
04	1	00..7F	Master Volume	0..127	7F
05	1	00..7F	Not Used		
06	1	28..58	Transpose	-24..+24[semitones]	40
7D	n		Drum Setup Reset	n=Drum Setup Number	
7E	00		XG System On	00=XG System on (receive only)	
7F	00		All Parameter Reset	00=on (receive only)	
TOTAL SIZE 06					

< Table 1-3 >

MIDI Parameter table (System information)

Address (H)	Size (H)	Data (H)	Parameter Name	Description	Default value (H)
01 00 00	E	20..7F	Model Name	("QY100 ")	
:					
0E	1	00			
0F	1	00	XG Support Level	0..127	
TOTAL SIZE 10					

(Transmitted in response to a Dump Request. Not received. Bulk Dump Only)

< Table 1-4 >

MIDI Parameter Change table (EFFECT 1)

Address (H)	Size (H)	Data (H)	Parameter Name	Description	Default value (H)
02 01 00	2	00..7F	Reverb Type MSB	Refer to Effect Type List	01 (=HALL1)
		00..7F	Reverb Type LSB	00 : basic type	00
02	1	00..7F	Reverb Parameter 1	Refer to Ef. Parameter List	depends on Reverb type
03	1	00..7F	Reverb Parameter 2	Refer to Ef. Parameter List	depends on Reverb type
04	1	00..7F	Reverb Parameter 3	Refer to Ef. Parameter List	depends on Reverb type
05	1	00..7F	Reverb Parameter 4	Refer to Ef. Parameter List	depends on Reverb type
06	1	00..7F	Reverb Parameter 5	Refer to Ef. Parameter List	depends on Reverb type
07	1	00..7F	Reverb Parameter 6	Refer to Ef. Parameter List	depends on Reverb type
08	1	00..7F	Reverb Parameter 7	Refer to Ef. Parameter List	depends on Reverb type
09	1	00..7F	Reverb Parameter 8	Refer to Ef. Parameter List	depends on Reverb type
0A	1	00..7F	Reverb Parameter 9	Refer to Ef. Parameter List	depends on Reverb type
0B	1	00..7F	Reverb Parameter 10	Refer to Ef. Parameter List	depends on Reverb type
0C	1	00..7F	Reverb Return	-∞..0..+6dB (0..96..127)	60
0D	1	01..7F	Reverb Pan	L63..C..R63 (1..64..127)	40
TOTAL SIZE 0E					
02 01 10	1	00..7F	Reverb Parameter 11	Refer to Ef. Parameter List	depends on Reverb type
11	1	00..7F	Reverb Parameter 12	Refer to Ef. Parameter List	depends on Reverb type
12	1	00..7F	Reverb Parameter 13	Refer to Ef. Parameter List	depends on Reverb type
13	1	00..7F	Reverb Parameter 14	Refer to Ef. Parameter List	depends on Reverb type
14	1	00..7F	Reverb Parameter 15	Refer to Ef. Parameter List	depends on Reverb type
15	1	00..7F	Reverb Parameter 16	Refer to Ef. Parameter List	depends on Reverb type
TOTAL SIZE 6					
02 01 20	2	00..7F	Chorus Type MSB	Refer to Effect Type List	41 (=Chorus1)
		00..7F	Chorus Type LSB	00 : basic type	00
22	1	00..7F	Chorus Parameter 1	Refer to Ef. Parameter List	depends on Chorus Type
23	1	00..7F	Chorus Parameter 2	Refer to Ef. Parameter List	depends on Chorus Type
24	1	00..7F	Chorus Parameter 3	Refer to Ef. Parameter List	depends on Chorus Type
25	1	00..7F	Chorus Parameter 4	Refer to Ef. Parameter List	depends on Chorus Type
26	1	00..7F	Chorus Parameter 5	Refer to Ef. Parameter List	depends on Chorus Type
27	1	00..7F	Chorus Parameter 6	Refer to Ef. Parameter List	depends on Chorus Type
28	1	00..7F	Chorus Parameter 7	Refer to Ef. Parameter List	depends on Chorus Type
29	1	00..7F	Chorus Parameter 8	Refer to Ef. Parameter List	depends on Chorus Type
2A	1	00..7F	Chorus Parameter 9	Refer to Ef. Parameter List	depends on Chorus Type
2B	1	00..7F	Chorus Parameter 10	Refer to Ef. Parameter List	depends on Chorus Type
2C	1	00..7F	Chorus Return	-∞..0..+6dB (0..96..127)	60
2D	1	01..7F	Chorus Pan	L63..C..R63 (1..64..127)	40
2E	1	00..7F	Send Chorus To Reverb	-∞..0..+6dB (0..96..127)	00
TOTAL SIZE 0F					
02 01 30	1	00..7F	Chorus Parameter 11	Refer to Ef. Parameter List	depends on Chorus Type
31	1	00..7F	Chorus Parameter 12	Refer to Ef. Parameter List	depends on Chorus Type
32	1	00..7F	Chorus Parameter 13	Refer to Ef. Parameter List	depends on Chorus Type
33	1	00..7F	Chorus Parameter 14	Refer to Ef. Parameter List	depends on Chorus Type
34	1	00..7F	Chorus Parameter 15	Refer to Ef. Parameter List	depends on Chorus Type
35	1	00..7F	Chorus Parameter 16	Refer to Ef. Parameter List	depends on Chorus Type
TOTAL SIZE 6					
02 01 40	2	00..7F	Variation Type MSB	Refer to Ef. Type List	05 (=DELAY L,C,R)
		00..7F	Variation Type LSB	00 : basic type	00
42	2	00..7F	Variation Param 1 MSB	Refer to Ef. Parameter List	depends on vari. type
		00..7F	Variation Param 1 LSB	Refer to Ef. Parameter List	depends on vari. type
44	2	00..7F	Variation Param 2 MSB	Refer to Ef. Parameter List	depends on vari. type
		00..7F	Variation Param 2 LSB	Refer to Ef. Parameter List	depends on vari. type
46	2	00..7F	Variation Param 3 MSB	Refer to Ef. Parameter List	depends on vari. type
		00..7F	Variation Param 3 LSB	Refer to Ef. Parameter List	depends on vari. type
48	2	00..7F	Variation Param 4 MSB	Refer to Ef. Parameter List	depends on vari. type
		00..7F	Variation Param 4 LSB	Refer to Ef. Parameter List	depends on vari. type
4A	2	00..7F	Variation Param 5 MSB	Refer to Ef. Parameter List	depends on vari. type
		00..7F	Variation Param 5 LSB	Refer to Ef. Parameter List	depends on vari. type
4C	2	00..7F	Variation Param 6 MSB	Refer to Ef. Parameter List	depends on vari. type
		00..7F	Variation Param 6 LSB	Refer to Ef. Parameter List	depends on vari. type

M I D I D a t a F o r m a t

Address (H)	Size (H)	Data (H)	Parameter Name	Description	Default value (H)
4E	2	00..7F	Variation Param 7 MSB	Refer to Ef. Parameter List	depends on vari. type
		00..7F	Variation Param 7 LSB	Refer to Ef. Parameter List	depends on vari. type
50	2	00..7F	Variation Param 8 MSB	Refer to Ef. Parameter List	depends on vari. type
		00..7F	Variation Param 8 LSB	Refer to Ef. Parameter List	depends on vari. type
52	2	00..7F	Variation Param 9 MSB	Refer to Ef. Parameter List	depends on vari. type
		00..7F	Variation Param 9 LSB	Refer to Ef. Parameter List	depends on vari. type
54	2	00..7F	Variation Param 10 MSB	Refer to Ef. Parameter List	depends on vari. type
		00..7F	Variation Param 10 LSB	Refer to Ef. Parameter List	depends on vari. type
56	1	00..7F	Variation Return	-∞..0..+6dB (0..96..127)	60
57	1	01..7F	Variation Pan	L63..C..R63 (1..64..127)	40
58	1	00..7F	Send Variation To Rev.	-∞..0..+6dB (0..96..127)	00
59	1	00..7F	Send Variation To Cho.	-∞..0..+6dB (0..96..127)	00
5A	1	00..01	Variation Connection	0:insertion,1:system	00
5B	1	00..1F	Variation Part	part1..32 (0..31), off (127)	7F
5C	1	01..7F	MW Variation Ctrl Depth	-63..+63	00
5D	1	01..7F	PB Variation Ctrl Depth	-63..+63	00
5E	1	01..7F	AT Variation Ctrl Depth	-63..+63	00
5F	1	01..7F	AC1 Variation CtrlDepth	-63..+63	00
60	1	01..7F	AC2 Variation CtrlDepth	-63..+63	00
TOTAL SIZE 21					
02 01 70	1	00..7F	Variation Parameter 11	option Parameter	depends on vari. type
71	1	00..7F	Variation Parameter 12	option Parameter	depends on vari. type
72	1	00..7F	Variation Parameter 13	option Parameter	depends on vari. type
73	1	00..7F	Variation Parameter 14	option Parameter	depends on vari. type
74	1	00..7F	Variation Parameter 15	option Parameter	depends on vari. type
75	1	00..7F	Variation Parameter 16	option Parameter	depends on vari. type
TOTAL SIZE 6					

< Table 1-5 >

MIDI Parameter Change table (DISPLAY DATA)

Address (H)	Size (H)	Data (H)	Parameter Name	Description	Default value (H)
06 00 00	20	20..7F	MESSAGE WINDOW	32..127 (ASCII CHARACTER)	
∴					
1F					
TOTAL SIZE 20					
07 00 00	30	00..7F	BITMAP WINDOW Data0	0..127 (ASCII CHARACTER)	
∴					
2F			BITMAP WINDOW Data47		
TOTAL SIZE 30					

The following shows the relationship of data and the display.

7 horizontally arranged elements are combined to create 1 byte of data.

When the elements are displayed, the "bit" that is displayed is 1, and the "bit" that is not displayed is 0.

The arrangement for the display's data is below.

	b6	b5	b4	b3	b2	b1	b0		b6	b5	b4	b3	b2	b1	b0		b6	b5	b4	b3	b2	b1	b0
Data 0	0	0	0	0	0	0	0	Data 16	0	0	0	0	0	0	0	Data 32	0	0	-	-	-	-	-
Data 1	0	0	0	0	0	0	0	Data 17	0	0	0	0	0	0	0	Data 33	0	0	-	-	-	-	-
Data 2	0	0	0	0	0	0	0	Data 18	0	0	0	0	0	0	0	Data 34	0	0	-	-	-	-	-
Data 3	0	0	0	0	0	0	0	Data 19	0	0	0	0	0	0	0	Data 35	0	0	-	-	-	-	-
Data 4	0	0	0	0	0	0	0	Data 20	0	0	0	0	0	0	0	Data 36	0	0	-	-	-	-	-
Data 5	0	0	0	0	0	0	0	Data 21	0	0	0	0	0	0	0	Data 37	0	0	-	-	-	-	-
Data 6	0	0	0	0	0	0	0	Data 22	0	0	0	0	0	0	0	Data 38	0	0	-	-	-	-	-
Data 7	0	0	0	0	0	0	0	Data 23	0	0	0	0	0	0	0	Data 39	0	0	-	-	-	-	-
Data 8	0	0	0	0	0	0	0	Data 24	0	0	0	0	0	0	0	Data 40	0	0	-	-	-	-	-
Data 9	0	0	0	0	0	0	0	Data 25	0	0	0	0	0	0	0	Data 41	0	0	-	-	-	-	-
Data 10	0	0	0	0	0	0	0	Data 26	0	0	0	0	0	0	0	Data 42	0	0	-	-	-	-	-
Data 11	0	0	0	0	0	0	0	Data 27	0	0	0	0	0	0	0	Data 43	0	0	-	-	-	-	-
Data 12	0	0	0	0	0	0	0	Data 28	0	0	0	0	0	0	0	Data 44	0	0	-	-	-	-	-
Data 13	0	0	0	0	0	0	0	Data 29	0	0	0	0	0	0	0	Data 45	0	0	-	-	-	-	-
Data 14	0	0	0	0	0	0	0	Data 30	0	0	0	0	0	0	0	Data 46	0	0	-	-	-	-	-
Data 15	0	0	0	0	0	0	0	Data 31	0	0	0	0	0	0	0	Data 47	0	0	-	-	-	-	-

Data 32-47 only uses bit 6 and bit 5.

In the Bit Map Data, only the specified elements can also be received. At this time, other elements are displayed in their previous condition.
 Parameter changes for DISPLAY DATA can be constantly transmitted from the specified region.

< Table 1-6 >

MIDI Parameter Change table (MULTI PART)

Address (H)	Size (H)	Data (H)	Parameter Name	Description	Default value (H)
08 nn	00 1	00..20	Element Reserve	0..32	0 (Part10), 2 (Others)
nn 01	1	00..7F	Bank Select MSB	0..127	7F (Part10), 00 (Others)
nn 02	1	00..7F	Bank Select LSB	0..127	00
nn 03	1	00..7F	Program Number	1..128	00
nn 04	1	00..0F	Rcv Channel	0..15;1..16,127;off	Part No. 7F
nn 05	1	00..01	Mono/Poly Mode	0:mono,1:poly	01
nn 06	1	00..02	Same Note Number Key On Assign	0:single 1:multi 2:inst (for DRUM)	01
nn 07	1	00..02	Part Mode	0:normal 1..3:drum thru,drum1..2	00 (other than Part 10) 01 (Part10)
nn 08	1	28..58	Note Shift	-24..+24[semitones]	40
nn 09	2	00..FF	Detune	-12.8..+12.7[Hz]	08 00
nn 0A				1st bit3..0→bit7..4 2nd bit3..0→bit3..0	(80)
nn 0B	1	00..7F	Volume	0..127	64
nn 0C	1	00..7F	Velocity Sense Depth	0..127	40
nn 0D	1	00..7F	Velocity Sense Offset	0..127	40
nn 0E	1	00..7F	Pan	0:random L63..C..R63 (1..64..127)	40
nn 0F	1	00..7F	Note Limit Low	C-2..G8	00
nn 10	1	00..7F	Note Limit High	C-2..G8	7F
nn 11	1	00..7F	Dry Level	0..127	7F
nn 12	1	00..7F	Chorus Send	0..127	00
nn 13	1	00..7F	Reverb Send	0..127	28
nn 14	1	00..7F	Variation Send	0..127	00
nn 15	1	00..7F	Vibrato Rate	-64..+63	40
nn 16	1	00..7F	Vibrato Depth	-64..+63	40
nn 17	1	00..7F	Vibrato Delay	-64..+63	40
nn 18	1	00..7F	Filter Cutoff Frequency	-64..+63	40
nn 19	1	00..7F	Filter Resonance	-64..+63	40
nn 1A	1	00..7F	EG Attack Time	-64..+63	40
nn 1B	1	00..7F	EG Decay Time	-64..+63	40
nn 1C	1	00..7F	EG Release Time	-64..+63	40
nn 1D	1	28..58	MW Pitch Control	-24..+24[semitones]	40
nn 1E	1	00..7F	MW Filter Control	-9600..+9450[cent]	40
nn 1F	1	00..7F	MW Amplitude Control	-64..+63	40
nn 20	1	00..7F	MW LFO PMod Depth	0..127	0A
nn 21	1	00..7F	MW LFO FMod Depth	0..127	00
nn 22	1	00..7F	MW LFO AMod Depth	0..127	00
nn 23	1	28..58	Bend Pitch Control	-24..+24[semitones]	42
nn 24	1	00..7F	Bend Filter Control	-9600..+9450[cent]	40
nn 25	1	00..7F	Bend Amplitude Control	-64..+63	40
nn 26	1	00..7F	Bend LFO PMod Depth	0..127	00
nn 27	1	00..7F	Bend LFO FMod Depth	0..127	00
nn 28	1	00..7F	Bend LFO AMod Depth	0..127	00
TOTAL SIZE	29				
nn 30	1	00..01	Not Used		
nn 31	1	00..01	Not Used		
nn 32	1	00..01	Not Used		
nn 33	1	00..01	Not Used		
nn 34	1	00..01	Not Used		

M I D I D a t a F o r m a t

Address (H)	Size (H)	Data (H)	Parameter Name	Description	Default value (H)
nn 35	1	00..01	Not Used		
nn 36	1	00..01	Not Used		
nn 37	1	00..01	Not Used		
nn 38	1	00..01	Not Used		
nn 39	1	00..01	Not Used		
nn 3A	1	00..01	Not Used		
nn 3B	1	00..01	Not Used		
nn 3C	1	00..01	Not Used		
nn 3D	1	00..01	Not Used		
nn 3E	1	00..01	Not Used		
nn 3F	1	00..01	Not Used		
nn 40	1	00..01	Not Used		
nn 41	1	00..7F	Not Used		
nn 42	1	00..7F	Not Used		
nn 43	1	00..7F	Not Used		
nn 44	1	00..7F	Not Used		
nn 45	1	00..7F	Not Used		
nn 46	1	00..7F	Not Used		
nn 47	1	00..7F	Not Used		
nn 48	1	00..7F	Not Used		
nn 49	1	00..7F	Not Used		
nn 4A	1	00..7F	Not Used		
nn 4B	1	00..7F	Not Used		
nn 4C	1	00..7F	Not Used		
nn 4D	1	28..58	Ch's AT Pitch Control	-24..+24[semitones]	40
nn 4E	1	00..7F	Ch's AT Filter Control	-9600..+9450[cent]	40
nn 4F	1	00..7F	Ch's AT Amp. Control	-100..+100[%]	40
nn 50	1	00..7F	Ch's AT LFO PMod Depth	0..127	00
nn 51	1	00..7F	Ch's AT LFO FMod Depth	0..127	00
nn 52	1	00	Ch's AT LFO AMod Depth	0..127	00
nn 53	1	28..58	Not Used		
nn 54	1	00..7F	Not Used		
nn 55	1	00..7F	Not Used		
nn 56	1	00..7F	Not Used		
nn 57	1	00..7F	Not Used		
nn 58	1	00	Not Used		
nn 59	1	00..5F	Not Used		
nn 5A	1	28..58	Not Used		
nn 5B	1	00..7F	Not Used		
nn 5C	1	00..7F	Not Used		
nn 5D	1	00..7F	Not Used		
nn 5E	1	00..7F	Not Used		
nn 5F	1	00..7F	Not Used		
nn 60	1	00..5F	Not Used		
nn 61	1	28..58	Not Used		
nn 62	1	00..7F	Not Used		
nn 63	1	00..7F	Not Used		
nn 64	1	00..7F	Not Used		
nn 65	1	00..7F	Not Used		
nn 66	1	00..7F	Not Used		
nn 67	1	00..01	Portamento Switch	off/on	00
nn 68	1	00..7F	Portamento Time	0..127	00
nn 69	1	00..7F	Pitch EG Initial Level	-64..+63	40
nn 6A	1	00..7F	Pitch EG Attack Time	-64..+63	40
nn 6B	1	00..7F	Pitch EG Release Level	-64..+63	40
nn 6C	1	00..7F	Pitch EG Release Time	-64..+63	40
nn 6D	1	00..7F	Not Used		
nn 6E	1	00..7F	Not Used		

TOTAL SIZE 3F

nn = PartNumber

For the Drum Part, the following parameters have no effect.

- Bank Select LSB
- Portamento
- Soft Pedal
- Mono/Poly
- Scale Tuning
- Pitch EG

< Table 1-7 >

MIDI Parameter Change table (DRUM SETUP)

Address (H)	Size (H)	Data (H)	Parameter Name	Description	Default value (H)
3n rr 00	1	00..7F	Pitch Coarse	-64..+63	relative effect 00
3n rr 01	1	00..7F	Pitch Fine	-64..+63[cent]	relative effect 00
3n rr 02	1	00..7F	Level	0..127	absolute effect XG Drum1
3n rr 03	1	00..7F	Alternate Group	0:off,1..127	absolute effect XG Drum1
3n rr 04	1	00..7F	Pan	0:random L63..C..R63 (1..64..127)	absolute effect XG Drum1
3n rr 05	1	00..7F	Reverb Send Level	0..127	absolute effect XG Drum1
3n rr 06	1	00..7F	Chorus Send Level	0..127	absolute effect XG Drum1
3n rr 07	1	00..7F	Variation Send Level	0..127	absolute effect XG Drum1
3n rr 08	1	00..01	Key Assign	0;single,1;multi	absolute effect XG Drum1
3n rr 09	1	00..01	Rcv Note Off (Invalid for voices for which GMx specifies Note-off recognition.)	off/on	absolute effect XG Drum1
3n rr 0A	1	00..01	Rcv Note On	off/on	absolute effect XG Drum1
3n rr 0B	1	00..7F	Filter Cutoff Frequency	-64..63	relative effect 00
3n rr 0C	1	00..7F	Filter Resonance	-64..63	relative effect 00
3n rr 0D	1	00..7F	EG Attack Rate	-64..63	relative effect 00
3n rr 0E	1	00..7F	EG Decay1 Rate	-64..63	relative effect 00
3n rr 0F	1	00..7F	EG Decay2 Rate	-64..63	relative effect 00
TOTAL SIZE 10					

n:Drum Setup Number - 1

rr:note number (0D - 5B)

When XG SYSTEM ON or GM SYSTEM ON messages are received, all Drum Setup Parameters will be initialized. Drum Setup Reset message allows individual Drum Setup Parameters to be initialized.

< Table 1-8 >

Effect Type List

REVERB TYPE		[] is the order of display	
TYPE MSB	TYPE LSB	01	02
DEC	HEX	00	02
000	0	[00]No Effect	
001	1	[01]Rev Hall 1	[02]Rev Hall 2
002	2	[03]Rev Room1	[04]Rev Room 2
003	3	[06]Rev Stage 1	[05]Rev Room 3
004	4	[08]Rev Plate	
005	5	No Effect	
:	:	:	
015	F	No Effect	
016	10	[09]Rev WhiteRm	
017	11	[10]Rev Tunnel	
018	12	No Effect	
019	13	[11]Rev Basement	
020	14	No Effect	
:	:	:	
127	7F	No Effect	

CHORUS TYPE

TYPE MSB		TYPE LSB	01	02	08
DEC	HEX	00			
000	0	[00]No Effect			
001	1	No Effect			
:	:	:			
064	40	No Effect			
065	41	[01]Chorus 1	[02]Chorus 2	[03]Chorus 3	[04]Chorus 4
066	42	[05]Celeste 1	[06]Celeste 2	[07]Celeste 3	[08]Celeste 4
067	43	[09]Flanger 1	[10]Flanger 2		[11]Flanger 3
068	46	No Effect			
069	45	No Effect			
:	:	:			
:	:	:			
127	7F	No Effect			

VARIATION TYPE (0~63)

TYPE MSB		TYPE LSB	01	02
DEC	HEX	00		
000	0	[00]No Effect		
001	1	[01]Rev Hall 1	[02]Rev Hall 2	
002	2	[03]Rev Room 1	[04]Rev Room 2	[05]Rev Room 3
003	3	[06]Rev Stage1	[07]Rev Stage2	
004	4	[08]Rev Plate		
005	5	[09]DelayL,C,R		
006	6	[10]Delay L,R		
007	7	[11]Echo		
008	8	[12]CrossDelay		
009	9	[13]EarlyRef.1	[14]EarlyRef.2	
010	A	[15]GateReverb		
011	B	[16]ReversGate		
012	C	No Effect (sys) ,THRU (ins)		
:	:	:		
019	13	No Effect (sys) ,THRU (ins)		
020	14	[17]RevKaraok1	[18]RevKaraok2	[19]RevKaraok3
021	15	No Effect (sys) ,THRU (ins)		
:	:	:		
063	3F	No Effect (sys) ,THRU (ins)		

VARIATION TYPE (64~127)

TYPE MSB		TYPE LSB	01	02	08
DEC	HEX	00			
064	40	[43]THRU			
065	41	[20]Chorus 1	[21]Chorus 2	[22]Chorus 3	[23]Chorus 4
066	42	[24]Celeste 1	[25]Celeste 2	[26]Celeste 3	[27]Celeste 4
067	43	[28]Flanger 1	[29]Flanger 2	[30]Flanger 3	
068	44	[31]Symphonic			
069	45	[32]RotarySp.			
070	46	[33]Tremolo			
071	47	[34]Auto PAN			
072	48	[35]Phaser 1		[36]Phaser 2	
073	49	[37]Distortion			
074	4A	[38]Overdrive			
075	4B	[39]G-Amp.Sim.			
076	4C	[40]3 Band EQ			
077	4D	[41]2 Band EQ			
078	4E	[42]Auto Wah			
079	4F	THRU			
:	:	:			
127	7F	THRU			

< Table 1-9 >

SEQUENCER PARAMETER ADDRESS

	Address			Size	Description	QY100 (P=1)			QY70(P=0)	
	H	M	L			Recv	Trans	Req	Recv	
SYSTEM	P0	00	00	1	bulk mode on/off	O	O	O	O	
BULK DUMP SONG	P1	00	tr	147	song 1	O	O	O	*1	
	P1	01	tr		song 2	O	O	O	*1	
	P1	nn	tr		song (nn+1)	O	O	O	*1	
	:	:	:		:	:	:	:	:	
	P1	13	tr		song 20	O	O	O	*1	
	P1	7F	00		song all	X	X	O	*1	
BULK DUMP PATTERN	P2	00	tr	147	user pattern 1	O	O	O	*2	
	P2	01	tr		user pattern 2	O	O	O	*2	
	P2	nn	tr		user pattern (nn+1)	O	O	O	*2	
	:	:	:		:	:	:	:	:	
	P2	3F	tr		user pattern 64	O	O	O	*2	
	P2	7F	00		user pattern all	X	X	O	*2	
BULK DUMP SETUP	P3	00	00	32	setup parameter	O	O	O	X	
BULK DUMP ALL	P4	00	00	147	all data	X	X	O	X	
INFORMATION	P5	00	00	320	song	X	O	O	X	
	P5	01	00	512	pattern 1 - 32	X	O	O	X	
	P5	01	01	512	pattern 33 - 64	X	O	O	X	
GUITAR EFFECT	16	00	00	144	effect data 1	O	O	O	-	
	16	nn	00		effect data (nn+1)	O	O	O	-	
	:	:	:		:	:	:	:	:	
	16	7F	00		effect data all	O	O	O	-	
COMMAND	P8	00	00	1	clear song (7F=all)	O	X	X	O	
	P8	01	00		clear pattern (7F=all)	O	X	X	O	
	08	02	00		clear all (song&pat)	O	X	X	*3	
	18	02	00		clear all (s,p&effect)					
	18	03	00		init effect (7F=all)	O	X	X	-	

O : Yes X : No

*1 Pattern Track data is not received.

*2 Preset Phrase data is not received.

*3 Clear Song and Pattern data except for Effect data.

*4 Receive GROOVE TEMPLATE only for 32swing, 16swing, 8swing, 4swing and OFF. Other template data is converted into OFF,

Decimal↔Hexadecimal↔Binary Correspondence List

Many MIDI messages listed in the MIDI Data Format section are expressed in hexadecimal or binary numbers. Hexadecimal numbers may include the letter "H" as a suffix. The letter "n" indicates a certain whole number. The chart below lists the corresponding decimal number for each hexadecimal/binary number.

Decimal	Hexadecimal	Binary	Decimal	Hexadecimal	Binary	Decimal	Hexadecimal	Binary	Decimal	Hexadecimal	Binary
0	00	0000 0000	32	20	0010 0000	64	40	0100 0000	96	60	0110 0000
1	01	0000 0001	33	21	0010 0001	65	41	0100 0001	97	61	0110 0001
2	02	0000 0010	34	22	0010 0010	66	42	0100 0010	98	62	0110 0010
3	03	0000 0011	35	23	0010 0011	67	43	0100 0011	99	63	0110 0011
4	04	0000 0100	36	24	0010 0100	68	44	0100 0100	100	64	0110 0100
5	05	0000 0101	37	25	0010 0101	69	45	0100 0101	101	65	0110 0101
6	06	0000 0110	38	26	0010 0110	70	46	0100 0110	102	66	0110 0110
7	07	0000 0111	39	27	0010 0111	71	47	0100 0111	103	67	0110 0111
8	08	0000 1000	40	28	0010 1000	72	48	0100 1000	104	68	0110 1000
9	09	0000 1001	41	29	0010 1001	73	49	0100 1001	105	69	0110 1001
10	0A	0000 1010	42	2A	0010 1010	74	4A	0100 1010	106	6A	0110 1010
11	0B	0000 1011	43	2B	0010 1011	75	4B	0100 1011	107	6B	0110 1011
12	0C	0000 1100	44	2C	0010 1100	76	4C	0100 1100	108	6C	0110 1100
13	0D	0000 1101	45	2D	0010 1101	77	4D	0100 1101	109	6D	0110 1101
14	0E	0000 1110	46	2E	0010 1110	78	4E	0100 1110	110	6E	0110 1110
15	0F	0000 1111	47	2F	0010 1111	79	4F	0100 1111	111	6F	0110 1111
16	10	0001 0000	48	30	0011 0000	80	50	0101 0000	112	70	0111 0000
17	11	0001 0001	49	31	0011 0001	81	51	0101 0001	113	71	0111 0001
18	12	0001 0010	50	32	0011 0010	82	52	0101 0010	114	72	0111 0010
19	13	0001 0011	51	33	0011 0011	83	53	0101 0011	115	73	0111 0011
20	14	0001 0100	52	34	0011 0100	84	54	0101 0100	116	74	0111 0100
21	15	0001 0101	53	35	0011 0101	85	55	0101 0101	117	75	0111 0101
22	16	0001 0110	54	36	0011 0110	86	56	0101 0110	118	76	0111 0110
23	17	0001 0111	55	37	0011 0111	87	57	0101 0111	119	77	0111 0111
24	18	0001 1000	56	38	0011 1000	88	58	0101 1000	120	78	0111 1000
25	19	0001 1001	57	39	0011 1001	89	59	0101 1001	121	79	0111 1001
26	1A	0001 1010	58	3A	0011 1010	90	5A	0101 1010	122	7A	0111 1010
27	1B	0001 1011	59	3B	0011 1011	91	5B	0101 1011	123	7B	0111 1011
28	1C	0001 1100	60	3C	0011 1100	92	5C	0101 1100	124	7C	0111 1100
29	1D	0001 1101	61	3D	0011 1101	93	5D	0101 1101	125	7D	0111 1101
30	1E	0001 1110	62	3E	0011 1110	94	5E	0101 1110	126	7E	0111 1110
31	1F	0001 1111	63	3F	0011 1111	95	5F	0101 1111	127	7F	0111 1111

- For example, 144 - 159(Decimal)/9nH/1001 0000 - 1001 1111(Binary) indicate the note-on messages for the channels 1 through 16 respectively. 176 - 191/BnH/1011 0000 - 1011 1111 indicate the control change messages for the channels 1 through 16 respectively. 192 - 207/CnH/1100 0000 - 1100 1111 indicate the program change messages for the channels 1 through 16 respectively. 240/F0H/1111 0000 is positioned at the beginning of data to indicate a system exclusive message. 247/F7H/1111 0111 is positioned at the end of the system exclusive message.
- aaH(Hexadecimal)/0aaaaaaa(Binary) indicates the data addresses. The data address consists of High, Mid and Low.
- bbH/0bbbbbbb indicates byte counts.
- ccH/0ccccccc indicates check sums.
- ddH/0ddddddd indicates data/value.

YAMAHA [Music Sequencer --- voice part] Date:06-OCT-2000
 Model QY100 MIDI Implementation Chart Version : 1.0

Function ...	Transmitted	Recognized	Remarks
Basic Channel	1 - 16 1 - 16	1 - 16 1 - 16	Memorized
Mode	3	1	Memorized
Messages Altered	x *****	1 - 4 (m=1) x	*2
Note Number : True voice	0 - 127 *****	0 - 127 0 - 127	Transpose
Velocity Note ON Note OFF	0 9nH,v=1-127 x 9nH,v=0	o v=1-127 x	
After Touch	x x	x o	*1
Pitch Bender	x	o 0-24 semi	
	0,32	o	Bank Select
	1,7,10	o	
	5,11,64,65-67	x	
	6,38	x	
Control	16	x	Data Entry
	71-74	o	Assignable Cntrl
Change	84	o	Sound Controller
	91,93,94	o	Portamento Cont. Effect SendLevel

	96,97	x	0	Data INC,DEC
98,99	x		0	NRPN LSB,MSB
100,101	x		0	RPN LSB,MSB
120	x		0	All Sound Off
121	x		0	Reset All Cntrls

Prog	0 0 - 127		0 0 - 127	
Change : True #	*****		0 - 127	

System Exclusive	0		0	

System : Song Pos.	x		x	
: Song Sel.	x		x	
Common : Tune	x		x	

System :Clock	x		x	
Real Time :Commands	x		x	

Aux :Local ON/OFF	x		x	
:All Notes OFF	x		o(123-127)	
Mes- :Active Sense	o		o	
sages:Reset	x		x	

Notes: *1 receive if switch is on.				
*2 m is always treated as "1" regardless of its value.				

Mode 1 : OMNI ON, POLY	Mode 2 : OMNI ON, MONO		o : Yes	
Mode 3 : OMNI OFF, POLY	Mode 4 : OMNI OFF, MONO		x : No	

YAMAHA [Music Sequencer --- sequencer part] Date:06-OCT-2000
 Model QY100 MIDI Implementation Chart Version : 1.0

Function ...	Transmitted	Recognized	Remarks
Basic Channel	1 - 16	1 - 16	Memorized
Changed	x	x	
Mode	x	x	
Default Messages	x	x	
Altered	*****	x	
Note Number : True voice	0 - 127	0 - 127	

Velocity Note ON	o 9nH, v=1-127	o v=1-127	
Note OFF	x 9nH, v=0	x	
After Touch	o	o	
Ch's	o	o	
Pitch Bender	o	o	
0-121	o	o	
Control Change			

Prog Change : True # 0 0 - 127 0 0 - 127

System Exclusive 0 0

System : Song Pos. 0 *2 *1

: Song Sel. 0 *2 *1

Common : Tune x

System :Clock 0 *2 *3

Real Time :Commands 0 *2 *1

Aux :Local ON/OFF 0 0

:All Notes OFF x x

Mes- :Active Sense x x

sages:Reset x x

Notes: *1 if MIDI control is in or in/out
 *2 if MIDI control is out or in/out
 *3 if MIDI sync is external

Mode 1 : OMNI ON, POLY Mode 2 : OMNI ON, MONO 0 : Yes

Mode 3 : OMNI OFF, POLY Mode 4 : OMNI OFF, MONO x : No



This document is printed on chlorine free (ECF) paper with soy ink.

Auf Umweltpapier mit Sojatinte gedruckt.

Ce document a été imprimé sur du papier non blanchi au chlore avec de l'encre d'huile de soja.

Yamaha Web Site (English only)

<http://www.yamahasynt.com>

Yamaha Manual Library

<http://www2.yamaha.co.jp/manual/english/>

U.R.G., Pro Audio & Digital Musical Instrument Division, Yamaha Corporation

© 2000 Yamaha Corporation

V675840 311POCP2.3-03B0 Printed in Japan