



DIGITAL MIXING SYSTEM

RIVAGE

PM SERIES

Operation Manual

EN

Table of Contents

Intruduction	24
<hr/>	
About the Relevant Manuals	24
Trademarks	25
Component Structure	26
<hr/>	
Control surface	26
Digital mixing console	35
About RIVAGE PM Editor	37
DSP engine	38
I/O rack	40
RY cards	44
HY card	45
Part Names & Functions (CS-R10, CS-R10-S, CSD-R7)	47
<hr/>	
Selected Channel section	47
INPUT/A.GAIN/SILK/D.GAIN/DELAY	49
EQUALIZER	51
LPF/HPF	52
DCA/MUTE/INSERT	53
DYNAMICS	54
MIX/MATRIX SENDS	55
UTILITY section	57
SCENE MEMORY section	59
USER DEFINED KEYS/KNOBS section	61
Touch Screen section (bay L, bay C)	63
Channel Strip section (bay L, bay R, bay C)	65
[TOUCH AND TURN] knob/layer selection	68
Front panel of the control surface	70

Rear panel of the control surface 72
Precautions regarding using the NETWORK connector 78

Part Names & Functions (CS-R5, CS-R3) 80

Selected Channel section 80
GAIN 81
DYNAMICS 82
EQUALIZER 83
UTILITY section 84
SCENE MEMORY section 86
USER DEFINED KEYS section 88
Touch Screen section 90
Channel Strip section 93
Front panel 101
Rear panel 103

Basic operations on the panel 108

Basic touch screen operations 108
Basic operations on the top panel 109
Shut down (power-off procedure) 111
Other convenient functions 112
On-screen user interface 113
Viewing a touch screen 117
Entering names 123
Using tool buttons 125
Resetting parameters to default 127
Comparing two settings 128
Using libraries 130
Recalling a preset from a library 131
Library screen (Recall) 132
Storing setting data in a library 133
Library screen (Store) 134

Deleting setting data from a library 135
Library screen (Delete) 136
Pair setting 137
Setting or defeating pairing on the SELECTED CHANNEL VIEW screen 140

Screen Overview 142

About the SELECTED CHANNEL VIEW window 142
About the OVERVIEW window 157

Quick Guide 165

Basic system 165
Installing optional cards 167
Assigning the Unit ID 173
Connecting the devices 175
Turning on the power to the system 177
Setting the word clock 178
Assigning channels to the TWINLANe network 179
Patching the input ports 184
Patching the output ports 186
Specifying the analog gain for the HA (head amp) 188
Routing a signal to the STEREO bus 189

Network and Connections 193

About the TWINLANe Network 193
Connecting a TWINLANe network card 194
Signal flow within the RPiO 196
About Connections 198
About Dual Console 201
TWINLANe mirroring 202
About DSP mirroring 204
Parameter mirroring 207
Verifying the DSP mirroring operation 209

Make RPi0622 / 222 a word clock leader	210
Forced switching by GPI connection between DSPs	211
About Dante	212
Connecting to a Dante network	213
DSP mirroring function in the Dante audio network	214
Word clock in the RIVAGE PM series	215
About the sampling rate converter (SRC)	216
About connecting a computer	217
Bay	218
<hr/>	
About bays	218
Faders and fader layers	219
Selected channel concepts	223
BAY LINK	227
System Setup	232
<hr/>	
About the SETUP screen	232
SYSTEM SETUP field (SETUP screen)	233
USER SETUP field (SETUP screen)	235
FILE field (SETUP screen)	236
MAINTENANCE field (SETUP screen)	237
CONSOLE STATUS field (SETUP screen)	238
PANEL SETTINGS field (SETUP screen)	240
SYSTEM CONFIG	241
SYSTEM CONFIG Online settings	242
Synchronizing the settings data between components	243
DEVICE SYNC screen	244
Selecting and setting up the components	245
[SYSTEM] tab	246
HY SLOT tab	249
Assigning the channels (that will be used by the I/O racks) to the TWINLANE network	251

I/O rack settings popup window	253
Assign the channels that will be used by the DSP engines to the TWINLANE network	256
DSP popup window	257
TWINLANE CONFIGURATION popup window	259
SYSTEM CONFIG [CS1] popup window	261
Editing the internal parameters of each component	262
Editing the internal parameters of the RY16-ML-SILK	263
Editing the internal parameters for OMNI OUT of the RY16-DA and control surface	265
Editing the internal parameters for INPUT 1-8/INPUT 9-16 of the RY16-AE, and AES/EBU INPUT 1-8 on the rear panel of the control surface	267
Editing the internal parameters for OUTPUT 1-8/OUTPUT 9-16 of the RY16-AE, and AES/EBU OUTPUT 1-8 on the rear panel of the control surface	269
Editing the internal parameters of the MY CARD INPUT	271
Editing the internal parameters of the MY CARD OUTPUT	272
Editing the internal parameters for OMNI IN of the control surface	274
Settings for the HY128-MD card	276
SYSTEM CONFIG Offline settings	280
Mounting an I/O rack (offline)	281
SYSTEM CONFIG popup window (Offline)	283
Specifying the type and number of cards (Offline)	284
RY CARD SELECT popup window	285
MY CARD SELECT popup window	286
HY CARD SELECT popup window	287
DELAY COMPENSATION	288
DELAY COMPENSATION popup window	289
Word Clock	291
WORD CLOCK popup window	292
Network	294
NETWORK screen: FOR MIXER CONTROL tab	295
NETWORK screen: IMMERSIVE SOUND tab	297
Dante audio network settings	298

HY SLOT window	299
DANTE SETUP popup window	301
Dante messages	304
Mounting an I/O rack	309
DEVICE SELECT popup window	310
DEVICE LIST	311
SUPPORTED DEVICE	312
DVS or MANUAL	313
Patching an I/O rack	314
Remotely controlling an I/O rack	317
HY SLOT window	319
DANTE I/O DEVICE [I/O] screen	321
I/O DEVICE screen: HA	323
I/O DEVICE screen: OUTPUT	325
I/O DEVICE screen: WIRELESS	327
BUS SETUP (Basic settings for MIX buses and MATRIX buses)	329
BUS SETUP page	331
SEND POINT (INPUT) (Specifying the send point for each input channel)	332
SEND POINT page	333
Mix minus	335
BUS SETUP popup window	337
MIX MINUS OWNER popup window	338
SEND indications for a mix minus bus	339
SURROUND SETUP (specifying surround mode)	340
SURROUND SETUP screen	342
SELECTED CHANNEL VIEW screen (SURROUND)	343
OVERVIEW screen (SURROUND)	344
SURROUND PAN 1CH screen	345
SURROUND PAN CH1-36/ CH37-72/ CH73-108/ CH109-144 screen	347
DOWNMIX screen	348
SURROUND MONITOR screen	349
SURROUND MONITOR SETTINGS popup window	351

MONITOR SOURCE popup window (SURROUND) 353
MONITOR SOURCE popup window (SURROUND) 354
SURROUND CUE SETTING popup window 355
PHONES popup window 356

Patching 357

Input channel I/O unit section 357
Input channel mixing engine section 359
Patching the input ports 364
Display when patching conflicts between engines 365
INPUT patch window 368
Output channel mixing engine section 370
Output channel I/O unit section 376
Patching the output ports 377
OUTPUT patch window 378
Changing the name 380
PATCH/NAME screen 381
NAME/ICON EDIT popup window 382
Port to port 384
PORT-PORT patch window 386
PORT NAME tab 387
SUB IN 389

Monitor 391

About monitoring 391
Using the Monitor function (top panel) 393
Using the Monitor function 394
Monitor sources 396
MONITOR screen 397
MONITOR SETTINGS popup window 399
MONITOR SOURCE popup window 402
MONITOR SOURCE SELECT popup window (INPUT) 403

MONITOR SOURCE SELECT popup window (OUTPUT)	404
MONITOR SOURCE SELECT popup window (DIRECT INPUT)	405
INPUT PATCH popup window	406
Inserting a plug-in into monitor signals	407
MONITOR SETTINGS popup window (insert)	408
MONITOR INSERT popup window	409
INSERT MOUNT screen	410
About cue	411
About Cue mode and Solo mode	414
About cue/solo groups	415
CUE OPERATION mode	418
Using the Cue function	419
MONITOR screen (cue)	421
CUE popup window	423
CUE SETTINGS popup window	426
OUTPUT PATCH popup window	427
Using the Solo function	428
SOLO SAFE popup window	430
About oscillators	432
Using the oscillators	433
Destination of oscillator signals	434
MONITOR screen (oscillator)	435
OSCILLATOR popup window	436
About talkback	439
Using talkback (top panel)	440
Using talkback	441
MONITOR screen (talkback)	443
TALKBACK SETTINGS popup window	445
TALK GROUPS popup window	448
TALKBACK ASSIGN popup window	449
About PHONES	450
Using PHONES	451

MONITOR screen (PHONES) 452
PHONES popup window 453
Using RTA 455
Using a popup window dedicated to the RTA 456
MONITOR screen (RTA) 457
RTA popup window 458
Using the HPF/EQ popup window for the channel parameters 460
Using the GEQ popup window for the inserted GEQ 461
Using the PEQ popup window for the inserted PEQ 462

Meters 463

Meter area 463
Operating the METER screen 465

CH Parameter 470

About GAIN/SILK 470
Controlling GAIN/SILK via the Selected Channel section(CS-R10, CSR10- S, CSD-R7) 471
Controlling GAIN via the Selected Channel section (CS-R5, CS-R3) 473
Controlling GAIN/SILK via the OVERVIEW screen 475
GAIN/SILK popup window 476
Controlling GAIN/SILK via the SELECTED CHANNEL VIEW screen 478
Signal level that flows on the TWINLANE network when gain compensation is on 479
About EQ 480
EQUALIZER section(CS-R10, CSR10- S, CSD-R7) 481
Controlling the EQ via the Selected Channel section (CS-R10, CSR10- S, CSD-R7) 483
EQUALIZER(CS-R5, CS-R3) 484
Controlling the EQ via the Selected Channel section (CS-R5, CS-R3) 486
Controlling the EQ via the OVERVIEW screen 487
Controlling an EQ via the SELECTED CHANNEL VIEW screen 488

EQ popup window (CH 1-72, CH 73-144, MIX, MTRX/ST) 489

EQ popup window (1ch) 490

Touch EQ screen 494

About DYNAMICS 496

DYNAMICS section 497

Controlling a dynamics processor via the Selected Channel section 498

Controlling a dynamics processor via the OVERVIEW screen 499

Dynamics fields 500

**Controlling a dynamics processor via the SELECTED CHANNEL VIEW screen
..... 501**

DYNAMICS 1/2 popup window (1CH) 502

DYNAMICS 1/2 popup window (CH 1-72, CH 73-144, MIX, MTRX/ST) 506

About insert 508

**Using the Selected Channel section to make INSERT settings (only for CS-R10,
CS-R10-S, CSD-R7) 509**

INSERT section 511

Using the OVERVIEW screen to make INSERT settings 512

Using the SELECTED CHANNEL VIEW screen to make INSERT settings 513

INSERT screen 514

OUTBOARD screen 515

INSERT/D.OUT popup window (1CH) 516

INSERT/D.OUT popup window (12CH INSERT 1, 12CH INSERT 2) 517

Inserting an external device into a channel 518

Directly outputting an input channel 520

INSERT/D.OUT popup window (1CH/D.OUT) 522

INSERT/D.OUT popup window (12CH/D.OUT) 523

Patching multiple Direct Outs simultaneously 524

DIRECT OUT page 525

About delay 527

DELAY section(CS-R10, CSR10- S, CSD-R7) 528

**Controlling the delay via the Selected Channel section(CS-R10, CSR10- S, CSD-
R7) 529**

Controlling the delay via the OVERVIEW screen	530
Controlling the delay via the SELECTED CHANNEL VIEW screen	531
DELAY popup window (12ch)	532
DELAY popup window (CH 1-72, CH 73-144, MIX, MTRX/ST)	534
DELAY SCALE popup window	535
DELAY TIME popup window	536
Using SENDS TO	537
Using SENDS FROM	539
MIX/MATRIX SEND section(CS-R10, CSR10- S, CSD-R7)	540
Using the Selected Channel section to make send level settings(CS-R10, CSR10- S, CSD-R7)	542
SENDS TO popup window	543
SENDS FROM popup window	545
Using the faders to adjust the sends (SENDS ON FADER mode)	547
SENDS ON FADER popup window	549
Using the Touch Screen section to make send level settings (CS-R5, CS-R3)	550
SEND/USER DEFINED KNOB popup window	552
Using the Quick data copy function	554
Operating the Quick Data Copy function from the OVERVIEW screen or SENDS TO/SENDS FROM popup windows	555
PARAMETER COPY popup window	556
Operating the Quick Data Copy function from the HPF/EQ and DYNAMICS 1/2 popup windows	557
PARAMETER SET popup window	558
Operating the Quick Data Copy function from the SELECTED CHANNEL VIEW and TO STEREO popup windows	559
PARAMETER SET popup window	560
Controlling via the TO STEREO section	561
TO STEREO section	562
ST mode and LCR mode	563
Sending a signal to a STEREO bus	565
TO STEREO popup window	567

Signal flow 570
SIGNAL FLOW popup window 571

Channel Job **573**

About DCA/Mute groups library 573
About DCA 574
Assigning channels to a DCA (Selecting the channels that will belong to a specific DCA) 575
Assigning channels to a DCA (Selecting the DCAs to which a specific channel will belong) 576
Using DCAs 577
Viewing the list of DCA status on the OVERVIEW screen 578
Using DCAs 579
DCA ROLL-OUT 580
DCA GROUP ASSIGN window (ALL DCA) 581
DCA ASSIGN popup window 582
DCA/MUTE ASSIGN window (1CH) 583
About mute groups 584
Assigning channels to a mute group (Selecting the channels that will belong to a specific mute group) 585
Assigning channels to a mute group (Selecting the mute group to which a specific channel will belong) 587
Temporarily defeating the Mute function 588
MUTE GROUP ASSIGN window (ALL MUTE) 589
DCA/MUTE ASSIGN window (1CH) 591
Channel link 592
Channel link operations 593
CH LINK popup window 594
Temporary link 595
Configuring a temporary channel link 596
Copying channel parameters 597
CH COPY popup window 599

CH COPY PRESET popup window 601
Moving channel parameters 603
CH MOVE popup window 605
Initializing channel parameters 606
CH DEFAULT popup window 607
Parameters to be copied 608

GEQ/PEQ/Automixer 611

Graphic EQ, parametric EQ and Automixer 611
About using a graphic EQ (GEQ) 612
About using a parametric EQ (PEQ) 613
About Automixer 614
DSP resource management for GEQ 615
Inserting a GEQ/PEQ into a channel via the Selected Channel section (CS-R10, CS-R10-S, CSD-R7 only) 617
INSERT screen 619
The MOUNT GEQ/PEQ screen 620
GEQ ASSIGNMENT popup window 621
Inserting a GEQ/PEQ into a channel via the OVERVIEW screen 622
Inserting a GEQ/PEQ into a channel via the SELECTED CHANNEL VIEW screen (CS-R10, CS-R10-S, CSD-R7) 623
Using the 31BandGEQ 625
GEQ/PEQ EDIT screen 627
Using the Flex15GEQ 629
Using the 8BandPEQ 631
GEQ/PEQ EDIT screen (8BandPEQ) 632
About Automixer 634
Theory of Automixer operation 635
Inserting Automixer into a channel 636
GEQ RACK screen 637
GEQ MOUNT popup window 638
GEQ RACK screen 639

Controlling the Automixer parameters 640

Plug-ins 644

About plug-ins 644

Using plug-ins 649

PLUG-IN RACK page of the RACK&REC screen 650

PLUG-IN ALLOCATION page of the RACK&REC screen 651

RACK MOUNT popup window 653

PLUG-IN ASSIGNMENT popup window 654

Plug-in screen 655

Controlling the plug-in parameters 656

Controlling the REV-X plug-in parameters 659

Controlling the SP2016 parameters 662

Controlling the VSS4HD plug-in parameters 665

 Main page 665

 Color page 668

Controlling the NonLin2 plug-in parameters 670

Controlling the Bricasti Design Y7 Stereo Reverb Processor plug-in parameters 672

Controlling the Analog Delay plug-in parameters 674

Controlling the Max100 plug-in parameters 676

Controlling the Dual Phaser plug-in parameters 677

Controlling the Vintage Phaser plug-in parameters 679

Controlling the H3000 Live plug-in parameters 680

Controlling the Rupert EQ 773 plug-in parameters 682

Controlling the Rupert EQ 810 plug-in parameters 683

Controlling the Portico 5033 plug-in parameters 685

Controlling the EQ-1A plug-in parameters 686

Controlling the Equalizer601 plug-in parameters 687

Controlling the Dynamic EQ plug-in parameters 689

Controlling the Dynamic EQ4 plug-in parameters 692

Controlling the Rupert Comp 754 plug-in parameters 694

Controlling the Rupert Comp 830 plug-in parameters	697
Controlling the Portico 5043 plug-in parameters	699
Controlling the Portico 5045 plug-in parameters	700
Controlling the U76 plug-in parameters	701
Controlling the Opt-2A plug-in parameters	702
Controlling the Comp276 plug-in parameters	703
Controlling the Buss Comp 369 plug-in parameters	704
Controlling the MBC4 plug-in parameters	708
Controlling the DaNSe plug-in parameters	711
Controlling the P2MB plug-in parameters	713
Controlling the Interphase parameters	716
Controlling the OpenDeck plug-in parameters	718
Using the Tap Tempo function	720
Effects and tempo synchronization	723

Recording 725

2-track USB recorder	725
Recording audio to a USB flash drive	726
RECORDER screen	730
Playing back audio files from a USB flash drive	733
RECORDER screen	735
Playback mode pattern	737
Editing the title list	738
RECORDER screen	740
Multitrack recording and virtual sound check	741
Signal flow during a virtual sound check (VSC)	744
Signal flow for the USB memory recorder	745
Assigning channels to the input/output of the recorder	746
RECORDER screen	747
INPUT PATCH popup window	749
OUTPUT PATCH popup window	750
Virtual sound check	751

About Dante	752
Patching for multitrack recording and virtual sound check	753
RECORDING PATCH screen	754
Recording or playing back using a DAW on the computer	756
Configuring Dante Accelerator	757
Configuring a Dante Virtual Soundcard	758
Configuring Dante Controller	759
Setting up DAW software	760
Audio recording and playback	761
NUENDO Live	762
NUENDO Live SETUP Screen	763
NUENDO Live Screen	766
Scene memory	768
<hr/>	
About the conceptual memory diagram	768
About scene memories	770
Using the keys in the SCENE MEMORY section	773
Storing scenes (Using the keys in the SCENE MEMORY section)	775
SCENE STORE screen	777
Automatic suggestion of scene numbers and names	779
Updating scenes (Using the keys in the SCENE MEMORY section)	780
Recalling scenes (Using the keys in the SCENE MEMORY section)	781
SCENE field	783
Storing scenes (Using the SCENE LIST screen)	784
SCENE LIST screen	786
Recalling scenes (Using the SCENE LIST screen)	788
Using USER DEFINED keys to recall a scene (Direct Recall function)	789
Sorting scene memories	792
SCENE LIST screen	793
About editing scene memories	795
Deleting a scene (DELETE)	796
Duplicating a scene (DUPLICATE)	797

Modifying the scene number and title (RENAME)	798
About the Focus function	799
Using the Focus function	800
FOCUS field	802
SCENE SETUP (FOCUS) popup window	803
Using the Fade function	806
FADE TIME field	807
SCENE SETUP (FADE TIME) popup window	808
Outputting a control signal to an external device in tandem with scene recall (GPI OUT)	809
GPI field	811
Playing back an audio file in tandem with scene recall (PLAYBACK LINK)	812
PLAYBACK LINK field	814
PLAYBACK LINK popup window	815
Using the Global Paste function	816
GLOBAL PASTE screen	818
GLOBAL PASTE PARMETERS screen	820
About the Recall Safe function	823
Using the Recall Safe function	824
RECALL SAFE window	825
Creating an event list	828
EVENT LIST window	829
Automatic alignment of events	832
EVENT LIST EDIT popup window	833
Using MANUAL to recall scenes from an event list	834
EVENT LIST screen	835
About the Isolate function	836
Using Preview mode	837
Using Preview mode (Using the keys in the SCENE MEMORY section)	838
Using Preview mode (Using the SCENE LIST screen)	839
About the functions in Preview mode	840

OVERLAY 842

About the Overlay function 842

Selected Channel section (OVERLAY) 843

Controlling the Overlay function using the keys and knobs on the top panel
..... 847

Controlling the Overlay function from the touch screen 848

OVERLAY SETTING screen 849

Example of panel and touch screen indication while Overlay is enabled 851

File 852

SAVE/LOAD 852

Data handled by a settings file 853

Saving the RIVAGE PM series’s settings on a USB flash drive 855

SAVE SELECT screen 857

Loading a file from a USB flash drive 861

LOAD SELECT screen 864

LOAD SELECT screen 866

LOAD SELECT screen 867

About loading 869

Editing the files saved on the USB flash drive 870

SAVE/LOAD popup window 871

Sorting files and editing file names/comments 873

Sort buttons located at the top of the file list 874

Copying and pasting a file 875

Deleting a file 876

Creating a directory 877

Exporting a CSV file 878

CSV EXPORT/IMPORT popup window 880

Theatre Mode 881

Theatre mode 881

How to configure the Theatre mode settings	882
How to configure the Theatre mode settings for DSP engines	884
SELECTED CHANNEL VIEW screen (Theatre mode)	885
Added indicators in Theatre mode	886
OVERVIEW screen	888
How to configure the actor library settings	889
Actor library screen	890
AFC IMAGE control	892
<hr/>	
AFC IMAGE settings	892
NETWORK screen: IMMERSIVE SOUND tab	893
SELECTED CHANNEL VIEW screen	895
IMMERSIVE SOUND popup window (1CH)	896
IMMERSIVE SOUND popup window (OBJ1-36, OBJ37-72, OBJ73-108, OBJ109-128)	897
AFC IMAGE field	898
Genius.lab	899
<hr/>	
Genius.lab	899
MACRO LIST window	900
MACRO EDIT window	902
Using macros	905
CAPTURE window	915
MACRO KEYS window	916
MACRO KEY LABEL window	917
MACRO LOG window	918
User Setup	919
<hr/>	
Preference settings	919
SURFACE SETTINGS1	920
SURFACE SETTINGS2	922
SCREEN SETTINGS	925

MISC	927
Channel Strip section: Using the CUSTOM [1]/[2] keys (CS-R10, CSD-R7)	928
Channel Strip section: Using the [CUSTOM] keys (CS-R5, CS-R3)	929
Custom fader banks and main faders	930
CUSTOM FADER BANK popup window	932
USER DEFINED KNOBS section	934
Assigning a function to a USER DEFINED knob	935
USER DEFINED KNOBS popup window	937
Functions that can be assigned to the USER DEFINED knobs	938
Channel Strip section	943
Assigning a function to a channel strip encoder	946
Using the USER DEFINED keys section (CS-R10, CSD-R7)	949
Using the USER DEFINED keys section (CS-R5, CS-R3)	950
Assigning a function to a USER DEFINED key	953
Modifying the contents displayed for the USER DEFINED keys	954
USER DEFINED KEYS popup window	955
USER DEFINED KEY LABEL popup window (CS-R10, CSD-R7)	958
USER DEFINED KEY LABEL popup window (CS-R5, CS-R3)	959
Functions that can be assigned to the USER DEFINED keys	960
Using the Alternate function	970
MIDI/GPI	971
<hr/>	
About MIDI	971
Basic MIDI Settings	972
MIDI/GPI window (MIDI SETUP page)	974
MIDI SETUP popup window	976
Using Program Changes to recall scenes	977
MIDI/GPI window (PROGRAM CHANGE page)	980
MIDI PROGRAM CHANGE popup window	982
Using Control Changes to control parameters	983
MIDI PROGRAM CHANGE popup window	985
MIDI/GPI window (CONTROL CHANGE page)	986

About GPI	987
Using GPI IN	989
GPI page	991
Using GPI OUT	992
GPI page	994
Using FADER START	995
FADER START page	996
Time code	998
GPI OUT functions	999

Maintenance 1000

Firmware version	1000
Firmware updates	1001
Adjusting the faders	1002
Adjusting the detection point of the touch screen panels (CS-R10, CS-R10-S, CSD-R7)	1004
Adjusting the detection point of the touch screen panels (CS-R5 and CS-R3)	1006
Initializing the unit to factory default settings	1008
INITIALIZATION page	1010
System dump (CS-R10, CS-R10, CSD-R7)	1011
PORT TRIM page	1012
System log	1013
SYSTEM LOG page	1015
System dump (CS-R10, CS-R10, CSD-R7)	1016
DSP-RX INFORMATION	1017
Adjusting the input/output gain	1018

Console Status 1019

Setting the date and time of the internal clock	1019
DATE/TIME popup window	1021

Panel Settings 1022

Specifying the brightness of the touch screens, LEDs, channel name displays, and lamps	1022
Console Lock	1024
PASSWORD popup window	1026
Unlocking the console	1027
Specifying the CONSOLE LOCK screen image	1028

Setting up RIVAGE PM Editor and RIVAGE PM StageMix 1029

About RIVAGE PM Editor	1029
On-line monitoring/operation	1030
PM Editor startup screen	1034
Off-line editing	1035
Synchronizing the edited mixing data	1037
RIVAGE PM Editor On-screen operation	1039
About RIVAGE PM Editor screens	1041
Operating the faders in the METER screen (Full Screen) (RIVAGE PM Editor)	1043
Saving and loading a file (RIVAGE PM Editor)	1044
Initializing PM Editor	1045
About RIVAGE PM StageMix	1046
Network settings for the control surface	1047
Network settings on the iPad	1049

Messages 1050

Messages	1050
DSP Messages	1059

Intruduction

About the Relevant Manuals

The manuals related to the RIVAGE PM series are organized as follows.

Paper manuals

[RIVAGE PM10 System Setup Guide](#)

[RIVAGE PM7 System Setup Guide](#)

This guide provides an overview of the RIVAGE PM series, and explains step by step how to set up the system from connecting devices to producing sound.

[Manuals for each device](#)

The manual for each device describes part names and functions of that device.

Each manual is packaged with the corresponding device.

Online manuals

RIVAGE PM series Operation Manual (this document)

This manual provides a detailed explanation of the screens and functions shown on the control surface and the digital mixing console.

Overview is concerned mainly with providing an overview and explaining the concepts needed to understand the RIVAGE PM series.

Operations explains specific procedures and operations.



RIVAGE PM Editor Installation Guide

This guide explains how to install RIVAGE PM Editor.



RIVAGE PM StageMix User Guide

This guide describes an iPad application that enables you to control the RIVAGE PM series system wirelessly.

NOTE

All manuals can be downloaded from the Yamaha website. If necessary, you can review updated manual information, which is always posted on the Yamaha website.

<https://download.yamaha.com/>

Trademarks

- The illustrations and screenshots in this manual are entirely for the purpose of explanation.
- We bear no responsibility whatsoever for the effects or impacts of using the software or this manual.
- Windows is a registered trademark in the United States and other countries of Microsoft Corporation of the United States.
- Mac and iPad are trademarks of Apple Inc. registered in the United States and other countries.
- MIDI is a registered trademark of Association of Musical Electronics Industry (AMEI).
- Mackie Control and HUI are registered trademark or trademarks of LOUD Technologies Inc.
- The names and trade names in this manual are the registered trademarks or trademarks of the companies involved.
- TUXERA is a registered trademark of Tuxera Inc. in the US and other countries.

The logo for Tuxera, featuring the word "TUXERA" in a bold, white, sans-serif font. The letters are set against a solid red rectangular background. The letter "X" has a distinctive design with a horizontal stroke that tapers to the right, giving it a sense of motion or speed.

Component Structure

Control surface

The CS-R10 control surface lets you control all functions of the DSP engine. All audio signal operations such as mixing and routing, memory functions, and system settings can be controlled. The following functionality is provided.

- Total 38 faders (12 channels x 3 panels + 2 channels) on CS-R10 and CS-R5
- Total 26 faders (12 channels x 2 panels + 2 channels) on CS-R10-S
- Fully-featured Selected Channel section, which inherits the traditional elements of Yamaha digital mixing consoles
- Easy-to-use user interface via touch operation on the large LCD panel
- Equipped with audio in/out jacks (Local I/O) to connect onboard equipment or a CD player, and control I/O connectors (MIDI/GPI) to control external devices
- Two-track USB recorder function to make live recordings and play background music or sound effects without additional equipment
- Two built-in power supply units, providing power redundancy

CS-R10

Top panel

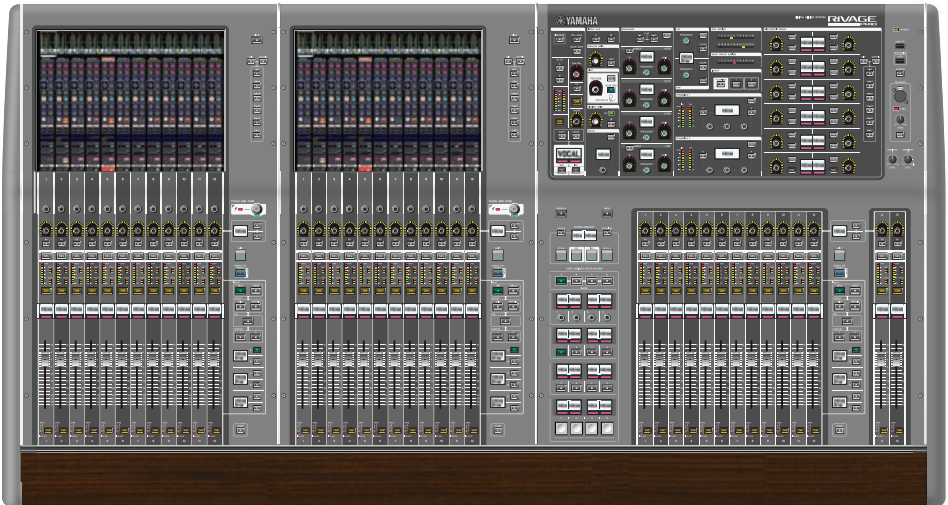

Front panel

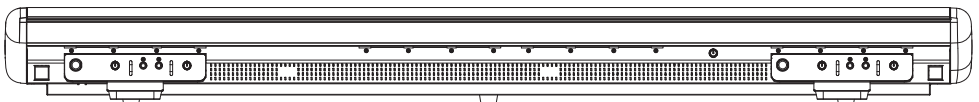

Rear panel



Jack list

Jack	Connector	Number of jacks
OMNI IN (ANALOG)	XLR-3-31 Type	8
OMNI OUT (ANALOG)	XLR-3-32 Type	8
AES/EBU IN	XLR-3-31 Type	4
AES/EBU OUT	XLR-3-32 Type	4
TO ENGINE (Console Network)	etherCON CAT5e	2
WORD CLOCK OUT	BNC	1
MIDI IN	DIN 5P	1
MIDI OUT	DIN 5P	1
PHONES	TRS 1/4" (6.35 mm)	4 (front)
TALKBACK	XLR-3-31 Type	1
USB	TYPE A USB	1 (top) 3 (rear)
RECORDING	TYPE A USB	1
GPI	D-Sub 25P (Female)	1
VIDEO OUT	DVI-D	1
NETWORK (PC)	etherCON CAT5	1
LAMP	XLR-4-31 Type	4
AC INLET	V-Lock Type	2

Slot list

Slot	Number
MY CARD SLOT	2

CS-R10-S

Top panel

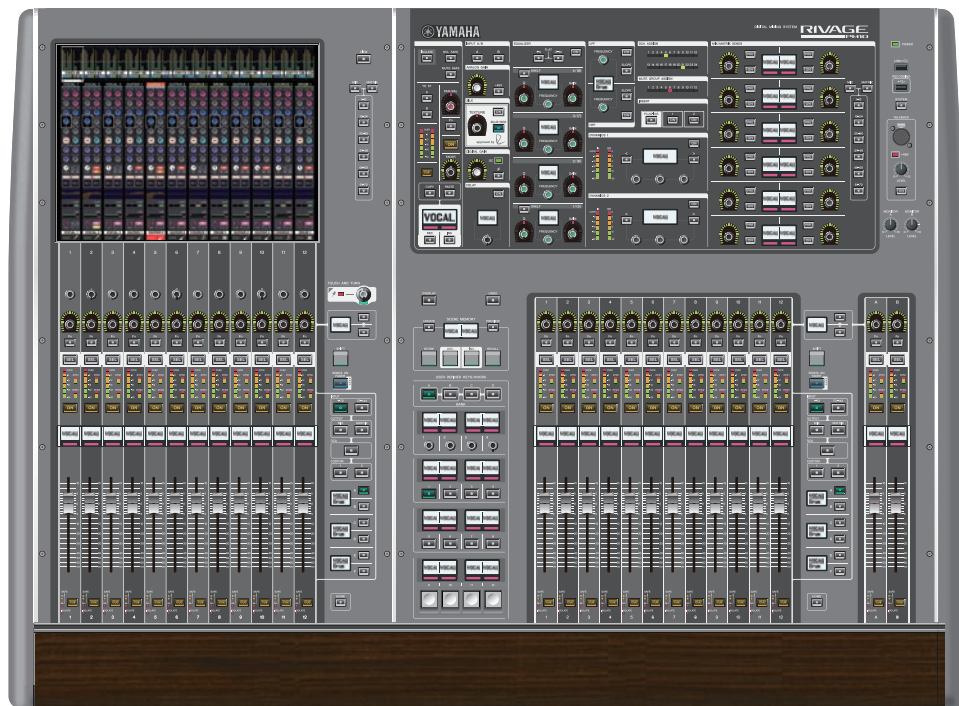

Front panel

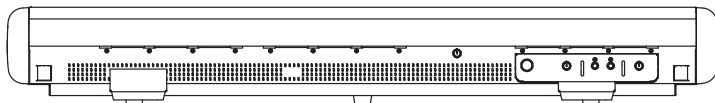

Rear panel

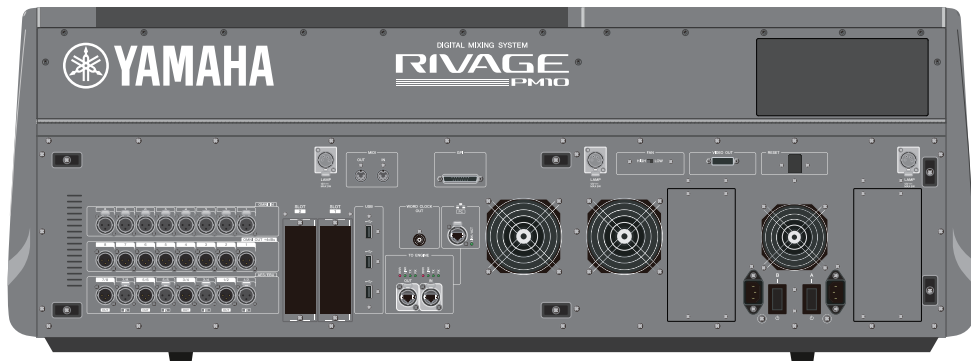

Jack list

Jack	Connector	Number of jacks
OMNI IN (ANALOG)	XLR-3-31 Type	8
OMNI OUT (ANALOG)	XLR-3-32 Type	8
AES/EBU IN	XLR-3-31 Type	4
AES/EBU OUT	XLR-3-32 Type	4
TO ENGINE (Console Network)	etherCON CAT5e	2
WORD CLOCK OUT	BNC	1
MIDI IN	DIN 5P	1
MIDI OUT	DIN 5P	1
PHONES	TRS 1/4" (6.35 mm)	2 (front)
TALKBACK	XLR-3-31 Type	1
USB	TYPE A USB	1 (top) 3 (rear)
RECORDING	TYPE A USB	1
GPI	D-Sub 25P (Female)	1
VIDEO OUT	DVI-D	1
NETWORK (PC)	etherCON CAT5	1
LAMP	XLR-4-31 Type	3
AC INLET	V-Lock Type	2

Slot list

Slot	Number
MY CARD SLOT	2

CS-R5

Top panel



Front panel



Rear panel



Jack list

Jack	Connector	Number of jacks
OMNI IN (ANALOG)	XLR-3-31 Type	8
OMNI OUT (ANALOG)	XLR-3-32 Type	8
AES/EBU IN	XLR-3-31 Type	2
AES/EBU OUT	XLR-3-32 Type	2
TO ENGINE (Console Network)	etherCON CAT5e	2
MIDI IN	DIN 5P	1
MIDI OUT	DIN 5P	1
PHONES	TRS 1/4" (6.35 mm)	2(front)
USB	TYPE A USB	1 (top) 3 (rear)
RECORDING	TYPE A USB	1
GPI	D-Sub 25P (Female)	1
NETWORK (PC)	etherCON CAT5	1
LAMP	XLR-4-31 Type	3
AC INLET	V-Lock Type	2

Slot list

Slot	Number
MY CARD SLOT	2

CS-R3

Top panel



Front panel

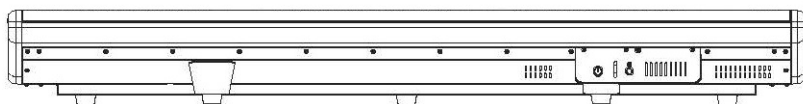

rear panel



Rear panel

Jack	Connector	Number of jacks
OMNI IN (ANALOG)	XLR-3-31 Type	8
OMNI OUT (ANALOG)	XLR-3-32 Type	8
TO ENGINE (Console Network)	etherCON CAT5e	2
MIDI IN	DIN 5P	1
MIDI OUT	DIN 5P	1
PHONES	TRS 1/4" (6.35 mm)	1(front)
USB	TYPE A USB	1 (top) 3 (rear)
RECORDING	TYPE A USB	1
GPI	D-Sub 25P (Female)	1
NETWORK (PC)	etherCON CAT5	1
LAMP	XLR-4-31 Type	2
AC INLET	V-Lock Type	2

Slot list

Slot	Number
MY CARD SLOT	2

Digital mixing console

All audio signal operations such as mixing and routing, memory functions, and system settings can be controlled. This unit also has a built-in DSP engine that handles 120 input, 60 mix, 24 matrix, and 2 stereo channels of audio processing.

CSD-R7

Top panel

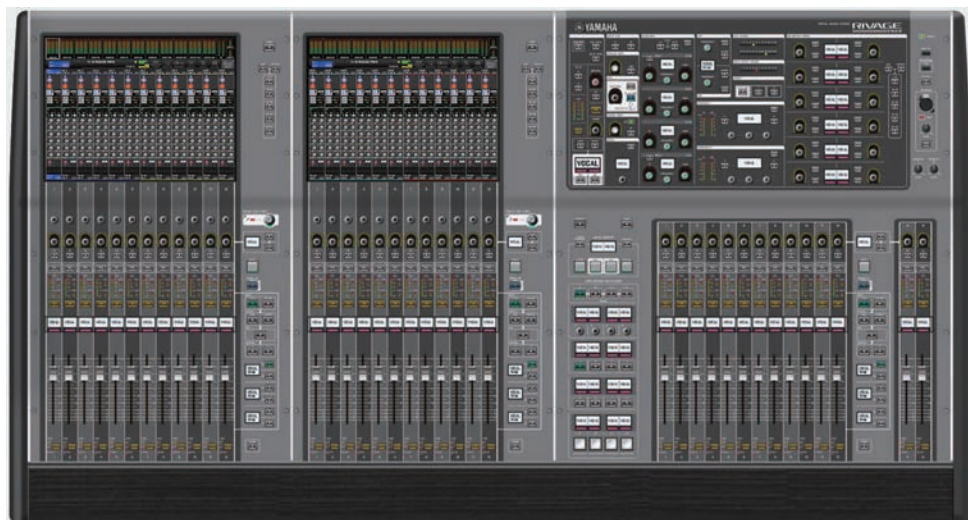

Front panel

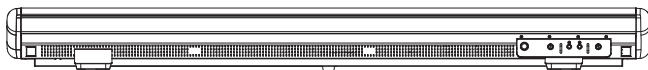

Rear panel

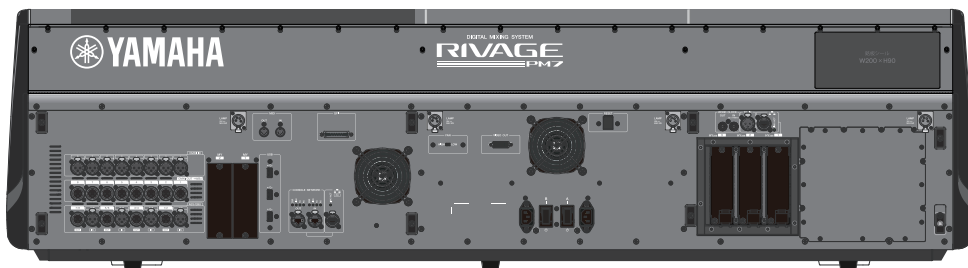

Jack list

Jack	Connector	Number of jacks
OMNI IN (ANALOG)	XLR-3-31 Type	8

Jack	Connector	Number of jacks
OMNI OUT (ANALOG)	XLR-3-32 Type	8
AES/EBU IN	XLR-3-31 Type	4
AES/EBU OUT	XLR-3-32 Type	4
WORD CLOCK IN	BNC	1
WORD CLOCK OUT	BNC	1
MIDI IN	DIN 5P	1
MIDI OUT	DIN 5P	1
PHONES	TRS 1/4" (6.35 mm)	2 (front)
TALKBACK	XLR-3-31 Type	1
USB	TYPE A USB	1 (top) 3 (rear)
RECORDING	TYPE A USB	1
GPI	D-Sub 25P (Female)	1
VIDEO OUT	DVI-D	1
NETWORK (PC)	etherCON CAT5	1
NETWORK	etherCON CAT5	1
TC IN	XLR-3-31 Type	1
LAMP	XLR-4-31 Type	4
AC INLET	V-Lock Type	2

Slot list

Slot	Number
MY CARD SLOT	2
HY CARD SLOT	3

About the HY card slots

Each HY card slot 1 – 3 is 256-in/out. A TWINLANE network card will work exclusively in HY card slot 1. The multitrack recording function will work exclusively in HY card slot 3.

About RIVAGE PM Editor

This application software enables you to access the same functions that are available on the control surface. You can use your computer to perform off-line editing by preparing the RIVAGE PM series settings in advance, and to monitor and adjust those settings (on-line monitoring/operation). You can connect a computer with RIVAGE PM Editor installed (called PM Editor elsewhere in this book) to a DSP engine or a control surface. If you connect it to a DSP engine, you can control the entire system without a control surface. Therefore, in the event that the control surface encounters a problem, you can still use your computer as a backup.

Details about the software are available on the following Yamaha Pro Audio website:

<http://www.yamahaproaudio.com/>

For information regarding how to download or install Editor, as well as its various setting details, refer to the website listed above or to the Installation Guide attached to the downloaded software program.

DSP engine

This is a DSP engine that performs all of the RIVAGE PM series's audio processing such as mixing and plug-ins. It provides four HY card slots and two MY card slots as well as control input/output connectors for external equipment. Two power supply units are built-in, providing redundant power.

DSP-R10, DSP-RX, DSP-RX-EX

Front panel



* The DSP-RX does not feature the EX badge that is attached to the lower center on the front panel of the DSP-RX-EX.

Rear panel



Jack list

Jack	Connector	Number of jacks
TO CONSOLE (Console Network)	etherCON CAT5e	2
WORD CLOCK IN	BNC	1
WORD CLOCK OUT	BNC	1
NETWORK (PC)	etherCON CAT5	1
NETWORK	etherCON CAT5	1
MIDI IN	DIN 5P	1
MIDI OUT	DIN 5P	1
TC IN	XLR-3-31 Type	1
GPI	D-Sub 25P (Female)	1
REMOTE	D-Sub 9P (Male)	1
FAULT OUTPUT	Euroblock 3P	1
AC INLET	V-Lock Type	2

Slot list

Slot	Number
MY CARD SLOT	2
HY CARD SLOT	4

About the HY card slots

Each HY card slot 1 – 4 is 256-in/out. A TWINLANe network card will work exclusively in HY card slot 1 or 2. The multitrack recording function will work exclusively in HY card slot 4.

I/O rack

This is an I/O rack for input/output of analog audio signals and digital audio signals of various formats including AES/EBU to and from the DSP engine via a TWINLANe network card installed in HY card slot 1. Two power supply units are built-in, providing redundant power.

RPio622

Front panel

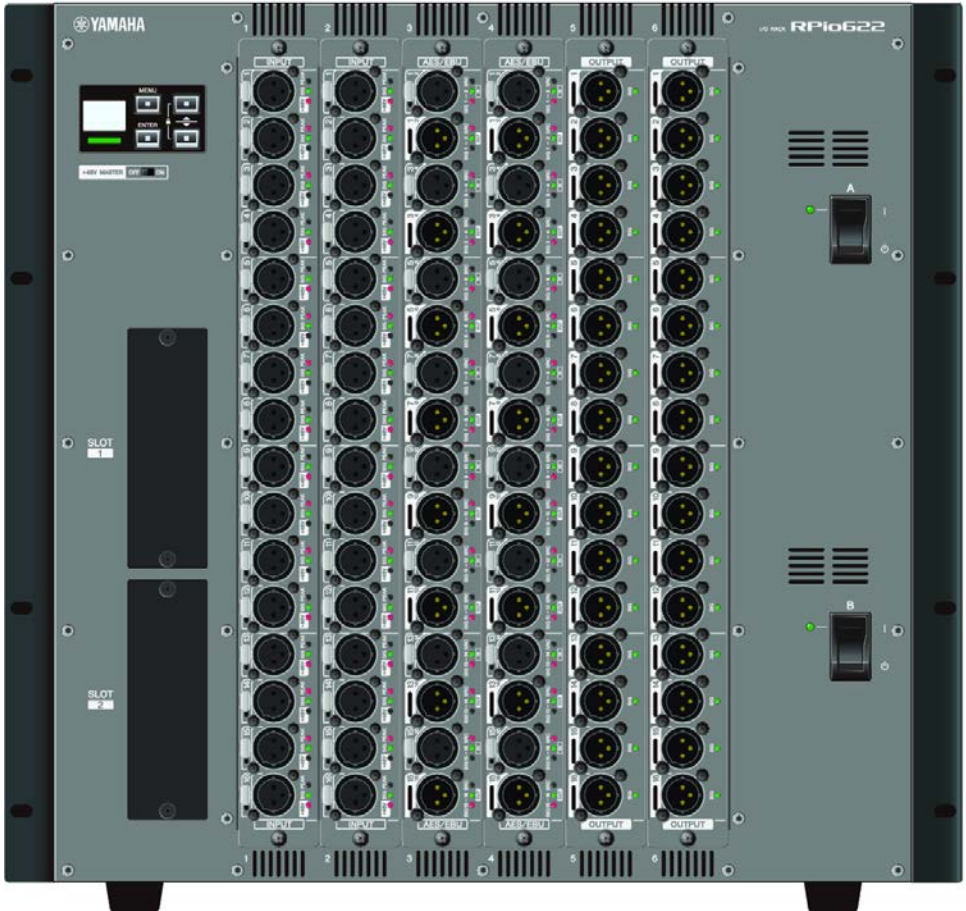

Rear panel

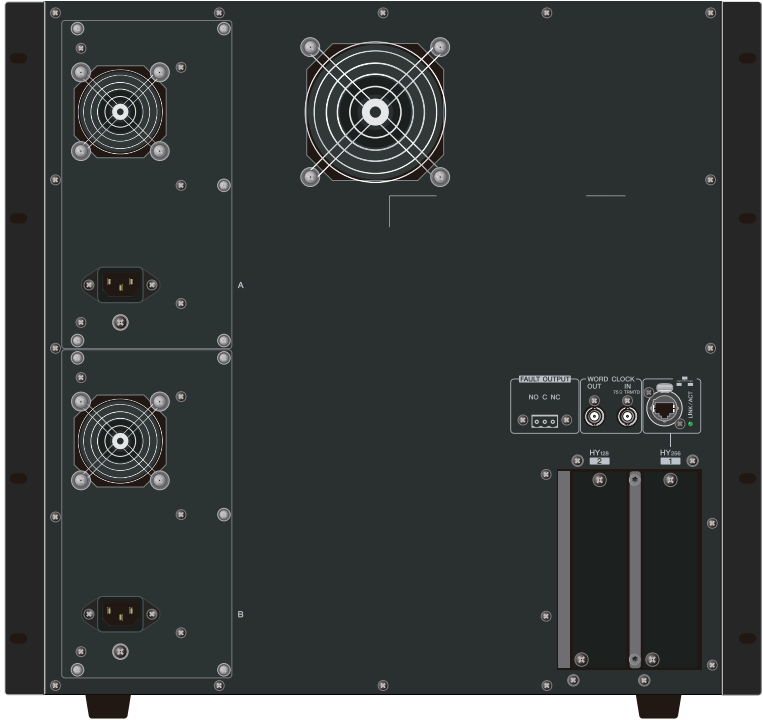

Jack list

Jack	Connector	Number of jacks
WORD CLOCK IN	BNC	1
WORD CLOCK OUT	BNC	1
NETWORK	etherCON CAT5	1
FAULT OUTPUT	Euroblock 3P	1
AC INLET	V-Lock Type	2

Slot list

Slot	Number
RY CARD SLOT	6
MY CARD SLOT	2
HY CARD SLOT	2

About the HY card slots

HY card slot 1 of the I/O rack is only for a TWINLANE network card. HY card slot 2 is reserved for Dante/MADI. HY card slot 1 is 256-in/out, and HY card slot 2 is 128-in/out.

RPio222

Front panel



Rear panel

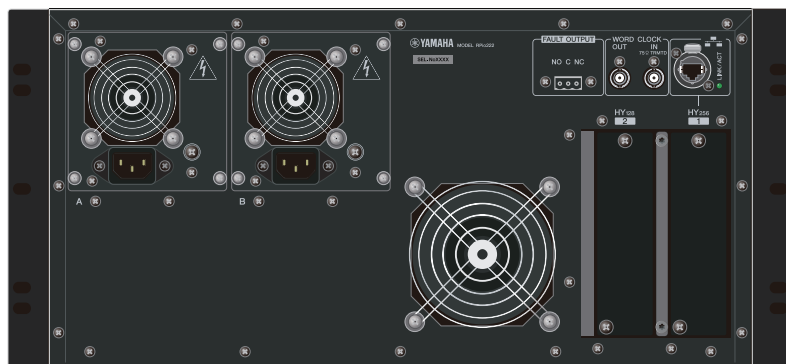

Jack list

Jack	Connector	Number of jacks
WORD CLOCK IN	BNC	1
WORD CLOCK OUT	BNC	1
NETWORK	etherCON CAT5	1
FAULT OUTPUT	Euroblock 3P	1
AC INLET	V-Lock Type	2

Slot list

Slot	Number
RY CARD SLOT	2
MY CARD SLOT	2
HY CARD SLOT	2

About the HY card slots

HY card slot 1 of the I/O rack is only for a TWINLANe network card. HY card slot 2 is reserved for Dante/MADI. HY card slot 1 is 256-in/out, and HY card slot 2 is 128-in/out.

RY cards

RY cards are 16-channel input/output cards. They support 16-channel input/output regardless of the sampling frequency.

■ Mic/line analog input card (RY16-ML-SILK)

This is a 16-channel mic/line analog input card featuring a newly developed mic preamp and Rupert Neve Designs' "Silk" processing modeled in the digital domain. See the Input channel I/O unit section for more information regarding the Silk processing.



■ Analog output card (RY16-DA)

This is a 16-channel analog output card. Level setting switches allow the maximum output level of each channel to be switched between +15 dBu, +18 dBu, and +24 dBu. For details, refer to the owner's manual of the card.



■ AES/EBU input/output card (RY16-AE)

This is a 16-in/16-out AES/EBU format digital input/output card. Sampling rate converters are provided on all inputs and outputs. For details, refer to the owner's manual of the card.



HY card

The HY cards allow multiple channels of digital audio signals and control signals to be transferred.

■ TWINLANe interface card

This is a 256-in/256-out interface card that supports Yamaha's proprietary TWINLANe audio transfer network protocol.

HY256-TL

It uses multi-mode optical fiber cables such as Neutrik's opticalCON DUO to allow transmission between devices up to 300 meters apart.

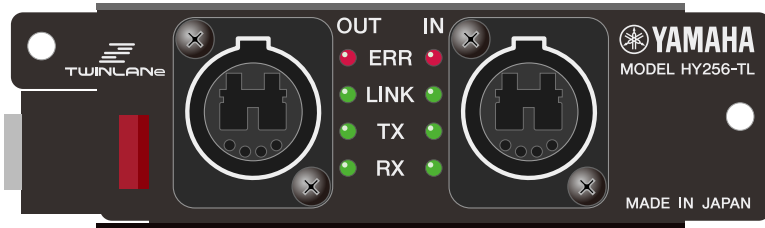

HY256-TL-SMF

It uses single-mode optical fiber cables such as Neutrik's opticalCON DUO to allow transmission between devices up to 2km apart.

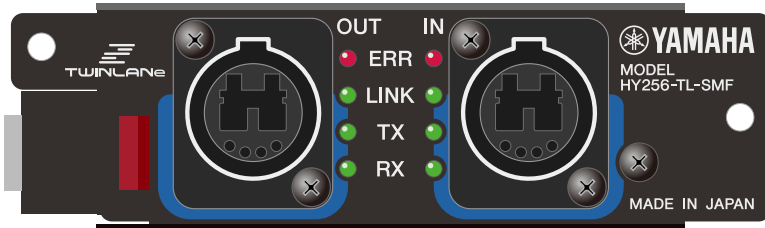

■ Dante interface card

HY144-D

This is an interface card that supports the Dante digital audio network protocol created by Audinate. It allows transfer of up to 144 channels of audio signals at a sampling frequency of 96 kHz. Transmission up to 100 meters is possible using CAT5e or better Ethernet cable.

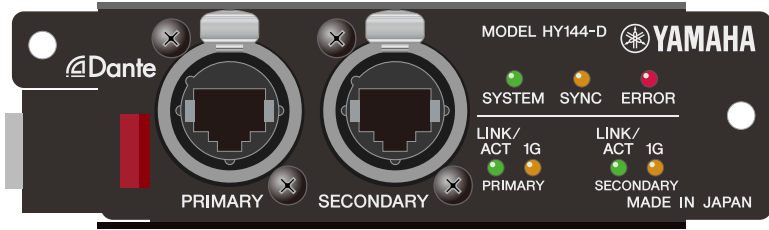

HY144-D-SRC

This interface card features five options for SRC mode, which you can select according to your purpose. It is a 144-channel, digital I/O card used for an HY card slot that supports the Dante digital audio network.



■ Audio interface card

HY128-MD

This audio interface card transmits and receives up to 128-in/128-out channels of MAD1 signals. It supports redundant connections via two fiber optic lines and two coaxial lines.

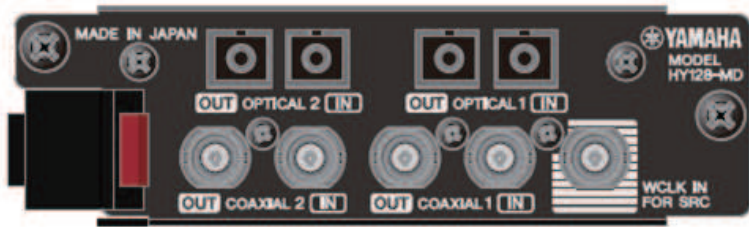

NOTE

- Please refer to the owner's manual supplied with the host device for information on installing the I/O cards.
- For detailed information on I/O card settings, refer to the owner's manual for the I/O card.
- For the latest information on which I/O cards can be used with the system, visit the Yamaha Pro Audio website at:
 - <http://www.yamahaproaudio.com/>

Part Names & Functions (CS-R10, CS-R10-S, CSD-R7)

Selected Channel section

This section enables you to adjust parameters for the selected channel.

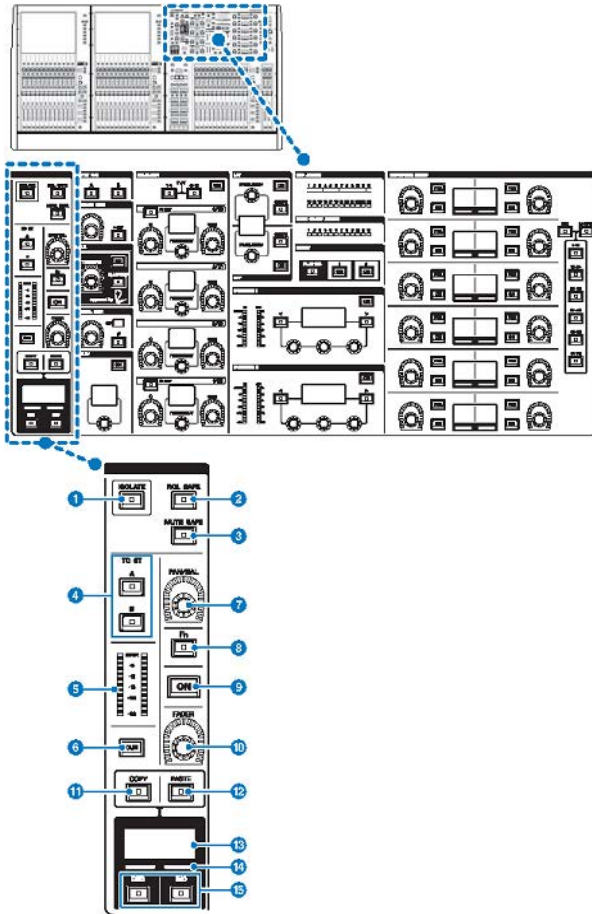

1 [ISOLATE] key

Switches Isolate on or off. The Isolate function enables you to protect the channel from any recall operations for scenes or libraries. Also, if the “isolated” channel belongs to any DCA, Mute group, or other category, the channel will be unaffected by the controls of that group.

2 [RCL SAFE] key

You can switch RECALL SAFE on or off. The Recall Safe function protects certain parameters of a channel from scene recall operations.

3 [MUTE SAFE] key

You can switch MUTE SAFE on or off. The Mute Safe function protects a channel from mute operations.

4 TO ST [A]/[B] keys

Switch on or off the signal sent from the channel to stereo bus A or B.

5 LED meter

Displays the channel signal level.

6 [CUE] key

Switches channel cue send on or off.

7 [PAN/BAL] knob

Sets the panning/balance of the signal sent to the stereo buses.

8 [Fn] (Function) key

Executes the pre-assigned function.

9 [ON] key

Switches the channel on or off.

10 [FADER] knob

Adjusts the channel fader level.

11 [COPY] key

Copies a channel parameter.

12 [PASTE] key

Pastes the copied channel parameter.

13 Channel name display

Indicates the channel number and name, and the fader level.

14 Channel color indicator

Indicates the channel color.

15 [INC]/[DEC] keys

Switch channels to edit parameters.

INPUT/A.GAIN/SILK/D.GAIN/DELAY

INPUT/A.GAIN/SILK/D.GAIN/DELAY

This section enables you to adjust parameters for the selected channel.

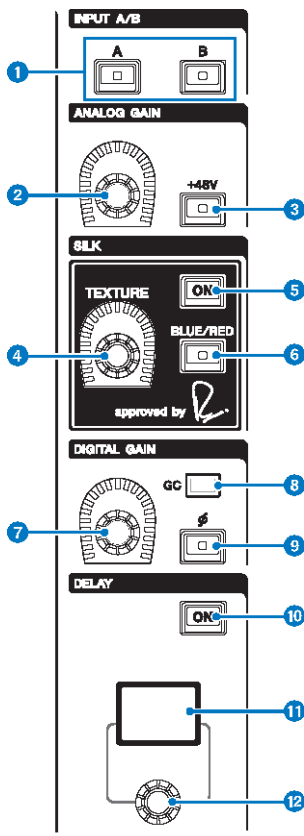

- 1 INPUT [A]/[B] keys**
Switch the input source for the selected input channel.
- 2 [ANALOG GAIN] knob**
Sets the analog gain for the head amp.
- 3 [+48V] key**
Switches phantom power (+48V) on or off.
- 4 SILK [TEXTURE] knob**
Adjusts the intensity of SILK processing.

5 SILK [ON] key

Switches the SILK on or off. SILK processing can be applied only to specific channels to bring the corresponding parts to life within the mix, or to all channels to add depth and perspective to the mix overall.

6 SILK [BLUE/RED] key

Toggles between two SILK characteristics (BLUE and RED): “BLUE” for solidity and power, and “RED” for sparkling energy.

7 [DIGITAL GAIN] knob

Sets the digital gain of the channel.

8 GC indicator

Lights up when GC (GAIN COMPENSATION) is enabled.

9 [Φ] Phase key

Reverses the phase of the input signal.

10 DELAY [ON] key

Switches the delay on or off.

11 DELAY display

Indicates the delay value.

12 [DELAY] knob

Sets the delay value.

EQUALIZER

This section enables you to adjust parameters for the selected channel.

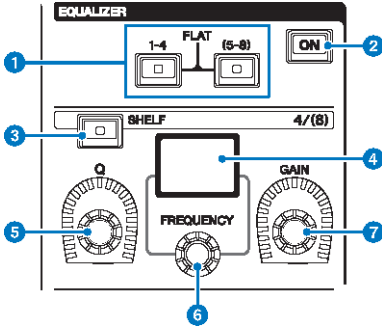

1 EQUALIZER [1-4]/[(5-8)] keys

Switch the EQ bands for which you want to make settings. Pressing both [1-4] and [5-8] keys simultaneously will set the gain for all bands to 0 (FLAT).

2 EQUALIZER [ON] key

Switches EQ on or off.

3 EQUALIZER [SHELF] key

Switches peaking filter to shelving filter.

4 EQ display

Indicates parameters for each EQ band.

5 EQUALIZER [Q] knob

Specifies the Q value.

6 EQUALIZER [FREQUENCY] knob

Sets the frequency.

7 EQUALIZER [GAIN] knob

Sets the gain.

LPF/HPF

This section enables you to adjust parameters for the selected channel.

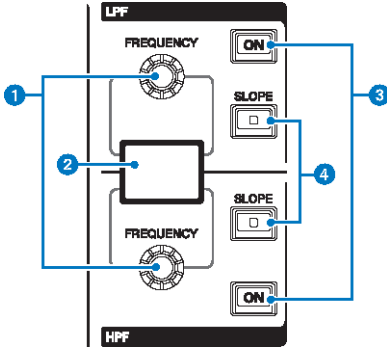

- 1 LPF/HPF [FREQUENCY] knobs**
Specify the cutoff frequency of LPF and HPF respectively.
- 2 LPF/HPF display**
Indicates the LPF and HPF settings.
- 3 LPF/HPF [ON] keys**
Switch the LPF and HPF on or off respectively.
- 4 LPF/HPF [SLOPE] keys**
Switch the LPF and HPF slope settings respectively.

DCA/MUTE/INSERT

This section enables you to adjust parameters for the selected channel.

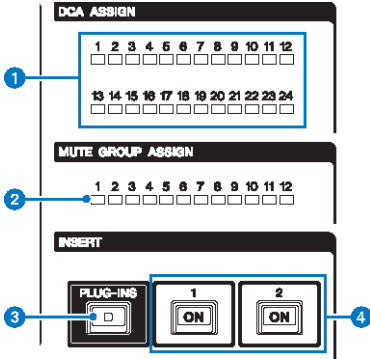

1 DCA ASSIGN LEDs

Indicate the assigned DCAs.

2 MUTE GROUP ASSIGN LEDs

Indicate the assigned Mute Groups.

3 INSERT [PLUG-INS] key

Enables you to recall a parameter setting screen for the inserted plug-in.

4 INSERT 1/2 [ON] keys

Switch INSERT1 and INSERT2 on or off respectively.

DYNAMICS

This section enables you to adjust parameters for the selected channel.

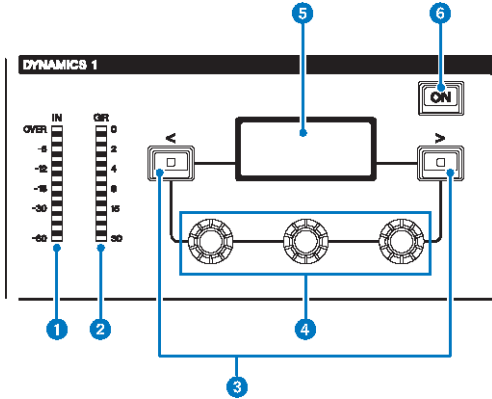

- 1 DYNAMICS 1/2 IN LED**
Indicates the Dynamics input level.
- 2 DYNAMICS 1/2 GR LED**
Indicates the amount of Dynamics gain reduction.
- 3 DYNAMICS 1/2 [<]/[>] keys**
Switch parameters that are indicated on the DYNAMICS display.
- 4 DYNAMICS 1/2 setting knobs**
Set parameters that are indicated on the DYNAMICS display.
- 5 DYNAMICS 1/2 display**
Indicates the Dynamics parameters.
- 6 DYNAMICS 1/2 [ON] key**
Switches Dynamics on or off.

MIX/MATRIX SENDS

This section enables you to adjust parameters for the selected channel.

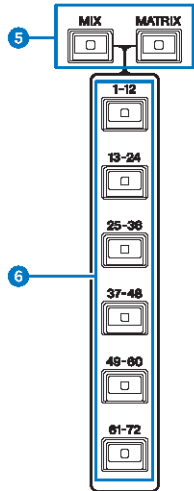
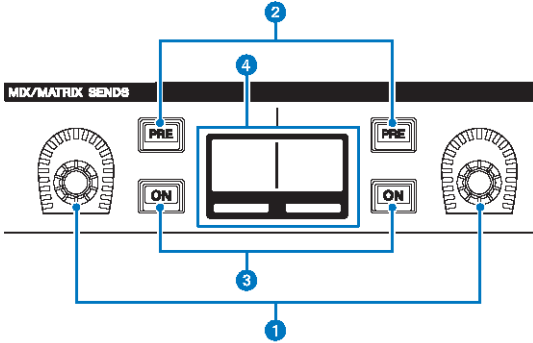

- 1 MIX/MATRIX SENDS knobs**
Adjust the send levels for the corresponding buses.
- 2 MIX/MATRIX SENDS [PRE] keys**
Toggle the send point between PRE and POST. If a key lights up, the send point is set to PRE.
- 3 MIX/MATRIX SENDS [ON] keys**
Switch the send signal to the corresponding bus on or off.
- 4 MIX/MATRIX SENDS display**
Indicates the corresponding bus.

5 MIX/MATRIX SENDS [MIX]/[MATRIX] keys

Switch the type of the send destination bus.

6 MIX/MATRIX SENDS [1-12]/[13-24]/[25-36]/[37-48]/[49-60]/[61-72] keys

Selects a bank for the send destination bus.

UTILITY section

The UTILITY section is located on the top panel.

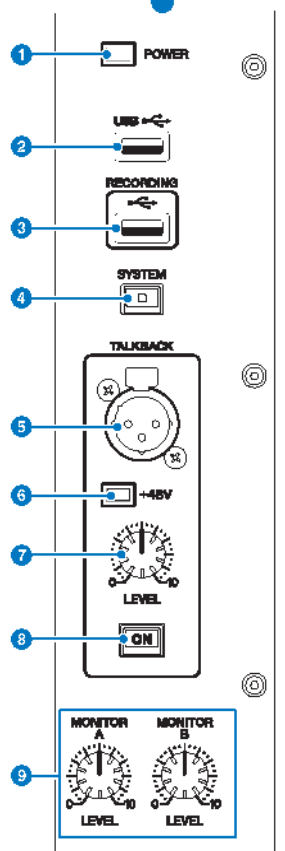
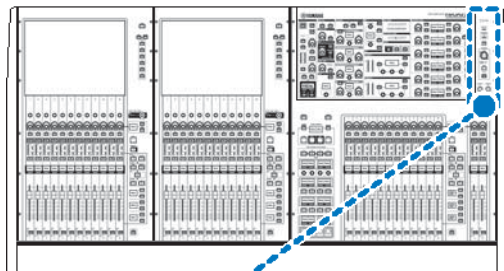

1 POWER Indicator

Lights when AC power to the unit is ON. If both power switches A and B are turned on, this indicator will light green. If either power switch A or B is turned on, it will light red. If the RIVAGE PM series is not started, it will light orange.

2 USB port

Enables you to connect a USB device (such as a mouse, keyboard, or USB flash drive). Use a USB flash drive to store the system's internal data and to load the stored data into the system.

USB flash drive format

The FAT16 and FAT32 formats are supported.

Write Protection

Some USB flash drives feature write protection that prevents data from being erased inadvertently. If your USB flash drive contains important data, we suggest that you use write protection to prevent accidental erasure. On the other hand, you will need to make sure that your USB flash drive's write-protect setting is turned off before you save data onto the USB flash drive. For the latest information on USB flash drives that can be used with the system, visit the Yamaha Pro Audio website at:

<http://www.yamahaproaudio.com/>

NOTICE

- Do not remove the USB flash drive from the USB connector or turn off the power to the unit while the unit is accessing data, e.g., saving, loading or deleting data. Doing so may damage your flash drive, or may damage the data in the unit or on your media device.

3 RECORDING port

Enables you to connect a USB flash drive to record and play back audio files. Supported file formats include WAV and MP3. For the latest information on USB flash drives that can be used with the system, visit the Yamaha Pro Audio website at:

<http://www.yamahaproaudio.com/>

4 [SYSTEM] key

Press this key to display information about the RIVAGE PM series on the touch screens. Press and hold down the key for two seconds or longer to shut down the console. Be sure to shut down before turning off the power to the unit.

5 TALKBACK jack

This is a balanced XLR-3-31 jack to which a talkback mic can be connected.

6 +48V indicator

Lights up when +48V phantom power is supplied to the TALKBACK jack.

7 TALKBACK [LEVEL] knob

Adjusts the input level of the mic connected to the TALKBACK jack.

8 TALKBACK [ON] key

Switches the Talkback function on or off.

Talkback remains on while you press and hold down this key. It turns off when you release the key.

9 MONITOR A/B [LEVEL] knobs

Adjust the output level of the monitoring signals.

SCENE MEMORY section

The section, located on the top panel, enables you to control scene memories and monitoring operations.

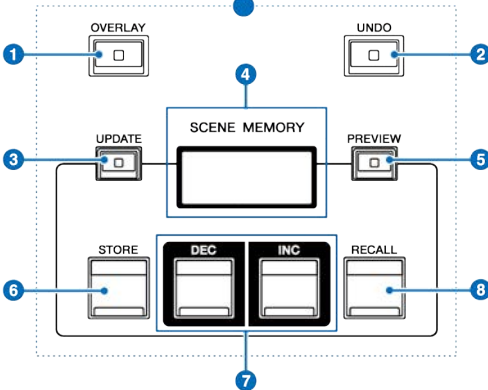
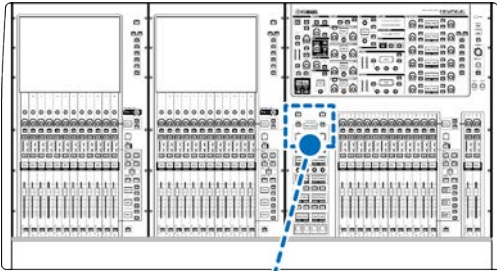

1 [OVERLAY] key

Press this button to display the OVERLAY SETTING screen. While pressing and holding down the [SHIFT] key, press the [OVERLAY] key to switch Overlay on or off. While Overlay is turned on, press and hold down the [OVERLAY] key to enter Overlay edit mode.

2 [UNDO] key

Cancels the most recent operation of storing, recalling or updating. After you cancel the operation by pressing the [UNDO] key, you can “redo” the canceled operation by pressing the [UNDO] key again.

NOTE

You cannot undo an operation to store a new scene.

3 [UPDATE] key

Updates scene data by overwriting the current scene (that has been recalled or stored most recently) with the current mix data.

4 SCENE MEMORY display

Indicates the selected scene memory.

5 **[PREVIEW] key**

Turns Preview mode on or off.

6 **[STORE] key**

Stores the current mix data to the selected scene memory.

7 **[INC]/[DEC] keys**

Enable you to select the scene number of a scene that you want to store or recall.

8 **[RECALL] key**

Enables you to recall a stored scene from scene memory.

USER DEFINED KEYS/KNOBS section

The USER DEFINED KEYS/KNOBS section is located on the top panel.

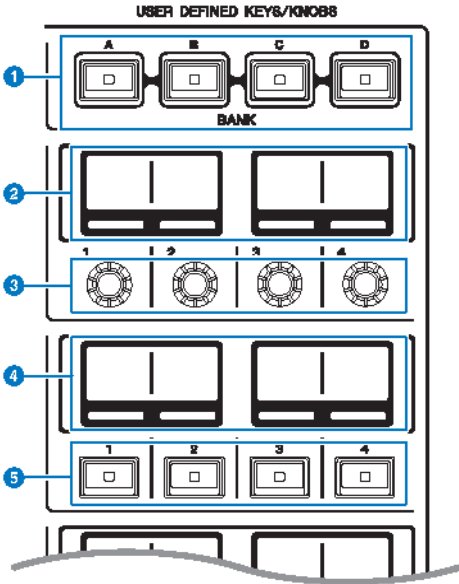
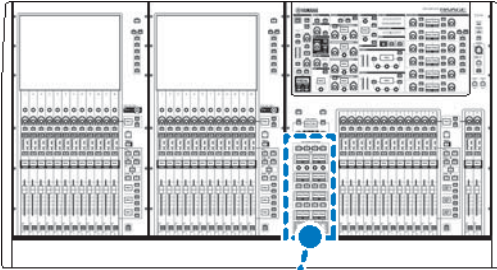

1 USER DEFINED [A]/[B]/[C]/[D] BANK keys

Select the bank ([A], [B], [C], or [D]) for the USER DEFINED knobs or USER DEFINED keys.

2 USER DEFINED KNOBS displays

Indicate the functions assigned to the USER DEFINED knobs.

3 USER DEFINED KNOBS [1]/[2]/[3]/[4]

Control the functions as assigned by the user.

4 USER DEFINED KEYS displays

Indicate the functions assigned to the USER DEFINED keys.

5 USER DEFINED KEYS [1]-[12]

Control the functions as assigned by the user.

Touch Screen section (bay L, bay C)

The Touch Screen section is located on the top panel.

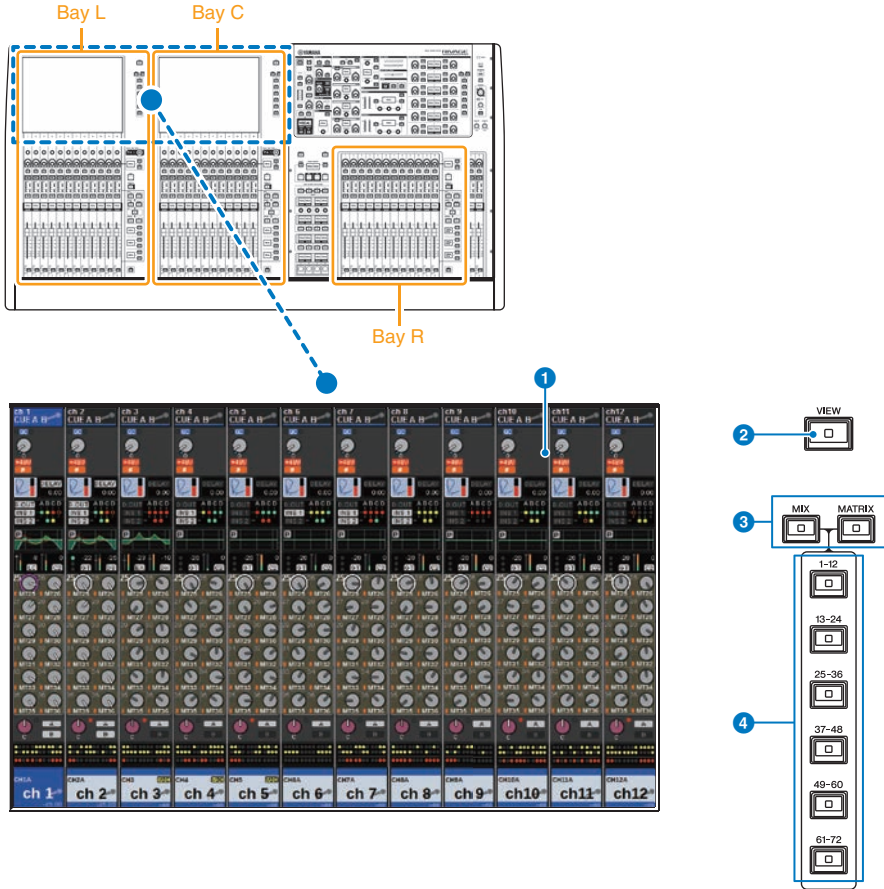

Bay

A bay consists of a group of 12 faders located across the Touch Screen section and the Channel Strip section. The CS-R10 and CSD-R7 contain three bays; the CS-R10-S contains two bays. You can control these bays independently.

1 Touch screen

This is a touch screen that you can operate by touching it with your finger to select menus or set parameters. Please note that you cannot operate the unit by touching multiple points simultaneously.

NOTICE

- Never use a sharp or pointed object such as your fingernail to operate the touch screens. Doing so may scratch the screens and render the touch screens inoperable.

NOTE

If the touch screens become dirty, wipe them with a soft dry cloth. Before use, be sure to remove the transparent film applied to the touch screens to protect them during transport.

2 [VIEW] key

Recalls and toggles between the OVERVIEW and SELECTED CHANNEL VIEW screens.

3 [MIX]/[MATRIX] keys

Specify the type of the send destination buses displayed on the OVERVIEW screen.

4 [1-12]/[13-24]/[25-36]/[37-48]/[49-60]/[61-72] keys

Enable you to select a bank for the send destination bus displayed on screen.

Channel Strip section (bay L, bay R, bay C)

The Channel Strip section is located on the top panel.

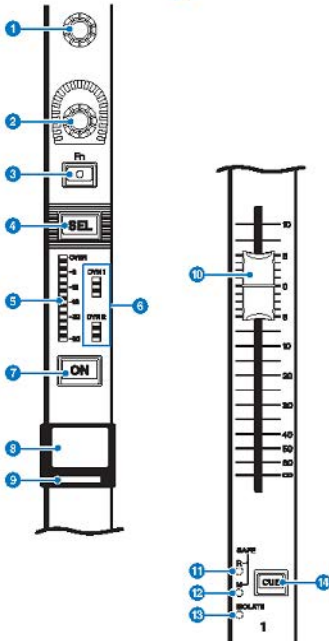
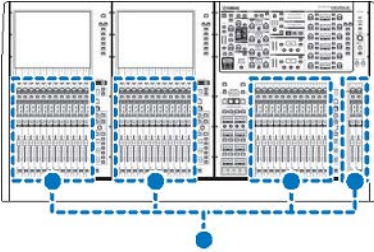

1 Screen encoder (bay L and C only)

Controls the knob currently selected on the touch screen. The knob function varies depending on the screen currently displayed.

2 **Channel strip encoder**

Adjusts the gain, pan, and the other parameters of the channel. You can assign five parameter functions (selected from the following list) to this encoder, and use the [UP]/[DOWN] keys to select the function.

- PAN/BALANCE
- ANALOG GAIN
- DIGITAL GAIN
- AUTO A.G./D.G.
- SELECTED SEND
- MIX1 SEND - MIX72 SEND
- MATRIX1 SEND -MATRIX36 SEND
- HPF FREQUENCY
- LPF FREQUENCY
- DYNAMICS1 THRESHOLD
- DYNAMICS2 THRESHOLD
- DELAY
- SILK TEXTURE
- SURROUND L-R PAN
- SURROUND F-R PAN
- SURROUND DIV
- SURROUND LFE

3 **[Fn] key**

Executes the function as assigned by the user. You can assign one of the following functions:

- INPUT A/B
- ISOLATE
- ALTERNATE CUE
- ENCODER PARAMETER
- GC ON/OFF
- SURROUND CUE
- EQ A/B
- DYNAMICS1 A/B
- DYNAMICS2 A/B
- VSC ON

4 **[SEL] key**

Enables you to select the channel that will be controlled in the Channel Strip section or on the display. When the channel is selected, the key LED will light.

5 **LED meter**

Indicate the channel level.

6 **Dynamics LEDs**

Indicate the status of Dynamics 1 and 2.

7 [ON] key

Switches the channel on or off. If the channel is on, the key LED will light. In SENDS ON FADER mode, this key works as an on/off switch for signals sent from each channel to the currently-selected MIX/MATRIX bus.

8 Channel name display

Indicates the channel name, fader level, etc.

9 Channel color indicator

Indicates the channel color. You can select the channel color from eleven options including OFF.

10 Fader

This is a touch-sensitive 100 mm motorized fader. In SENDS ON FADER mode, this fader adjusts the send level of the signal sent from each channel to the currently-selected MIX/MATRIX bus.

11 SAFE R indicator

Lights up if the channel is set to Recall Safe.

12 SAFE M indicator

Lights if the channel is set to Mute Safe.

13 ISOLATE indicator

Lights if the channel is "Isolated."

14 [CUE] key

Selects the channel for cue.

[TOUCH AND TURN] knob/layer selection

The section, located on the top panel, enables you to operate the [TOUCH AND TURN] knob and select a layer.

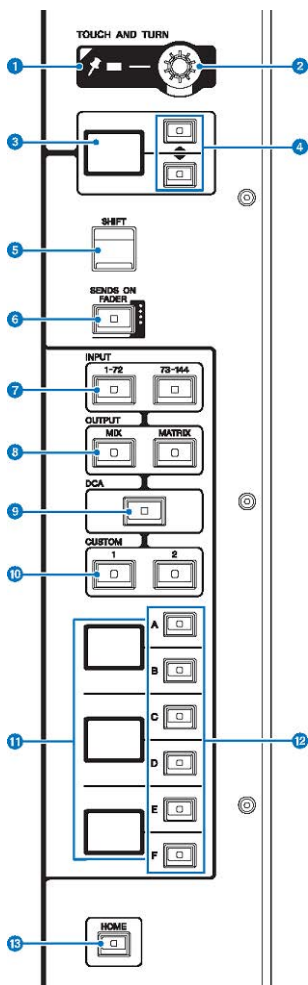

1 PIN indicator

Lights when the Pinning function for the [TOUCH AND TURN] knob is ON. (This feature will be supported by a future update.)

2 [TOUCH AND TURN] knob

Controls the parameter of the knob you are touching on the touch screen.

3 Channel strip encoder display

Indicates the function that has been assigned to the channel strip encoder.

4 UP [@U@] / DOWN [@D@] keys

Enable you to select the function that you want to control using the channel strip encoder.

5 [SHIFT] key

Combine with another key to perform certain functions. For more information, refer to the Special Key Command List for the RIVAGE PM Series.

6 [SENDS ON FADER] key

Turns SENDS ON FADER mode on and off.

7 INPUT [1-72] / [73-144] keys

Enable you to select an input layer.

NOTE

Press the INPUT [1-72] key and INPUT [73-144] key simultaneously to select the INPUT 145-288 channel layer. Press these two keys simultaneously again to select the INPUT 1-144 layer.

8 OUTPUT [MIX] / [MATRIX] keys

Enable you to select an output layer.

9 [DCA] key

Enables you to select a DCA layer.

10 CUSTOM [1] / [2] keys

Enable you to select a custom layer. You can assign up to five banks of custom faders to each custom layer (total of 60 layers). The CUSTOM [1] and [2] keys enable you to directly access two of these banks. Press CUSTOM [1] and CUSTOM [2] together to enter Custom fader mode, where you can assign custom faders and access the rest of three banks.

11 Layer display

Indicates the selected layer.

12 Layer Select [A] / [B] / [C] / [D] / [E] / [F] keys

Enable you to select a layer.

13 [HOME] key

Recalls a group of settings. Press and hold down this key to store the following settings:

- Current screen
- Selected channel/parameter on the screen
- Selected layer

Front panel of the control surface

CS-R10

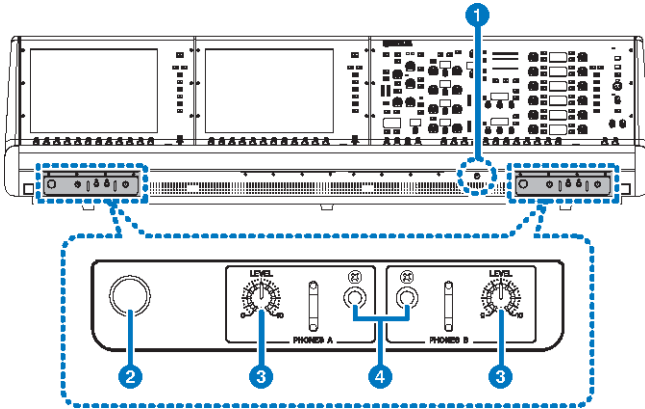

CS-R10-S

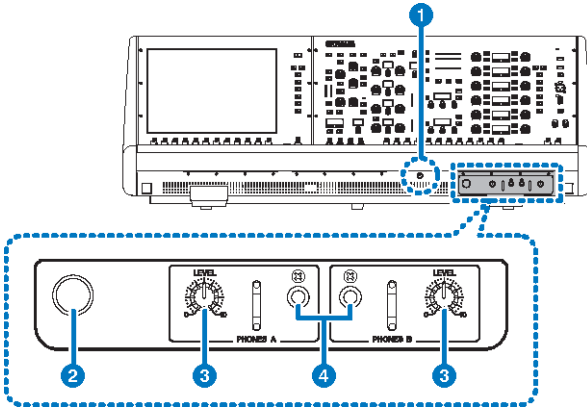

CSD-R7

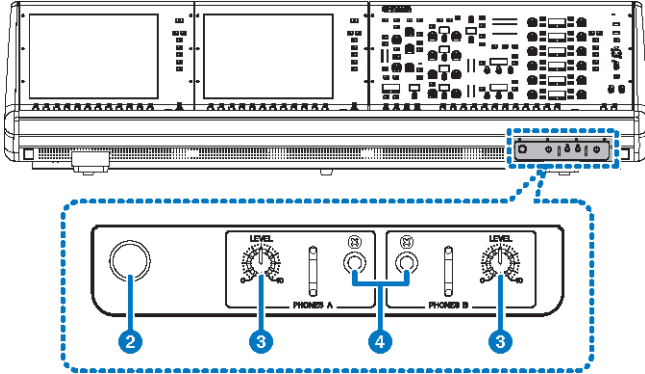

- 1 Brightness control knob**
Adjusts brightness of the light below the console.
- 2 Headphone hanger**
To use the hanger, pull out the knob, and then turn it counter-clockwise. (The hanger will be locked in place.) To put away the hanger, turn the knob clockwise to unlock it, and then push it in.
- 3 PHONES A/B [LEVEL] knobs**
Adjust the level of the signal output from the PHONES OUT jacks respectively.
- 4 PHONES A/B output jacks**
These are headphone jacks for monitoring the MONITOR or CUE signal.

Rear panel of the control surface

CS-R10

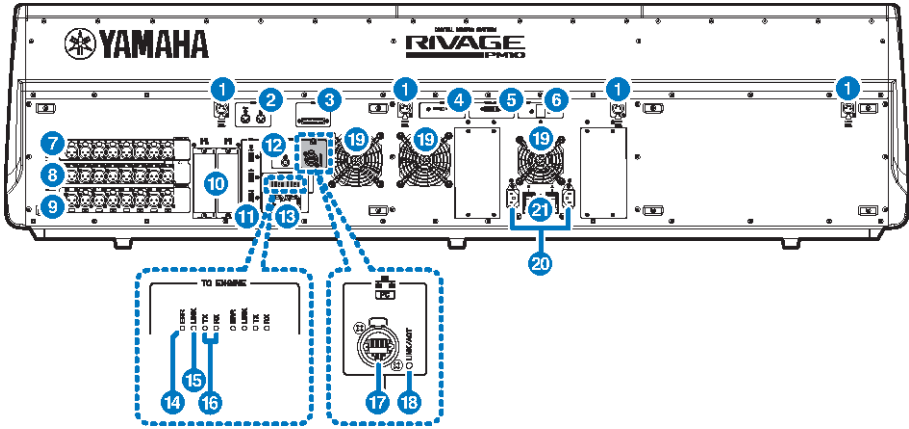

CS-R10-S

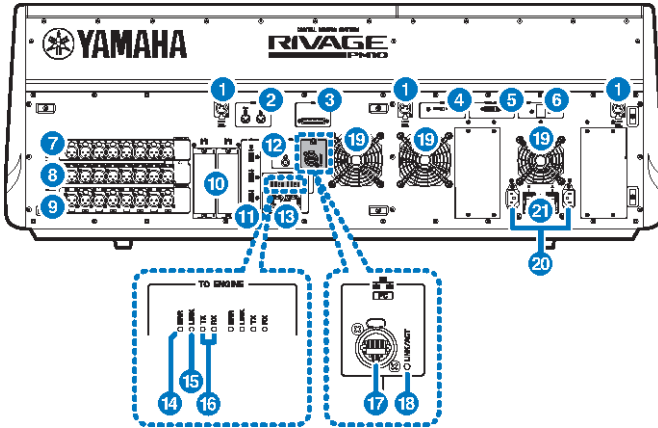

CSD-R7

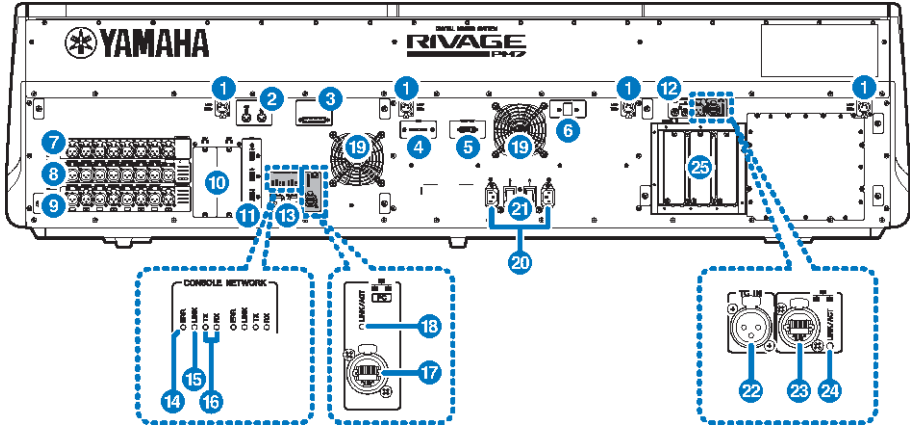

1 LAMP jacks

These 4-pin female XLR output connectors are used to supply power to Yamaha LA1L gooseneck lamps supplied with the unit (CS-R10, CSD-R7: 4 jacks; CS-R10-S: 3 jacks).

2 MIDI OUT/IN jacks

These connectors are used to transmit and receive MIDI messages to/from external MIDI devices.

3 GPI connector

This is a D-sub 25-pin female connector that allows communication (8-in, 8-out) with a GPI-equipped external device.

4 [FAN] switch

Sets the internal cooling fan to operate at either HIGH or LOW speed.

NOTE

This switch is set to LOW when the unit is initially shipped from the factory. As long as the unit is operated within the specified ambient temperature range either the LOW or HIGH setting can be used. The HIGH setting is recommended if the ambient temperature is high, if the unit is in direct sunlight even if the ambient temperature is within the specified operating range, and in any situation in which fan noise is not a problem.

5 VIDEO OUT connector

Connect your external display monitor (XGA 1024x768 or higher) to this DVI-D (Dual-link) connector.

6 [RESET] switch

Resets the control surface. Only the controls (screens, indicators, and control keys and knobs) on the control surface will restart without interrupting audio. Use this switch in case the control surface becomes non-responsive to your operations.

7 OMNI IN jacks

These are balanced XLR-3-31 female input jacks for inputting analog audio signals from line level devices or microphones. They feature SILK digital processing.

Male XLR plug

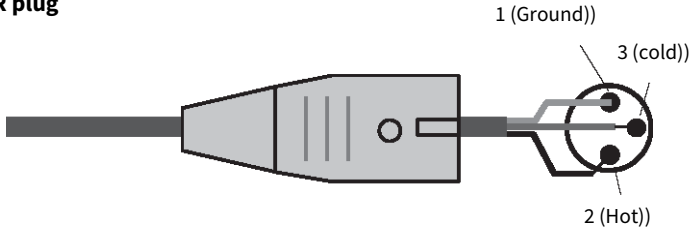

8 OMNI OUT jacks

These are balanced XLR-3-32 male output jacks that transmit analog audio signals.

Female XLR plug

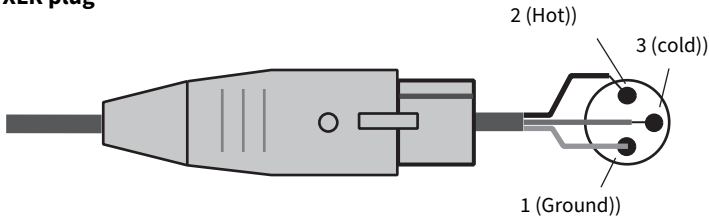

9 AES/EBU jacks

Both input and output jacks feature built-in sampling rate converters.

IN

These are balanced XLR-3-31 female input jacks that accept digital audio signals in AES/EBU format.

OUT

These are balanced XLR-3-32 male output jacks for outputting digital audio signals in the AES/EBU format.

10 MY card slots

Install optional Mini-YGDAI I/O cards here to expand I/O ports.

11 USB port

Use these ports to connect a USB storage device such as a flash drive, USB mouse, or USB keyboard.

12 WORD CLOCK OUT connector (CS-R10, CS-R10-S)

This BNC connector is used to transmit word clock signal to an external device.

WORD CLOCK OUT/IN connectors (CSD-R7)

These are BNC connectors used to transmit/receive word clock signals to/from an external device. The WORD CLOCK IN connector is internally terminated by a 75-ohm resistor.

13 TO ENGINE OUT/IN connectors (CS-R10, CS-R10-S), CONSOLE NETWORK connector (CSD-R7)

These RJ-45 connectors allow the unit to be connected to a console network in a ring topology via Ethernet cables (CAT5e or higher recommended).

NOTE

Use an STP (Shielded Twisted Pair) cable to prevent electromagnetic interference. Make sure that the metal parts of the plugs are electrically connected to the STP cable's shield by conductive tape or comparable means. The use of Ethernet cables with Neutrik etherCON CAT5 compatible RJ-45 plugs is recommended. Standard RJ-45 plugs can also be used. Cable length can span up to 100 meters between devices. Maximum practical distance may vary depending on the cable used.

14 ERR indicators

This indicator lights up or flashes red if an error occurs. In such an event, please contact your Yamaha dealer.

15 LINK indicator

This indicator flashes or lights up, depending on the network status.

Green (flashing)

The unit is preparing to connect to the console network. If it continues flashing, the system is not functioning properly. If the problem persists after you take the following actions, please contact your Yamaha dealer.

- Turn the power to the RIVAGE PM series off and then on.
- Make sure that the cables are connected properly.
- Make sure that the cables are securely inserted (locked in).
- Change to a different cable.

Green (lit steadily)

The unit is connected to the console network properly.

16 TX/RX indicators

The appropriate indicator flashes green when data is transmitted from (TX) or received at (RX) the TO ENGINE OUT/IN connectors.

17 NETWORK connector

This RJ-45 connector allows the unit to be connected to a computer or network device via an Ethernet cable (CAT5e or higher recommended).

NOTE

Use an STP (Shielded Twisted Pair) cable to prevent electromagnetic interference. Make sure that the metal parts of the plugs are electrically connected to the STP cable's shield by conductive tape or comparable means. The use of Ethernet cables with Neutrik etherCON CAT5 compatible RJ-45 plugs is recommended. Standard RJ-45 plugs can also be used. Cable length can span up to 100 meters between devices. Maximum practical distance may vary depending on the cable used.

18 LINK/ACT indicator

This indicator flashes or lights up green, depending on the connection status.

19 Vent

The control surface is equipped with cooling fans. These vents let warm air out from the unit. Please make sure that you do not block the vents with any object.

20 AC IN connectors

Use these sockets to connect the supplied power cords. First connect the AC power cords to this unit, and then insert the power cord plugs into AC outlets. Insert the cable plugs all the way until they lock in place securely. The supplied AC power cords feature a V-lock mechanism via a latch, which prevents the power cords from disconnecting accidentally.



CAUTION

- Be sure to turn off the power to the unit before connecting or disconnecting the power cords.

To disconnect each power cord, remove it while pressing the latch on the plug.

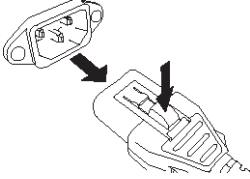

21 I/⏻ (Power switches)

Toggle between power on (I) and off (⏻). While the power is turned on, the “UTILITY section” (p.57) on the top panel will light up.

22 TC IN connector

This balanced XLR-3-31-type female connector accepts time code signals from a connected external device.

Male XLR plug

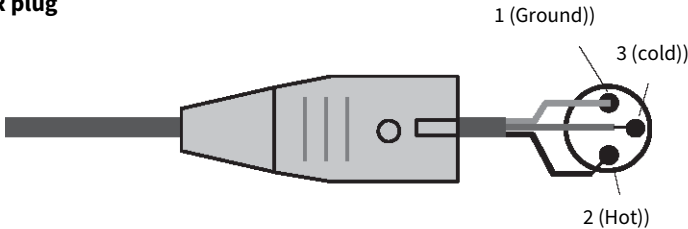

23 NETWORK connector

This RJ-45 connector enables you to connect an external device via an Ethernet cable (CAT5 or higher).

NOTE

Use an STP (Shielded Twisted Pair) cable to prevent electromagnetic interference. Make sure that the metal parts of the plugs are electrically connected to the STP cable’s shield by conductive tape or comparable means. The use of Ethernet cables with Neutrik etherCON CAT5 compatible RJ-45 plugs is recommended. Standard RJ-45 plugs can also be used. Cable length can span up to 100 meters between devices. Maximum practical distance may vary depending on the cable used.

24 LINK/ACT indicator

This indicator lights up or flashes green, depending on the connection status.

25 HY card slots

Enable you to install optional HY cards and connect to an I/O rack, such as RPi0622, to expand I/O ports.

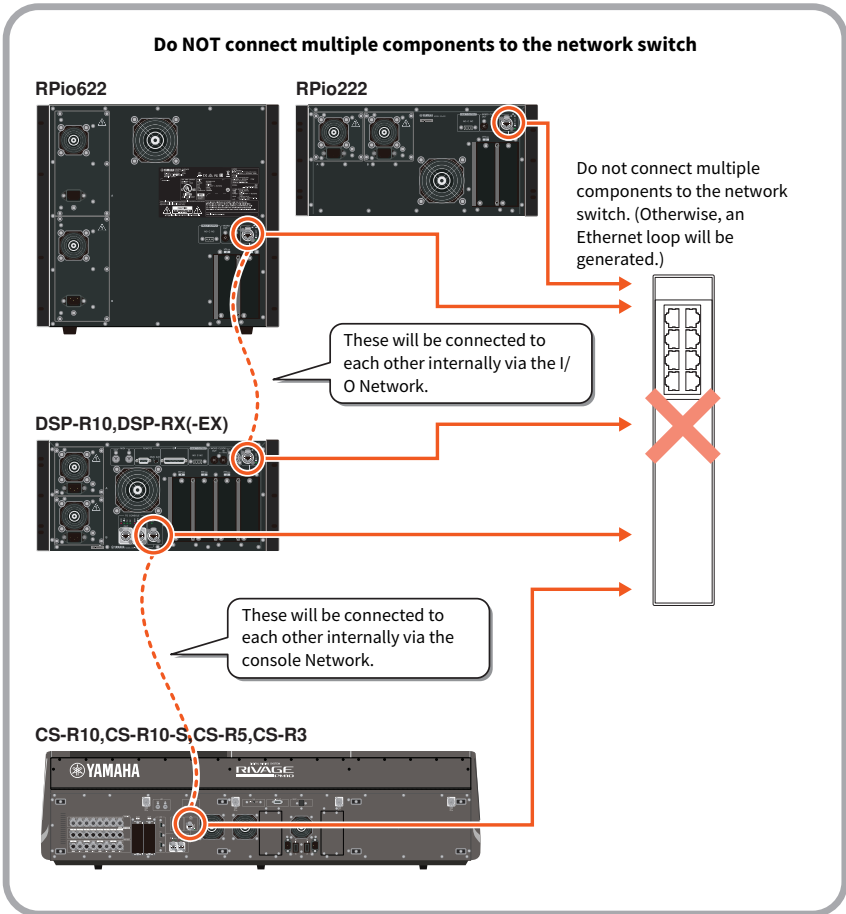

Part Names & Functions (CS-R5, CS-R3)

Selected Channel section

This section enables you to adjust parameters for the selected channel.

The knobs in the Selected Channel section feature the Touch Sense function.

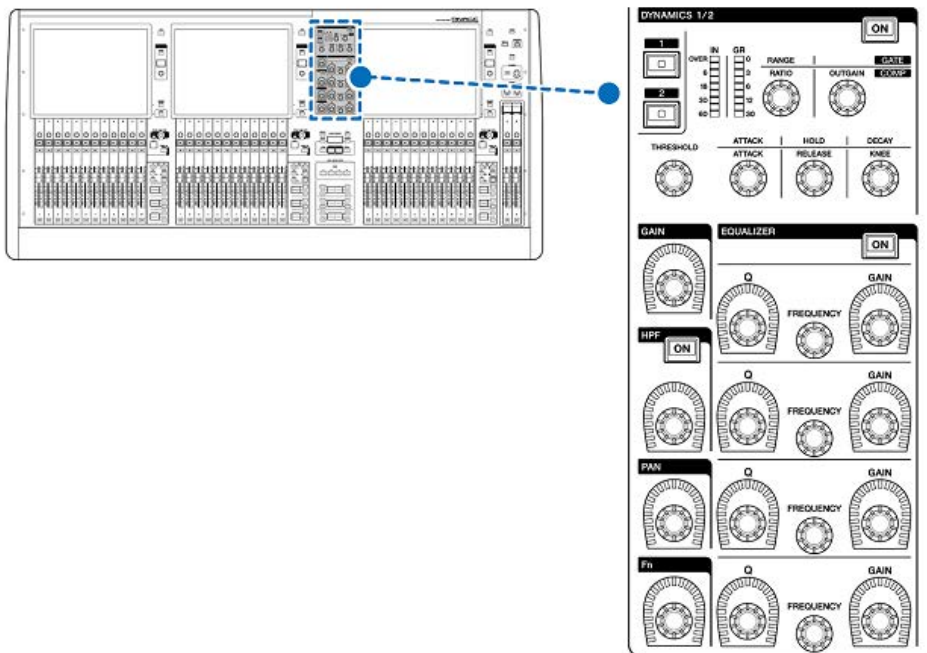

GAIN

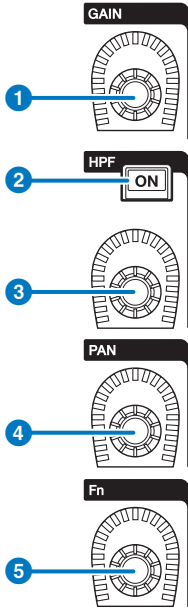

1 **[GAIN] knob**

Controls the analog gain or digital gain.

2 **HPF [ON] key**

Switches the HPF on or off.

3 **[HPF] knob**

Adjusts the HPF cutoff frequency.

4 **[PAN] knob**

Adjusts the panning of the signal sent to the stereo buses.

5 **[Fn] (Function) knob**

While pressing and holding down this knob, touch a parameter to assign the function.

DYNAMICS

This section enables you to select DYNAMICS1 or 2, and make detailed settings. You can also view the input level and the gain reduction of selected Dynamics.

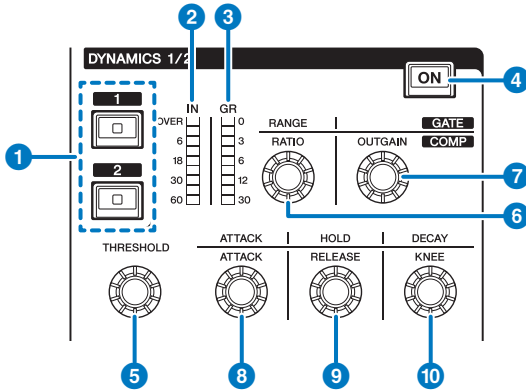

1 DYNAMICS [1]/[2] keys

These enable selection of Dynamics 1 or 2.

2 DYNAMICS 1/2 IN LEDs

Indicates the input level of selected Dynamics.

3 DYNAMICS 1/2 GR LEDs

Indicates the gain reduction amount of selected Dynamics.

4 DYNAMICS 1/2 [ON] key

Switches the selected Dynamics on or off.

5-10 DYNAMICS 1/2 setting knobs

These knobs enable you to make detailed settings for the selected Dynamics 1 or 2. The available knob functions vary depending on the type of selected Dynamics. For more information regarding the type of Dynamics, please refer to the About dynamics section.

Dynamics processor type	5	6	7	8	9	10
GATE/DUCKING	THRESHOLD	RANGE	-	ATTACK	HOLD	DECAY
COMP/EXPANDER	THRESHOLD	RATIO	OUTGAIN	ATTACK	RELEASE	KNEE
DE-ESSER	THRESHOLD	FREQ	Q	-	-	TYPE
FET LIMITER	INPUT	RATIO	OUTPUT	ATTACK	RELEASE	-
DIODE BRIDGE COMP	THRESHOLD	RATIO	GAIN	-	RECOVERY	-

EQUALIZER

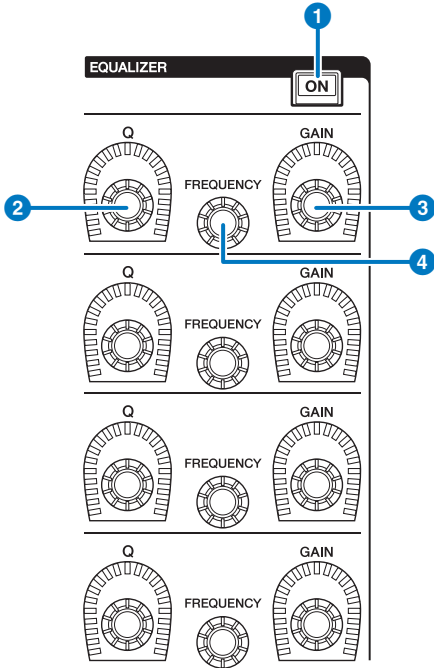

- 1 EQUALIZER [ON] key**
Switches EQ on or off.
- 2 EQUALIZER [Q] knob**
Specify the Q value.
- 3 EQUALIZER [GAIN] knobs**
Adjust the gain.
- 4 EQUALIZER [FREQUENCY] knobs**
Adjust the frequency.

UTILITY section

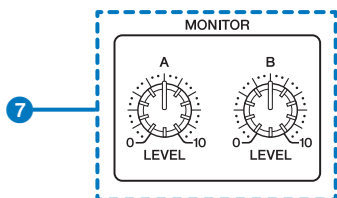
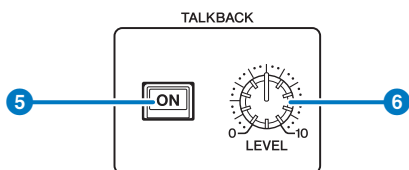
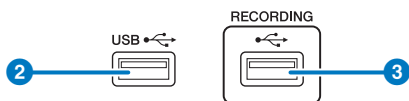
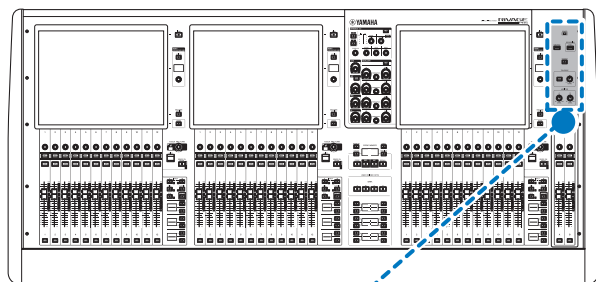

1 POWER Indicator

Lights when AC power to the unit is ON. If both power switches A and B are turned on, this indicator will light green. If either power switch A or B is turned on, it will light red. If the control surface is in the process of starting up, or if one or both power switches remain turned on after the control surface is shut down, the indicator will light orange.

2 USB port

Enables you to connect a USB device (such as a mouse, keyboard, or USB flash drive). Use a USB flash drive to store the system's internal data and to load the stored data into the system.

USB flash drive format

The FAT16 and FAT32 formats are supported.

Write Protection

Some USB flash drives feature write protection that prevents data from being erased inadvertently. If your USB flash drive contains important data, we suggest that you use write protection to prevent accidental erasure. On the other hand, you will need to make sure that your USB flash drive's write-protect setting is turned off before you save data onto the USB flash drive. For the latest information on USB flash drives that can be used with the system, visit the Yamaha Pro Audio website at:

<http://www.yamahaproaudio.com/>

NOTICE

- Do not remove the USB flash drive from the USB connector or turn off the power to the unit while the unit is accessing data, e.g., saving, loading or deleting data. Doing so may damage your flash drive, or may damage the data in the unit or on your media device.

3 RECORDING port

Enables you to connect a USB flash drive to record and play back audio files. Supported file formats include WAV and MP3. For the latest information on USB flash drives that can be used with the system, visit the Yamaha Pro Audio website at:

<http://www.yamahaproaudio.com/>

4 [SYSTEM] key

Press this key to display information about the RIVAGE PM series system on the touch screens. Press and hold down the key for two seconds or longer to shut down the console. Be sure to shut down before turning off the power switches.

5 TALKBACK [ON] key

Switches the Talkback function on or off.

Talkback remains on while you press and hold down this key. It turns off when you release the key.

6 TALKBACK [LEVEL] knob

Adjusts the Talkback input level.

7 MONITOR A/B [LEVEL] knobs

Adjust the output level of the monitoring signals.

SCENE MEMORY section

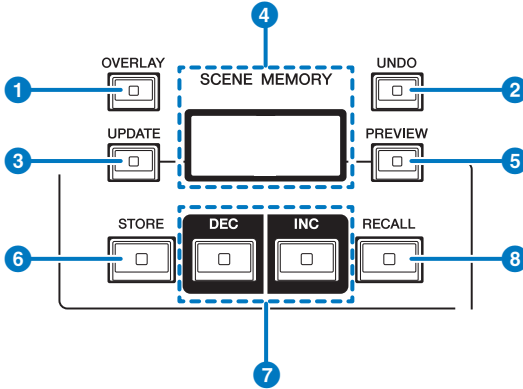
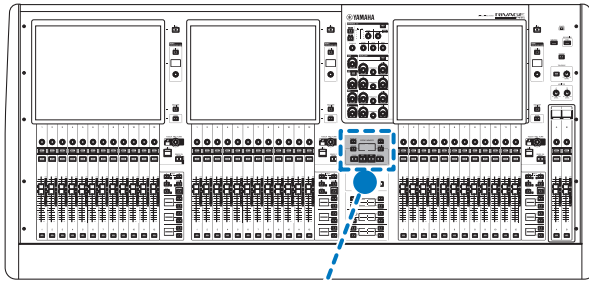

1 [OVERLAY] key

Press this button to display the OVERLAY SETTING screen. While pressing and holding down the [SHIFT] key (see 5 on page 16), press the [OVERLAY] key to switch Overlay on or off. While Overlay is turned on, press and hold down the [OVERLAY] key to enter Overlay edit mode.

2 [UNDO] key

Cancel the most recent operation of storing, recalling or updating. After you cancel the operation by pressing the [UNDO] key, you can “redo” the canceled operation by pressing the [UNDO] key again.

NOTE

Using the [UNDO] key will not undo an operation to store a new scene.

3 [UPDATE] key

Updates scene data by overwriting the current scene (that has been recalled most recently) with the current mix data.

4 SCENE MEMORY display(CS-R5)

Indicates the selected scene memory.

5 [PREVIEW] key

Turns Preview mode on or off.

6 [STORE] key

Stores the current scene settings to the selected scene memory. If you select the existing scene as the store destination, it will be overwritten.

NOTE

Use the [UPDATE] key to overwrite the current scene.

7 [INC]/[DEC] keys

Enable you to select the scene number of a scene that you want to store or recall.

NOTE

If you select a scene other than the current scene, the scene number on the LCD display will flash. Press the [INC] and [DEC] keys simultaneously to return to the current scene.

8 [RECALL] key

Enables you to recall a selected scene from scene memory.

USER DEFINED KEYS section

■ CS-R5

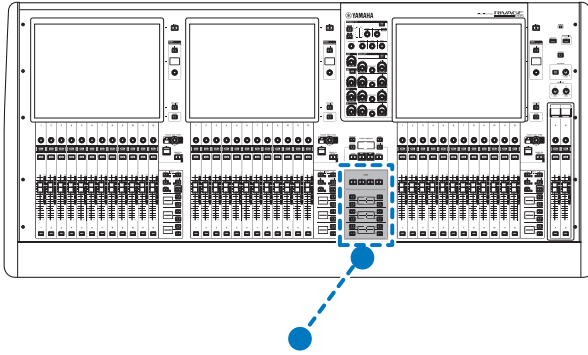

USER DEFINED KEYS

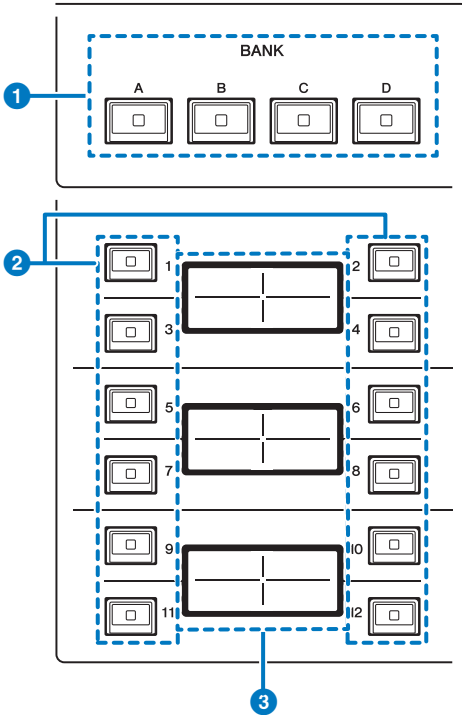

1 USER DEFINED KEYS BANK [A]/[B]/[C]/[D] keys

Enable you to select the bank ([A], [B], [C], or [D]) for the USER DEFINED keys.

2 USER DEFINED KEYS [1]-[12] keys

Control the functions as assigned by the user.

3 USER DEFINED KEYS displays

Indicate the functions assigned to the USER DEFINED keys.

CS-R3

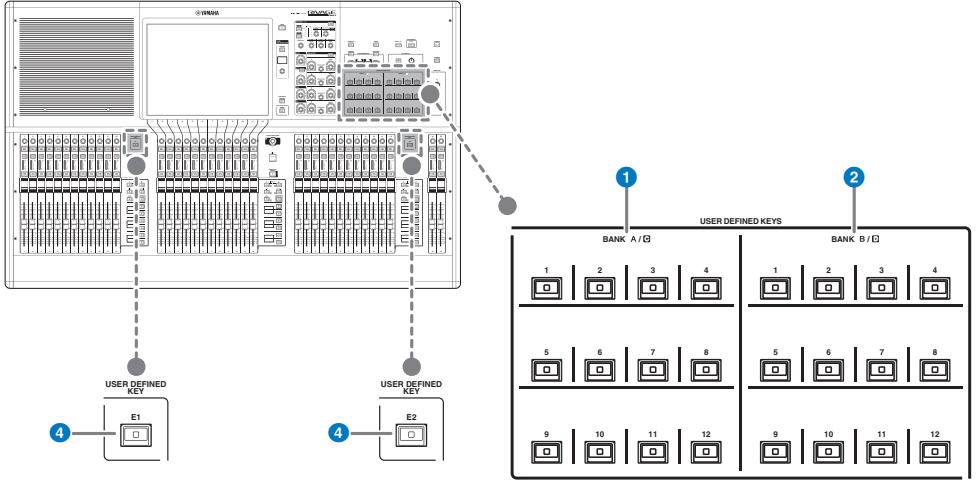

1 USER DEFINED keys BANK A/C [1]-[12]

2 USER DEFINED keys BANK B/D [1]-[12]

3 USER DEFINED keys [E1]/[E2]

Control the functions as assigned by the user.

Touch Screen section

Bay

A “bay” consists of a group of 12 faders located across the Touch Screen section and the Channel Strip section. The control surface contains three bays. You can control these bays independently

■ CS-R5

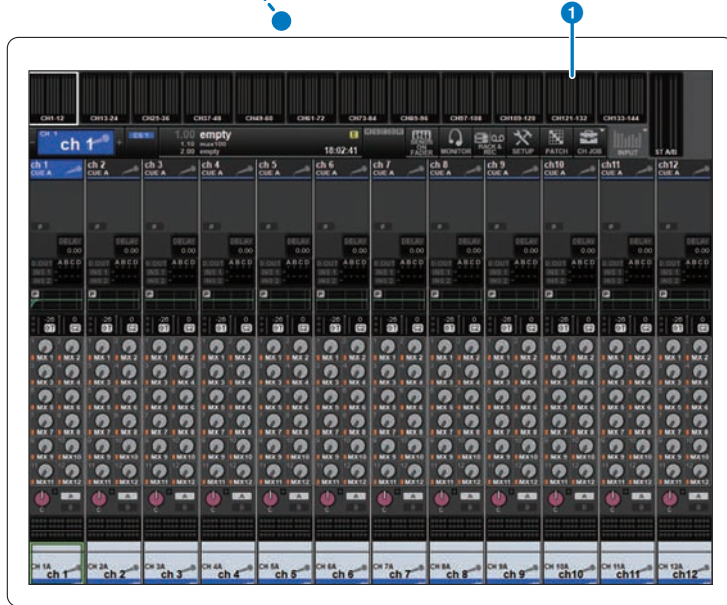
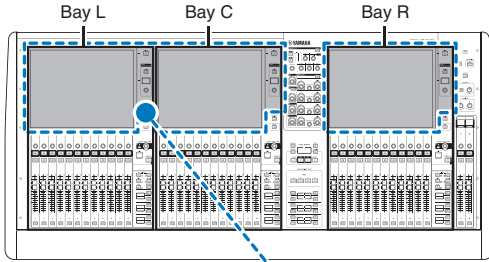

■ CS-R3

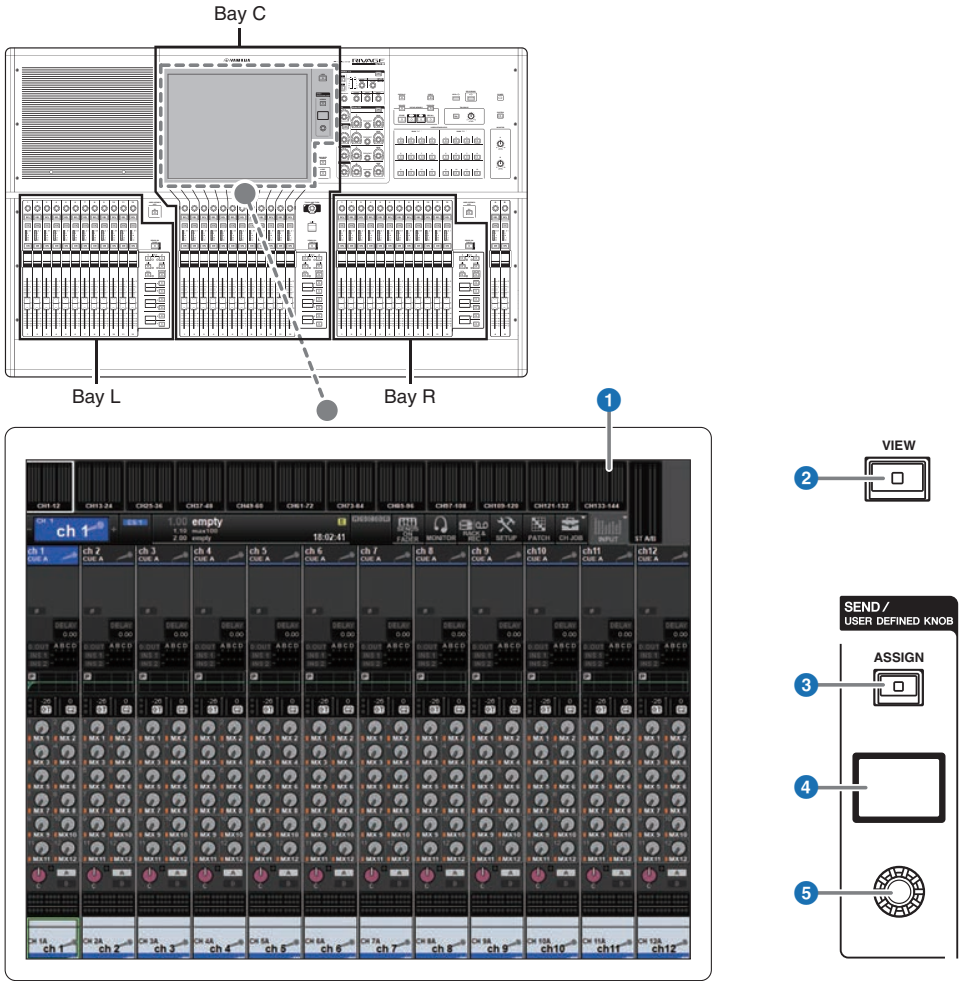

1 Touch screen

This is a multi-touch screen that you can operate by touching it with your finger to select menus or set parameters. The touch screen will not respond correctly if you are wearing gloves.

NOTICE

- Never use a sharp or pointed object such as your fingernail to operate the touch screens. Doing so may scratch the screens and render the touch screens inoperable.

NOTE

If the touch screens become dirty, wipe them with a soft dry cloth. Before use, be sure to remove the transparent film applied to the touch screens to protect them during transport.

2 **[VIEW] key**

Recalls and toggles between the OVERVIEW and SELECTED CHANNEL VIEW screens.

SEND / USER DEFINED KNOB

This section enables you to specify the send bus destination, and adjust the send level for the corresponding bus. You can also switch to the USER DEFINED KNOB function to control the assigned function.

3 **[ASSIGN] key**

Displays a screen that enables you to specify the send destination bus and switch to the USER DEFINED KNOB. The factory default bus is set to SEND TO MIX 1.

4 **Display**

While the SEND function is enabled, the display indicates the selected bus and its send level. While the USER DEFINED KNOB function is enabled, the display indicates the assigned function parameter and its value.

5 **SEND / USER DEFINED knob**

Adjusts the send level for the corresponding bus while the SEND function is enabled. Enables you to control the assigned function while the USER DEFINED KNOB function is enabled.

Channel Strip section

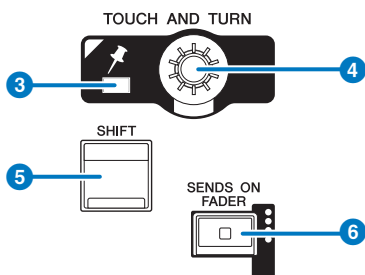
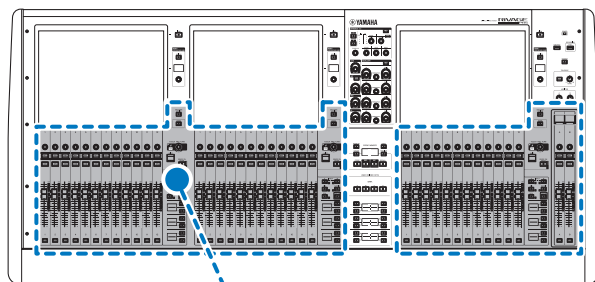

1 [ENCODER ASSIGN] key

Displays a screen that enables you to switch between the Screen Encoder function and the Channel Encoder function. You can use only the Channel Encoder function for channel strips A and B.

2 [HOME] key

Recalls a group of settings for the bay. Press and hold down this key to store the following settings:

- Layers and current screen data
- Selected channel/parameters on screen

3 PIN indicator

Lights when the Pinning function for the [TOUCH AND TURN] knob is ON. (This feature will be supported by a future update.)

4 [TOUCH AND TURN] knob

Controls the parameter of the knob you selected by touching the touch screen.

5 [SHIFT] key

Combine with another key to perform a certain function. For more information, refer to the Special Key Command List for the RIVAGE PM Series.

6 [SENDS ON FADER] key

Turns SENDS ON FADER mode on and off. While SENDS ON FADER mode is enabled, the input faders will control the send levels of the corresponding buses.

■ **CS-R5**

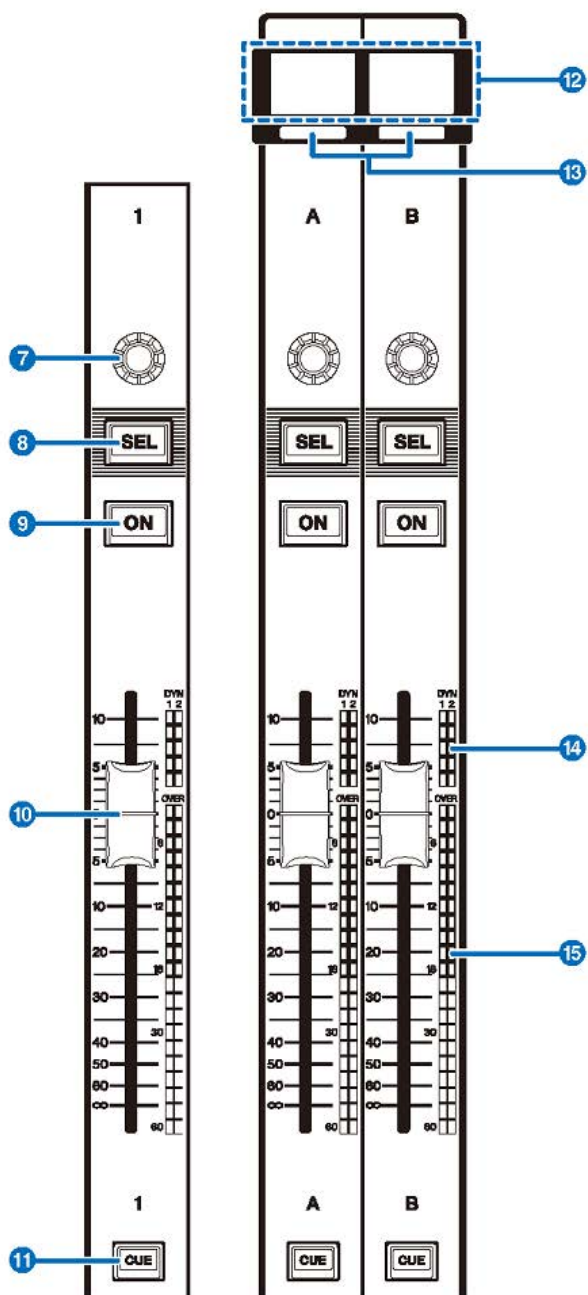

■ CS-R3

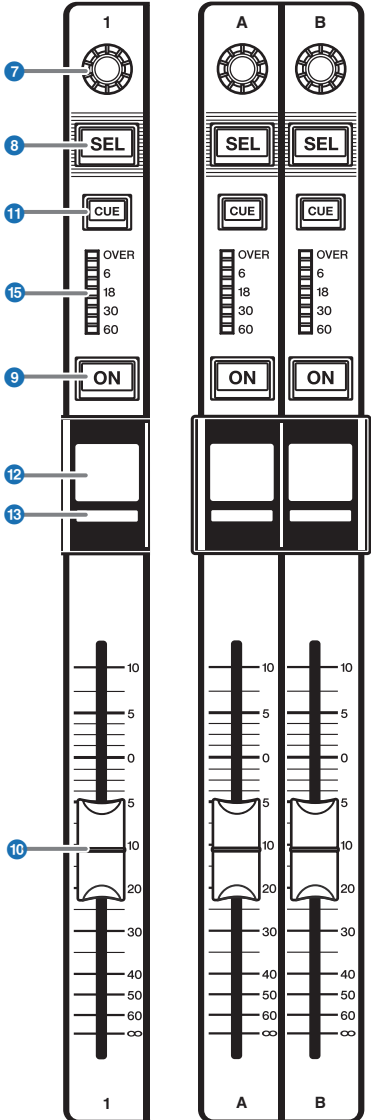

7 **Strip encoder**

You can use the Screen Encoder function and the Channel Encoder function for channel strips 1–12. Use the 1 p.93 to toggle between these two functions. You can use only the Channel Encoder function for channel strips A and B.

- **Screen Encoder function:**

Up to 12 parameters can be assigned by selecting controls on the screen.

- **Channel Encoder function:**

Adjusts the gain, pan, and the other parameters of the channel. The parameters for the selected function will be assigned to the knob. Use the 1 p.93 to switch the parameters. See 2 Channel Strip Encoder for more information regarding the available parameters.

8 **[SEL] key**

Enables you to select the channel that will be controlled in the Channel Strip section or on the display. When the channel is selected, the key LED will light.

9 **[ON] key**

Switches the channel on or off. If the channel is on, the key LED will light. If the channel is in a mute group, the key indicator will flash. In SENDS ON FADER mode (see 6 p.93), this key works as an on/off switch for signals sent from each channel to the currently-selected MIX/MATRIX bus.

10 **Fader**

This is a touch-sensitive 100 mm motorized fader. In SENDS ON FADER mode, this fader adjusts the send level of the signal sent from each channel to the currently-selected MIX/MATRIX bus.

11 **[CUE] key**

Selects the channel for cue.

12 **Channel name display**

Indicates the channel name, fader value, etc.

13 **Channel color indicator**

Indicates the channel color.

14 **LED gain reduction (CS-R5 only)**

Indicates the gain reduction.

15 **LED meter**

Indicates the channel level.

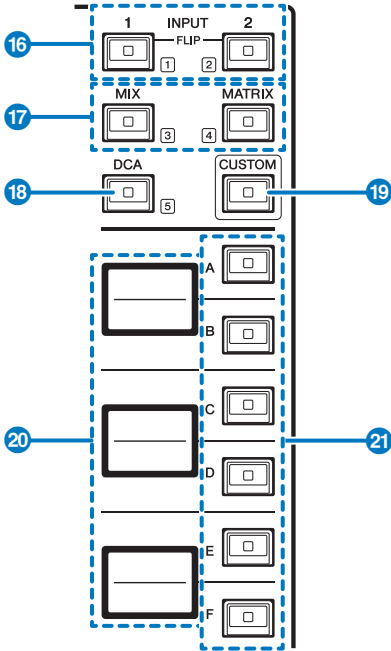

16 INPUT [1]/[2] keys

Enable you to select an input layer. Press the INPUT [1] key to select the INPUT 1-72 layer. Press the INPUT [2] key to select the INPUT 73-144 layer.

NOTE

Press the INPUT [1] key and INPUT [2] key simultaneously to select the INPUT 145-288 layer. Press these two keys simultaneously again to select the INPUT 1-144 layer. When the INPUT 145-288 layer is selected, these key indicators light up in a different color than when the INPUT 1-144 layer is selected.

17 [MIX]/[MATRIX] keys

Enable you to select an output layer.

18 [DCA] key

Enables you to select a DCA bank.

19 [CUSTOM] key

Turns Custom fader mode on or off. Use the INPUT [1]/[2] keys, the [MIX]/[MATRIX] keys, and the [DCA] key to select a Custom bank. The bank numbers (1-5) are labeled adjacent to these keys. Press and hold down to lock the Custom fader mode. To unlock the mode, press and hold down again.

20 Layer displays

Indicates the name of the layer selected via the 21 Layer select keys.

21 Layer Select [A]/[B]/[C]/[D]/[E]/[F] keys

Enable you to select a layer. Different layers are recalled to the faders depending on the combination of the keys, as shown in the table below: (*Please refer to the Note regarding the  INPUT [1]/[2] keys.)

Key	INPUT [1] / INPUT [1]+[2]*	INPUT [1] / INPUT [1]+[2]*	[MIX]	[MATRIX]	[DCA]
[A]	Input1-12 / 145-156*	Input73-84 / 217-228	MIX 1-12	MATRIX 1-12	DCA 1-12
[B]	Input13-24 / 157-168*	Input85-96 / 229-240*	MIX 13-24	MATRIX 13-24	DCA 13-24
[C]	Input25-36 / 169-180*	Input97-108 / 241-252*	MIX 25-36	MATRIX 25-36	—
[D]	Input37-48 / 181-192*	Input109-120 / 253-264*	MIX 37-48	STEREO	—
[E]	Input49-60 / 193-204*	Input121-132 / 265-276*	MIX 49-60	CUE/MONITOR	—
[F]	Input61-72 / 205-216*	Input133-144 / 277-288*	MIX 61-72	—	—

Front panel

■ CS-R5

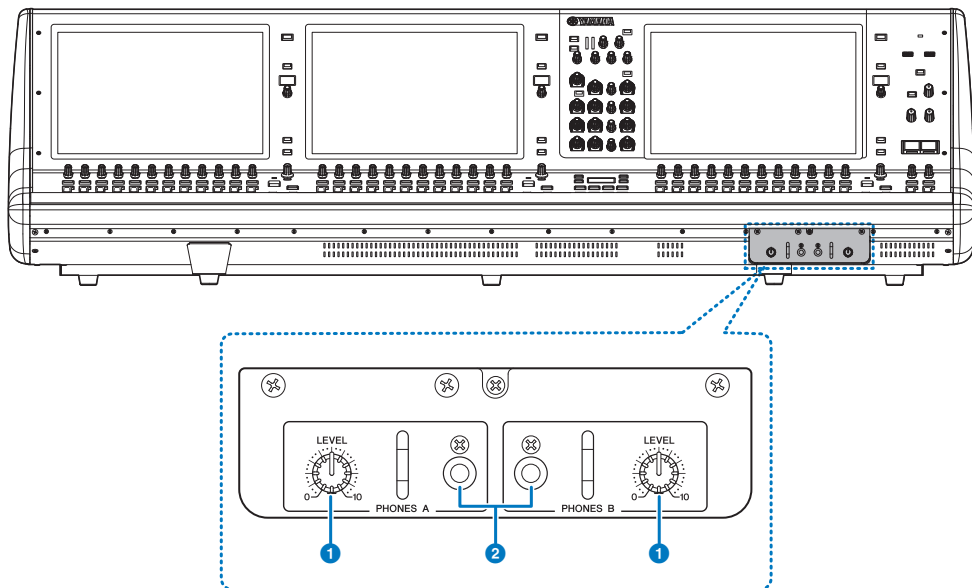

1 PHONES A/B [LEVEL] knobs

Adjust the level of the signal output from the PHONES OUT jacks respectively.

2 PHONES A/B output jacks

These are headphone jacks for monitoring the MONITOR or CUE signal.

■ **CS-R3**

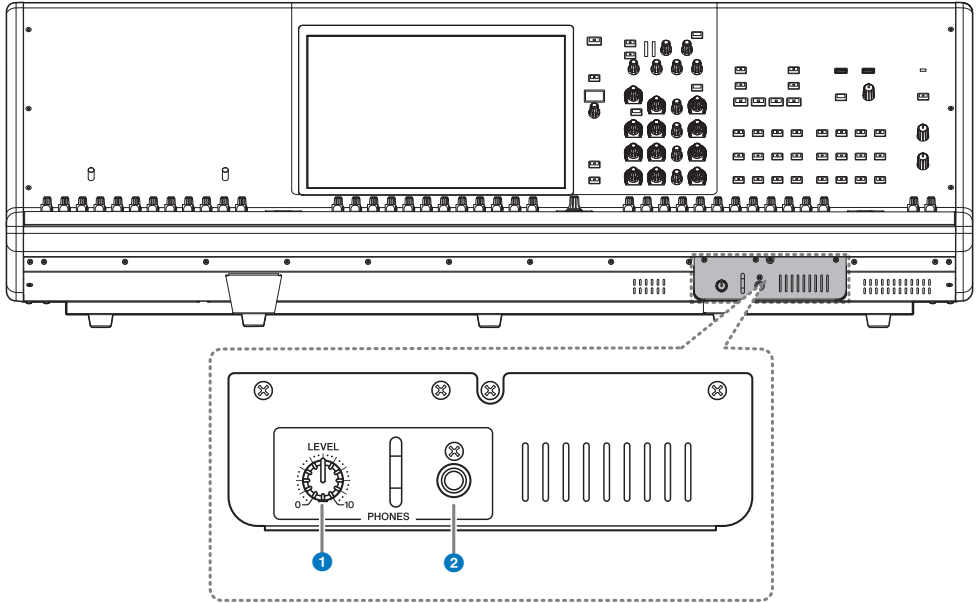

- 1 PHONES [LEVEL] knob**
Adjust the level of the signal output from the PHONES OUT jacks respectively.
- 2 PHONES output jack**
This is the headphone jack for monitoring the MONITOR or CUE signal.

Rear panel

■ CS-R5

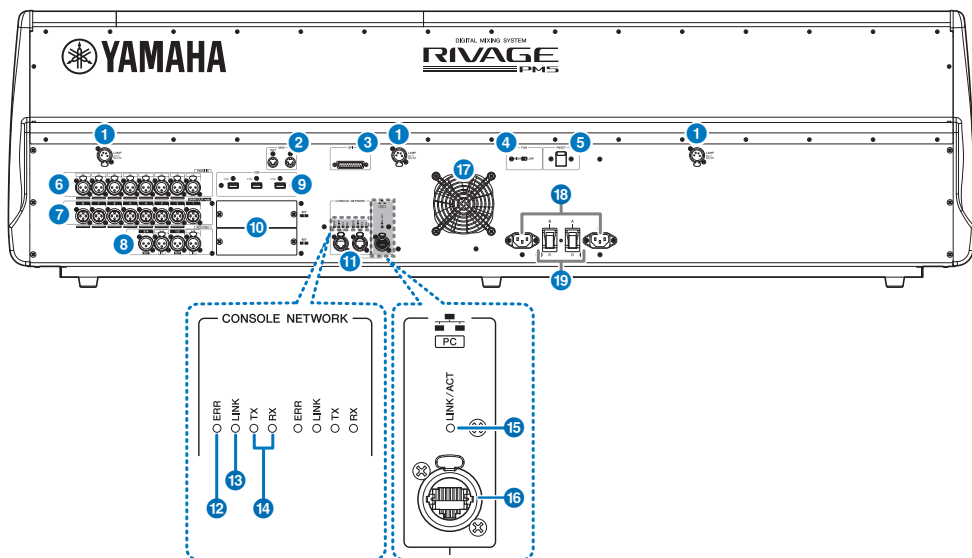

■ CS-R3

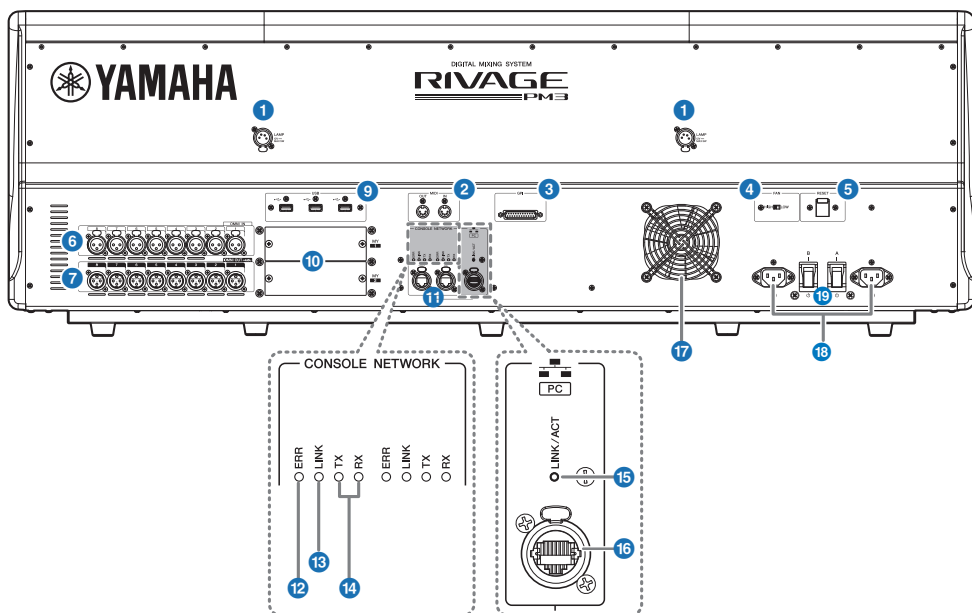

1 LAMP jacks

These four 4-pin female XLR output jacks are used to supply power to optional Yamaha LA1L gooseneck lamps.

2 MIDI OUT/IN jacks

These connectors are used to transmit and receive MIDI messages to/from external MIDI devices.

3 GPI connector

This is a D-sub 25-pin female connector that allows communication (8-in, 8-out) with a GPI-equipped external device.

4 [FAN] switch

Sets the internal cooling fan to operate at either HIGH or LOW speed.

NOTE

This switch is set to LOW when the unit is initially shipped from the factory. As long as the unit is operated within the specified ambient temperature range either the LOW or HIGH setting can be used. The HIGH setting is recommended if the ambient temperature is high, if the unit is in direct sunlight even if the ambient temperature is within the specified operating range, and in any situation in which fan noise is not a problem.

5 [RESET] switch

Resets the control surface. Only the controls (screens, indicators, and control keys and knobs) on the control surface will restart without interrupting audio. Use this switch in case the control surface becomes non-responsive to your operations.

6 OMNI IN jacks

These are balanced XLR-3-31 female input jacks for inputting analog audio signals from line level devices or microphones.

Male XLR plug

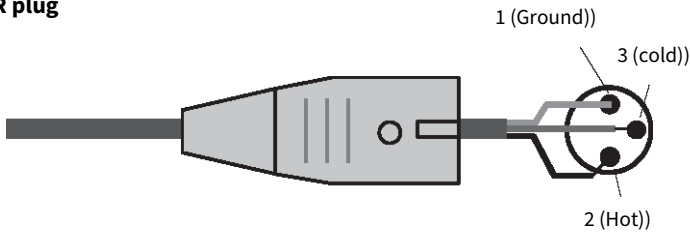

7 OMNI OUT jacks

These are balanced XLR-3-32 male output jacks that transmit analog audio signals.

Female XLR plug

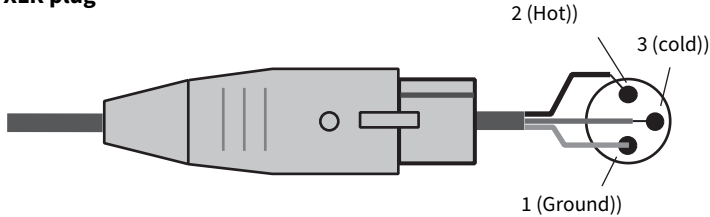

8 AES/EBU jacks (CS-R5)

Both input and output jacks feature built-in sampling rate converters.

IN

These are balanced XLR-3-31 female input jacks that accept digital audio signals in AES/EBU format.

OUT

These are balanced XLR-3-32 male output jacks for outputting digital audio signals in the AES/EBU format.

9 USB port

Use these ports to connect a USB storage device such as a flash drive, USB mouse, or USB keyboard.

10 MY card slots

Install optional Mini-YGDAI I/O cards here to expand I/O ports.

11 CONSOLE NETWORK OUT/IN connectors

These RJ-45 connectors allow the unit to be connected to a Console Network(*) in a ring topology via Ethernet cables (CAT5e or higher recommended).

• Console Network

A DSP engine is equipped with a special control surface terminal to connect to a control surface. A network created by the control surface and a DSP engine is called a "Console Network."

NOTE

Use an STP (Shielded Twisted Pair) cable to prevent electromagnetic interference. Make sure that the metal parts of the plugs are electrically connected to the STP cable's shield by conductive tape or comparable means. The use of Ethernet cables with Neutrik etherCON CAT5 compatible RJ-45 plugs is recommended. Standard RJ-45 plugs can also be used. Cable length can span up to 100 meters between devices. Maximum practical distance may vary depending on the cable used.

12 ERR indicators

This indicator lights up or flashes red if an error occurs. In such an event, please contact your Yamaha dealer.

13 LINK indicator

This indicator flashes or lights up, depending on the network status.

Green (flashing)	<p>The unit is preparing to connect to the console network. If it continues flashing, the system is not functioning properly. If the problem persists after you take the following actions, please contact your Yamaha dealer.</p> <ul style="list-style-type: none"> • Make sure that the cables are connected properly. • Make sure that the cables are securely inserted (locked in). • Turn the power to the RIVAGE PM series system off and then on. • Change to a different cable.
Green (lit steadily)	<p>The unit is connected to the console network properly.</p>

14 TX/RX indicators

The appropriate indicator flashes green when data is transmitted from (TX) or received at (RX) the TO ENGINE OUT/IN connectors.

15 LINK/ACT indicator

This indicator flashes or lights up green, depending on the connection status.

16 NETWORK  connector

This RJ-45 connector allows the unit to be connected to a computer or network device via an Ethernet cable (CAT5e or higher recommended).

NOTE

Use an STP (Shielded Twisted Pair) cable to prevent electromagnetic interference. Make sure that the metal parts of the plugs are electrically connected to the STP cable's shield by conductive tape or comparable means. The use of Ethernet cables with Neutrik etherCON CAT5 compatible RJ-45 plugs is recommended. Standard RJ-45 plugs can also be used. Cable length can span up to 100 meters between devices. Maximum practical distance may vary depending on the cable used.

17 Vent

The control surface is equipped with cooling fans. These vents let warm air out from the unit. Please make sure that you do not block the vents with any object. The air intake is located on the bottom of the front panel.



CAUTION

- Do not block the vents. This product has ventilation holes at the rear and under the front to prevent the internal temperature from becoming too high. Inadequate ventilation can result in overheating, possibly causing damage to the product(s), or even fire.

18 AC IN connectors

Use these sockets to connect the supplied power cords. First connect the AC power cords to this unit, and then insert the power cord plugs into AC outlets. Insert the cable plugs all the way until they lock in place securely. The supplied AC power cords feature a V-lock mechanism via a latch, which prevents the power cords from disconnecting accidentally.



CAUTION

- Be sure to turn off the power to the unit before connecting or disconnecting the power cords.

To disconnect each power cord, remove it while pressing the latch on the plug.

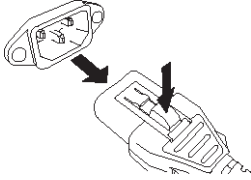

19 [I]/[⏻](Power switches A/B)

Toggle between power on (I) and off (⏻). While the power is turned on, the 1 POWER indicator on the top panel will light up.

Basic operations on the panel

Basic touch screen operations

This section explains the basic procedures you can perform on the unit's touch screens. In general, you will operate the system using an appropriate combination of the operations explained here.

Pressing the touch screens

You will use this operation primarily to switch screens and pages, to select the parameter to be operated, and to turn a button on/off. Certain buttons let you specify a number based on the area of the button itself that you touch.

Multiple selection (specifying a range)

While pressing your finger on the touch panel, move it in the left or right direction to specify a range within a character string. You will use this technique primarily when assigning a name to a scene or library.



For the channel select buttons, you can select multiple buttons by moving your finger across the touch screen while continuing to press down.

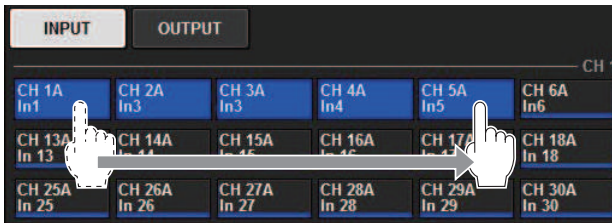

Knob operations

Typically, knobs are rotated left or right to change the value of the corresponding parameter.

NOTE

Pressing certain knobs a second time while a thick frame is displayed around them will open a window in which you can make additional detailed settings.

Basic operations on the top panel

This section explains the basic procedures you can perform on the top panel.

Screen encoder operations

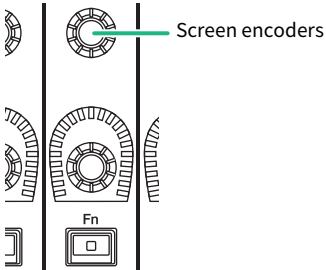

Screen encoders 1–12 are used to operate the knobs selected for operation in the touch screens. When you press to select a knob that can be controlled by the screen encoders, a thick frame appears around it. (Normally, a knob of this type corresponds to the screen encoder located immediately below that knob, allowing you to control up to twelve parameters simultaneously.)

[TOUCH AND TURN] knob operations

TOUCH AND TURN



The [TOUCH AND TURN] knob enables you to control the parameter of the knob you are touching on the touch screen. At this time, a pink or yellow frame appears around certain knobs on the touch screen, indicating that you can operate those knobs.

[HOME] key operations



This key enables you to store the status of each bay and recall the settings all together later. Hold this down to save (store) the following settings and press to recall.

- Current screen data
- Selected channel/parameter on the screen
- Selection of the fader layer

[SYSTEM] key operations

Press this key to display information about the RIVAGE PM series on the center touch screens. The SYSTEM CONFIG popup window will open.

Basic operations on the panel > Basic operations on the top panel

Hold this down for two seconds or longer to enter shutdown (power off procedure).

Shut down (power-off procedure)

Before you shut down the control surface, Yamaha recommends that you store the current status to scene memory. If you change the connection status of the components after the power is turned off, some settings, such as patching, may be altered when you turn the power on again. For instructions on storing scenes, see ““Storing scenes (Using the keys in the SCENE MEMORY section)” (p.775)” .

NOTICE

- If you turn off the power to the control surface without following the shutdown procedure, data inside the built-in storage (including the current memory) may be damaged. Be sure to perform the shutdown procedure to turn off the power to the control surface.

- 1 Press the [SYSTEM] key for two seconds or longer. A message will ask you to confirm the shutdown operation.**
- 2 To shut down the control surface, press the OK button. To cancel shutdown, press the CANCEL button.**
- 3 Wait until the LEDs on the panel turn off, the touch screens go dark, and the POWER indicator lights orange.**
- 4 Turn off both power switches A and B on the rear panel.**



CAUTION

- If you plan to turn on the power to the control surface again, wait at least five seconds before switching the power on. Otherwise, the unit may malfunction. Even when the power switches are turned off, a small amount of current still flows through the unit. If you plan not to use the unit for a long period of time, remove the power cords from the AC outlets.

NOTE

You can shut down the control surface by assigning the Console Shutdown function to a USER DEFINED key or GPI IN.

Other convenient functions

The RIVAGE PM series provides various other convenient functions.

CONSOLE LOCK

You can temporarily prohibit control surface operation in order to prevent unwanted operation. This setting completely disables operations of the panel and touch screen, so that controls cannot be operated by an accidental touch or by an unauthorized third party while the operator is taking a break. You can also specify a password when locking the console.

On-screen user interface

This section explains various user interface components shown in the touch screens, and how to use them.

Tabs

Tabs enable you to switch between multiple pages. Each tab indicates its page name.

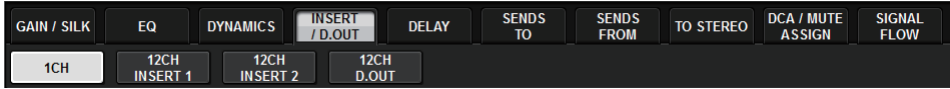



Buttons

Buttons are used to execute specific functions, to switch parameters on or off, or to select one of multiple choices. Buttons that perform on/off operations appear in solid colors while they are turned on, and dark when turned off.

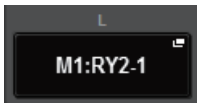

When you press a  button, a separate popup window will open, allowing you to make detailed settings.



When you press a  button, a pull-down menu will appear.

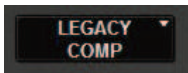

Faders/knobs

Faders in the screen are used mainly for visual confirmation of the levels of the corresponding channels, and will move in tandem when you operate the top panel faders. The current value is shown in numerical form immediately below the fader.

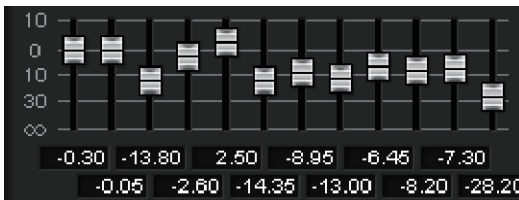

Basic operations on the panel > On-screen user interface

Knobs in the screen provide visual confirmation of the value of the corresponding parameter. If you press a knob once in the window, a thick frame appears around the knob. This frame indicates that the knob is selected for operations that can be controlled by the [TOUCH AND TURN] knob (pink highlight), [Fn] knob (yellow highlight), or screen encoders (white highlight).



Touch sensitive (only for CS-R5)

Touching a knob on the panel will highlight the corresponding knob in the SELECTED CHANNEL VIEW screen. In this way, visual movement will be minimized and you will be able to focus on your work. In other screens, a popup window will open, enabling you to see the value before operating the controls.

List windows

Windows similar to the following enable you to select items from a list, such as the USER DEFINED knob setting window.

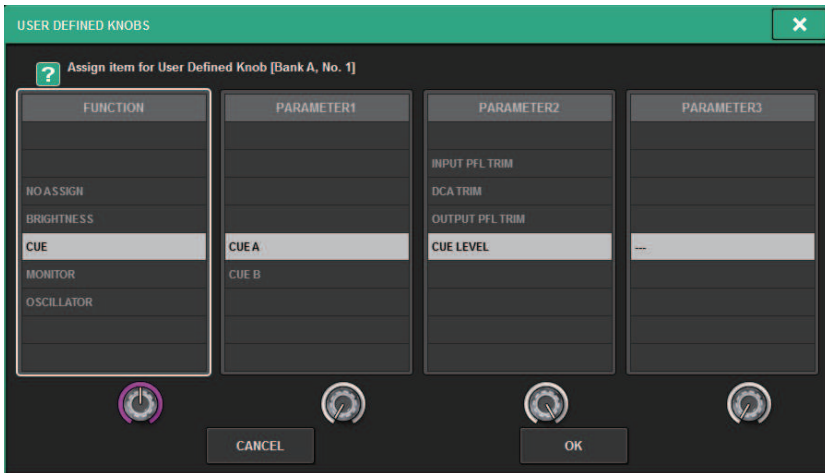

The highlighted item in the middle of the list is the item that is selected for operation. Press the screen encoders located below the list to scroll the list upward or downward.

NOTE

You can also scroll the list up or down by using the [TOUCH AND TURN] knob.

Keyboard window

The following keyboard window will appear when you need to assign a name or comment to a scene or library, or when you need to assign a channel name. Press character buttons in the window to enter the desired characters.



Popup windows

When you press a button or field for a specific parameter in a screen, a window showing details or a list for that parameter will appear. These windows are called “popup windows.”



You can switch between popup windows using tabs as needed. Some popup windows show several buttons called “tool buttons” at the top of the window. You can use these tool buttons to recall libraries or to perform copy and paste operations. Press the “x” symbol located in the upper right corner to close the popup window and return to the previous screen.

Dialog boxes

Basic operations on the panel > On-screen user interface

Dialog boxes similar to the following enable you to confirm operations you just performed. Press the OK button to execute the operation. The operation will be canceled if you press the CANCEL button.

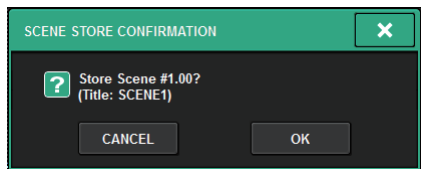

Viewing a touch screen

The touch screens display the following information:



Meter area

The meter area displays various meters. Press any part of the meter area to recall the corresponding fader layer to the panel.

Main area

The contents of the main area will vary depending on the currently-selected function. Mixing operations will involve mainly the following two types of screens. To access these screens, press the [VIEW] key.

SELECTED CHANNEL VIEW screen

Basic operations on the panel > Viewing a touch screen



This screen shows all mix parameters of the currently-selected channel. For details about this screen, refer to the “About the SELECTED CHANNEL VIEW screen” section.

OVERVIEW screen



This screen shows the main parameters of 12 channels selected as a layer. For details about this screen, refer to the “About the OVERVIEW screen” section.

Menu bar

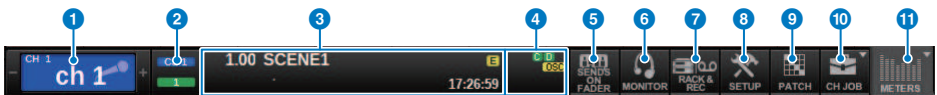

1 Selected channel

This area shows the number, name, icon, and channel color of the channel that is currently selected for operation. For details on assigning a name, refer to “Entering names.” For details on selecting an icon, refer to ““Changing the name” (p.380).” Press the left side of the selected channel area to select the preceding channel. Press the right side of the area to select the next channel.

2 Connection

This indicates the ID of the control surface and the unit ID of the DSP engine that is connected. Here you can also check whether the DSP engine is operating in active mode or in standby mode.

Not shown: DSP not found

Green: found as active

Gray: found as standby (switchable)

Gray slanting line: found as standby (not switchable)

Grayed out: DSP assumed to be in standby is not found.

When DSP mirroring is used, this also operates as a button to access the System Config screen.

3 INFORMATION

This area displays information such as the current time and a scene number. If you press this area, the SCENE LIST window will appear in the main area, allowing you to set scenes. In Preview mode, this flashes red.

4 Status indicator

This area indicates the current status. The following table shows the displayed content and the corresponding status.



Indicator	Conditions
M	Status of the TWINLANE network (MAIN) Green: Online (Normal) Yellow: Online (Not in the ring connection) Red: Wiring problem Blue: Out of sync Gray: Offline
S	Status of the TWINLANE network (Sub) Green: Online (Normal) Yellow: Online (Not in the ring connection) Red: Wiring problem Blue: Out of sync Gray: Offline
C	Status of the Console network Green: Online (Normal) Yellow: Online (Not in the ring connection) Red: Wiring problem Blue: Out of sync Gray: Offline

Indicator	Conditions
D	Status of the DSP engine Green: Normal Yellow: Only POWER A or B is enabled. Red: Error (inoperative fan, etc.)
R	Status of the I/O rack Green: Normal Yellow: Only POWER A or B is enabled. Red: Error (inoperative fan, etc.)
OSC (yellow)	Oscillator is enabled.
ALT (yellow)	Alternate function ON
TB (yellow)	Talkback is enabled.
REC (red)	Currently recording an audio file
PLAY (green)	Currently playing an audio file
OVL (yellow)	Overlay ON
VSC (yellow)	Virtual sound check ON
LINK (yellow)	Temporary link ON
CUE A, CUE B, CUE A+B, CUE S, CUE A+S, CUE B+S, CUE A+B+S (yellow)	Status of cue
Solo mode ON	SOLO (red)
ACCESS	Communicating with the USB flash drive

NOTICE

- The ACCESS indicator will appear while data is being accessed (i.e., saved, loaded, or deleted). Do not disconnect the USB flash drive or power-off the unit while this indicator is shown. Doing so may damage the flash drive, or may damage the data in the unit or on your media device.

5 SENDS ON FADER

Press this button to switch to SENDS ON FADER mode, in which you can use the faders of the top panel to adjust the MIX/MATRIX send level (see “Using the faders to adjust the sends (SENDS ON FADER mode)”). During this time, the main area will switch to a screen that enables you to select the send-destination MIX/MATRIX bus.

6 MONITOR

When you press this button, the MONITOR screen will appear in the main area, enabling you to edit the monitor or oscillator settings.

7 RACK & REC (Recorder)

When you press this button, the RACK & REC screen will appear, enabling you to configure plug-ins. You can also make settings for the recorder function (USB), which allows you to record and play back audio files.

8 SETUP

When you press this button, the SETUP screen will appear in the main area, enabling you to make basic and user-specific settings for the RIVAGE PM series.

9 PATCH

When you press this button, the PATCH screen will appear, enabling you to configure in/out, direct out, recording, and other patches.

10 CH JOB (Channel Job)

Press this button to access the CH JOB pull-down menu, in which you can copy or initialize the channel settings, etc.

11 METER

When you press this button, a popup menu will appear, enabling you to select the type of channel block to display in the meter area (Meter).

Basic operations on the panel > Viewing a touch screen

Channel name area

Press the channel name area to switch the selected channel/parameter on the screen. If you switch fader layers, the indication in this area will reflect the change in layer selection. In this way, you can access any channel on screen.



Channel name

NOTE

Switching layers will not affect the selected channel/parameter on the screen. The 12-channel group displayed on the OVERVIEW screen will change. However, unless you press the channel name area, the selected channel/parameter on the screen will remain unchanged since your last press of the [SEL] key(s). If you want to switch the selected channel/parameter on screen at the same time you switch layers, you can configure this arrangement by selecting [FADER BANK] > [SEL] LINK in the Preferences settings.

When you use a screen encoder to control an EQ or dynamics parameter in the SELECTED CHANNEL VIEW screen, the corresponding parameter and its value will appear in the upper part of the channel name area.

EQ

1 Q	1 FREQ	1 GAIN	2 Q	2 FREQ	2 GAIN	3 Q	3 FREQ	3 GAIN	4 Q	4 FREQ	4 GAIN
4.0	125	0.0	1.4	355	0.0	1.4	3.55k	0.0	4.4	6.30k	0.0

Dynamics

THRESH	RANGE	ATTACK	HOLD	DECAY	THRESH	RATIO	OUTGAIN	ATTACK	RELEASE	KNEE
-22.1	-68	0	0.75m	390m	0.0	8.0:1	20.0	3.148m	290.6	Soft2

MIX/MATRIX SENDS

MX 1	MX 2	MX 3	MX 4	MX 5	MX 6	MX 7	MX 8	MX 9	MX10	MX11	MX12
5.00	-1.00	-∞	-∞	-∞	-∞	-∞	-∞	-∞	-∞	-∞	-∞

The following functions will be displayed.

* If ALTERNATE FUNCTION is assigned to a USER DEFINED key, pressing the channel screen encoder repeatedly will turn the function on and off.

For the SENDS function, rotate the screen encoder to set PRE or POST.

You can also turn the function on or off by pressing the screen encoder while holding down the [SHIFT] key.

Entering names

You can assign a name to each input channel, output channel, and DCA, and assign a title to each scene or library data item when you save it. To assign a name, you will use the keyboard window that is shown in the main area.

1 Access the screen for assigning names.

The screen shot below shows how to assign a name to a channel.



The box shows the characters you have entered and a cursor that indicates the current position.

2 Use the keyboard window in the touch screen to enter the desired characters.

When you press a character button in the keyboard window, the corresponding character will be entered in the box, and the cursor will move to the right.

3 Enter the subsequent characters in the same way.

When entering characters, you can also use the following buttons in the keyboard window.

COPY button

Copies the string of characters that are selected (highlighted) in the text box.

CUT button

Deletes and copies the string of characters that are selected (highlighted) in the text box.

PASTE button

Inserts the string of characters copied by COPY or CUT at the cursor location (or overwrites the currently-selected range of characters).

CLEAR button

Erases all characters that have been input in the text input box.

DEL button

Deletes the character to the right of the cursor (or the string of characters selected in the text box).

BS button

Deletes the character to the left of the cursor (or the string of characters selected in the text box).

TAB button

Enables you to access the next selectable item. For example in the SCENE STORE window you can use this button to switch between four text entry boxes, and in the PATCH/NAME window you can use this to switch channels.

CAPS button

Switches between uppercase and lowercase alphabetical characters.

SHIFT button

You can enter uppercase characters and symbols while this button is on, and lowercase characters and numerals while this button is off.

ENTER button

Finalizes the name you entered.

4 When you finish entering the name, press the [ENTER] button.

The name you entered will be applied.

NOTE

- Basic procedures are the same in windows that let you assign names to channels or other types of library data. When you enter a name for a channel, your input will be reflected immediately without pressing the ENTER button.
- By pressing inside the text entry box, you can move the input position to the location you pressed. If you select a region of characters you've entered in the box and then enter a new character, the newly entered character will overwrite the selected region.

Using tool buttons

The title bar on top of certain popup windows features tool buttons that provide additional functions. These buttons enable you to recall related libraries, or copy channel parameters to another channel. This section explains how to use the tool buttons.

About the tool buttons

EQ, Dynamics, Delay, GEQ/PEQ, and Plug-in popup windows feature the following tool buttons:



1 LIBRARY button

Recalls a library related to the current popup window (such as EQ, Dynamics, GEQ/PEQ, or Plug-in library).

2 DEFAULT button

Resets the EQ or Dynamics of the currently-selected channel, or GEQ/PEQ or Plug-in to their default settings.

3 COPY button

Copies the EQ, Dynamics, or Delay parameter settings of the currently-selected channel, or the GEQ/PEQ or Plug-in settings. Copied settings will be stored in buffer memory (a temporary storage area).

4 PASTE button

Pastes the settings stored in buffer memory to the EQ, Dynamics, or Delay of the currently-selected channel, or GEQ/PEQ or Plug-ins.

5 COMPARE button

Switches between and compares the settings stored in buffer memory and the EQ or Dynamics of the currently-selected channel, or GEQ/PEQ or Plug-in settings.

Copying and pasting parameters

You can copy the EQ, Dynamics, or Delay parameter settings of the currently-selected channel, or GEQ/PEQ or Plug-in settings to buffer memory, and then paste them to corresponding parameters for other channels, or a similar type of GEQ/PEQ or Plug-in.

NOTE

- The EQ and Dynamics parameter settings will be copied and pasted per bank (A/B). You can copy and paste the parameters between Bank A and B of the same channel. For example, you can copy the parameter settings for Dynamics 1 on CH1 in Bank A to Dynamics 2 on CH144 in Bank B.
- If 15 bands or less are used for 31BandGEQ, those parameter settings can also be copied to Flex15GEQ.

1 Open a popup window that features tool buttons.

2 Select a channel EQ, Dynamics, or Delay, or GEQ/PEQ or Plug-in as the copy source.

3 Press the COPY button.

The current setting will be stored in buffer memory.

NOTE

- After copying a setting, be sure to paste it to the destination BEFORE you copy another setting. Otherwise, the copied setting (in buffer memory) will be overwritten.
- You can select only one channel, GEQ/PEQ, or plug-in as the copy source.

4 Press the PASTE button.

The channel EQ, Dynamics or Delay setting, or GEQ/PEQ or Plug-in setting (selected in Step 2) will be pasted.

NOTE

- Please note that pasting the copied settings will overwrite the settings that are currently residing in the paste destination.
- If no data is stored in buffer memory, or if the data in buffer memory is not compatible with the data in the paste destination, the PASTE button will be disabled.

Resetting parameters to default

This section explains how to reset the EQ or Dynamics settings of the currently-selected channel, or GEQ/PEQ or Plug-in settings, to their default values.

NOTE

Pressing the FLAT button for GEQ/PEQ will reset the GAIN parameter for all bands to 0 dB.

- 1 Open a popup window that features tool buttons.**
- 2 Select a channel EQ, Dynamics, or Delay, or GEQ/PEQ or Plug-in, for which you want to reset the parameters.**

NOTE

You can select multiple channels to reset those channels' EQ or Dynamics settings using the corresponding popup windows (CH1-72, CH73-144, CH145-216, CH217-288*1, MIX, or MTRX/ST).

- *1 When the DSP-RX-EX is connected

- 3 Press the DEFAULT button.**

A dialog will request that you confirm the initialization operation.

- 4 To execute the initialization, press the OK button.**

The Initialization operation starts. If you decide to cancel the initialization operation, press the CANCEL button instead of the OK button.

Comparing two settings

Using the COMPARE button enables you to switch between and compare the settings stored in buffer memory with the EQ or Dynamics settings of the currently-selected channel, or GEQ/PEQ or Plug-in. This function is useful if you want to compare and listen to the edited data using the settings temporarily stored during the editing process.

- 1 Open a popup window that features tool buttons.**
- 2 Select a channel EQ, Dynamics, or Delay, or GEQ/PEQ or Plug-in that you want to compare.**

- 3 Press the COPY button to store the current setting in buffer memory.**

This is the first of two settings to compare.

NOTE

Do not try to copy another setting before you compare settings. Otherwise, the setting (in buffer memory) that you originally meant to compare will be overwritten by the newly-copied setting.

- 4 Edit the EQ or Dynamics setting of the currently-selected channel, or the GEQ/PEQ or Plug-in setting, as you desire.**

This is the second of two settings to compare.

NOTE

Once the first option is stored in buffer memory, you can initialize the current setting to create a second option from scratch.

5 Press the COMPARE button to compare the first option and the current (second) option.

The first option will be applied to the system. At this time, the second option will be stored in buffer memory.

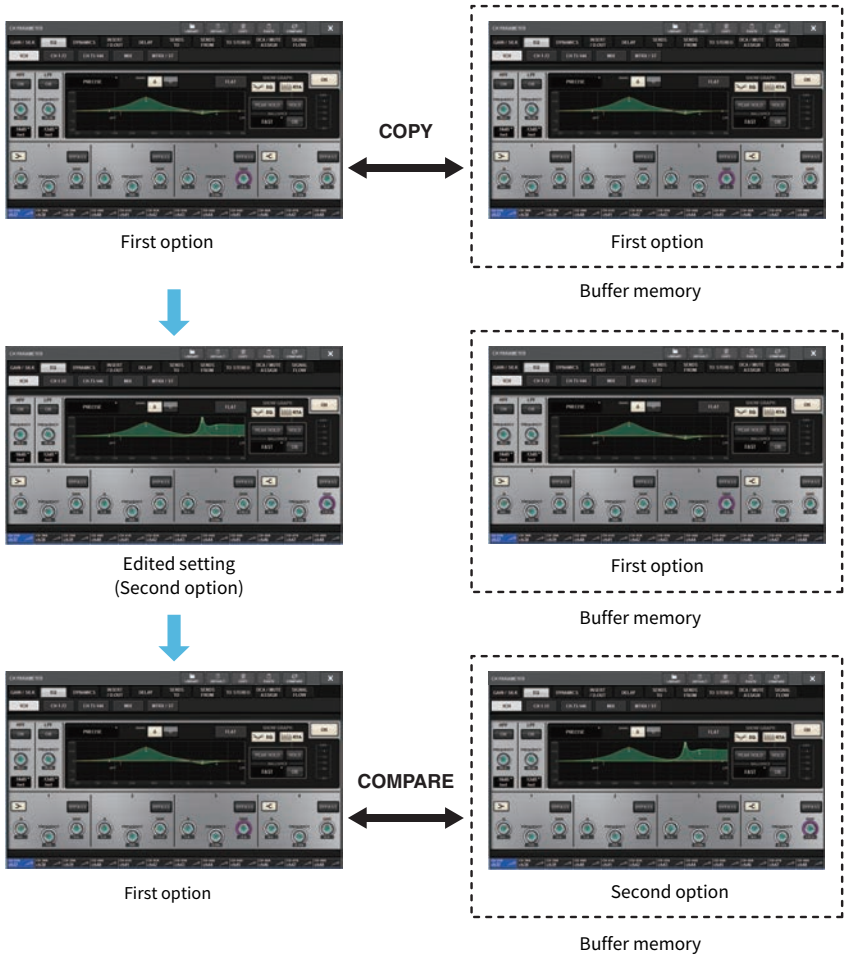

6 Press the COMPARE button repeatedly to listen to options 1 and 2 alternately.

Pressing the COMPARE button repeatedly will alternate between the two options. Unlike the paste operation, you can revert to the previous setting at any time unless buffer memory has been overwritten.

Using libraries

This section explains how to use libraries. Using libraries enables you to store and recall the EQ or Dynamics settings of the currently-selected channel, or GEQ/PEQ or Plug-in settings.

Libraries are categorized as follows:

- INPUT CH library
- OUTPUT CH library
- INPUT EQ library
- OUTPUT EQ library
- DYNAMICS library
- GEQ library
- PLUG-IN library
- NAME library
- DCA NAME/ASSIGN library
- MUTE NAME/ASSIGN library
- USER SETUP library
- OVERLAY LIBRARY
- CUSTOM FADER LIBRARY
- MACRO LIBRARY

Basic operation is nearly identical for all of these libraries.

NOTE

- PLUG-IN library is sub-categorized into libraries based on type.
- NAME library is sub-categorized into libraries based on type.

Preset limits in the libraries

Up to 600 user presets can be stored in all libraries collectively. You can view the total number of presets in the TOTAL LIBRARY USAGE field.

NOTE

If you try to store more presets than the maximum allowed, the STORE button will be disabled.

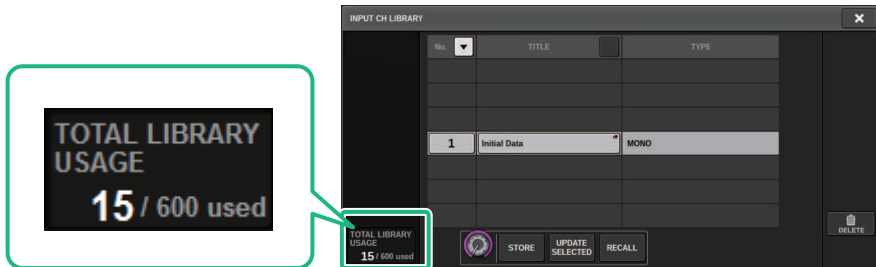

Recalling a preset from a library

This section describes how to recall a preset from a library.

1 Press the **LIBRARY** tool button.

The corresponding Library screen (Recall) will open.

2 Rotate the corresponding screen encoder to select the preset number you want to recall.

3 Press the **RECALL** button.

The selected preset data will be loaded and displayed.

NOTE

Some presets selected as the recall source may not be recalled into the currently-selected item.

The following restrictions apply for each library:

- Channel libraries

In the OUTPUT CH library, if the type of channel selected in the list does not match the type of channel selected as the recall destination, the “CONFLICT” indicator will appear on the right side of the TYPE column. You can still recall the preset while the “CONFLICT” indicator appears. However, please note that parameters that are not included in the recalled preset will be set to default values.

- OUTPUT EQ library

This library is sub-categorized into three types: output channel EQ, 8BandPEQ (to be mounted to INSERT), and MONITOR/CUE EQ. If you select a different type of preset than the destination, the “CONFLICT” indicator will appear. You can still recall the preset while the “CONFLICT” indicator appears. However, please note that parameters that are not included in the recalled preset will be set to default values or will remain unchanged.

- GEQ library

The presets stored in the GEQ library are sub-categorized into two types: 31BandGEQ and Flex15GEQ. If a 31BandGEQ library preset includes gain settings for more than 16 bands, you will be unable to recall it into Flex15GEQ.

- USER SETUP library

Setup data created in PM Editor can be recalled only by using PM Editor. Setup data created on the control surface can be recalled only by using the control surface.

Library screen (Recall)

Each library screen contains the following items.

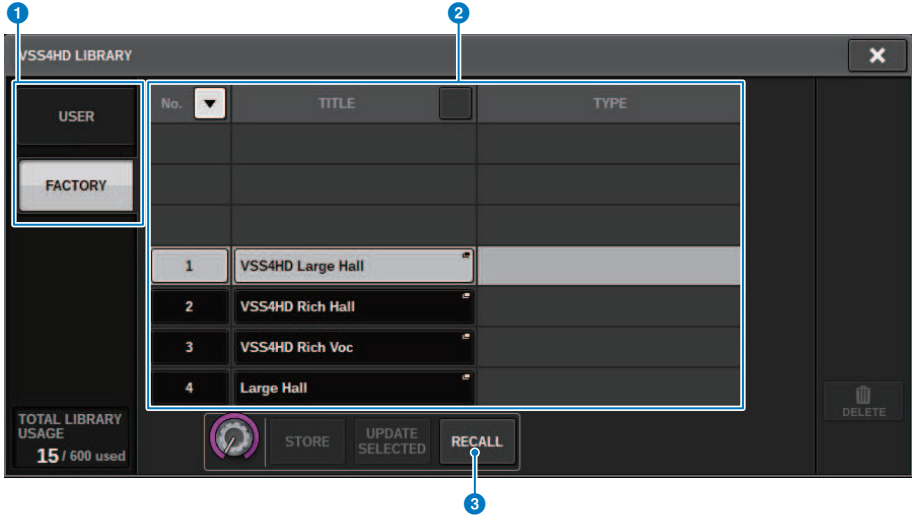

1 USER preset/FACTORY preset switching buttons

Switch between the user preset and factory preset display.

NOTE

The FACTORY preset switching button appears only on library screens for plug-ins that feature factory presets.

2 List

Displays the setting data (presets) stored in the library. The highlighted row in the list indicates that the item is selected for use.

NOTE

The right column in the list shows information related to the corresponding setting data (such as the type of output channels, Dynamics or effect type used).

3 RECALL button

Recalls a preset for the currently-selected item.

4 Sort buttons

Enable you to sort by library number or library name.

Storing setting data in a library

This section describes how to store setting data in a library.

1 Press the LIBRARY tool button.

“Library screen (Store)” (p.134) will open.

2 Rotate the corresponding screen encoder to select the preset number to which you want to store the setting.

3 After you select the store destination, press the STORE button.

A dialog will request that you confirm the store operation.

4 To execute the store operation, press the OK button.

The setting data will be stored to the preset number you selected in step 2. If you decide to cancel the store operation, press the CANCEL button instead of the OK button.

NOTE

You can change the title of the setting data after storing it by pressing on the setting data title in the list to open the TITLE EDIT popup window.

Library screen (Store)

Each library screen contains the following items.

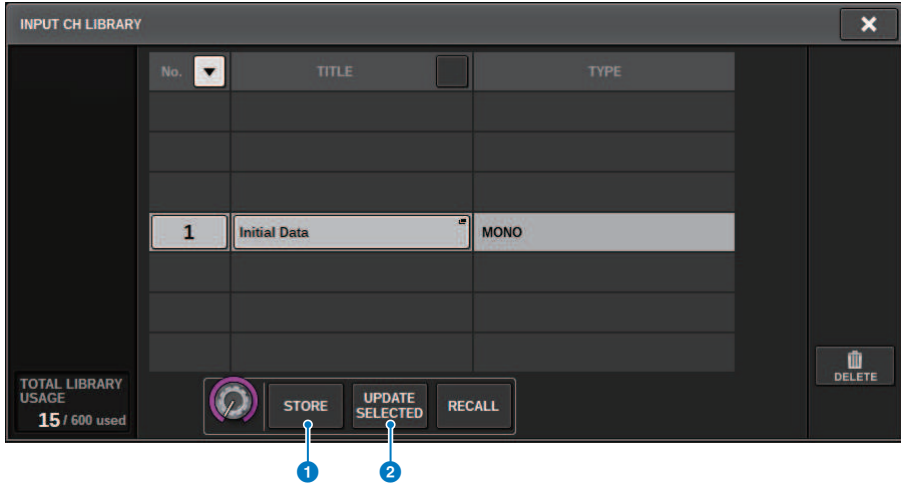

1 STORE button

Stores the current-channel EQ or Dynamics setting, or the GEQ/PEQ or Plug-in setting.

2 UPDATE SELECTED button

Stores the current setting by overwriting the selected preset.

Deleting setting data from a library

This section describes how to delete a preset from a library.

1 Press the LIBRARY tool button.

“Library screen (Delete)” (p.136) will open.

2 Rotate the corresponding screen encoder to select the preset number you want to delete.

3 Press the DELETE button.

A dialog will request that you confirm the delete operation.

4 To execute the delete operation, press the OK button.

The preset you selected in step 3 will be deleted. If you decide to cancel the delete operation, press the CANCEL button instead of the OK button.

Library screen (Delete)

Each library screen contains the following items.

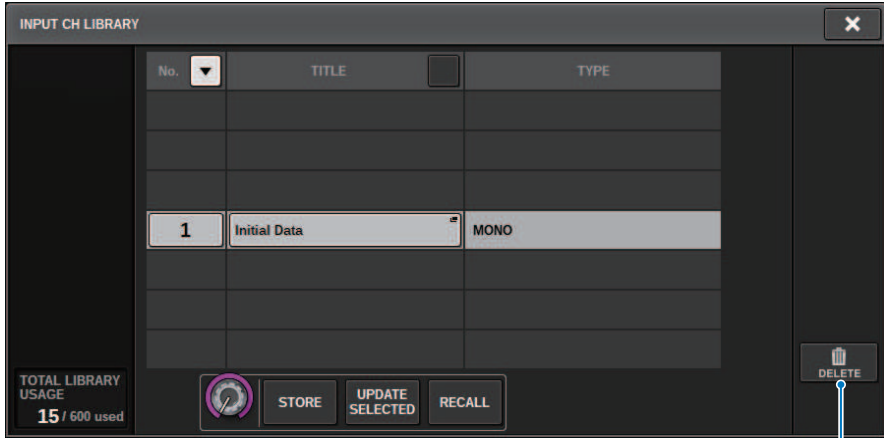

1 DELETE button

Deletes the preset selected in the list.

Pair setting

Adjacent channels can be paired and used as a stereo module.

Input channels

You can pair either odd/even-numbered channels or even/odd-numbered channels. For single input channels (monaural), the pan level is nominal at the center, and +3 dB at hard left or hard right. For paired input channels, the balance level is nominal at the center, and +3 dB at hard left or hard right.

MIX buses and MATRIX buses

You can pair adjacent odd/even-numbered MIX buses or MATRIX buses.

NOTE

For information on the parameters that can be linked using the pair setting, refer to the data list.

When MIX buses are paired, the signal flow will change as described below:

CH to MIX

FIX

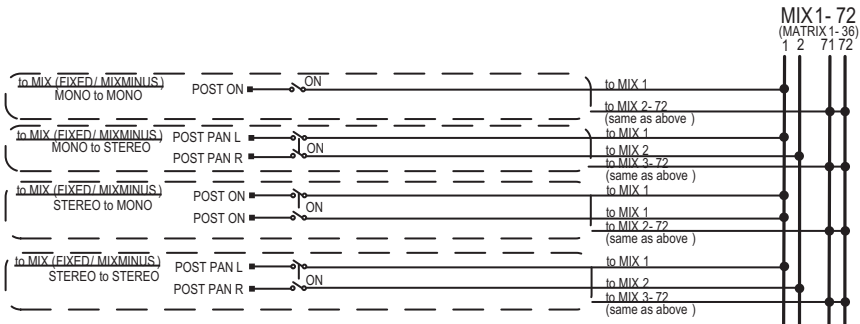

CH to MIX

VARI

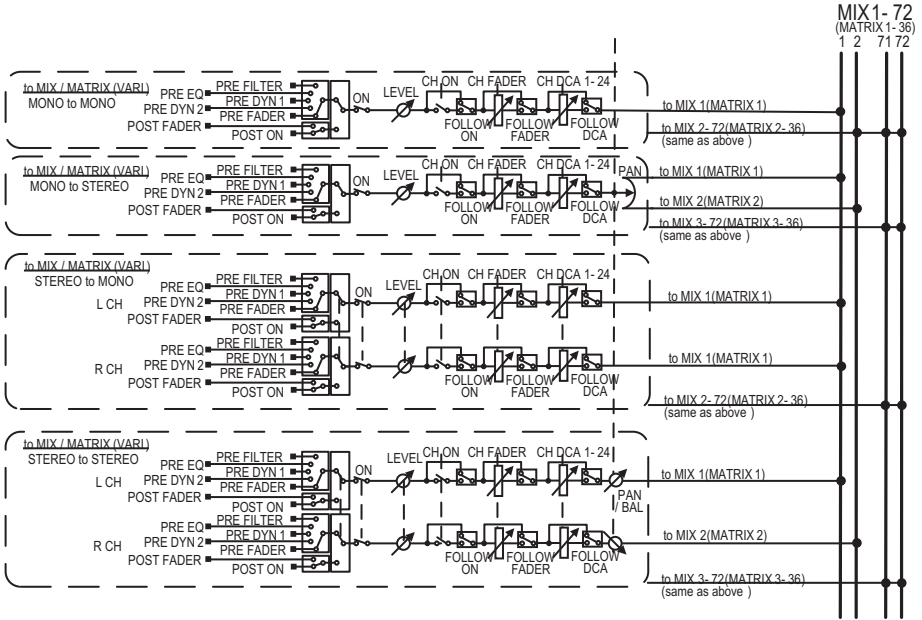

MIX to MATRIX

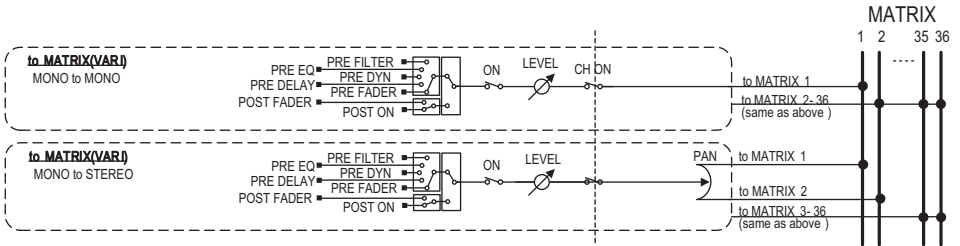

MIX/STEREO to MATRIX

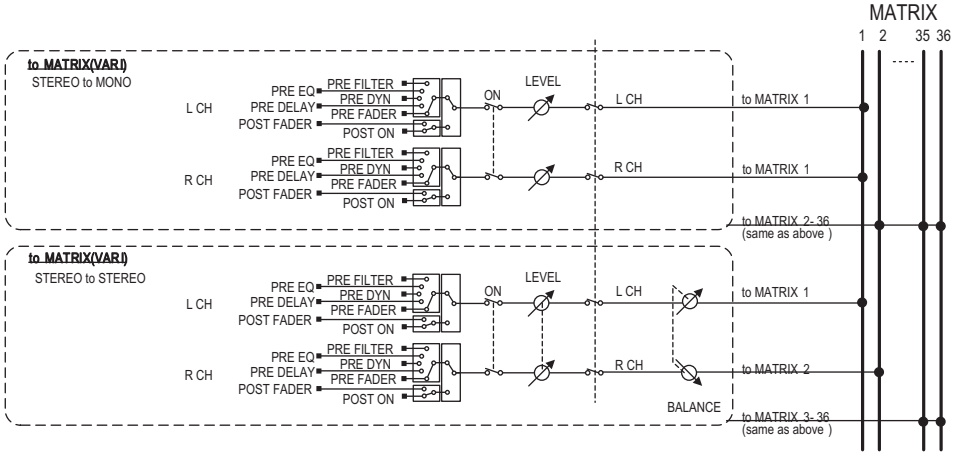

MATRIX (MONO) to OUTPUT PATCH

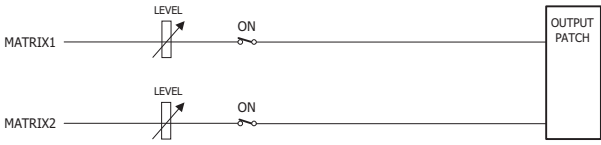

MATRIX (STEREO) to OUTPUT PATCH

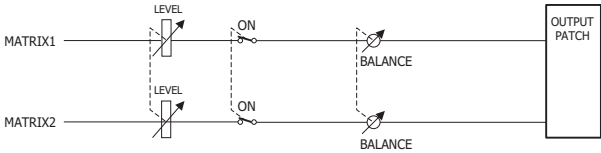

5 Press the OK button.

The pairing setting will be defeated.

Screen Overview

About the SELECTED CHANNEL VIEW window

This window shows all mix parameters of the currently-selected channel.



ISOLATE



1 ON button

Turns the Isolate function on and off.

RECALL SAFE

This field allows you to specify the Recall Safe settings.



1 ON button

Switches the Recall Safe status on or off.

2 Popup button

Press this button to open the RECALL SAFE popup window. This button will indicate “PARTIAL” if recall safe applies only to some of the parameters, not to all channel settings. It will indicate “All” if recall safe applies to all parameters. If no parameters are specified, it will indicate “OFF.”

SOLO SAFE



1 ON button

Turns the Solo Safe function on and off.

MUTE SAFE



1 ON button

Turns the Mute Safe function on and off.

TO STEREO field

You can control the stereo balance of the signals sent from the selected channel to the STEREO bus, or the signals output from the MIX/MATRIX/STEREO buses. The indication varies depending on the selected channel, as follows.

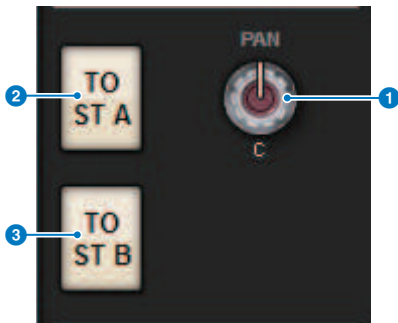

If the selected channel is an input channel or MIX channel:

Use the right-side PAN knob **1** to adjust the panning of the signal. Use the TO ST A button **2** to switch the signal to be sent to the STEREO A bus on or off. Use the TO ST B button **3** to switch the signal to be sent to the STEREO B bus on or off.

NOTE

If channels are paired for stereo, the PAN knob will be replaced with the BALANCE knob.



In the TO STEREO popup window, if the PAN/BALANCE select button is set to PAN, the L and R PAN knobs⁴ are displayed, allowing you to specify the panning of the signal. If you use the ST/LCR mode select button to select LCR, the LCR button⁵ and CSR knob⁶ are displayed. The LCR button turns on/off the signal that is sent from the channel to the STEREO bus, and the CSR knob specifies the level ratio between the signal that is sent to the STEREO A (L/R) bus and to the STEREO B (C) bus.

Fader strip field



- 1 LEVEL meter**
Displays the POST ON level of a channel.
- 2 CUE ON button**
Switches Cue Out on or off. The button also displays the selected cue bus(es).
- 3 ON button**
Switches the channel on or off.
- 4 FADER knob**
Adjusts the channel fader level.

CH MODE field



1 L/R PATH pull-down menu

Displayed if the input channels are paired. You can select MONO, STEREO, L/L, or R/R as the audio combination input to the input channels.

2 NAME popup buttons

Press this button to display the NAME/ICON EDIT popup window.

3 Pair setting popup button

Press this button to display the “Setting or defeating pairing on the SELECTED CHANNEL VIEW screen” (p.140).

4 LIBRARY popup button

Press this button to open the library popup window, where you can store or recall input/output channel parameters (including the HA setting).

PATCH field

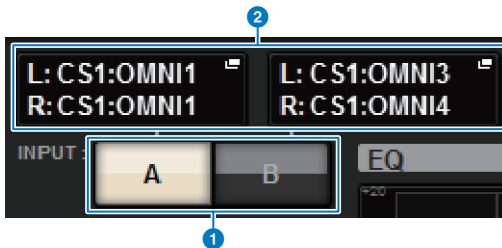

1 INPUT A/B switch buttons

Switches between INPUT A and INPUT B.

2 PATCH popup button

Press this button to open the patch window. The button will display the patch setting. If the selected channel is a STEREO channel, or is a MIX/MATRIX channel that is assigned as a pair, an OUTPUT BALANCE knob is shown, enabling you to adjust the output balance.

ANALOG GAIN field

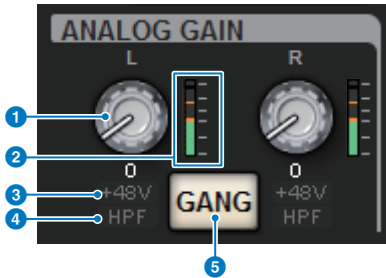

1 ANALOG GAIN knob

Sets the HA analog gain. If the Gain Compensation function is turned on, a blue indicator appears, showing the analog gain position at the time the function was turned on.

2 HA meter

Displays the level immediately after the analog head amp.

3 +48V indicator

Displays the phantom power (+48V) on or off status for the head amp.

4 HPF indicator

Indicates the on/off status of the HPF immediately after the external head amp.

5 GANG button

This button is displayed if channels are paired. If this button is on, the differences in HA analog gain will be maintained, and the digital gain GANG button will also be turned on.

SILK field



1 SILK [TEXTURE] knob

Adjusts the Silk TEXTURE parameter.

2 SILK [ON] key

Switches Silk on or off.

3 SILK [BLUE/RED] key

Toggles between BLUE and RED Silk characters: “BLUE” for solidity and power, and “RED” for sparkling energy.

DIGITAL GAIN field/PHASE field

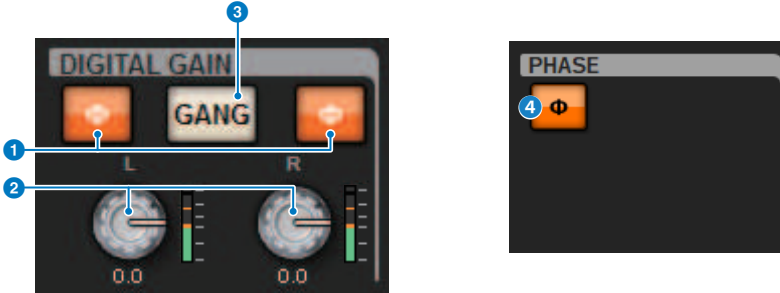

1 Φ (Phase) button

Switches the phase of the head amp input signal between normal phase (gray) and reverse phase (orange).

2 DIGITAL GAIN knob

Displays the digital gain setting value. Use the screen encoder to adjust the digital gain. If the Gain Compensation function is turned on, this knob will adjust the level of the signal input to the selected channel.

3 GANG button

This button is displayed if channels are paired. If this button is on, the differences in digital gain will be maintained, and the digital gain GANG button will also be turned on.

4 Polarity button

Inverts the phase of the input and output signals.

DELAY field

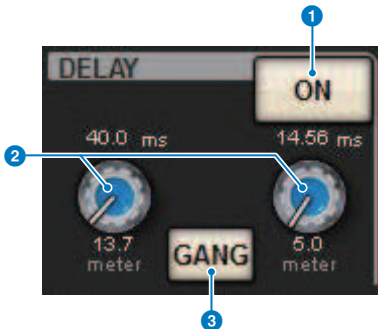

1 DELAY ON button

Switches the delay function on or off for the selected channel.

2 Delay time

Displays the delay time. Use the corresponding screen encoder to adjust the delay time. In addition, you can press one of these values to display the DELAY TIME popup window, where you can set the delay time.

3 GANG button

This button is displayed if channels are paired. If this button is on, then differences in delay time will be maintained.

DIRECT OUT field (input channels only)

This field allows you to turn Direct Out on/off for the selected input channel.



1 ON button

Turns the Direct Out on or off.

2 Direct Out patch popup button

Press this button to open the “INSERT/D.OUT popup window (1CH)” (p.516). The Direct Out level value will appear to the left of the button.

EQUALIZER field

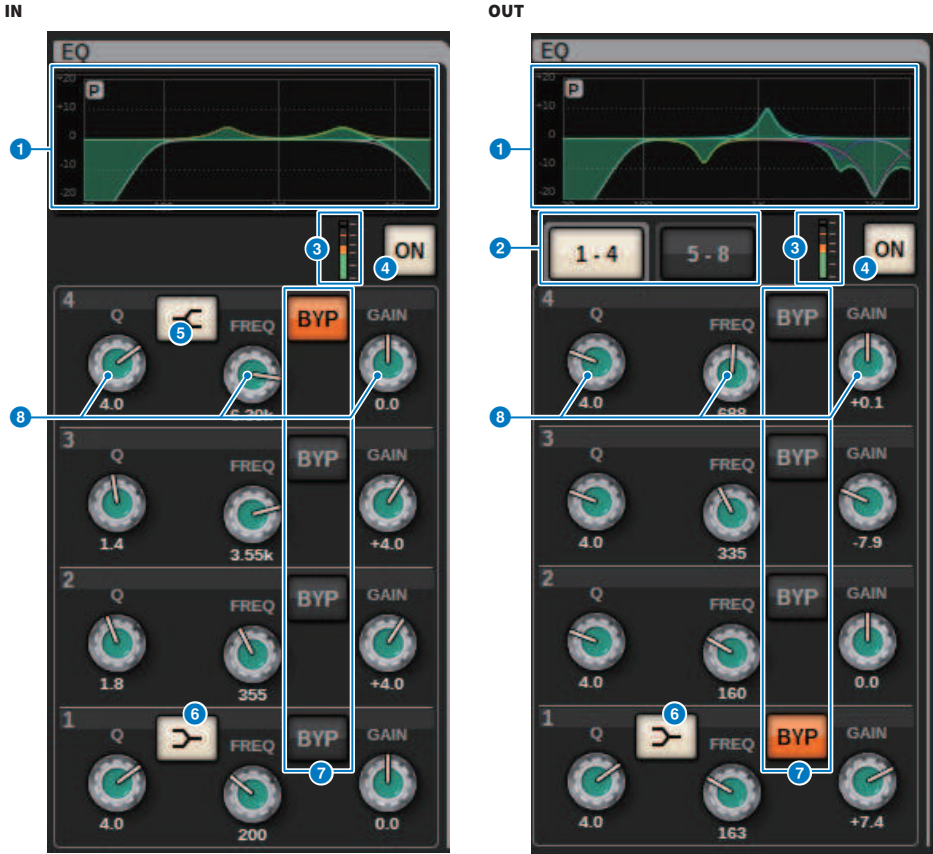

- 1 EQ graph**

This field indicates the approximate EQ response characteristics. Press this field to open the “EQ popup window (1ch)” (p.490), where you can set the HPF, LPF and EQ.
- 2 Tabs (Output channels only)**

Use these tabs to select a band that you want to view on the screen.
- 3 EQ IN/OUT level meters**

Indicate the peak level of signals before and after the EQ. For a stereo channel, these meters indicate the level of both the L and R channels.
- 4 EQ ON/OFF button**

Switches the EQ on or off.

5 HIGH SHELVING ON/OFF button

Turn on this button to switch the HIGH band to a shelving type filter.

6 LOW SHELVING ON/OFF button

Turn on this button to switch the LOW band to a shelving type filter.

7 BYP (BYPASS) button

Temporarily bypasses the EQ for each band.

8 EQ parameter setting knobs

Indicate the Q, FREQUENCY, and GAIN parameters for each band. When this knob is pressed, the parameter name and value are displayed at the top of the channel name area and can be adjusted using the screen encoder.

LPF field

This field allows you to set the LPF.



1 LPF knob

Specifies the cutoff frequency of the low pass filter.

2 ON button

Switches the LPF on and off.

3 LPF type select button

Allows you to set the LPF attenuation per octave to -6 dB/oct or -12 dB/oct.

HPF field

This field allows you to set the HPF.



- 1 HPF knob**
Sets the HPF cutoff frequency.
- 2 ON button**
Switches the HPF on and off.
- 3 HPF type select button**
allows you to set the HPF attenuation per octave to -6 dB/oct, -12 dB/oct, -18 dB/oct, or -24 dB/oct.

DCA/MUTE field

This field displays the DCA or mute group to which the channel is assigned.

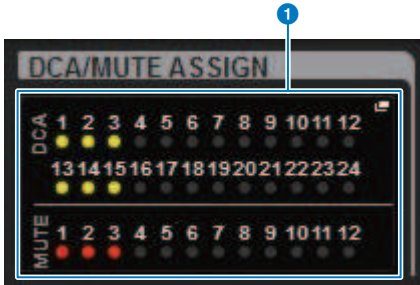

- 1 DCA/mute group pop up button**
Indicates the DCA and mute group to which the channel is assigned. Press this button to open the DCA/MUTE ASSIGN (1CH) popup window.

NOTE

Each indicator will flash when the muted channel MUTE GROUP CONTROL is ON or DCA MAIN is OFF.

INSERT field

This field allows you to specify insert settings.



- 1 ON button**
Switches the insert on or off.

2 Plug-in buttons

If nothing is inserted, each button will display “BLANK.” If you press a BLANK button, a window will appear, where you can insert a plug-in. If a plug-in is already inserted, a window will appear, where you can set the plug-in parameters. Also, the level indicator will appear in the upper right.

NOTE

If an inserted plug-in is bypassed, the plug-in button icon will become dark.

DYNAMICS 1/DYNAMICS 2 field

This field allows you to view and set the Dynamics 1/2 parameters. Press the meter or the selected knob to open the DYNAMICS 1/2 popup window, where you can specify detailed parameter settings.



1 DYNAMICS 1 graph

Indicates the abbreviated name of the dynamics processor type and the threshold value that are selected for Dynamics 1.

The input/output characteristics graph, GR (gain reduction) meter, input/output level indicator, threshold values and dynamics type are displayed.

2 DYNAMICS 2 graph (input channels only)

Indicates the abbreviated name of the dynamics processor type and the threshold value that are selected for Dynamics 2.

The input/output characteristics graph, GR (gain reduction) meter, input/output level indicator, threshold values and dynamics type are displayed.

NOTE

For details on the abbreviation of the dynamics processor types, refer to the DYNAMICS 1/2 popup window. (DYNAMICS 1/2 popup window)

Dynamics types						
GATE/DUCKING	THRESHOLD	RANGE	—	ATTACK	HOLD	DECAY
COMP/EXPANDER	THRESHOLD	RATIO	OUTGAIN	ATTACK	RELEASE	KNEE
DE-ESSER	THRESHOLD	FREQ	Q	—	—	TYPE
FET LIMITER	INPUT	RATIO	OUTPUT	ATTACK	RELEASE	—
DIODE BRIDGE COMP	THRESHOLD	RATIO	GAIN	—	RECOVERY	—

3 ON button

Switches the dynamics processor on or off.

4 Threshold

Sets the threshold. When this knob is pressed, the parameter name and value are displayed at the top of the channel name area.

5 Parameter

Displays the values of parameters that vary depending on the currently-selected dynamics type. When this knob is pressed, the parameter name and value are displayed at the top of the channel name area.

MIX/MATRIX SENDS field



1 MIX popup buttons (input/MATRIX channels only)

Displays the level sent from the channel selected by the input channel to the MIX bus. Displays the level sent from the MIX bus on the MATRIX channel to the selected channel. Press to roll out the send parameters to the screen encoder. Press again to switch between the SEND FROM and SEND TO windows.

NOTE

On the CS-R5, when the encoder is in channel strip mode, the screen switches between SEND FROM and SEND TO when this is pressed.

On with PRE



On with POST



Off with PRE



Off with POST





2 MATRIX popup buttons (input/MIX/STEREO channels only)

Each button displays the level of the signal sent from the selected channel to the MATRIX bus. Press to roll out the send parameters to the screen encoder. Press again to switch between the SEND FROM and SEND TO windows.

About the OVERVIEW window

This window displays the main parameters for the 12 channels selected for the layer all at once.



Channel name area

The upper part of the channel name area displays the channel number and the setting status of the patch and VSC. The middle part of the channel name area displays the channel name and channel icon. The lower part of the channel name area displays the overlay and fader status.

Selected channel

Channel is on

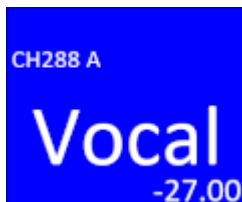

Unselected channel

Channel is on



Channel with overlay turned on

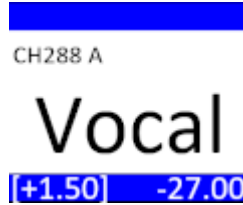

Channel with Isolate turned on



Temporarily linked channel



Unassigned channel



HA GAIN field

Sets the analog gain/digital gain of the HA (head amp). This also displays the operational status of the HA. The displayed contents of this field changes depending on the status of patches and the system configuration.

For analog gain

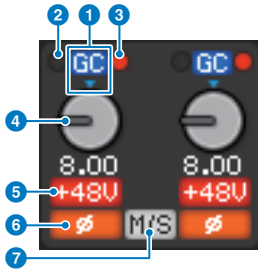

1 GC indicator

If the Gain Compensation function is turned on, this indicator will appear, showing the fixed gain value of the signal output to the TWINLANe network or Dante network.

2 PRE GC OVER indicator

Illuminates to indicate that a signal is clipped before gain compensation.

3 POST GC OVER indicator

Illuminates to indicate that a signal is clipped after gain compensation.

4 ANALOG GAIN knob

Displays the HA analog gain setting value. Use the screen encoder to adjust the gain. If gain compensation is turned on, an indicator shows the analog gain position at the time that gain compensation was turned on.



5 +48V indicator

Displays the phantom power (+48V) on or off status for the head amp. This indicator is not displayed unless the head amp is patched to the channel.

6 Indicator

Displays the phase setting status for the head amp input.

7 M/S indicator

This indicator is displayed when the M/S Decode function is enabled.

For digital gain

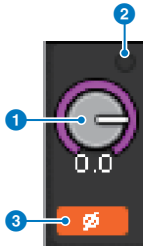

1 DIGITAL GAIN knob

Displays the digital gain setting value. Use the screen encoder to adjust the digital gain. If the Gain Compensation function is turned on, this knob will adjust the level of the signal input to the input channel.

2 OVER indicator

Illuminates when a signal at the input port or from the rack output is clipped. This indicator is displayed only if an input channel is selected.

3 Indicator

Displays the phase setting status for each channel.

NOTE

You can display either analog gain or digital gain in the OVERVIEW screen by using the GAIN SHOWN ON OVERVIEW SCREEN setting on the PREFERENCES screen.

SILK field

Displays the SILK setting status. A bar graph on the right displays the TEXTURE of the SILK processing.

SILK BLUE On



SILK BLUE Off



SILK RED On



SILK RED Off



DELAY field

This field displays the delay status of the corresponding input channel or output channels. Press this field to open the DELAY popup (12CH) popup window.



This field displays the delay status of the corresponding input channel or output channels. Press this field to open the DELAY popup (12CH) popup window.

1 DELAY ON/OFF indicator

Indicates the on/off status of the delay.

INSERT/DIRECT OUT field

This field allows you to make insert and Direct Out settings. Press this field to open the INSERT/D.OUT 1CH popup window.

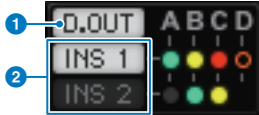

1 DIRECT OUT ON/OFF indicator (input channels only)

Indicates the Direct Out on/off status.

2 INSERT ON/OFF indicator

Displays the Insert on/off status. The following indicators display the insert mount status:

	A plug-in, GEQ/PEQ, or outboard unit is inserted at the insert point.
	Bypassed
	Level indicator
	Gray: $-\infty$
	Green: < -18 dB
	Yellow: -18 dB \leq , ≤ 0 dB
	Red: 0 dB $<$

EQ field

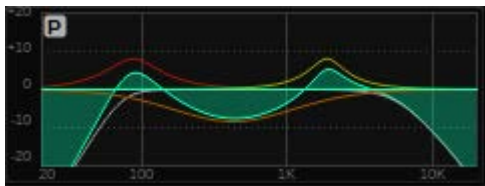

This field indicates the approximate EQ response characteristics. Press this field to open the HPF/EQ (1CH) popup window, where you can specify the HPF, LPF and EQ settings. This field will be grayed out on channels for which the EQ is disabled.

DYNAMICS 1/2 field



This field displays the threshold value, meter, and abbreviated dynamics processor type for Dynamics 1/2. Press this field to open the DYNAMICS 1/2 (1CH) popup window. If GATE is selected as the dynamics type, an indicator is displayed to indicate the gate status. If the dynamics processor is any type other than GATE, the abbreviated type name will be displayed in this field, and the threshold setting will be indicated as a horizontal line on the meter. For information on the abbreviated name and GATE indicators that are displayed, see (DYNAMICS1/2 popup window). In addition, the on/off status of the dynamics is displayed in the type.

SEND field

This field displays the send level, output bus name, and the send on/off status for 12 buses.



To select the 12 destination buses, use the MIX/MATRIX SENDS [1-12]/[13-24]/[25-36]/[37-48]/[49-60]/[61-72] keys on the panel. Use the screen encoders or the [TOUCH AND TURN] knob to adjust the send level for each bus. Press the knob of the bus you want to control to assign the knob to one of the screen encoders. If it is assigned to the [TOUCH AND TURN] knob, press the knob again to open the SENDS TO popup window. If the channels that are rolled out to a bay are MATRIX channels, press the knob to open the SENDS FROM popup window. This display for this field varies depending on the type of destination bus.

If the destination bus is VARI (mono):

The knob color and pointer color indicate the send on/off and pre/post status. If the send is off, the knob color will turn gray. With the post setting, the knob pointer color will turn black.

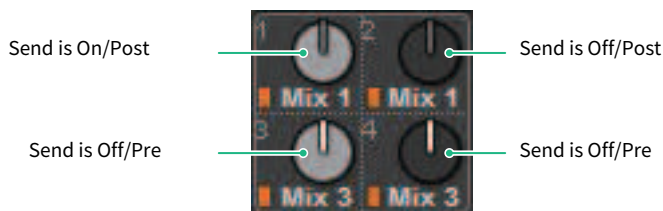

If the destination bus is VARI (stereo):

If a pair of buses (odd-numbered and even-numbered) are in stereo, the left-hand knob will function as the PAN knob, and the right-hand knob will function as the SEND knob.



If the destination bus is set to FIXED:

The SEND ON/OFF button for each bus is shown instead of the knob.



TO STEREO field

This field displays the on/off status and pan/balance setting of the signal sent to the STEREO bus. Press this knob and you will be able to use the screen encoder and the [TOUCH AND TURN] knob to adjust the value. If you press the knob once again, the TO STEREO popup window will appear. This field varies depending on the type of the selected channel.

When an input channel or MIX channel is selected:

1 TO STEREO PAN knob

Sets the pan/balance of a signal routed to the STEREO bus. Press the knob to open the TO STEREO popup window.

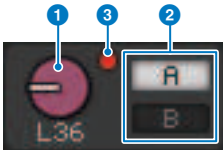

2 TO ST A/TO ST B indicators

Displays the status of a signal sent to the STEREO A bus/STEREO B bus. If an input or MIX channel is set to LCR mode, the LCR indicator will be displayed.



3 Σ clipping indicator

Illuminates to indicate that a signal is clipped at some point in the channel.



When MATRIX or STEREO channels are selected:

If STEREO channels are selected, the stereo balance will be displayed. Also, If MATRIX channels are paired, the balance will be displayed. The Σ clip indicator will be displayed if the signal is clipped at some point within the channel.

DCA field

A DCA (1-24) to which the channel is assigned is displayed on the first and/or second row in this field. Press this field to open the DCA/MUTE ASSIGN (1CH) popup window.



NOTE

Each indicator will flash when the muted channel MUTE GROUP CONTROL is ON or DCA MAIN is OFF.

Mute group field

The mute group (1-12) to which the channel is assigned is displayed on the third row in this field. If that channel has been temporarily removed (SAFE) from the mute group, a highlight is applied. Press this field to open the DCA/MUTE ASSIGN (1CH) popup window.

NOTE

Press the [SHIFT] key to display the send block switching button in the DCA/Mute group field.



Quick Guide

Basic system

This section describes a basic procedure for setting up your RIVAGE PM10 system.

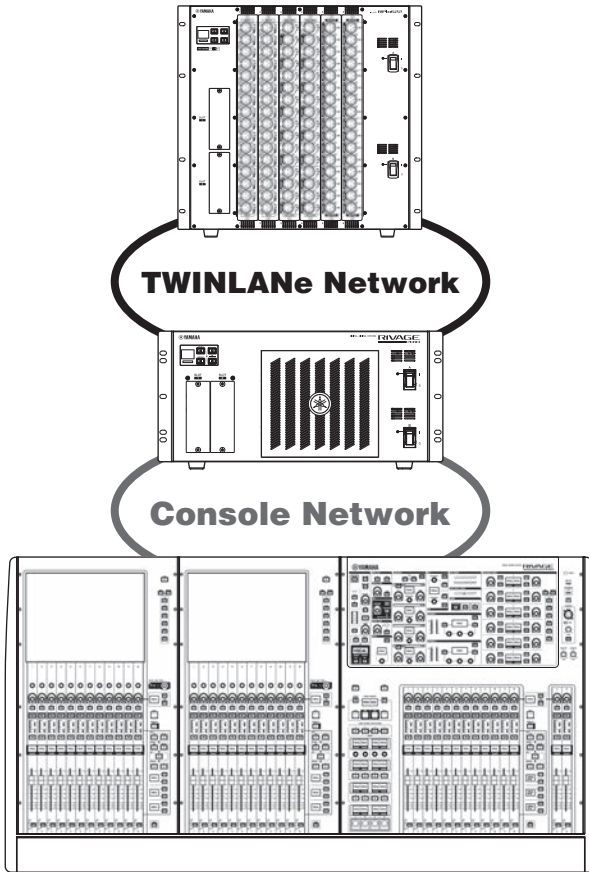

The system in the example consists of the following devices:

- Control surface (CS-R10) x 1
- DSP engine (DSP-R10) x 1
- I/O rack (RPio622) x 1
- HY card (HY256-TL) x 2
- RY card (RY16-ML-SILK) x 1
- RY card (RY16-DA) x 1

Set-up procedure

Quick Guide > Basic system

“Installing optional cards” (p.167)

“Assigning the Unit ID” (p.173)

“Connecting the devices” (p.175)

“Turning on the power to the system” (p.177)

Setting the word clock

“Assigning channels to the TWINLANe network” (p.179)

Patching the input ports

Patching the output ports

Specifying the analog gain for the HA (head amp)

Routing the input channel signals to the STEREO bus

- 3** Align both edges of the HY card with the guide rails inside the slot, and then insert the card into the slot with the card installation lever pressed down.

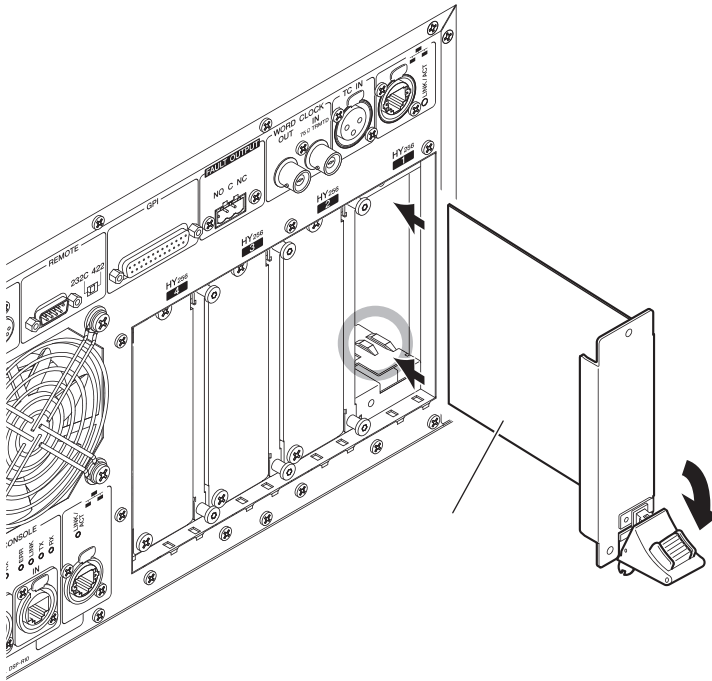

NOTE

For information on cards supported by each slot, refer to “Component Structure.”

Push the card all the way into the slot so that the connector at the end of the card is correctly inserted into the connector inside the slot.

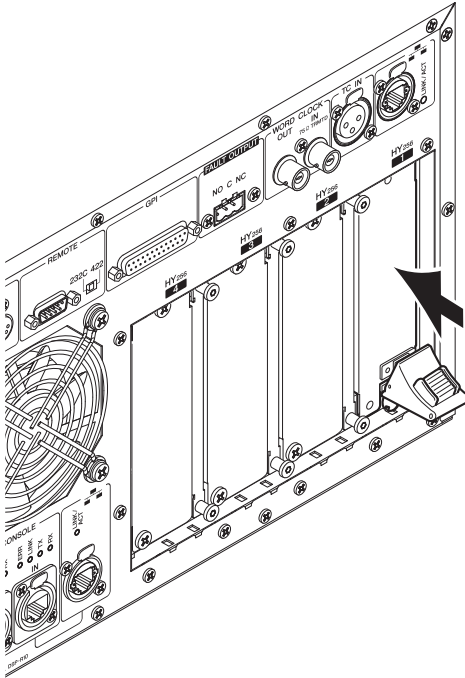

4 Pull up the card installation lever to lock in the card.

Make sure that the lever claw is securely locked under the bottom part of the slot.

NOTE

If the lever claw does not lock in, pull up the card slightly, then push it in.

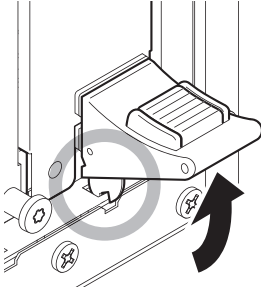

5 Affix the card using the screws that were previously used to affix the slot cover.

If the card is not fastened securely, component failure or malfunction may occur.

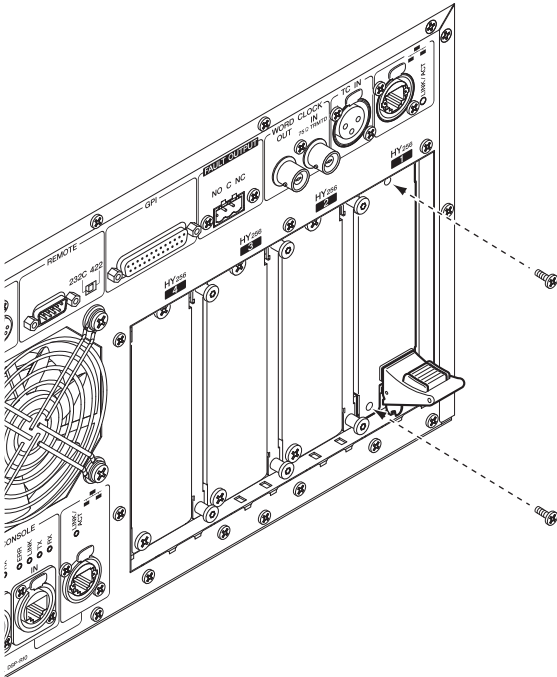

Installing the RY card

Insert the Mic/line input card (RY16-ML-SILK) into RY card slot 1 on the I/O rack. Insert the analog output card (RY16-DA) into RY card slot 2 on the I/O rack.

Installing an RY Card

1 Make sure that both power indicators are off.



CAUTION

- Installing or removing a card while the power is on may lead to component failure or electric shock.

2 Remove the screws that fasten the slot cover to remove the slot cover.

Keep the cover and fixing screws in a safe place for future use.

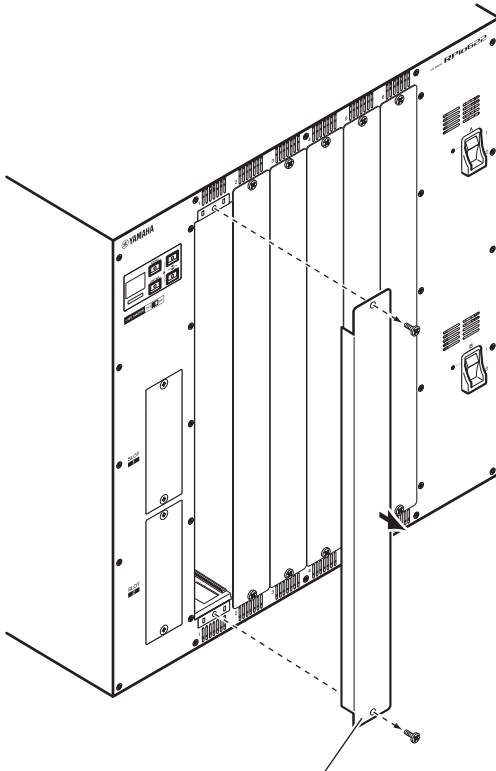

3 Align both edges of the card with the guide rails inside the slot, and then insert the card into the slot.

Push the card all the way into the slot so that the connector at the end of the card is correctly inserted into the connector inside the slot.

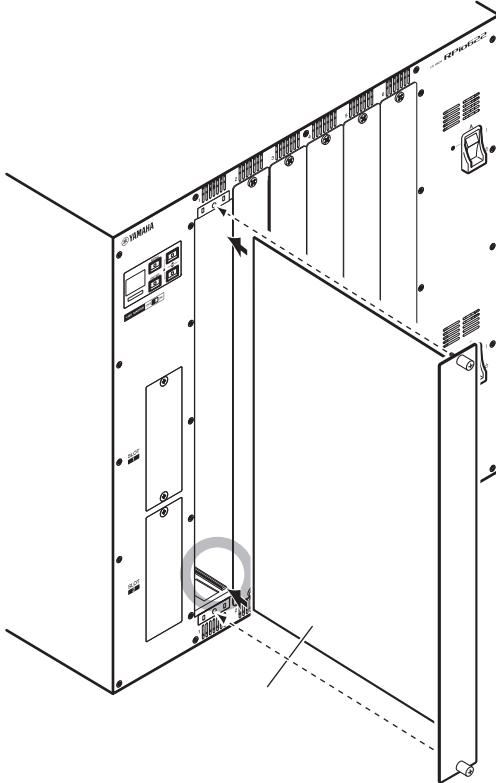

4 Fasten the card using the screws attached to the card.

If the card is not fastened securely, component failure or malfunction may occur.

NOTE

Use a tool, such as a screwdriver, to tighten the screws to secure the cards. The slots on the unit are well structured and shielded so that the cards will fit tightly into the slots. If the screws are not sufficiently tightened, the card might not be efficiently shielded and other cards might not fit into the slots easily.

Assigning the Unit ID

You need to assign a unique Unit ID to each device so that the system will recognize the connected devices. You can view the Unit ID on the LCD screen of each device.

Assigning the Unit ID to the DSP engine and I/O rack

- 1 Turn on the power (A and B) to the DSP engine and I/O rack to which you want to assign the Unit ID.**

The Unit ID number will appear. I/O rack: M1 - 8, S1 - 8



DSP engine: 1 - 4 (1A/1B - 4A/4B)



- 2 Press the [MENU] key.**

The menu screen will appear.

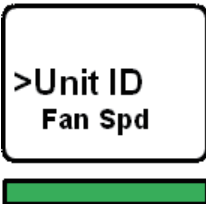

- 3 Press the [▲]/[▼] keys to move the cursor to “Unit ID.”**

4 Press the [ENTER] key.

The Unit ID setup screen appears.

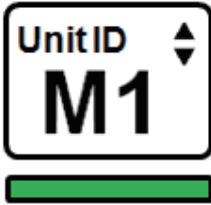

5 Press the [▲]/[▼] keys to select the desired Unit ID number.

6 Press the [ENTER] key to confirm the selected Unit ID number.

If you press the [MENU] key before the Unit ID setting is confirmed, the initial screen will be displayed.

7 The device will display the “setup complete” screen and automatically restart.



8 Assign the Unit ID for other devices in the same manner.

Be sure to set a unique Unit ID number for each device.

9 After you complete the settings, turn the power off.

Connecting the devices

Make sure that the power indicators are off.

Connecting the control surface to the DSP engine

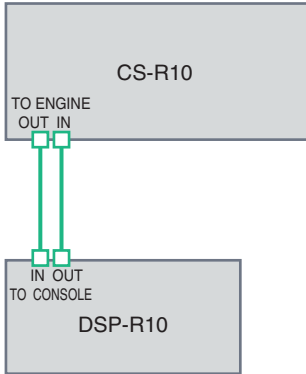

Use Ethernet cables to connect the TO ENGINE OUT/IN jacks of the control surface to the TO CONSOLE OUT/IN jacks of the DSP engine.

Connecting the DSP engines to the I/O rack

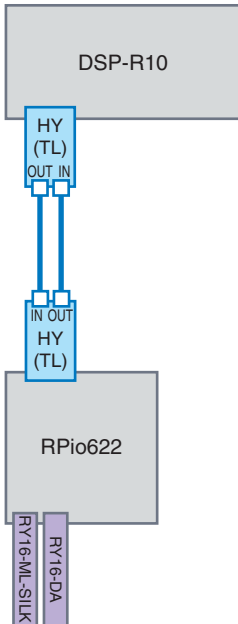

Use fiber-optic cables to connect the TWINLANE IN/OUT jacks of the HY card (installed in the DSP engine) to the TWINLANE OUT/IN jacks of the HY card (installed in the I/O rack).

Audio input and output connections

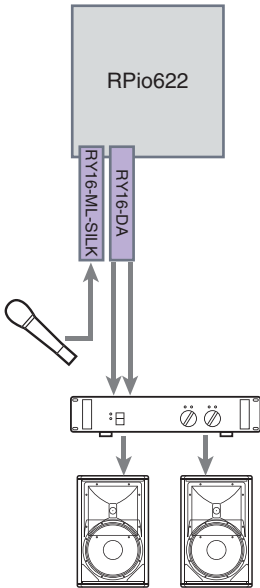

1 Analog input connection Connect a microphone or line-level component to the input jacks of the RY card (RY16-ML-SILK).

NOTE

In the default status, there are no patch settings for these input jacks. Before you can use signals at these jacks as the input, you need to make patch settings.

2 Analog output connection Connect a speaker system to the output jacks of the RY card (RY16-DA) to patch the signals on the output channels (MIX, MATRIX, or STEREO), monitor signals and cue signals.

Digital I/O connections

Before you connect digital audio equipment, you need to install an optional card on the I/O rack and the DSP engine. You can also use the AES/EBU connector on the control surface.

Turning on the power to the system

After the Unit ID setting and connections are complete, turn on the power to all connected devices. Once the control surface starts, information on the connected devices will automatically be collected and all devices will synchronize. A popup window will appear. Select the direction of the data synchronization (Engine -> Console; or Console -> Engine), and then press the SYNC button.



Setting the word clock

The entire system must synchronize to the word clock.

1 Press the **WORD CLOCK** button in the **SETUP** screen.



2 Select the clock source.

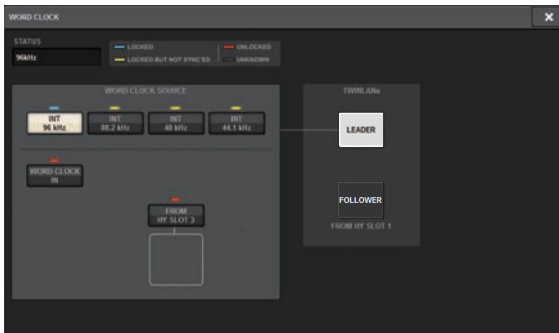

The default value is 96kHz. If the unit is operating correctly with the selected clock, the indicator for the selected clock will light blue, and the clock frequency will be displayed in the upper left of the LEADER CLOCK SELECT field.

3 To close the **WORD CLOCK** popup window, press the “x” symbol located in the upper right.

The system will return to the SETUP screen.

Assigning channels to the TWINLANE network

This section describes how to select channels from the DSP engine and I/O rack that will be output to the TWINLANE network, and to make settings to reserve the network bandwidth.

1 Press the **SYSTEM CONFIG** button in the **SETUP** screen.



2 Press the DSP button on the HY SLOT1 tab.

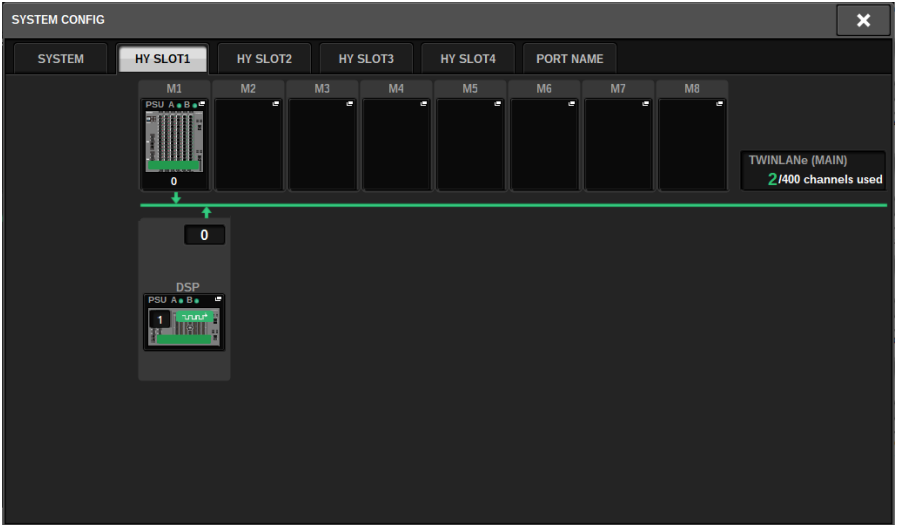

The DSP popup window will appear.

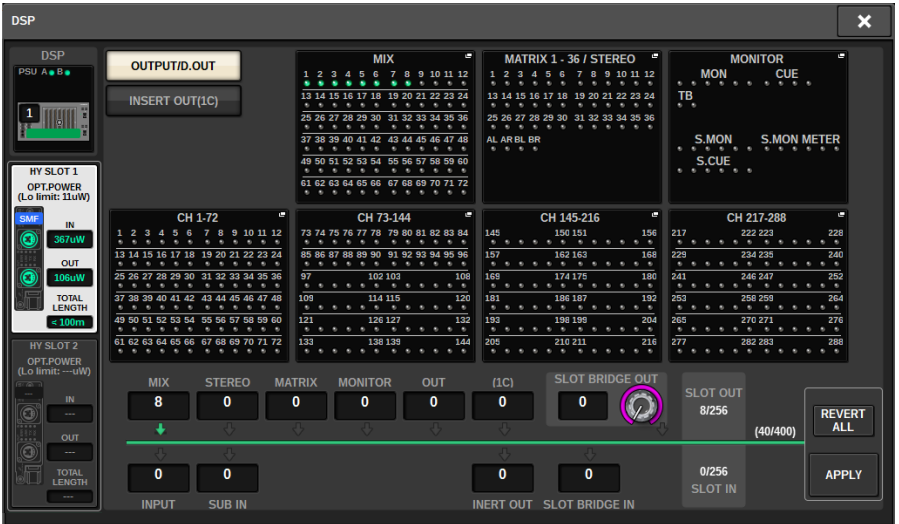

3 Press a desired channel assign popup button.

In this case, select STEREO. The TWINLANE CONFIGURATION popup window appears.

4 Turn on the desired channel select buttons.

In this case, select STA L and STA R.



5 To close the TWINLANe CONFIGURATION popup window, press the CLOSE button.

You will return to the DSP popup window.

6 If you turn on different channel select buttons, press the APPLY button.

The setting for the output from the DSP engine to the TWINLANe network is applied.

7 When a confirmation screen appears, press the OK button.

8 To close the DSP engine setting screen, press the “x” symbol located in the upper right.

9 Select an I/O rack.

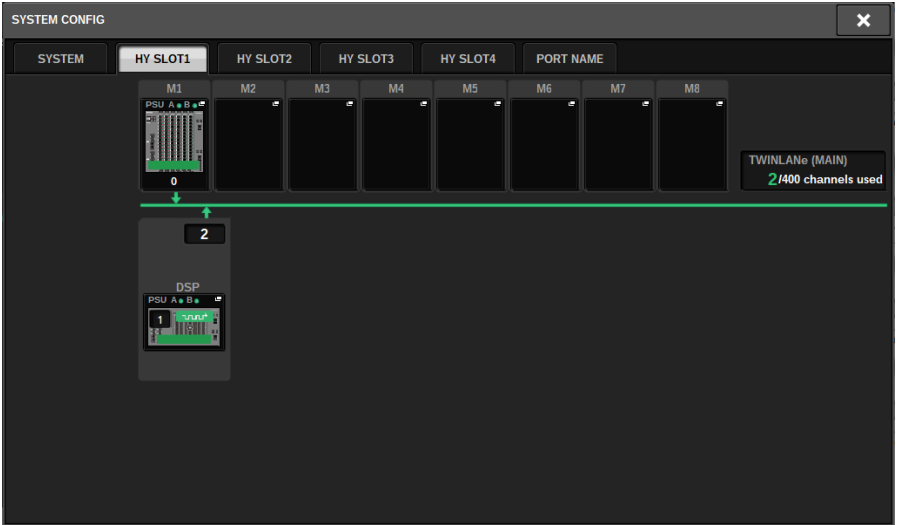

Press an I/O rack select button (in this case the M1 button). The I/O rack settings popup window will appear.

10 Press desired channel assign popup buttons to assign channels to the TWINLANe network.

In this case, select RY card slot 1.

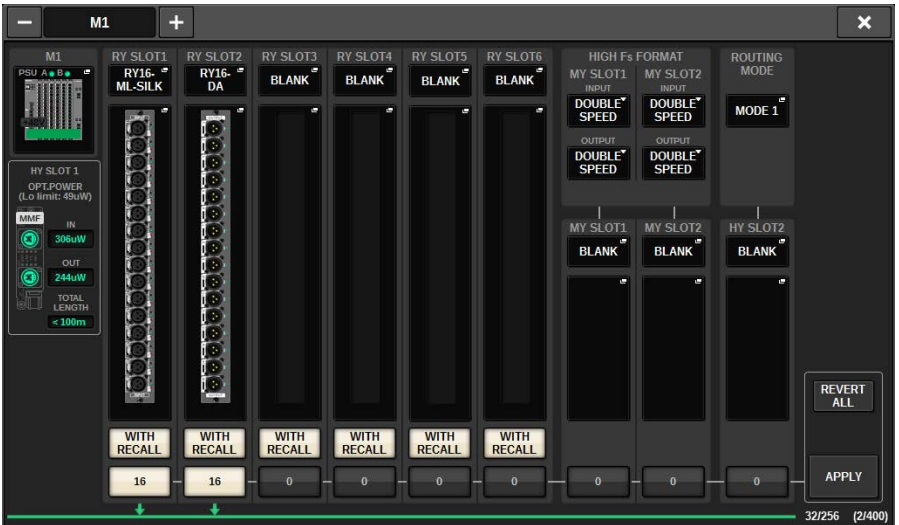

11 Press the APPLY button.

The setting for the output from the I/O rack to the TWINLANe network is applied.

12 When a confirmation screen appears, press the OK button.

Patching the input ports

Follow the steps below to patch an input channel to the input port to which the microphone was connected as described in the “Connecting the devices” section.

NOTE

The PATCH screen displays the input and output ports assigned to the TWINLANe network.

1 Press the PATCH button on the menu bar in the touch screen.

The PATCH screen will appear.

2 Press the INPUT tab.



3 Use the knob in the upper right to display the desired input port.



NOTE

The [TOUCH AND TURN] knob enables you to control the parameter of the knob you are touching on the touch screen.

For RY card slot 1 on the I/O rack (M1), “M1/Ry1” will be displayed.

4 Use the knob in the lower left corner to display the input channel.



5 Press the desired grid cell to patch a desired channel.

In this example, press the grid cell in which the input port (M1/RYSLOT1/1) and input channel (CH 1) intersect.



Patching the output ports

Follow the steps below to patch output channels to the output ports to which the speaker system was connected as described in the “Connecting the devices” section.

NOTE

The PATCH screen displays the input and output ports assigned to the TWINLANe network.

1 Press the PATCH button on the menu bar in the touch screen.

The PATCH screen will appear.

2 Press the OUTPUT tab.

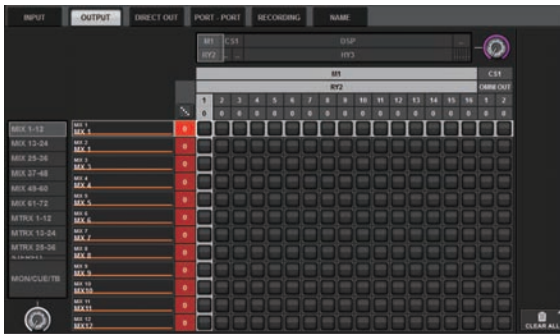

3 Use the knob in the upper right to display the desired output ports.



NOTE

Press the knob you want to control on the touch screen so that you will be able to control it using the [TOUCH AND TURN] knob.

For RY card slot 2 on the I/O rack (M1), M1/Ry2 will be displayed.

4 Use the knob in the lower-left corner to display the output channels.



5 Press the desired grid cell to patch a desired channel.

In this example, press the grid cells in which the output ports (M1/RYSLOT2/1,2) and output channels (ST A L, R) intersect.



Specifying the analog gain for the HA (head amp)

Follow the steps below to adjust the analog gain for the HA (head amp) which was patched to the input channel as described in the “Patching the input ports” section.

- 1 In the channel strip section on the top panel, press the [SEL] key for the channel that corresponds to the input jack (to which the microphone is connected).**



- 2 While talking to the microphone, rotate the [ANALOG GAIN] knob in the Selected Channel section to adjust the head amp gain.**

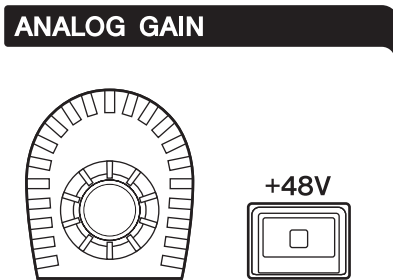

You can view the level on the meters in the METER screen.

- 3 If you are using a microphone that requires phantom power, press the [+48V] key to turn the phantom power on.**

NOTICE

- **<About phantom power>**
- To use the phantom power, you must turn on the phantom power master switch on the I/O rack. If you do not need to use the phantom power, turn the [+48V] key off.
- If you use the phantom power, follow the precautions below to avoid noise or damages to the unit or external devices.
- If you connect a device that does not support phantom power, be sure to turn the phantom power off.
- Do not connect or disconnect cables while the phantom power is on.
- When you turn the phantom power on or off, make sure that the output level controls are set to minimum.

Routing a signal to the STEREO bus

Follow the steps below to route the input channel signals to the STEREO bus.

- 1 In the channel strip section on the top panel, press the [SEL] key for the target input channel.**



- 2 Make sure that the TO ST [A] key in the Selected Channel section is turned on.**
TO ST

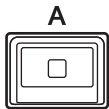

If the TO ST [A] key is turned off (its LED is off), press the key to turn it on (the LED lights up).

- 3 Make sure that the [ON] key for the target input channel is turned on.**



If the [ON] key is turned off (its LED is off), press the key to turn it on (the LED lights up).

- 4 Make sure that the [ON] key for the STEREO A channel on the top panel is turned on.**



5 Raise the main fader for the STEREO A channel up to 0 dB.

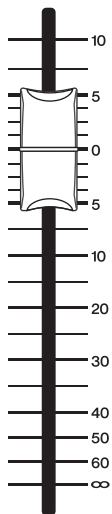

6 Raise the input channel fader to the appropriate volume level.

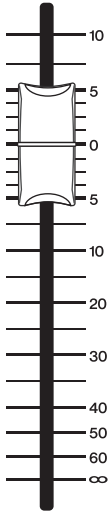

At this point, you should be able to hear sound from the speaker system (that is patched to the STEREO A channel). If no sound is heard, check to see whether the meters are moving in the METER screen.

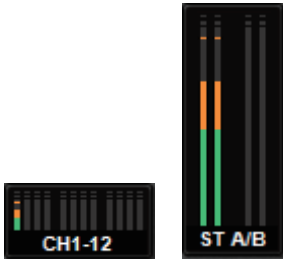

If the input meters are not moving

Make sure that signals are being input correctly to the patched input channels.

If the meters are moving but no sound is heard

The output ports (to which the speaker system is connected) might not be patched correctly. Check the patching status of the output ports.

- 7 To adjust the balance of the signal routed from the input channels to the STEREO bus, rotate the [PAN/BAL] knob in the Selected Channel section.**

PAN/BAL

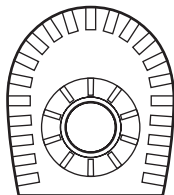

Network and Connections

About the TWINLANe Network

TWINLANe is a proprietary Yamaha network protocol for transferring multiple channels of digital audio and control signals simultaneously over a single cable. TWINLANe allows low-latency transfer of up to 400 audio channels, and enables sharing between all devices on the network. Input signals can also be shared between multiple DSP engines. Ring topology allows redundancy that will keep the network running even if a cable fails.

TWINLANe network

Transmitted data	400 channels of audio, control signals
Sampling frequency	44.1 kHz, 48 kHz, 88.2 kHz, 96 kHz
Network latency*	11 sample @ Fs = 44.1 kHz (0.25 msec)
	11 sample @ Fs = 48 kHz (0.23 msec)
	12 sample @ Fs = 88.2 kHz (0.14 msec)
	12 sample @ Fs = 96 kHz (0.13 msec)
Bit-length	32-bit
Topology	Ring

* If the number of connected devices is much larger, or if the total length of all cables is too long, the listed value may not apply.

NOTE

Use Neutrik opticalCON DUO multi-mode optical fiber cables. Optical fiber cable is easily damaged by bending and pulling. Using cable that has a locking mechanism and strong insulation can help to reduce trouble.

Cleaning

Correct communication might not be possible if debris and/or dust has adhered to the ends of optical fiber cables or the connectors. Clean the equipment regularly by using commercially available optical fiber cleaning products.

Connecting a TWINLANe network card

The TWINLANe network card can be used with the RIVAGE PM series.

TWINLANe network card	HY256-TL	HY256-TL-SMF
Connection cable	Multi-mode optical fiber cable	Single-mode optical fiber cable
Maximum cable length between devices	300 meters maximum	2 km maximum
Maximum number of channels	256 in / 256 out	256 in / 256 out

To connect devices, first install a TWINLANe network card in an HY card slot of each device, then use fiber optic cables to connect the TWINLANe network cards in a ring network topology.

NOTE

- Do not install both an HY256-TL-SMF and HY256-TL cards on a TWINLANe network.
- If you use an HY256-TL-SMF card, make sure that the total length of all cables is 6km or less.

Ring connection

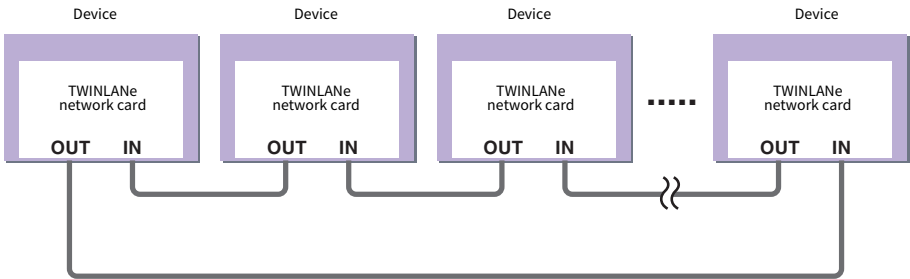

If a cable in the network breaks down for some reason, the signal will be automatically re-routed and audio will flow without interruption. Even if a device in the network malfunctions, other working devices will be able to continue communicating.

• Normal situation

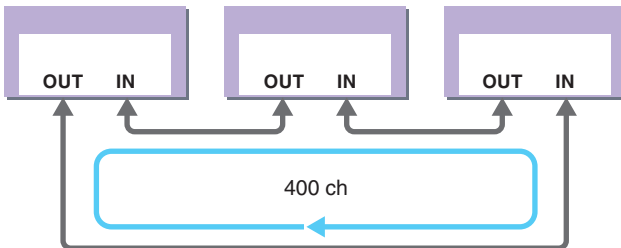

• When a cable is broken

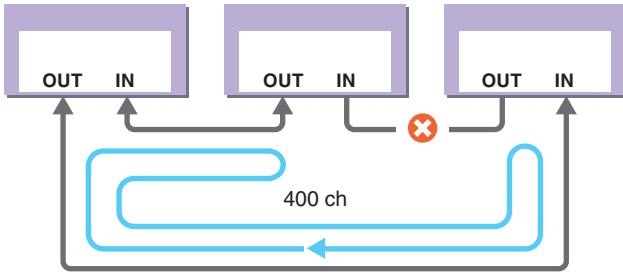

Even if a cable is severed at one point, the signal will be re-routed automatically and communication will continue without interruption.

In RIVAGE PM system version 2 and later, you can make settings for two TWINLANe networks (MAIN and SUB). This is convenient if I/O racks are located in numerous places such that eight RPiO units are insufficient, or if you want to divide the administration of a large system for simplicity. The following settings are required in order to provide the appropriate word clock to the system.

- Share TWINLANe (MAIN) network between all DSP engines.
- Connect the TWINLANe (MAIN) network only to HY card slot 1 of each DSP engine, and set the UNIT ID of the RPiO only to M1–M8.
- Connect the TWINLANe (SUB) network only to HY card slot 2 of each DSP engine, and set the UNIT ID of the RPiO only to S1–S8.
- Specify LEADER as the WORD CLOCK setting of the DSP engine of the lowest UNIT ID in the network, and specify FOLLOWER for other DSP engines.

Signal flow within the RPiO

The following diagram shows the signal flow within the RPiO.

Mode 1

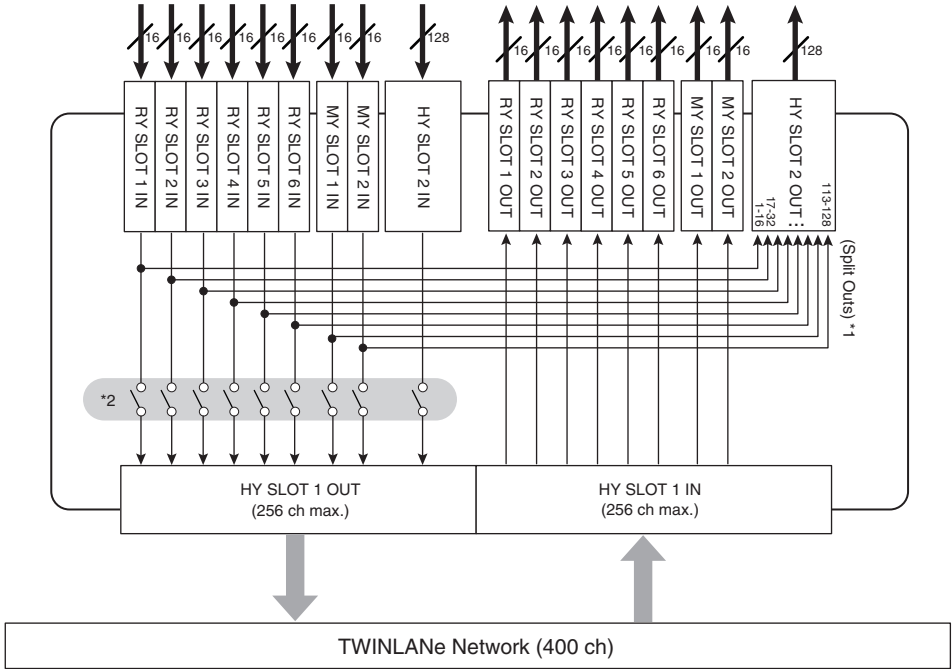

*1) In mode 1, all input signals (total 128 channels) of the RY slots and MY slots are always split for output to the HY SLOT 2 output. The signal is output immediately after gain compensation.

*2) Specifies the number of channels that are output to the TWINLANe network (turn on/off in 16-channel units for each slot).

Mode 2

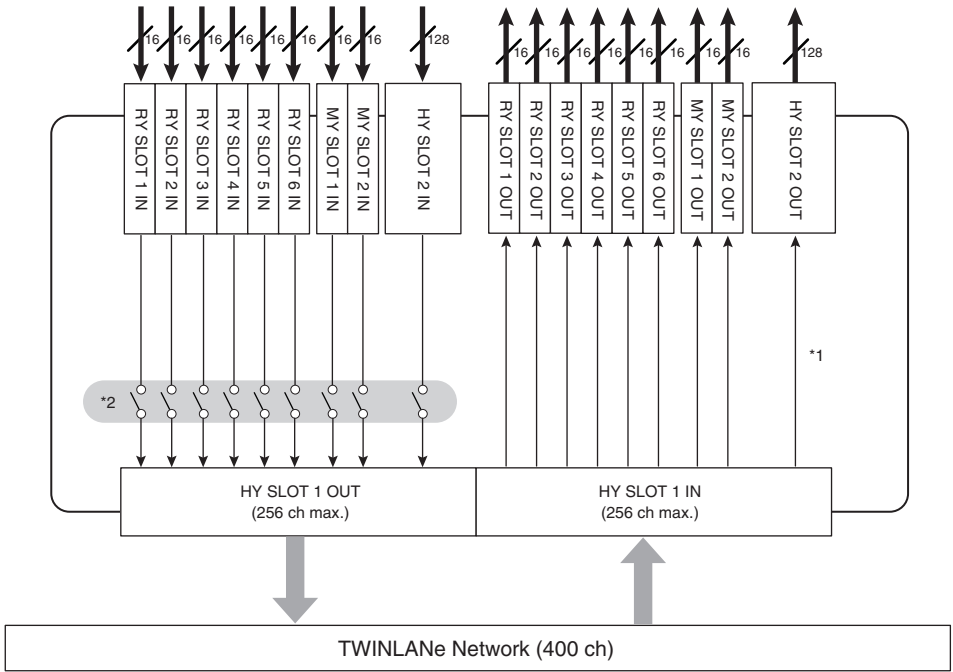

*1) In mode 2, you can patch signals from the DSP engine to the HY SLOT 2 output via the TWINLANE network.

*2) Specifies the number of channels that are output to the TWINLANE network (turn on/off in 16-channel units for each slot).

About Connections

The diagram below shows typical connections for the RIVAGE PM series. Equipment can be combined in various ways to construct small systems or large systems.

• Connecting the control surface and DSP engine (Console Network)

A DSP engine has a dedicated connector (TO CONSOLE) for connection to the control surface. A network created by the control surface and a DSP engine is called a “Console Network.” The Console Network is connected as a ring. This provides redundancy for both audio signals and control signals.

• Connection between DSP engines and I/O racks (TWINLANE Network)

A DSP engine and an I/O rack are connected via a TWINLANE network, using HY card slot 1. The TWINLANE Network is connected as a ring. For each ring, a maximum of four (in a DSP mirroring configuration, a maximum of eight) DSP engines and a maximum of eight I/O racks can be connected.

About the HY card slots

- 1 Each HY card slot 1 – 4 is 256-in/out. A TWINLANE network card will work exclusively in HY card slot 1 or 2 on the DSP engine (or HY card slot 1 on the CSD-R7). The multitrack recording function will work exclusively in HY card slot 4 (or HY card slot 3 on the CSD-R7).
- 2 HY card slot 1 of the I/O rack is only for a TWINLANE network card. HY card slot 2 is reserved for Dante/MADI/WSG-HY128. HY card slot 1 is 256-in/out, and HY card slot 2 is 128-in/out.

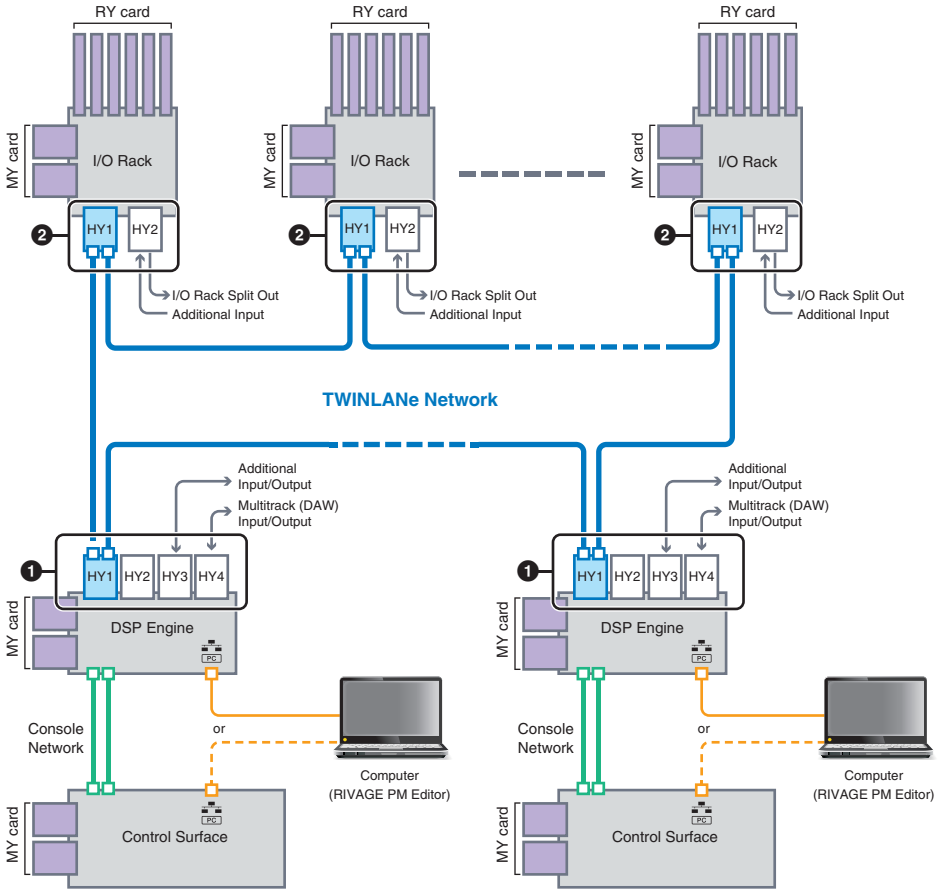

Ethernet connection

Ethernet cable (CAT5 or better) (maximum 100 meters)



Console Network

Ethernet cable (CAT5e or better) (maximum 100 meters)

* etherCON connectors made by Neutrik are recommended.



TWINLANe Network

Multi-mode optical fiber cable (maximum 300 meters between devices)

Single-mode optical fiber cable (maximum 2km between devices)

* LC Duplex connectors compatible with Neutrik's opticalCON are recommended.

System configuration example

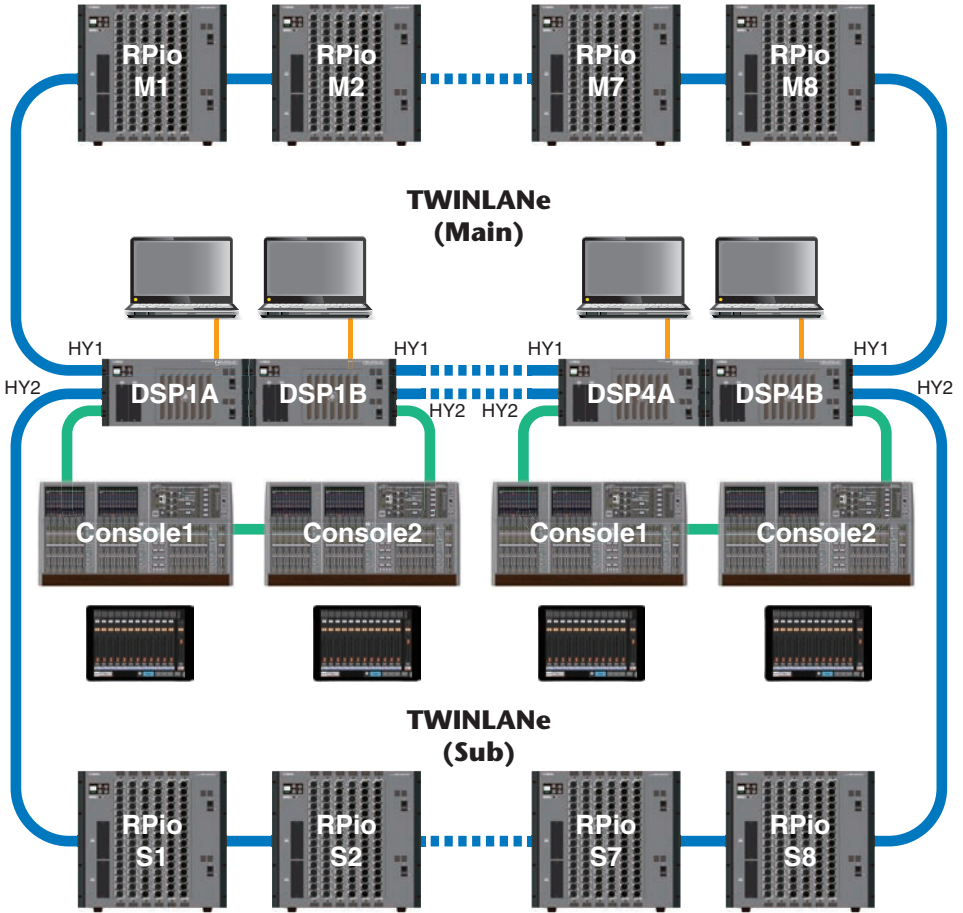

The ID settings of components are shown below.

CS-R10, CS-R10-S, CS-R5	DSP-RX, DSP-RX-EX, DSP-R10	CSD-R7	CSD-R7	RPiO
Console ID	Unit ID	Unit ID	INTERNAL DSP ID	Unit ID
1, 2	1, 2, 3, 4 (In a DSP mirroring configuration, 1A/1B-4A/4B)	1	1, 2, 3, 4	M1, M2...M8 S1, S2...S8

About Dual Console

The system can be configured with two control surfaces connected to the DSP engine(s). The two control surfaces (the main CS-R10 and the sub CS-R10-S) can be placed side by side to expand the number of faders, or can be used by two operators in the FOH position of audience seating and in a sound booth. It is also possible to add a single CS-R10 or CS-R10-S unit to the CSD-R7. When connecting two control surfaces, you'll need to assign each to a different ID. (SETUP screen)

TWINLANe mirroring

In a mirroring configuration, the DSP engine that is performing the system's audio processing is said to be in the "active" state, and the DSP engine that is waiting as a backup is said to be in the "standby" state. When starting up in a mirroring configuration, the default is that A starts in the active state and B starts in the standby state. The DSP engine that is running in the standby state synchronizes to the parameters of the DSP that is running in the active state.

When the active DSP engine stops operating and the standby DSP engine fails-over (automatically switches to the backup system when an accident occurs), synchronization processing is performed but the sound is not interrupted. Depending on the reason that the active DSP engine stopped operating, there might be cases in which failover will not occur. In such cases, you'll need to switch systems manually. Even in such cases, synchronization processing occurs automatically. Whether the audio is interrupted will depend on the state in which the active DSP engine's operation stopped. We cannot guarantee that the audio will be uninterrupted.

Even if failover occurs, the active DSP engine that is the word clock leader will continue operating as long as the word clock continues to be supplied.

NOTE

Do not turn off the power of the active DSP engine. If the power is turned off, the audio will be interrupted. If word clock supply from the active DSP engine that is the word clock leader is interrupted, the standby DSP engine automatically becomes the substitute wordclock leader. However, the audio is interrupted during this switch.

The indicator above the DSP popup button in the SYSTEM CONFIG screen (see the SYSTEM tab) shows which DSP engine (A or B) is the word clock leader.

After failover, if the replacement unit provided for A (the active DSP engine) and unit B (the standby DSP engine) that was operating after the failure are operating simultaneously, the parameters that had been edited on unit B will be lost. In the state where DSP engines A and B are each operating as the word clock leader, and mirroring is occurring, both units are set as the word clock leader. In this case, one unit must be removed from being a word clock leader. Since this operation cannot be performed from the panel of the control surface, it must be performed from the front panel of the DSP engine.

**** [ERR T13]
MULTI LEADERS
PRESS [ENTER]**

** Unit ID



Press the [ENTER] key.

**Press [ENTER]
TO WORD CLOCK
FOLLOWER**



Press the [ENTER] key.

**SOUND MAY
STOP OK?
[ENTER] IF OK**

About DSP mirroring

The system can be configured with two DSP engines as a set, providing resilience against unexpected software failures or hardware malfunctions that would not be addressed by the redundant power supplies of the units or by TWINLANe cable redundancy.

There are two types of DSP mirroring: TWINLANe MIRRORING configured in the TWINLANe network and PARAMETER MIRRORING configured in the Dante audio network.

Requirements for mirroring

- The two DSP engine units are of the same model
- The two DSP engine units have the same version
- The Unit IDs of the two DSP engines are set to A and B of the same number (example: 1A, 1B)
- The two DSP engine units are set to the same Unit Mode
- The two DSP engine units have the same card configuration (Mini-YGDAI cards, HY cards)

The following conditions are also required only for TWINLANe MIRRORING.

- The TWINLANe networks of the two DSP engine units have the same ring connection settings (MAIN and SUB)
- The connected RPio has the same configuration (version, Unit ID, etc.)

If the DSP mirroring conditions do not match, the DETAIL button will appear in the DSP pop-up button on the SYSTEM tab. When you press the DETAIL button, the items that do not match are displayed in red.

TWINLANe MIRRORING

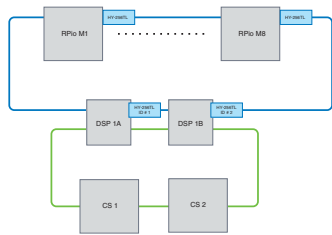

Parameters and TWINLANe network patches will be synchronized.

PARAMETER MIRRORING

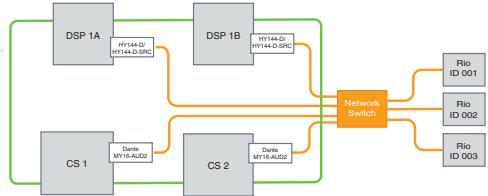

The parameters are periodically synced from the active DSP engine to the standby DSP engine.

DSP mirroring settings

- 1 Press the [MENU] key on the front panel of the active DSP engine.**
- 2 Press the [▲]/[▼] keys to move the cursor to “Unit ID.”**
- 3 Press the [ENTER] key.**

- 4 Use the [▲]/[▼] keys to select the DSP engine to be mirrored.**

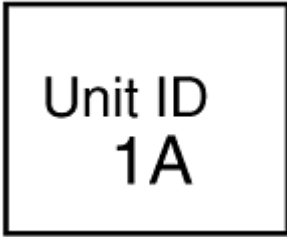

NOTE

If the Unit ID of the DSP engine does not support mirroring, the Unit IDs that can be set (1A, 1B, etc.) will not be displayed.

- 5 Press the [ENTER] key.**
- 6 Use the [▲]/[▼] keys to select the desired mirroring mode.**



- 7 Press the [ENTER] key.**
- 8 The DSP engine will restart.**

The Mirroring mode is displayed in the indicator of the SYSTEM tab.

The active DSP engine can be switched with the active/standby switch button or the DSP popup button.

The Mirroring mode is displayed at the bottom of the DSP engine LCD screen.

1A
TL MIRROR

The image shows a large, bold, black '1A' at the top, with 'TL MIRROR' in a smaller, bold, black font directly below it. This represents the mirroring mode displayed on the DSP engine LCD screen.

Parameter mirroring

Parameter mirroring only synchronizes the parameters between the two DSP engines. When the DSP engine fails over, patches for the Dante audio network do not switch automatically, so you will need to make separate settings.



Mirror MODE 2 PARAM MIRROR

Please set the input patch to the Dante card HY144-D, HY144-D-SRC inserted in the active DSP engine and the standby DSP engine beforehand. Also, make sure that the control IDs for the active DSP engine and standby DSP engine do not overlap, and make the same With Recall settings for both DSP engines. Perform output patch from the Dante card (HY144-D, HY144-D-SRC, Dante MY16-AUD card) inserted in RPi0622/222. These settings ensure uninterrupted audio input/output and HA control in the event of a failover. We recommend setting up a word clock leader on the Dante audio network. Since the word clock is maintained even when the power of the active DSP engine is cut off, the dead sound period can be shortened. Note that the Dante patch of the Dante card HY144-D, HY144-D-SRC inserted in the standby DSP engine cannot be set in advance, so it must be switched manually after failover. Also, HA control can be performed only from the Dante card HY144-D, HY144-D-SRC inserted in the DSP engine. The MY card and OMNI IN / OUT signals inserted in the control surface are automatically switched. However, please note that if you turn off the active DSP engine before switching, the audio will stop.

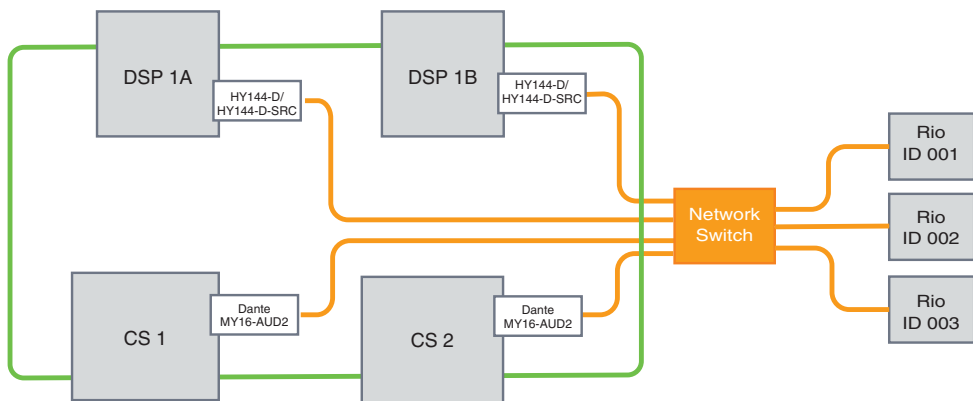

Verifying the DSP mirroring operation

This verification function is available only while two DSP engines are in mirroring status. The function involves virtual stoppage of the DSP engine operation. Use this function to verify the system during the set-up process.

An example of mirroring check-up

While DSP A is in the active state, start the mirroring check operation on DSP A to make sure that failover to DSP B (which is in the stand-by state) will occur. (Failover: a method of protecting the system from failure, in which standby equipment automatically takes over when the main system fails.)

Starting the mirroring check operation

- 1 Press the [MENU] key on the front panel of the active DSP engine.**
- 2 Use the [▲]/[▼] keys to select “Mirr Chk.”**

NOTE

If the Unit ID for the DSP engine does not support mirroring, “Mirr Chk” will not appear.

- 3 Press and hold down the [ENTER] key.**



- 4 If “DONE” appears, you can verify the DSP’s mirroring operation.**

Completing the mirroring check operation

Turn the power to the two DSP engines off and then on.

If both DSP engines become the word clock leader after the mirroring operation, you must cancel the status of the word clock leader on one of them. Since this operation cannot be performed from the panel of the control surface, it must be performed from the front panel of the DSP engine.

NOTE

Even if the active DSP switches from DSP A to DSP B, you must turn off the power to DSP A to change the word clock leader status. Unless the active DSP engine is switched from DSP B to DSP A, the word clock leader status will not change. When you turn on the power to both DSP engines again, DSP A will become active. Please note that the edited data on DSP B will be lost unless you save it first.

Make RPi0622 / 222 a word clock leader

Make RPi0622 / 222 a word clock leader

You can make the DSP engine a follower by making the RPi0 the leader of the TWINLANe Network.

As a result, after the active DSP engine (A) freezes and switches to the standby DSP engine (B), the sound will not be interrupted even if the DSP engine (A) is restarted. Using "“Forced switching by GPI connection between DSPs” (p.211)" can shorten the sound interruption time when the power of the active DSP engine is cut off as much as possible.

- 1 Press the [MENU] key on the front panel of the RPi0 622/222.**
- 2 Press the [▲]/[▼] keys to move the cursor to “Word Clk.”**
- 3 Press the [ENTER] key.**
- 4 Press the [▲]/[▼] keys to select the clock source.**



INTERNAL 96kHz, INTERNAL 88.2kHz, INTERNAL 48kHz, INTERNAL 44.1kHz

The built-in clock (sampling frequency 96kHz, 88.2kHz, 48kHz, 44.1kHz) is used as the clock source. The RPi0 is the leader.

WORD CLOCK IN

The word clock supplied from the WORD CLOCK IN terminal on the rear panel is used as the clock source. The RPi0 is the leader.

HY Slot1

Default configuration. The other device is the leader and the RPi0 is the follower.

- 5 Press the [ENTER] key.**
- 6 Select FROM HY SLOT 1 of the leader clock selection button on the WORD CLOCK popup screen on the control surface.**

Forced switching by GPI connection between DSPs

In DSP mirroring, sound interruption occurs when the power of the active DSP engine is cut off. In order to shorten the sound interruption time as much as possible, GPI connection is enabled between DSPs and the DSP engine is forcibly switched.

The procedure for using GPI IN1 and GPI OUT1 is described below. The GPI wiring and GPI settings that achieve the same operation can be forcibly switched.

NOTE

Note that if a forced switch occurs to the standby DSP engine when the active DSP engine is not turned off, multiple clock leaders will exist, and control will be lost. If this happens, turn off the power of either DSP engine to recover control..

■ When using GPI IN1 and GPI OUT1

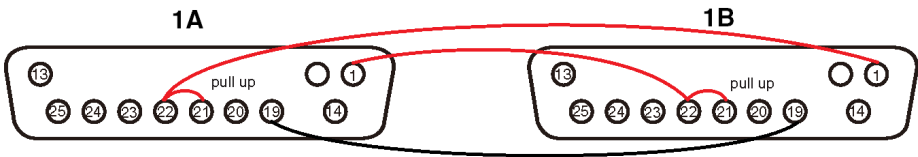

- 1** Connect the GPI terminals between DSPs that perform the TWINLANe mirroring.
- 2** Turn on the power and put it in the DSP mirroring state.
- 3** Set the GPI to the following for both the active DSP and standby DSP.

NOTE

If DSP mirroring is enabled, the settings made to the active DSP engine will also be reflected in the standby DSP engine.

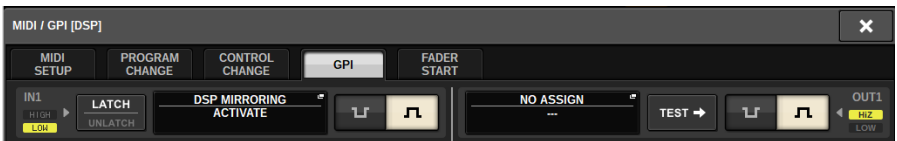

- 1) Set both GPI IN1 and GPI OUT1 to NO ASSIGN.
- 2) Change both GPI IN1 and GPI OUT1 to HI active.
- 3) Assign DSP MIRRORING-- ACTIVATE to GPI IN1.

NOTE

Due to the GPI connection between DSP engines and the GPI setting, when the power of the active DSP engine is turned off, GPI IN 1 of the standby DSP engine becomes HI and immediately switches to active. After that happens, manually synchronize the configuration data.

About Dante

Dante is a network audio protocol developed by Audinate. It is designed to deliver multi-channel audio signals at various sampling and bit rates, as well as device control signals over a Giga-bit Ethernet (GbE) network.

Visit the Audinate website for more details on Dante.

<http://www.audinate.com/>

More information on Dante is also posted on the Yamaha Pro Audio website:

<http://www.yamahaproaudio.com/>

Precautions for using a network switch

Do not use the EEE function (*) on the network switch within a Dante network. Some switches that support the EEE function automatically adjust mutual power consumption settings. However, some switches may not adjust these settings correctly. In that case, the EEE function of the network switch might become active inadvertently at certain inappropriate times within Dante network. This could lead to deterioration of the clock sync performance, resulting in audio interruption.

To avoid this kind of situation, follow the precautions below:

- If you plan to use a managed switch, turn off the EEE function for all ports that are connected to the Dante network. If you cannot turn off the EEE function on the switch, do not use the switch.
- If you plan to use an unmanaged switch, do not use a switch that supports the EEE function. You will be unable to turn off the EEE function on such a switch.

* EEE (Energy Efficient Ethernet) function is a technology that is designed to reduce power consumption in Ethernet networks during the idle periods or periods of low utilization. It is also called "green Ethernet" or an IEEE802.3az standard.

Connecting to a Dante network

There are two ways to connect this product model to a Dante network. For more information on how to connect and set up Dante devices, refer to the Dante audio network settings section.

NOTE

A daisy chain connection is used to connect fewer simple devices. If you want to connect several devices, a star topology is recommended.

Daisy chain connection

In a daisy chain connection, multiple devices are connected together in sequence. Configuring a daisy chain network is simple and does not require network switches. If many devices are to be connected, the transmission delay between the end devices increases. To avoid audio interruption on the Dante network, a greater latency must be configured. Also, if a system problem occurs due to a broken cable, the network will be disrupted at that point, and signals cannot be transferred beyond the point.

Star topology

In a star topology, all devices are individually connected to a central network switch. Using a network switch that supports gigabit Ethernet can handle a large-scale network that requires a broad bandwidth. It is recommended to use a network switch that features various functions to control and monitor the network (such as a clock synchronization function for certain data circuits, or QoS that provides prioritization of audio traffic). With this topology, in general, a redundancy network should be configured to set up an environment that maintains quality communications without affecting audio quality.

Redundancy network

A redundancy network consists of the primary circuit and the secondary circuit. Normally, the primary circuit is used for transmission. If a problem occurs in this primary circuit, such as a broken cable, the secondary circuit will automatically take over the transmission. A star topology featuring a redundancy network will enable you to establish an environment that is resilient against network troubles, contrary to a daisy chain network.

NOTE

- If you have been using the HY144-D card on a system older than the RIVAGE PM10 V1.51, you need to update the HY144-D firmware. Details on updating the firmware are available on the following Yamaha Pro Audio website:
- <http://www.yamahaproaudio.com/>

DSP mirroring function in the Dante audio network

If the active DSP engine fails over, the stand-by DSP engine will take over all I/O patches for the TWINLANE network, and the audio will continue without interruption. However, patches for the Dante audio network will not switch over automatically. So, you need to make settings so they will switch over. First, assign input patches to the Dante cards (HY144-D, HY144-D-SRC) that have been installed in the active DSP engine and the standby DSP engine. Also, make sure that the control IDs for the active DSP engine and standby DSP engine are unique, and specify the same With Recall setting on both DSP engines. Assign output patches from the Dante card (HY144-D, HY144-D-SRC, or Dante MY16-AUD card) that was installed on the RPio622/222. With these settings, audio input and output, and HA controls will be kept uninterrupted even if failover occurs. Meanwhile, you cannot set up Dante patches for the Dante card (HY144-D, HY144-D-SRC) installed on the standby DSP engine in advance. Therefore, you need to prepare a Dante Preset in advance, and you would need to manually switch to this preset in case of failover. Please note that HA controls are available only from a Dante card (HY144-D, HY144-D-SRC) inserted into the DSP engine.

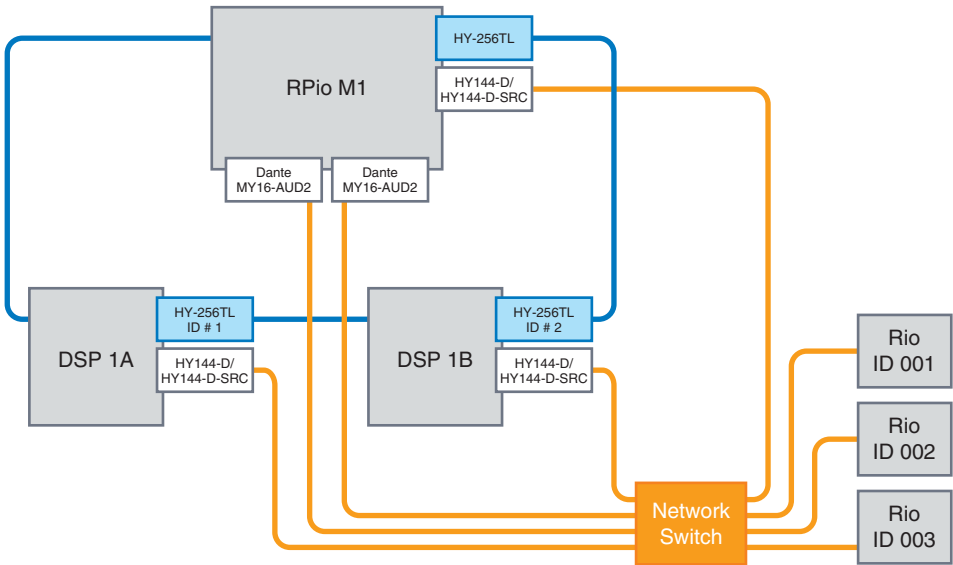

Word clock in the RIVAGE PM series

On a TWINLANe network, only one DSP engine is the leader for one network. If two or more DSP engines exist on a single network, one is the leader and the other units are followers. For the leader clock on a TWINLANe network, you can select either the DSP engine’s internal clock (44.1 kHz, 48 kHz, 88.2 kHz, or 96 kHz), or the external word clock that is input at the WORD CLOCK IN connector on the rear panel of the leader DSP engine. If using the Dante audio network, you can also select HY SLOT as the leader clock. Since I/O racks always use the word clock that is being sent over the TWINLANe network, there is no need to specify their word clock source. (I / O racks on the TWINLANe (Main) network can also be set as the leader clock from V5.)

If INT (INTERNAL) or WORD CLOCK IN is selected

The DSP engine will be the clock leader for the TWINLANe network

If HY SLOT 1 is selected

The DSP engine will be the clock follower of the TWINLANe network

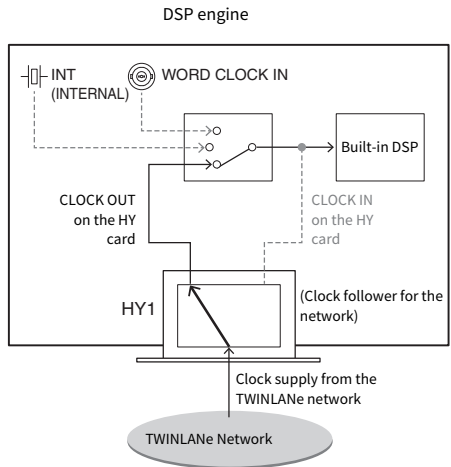
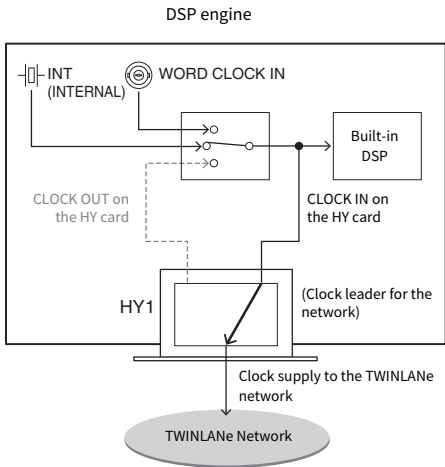

About the sampling rate converter (SRC)

SRC is built into all input and output channels (one SRC for every two channels) of the AES/EBU jacks on the rear panel of the control surface and of the RY16-AE. This allows digital signals that are not synchronized to the RIVAGE PM series to be input and output.

SRC block diagram

SRC block diagram

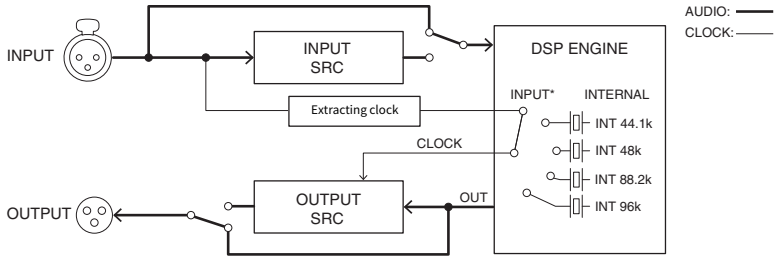

The input SRC converts the signal to the system clock of the RIVAGE PM series. The output SRC converts the signal to the specified internal clock source or to the same clock as the input of the same channel.

* Only the corresponding input channels can be selected (if OUT1/2, then IN1/2). For example, IN7/8 cannot be used for OUT1/2.

About connecting a computer

You can connect a computer with PM Editor installed to a DSP engine. To do so, connect the computer to the NETWORK connector [PC] located next to the TO CONSOLE connector. Do not connect it to the NETWORK connector located above the HY card slots. Alternatively, you can use the NETWORK connector on the control surface. However, in this case, please note that the computer will be unable to communicate with the DSP engine if the power to the control surface is turned off.

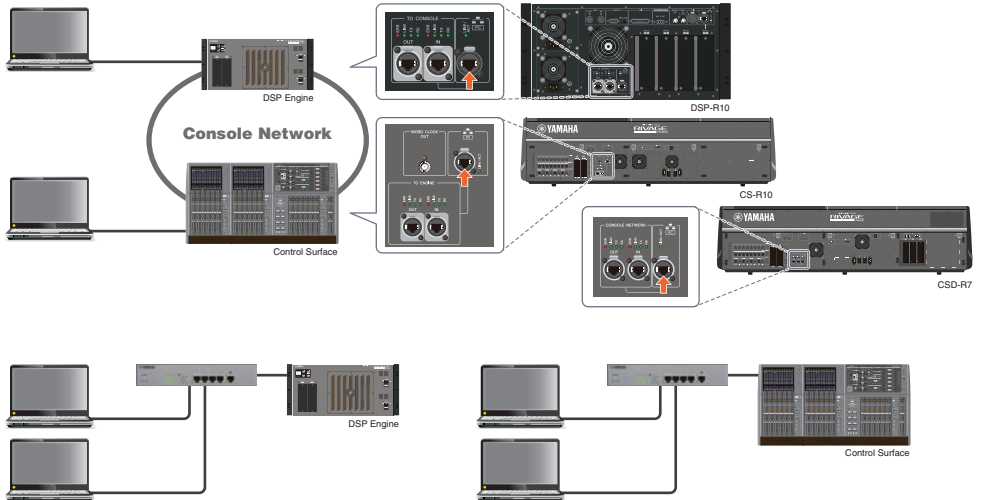

If you want to connect two computers to a DSP engine or control surface, use a switching hub to make connections.

Bay

About bays

A bay consists of a group of 12 faders located across the Touch Screen section and the Channel Strip section. The CS-R10 and CSD-R7 have three bays; the CS-R10-S has two bays. You can operate these bays independently. Therefore, you can perform mixing operations, such as recalling settings to the touch screen or switching between 12-fader layers on a bay, without affecting the settings on other bays. Please note that unlike bay L and bay C, bay R does not feature a touch screen or screen encoders beneath it. If you connect an external screen monitor, you will be able to use it exclusively for bay R. The external monitor will display content similarly to bay L and bay C, except that it will display a layer or channels that are selected on bay R.

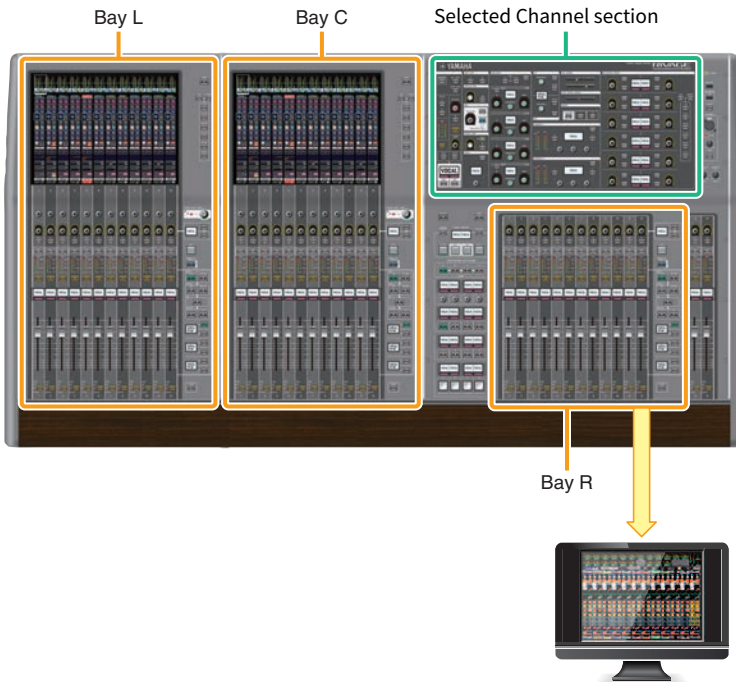

Faders and fader layers

Selecting a layer

Twelve faders are arranged into layers, as illustrated below. You can use the Layer Select keys to the right of the faders to recall the channels to edit. There are two layer types: base layer and custom layer.

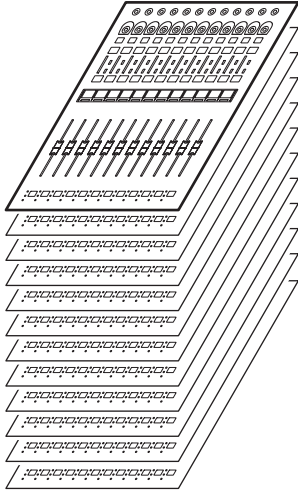

Base layer

A base layer features mixer channels lined up in the fixed order of channels.

Input [1-12], [13-24] ... [277-288]: total 24 layers

Mix [1-12], [13-24] ... [61-72]: total 6 layers

Matrix [1-12], [13-24] ... [35-36]: total 3 layers

Stereo [A/B]: total one layer

CUE [A/B], MONITOR [A/B]: total one layer

DCA [1-12], [13-24]: total 2 layers

Custom layer

A custom layer contains 12 faders to which you can assign channels. You can assign 30 layers (5 banks x 6 layers) of custom faders for each bay independently.

For input channels/output channels/DCA/custom channel, use the LAYER keys to select a layer. The Layer Select key of the currently-selected layer will light up, and the layer display will show the short names of the corresponding channels. For example, if you select LAYER [IN 1-12], you will be able to use the [SEL] 1 key to control input channel 1. If you select LAYER [IN 25-36], you will be able to use the same [SEL]1 key to control input channel 25.

■ CS-R10, CS-R10-S, CSD-R7

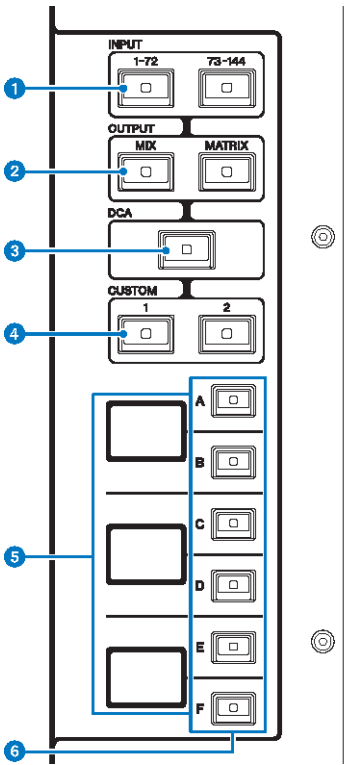

1 INPUT [1-72]/[73-144] keys

Enable you to select an input layer.

NOTE

Press the INPUT [1-72] key and INPUT [73-144] key simultaneously to select the INPUT 145-288 channel layer. Press these two keys simultaneously again to select the INPUT 1-144 layer.

2 OUTPUT [MIX]/[MATRIX] keys

Enable you to select an output layer.

3 [DCA] key

Enables you to select a DCA layer.

4 CUSTOM [1]/[2] keys

Enable you to select a custom layer. Generally, you can assign custom faders of two banks (total of 12 layers) to each custom layer.

5 Layer display

Indicates the selected layer.

6 Layer Select [A]/[B]/[C]/[D]/[E]/[F] keys

Enable you to select a layer. Different layers are recalled to the faders depending on the combination of the keys, as shown in the table below: (Please refer to the Note regarding the INPUT [1-72]/[73-144] keys.)

Key	INPUT [1-72] / INPUT [1-72]+INPUT [73-144]*	INPUT [73-144] / INPUT [1-72]+INPUT [73-144]*	OUTPUT[MIX]	OUTPUT[MATRIX]	[DCA]
[A]	Input 1-12 / 145-156*	Input 73-84 / 217-228	MIX 1-12	MATRIX 1-12	DCA 1-12
[B]	Input 13-24 / 157-168*	Input 85-96 / 229-240*	MIX 13-24	MATRIX 13-24	DCA 13-24
[C]	Input 25-36 / 169-180*	Input 97-108 / 241-252*	MIX 25-36	MATRIX 25-36	-
[D]	Input 37-48 / 181-192*	Input 109-120 / 253-264*	MIX 37-48	STEREO	-
[E]	Input 49-60 / 193-204*	Input 121-132 / 265-276*	MIX 49-60	CUE/MONITOR	-
[F]	Input 61-72 / 205-216*	Input 133-144 / 277-288*	MIX 61-72	-	-

■ CS-R5

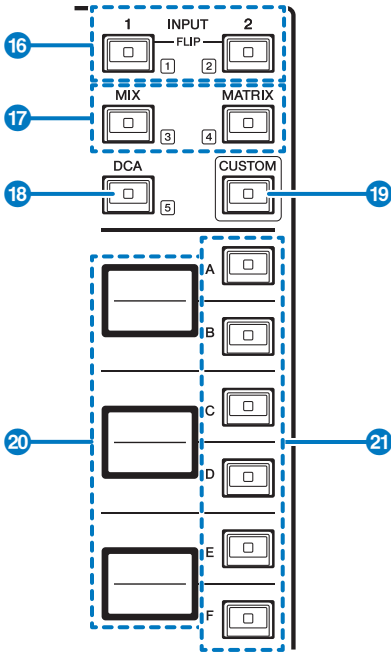

1 INPUT [1]/[2] keys

Enable you to select an input layer. Press the INPUT [1] key to select the INPUT 1-72 layer. Press the INPUT [2] key to select the INPUT 73-144 layer.

Press the INPUT [1] key and INPUT [2] key simultaneously to select the INPUT 145-288 layer. Press these two keys simultaneously again to select the INPUT 1-144 layer. When the INPUT 145-288 layer is selected, these key indicators light up in a different color than when the INPUT 1-144 layer is selected.

2 [MIX]/[MATRIX] keys

Enable you to select an output layer.

3 [DCA] key

Enables you to select a DCA bank.

4 [CUSTOM] key

Turns Custom fader mode on or off. Use the INPUT [1], [2], [MIX], [MATRIX], and [DCA] keys to select a Custom bank. The bank numbers (1–5) are labeled adjacent to these keys.

5 Layer displays

Indicates the name of the layer selected via the Layer select keys (see 21 on page 18).

6 Layer Select [A]/[B]/[C]/[D]/[E]/[F] keys

Enable you to select a layer. Different layers are recalled to the faders depending on the combination of the keys, as shown in the table below: (Please refer to the Note regarding the INPUT [1]/[2] keys.)

Key	INPUT [1] / INPUT [1]+[2]*	INPUT [1] / INPUT [1]+[2]*	[MIX]	[MATRIX]	[DCA]
[A]	Input 1-12 / 145-156*	Input 73-84 / 217-228	MIX 1–12	MATRIX 1–12	DCA 1–12
[B]	Input 13-24 / 157-168*	Input 85-96 / 229-240*	MIX 13–24	MATRIX 13–24	DCA 13–24
[C]	Input 25-36 / 169-180*	Input 97-108 / 241-252*	MIX 25–36	MATRIX 25–36	–
[D]	Input 37-48 / 181-192*	Input 109-120 / 253-264*	MIX 37–48	STEREO	–
[E]	Input 49-60 / 193-204*	Input 121-132 / 265-276*	MIX 49–60	CUE/MONITOR	–
[F]	Input 61-72 / 205-216*	Input 133-144 / 277-288*	MIX 61–72	–	–

Selected channel concepts

The RIVAGE PM series enables you to select a specific channel to control or for which to display mixing parameters.

Types of selected channels

The CS-R10 control surface enables you to select specific “independent” channels. This feature enables you to control multiple channels on a single control surface.

Selecting a channel by using hardware

You can select a specific channel for the Selected Channel section (hardware). You can also use [SEL] keys on each bay.

Selecting channels on screen (up to three individual channels)

You can also customize links between those on-screen selected channels on bay L, C or R (external display) of the CS-R10 or CSD-R7, or those on-screen selected channels on bay C or R (external display) of the CS-R10-S, and the ones selected via hardware keys, in accordance with your operational style.

Hardware [SEL] key

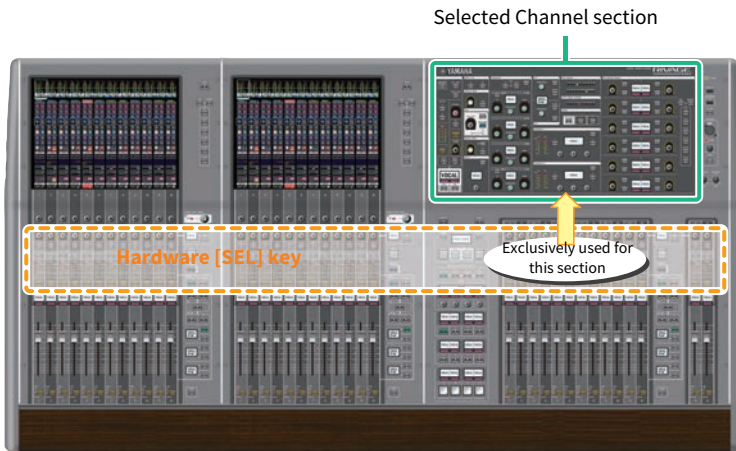

A [SEL] key is used to select the corresponding channel for the Selected Channel section (hardware). However, the [SEL] keys can also be linked to on-screen selected channels to assign channels to a DCA or mute group.

Selecting channels on screen

In addition to the Selected Channel section (hardware), the touch screen in each bay is useful for controlling parameters for one specific channel. One specific channel selected on each touch screen is called an “on-screen selected channel.”

You can select a channel on screen in one of the following ways:



- 1 **Press either side (+/- buttons) of the selected channel indication in the upper-left of the screen.**

Press the left side (-) of the selected channel indication to select the preceding channel. Press the right side (+) of the area to select the next channel.

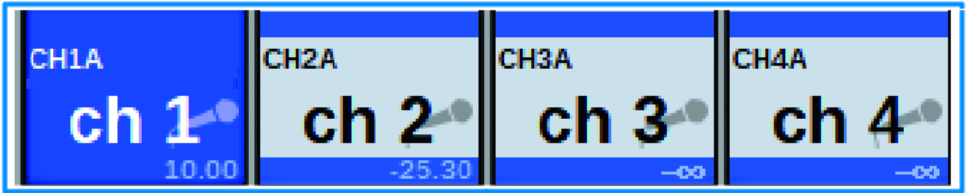

- 2 **Press the channel name area located at the bottom of the screen.**

Press the channel name repeatedly to switch the selected channel on screen. If you switch fader layers in the meter area, the channel name area will change the indication accordingly. In this way, you can access any channel on screen.

NOTE

If you use the [FADER BANK]>[SEL] LINK function specified in the PREFERENCES window, you will be able to automatically switch to the selected channel in each bank (a channel selected most recently) while switching between fader banks (Preferences Settings).

Bay > Selected channel concepts

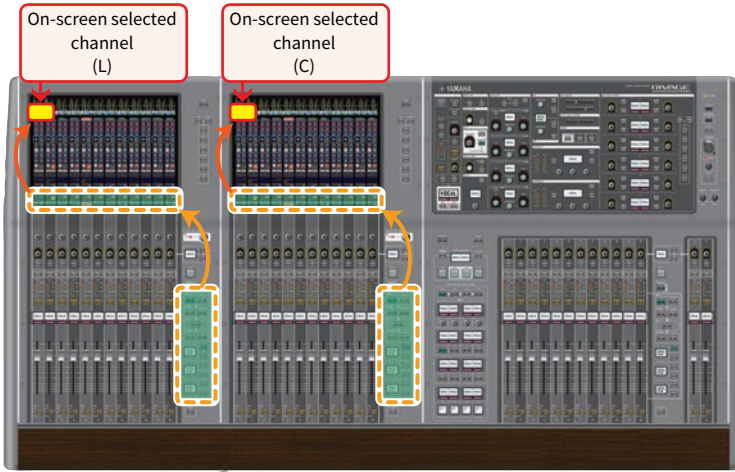

On-screen selected channel displayed on an external monitor

The on-screen selected channel on an external monitor screen also serves as the on-screen selected channel for bay R. In this way, if you use the external display and a USB mouse, you will be able to operate channel parameters on bay R in same way you do on bay L and bay C.

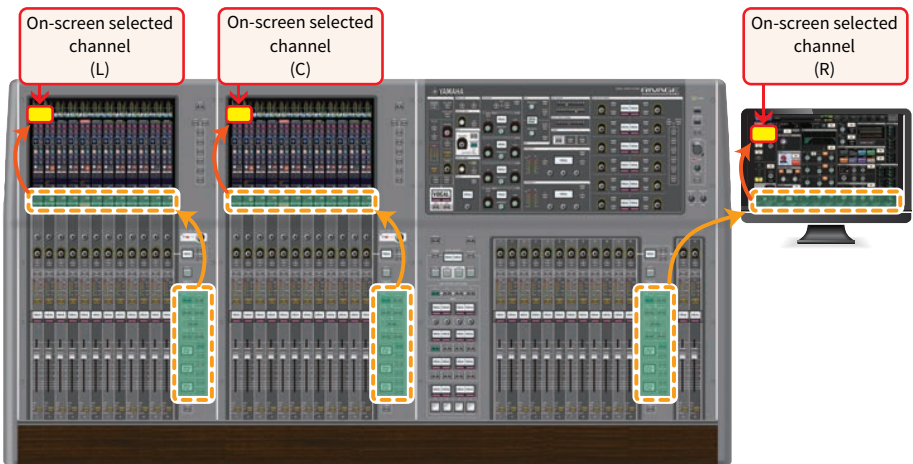

Linking selected channels

The PREFERENCES window enables you to set up a link between the selected channels/parameters on screen and the [SEL] keys (hardware), and to set up a link between each bay's [SEL] keys.

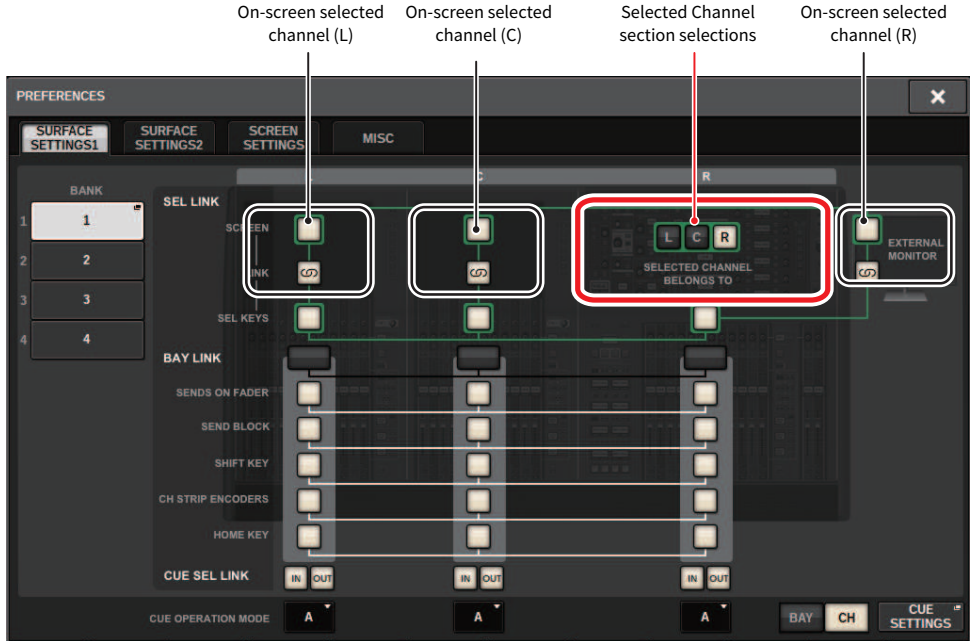

For more information on the buttons, refer to SURFACE SETTINGS 1.

- **SCREEN:** Links with the SEL between bays on the screen
- **LINK:** Links with the SEL on the screen and the [SEL] keys
- **SEL KEYS:** Links with the [SEL] keys between bays

BAY LINK

The BAY LINK function allows you to select and link layers from multiple bays on the control surface. Normally, each bay with 12 faders operates independently. However, using this function, you can link and use multiple bays as one bay that features up to 36 faders.

The functions to be linked can be set in the PREFERENCES pop-up window.

1 Press the **SETUP** button on the menu bar to open the **SETUP** window.

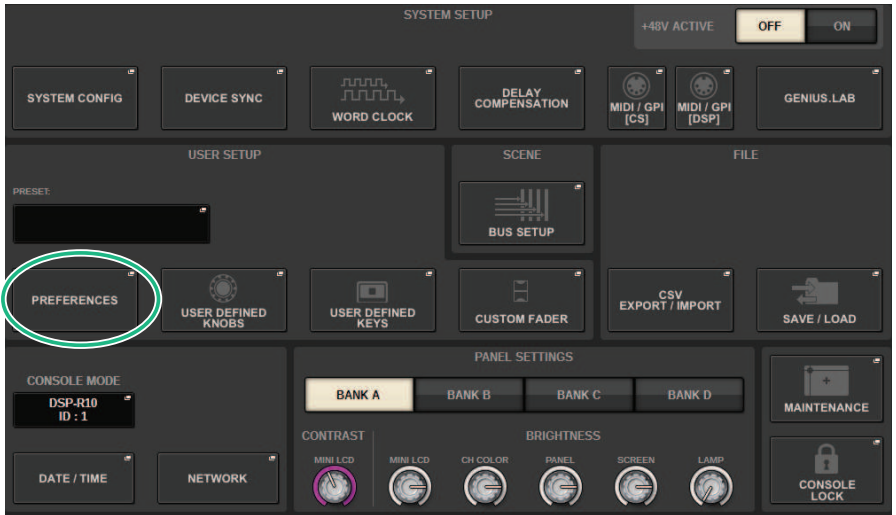

2 Press the **PREFERENCES** button to open the **PREFERENCES** popup window.

This window includes several pages, which you can switch between using the tabs located at the top of the window.

3 Press the SURFACE SETTINGS1 tab to open the SURFACE SETTINGS1 page.



See SURFACE SETTINGS1 for details about the buttons.

BAY LINK: Select the linked Bay settings and fader layer

SENDS ON FADER: Turns SENDS ON FADER on or off, sets send destination

SEND BLOCK: Select the send destination for 12 buses when selecting the OVERVIEW window

SHIFT KEY: Turn the [SHIFT] key on or off

CH STRIP ENCODERS: Switches the selection of the channel strip encoder

HOME KEY: Saves and recalls the [HOME] key setting

4 Selects the bays and functions you want to link.

Setting example

All Link... This is a setting for simple use by a single operator. You can control the specified channel from any location.



SEparate... This is another simple setting. Because separate channels can be selected for each Bay, up to three channels can be viewed and operated simultaneously.

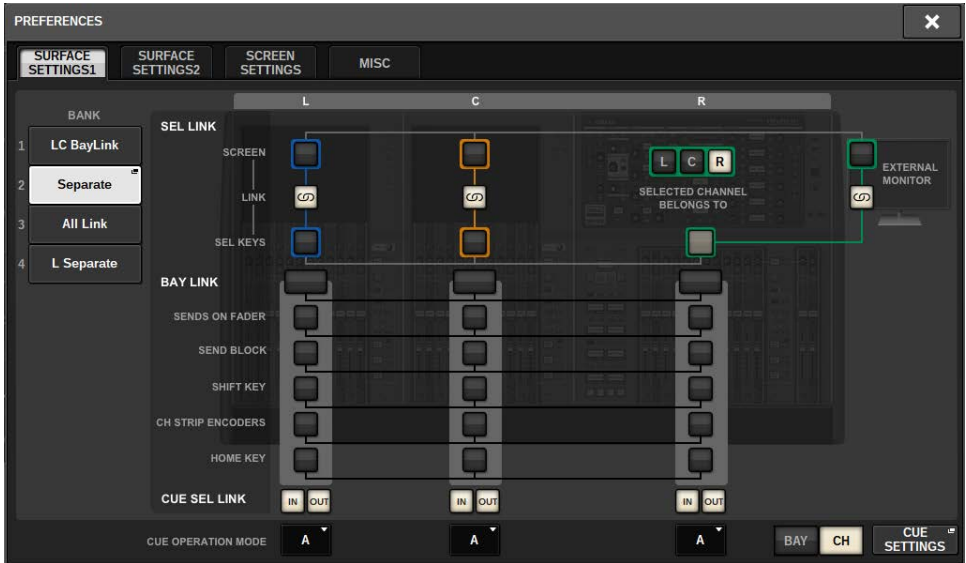

L SEparate... When working with 2 operators, this setting allows the person controlling Bay L to work without interfering with the person operating Bay CR.

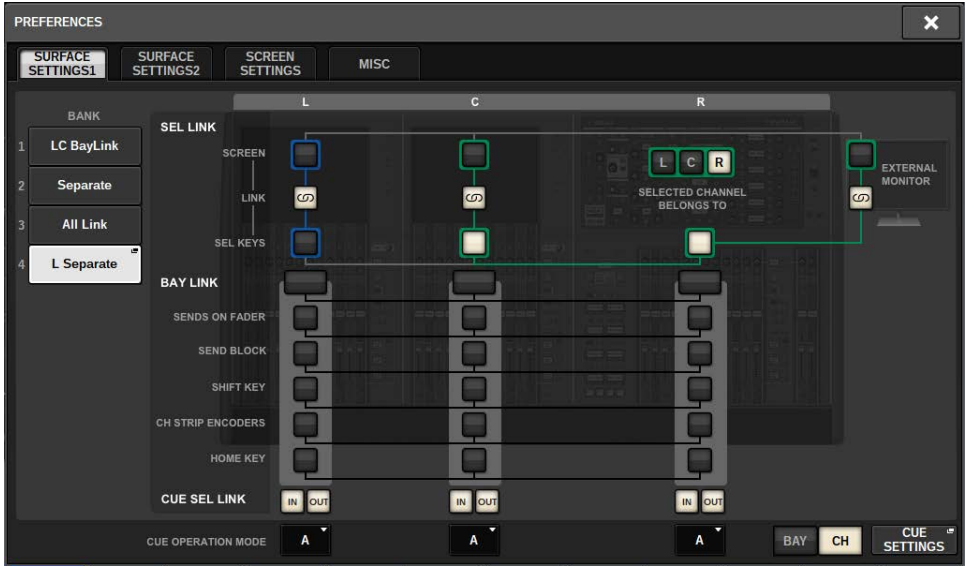

LC BayLink... Bay L and Bay C can be linked and used like a bank of 24 faders.

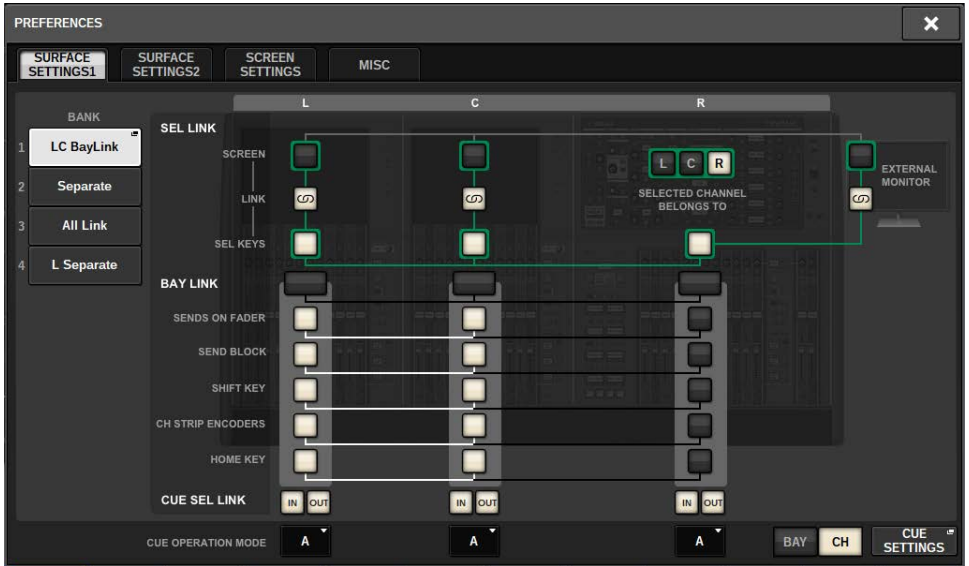

The selected layer will be indicated by a bold white frame in the meter area. The layer of the linked bay will be indicated by a thin white frame.



NOTE

- Changing the Bay Link setting will clear the position of the selected channel stored in each layer. Once this position data is cleared, the selected channel (which was already selected at the time of layer switching) will move to the left-most channel in the fader bank. (Please note that this applies only when FADER BANK SEL LINK is turned on.)
- If Bay Link mode is changed while DCA channels are being rolled out, the DCA roll-out operation will be canceled.
- If the Bay Link setting is changed for a bay on which the SET BY SEL button is turned on, SET BY SEL will be turned off.

System Setup

About the SETUP screen

The SETUP screen enables you to set various parameters that apply to the entire RIVAGE PM series. Press the SETUP button on the menu bar to access the SETUP screen.

SYSTEM SETUP field (SETUP screen)

This field enables you to make various settings that globally apply to the control surface.

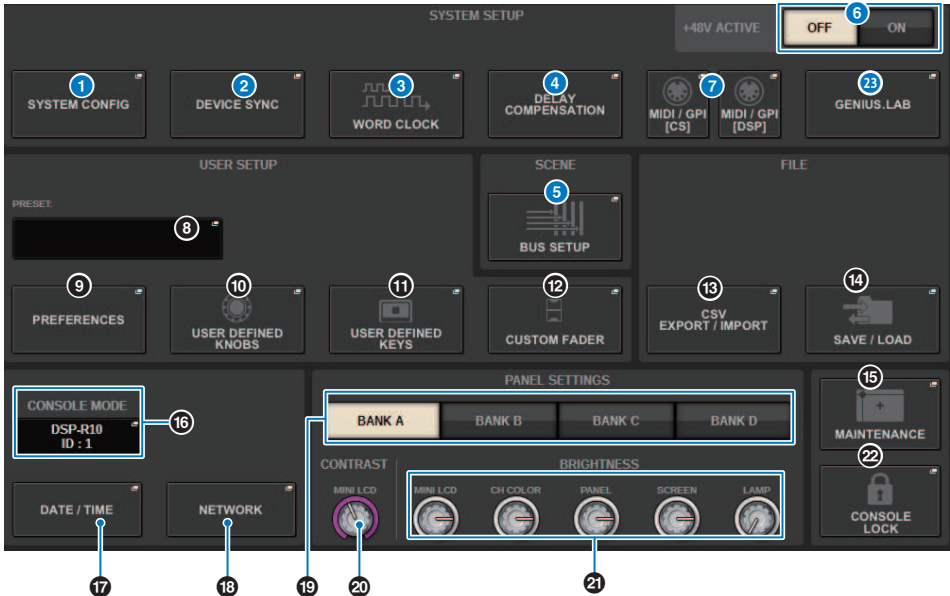

1 SYSTEM CONFIG popup button

Press this button to access the SYSTEM CONFIG popup window, in which you can configure the TWINLANe network and set up the components that comprise the RIVAGE PM series.

2 DEVICE SYNC popup button

Press this button to access the “DEVICE SYNC screen” (p.244), in which you can set the direction of data synchronization.

3 WORD CLOCK popup button

Press this button to access the WORD CLOCK popup window, in which you can set the word clock.

4 DELAY COMPENSATION popup button

Press this button to access the “DELAY COMPENSATION popup window” (p.289), in which you can make settings to compensate for signal delay.

5 BUS SETUP popup button

Press this button to access the “BUS SETUP page” (p.331), in which you can switch bus operation, mono/stereo, or send point, and specify mix minus and surround settings.

6 +48V ACTIVE button

Switches the console’s master +48V master phantom power on or off. If this button is off, phantom power will not be supplied even if the +48V button of an OMNI jack input channel or TALKBACK IN is on.

System Setup > SYSTEM SETUP field (SETUP screen)

7 MIDI/GPI [CS] popup button, MIDI/GPI [DSP] popup button

Press this button to access the “MIDI/GPI window (MIDI SETUP page)” (p.974), in which you can make MIDI and GPI settings.

USER SETUP field (SETUP screen)

This field enables you to make various user-related settings.

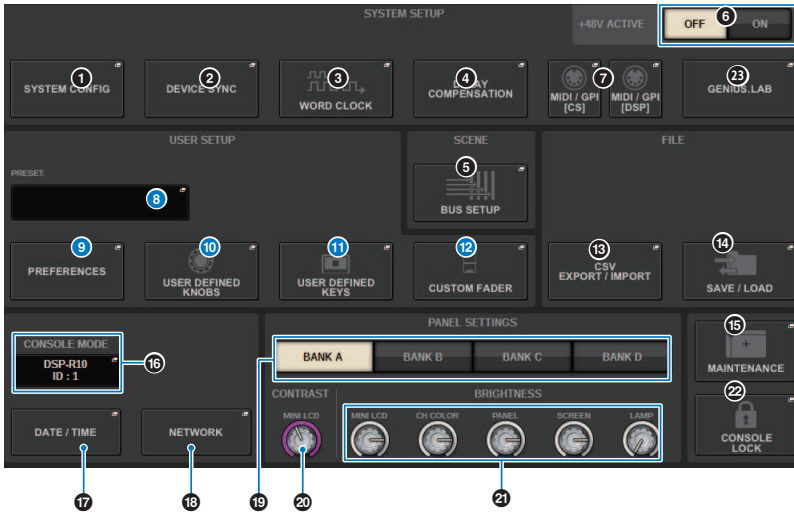

8 USER SETUP LIBRARY popup button

Press this button to access the USER SETUP LIBRARY popup window, in which you can store various settings for PREFERENCES, or for the USER DEFINED keys and knobs.

NOTE

Please note that custom fader settings will not be stored in this window.

9 PREFERENCES popup button

Press this button to access the PREFERENCES window, in which you can make various preference settings.

10 USER DEFINED KNOBS popup button

Press this button to access the “USER DEFINED KNOBS popup window” (p.937), in which you can set the parameters related to the USER DEFINED knobs, and assign functions to the channel strip encoders.

11 USER DEFINED KEYS popup button

Press this button to access the “USER DEFINED KEYS popup window” (p.955), in which you can make settings for the USER DEFINED keys.

12 CUSTOM FADER popup buttons

Press this button to access the CUSTOM FADER popup window. This window enables you to make settings for custom faders for which you can combine various channels at will.

MAINTENANCE field (SETUP screen)

This field enables you to perform maintenance operations for the entire control surface.

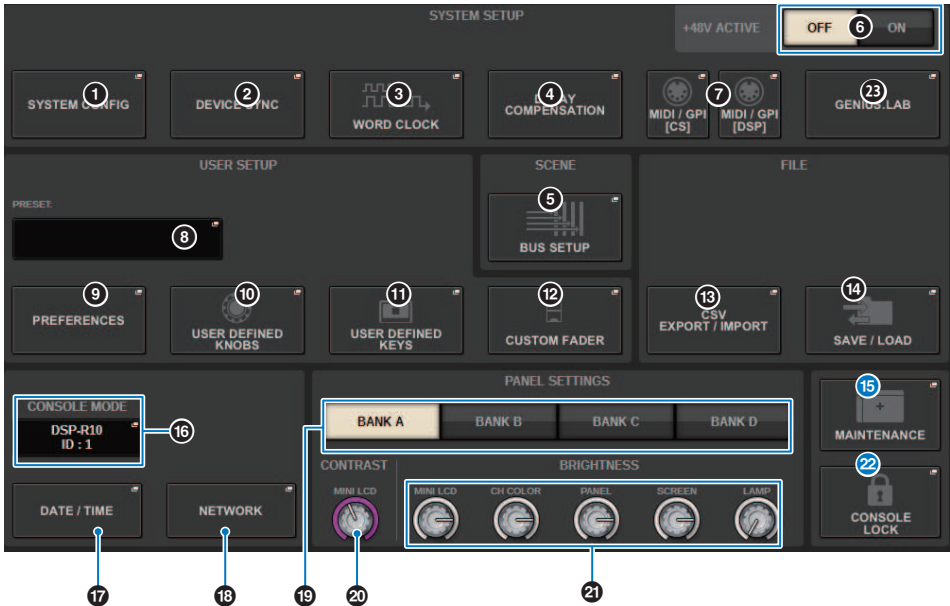

15 MAINTENANCE popup button

Press this button to access the MAINTENANCE popup window, in which you can initialize or calibrate the RIVAGE PM series.

22 CONSOLE LOCK button

Executes the Console Lock function. If the console password has been set, pressing this button will open the "PASSWORD popup window" (p.1026). Enter the correct password to execute Console Lock. If the console password has not been set, pressing this button will execute the Console Lock immediately.

CONSOLE STATUS field (SETUP screen)

This field displays various information about the control surface.

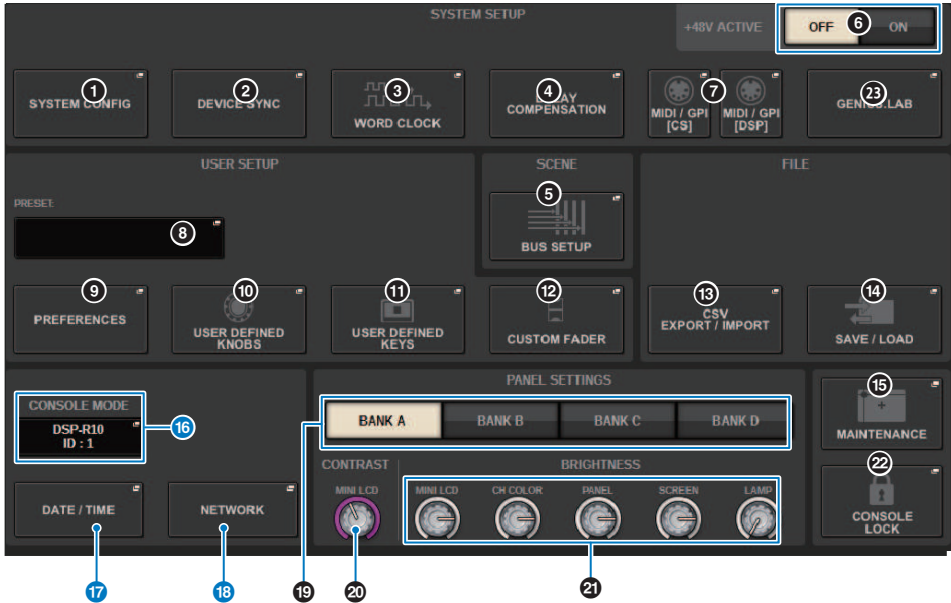

16 CONSOLE MODE button

When you press a button, the CONSOLE MODE popup window appears, in which you can select the DSP engine and CONSOLE ID. When you edit the setting, a confirmation dialog box appears. When you press the OK button, the control surface restarts.

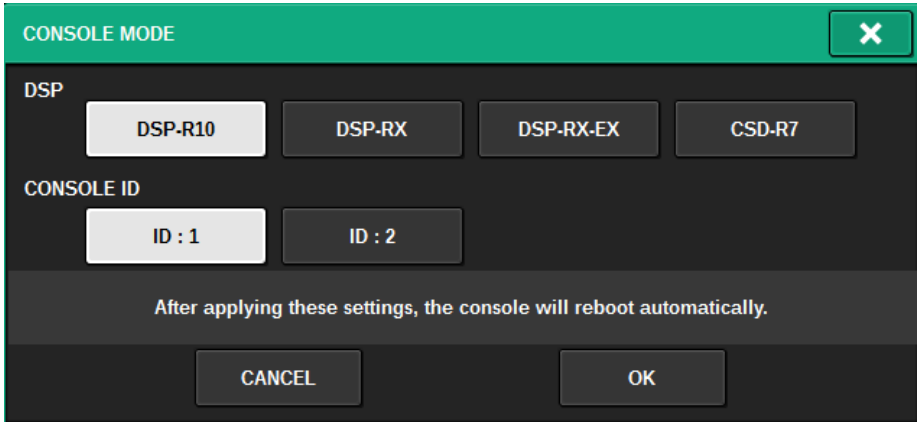

Specify separate CONSOLE IDs when using the system in dual console mode. The following functions are available only for the main console (ID1), but other functions are common to both.

- Pressing a meter indication in the meter area to recall the fader layer to the panel.
- Editing an event list and recalling events.

If you want to connect an additional control surface to the CSD-R7, set the Console ID to 2 for the control surface that you connect.

In the case of the CSD-R7, the CSD-R7 MODE ID is fixed at 1. If you connect multiple CSD-R7 units or DSP engines to the TWINLANE network, set the INTERNAL DSP ID to 1–4.

17 DATE/TIME popup button

Press this button to access the “DATE/TIME popup window” (p.1021), in which you can set the date and time.

18 NETWORK popup button

Press this button to access the NETWORK popup window, in which you can make IP address settings etc. for StageMix.

PANEL SETTINGS field (SETUP screen)

This field enables you to set the LED brightness and contrast (see “Specifying the brightness of the touch screens, LEDs, channel name displays, and lamps”).

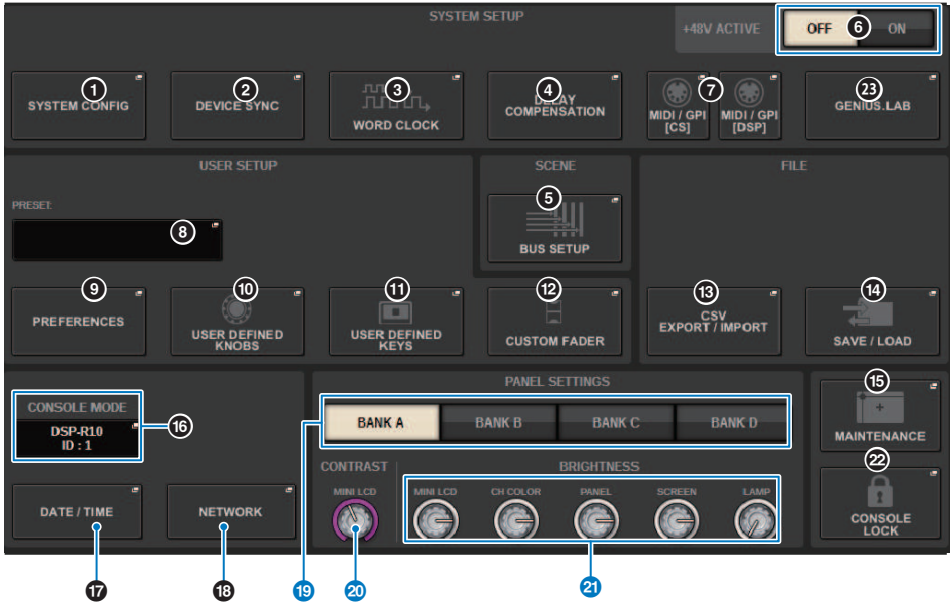

19 BANK A–D buttons

Select the bank to which you want to save the brightness and contrast settings. You can save four different settings in banks A–D, and switch them if desired.

20 CONTRAST NAME knob

Adjusts the contrast of the channel name display.

21 BRIGHTNESS NAME knob

Adjusts the brightness of the channel name display.

BRIGHTNESS CH COLOR knob

Adjusts the brightness balance of the channel color.

BRIGHTNESS PANEL knob

Adjusts the brightness of the panel LEDs.

BRIGHTNESS SCREEN knob

Adjusts the brightness of the display.

BRIGHTNESS LAMP knob

Adjusts the brightness of the lamp connected to the LAMP connector.

SYSTEM CONFIG

In SYSTEM CONFIG you can specify the type and number of components that comprise the RIVAGE PM series, and the audio channels that are assigned to the TWINLANE network. As necessary, you can also set the internal parameters of each component. You can also view and set the overall operating state of the entire system. SYSTEM CONFIG allows you to make settings offline if you are setting up in a location where the actual devices are not yet connected. The components will be recognized automatically once they are connected, and you will be able to control the parameters for those actual devices.

SYSTEM CONFIG Online settings

The procedure for making online settings is described below.

- 1** “Synchronizing the settings data between components” (p.243)
- 2** “Selecting and setting up the components” (p.245)
- 3** “Assign the channels that will be used by the DSP engines to the TWINLANe network” (p.256)
- 4** “Editing the internal parameters of each component” (p.262)
- 5** **Making Dante network settings as needed**

Synchronizing the settings data between components

About the need for synchronization

About the need for synchronization

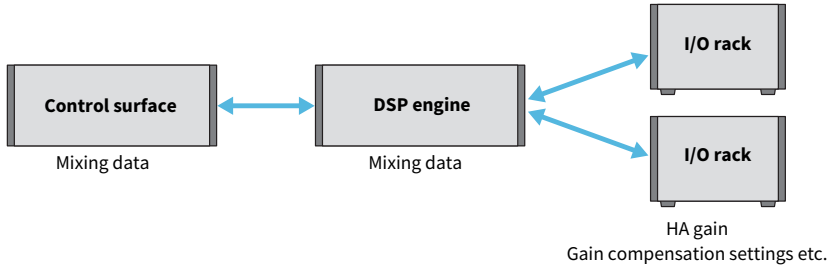

The control surface and DSP engine each maintain mixing data, and synchronize this data via the network. This means that when connecting a network, it is necessary to specify whether synchronization is performed on the basis of the control surface's data or the DSP engine's data. The I/O (CS I/O) of the I/O rack or control surface saves parameters such as the HA gain and gain compensation, and you must likewise specify the unit whose data will be the basis of synchronization. (Since CSD-R7 unifies the console and the DSP, the synchronization occurs with the I/O rack and CS I/O.)

1 When you finish connecting the system, turn on the power of each device other than the output devices (such as amps).

When the control surface detects that a new device (Control surface, DSP engine, I/O rack, CS I/O) is connected, it determines whether data synchronization is needed; if data synchronization is needed, the DEVICE SYNC popup window will appear.

2 When a popup window appears, specify the direction of data synchronization.

3 When you press the SYNC button to synchronize data, a confirmation screen appears. Press the OK button to execute.

NOTE

- If there has been no change in the internal data of each component since the previous synchronization, synchronization occurs automatically, so the "DEVICE SYNC screen" (p.244) does not appear.
- Before you synchronize, you must specify the CONSOLE MODE and CONSOLE ID.

DEVICE SYNC screen



This screen contains the following items.

1 Sync direction buttons

Press one of these buttons to specify the direction of data synchronization collectively.

2 CLEAR ALL button

Press this button to clear the direction of data synchronization setting.

Selecting and setting up the components

Follow the steps below to set up the components for the RIVAGE PM series system by selecting DSP engines and making settings for the HY slot and Y slot.

- 1 Press the **SETUP** button on the menu bar to access the **SETUP** screen.**
- 2 Press the **SYSTEM CONFIG** button.**

The **SYSTEM** tab appears.
- 3 Make sure that the proper DSP engines have been selected for connection. (DSP-R10, CSD-R7, DSP-RX, DSP-RX-EX)**
- 4 Mount the HY card. (HY Slot 1-4; HY Slot1-3 for CSD-R7)**

TWINLANe interface cards (HY256-TL, HY256-TL-SMF) can only be mounted in HY Slot 1 or 2. (Only HY Slot1 for CSD-R7)
- 5 Mount the MY card, if necessary.**
- 6 Press the **×** button to close the **SYSTEM** tab.**

NOTE

To access the **SYSTEM** tab, press the [SYSTEM] key on the panel.

[SYSTEM] tab

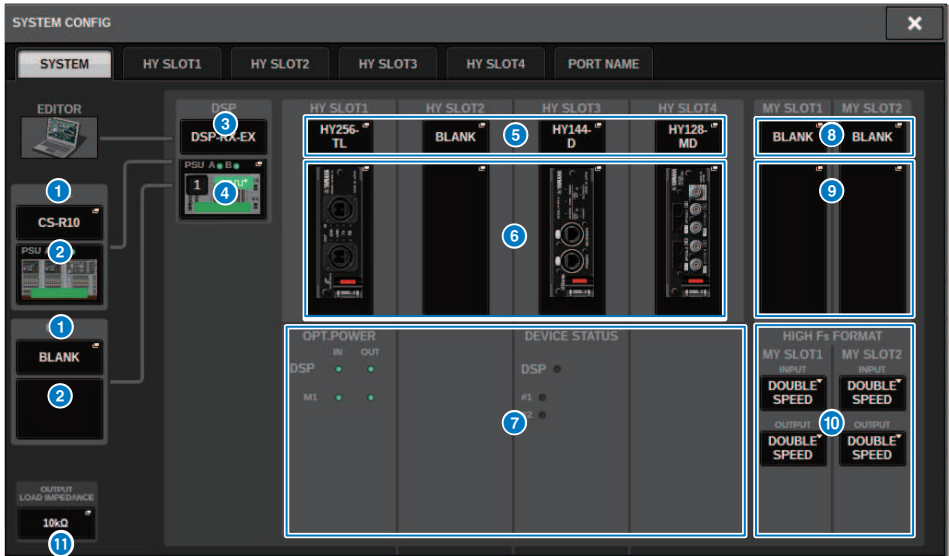

This window contains the following items.

1 CONSOLE SELECT popup button

Press the button to open the CONSOLE SELECT popup window, where you can select the control surface to mount.

2 CS1 popup button, CS2 popup button

Press this button to open the SYSTEM CONFIG [CS1] or SYSTEM CONFIG [CS2] popup window, where you can make input/output and MY slot settings for the control surface.

3 DSP engine display

The connected DSP engine is displayed.

4 **DSP engine display**

The status of the connected DSP engine is displayed.

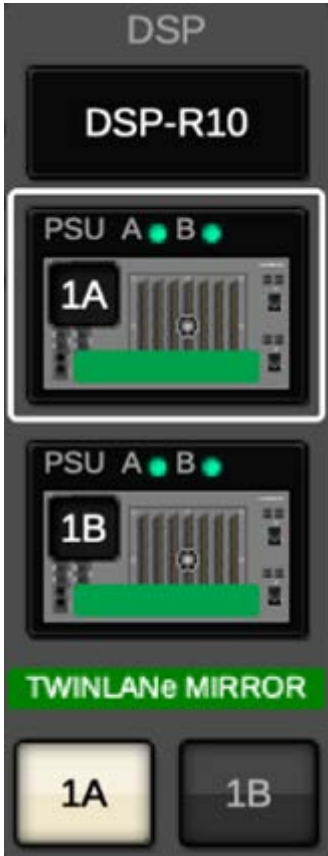

For a DSP Mirroring configuration, a button for switching the DSP engine between active/standby and DSP popup buttons for two units are displayed. In this case, the SYSTEM CONFIG [DSP] popup window that is opened by the DSP popup button will be valid only for the DSP engine that is selected as the active unit by the active/standby button. The DETAIL button is displayed when the DSP mirroring conditions do not match. Pressing the DETAIL button will display the non-matching items in red.

The image shows a 'DETAIL' popup window with a close button (X) in the top right corner. The window contains a table with two columns: 'TYPE' and 'RD'. The 'TYPE' column lists various system components, and the 'RD' column shows their status. The first two rows, 'FW VERSION' and 'RD', have red text, indicating a mismatch. The remaining rows have black text, indicating they match.

TYPE	RD
FW VERSION	RD
MYSL0T	OK
HYSLOT	OK
UNIT MODE	OK
MIRROR MODE	OK
M1	...
M2	...
M3	...
M4	...
M5	...
M6	...
M7	...
M8	...
S1	...

5 HY CARD SELECT popup button

Press the button to open the HY CARD SELECT popup window, where you can select an HY card to mount.

6 HY SLOT popup button

Press the button for the mounted card to open the corresponding HY SLOT popup window.

If this is pressed while BLANK, the HY CARD SELECT popup window opens, where you can select an HY card to mount.

7 HY SLOT status display

Displays the network and connected device status of the card mounted in the HY slot.

- TWINLANe network card: Status of the communication optical receiver power.
- Dante network card: Communication status on the Dante network

Displayed in green when there are no problems with the Dante communication. Check the Dante messages if there is a problem.

8 MY CARD SELECT popup button

Press this to open the MY CARD SELECT popup window, where you can select a Mini-YGDAI card.

9 MY SLOT (1-2) popup buttons

Press the button for the mounted card to open the parameter setting popup window for the corresponding card.

If a button is pressed while BLANK, the MY CARD SELECT popup window opens, where you can select Mini-YGDAI card.

10 HIGH Fs FORMAT switching button

When a Mini-YGDAI card uses high sampling (88.2 kHz, 96 kHz), these buttons select the operating mode as DOUBLE SPEED, DOUBLE CHANNEL, or SINGLE for IN and OUT respectively.

NOTE

Setting to a mode which is MY card-compatible will not be reflected.

11 OUTPUT LOAD IMPEDANCE button

Press this button to open a load impedance setting window for the control surface and I/O rack (Rpio) output terminal that allows for batch setting to 600kΩ or 10kΩ.

HY SLOT tab

The screenshot displays the 'HY SLOT tab' within a 'SYSTEM CONFIG' window. At the top, there are tabs for 'SYSTEM', 'HY SLOT1', 'HY SLOT2', 'HY SLOT3', 'HY SLOT4', and 'PORT NAME'. The main area is divided into three sections:

- Top Section:** A row of eight I/O rack buttons labeled M1 through M8. Each button shows a 'PSU A B' status and a channel count. A callout '1' points to these buttons. To the right, a 'TWINLANe (MAIN)' status box shows '128/400 channels used' and '(272 remain)'. A callout '4' points to this box. A callout '2' points to the horizontal line separating this section from the next.
- Middle Section:** A 'DSP' engine status popup window for rack M2. It shows '1A' and '1B' sub-racks with their own PSU status and channel counts. A callout '3' points to this popup. A callout '2' points to the horizontal line separating this section from the bottom section.
- Bottom Section:** A row of eight I/O rack buttons labeled S1 through S8. Each button shows a 'PSU A B' status and a channel count. A callout '1' points to these buttons. To the right, a 'TWINLANe (SUB)' status box shows '0/400 channels used' and '(400 remain)'. A callout '4' points to this box.

This screen contains the following items.

1 I/O rack select popup buttons (M1–M8, S1–S8)

These buttons represent the I/O racks that are connected to the system. When you press one of these buttons, a popup window appears, allowing you to select an I/O rack (on the CSD-R7, only M1–M8). The row at the top of the button shows the icon of the device and the power supply status of POWER A and B (green: power on, red: power off). The device icon indicates the status of +48V MASTER (red: on; grey: off), and also the status of the device (green: normal; yellow: abnormal; red: critical error). The number of output channels for the TWINLANe network is shown below the button.

2 TWINLANe Network

Indicates the status of the TWINLANe network (MAIN/SUB) (for the CSD-R7, only MAIN).

Blue: Connected, but settings data is not synchronized.

Green: Connected, and settings data is synchronized.

Yellow: The TWINLANe network is not in a ring-connected state (a cable is disconnected somewhere in the ring connection). This could happen when there is a device on the TWINLANe network whose input/output level is diminished.

Red: When a misconnection of a TWINLANe cable is detected.

If connected IN-IN

If connected OUT-OUT

If the DSP engine's own IN-OUT are connected directly

3 DSP popup button

Press this button to access the “DSP popup window” (p.257), in which you can assign the DSP engine’s MIX channels, MATRIX channels, and direct outputs to the TWINLANe network, and make settings for the HY slots and MY slots. In the case of a DSP engine that is the word clock leader for any TWINLANe network (Main, Sub, or Console), an indicator is shown above this button.



In the case of a DSP mirroring configuration, this area will display a button for switching the DSP engine between active and standby, and DSP popup buttons for two units. In this case, the SYSTEM CONFIG [DSP] popup window that is opened by the DSP popup button will be valid only for the DSP engine that is selected as the active unit by the active/standby button.

4 TWINLANe channel indication

Indicates the total number of channels currently used by the TWINLANe network and the number of remaining channels. A maximum of 400 channels can be assigned on the TWINLANe network. You cannot assign more than 400 channels.

The total number of "x/400 channels used" in the upper row shows the number of channels assigned by the displayed DSP engine and I/O rack connected to the DSP engine. The number of remaining channels is shown in the "(x remain)" area in the bottom row. It indicates how many channels are left to be assigned in the TL network. This number includes channels assigned from other DSP engines, so it is displayed only when online.

For the I/O rack or the DSP engine that is word clock leader in either the TWINLANe (Main)/(Sub)/Console Network, an indicator will appear on this button.

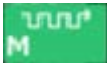

Word Clock Leader for TWINLANe (Main) Network



Word Clock Leader for TWINLANe (Sub) Network



Word Clock Leader for Console Network

Assigning the channels (that will be used by the I/O racks) to the TWINLANE network

The following procedure explains how to assign the channels used by the I/O racks to the TWINLANE network.

Only the input signals via the RY16-ML-SILK, RY16-AE, or MY card should be assigned to channels. You do not need to assign signals output from the TWINLANE network.

A maximum of 400 channels can be assigned on the TWINLANE network. A TWINLANE network card features 256-in/256-out.

For an I/O rack

NOTE

Bandwidth for an I/O rack can be assigned to the TWINLANE network only for the DSP engine that is the word clock leader of the system.

1 Press the SETUP button on the menu bar to access the SETUP screen.

2 Press the SYSTEM CONFIG button.

The SYSTEM tab will appear.



3 Press the tab for the HY SLOT1 or HY SLOT2 into which the TWINLANE network card (HY256-TL/HY256TL-SMF) has been inserted. (The CSD-R7 features only HY-SLOT1.)

The HY slot popup window will appear. The main network (M1-M8) and the sub network (S1-S8) consist of the TWINLANE network cards that are inserted into HY SLOT1 and HY SLOT2 (not on the CSD-R7) respectively.

4 Press the I/O rack select popup buttons.

The I/O rack settings popup window will appear.

5 Press the TWINLANE assignment button of the slot for which you want to make settings, and assign the channels to the TWINLANE network.

The number of selected channels assigned is shown on the button. For an HY slot, a window in which you can make settings in 16-channel units will appear. If you press a TWINLANE assignment button that is already assigned, an “x” mark () appears, indicating that the assignment is canceled. If you press a TWINLANE assignment button () that is not assigned, a checkmark () appears, indicating the assignment.

6 Press the APPLY button to apply the channel settings to the TWINLANE network.

7 When you finish making assignments, press the × button to close the I/O rack settings popup window.

If channels are assigned, and you press the × button without pressing the APPLY button, the following confirmation screen will appear. If you press OK, you will return to the HY slot popup window without applying the assignments. If you press CANCEL, you will return to the I/O rack settings popup window.

I/O rack settings popup window

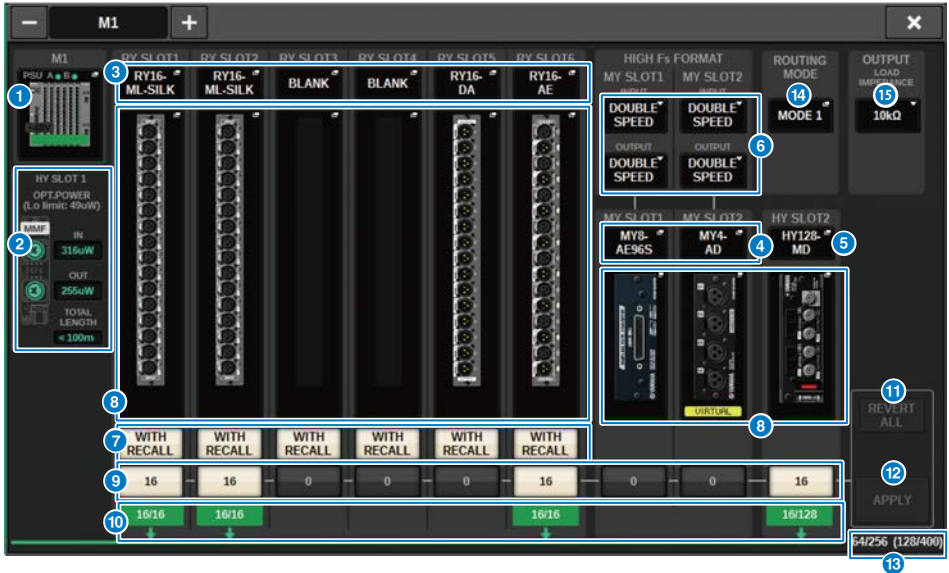

This window contains the following items.

1 I/O rack select popup buttons

These buttons display the I/O racks that are connected to the system. Press one of these buttons to open a popup window, where you can select an I/O rack. The row at the top of the button shows the power supply status of POWER A and B (green: power on, red: power off). The upper part of the device icon indicates the status of +48V ACTIVE (red: on; grey: off), and also the status of the device (green: normal; yellow: abnormal; red: critical error).

2 Optical reception power status display

This section displays the power status and readings of the optical receiver for communication on the TWINLANE network.

Green: Normal

Yellow: Optical power margin is low

Red [LOW]: Optical power is low, communication is not possible

It also displays the type of HY cards (MMF:HY256-TL; SMF:HY256-TL-SMF) and the total length of the cables.

3 RY SLOT (1-6) popup buttons

When this is pressed, the RY CARD SELECT popup window opens and you can select an RY card.

4 MY SLOT (1-2) popup buttons

When this is pressed, the MY CARD SELECT popup window opens and you can select a Mini-YGDAl card.

5 HY SLOT (2) popup button

When this is pressed, the HY CARD SELECT popup window opens and you can select an HY card.

6 HIGH Fs FORMAT switching button

When a Mini-YGDAI card uses high sampling (88.2 kHz, 96 kHz), these buttons select the operating mode as DOUBLE SPEED, DOUBLE CHANNEL, or SINGLE for IN and OUT respectively.

NOTE

Setting to a mode which is MY card-compatible will not be reflected.

7 WITH RECALL button

If this is ON, when a scene recall is performed, the scene information is reflected to the HA device and output patch. If you do not want to recall the HA gain settings, turn this to OFF. (E.g: Leave this off on the FoH side when HA is batch managed on the monitor console.).

8 Parameter settings popup buttons

Press a button to open a popup window, where you can set the parameters of each card.

9 TWINLANe assign buttons

When you press a button, the number of channels used by the selected slot will be assigned (or unassigned) to TWINLANe network. For an HY slot, a window where you can make settings in 16-channel units will appear.

NOTE

You must assign the number of channels required for input signals (that is, signals output to the TWINLANe network). You do not need to assign bandwidth to an RY slot that has an RY16-DA card installed, nor to a slot that has an output-only MY card installed.

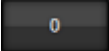
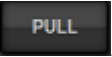
To assign, press once to set to ; to cancel, press again to set to . If you wish to leave the assignment to other DSP engines, leave this set to the default value of .

10 ASSIGNED indicator

Indicates that an assignment is currently being made to the TWINLANe network.

The color is green when the assignment is complete, and red when only a portion of the assignment is complete due to unavailability of resources or other reasons. The number of set channels/assigned channels is also displayed.

11 REVERT ALL button

If you press this button, all changes in channel assignments that you made up to that point will be canceled, reverting to the state prior to the changes.

12 APPLY button

Press this button to apply the channel assignment changes to the TWINLANe network.

13 Number of TWINLANe channels indicator

Displays the total number of channels currently used by the TWINLANe network.

14 ROUTING MODE switch button

Press this button to open a popup window, where you can switch the routing mode for HY slot 2.

ROUTING MODE switch popup window

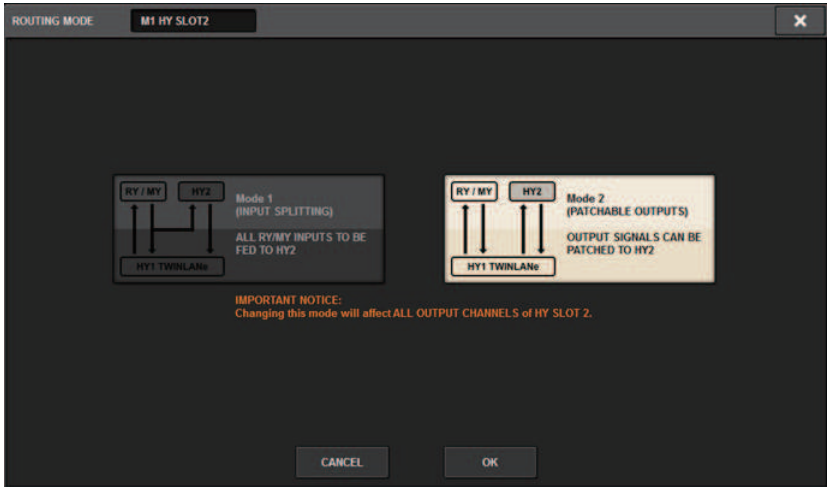

This window allows you to switch the routing mode for HY slot 2.

MODE 1: All input signals of the RY slots and MY slots are split for output to the HY SLOT 2 output.

MODE 2: You can patch mixing output signals to the HY SLOT 2 output via the TWINLANE network, in the same way as the RY slots and MY slots.

15 **OUTPUT LOAD IMPEDANCE button**

Press this to select the load impedance of the output terminals (600kΩ or 10kΩ).

Assign the channels that will be used by the DSP engines to the TWINLANe network

The following procedure explains how to assign the channels used by the DSP engines to the TWINLANe network.

A maximum of 400 channels can be assigned on the TWINLANe network. A TWINLANe network card features 256-in/256-out.

For a DSP engine

- 1 Press the SETUP button on the menu bar to access the SETUP screen.**
- 2 Press the SYSTEM CONFIG button.**

The SYSTEM tab appears.
- 3 Press the tab for the HY SLOT1 or HY SLOT2 into which the TWINLANe network card (HY256-TL/HY256TL-SMF) has been inserted. (The CSD-R7 features only HY-SLOT1.)**

The HY slot popup window appears. The main network (M1-M8) and the sub network (S1-S8) consist of the TWINLANe network cards that are inserted into HY SLOT1 and HY SLOT2 (not on the CSD-R7) respectively.
- 4 Press the DSP popup button.**

The “DSP popup window” (p.257) appears.
- 5 Press a desired channel assign popup button.**

The “TWINLANe CONFIGURATION popup window” (p.259) appears.
- 6 Select the channels that you want to use on the TWINLANe network.**

When you finish making selections, press the CLOSE button to close the window.
- 7 Press the APPLY button to apply the channel settings to the TWINLANe network.**
- 8 When you finish making assignments, press the × button to close the DSP popup window.**

If channels are assigned, and you press the × button without pressing the APPLY button, the confirmation screen appears. If you press OK, you will return to the HY slot popup window without applying the assignments. If you press CANCEL, you will return to the DSP popup window.

DSP popup window

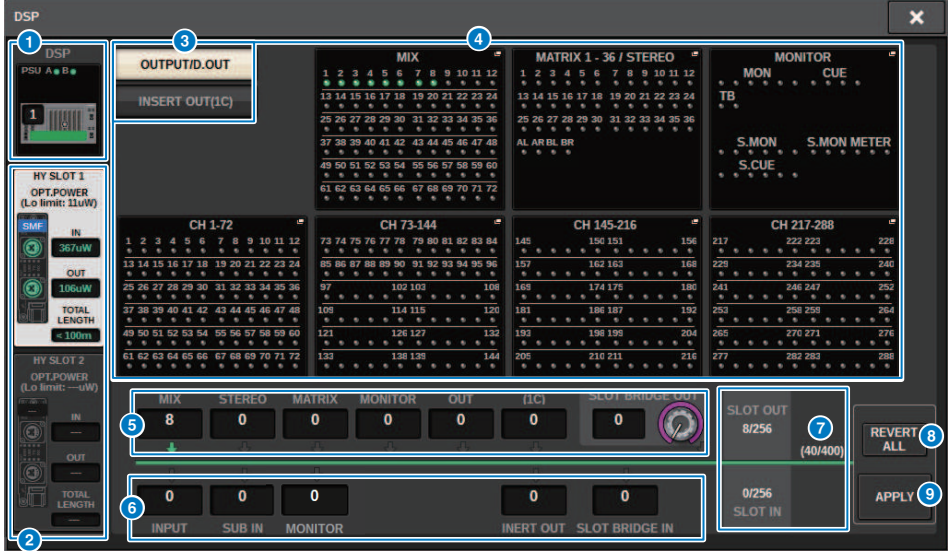

This screen contains the following items.

1 DSP engine indicator

This button represents the DSP engine that is connected to the system. The row at the top of the button shows the power supply status of POWER A and B (green: power on, red: power off). The device icon indicates the device status (green: normal; yellow: abnormal, red: critical error).

2 HY SLOT select buttons

These buttons allow you to select the HY SLOT (TWINLANE network) for which you will assign channels. (You can select only HY SLOT1 for the CSD-R7.) The optical reception power status and value on the TWINLANE network are also shown here.

HY SLOT1 is for the main network, and HY SLOT2 is for the sub network.

Green: Normal

Yellow: Optical reception power is getting low.

Red “LOW”: Optical reception power is too low to communicate.

It also indicates the type of HY cards (MMF:HY256-TL; SMF:HY256-TL-SMF) and the total length of the cables.

3 Display switch buttons for the channel assign popup button area

These buttons enable you to select which channels will be assigned to the TWINLANE: either output bus/direct out or insert out.

4 Channel assign popup buttons

When you press a button, a “TWINLANE CONFIGURATION popup window” (p.259) appears, in which you can assign the direct out to the TWINLANE network.

The number of channels varies depending on the system configuration.

5 SLOT OUT channel assignment

This area indicates the number of output channels currently used by the TWINLANe network.

6 SLOT IN channel assignment

This area indicates the number of input channels currently used by the TWINLANe network.

7 TWINLANe resource section

Indicates the total number of channels currently used by the TWINLANe network.

- SLOT OUT resource counter: The maximum number of channels is 256.

- SLOT IN resource counter: The maximum number of channels is 256.

- TWINLANe network resource counter: The maximum number of channels is 400.

You cannot assign more than the maximum number of channels.

8 REVERT ALL button

If you press this button, all changes in channel assignments that you made up to that point will be canceled, reverting to the state prior to the changes.

9 APPLY button

If you press this button, the channel assignment changes you made will be applied to the TWINLANe network.

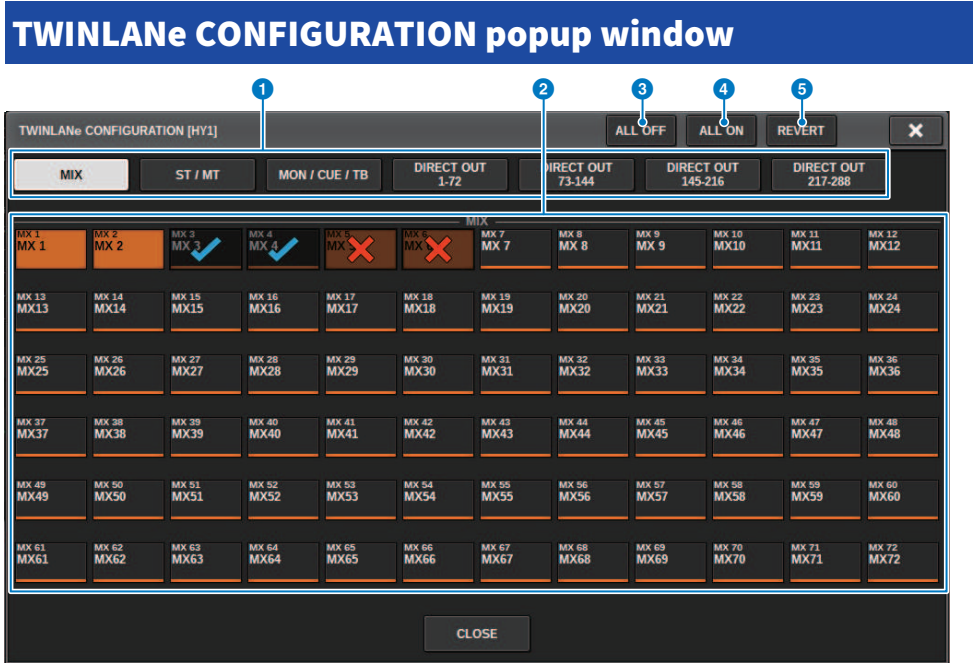

This screen contains the following items.

1 Tabs

Switch between MIX OUT, ST/MT/MON/CUE/TB, DIRECT OUT 1-72, and DIRECT OUT 73-144.

2 Channel select buttons

Select the channel to edit. The select button will change as follows.



Currently not assigned to the TWINLANe network



Currently assigned to the TWINLANe network



Currently assigned to the TWINLANe network, and selected for cancellation.

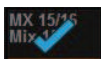

Currently not assigned to the TWINLANe network, and selected for assignment.

3 ALL OFF button

Press this button to cancel all channels assigned to the TWINLANe network collectively.

4 ALL ON button

Press this button to select and assign all channels that have not been assigned to the TWINLANe network collectively.

System Setup > TWINLANe CONFIGURATION popup window

5 REVERT button

Press this button to revert the selections for cancellation and assignments to their original status collectively.

SYSTEM CONFIG [CS1] popup window

This screen contains the following items.

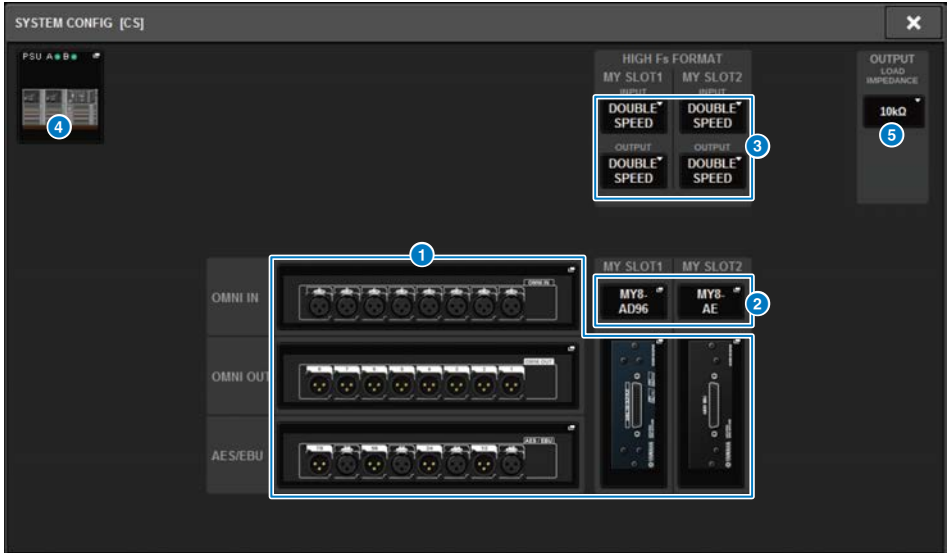

1 Parameter settings popup buttons

Press a button to open a popup window, in which you can set the parameters of each card.

2 MY SLOT (1-2) popup buttons

Press a button to open the MY CARD SELECT popup window, in which you can select a Mini-YGDAI card.

3 HIGH Fs FORMAT select button

When a Mini-YGDAI card is using high sampling (88.2 kHz, 96 kHz), these buttons select the operating mode as DOUBLE SPEED, DOUBLE CHANNEL, or SINGLE for IN and OUT respectively.

NOTE

This setting will be ignored if you try to specify a mode that the MY card does not support. The I/Os for the control surface are assigned as part of the DSP engine on the RIVAGE PM series. Therefore, you do not need to assign channels to the TWINLANE network.

4 Control surface select popup button

This shows the control surfaces that are connected to the system. Press this button to display a popup window, in which you can select a control surface.

Editing the internal parameters of each component

You can edit the internal parameters of each component

- 1 Press a parameter settings popup button to access the parameter settings popup window of each component.**
- 2 Edit the parameters as needed.**

Editing the internal parameters of the RY16-ML-SILK



This screen contains the following items.

- 1 **Patch indication**
Indicates the channel that is patched.
- 2 **+48V button**
Switches phantom power (+48V) on or off.
- 3 **A.GAIN knob**
Indicates the HA analog gain setting. Use the screen encoder to adjust the value. If gain compensation is on, an indicator shows the analog gain position at the time that gain compensation was turned on.
- 4 **Meter (Pre GC)**
This meter indicates the level of signals after passing through analog gain (before GC).
- 5 **Meter (channel input)**
This meter indicates the level after passing through GC (before D.GAIN).
- 6 **GC (GAIN COMPENSATION) button**
Switches the gain compensation on or off for that channel.
- 7 **PHASE button**
Switches the phase of the input signal.

NOTE

This is a parameter within the I/O rack. It is different than the Φ parameter within the channel module of the control surface.

8 SILK ON button

Switches Silk on or off.

9 RED/BLUE selection button

Toggles between BLUE and RED: “BLUE” for solidity and power, and “RED” for sparkling energy.

10 SILK [TEXTURE] knob

Adjusts the TEXTURE parameter of Silk.

11 HPF button

Toggles the high pass filter on or off for each port.

NOTE

This is a parameter within the I/O rack. It is different than the HPF within the channel module of the control surface.

12 FREQUENCY knob

Sets the HPF cutoff frequency.

13 M/S button

Switches the M/S decoder on or off for each pair of channels.

14 S-GAIN knob

Adjusts the side gain of M/S.

15 Tabs

Switch the display in units of eight channels.

Editing the internal parameters for OMNI OUT of the RY16-DA and control surface



This screen contains the following items.

1 Patch indication

Indicates the channel that is patched.

2 DELAY button

Switches the output delay on or off.

3 Delay time knob

Sets the delay time of the output port. If you press this knob when it is selected, the DELAY TIME popup window will appear. The delay time value is shown above the knob in millisecond units, and below the knob in the units that are selected in the DELAY SCALE popup window.

NOTE

If the scale is set to ms, the delay time value above the knob will not be shown.

4 PHASE button

Switches the phase of the output signal.

5 GAIN knob

Adjusts the output gain of the output port. Use the screen encoder to adjust the value. Adjust the setting in 1.0 dB units by turning the knob, or adjust the setting in 0.1 dB units by turning the knob while pressing it. The current value is shown immediately below the knob.

6 Level meter

Indicates the output level of the signal after level adjustment.

7 Tabs

Switch the display in units of eight channels.

Editing the internal parameters for INPUT 1-8/INPUT 9-16 of the RY16-AE, and AES/EBU INPUT 1-8 on the rear panel of the control surface



This screen contains the following items.

- 1 **Patch indication**
Indicates the channel that is patched.
- 2 **Level meter**
Shows the input level.
- 3 **SRC button**
Switches the sampling rate converter on/off for each pair of channels.
- 4 **Clock status indicator**
Indicates the status of the input signal.
- 5 **PHASE button**
Switches the phase of the input signal.

NOTE

This is a parameter within the I/O rack. It is different than the Φ parameter within the channel module of the control surface.

- 6 **M/S button**
Switches the M/S decoder on or off for each pair of channels.

System Setup > Editing the internal parameters for INPUT 1-8/INPUT 9-16 of the RY16-AE, and AES/EBU INPUT 1-8 on the rear panel of the control surface

7 S-GAIN knob

Adjusts the side gain of M/S.

8 Tabs

Switch the display in units of eight channels.

Editing the internal parameters for OUTPUT 1-8/OUTPUT 9-16 of the RY16-AE, and AES/EBU OUTPUT 1-8 on the rear panel of the control surface



This screen contains the following items.

- 1 Patch indication**
Indicates the channel that is patched.
 - 2 DELAY button**
Switches the output delay on or off.
 - 3 Delay time knob**
Sets the delay time of the output port. If you press this knob when it is selected, the DELAY TIME popup window will appear. The delay time value is shown above the knob in millisecond units, and below the knob in the units that are selected in the DELAY SCALE popup window.
- NOTE**
- If the scale is set to ms, the delay time value above the knob will not be shown.
- 4 PHASE button**
Switches the phase of the output signal.
 - 5 SRC button**
Switches the sampling rate converter on/off for each pair of channels.

System Setup > Editing the internal parameters for OUTPUT 1-8/OUTPUT 9-16 of the RY16-AE, and AES/EBU OUTPUT 1-8 on the rear panel of the control surface

6 Sampling rate select menu

Selects the output sampling rate when an SRC is turned on. Choose from SAME AS INPUT (same as the word clock that is input), 44.1 kHz, 48 kHz, 88.2 kHz, or 96 kHz.

7 GAIN knob

Adjusts the output gain of the output port. Use the screen encoder to adjust the value. Adjust the setting in 1.0 dB units by turning the knob, or adjust the setting in 0.1 dB units by turning the knob while pressing it. The current value is shown immediately below the knob.

8 Level meter

Indicates the output level of the signal after level adjustment.

9 Tabs

Switch the display in units of eight channels.

Editing the internal parameters of the MY CARD INPUT



This screen contains the following items.

1 Patch indication

Indicates the channel that is patched.

2 Level meter

Shows the input level.

3 SRC button

Switches the sampling rate converter on/off for each pair of channels.

NOTE

This setting will be ignored if you try to specify it for an MY card that does not support SRC.

4 Clock status display

Indicates the status of the input signal.

5 PHASE button

Switches the phase of the input signal.

NOTE

This is an internal SLOT parameter. It is different than the Φ parameter within the channel module of the control surface.

6 Tabs

Switch the display in units of eight channels.

Editing the internal parameters of the MY CARD OUTPUT



This screen contains the following items.

1 Patch indication

Indicates the channel that is patched.

2 DELAY button

Switches the output delay on or off.

3 Delay time knob

Sets the delay time of the output port. If you press this knob when it is selected, the DELAY TIME popup window will appear. The delay time value is shown above the knob in millisecond units, and below the knob in the units that are selected in the DELAY SCALE popup window.

NOTE

If the scale is set to ms, the delay time value above the knob will not be shown.

4 PHASE button

Switches the phase of the signal that is output.

5 GAIN knob

Adjusts the output gain of the output port. Use the screen encoder to adjust the value. Adjust the setting in 1.0 dB units by turning the knob, or adjust the setting in 0.1 dB units by turning the knob while pressing it. The current value is shown immediately below the knob.

6 Level meter

Indicates the output level of the signal after level adjustment.

7 Tabs

Switch the display in units of eight channels.

Editing the internal parameters for OMNI IN of the control surface



This screen contains the following items.

- 1 Patch indication**
Indicates the channel that is patched.
- 2 +48V button**
Switches phantom power (+48V) on or off.
- 3 A.GAIN knob**
Indicates the HA analog gain setting. Use the screen encoder to adjust the value.
- 4 Meters**
This meter indicates the level of signals after passing through analog gain.
- 5 SILK ON button**
Switches Silk on or off.
- 6 RED/BLUE selection button**
Toggles between BLUE and RED: “BLUE” for solidity and power, and “RED” for sparkling energy.
- 7 SILK [TEXTURE] knob**
Adjusts the TEXTURE parameter of Silk.

8 HPF button

Toggles the high pass filter on or off for each port.

NOTE

This is a parameter within the I/O rack. It is different than the HPF within the channel module of the control surface.

9 FREQUENCY knob

Sets the HPF cutoff frequency.

10 M/S button

Switches the M/S decoder on or off for each pair of channels.

11 S-GAIN knob

Adjusts the side gain of M/S.

NOTE

The OMNI IN of the CS-R5 or CS-R3 does not support the SILK function. (5, 6, 7)

Settings for the HY128-MD card

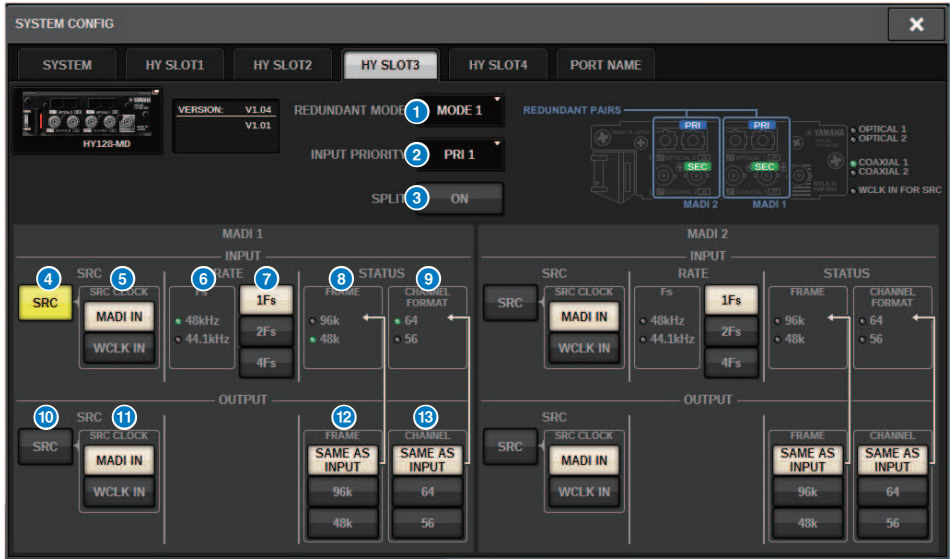

This illustration shows the screen that appears when the HY128-MD card is mounted in HY SLOT3. This screen contains the following items.

1 REDUNDANCY MODE

Select one of the following two redundant pairs:

- **MODE 1**

A combination of an optical connection and coaxial connection is used to maintain redundancy.

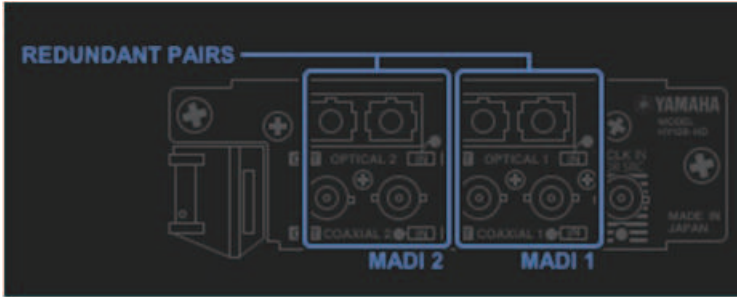

- **MODE 2**

Two optical connections or two coaxial connections are used to maintain redundancy.

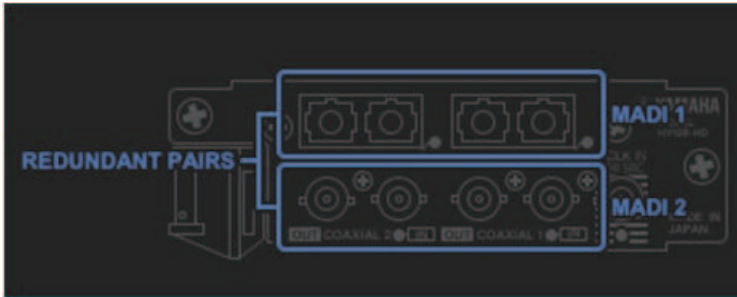

2 INPUT PRIORITY

Specifies which input signal from two redundant lines will take priority.

- **PR11**

With MODE 1, OPTICAL 1 and OPTICAL 2 signals will take priority.

With MODE 2, OPTICAL 1 and COAXIAL 1 signals will have priority.

- **PR12**

With MODE 1, COAXIAL 1 and COAXIAL 2 signals will take priority.

With MODE 2, OPTICAL 2 and COAXIAL2 signals will take priority.

3 SPLIT button

Specifies whether the input signals will be split and routed to the output jacks. The destination is the output jacks of the same type.

• **ON**

Input signals will be split and routed to the output jacks.

NOTE

If another output is patched at this time, the patch will be disabled and the sound will stop.

• **OFF**

Input signals from the mounted card will be output without being split.

4 INPUT SRC button

Selects SRC on or off for the MADI input signal.

5 SRC CLOCK button

Selects the clock for the input signal while SRC is on.

• **MADI IN**

MADI IN clock is regarded as the SRC input clock.

• **WCLK IN**

WCLK IN FOR SRC clock is regarded as the SRC input clock.

6 Fs indicators

Display whether the input signal is 48kHz or 44.1kHz. If there is no valid MADI input, the indicators will turn off.

7 RATE buttons

Specify whether the MADI input signal will be processed as a 1Fs, 2Fs, or 4Fs signal.

• **1Fs**

44.1 kHz/ 48 kHz, Maximum 64 channels

• **2Fs**

88.2 kHz/ 96 kHz, Maximum 32 channels

• **4Fs**

176.4 kHz/ 192 kHz, Maximum 16 channels

8 FRAME indicators

Display the FRAME format of the input signal. If there is no valid MADI input, the indicators will turn off.

9 CHANNEL FORMAT indicators

Display the channel format of the input signal. If there is no valid MADI input, the indicators will turn off.

10 OUTPUT SRC button

Selects SRC on or off for the MADI output signal.

11 SRC CLOCK button

Selects the clock for the output signal while SRC is on.

• **MADI IN**

The output signal follows the clock input at the corresponding MADI IN connector.

• **WCLK IN**

The output signal follows the clock input at the WCLK IN FOR SRC connector.

12 OUTPUT FRAME buttons

Select the FRAME format of the output signal.

• **SAME AS INPUT**

The signal is output in the same FRAME format as the MADI IN signal. If there is no valid MADI input, the signal will be output in the 48k FRAME format.

• **96k**

Output in the 96k FRAME format

• **48k**

Output in the 48k FRAME format

13 OUTPUT CHANNEL FORMAT buttons

Select the channel format of the output signal.

• **SAME AS INPUT**

The same number of channels as that of MADI IN will be output. If there is no valid MADI input, 64-channel signals will be output.

• **64**

64-Channel output

• **56**

56-Channel output

■ About the SOFTWARE CONTROL switches on the HY128-MD card

When switch 1 is ON (default), you can view and edit the settings on the control surface. When switch 1 is OFF, the parameters are fixed by the dip switch setting on the card. For details, refer to the “HY128-MD Owner’s Manual.” The screen is grayed out, and you will be unable to edit the settings from the control surface.

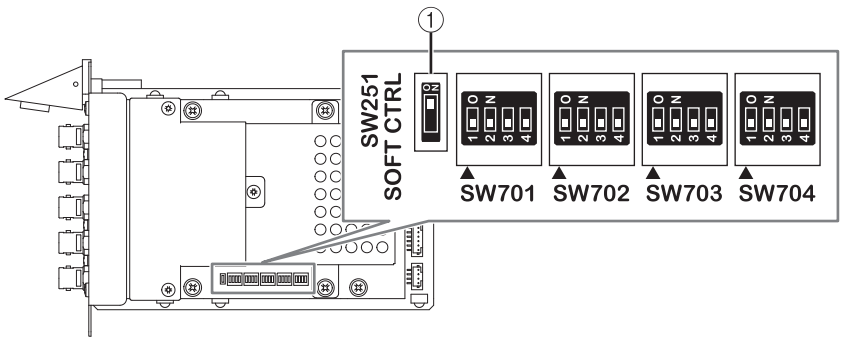

SYSTEM CONFIG Offline settings

You can make system settings using the control surface by itself, without connecting a DSP engine or I/O rack. The procedure for offline settings is described below.

- 1 Mounting an I/O rack**
- 2 “Specifying the type and number of cards (Offline)” (p.284)**
- 3 Assigning channels to the TWINLANe network**
- 4 “Editing the internal parameters of each component” (p.262)**
- 5 Making Dante network settings as needed**

NOTE

If the settings made while offline differ from the settings of the actual device when the actual device is connected, the settings of the actual device will take priority over the offline settings, and will be applied to the system.

Mounting an I/O rack (offline)

The following procedure explains how to assign the channels used by the I/O racks and DSP engines to the TWINLANe network.

1 Press the **SETUP** button on the menu bar to access the **SETUP** screen.

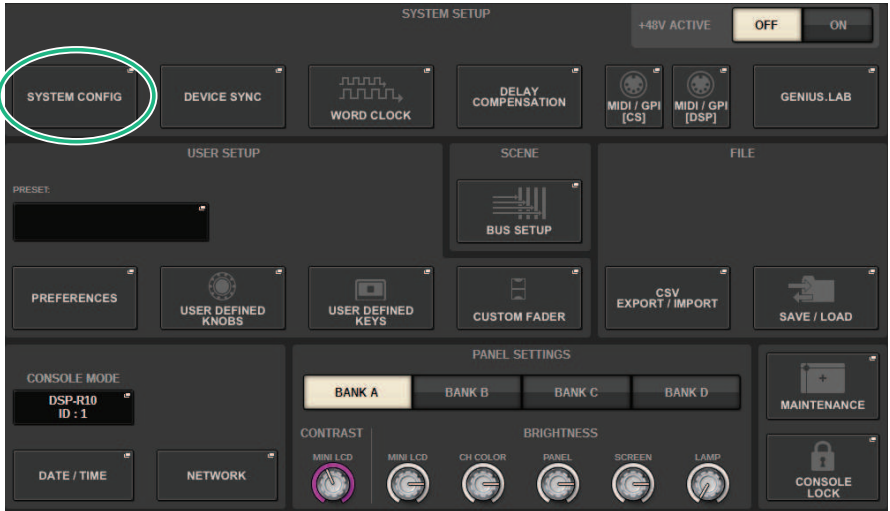

2 Press the **SYSTEM CONFIG** button.

The "SYSTEM CONFIG popup window (Offline)" (p.283) appears.

3 Press the I/O rack select popup button to access the I/O SELECT popup window.

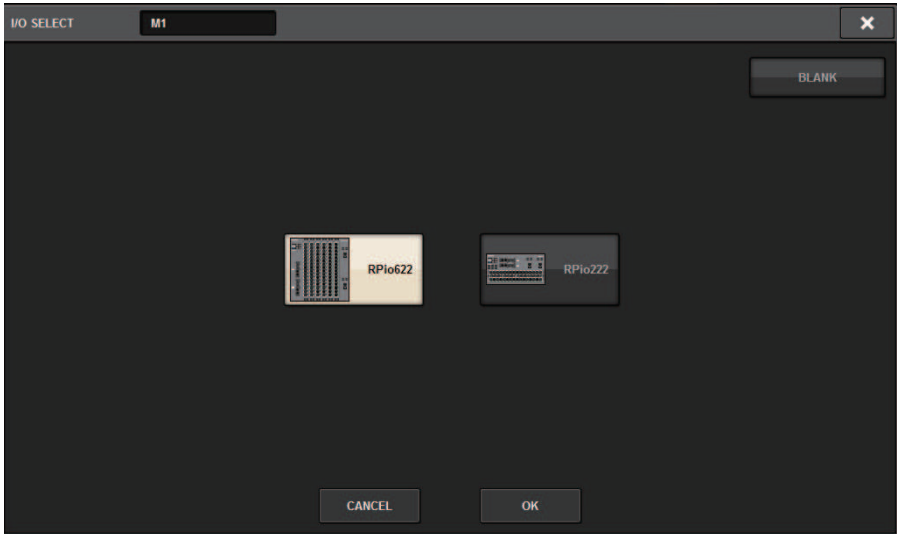

4 Select the I/O rack (RPIO622 or RPIO222) that you want to use, and press the OK button.

You will return to the SYSTEM CONFIG popup window. To cancel, press the CANCEL button. If you want to add another I/O rack, repeat steps 3–4.

SYSTEM CONFIG popup window (Offline)



This screen contains the following items.

1 I/O rack select popup buttons (M1–M8, S1–S8)

If you press one of these buttons when an I/O rack is not mounted, the I/O SELECT popup window will appear, allowing you to select the I/O rack that you want to use. If you press this button when an I/O rack is already mounted, the I/O rack settings window will appear. Devices being edited offline are indicated as “VIRTUAL” in yellow.

Specifying the type and number of cards (Offline)

The following example explains how to add an RY card for use in the I/O rack. Use the same procedure for adding a different card to a different component.

- 1 Press the SETUP button on the menu bar to access the SETUP screen.**
- 2 Press the SYSTEM CONFIG button to access the SYSTEM CONFIG popup window.**
- 3 Press the tab for the HY SLOT1 or HY SLOT2 into which the TWINLANe network card (HY256-TL/HY256TL-SMF) has been inserted. (The CSD-R7 features only HY-SLOT1.)**
The HY slot popup window will appear.
- 4 Press the the popup button for the mounted I/O rack.**
The I/O rack settings popup window will appear.
- 5 Press the RY SLOT popup button.**
The “RY CARD SELECT popup window” (p.285) appears.
- 6 Select the RY card that you want to use, and press the OK button.**
You will return to the I/O rack settings popup window. To cancel, press the CANCEL button. If you want to add another RY card, repeat steps 4–5.
- 7 When you finish adding cards, press the × button to close the I/O rack settings window.**

RY CARD SELECT popup window

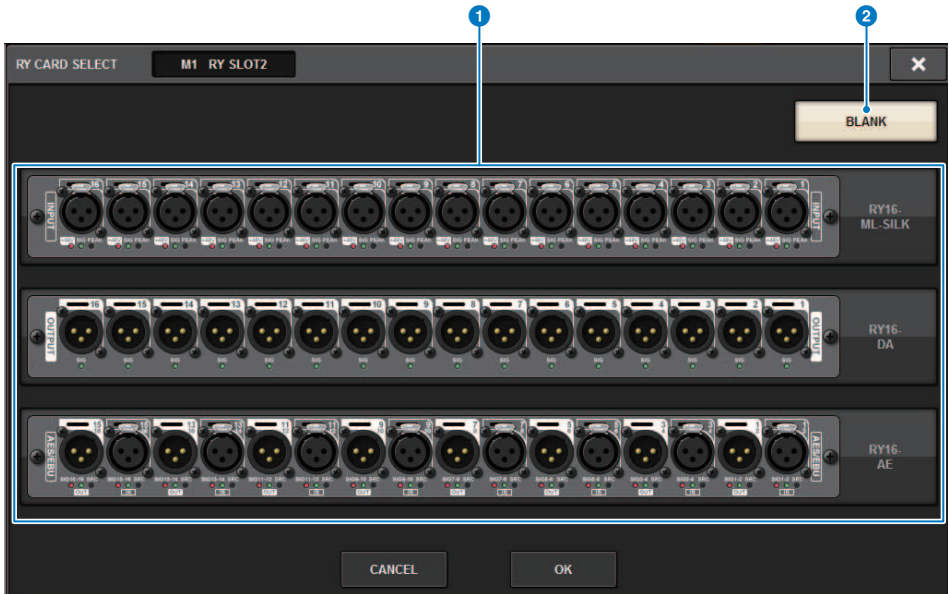

This screen contains the following items.

1 RY card select buttons

Select the RY card that you want to use.

2 BLANK button

Use this button if you do not want to mount anything.

MY CARD SELECT popup window

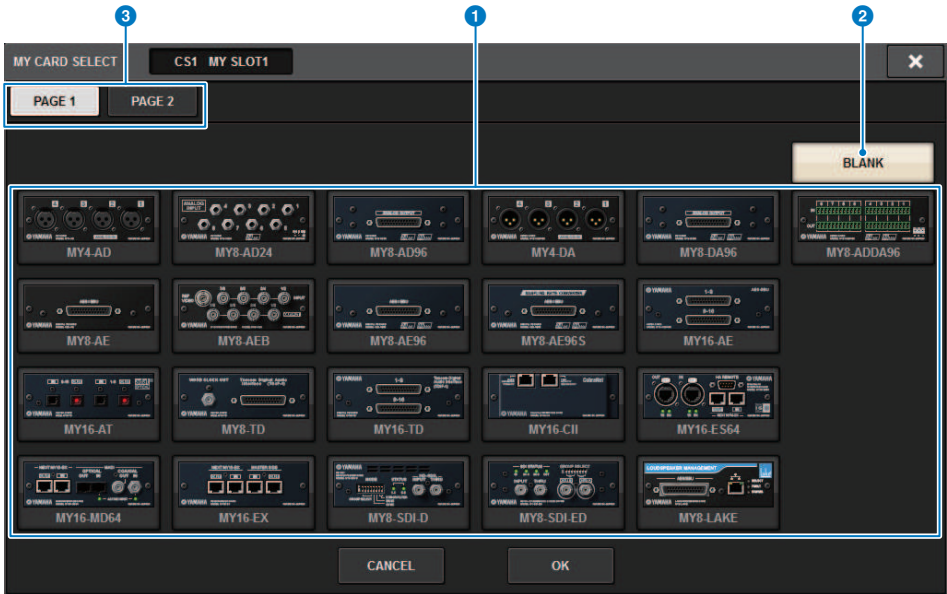

This screen contains the following items.

- 1 Mini-YGDAI card select buttons**
Select the Mini-YGDAI card that you want to use.
- 2 BLANK button**
Use this button if you do not want to mount anything.
- 3 Tabs**
Switch between pages in the list of Mini-YGDAI cards.

HY CARD SELECT popup window

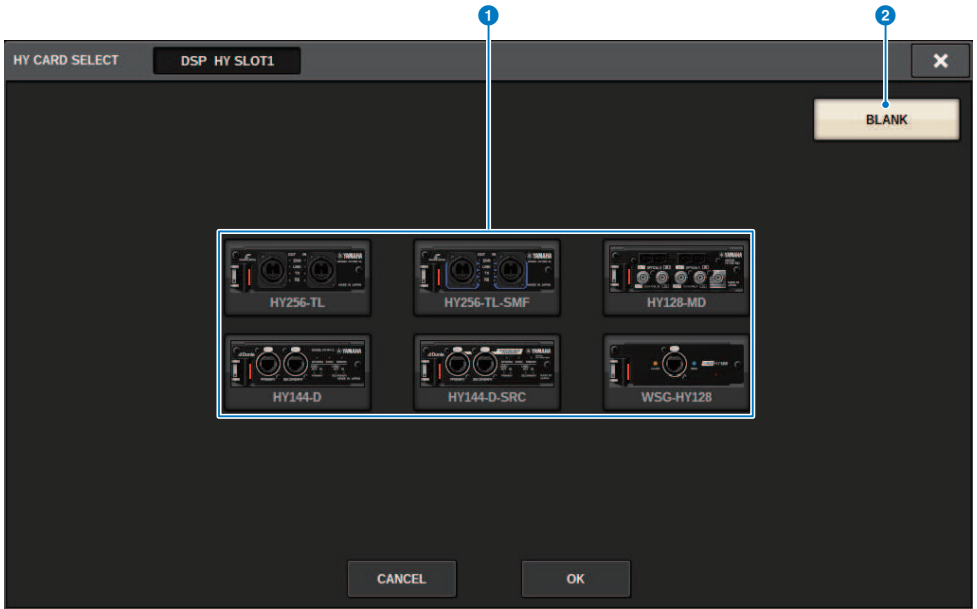

This screen contains the following items.

1 HY card select buttons

Select the HY card that you want to use.

2 BLANK button

Use this button if you do not want to mount anything.

DELAY COMPENSATION

Each channel signal may be delayed by a different amount of time due to digital signal processing through plug-ins, GEQ inserts, or certain routings. The Delay Compensation function automatically fixes this delayed timing. The maximum delay is estimated, and the appropriate amount of delay is added to each channel as compensation.

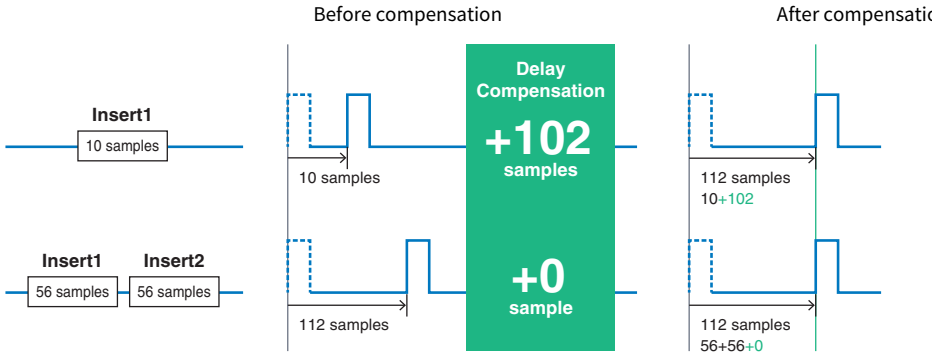

1 Press the SETUP button on the menu bar to access the SETUP screen.

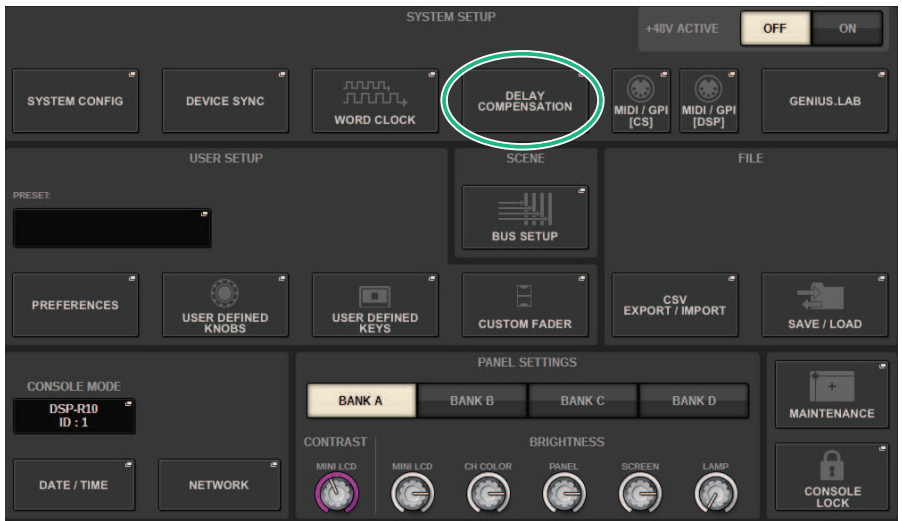

2 Press the DELAY COMPENSATION button.

The "DELAY COMPENSATION popup window" (p.289) appears.

DELAY COMPENSATION popup window

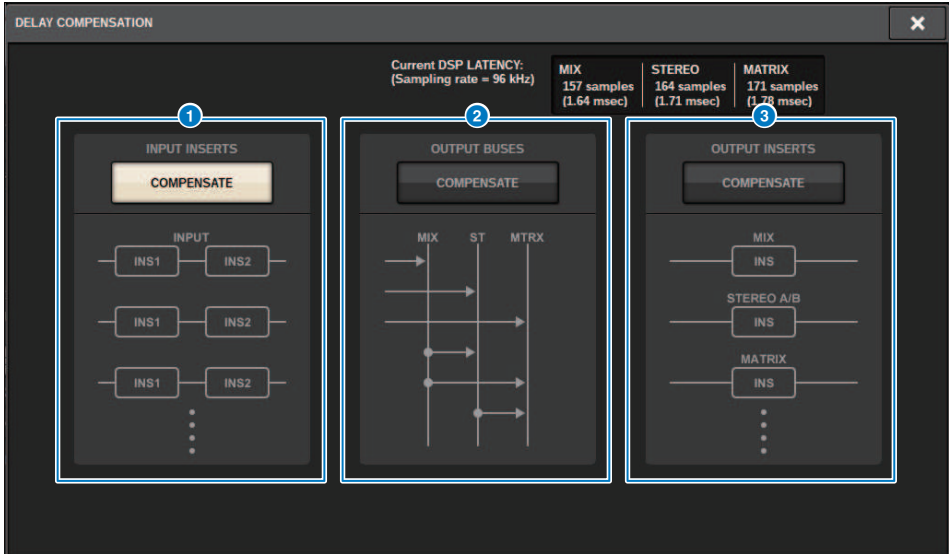

This screen contains the following items.

NOTE

By default, only the INPUT INSERTS button is turned on.

1 INPUT INSERTS COMPENSATE button

Press this button to automatically compensate for the timing among channels by inserting a delay into each input channel. Due to this compensation, all input channel signals will be delayed by 112 samples.

2 OUTPUT BUSES COMPENSATE button

Press this button to automatically compensate for the delayed timing on each MIX/ST/MATRIX bus. Due to this compensation, output signals from the MIX buses will be delayed by 14 samples, and output signals from the STEREO buses will be delayed by 7 samples. If you use the compensation via this button along with the OUTPUT INSERTS COMPENSATE button, output signals from the MIX buses will be delayed by 336+14 samples; from the STEREO buses by 336+7 samples; and from the MATRIX buses by 336 samples.

3 OUTPUT INSERTS COMPENSATE button

Press this button to automatically compensate the timing among channels by inserting a delay into each output channel. Due to this compensation, output signals from the MIX buses will be delayed by 112 samples; from the STEREO buses by 224 samples; and from the MATRIX buses by 336 samples.

sample	fs 44.1 kHz	fs 48kHz	fs 88.2kHz	fs 96kHz
7	0.16msec	0.15msec	0.08msec	0.07msec
14	0.32msec	0.29msec	0.16msec	0.15msec
112	2.50msec	2.30msec	1.30msec	1.20msec
224	5.10msec	4.70msec	2.50msec	2.30msec

sample	fs 44.1 kHz	fs 48kHz	fs 88.2kHz	fs 96kHz
336	7.60msec	7.00msec	3.80msec	3.50msec
336+7	7.80msec	7.10msec	3.90msec	3.60msec
336+14	7.90msec	7.30msec	4.00msec	3.60msec

4 Latency values

This area shows the latency values (msec) generated by the signal that is input to the DSP engine, passes through the input channel, and is output to the buses. A latency value increases as Delay Compensation is applied. The value also varies depending on the Fs (sampling rate).

- **MIX**..... Latency from INPUT to MIX OUT
- **STEREO** Latency from INPUT to STEREO OUT
- **MATRIX**..... Latency from INPUT to MATRIX OUT

Word Clock

A TWINLANE network that features the RIVAGE PM series transfers not only audio and control signals, but also word clock. On a TWINLANE network, only one DSP engine can become the clock leader. If two DSP engines are on the same network, one becomes the leader and the other becomes a follower. For the leader clock on a TWINLANE network, you can select one of the following three options: the DSP engine's internal clock (44.1 kHz, 48 kHz, 88.2 kHz, or 96 kHz), the external word clock that is input at the WORD CLOCK IN connector on the rear panel of the leader DSP engine, and the word clock that is supplied from the DSP engine's HY card slot. On the other hand, since the follower DSP engine will use word clock flowing through the TWINLANE network as the clock source, you must select HY SLOT 1 for the follower DSP engine.

Meanwhile, since the I/O racks automatically use word clock flowing through the TWINLANE network as the clock source, you do not have to specify word clock for the I/O rack.

Follow the steps below to select the clock source.

1 Press the **SETUP** button on the menu bar to access the **SETUP** screen.

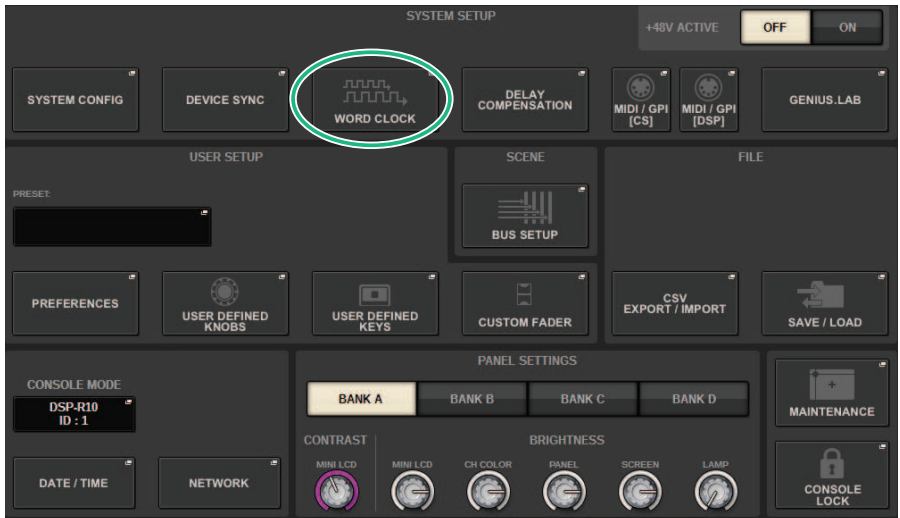

2 Press the **WORD CLOCK** button.

The **WORD CLOCK** popup window appears.

3 In the **LEADER CLOCK SELECT** field, select a clock source.

A confirmation dialog box will appear if you attempt to change the clock source setting.

4 To close the **WORD CLOCK** popup window, press the “x” symbol located in the upper right.

The system will return to the **SETUP** screen.

WORD CLOCK popup window

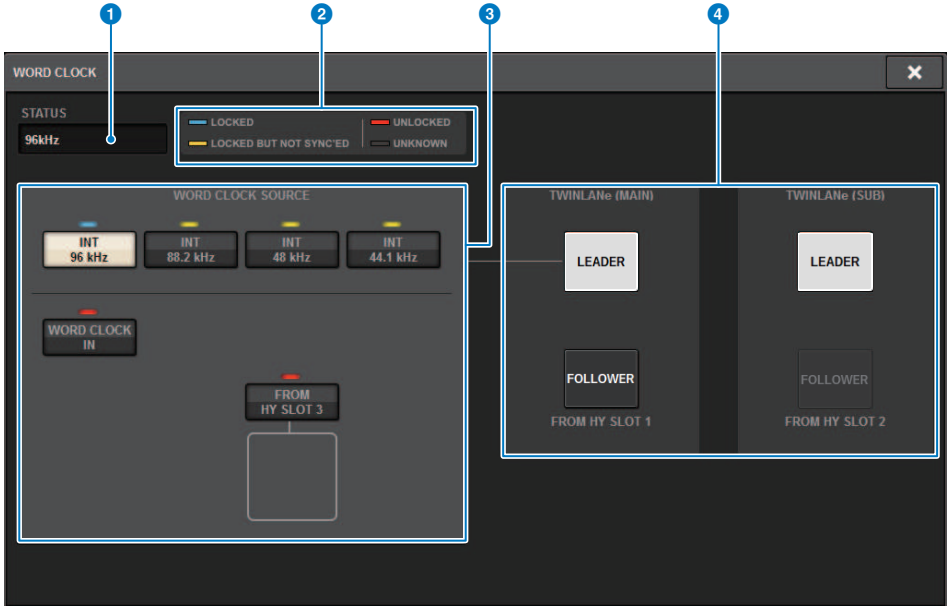

This screen contains the following items.

LEADER CLOCK SELECT field

1 Leader clock frequency display

Indicates the frequency (44.1 kHz, 48 kHz, 88.2 kHz, or 96 kHz) of the currently-selected leader clock. If the unit is not syncing to the leader clock, "UNLOCK" will appear.

2 Clock status display

Indicates the status of synchronization with the leader clock for each clock source. Each indicator is explained below.

- **LOCK (light blue)**

Indicates that a clock synchronized with the selected clock source is being input. If an external device is connected to the corresponding connector or slot, it indicates that a clock is being input or output properly between that device and the RIVAGE PM series. If the sampling frequency is close, this status may be displayed even if not synchronized.

- **LOCK, BUT NOT SYNC'ED (yellow)**

A valid clock is being input, but is not synchronized with the selected clock source. If an external device is connected to the corresponding connector, it indicates that a clock is not being input or output properly between that device and the RIVAGE PM series.

- **UNLOCK (red)**

A valid clock is not being input. If an external device is connected to the corresponding connector, a clock will not be input or output properly between that device and the RIVAGE PM series.

- **UNKNOWN (black)**

This indicates that the clock status cannot be detected because no external device is connected or because there is no valid clock input. You will be able to select this connector/slot, but successful synchronization cannot occur until a valid connection is established.

NOTE

- If the indicator for the port selected as the clock source has turned light blue, and the clock frequency appears in the upper left of the LEADER CLOCK SELECT field, this indicates that the RIVAGE PM series is operating correctly with the new clock.
- If the indicator for the selected clock does not turn light blue, make sure that the external device is correctly connected, and that the external device is set to transmit clock data.
- Noise may occur at the output jacks when the word clock setting is changed. To protect your speaker system, be sure to turn down the power amp volume before changing the word clock setting.

3 Leader clock select buttons

Use the buttons to select the clock source that you want to use as the word clock leader from the following options:

- **INT 44.1 kHz**
- **INT 48 kHz**
- **INT 88.2 kHz**
- **INT 96 kHz**

The internal clock of the DSP engine (sampling rate: 96 kHz, 88.2 kHz, 48 kHz or 44.1 kHz) will be the clock source.

- **WORD CLOCK IN**

The word clock supplied from the WORD CLOCK IN jack on the rear panel of the leader DSP engine will be used as the clock source.

- **FROM HY SLOT1-4 (or FROM HY SLOT1-3 on the CSD-R7)**

The word clock supplied from the HY card slot located on the rear panel of the DSP engine is used as the clock source.

NOTE

If the unit is initialized to the factory default status, the word clock default value will be set to 96 kHz.

4 TWINLANE network setting buttons

Use these buttons to specify operation (leader/follower) within the TWINLANE network.

Network

The RIVAGE PM series enables you to control the mixing parameters from external devices on the network using an application such as RIVAGE PM StageMix.

The setting procedure is described below.

1 Press the **SETUP** button on the menu bar to access the **SETUP** screen.

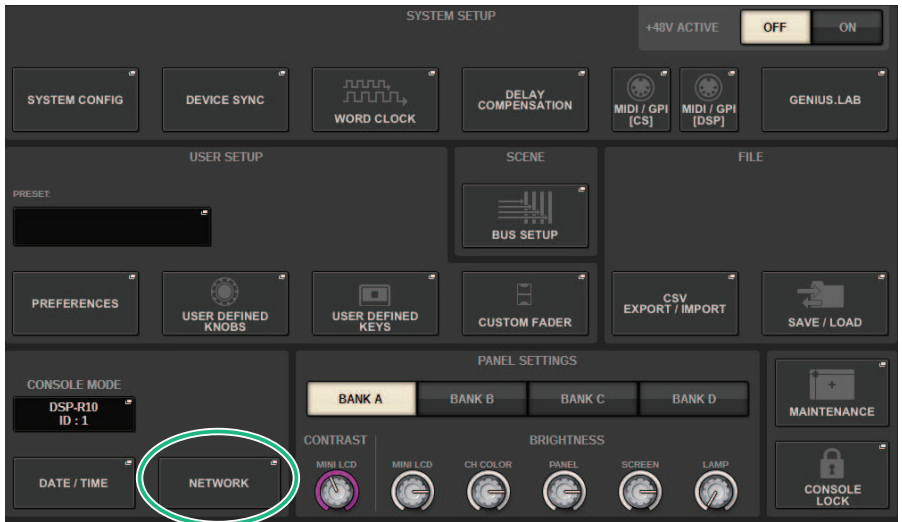

2 Press the **NETWORK** button. The **NETWORK** popup window appears.

3 Make network settings as needed.

The CONSOLE IP SETTING includes settings for RIVAGE PM StageMix, and the DSP ENGINE IP SETTING includes settings for MonitorMix.

4 To close the **NETWORK** popup window, press the “x” symbol located in the upper right. The system will return to the **SETUP** screen.

NETWORK screen: FOR MIXER CONTROL tab

In this section, you will configure the network settings for connecting applications for wireless control of the PM series, such as StageMix and MonitorMix, and for using the OSC SERVER.

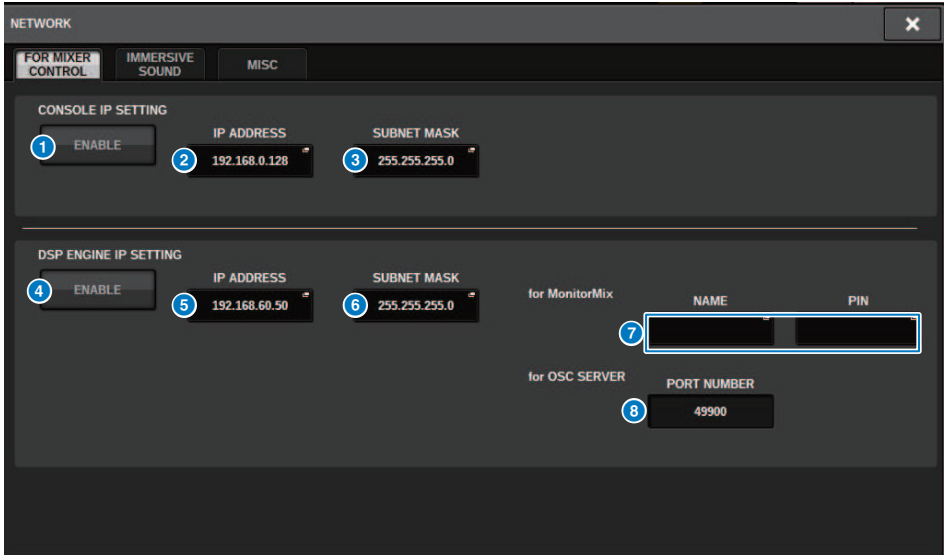

This window contains the following items.

The CONSOLE IP SETTING includes settings for RIVAGE PM StageMix, and the DSP ENGINE IP SETTING includes settings for MonitorMix or the OSC SERVER.

CONSOLE IP SETTING

1 ENABLE button

When you press this button to set it to ENABLE, a connection can be made from RIVAGE PM StageMix.

2 IP ADDRESS button

Specifies the IP address of the control surface. Press this button to open the settings screen.

3 SUBNET MASK button

This defines the bits used for the network address that identifies the network, out of the IP addresses used in the network. Press this button to open the settings screen.

DSP ENGINE IP SETTING

4 ENABLE button

When you press this button to set it to ENABLE, a connection can be made from MonitorMix.

5 IP ADDRESS button

Sets the IP address of the DSP engine. Press this button to open the settings screen.

6 SUBNET MASK button

This defines the bits used for the network address that identifies the network, out of the IP addresses used in the network. Press this button to open the settings screen.

7 for MonitorMix

Sets the NAME and PIN used by MonitorMix. NAME is the name to confirm before connecting, and PIN (Personal Identification Number) is the number for authentication that is asked for right after connecting. Press this button to open the settings screen.

8 for OSC SERVER

The port number used by OSC SERVER is fixed (at 49900).

NETWORK screen: IMMERSIVE SOUND tab

The RIVAGE PM series supports AFC IMAGE control and the control of L-ACOUSTICS Immersive Sound System "L-ISA".

Please consult your Yamaha dealer for more information.

The screenshot displays the NETWORK configuration interface for the IMMERSIVE SOUND tab. At the top, there are three tabs: "FOR MIXER CONTROL", "IMMERSIVE SOUND" (which is active), and "MISC". Below the tabs, the "L-ISA DEVICE" section contains a "VIRTUAL" button. The main area is divided into two panels: "NETWORK CONSOLE" and "PREFERENCE".

NETWORK CONSOLE

IP ADDRESS	PORT NUMBER
192.168.60.50	8880
SUBNET MASK	
255.255.255.0	

L-ISA

IP ADDRESS	PORT NUMBER
192.168.60.32	49900

PREFERENCE

SCREEN CHANNEL SELECTION SYNC

BAY L	ON
BAY C	ON
BAY R	ON

Dante audio network settings

Here's how to make Dante audio network settings for the RIVAGE PM series and the connected I/O racks. By mounting an I/O rack you can use routing and HA remote operations.

1 Press the **SETUP** button to access the **SETUP** screen.

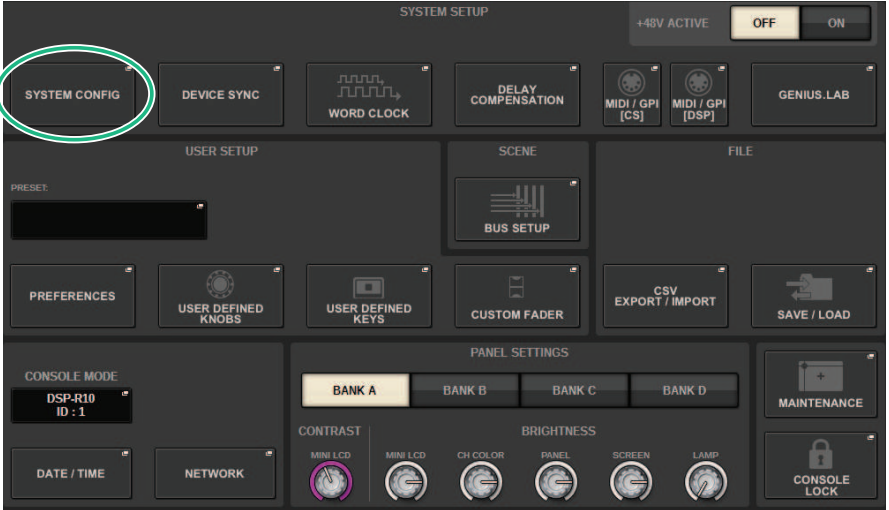

2 Press the **SYSTEM CONFIG** button to access the **SYSTEM CONFIG** popup window.

3 Press the target **HY SLOT** tab.

The “HY SLOT window” (p.299) appears.

4 Press the **DANTE SETUP** popup button.

The DANTE SETUP popup window appears.

5 When you finish making settings, press the **x** button to close the **DANTE SETUP** popup window.

HY SLOT window



This window contains the following items.

1 HY CARD popup button

Press a button to open the HY CARD SELECT popup window, in which you can select a Dante-enabled HY card.

2 NETWORK popup button

Press this button to access the NETWORK popup window, in which you can make IP address settings. Normally, the IP address is obtained automatically, so it is not necessary to change the setting. Specify this manually as necessary.



AUTO (DHCP)... The IP address is obtained automatically.

STATIC IP The IP address is specified manually.

- 3 **DANTE SETUP popup button**
Press this button to access the DANTE SETUP popup window, in which you can make settings for Dante-enabled HY cards.
- 4 **REFRESH button**
Press this button to update the I/O rack information in the Dante audio network to its latest state.
- 5 **DEVICE RACK USAGE indication**
This shows the state of IO rack resource usage.
- 6 **I/O rack select button**
This indicates the I/O rack's ID number, model name, and the number of inputs/outputs. When you press this, the DEVICE SELECT screen or DANTE I/O DEVICE screen appears, allowing you to mount an I/O rack.
- 7 **DANTE INPUT PATCH button**
When you press this, the DANTE PATCH popup window's INPUT tab appears, allowing you to select the channels that will be input from the I/O rack to the Dante-enabled HY card.
- 8 **DANTE OUTPUT PATCH button**
When you press this button, the DANTE PATCH popup window's OUTPUT tab appears, allowing you to select the channels that will be output from the Dante-enabled HY card to the I/O rack.
- 9 **CLEAR ALL button**
When you press this button, the mounted state of all displayed I/O racks is cleared.

DANTE SETUP popup window

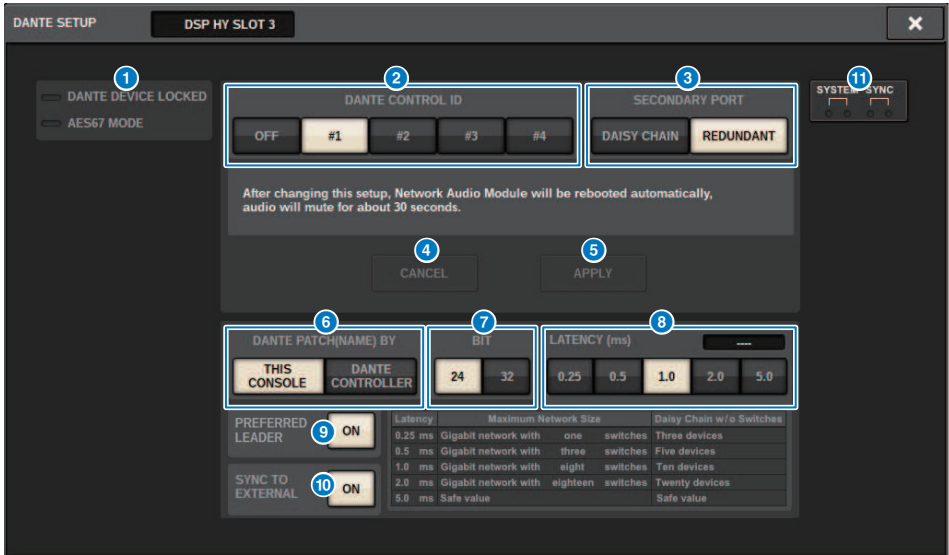

This screen contains the following items.

1 STATUS indicator

- **DANTE DEVICE LOCKED**

The indicator is lit red if the Dante Device Lock function is enabled, preventing the audio network settings of the Dante device from being changed.

- **AES67 MODE**

The indicator is lit green if AES67 (audio network compatibility connection standard) mode is enabled.

2 DANTE CONTROL ID button

These buttons specify the ID used to distinguish compatible HY cards on the Dante audio network. If the ID is turned OFF, the DANTE PATCH BY select button is fixed at DANTE CONTROLLER, and Dante patching cannot be edited. Additionally, the remote functionality of the mounted I/O racks is disabled. If you specify ID #1, the shared settings (BIT/LATENCY/WORD CLOCK) are also applied to the mounted I/O racks.

NOTE

Assign different IDs to the control surfaces and digital mixing consoles on the Dante audio network.

3 SECONDARY PORT select buttons

These buttons select how the Dante-enabled HY cards are connected: either the daisy chain connection used for simple systems with a small number of connected units, or the redundant connection used when connecting multiple units.

4 CANCEL button

This button cancels the temporarily edited content during the process of editing DANTE CONTROLLER I/O for SLOT or SECONDARY PORT.

5 APPLY button

If you have edited the DANTE CONTROLLER ID for SLOT setting or the SECONDARY PORT setting, the settings are applied when you press this button. A dialog box will ask you to confirm the change.

6 DANTE PATCH BY select buttons

If the THIS CONSOLE button is selected, Dante patching can be modified from the RIVAGE PM series. If the DANTE CONTROLLER button is selected, Dante patching cannot be controlled.

7 BIT select buttons

These buttons select either 24 bits or 32 bits as the bit depth of the Dante audio network.

8 LATENCY select buttons

These buttons select either 0.25 ms, 0.5 ms, 1.0 ms, 2.0 ms, or 5.0 ms as the latency of the Dante audio network.

9 PREFERRED LEADER button

Turning this ON raises the unit's order of priority for being the leader within the Dante audio network.

10 SYNC TO EXTERNAL button

When this is turned on, the unit will sync to the word clock supplied from the HY slot.

11 SYSTEM/SYNC indicators

These indicators show the state of Dante operation. When you press an indicator, a message is shown. For patterns that indicate a message, an error icon and information icon are shown beside the indicators. For details on what the indicators show, refer to "Messages" which follows.

For DDM SETTING

STATE

Indicates the status of joining the domain.

- **Domain:** Has joined the domain.
- **Disconnected:** Has joined the domain, but is not connected to the DDM server.
- **Unmanaged:** Has not joined the domain.

LOCAL

Displays the access status for the Dante settings (including the DANTE PATCH) that are currently being operated for this unit.

- **Read Write:** Can be modified.
- **Read Only:** Cannot be modified.

REMOTE

Shows the access status for the Dante settings of an external Dante device.

- **Operator:** Can read/write
- **Guest:** Read only, cannot modify
- **None:** Cannot read

System Setup > DANTE SETUP popup window

Latency display

Displays the currently-selected latency. “----” is shown when offline.

Dante messages

Errors, warnings, and certain other types of information are displayed via the Rio front panel indicators. Messages are also displayed in the Dante Controller Error Status field. Each indicator lights or flashes as described below:

No call-out	The indicator is off.
Light	The indicator remains lit steadily.
Flash	The indicator continues to flash.
Flash x2	The indicator flashes twice cyclically.
Flash x3	The indicator flashes three times cyclically.

Error Messages

If one of the following errors has occurred, the device will not operate. Until the error is resolved, the green SYSTEM indicator will be turned off, and all indicators for all I/O channels will continue to flash. In addition, certain errors will cause the red SYSTEM indicator to light or flash.

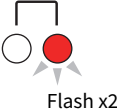
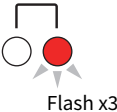
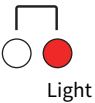
[SYSNC] Indicators	Meaning	Possible Solution
<p>SYSTEM</p>  <p>Flash x2</p>	An internal error has occurred.	The device has failed. Contact your Yamaha dealer for repair.
<p>SYSTEM</p>  <p>Flash x3</p>	Communication cannot occur because the MAC address setting has been corrupted.	The device has failed. Contact your Yamaha dealer for repair.
<p>SYSTEM</p>  <p>Light</p>	UNIT ID is not unique.	Set a unique UNIT ID number within the Dante network.

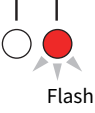
[SYSNC] Indicators	Meaning	Possible Solution
<p style="text-align: center;">SYSTEM</p>  <p style="text-align: center;">Flash</p>	<p>The device's DIP switches are not set correctly.</p>	<p>Check the DIP switch settings, and set them correctly.</p>

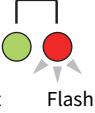
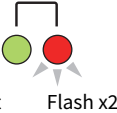
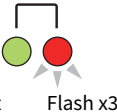

The following errors affect the settings or the hardware. However, the device will still be usable. The green SYSTEM indicator will light, and all indicators for all I/O channels will work normally. In addition, certain errors will cause the red SYSTEM indicator to light or flash.

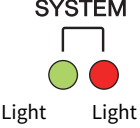
[SYSTEM] Indicators	Meaning	Possible Solution
<p style="text-align: center;">SYSTEM</p>  <p style="text-align: center;">Light Flash</p>	<p>The number of Dante transmit flows exceeded the limit.</p>	<p>Reduce the number of flows by, for example, using Dante Controller to change some of the transmit flows to multicast.</p>
<p style="text-align: center;">SYSTEM</p>  <p style="text-align: center;">Light Flash x2</p>	<p>The cooling fan has stopped.</p>	<p>Check that nothing is caught in the fan. If the problem persists, consult your Yamaha dealer.</p>
<p style="text-align: center;">SYSTEM</p>  <p style="text-align: center;">Light Flash x3</p>	<p>The internal memory has been corrupted.</p>	<p>When using the unit in [NORMAL] mode, if the problem persists even after turning the power off and on again, consult your Yamaha dealer.</p>



[SYSTEM] Indicators	Meaning	Possible Solution
<p style="text-align: center;">SYSTEM</p>  <p style="text-align: center;">Light Light</p>	<p>You changed the positions of the device setting DIP switches or rotary switch, or changed the Dante settings from Dante Controller. Therefore, the positions of the device setting DIP switches do not match the actual Dante settings.</p>	<p>If the Device Lock setting was enabled from Dante Controller, disable the setting, or check the device setting DIP switch positions, and set them to accommodate the current situation.</p>

Warning Messages

The indicators will light and/or flash as shown until the cause is resolved. If the green [SYNC] indicator is unlit, the unit's clock is unconfirmed.

[SYSNC] Indicators	Meaning	Possible Solution
<p style="text-align: center;">SYNC</p>  <p style="text-align: center;">Flash</p>	<p>The word clock is not set correctly.</p>	<p>Set the clock leader and sampling frequency correctly on the Rio-native device or in Dante Controller.</p>
<p style="text-align: center;">SYNC</p>  <p style="text-align: center;">Flash x2</p>	<p>Dante Network circuit is broken.</p>	<p>Make sure that the Ethernet cables are not removed or short-circuited.</p>
<p style="text-align: center;">SYNC</p>  <p style="text-align: center;">Flash x3</p>	<p>Other Dante-compatible devices cannot be found due to an incorrectly-wired Dante Network.</p>	<p>Make sure that the Ethernet cables are connected correctly.</p>

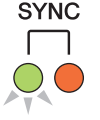

If the green indicator is flashing, the unit is the clock leader. If the green indicator is lit, the unit is the clock follower and the clock is synchronized.

[SYSNC] Indicators	Meaning	Possible Solution
 <p>Light or flash Light or flash</p>	<p>A non-GbE-compatible device is connected.</p>	<p>When transferring audio via Dante, use device that supports GbE.</p>
 <p>Light or flash Flash</p>	<p>The [SECONDARY] connector has taken over communications during redundant network operation.</p>	<p>Check the circuit connected to the [PRIMARY] connector.</p>
 <p>Light or flash Flash x2</p>	<p>An abnormality has occurred on the circuit connected to the [SECONDARY] connector during redundant network operation.</p>	<p>Check the circuit connected to the [SECONDARY] connector.</p>

Information Messages

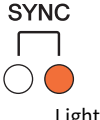
The indicators will remain lit and/or flashing cyclically to report the status. If the orange [SYNC] indicator is unlit, the unit is operating normally. If the green [SYNC] indicator is unlit, the unit's clock is unconfirmed.

[SYSNC] Indicators	Meaning	Possible Solution
 <p>Light</p>	<p>Synchronizing on Dante network</p>	<p>Please wait until started has completed or until the unit has finished synchronization. It may take up to 45 seconds for completion.</p>
	<p>Waiting to receive setting data</p>	<p>If START UP MODE is set to REFRESH on the R-series unit, the input/output will be muted until the unit receives setting data after it starts up.</p>

[SYSNC] Indicators	Meaning	Possible Solution
<p style="text-align: center;">SYNC</p>  <p>Flash</p>	<p>The unit is functioning correctly as the word clock leader.</p>	<p>The unit is operating as the word clock leader.</p>
<p style="text-align: center;">SYNC</p>  <p>Light</p>	<p>The unit is functioning correctly as the word clock follower.</p>	<p>The unit is operating as the clock follower and the clock is synchronized.</p>

Mounting an I/O rack

Here's how to select a device from the multiple I/O racks on the Dante audio network, and mount that device.

1 Press the **SETUP** button on the menu bar to access the **SETUP** screen.

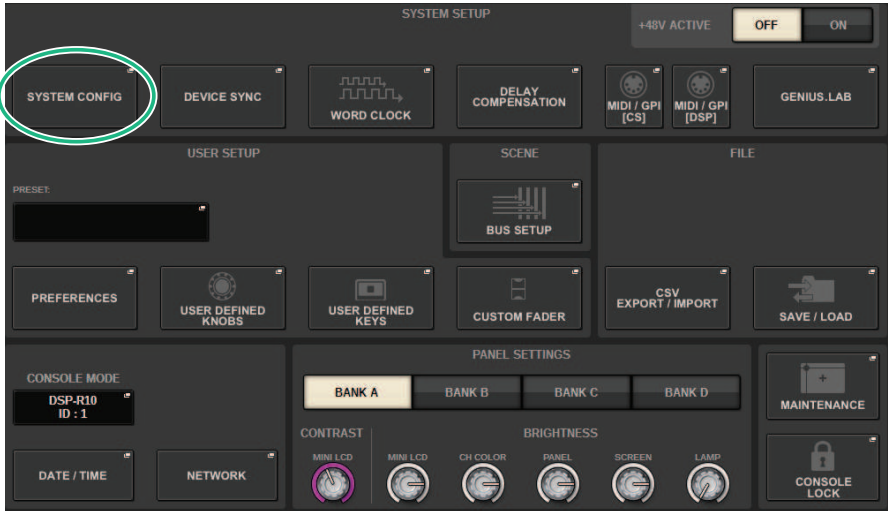

2 Press the **SYSTEM CONFIG** button to access the **SYSTEM CONFIG** popup window.

3 Press the **HY SLOT** tab (for the slot in which the Dante network card is mounted) to access the **HY SLOT** window.

NOTE

On the CSD-R7, press the HY SLOT2 tab to access the HY SLOT2 screen.

4 Press a vacant **I/O rack select** button.

The “DEVICE SELECT popup window” (p.310) appears.

5 Select the mounting method, and mount the **I/O rack**.

6 When you finish making settings, press the **x** button to close the **DEVICE SELECT** popup window.

DEVICE SELECT popup window

This window includes several pages, which you can switch between using the buttons located at the top of the window.

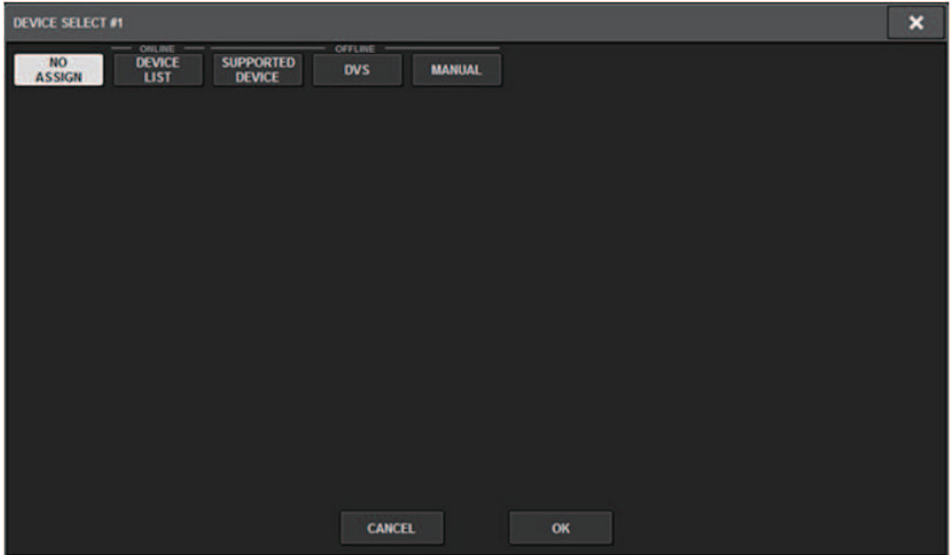

NO ASSIGN Unmount

DEVICE LIST Select an online I/O rack, and mount

SUPPORTED DEVICE Select from a list of supported devices, and mount

DVS Enter a device label, and mount (only for Dante Virtual Soundcard)

MANUAL Enter a device label, and mount

DEVICE LIST

Here's how to select a device from a list of I/O racks on the Dante audio network, and mount that device.

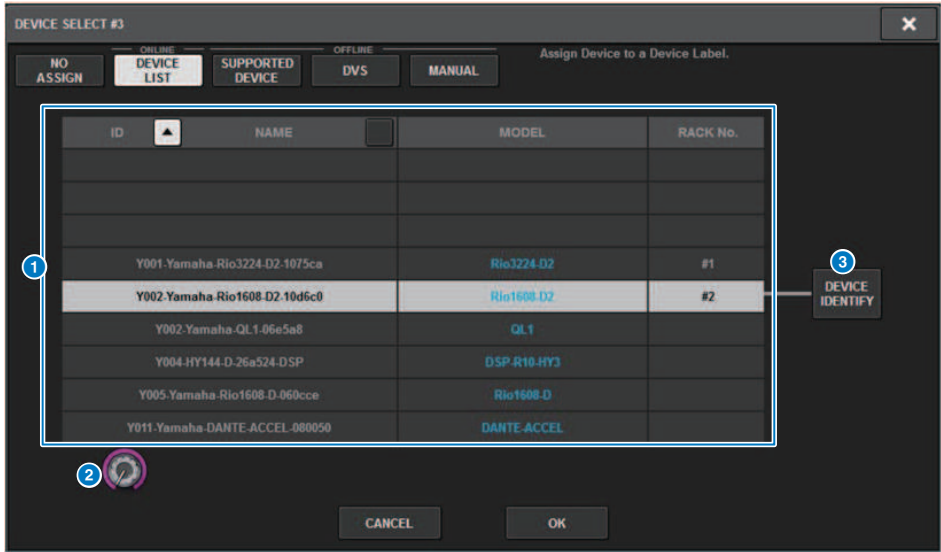

1 DEVICE LIST

This shows a list of the I/O racks on the Dante audio network. From the list, select the I/O rack that you want to mount.

NOTE

After the MODEL information appears in blue text, press the OK button to mount the device. If you press the OK button before this indication appears, the device is not recognized as a supported device. If an identical I/O rack of the identical UNIT ID is already mounted, the OK button is disabled, and the unit cannot be mounted.

2 DEVICE LIST select knob

Use the [TOUCH AND TURN] knob to operate this, to select the I/O rack that you want to mount.

3 DEVICE IDENTIFY button

This button is available in the case of an I/O rack that is equipped with a DEVICE IDENTIFY function; you can press the button to identify that device.

SUPPORTED DEVICE

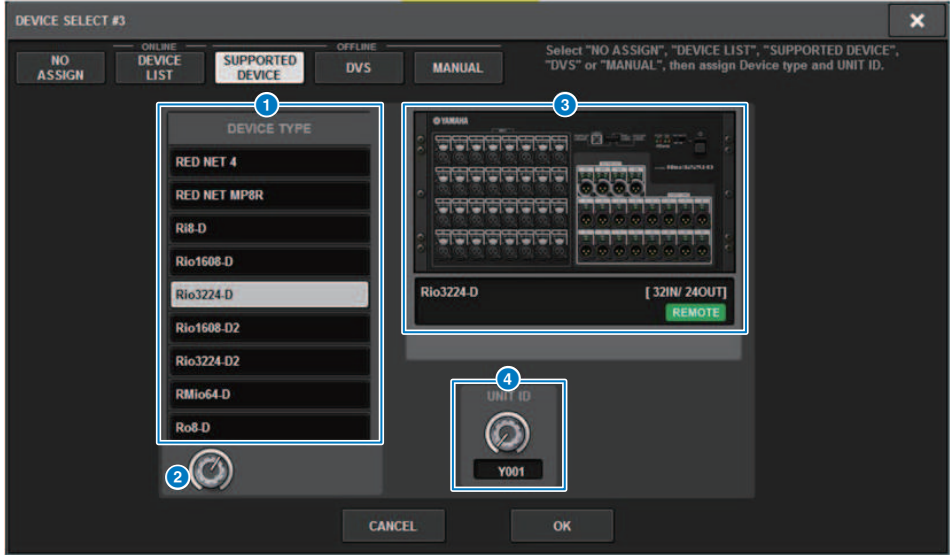

Here you can select from the supported I/O racks, and mount a device offline.

1 DEVICE TYPE

This shows a list of the supported I/O rack types. From the list, select the type of I/O rack that you want to mount.

NOTE

If an identical I/O rack of the identical UNIT ID is already mounted, the OK button is disabled, and the unit cannot be mounted.

2 DEVICE TYPE select knob

Use the [TOUCH AND TURN] knob to operate this, to select the type of I/O rack that you want to mount.

3 I/O rack indication

The selected I/O rack is shown here. This shows the model name, the number of inputs and outputs, and the remote control icon (only for supported devices).

4 UNIT ID knob

Use the [TOUCH AND TURN] knob to operate this, and set the UNIT ID.

DVS or MANUAL

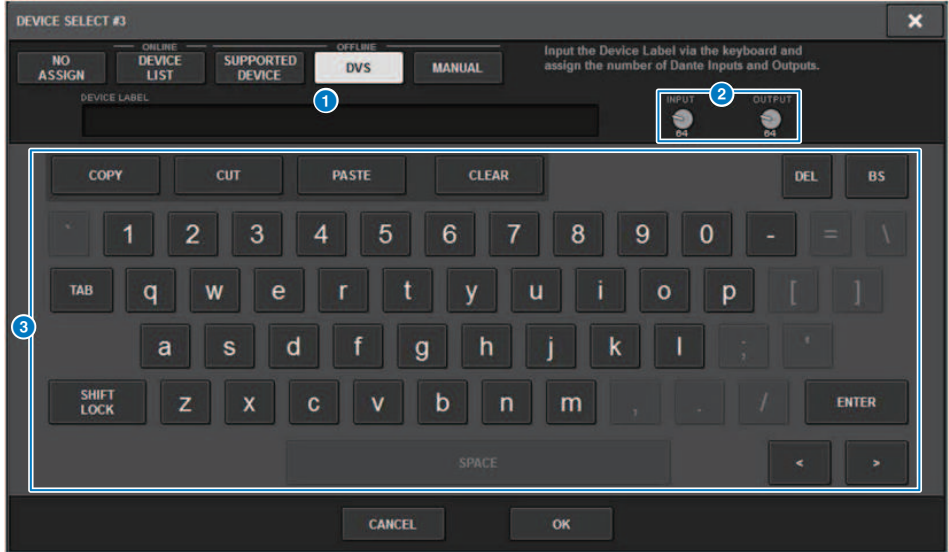

Here you can enter a device label for an I/O rack, and mount it offline.

1 DEVICE LABEL

This shows the device label of the I/O rack that you entered using the keyboard.

2 INPUT/OUTPUT knob

Use the [TOUCH AND TURN] knob to operate this, to specify the number of inputs and outputs of the Dante audio network.

3 Keyboard for device label input

Use this keyboard to enter a device label for the I/O rack.

Patching an I/O rack

Here you can patch between an I/O rack connected to a Dante connector and the Dante audio network.

1 Press the **SETUP** button to open the **SETUP** window.

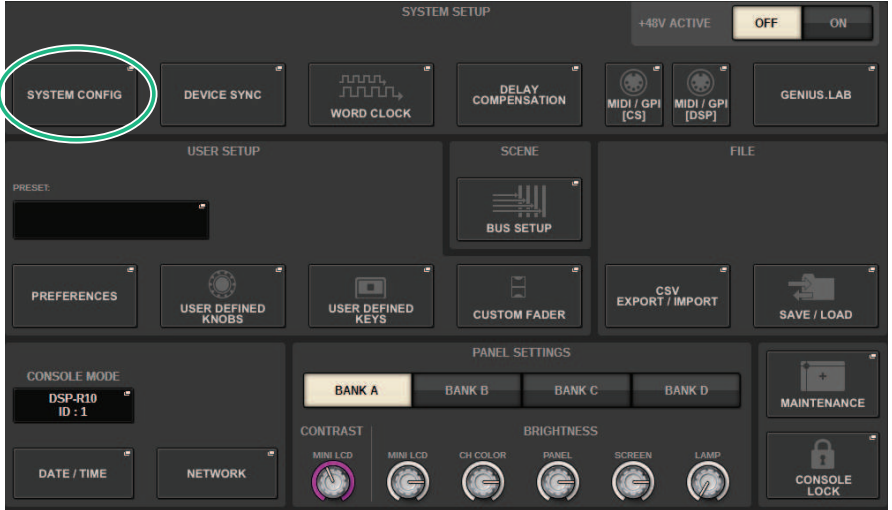

2 Press the **SYSTEM CONFIG** button to open the **SYSTEM CONFIG** popup window.

3 Press the **HY SLOT** tab with the Dante network card mounted to open the “HY SLOT window” (p.319).

NOTE

On the CSD-R7, press the HY SLOT2 tab to display the HY SLOT2 window.

4 Press the DANTE INPUT PATCH button to display the INPUT tab of the DANTE PATCH popup window.

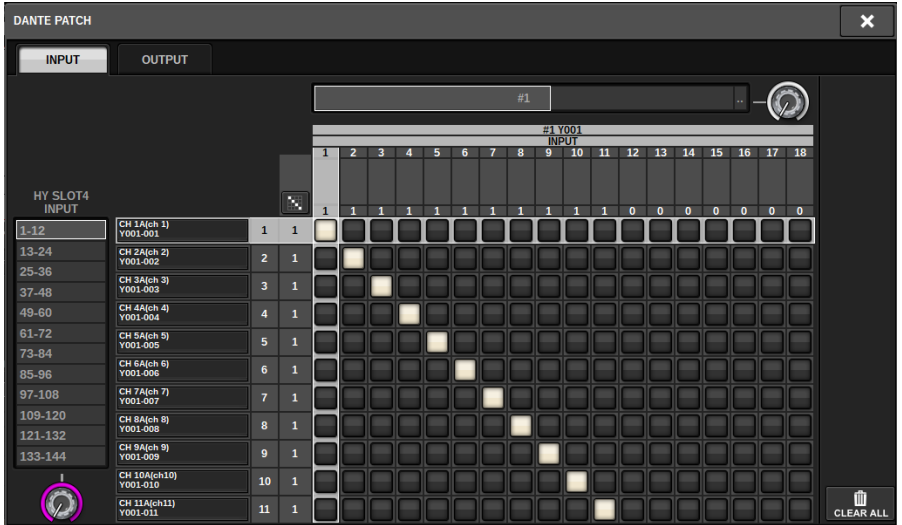

Specify the patching that will be input from the I/O rack to the Dante-enabled HY card.

NOTE

Unrecognized devices are displayed as ETC.

5 Press the OUTPUT tab to display the OUTPUT tab of the DANTE PATCH popup window.

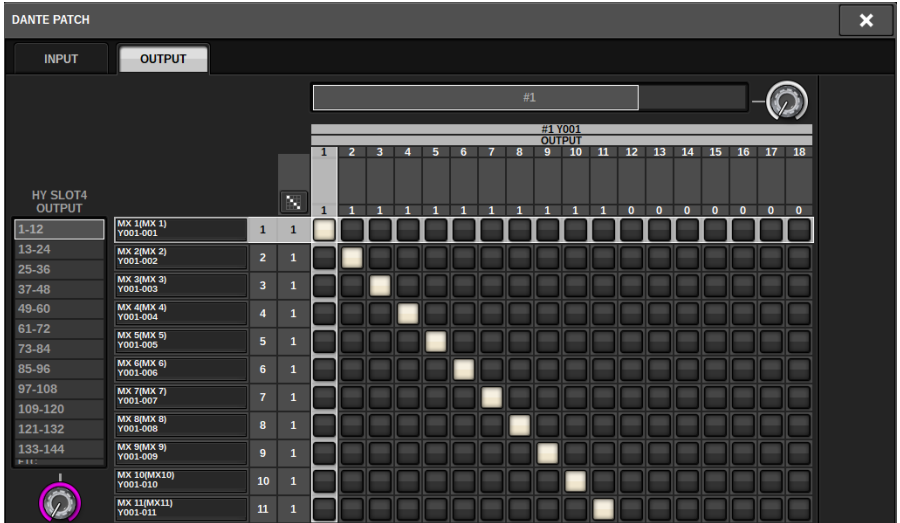

Specify the patching that will be output from the Dante-enabled HY card to the I/O rack.

NOTE

- Unrecognized devices are displayed as ETC.
- If the following are mounted, the grid is grayed out and cannot be changed.
 - CL5/CL3/CL1, QL5/QL1, CSD-R7-HY1/HY2/HY3, DSP-R10-HY1/HY2/HY3/HY4, DSP-RX-HY1/HY2/HY3/HY4, DSP-RXEX-HY1/HY2/HY3/HY4, DM7/DM7Compact

6 When you finish making settings, press the × button to close the DANTE PATCH popup window.

NOTE

To input and output signals from the I/O rack, it is necessary to patch the input channels and output channels with a Dante-enabled HY card.

Remotely controlling an I/O rack

You can control an I/O rack that supports remote control and is connected to the Dante connector. Supported models are indicated by a remote control icon. Up to 24 units can be mounted per Dante network card. In addition, up to 48 units can be controlled, and a maximum of 128 channels per device can be controlled.

1 Press the **SETUP** button on the menu bar to access the **SETUP** screen.

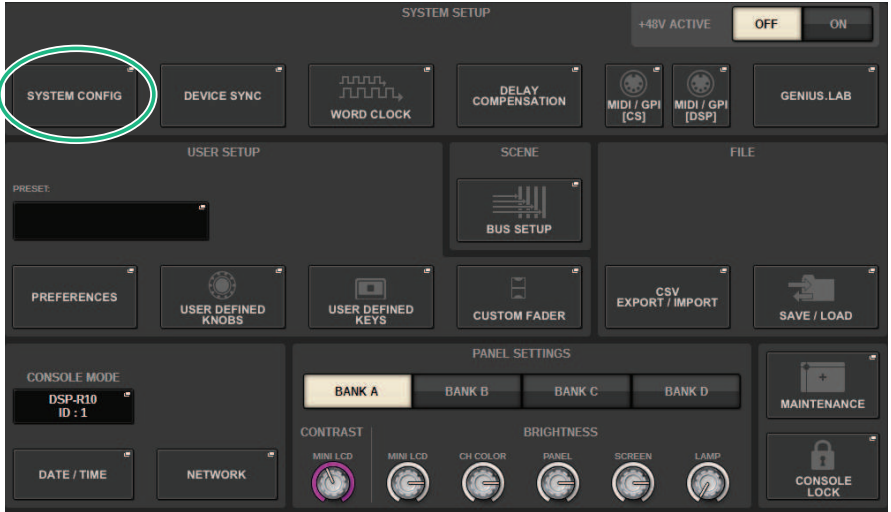

2 Press the **SYSTEM CONFIG** button to access the **SYSTEM CONFIG** popup window.

3 Press the **HY SLOT** tab (for the slot in which the Dante network card is mounted).

The “HY SLOT window” (p.319) appears.

NOTE

On the CSD-R7, press the HY SLOT2 tab to access the HY SLOT2 screen.

4 Press the **I/O rack select** button for an **HA-equipped I/O rack** that is mounted.

The DANTE I/O DEVICE [I/O] screen appears.

5 Remotely control the **HA** of the **I/O rack**.

Control the HA of the I/O rack from the Selected Channel section, the OVERVIEW screen, or the SELECTED CHANNEL VIEW screen. When you press the panel’s [SEL] key, the signal indicator of the I/O rack port to which the corresponding channel is patched will flash. Operations can also be performed from the I/O DEVICE popup window that appears when you press the HA display area of the I/O rack.

- 6** When you finish making settings, press the x button to close the DANTE I/O DEVICE [I/O] screen.
- 7** As necessary, make output port settings.
- 8** When you finish making settings, press the x button to close the DANTE PATCH popup window.

HY SLOT window

This screen contains the following items.

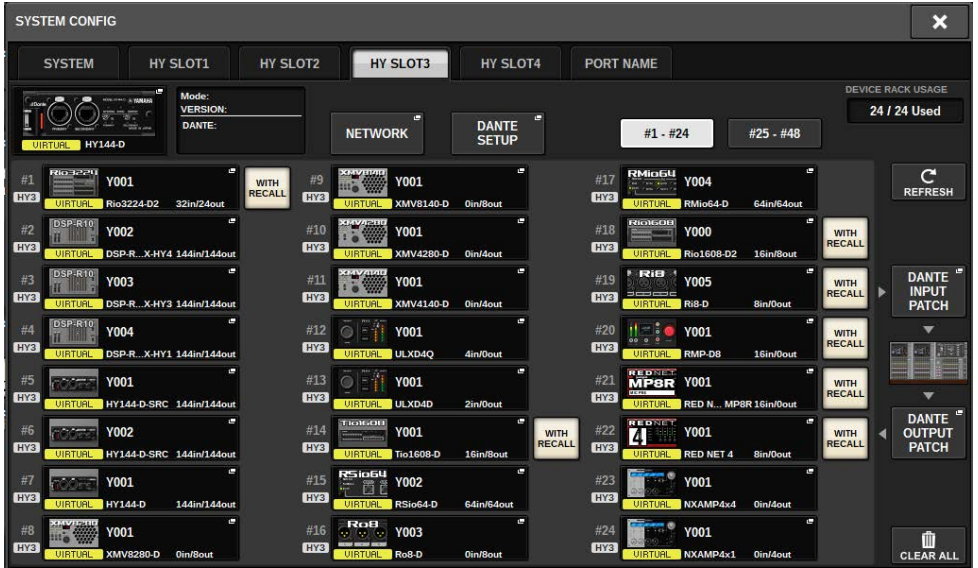

Control status icon

This indicates the control status of the device.

	Previously specified, and currently not existing on the Dante audio network ¹
	Devices of a different DEVICE TYPE and the identical ID are connected ²
	Multiple instances of the same ID exist ¹
	Operating in AES67 mode
	Dante Device Lock is on ³
	The DANTE CONTROLLER ID for SLOT3 select button (for the CSD-R7, HY SLOT2 popup button) is off, and the device is controlling as a Dante Controller
	There is a mismatch between versions of the Dante-enabled HY card and the device. ¹

¹ Remote control is not possible.

² Remote control is possible, but some functionality is limited. (For example, such as if a Rio1608-D is mounted, and is then replaced by a Rio3216-D of the identical ID.)

³ It is not possible to edit Dante audio network settings such as the parameters of the DANTE SETUP popup window on any device other than the specified PC.

WITH RECALL button

System Setup > HY SLOT window



If this button is on, the information saved in the RIVAGE PM series unit is applied to the HA device when scene recall is performed while connected to the applicable I/O rack.

DANTE I/O DEVICE [I/O] screen

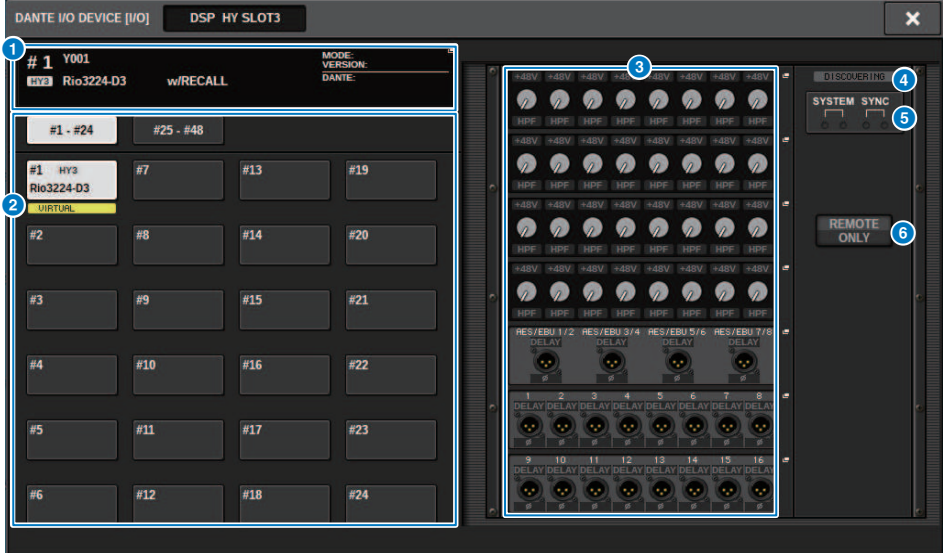

This screen contains the following items.

1 I/O rack button

This indicates the I/O rack's ID number and model name. Press this button to display the RACK MOUNT popup window, in which you can select an I/O rack to mount.

2 Display select buttons

Press a button to display the corresponding I/O rack.

3 I/O rack indication

When you press the HA display area, the I/O DEVICE popup window appears; when you press the output connector area, the OUTPUT tab of the DANTE PATCH popup window or the I/O DEVICE screen: OUTPUT (Rio3224-D3, Rio1608-D3) appears.

4 Control status icon

This indicates the control status of the device.

DISCOVERING	Searching for the device to be controlled
DECLINED	The device to be controlled was discovered, but connection was declined
CONNECTING	Attempting to connect to the device
SYNCHRONIZING	Synchronizing with the device
CONTROLLABLE	The device can be controlled

5 SYSTEM/SYNC indicators

These indicate messages such as errors, warnings, and information. For details on the messages, refer to “Messages.”

System Setup > DANTE I/O DEVICE [I/O] screen

6 REMOTE ONLY button (Rio3224-D2, Rio1608-D2, Rio3224-D3 and Rio1608-D3 only)

If this is on, it will no longer be possible to perform HA operations from the panel of the I/O rack. Only devices for which With Recall is enabled can be turned on/off.

I/O DEVICE screen: HA

You can remotely control the head amp of the I/O device by using the screen encoder or the [TOUCH AND TURN] knob.



1 +48V button

These switch phantom power on/off for each channel.

2 GAIN knob

Indicates the gain of the head amp on the I/O device. To adjust the value, press the knob to select it, and use the multi-function knobs. The level meter located at the immediate right of the knob indicates the input level for the corresponding port.

NOTE

For devices with a wider setting range than the RIVAGE PM series, since some values cannot be set from the RIVAGE PM series. Likewise, if the value set on the connected device side is outside the RIVAGE PM series setting range, it will be displayed as an approximate value or limit value.

3 GC button

Switches the Gain Compensation function on or off, which maintains a consistent signal level on the audio network.

4 FREQUENCY knob/HPF button

These controllers switch on or off the high-pass filter built into the head amp of the I/O device, and adjust its cutoff frequency. If you press the FREQUENCY knob to select it, you can adjust it by using the corresponding multi-function knob.

System Setup > I/O DEVICE screen: HA

NOTE

For devices that differ in how the setting value changes from the RIVAGE PM series, the cutoff frequency will be set as an approximate value.

I/O DEVICE screen: OUTPUT



This screen contains the following items.

1 Patch indication

Indicates the channel that is patched.

2 DELAY button

Switches the output delay on or off.

3 Delay time knob

Sets the delay time of the output port. If you press this knob when it is selected, the DELAY TIME popup window will appear. The delay time value is shown above the knob in millisecond units, and below the knob in the units that are selected in the DELAY SCALE popup window.

NOTE

If the scale is set to ms, the delay time value above the knob will not be shown.

4 PHASE button

Switches the phase of the signal that is output.

5 GAIN knob

Adjusts the output gain of the output port. Use the screen encoder to adjust the value. Adjust the setting in 1.0 dB units by turning the knob, or adjust the setting in 0.1 dB units by turning the knob while pressing it. The current value is shown immediately below the knob.

6 Level meter

Indicates the output level of the signal after level adjustment.

System Setup > I/O DEVICE screen: OUTPUT

7 DELAY SCALE popup button

Press this button to access the DELAY SCALE popup window in which you can select the unit for the delay time.

8 OUTPUT LOAD IMPEDANCE button

Press this to select the load impedance of the output terminals (600k Ω or 10k Ω).

I/O DEVICE screen: WIRELESS

Here you can set the channel name and HA. You cannot set this when the device is offline. Note that when the device is online, the settings on the device are applied.



NOTE

Displayed contents and channels will be changed depending on the device.

1 Channel name

Press this button to display the NAME screen for setting channel names on the receiver side. The number of characters that can be set varies depending on the device.

2 Frequency

Indicates the frequency that is currently set for the RF signal.

3 RX.LEVEL knob/RX.GAIN knob

Sets the gain value for the receiver. To adjust the value, touch the screen, then press the knob to select it, and use the multi-function knobs. The level meter located at the immediate right of the knob indicates the input level. The knob is not shown when the wireless device does not support this control.

4 MUTE button

Mutes the audio signal for the receiver.

5 Signal quality meter

Displays the quality of the received RF signal. The vertical axis represents signal quality, and the horizontal axis represents time, and the display of connection status is updated every second. If you move away from the transmitter, or the quality of the RF signal decreases due to the influence of disturbing radio waves, the bar graph becomes lower. It displays in purple for Shure devices, and in white for other developers' devices.

6 RF (Radio Frequency) signal meter

Shows bars to indicate the level of the RF signal. An active antenna indicator is shown on the right side. It indicates which antenna is enabled. In the Diversity mode, both A and B are shown. In the Quadversity mode, the one with the strongest level among A to D is shown.

NOTE

For details about the relationship between the number of bars and the actual strength of the RF signal, refer to the manual from each developer.

7 Battery indicator

Shows bars to indicate the remaining battery power.

NOTE

For details about the relationship between number of bars and maximum operation time, refer to the manual from each developer.

8 PORT ASSIGN button

Select these tabs to switch between the windows that specify the ports where the actual input signals are assigned.

When the port specified by the PORT ASSIGN button is patched to a channel, wireless devices can be controlled and their levels monitored from the input channel.



NOTE

- If the target device is unmounted, the parameters on the console return to their default values. If a new device is mounted and patched, that device's parameters are applied to the console.
- All port assignments for a rack are defeated only if the status of the rack is NO ASSIGN.
- Regarding the control of each developer's device, control parameters are not stored in scenes and saved in console files.
- For devices that can set both Dante Input Patch and Port Assign, if a Dante Input Patch has already been set, the Port Assign setting will be ignored.
- Shure devices can only be controlled in the lowest numbered HY slot in which the Dante network card is inserted.

BUS SETUP (Basic settings for MIX buses and MATRIX buses)

This section explains how to edit the basic settings for MIX buses and MATRIX buses, such as switching between stereo and monaural, or changing the bus type. The settings you make in the following procedure are saved as part of the scene.

1 Press the **SETUP** button to access the **SETUP** screen.

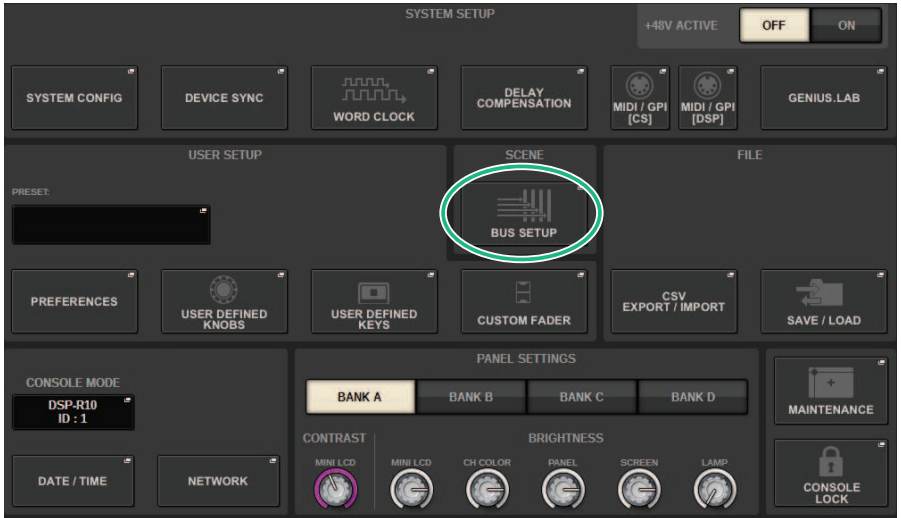

2 Press the **BUS SETUP** button to open the **BUS SETUP** popup window.

This window includes several pages, which you can switch between using the tabs located at the top of the window.



3 Press the **BUS SETUP** tab.

The “BUS SETUP page” (p.331) opens.

4 Use the tabs to display the buses for which you want to edit the settings.

5 Use the **SIGNAL TYPE** switch buttons to specify whether each bus will function as **STEREO** (main parameters will be linked for two adjacent odd-numbered/even-numbered buses) or **MONOx2** (use as two monaural channels).

6 Use the BUS TYPE select buttons to select the bus type.

BUS SETUP page

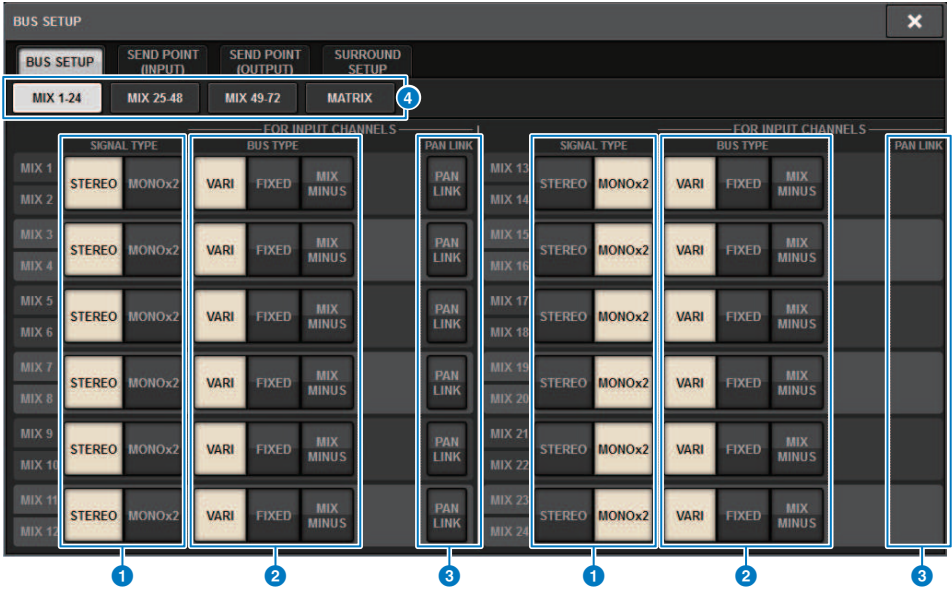

This screen contains the following items.

1 SIGNAL TYPE switch buttons

Enable you to select how signals are processed for every adjacent pair of buses. You can select either STEREO (stereo signal) or MONOx2 (monaural signal x 2).

2 BUS TYPE select buttons

Enable you to select the bus type for every adjacent pair of buses. You can select VARI (adjustable send level), FIXED (fixed send level), or mix minus.

3 PAN LINK button

This button will be displayed only if SIGNAL TYPE is STEREO and the bus type is set to VARI. If the button is on, the signals routed to the corresponding channels will link with the TO STEREO pan setting.

4 Tabs

Switch between MIX1-24, MIX25-48, MIX49-72 and MATRIX bus.

SEND POINT (INPUT) (Specifying the send point for each input channel)

1 Press the **SETUP** button to access the **SETUP** screen.

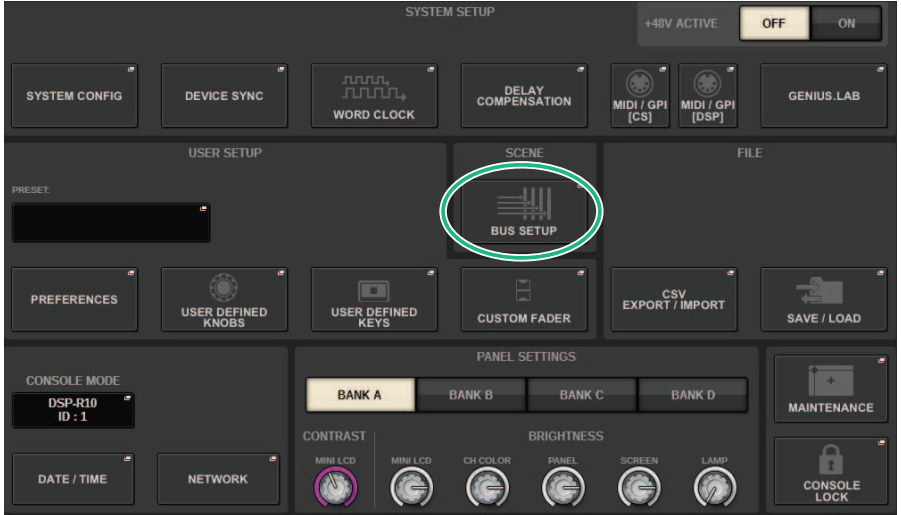

2 Press the **BUS SETUP** button to open the **BUS SETUP** popup window.

This window includes several pages, which you can switch between using the tabs located at the top of the window.

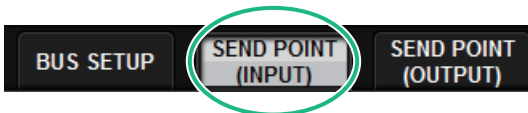

3 Press the **SEND POINT (INPUT)** tab.

The “SEND POINT page” (p.333) opens.

4 Use the send point select buttons to set the send point.

SEND POINT page

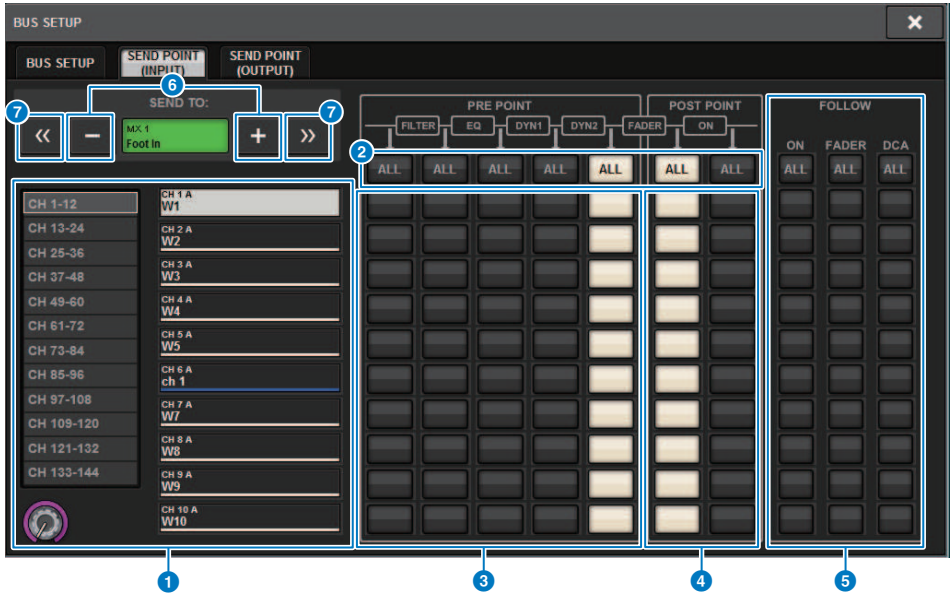

This screen contains the following items.

1 Channel select list

Enables you to select a channel.

2 ALL button

Press this button to apply the selected send point to all channels simultaneously. If the send point is not selected for some channels in the column, “...” will appear.

3 PRE send point select buttons

Enable you to select the send point for each channel for which PRE is turned on. These buttons correspond to the following parameters.

Button	Send Point
PRE FILTER	Immediately before the filter
PRE EQ	Immediately before the EQ
PRE DYN1	Immediately before DYNAMICS1
PRE DYN2	Immediately before DYNAMICS2
PRE FADER	Immediately before the fader

4 POST send point select buttons

Enable you to select the send point for each channels for which PRE is turned off (POST). These buttons correspond to the following parameters.

Buttons	Send Point
POST FADER	Immediately after the fader
POST ON	Immediately after the [ON] key

5 FOLLOW setting buttons

Enable you to select for each channel whether the signal sent to the MIX/MATRIX bus will follow the ON/FADER/DCA settings regardless of the send point. These buttons correspond to the following parameters.

Buttons	Setting
ON	FOLLOW ON
FADER	FOLLOW FADER
DCA	FOLLOW DCA

6 SEND TO [+]/[-] buttons

Enable you to select the MIX/MATRIX bus channel as the signal destination for one channel at a time.

7 SEND TO [<<]/[>>] buttons

Enable you to select the MIX/MATRIX bus channel as the signal destination for 12 channels at a time.

Mix minus

This function removes only the signal of a specified channel from the signal that is sent to the MIX/MATRIX bus. By using this, you can quickly send to a performer or announcer a monitor signal that omits only the voice of that person. You can make mix minus settings ahead of time, and then specify the OWNER channel to associate an announcer's mic (input channel) at their location with their monitor (mix minus bus).

1 Press the **SETUP** button to access the **SETUP** screen.

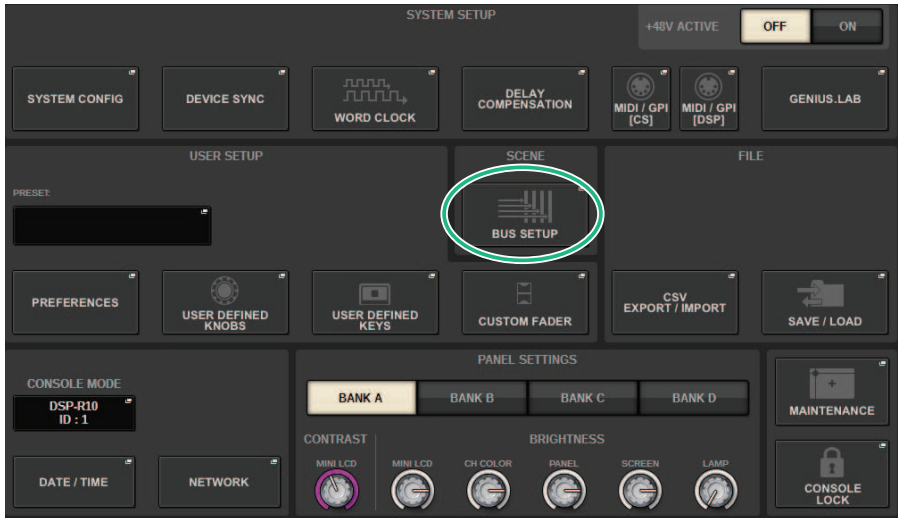

2 Press the **BUS SETUP** button.

The “BUS SETUP popup window” (p.337) appears.

3 Press the **BUS SETUP** tab.

4 Press the **MIX MINUS** button.

NOTE

- The send level of the signal sent from the selected OWNER channel is lowered to $-\infty$ dB.
- The send levels of all signals sent from input channels other than the selected channel are set to nominal level (0.0 dB).
- Also, send to the send-destination bus is turned on, and the send point is switched to POST.
- For a stereo input channel, the send levels of both signals sent from the two channels are lowered to $-\infty$ dB.

5 Press the **MIX MINUS OWNER** button.

The “MIX MINUS OWNER popup window” (p.338) appears.

6 Select the **OWNER** channel.

NOTE

Even in the OWNER screen, you can hold down the [SHIFT] key and use the N-1 OWNER button to make a selection.

7 Press the OK button.

The send that is sent from the selected OWNER channel is turned off.

BUS SETUP popup window

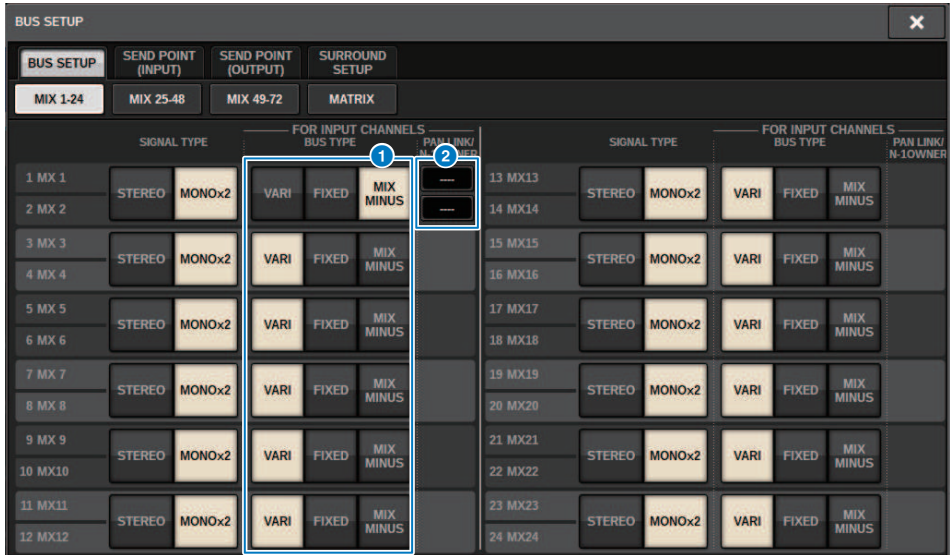

This screen contains the following items.

1 BUS TYPE select buttons

Enable you to select the bus type for every adjacent pair of buses. You can select VARI (variable send level), FIXED (fixed send level), or MIX MINUS.

2 N-1 OWNER button

Press this to access the MIX MINUS OWNER popup window, where you can select the OWNER channel for the mix minus setting.

MIX MINUS OWNER popup window

This screen contains the following items.

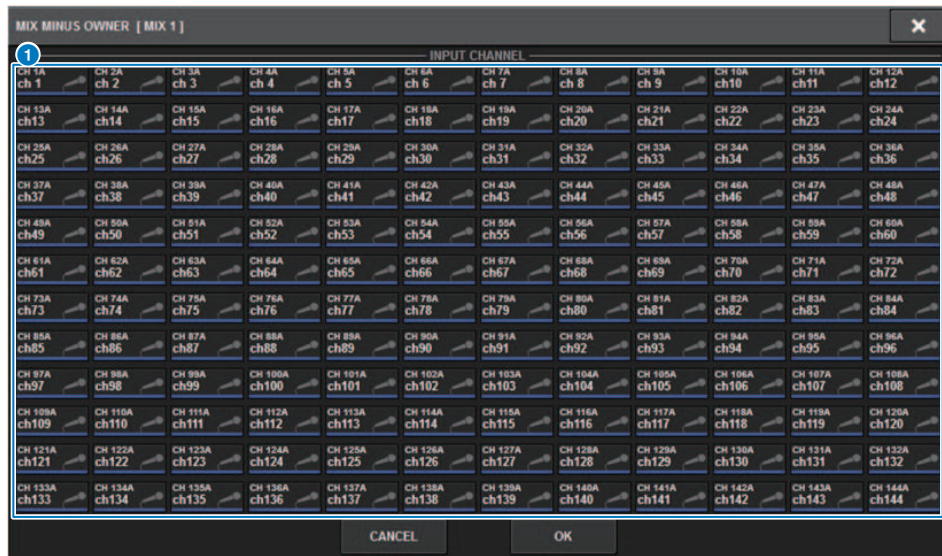

This screen contains the following items.

1 Channel select button

These buttons select the OWNER channel (the input channel that uses mix minus).

SEND indications for a mix minus bus

OVERVIEW screen

SEND field

After specifying the mix minus bus



By pressing the [SHIFT] key you can specify the OWNER channel. After the setting is made, it is shown in red. This will be the SEND ON/OFF button.



After the setting is made, it is shown in red.



For channels other than the OWNER channel, you will be able to specify the OWNER channel by pressing the [SHIFT] key.



SELECTED CHANNEL VIEW screen

MIX/MATRIX SENDS field

Send to a mix minus bus is blue

However, send from the OWNER channel is red



SURROUND SETUP (specifying surround mode)

If you specify surround mode in BUS SETUP, you'll be able to use 5.1 surround panning and monitoring. By using two surround buses, IS surround production also becomes easy. This allows a highly flexible monitoring environment that includes downmixing and external monitor sources. MIX buses 1–12 and MATRIX buses 1–4 are used for the two surround buses and the downmix bus.

1 Press the **SETUP** button to access the **SETUP** screen.

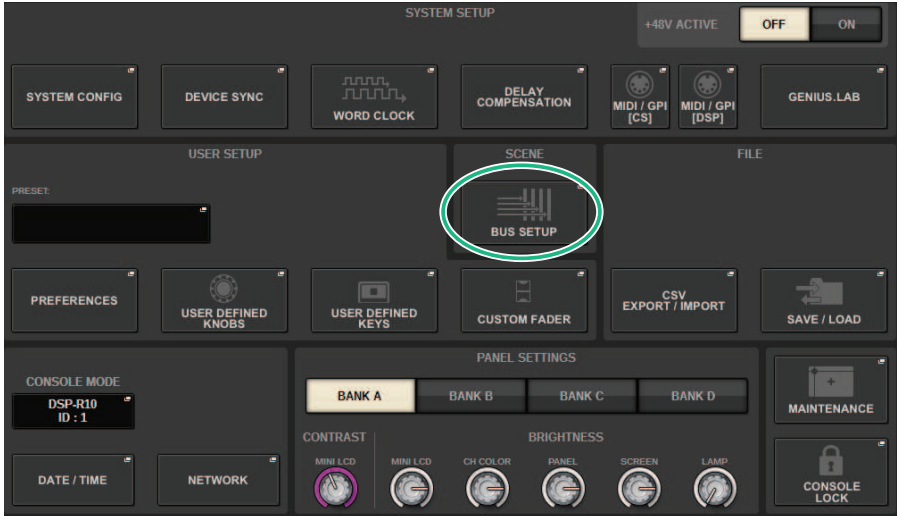

2 Press the **BUS SETUP** button to open the **BUS SETUP** popup window.



This window includes several pages, which you can switch between using the tabs located at the top of the window.

3 Press the **SURROUND SETUP** tab.

The “SURROUND SETUP screen” (p.342) appears.

4 Press the **SURROUND** mode switching button.

5 Using the surround output assign buttons, select the surround output channel to which each MIX channel is assigned.

6 Press the APPLY button.

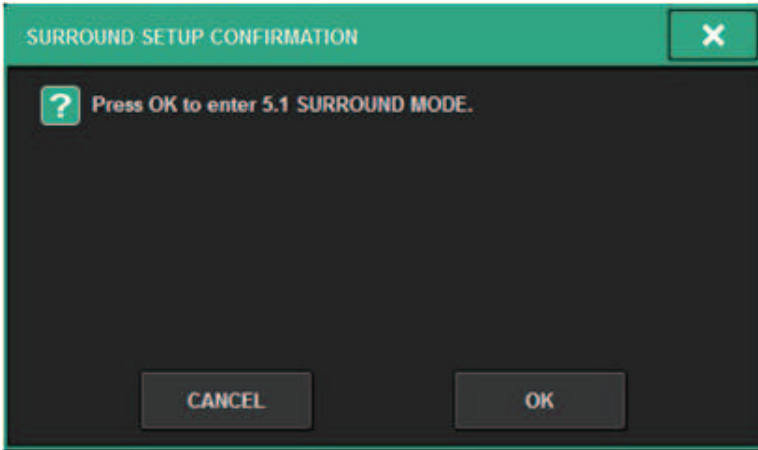

A window will be displayed, asking you to confirm the change.

7 Press the OK button.

SURROUND SETUP screen

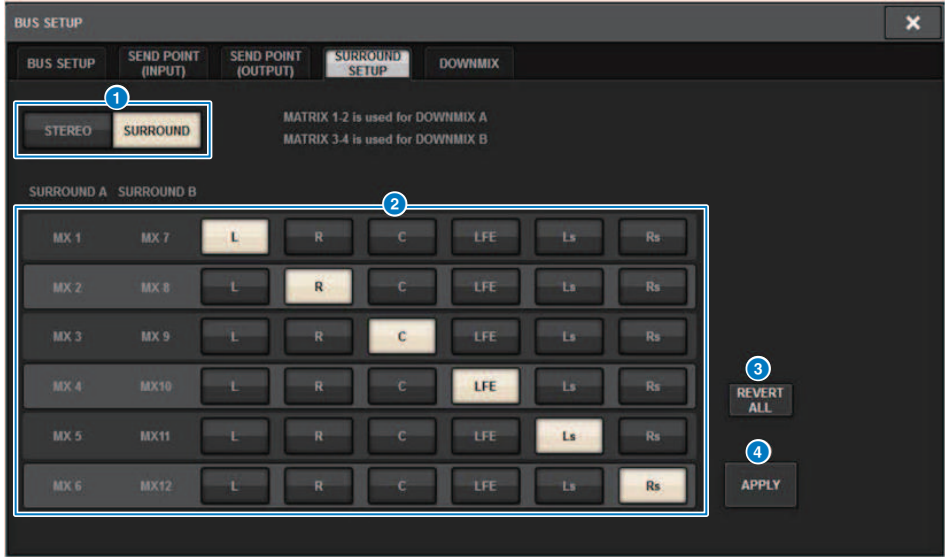

This screen contains the following items.

1 Mode switching buttons

These buttons switch the bus setting from stereo mode to surround mode, or from surround mode back to stereo mode. Mode settings can be recalled as a scene.

2 Surround output assign buttons

In surround mode, these buttons assign MIX buses (MIX 1–6/MIX7–12) to surround buses.

3 REVERT ALL button

This button reverts the un-applied changes of the surround output assign buttons to their previous state.

4 APPLY button

This button applies the settings of the mode switching buttons and the surround output assign buttons.

SELECTED CHANNEL VIEW screen (SURROUND)

When the bus setting in BUS SETUP is set to surround mode, the SELECTED CHANNEL VIEW screen will appear as follows.



1 Surround graph

The MIX popup buttons of MIX bus sends 1–12 indicate the surround positioning. When you press this, the SURROUND PAN 1CH screen will appear.

OVERVIEW screen (SURROUND)



When the bus setting in BUS SETUP is set to surround mode, the OVERVIEW screen will appear as follows.

1 Surround graph

This shows the surround positioning. When you press this, the SURROUND PAN 1CH screen will appear.

2 L/R⇄F/R select button

This is a toggle button that switches the object to be operated. (The [SHIFT] key does the same thing.) Use the screen encoder or the [TOUCH AND TURN] knob to operate this.

3 LFE knob

This knob adjusts the level of the LFE (low frequency effects) channel. Use the screen encoder or the [TOUCH AND TURN] knob to operate this.

SURROUND PAN 1CH screen

When the bus setting in BUS SETUP is set to surround mode, the SURROUND PAN 1CH screen will appear as follows. (The example shows PAIR)

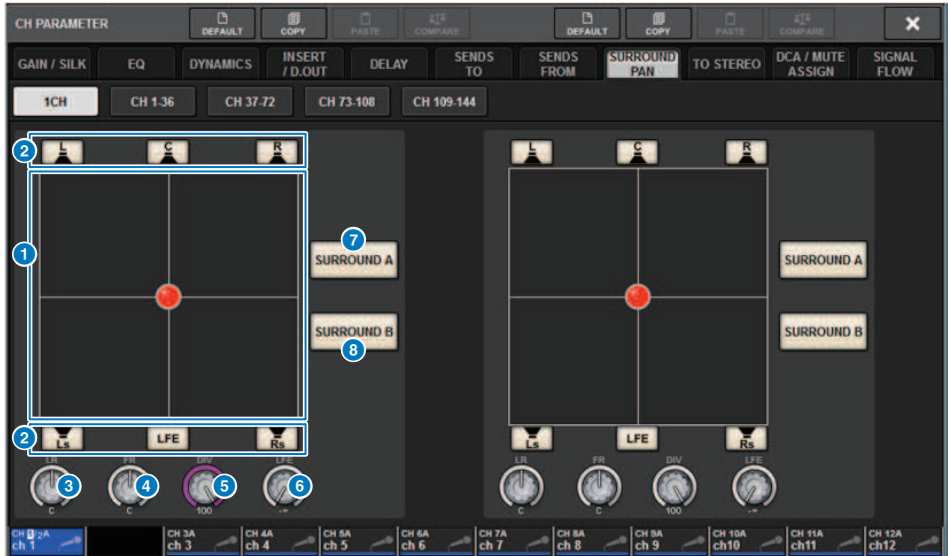

1 Surround graph

This shows the surround positioning.

2 Assignment buttons for each bus

By default, all buttons are on. Turn off buses that do not output an audio signal.

3 L/R knob

Specifies the left/right surround positioning. Use the screen encoder or the [TOUCH AND TURN] knob to operate this.

4 F/R knob

Specifies the front/rear surround positioning. Use the screen encoder or the [TOUCH AND TURN] knob to operate this.

5 DIV knob

Specifies the proportion of the front center signal that is sent to the left, right, and center channels. With a setting of 0, the front center signal is sent only to the left and right channels. With a setting of 50, the signal is sent equally to the left, right, and center channels. With a setting of 100, the signal is sent only to the center channel. Use the screen encoder or the [TOUCH AND TURN] knob to operate this.

6 LFE knob

This knob adjusts the level of the LFE (low frequency effects) channel. Use the screen encoder or the [TOUCH AND TURN] knob to operate this.

7 SURROUND A button

Specifies whether the signal is sent to surround bus A.

System Setup > SURROUND PAN 1CH screen

8 SURROUND B button

Specifies whether the signal is sent to surround bus B.

SURROUND PAN CH1-36/ CH37-72/ CH73-108/ CH109-144 screen

When the bus setting in BUS SETUP is set to surround mode, the screen will appear as follows.



DOWNMIX screen

If surround mode is specified in BUS SETUP, the DOWNMIX page allows you to individually specify the downmix coefficients for surround buses A/B and for the surround monitor. MATRIX buses 1–4 are used for downmix (fixed).

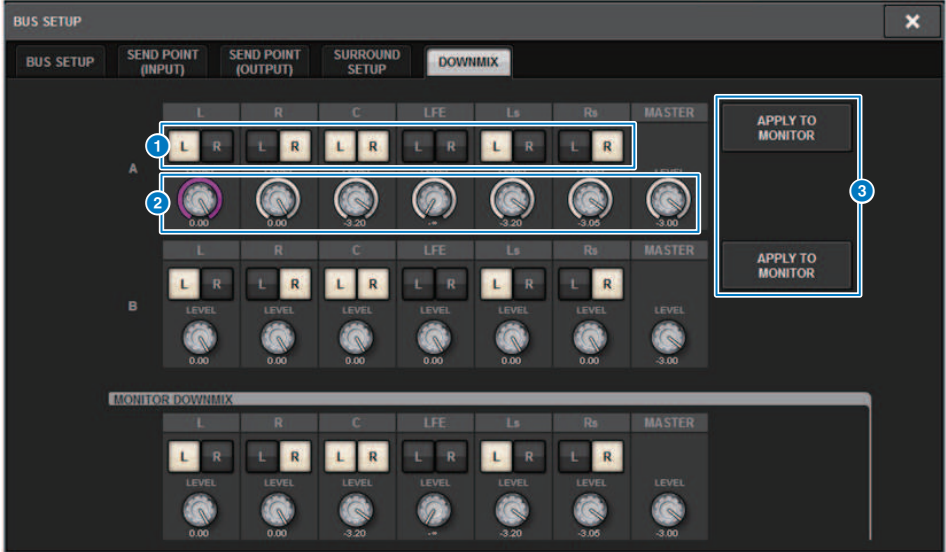

- 1 L/R buttons**
Specify the output destination.
- 2 Coefficient setting knobs**
Specify the downmix coefficients. Σ clip is provided.
- 3 APPLY TO MONITOR buttons**
Copy the settings to the surround monitor downmix settings.

SURROUND MONITOR screen

If surround mode is specified in BUS SETUP, you can make SURROUND MONITOR and SURROUND CUE settings on the SURROUND MONITOR tab that appears in the MONITOR screen.



1 SURROUND MONITOR popup button

Accesses the SURROUND MONITOR SETTINGS popup window, in which you can make detailed settings for surround monitoring.

2 DIMMER field

Enables you to make settings for the Dimmer function, which temporarily attenuates the surround monitor signals.

- **DIMMER LEVEL knob**
Adjusts the amount by which the surround monitor signals will be attenuated when the dimmer is on.
- DIMMER ON button
Turn on this button to enable the dimmer function and attenuate the surround monitor signal.

3 PHONES LEVEL LINK button

If this is on, the MONITOR FADER LEVEL knob will adjust the level of signals sent to the PHONES B output jack.

4 MONITOR SOURCE SELECT buttons

Select the surround monitor source. You can select not only surround buses A/B but also downmix A/B and external input (5.1 and stereo).

5 DOWNMIX buttons

To downmix the surround monitor, select either stereo or monaural.

6 Assignment buttons for each bus

You can mute specific buses of the surround monitor.

7 MONITOR FADER LEVEL knob

Adjusts the surround monitor fader level.

8 MONITOR OUTPUT button

Turns the surround monitor output on or off.

9 Meter field

Shows the output level for each channel of the surround monitor. Press this field to open the SURROUND MONITOR SETTINGS popup window.

10 SURROUND CUE popup button

Accesses the SURROUND CUE SETTINGS popup window, in which you can make detailed settings for surround cue.

11 CUE MODE buttons

Enable you to specify the operation mode when multiple [CUE] keys are on.

- MIX CUE mode.....All selected channels will be cue-monitored.
- LAST CUE mode.....Only most recently selected channel will be cue-monitored.

12 Meter field

Shows the output level for each channel of the surround cue. Press this field to open the SURROUND CUE SETTINGS popup window.

13 CLEAR CUE button

Cancels all surround cue selections simultaneously. If the CUE MODE setting is MIX CUE, all of the selected channels will be cleared.

SURROUND MONITOR SETTINGS popup window



This screen contains the following items.

1 MONITOR SOURCE SELECT buttons

Select the source that will be output to the MONITOR bus.

2 CUE INTERRUPT button

Press this button to interrupt the surround monitor signal by the surround cue signal. If this button is on and surround cue is enabled, the surround cue signal will be sent to the surround monitor output.

3 DOWNMIX buttons

To downmix the surround monitor, select either stereo or monaural.

4 Meter field

Shows the output level for each channel of the surround monitor.

5 MONITOR OUTPUT button

Turns the surround monitor output on or off.

6 MONITOR DELAY knob

Indicates the currently-specified delay time. The millisecond value is indicated above the knob, and the delay time value in currently-selected units and the currently-selected scale type are indicated below the knob. However if the scale is set to ms, the delay time value is not shown above the knob.

7 DIMMER ON CUE knob

Adjusts the amount by which the surround monitor signal will be attenuated when surround cue is on.

- **DIMMER ON CUE indicators**

When surround cue is active, CUE A and/or CUE B will light.

8 DIMMER ON TALKBACK LEVEL knob

Adjusts the amount by which the monitor signal will be attenuated when talkback is on.

- **DIMMER ON TALKBACK indicator**

Indicates the on/off status of the talkback dimmer function.

9 DIMMER LEVEL knob

Adjusts the amount by which the surround monitor signals will be attenuated when the dimmer is on.

10 SPEAKER MUTE buttons

These buttons individually mute the surround monitor speakers. The SOLO button turns on the solo function for the monitor speakers. This mutes the speakers other than the speaker for which this is on.

11 MONITOR FADER LEVEL knob

Adjusts the surround monitor fader level.

12 INSERT ON button

Switches the plug-in insert on or off.

13 INSERT button

Press this button to display a window allowing you to insert plug-ins into the surround monitor signal. One plug-in can be inserted into each bus.

14 OUTPUT PATCH popup buttons

These indicate the slot or port that is the surround monitor output destination of each channel. Press these buttons to access the OUTPUT PATCH [SURROUND MONITOR] popup window.

15 SURROUND METER OUTPUT PATCH popup button

Press this button to access the OUTPUT PATCH [SURROUND MONITOR] popup window.

MONITOR SOURCE popup window (SURROUND)



This screen contains the following items.

1 MONITOR SOURCE DEFINE buttons

Each button displays the name of the assigned surround monitor source. Press these buttons to access the MONITOR SOURCE SELECT popup window, in which you can assign surround monitor sources to individual DEFINE buttons.

MONITOR SOURCE popup window (SURROUND)



This screen contains the following items.

1 NAME buttons

You can enter the name of the external source that is assigned to each button. When you press a button, a keyboard screen appears, allowing you to edit the name.

2 SOURCE popup buttons

These buttons select the surround monitor source. When you press one of these buttons, the INPUT PATCH popup window will appear, in which you can select input jacks, slots and channels.

SURROUND CUE SETTING popup window

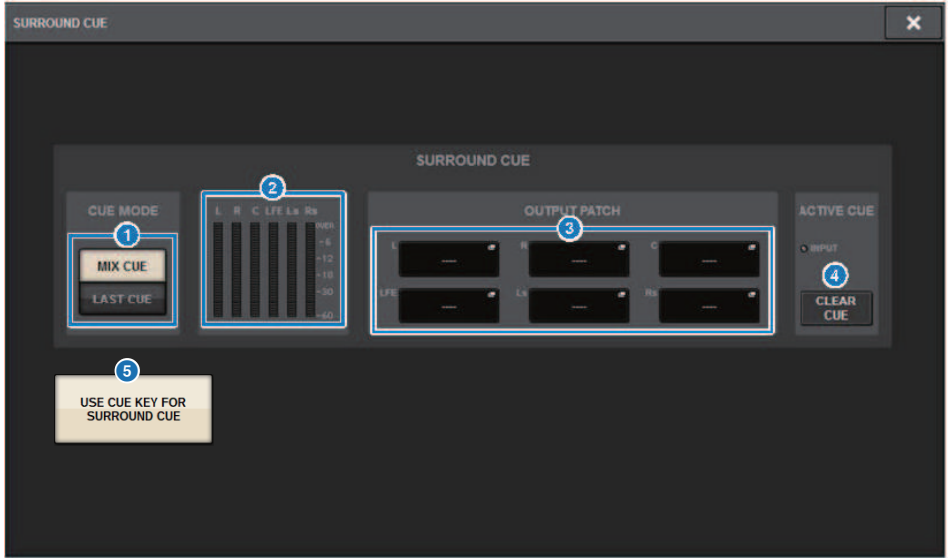

You can allocate the surround cue (in which the surround monitor environment is cued to the input channel) to the [Fn] key. Using the USE CUE KEY FOR SURROUND CUE function will also allow you to use [CUE]. This screen contains the following items.

1 CUE MODE buttons

Enable you to specify the operation mode when multiple [CUE] keys are on.

- MIX CUE mode.....Surround-cue all selected channels
- LAST CUE mode.....Surround-cue only the last selected channel

2 Meter field

Shows the output level for each channel of the surround cue.

3 OUTPUT PATCH buttons

Press these buttons to access the OUTPUT PATCH [SURROUND CUE] popup window, in which you can select output ports to patch to the surround cue outputs.

4 CLEAR CUE button

Cancels all surround cue selections simultaneously. If the CUE MODE setting is MIX CUE, all of the selected channels will be cleared.

5 USE CUE KEY FOR SURROUND CUE button (CS-R5 only)

Turning this on will allow SURROUND CUE to be switched on/off with the [CUE] key.

PHONES popup window

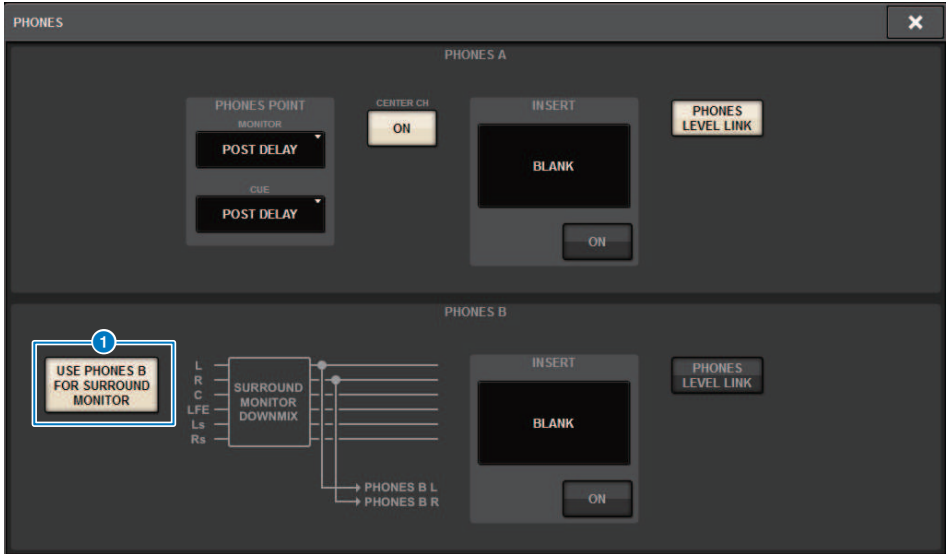

This screen contains the following items.

1 USE PHONES B FOR SURROUND MONITOR button

In surround mode, the USE PHONES B FOR SURROUND MONITOR button is displayed. If you turn this on, a block diagram graphic is shown, and PHONE B is used for surround monitor.

Patching

Input channel I/O unit section

This section describes the I/O unit section for the input channels.

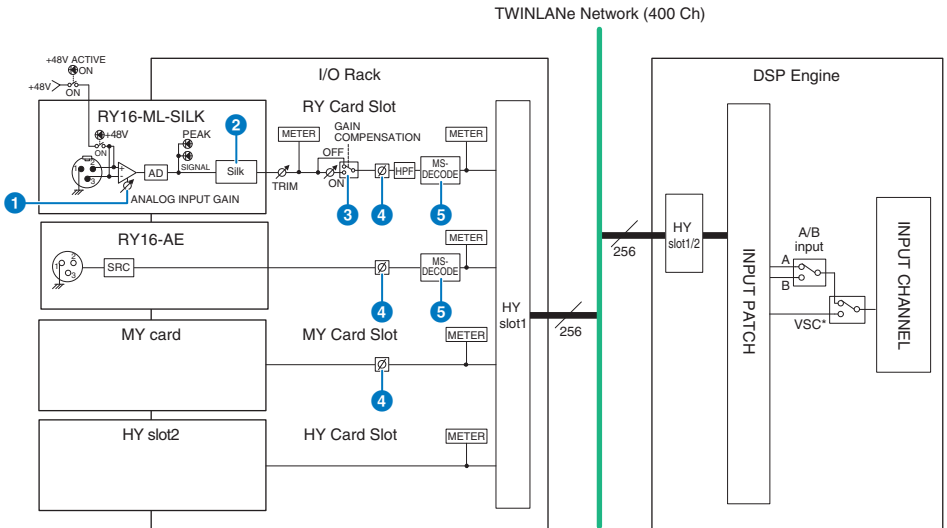

* Virtual Sound Check

1 ANALOG INPUT GAIN

This is the analog gain of the head amp.

2 Silk (available only on the CS-R10, CS-R10-S, and CSD-R7)

Allows you to add a natural sense of audio transformer compression and saturation. This enhances the sense of depth and space, freshening the sound.

You can control the brilliance or power.

About “Silk”

Silk uses proprietary Yamaha “VCM technology” digital signal processing to faithfully replicate the “Silk” processing that is built into numerous high-end analog audio devices developed, manufactured, and sold by Rupert Neve Designs.

Based on the natural compression and saturation of audio transformers, a matter about which Rupert Neve is especially passionate, the user can choose one of two characters, “Blue” or “Red,” and use a continuously-variable “Texture” knob that allows effective control over the tone and the accompanying overtones.

Silk allows effects such as the following.

- In addition to adding power and brilliance, you can recover the sense of air that tends to be lost in the mix.
- The graceful and solid tone characteristic of an analog console can be obtained.
- Breathing and subtle pianissimos can be expressed in a lifelike way.
- Channel EQ and reverb become more effective.
- If this is used only on a small number of important channels, those parts will stand out from the mix.
- If this is used on all channels, the mix will be given depth and three-dimensional character.
 - Red: Bright and lively
 - Blue: Rich and powerful

About the “Hybrid Mic Preamp” concept

This is a revolutionary mic preamp that uses digital signal processing to model and combine the ultra-high-quality analog mic preamp representing the pinnacle of Yamaha’s “natural sound” philosophy with Rupert Neve Designs’ “Silk” processing that allows you to freely control the sound’s “depth, space, and air.” In the RIVAGE PM series, Hybrid Mic Preamp as standard on the RY16-ML-SILK and on all the OMNI INPUT channels on the rear panel of the control surface.

3 GAIN COMPENSATION

Switches the gain compensation on or off for that channel. If this is on, the signal level that is output from the I/O rack to the audio network remains constant even if the HA analog gain is adjusted.

About gain compensation

The HA analog gain of the I/O rack can be controlled by the gain knob of the control surface, but normally this will also change the input level to another DSP engine or recording device that shares the input.

However if gain compensation is used to fix the gain within the I/O rack, the signal level that is output to the audio network is kept constant. In other words, raising (or lowering) the analog gain causes the compensation gain within the I/O rack to decrease (or increase). Because the mixing input level can be operated using the digital gain within the DSP engine, this allows the input level to be optimal for various routes used for different purposes.

Even if you turn gain compensation off again, the analog gain and compensation gain will return to the settings they had when gain compensation was turned on, so the signal level that is output to the audio network will not change.

In this way, you can adjust the analog gain for the optimal S/N ratio and use the digital gain to adjust the input level independently.

4 Ø

Reverses the phase of the input signal.

5 M/S DECODE

An M/S decoder is built in.

The M/S decoder is provided for adjacent odd- and even-numbered channels.

Input channel mixing engine section

This section describes the mixing engine section for the input channels.

TWINLANe Network (400 Ch)

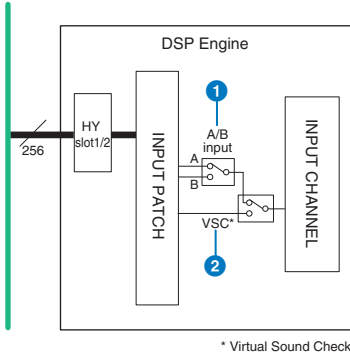

* Virtual Sound Check

1 A/B input

Switches between two sources A and B that are patched to the input channel. You can use this in the following ways.

- Patch a backup circuit in advance for quick selection in an emergency.
- Quickly switch input sources depending on the performance or scene.

2 Virtual Sound Check

Switches all stage (I/O) inputs and DAW playback in a single operation.

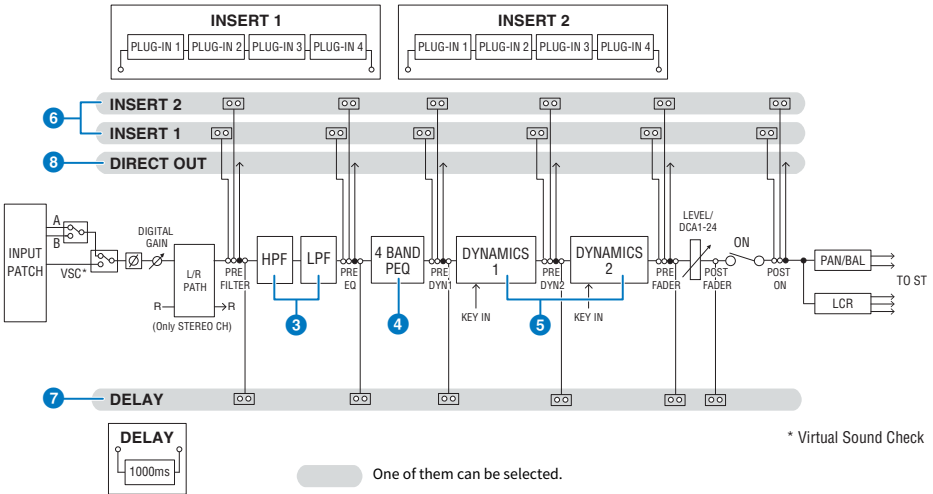

* Virtual Sound Check

One of them can be selected.

3 Filter

- **HPF**

The slope of the high-pass filter can be specified as -6 dB/oct, -12 dB/oct, -18 dB/oct, and -24 dB/oct.

- **LPF**

The slope of the low-pass filter can be specified as -6 dB/oct or -12 dB/oct.

4 EQ

This is a four-band parametric EQ.

- **4 BAND PEQ**

The following EQ types can be selected: PRECISE, AGGRESSIVE, SMOOTH, or LEGACY. Two sets of EQ parameter settings (A and B) can be saved for convenient comparison. The FREQUENCY parameter of each band is normally set in 1/12 octave steps, but if you need more precise adjustment, you can set it in 1/24 octave steps. The two bands LOW and HIGH can be switched to L SHELF (Low Shelving) and H SHELF (High Shelving) respectively.

The available EQ types include:

PRECISE	This EQ strives for ultimate precision and controllability. It enables you to adjust the target point precisely, and flexibly satisfies various requirements for sound making. Low/High Shelving filters feature a “Q” parameter, which enables you to adjust the knee characteristics.
AGGRESSIVE	This EQ is musical and effective. It enables you to add a powerful, creative edge and serves as a powerful tool for artistic expression.
SMOOTH	This EQ focuses on smooth sound qualities. It contributes to a natural sound without changing the atmosphere of the original.
LEGACY	This is a standard EQ that has been equipped with many of Yamaha’s legacy digital mixers, such as PM1D and PM5D.

5 DYNAMICS

Two dynamics processor modules are provided: Dynamics 1 and Dynamics 2. To each module you can assign one of six types of function such as GATE or COMP. Two types of compressor are provided: LEGACY COMP and COMP 260. Two sets of dynamics parameter settings (A and B) can be saved for convenient comparison.

The available dynamics types include:

LEGACY COMP	This is a standard compressor that has been equipped with many of Yamaha’s legacy digital mixers, such as PM1D and PM5D.
COMP 260	This is an analog-flavored compressor built using Yamaha’s proprietary VCM (Virtual Circuitry Modeling) technology. It emulates the characteristics of compressors and limiters of the mid-1970s, which are now a standard for live sound reinforcement. This compressor has faithfully modeled the VCA (Voltage-Controlled Amplifier) circuit and the RMS (Root Mean Square) detection circuit. Compression curve (Knee) can be set to Hard, Medium, or Soft. Although the attack/release times can also be adjusted, the preset settings reproduce the fixed response of the original unit being modeled. Designed under the supervision of top SR engineers, the parameter effects have been optimized for live sound reinforcement.
GATE	This dynamics type reduces the output by a fixed value (RANGE) when a signal smaller than the THRESHOLD level is input.
DE-ESSER	This dynamics type detects only the sibilants and other high-frequency consonants of the vocal, and compresses its bandwidth.
EXPANDER	This dynamics type reduces the output by a fixed ratio (RATIO) when a signal smaller than the THRESHOLD level is input.

DUCKING	This dynamics type reduces the output by a fixed value (RANGE) when a signal greater than the THRESHOLD level is input. This is effective if you want to lower the volume level of background music using the KEY IN SOURCE signal.
FET LIMITER *1	Models a FET compressor/limiter used standard in studios. Because THRESHOLD is fixed internally, the amount of compression applied is adjusted by adjusting the INPUT level.
DIODE BRIDGE COMP *1	Models a compressor that uses a Diode Bridge.

*1 Cannot be selected for input channel Dynamics 1.

• **KEY IN SOURCE**

Selects the source of the key-in signal. In addition to SELF, the key-in signal can also be selected directly from another channel or input patch.

6 INSERT

Two inserts are provided: Insert 1 and Insert 2. In each insert, you can insert up to four plug-ins/GEQ/PEQ/external devices (via the I/O jacks). Each insert point can be selected independently for INSERT 1 and INSERT 2.

7 DELAY

Up to 1000 msec of delay is provided on each channel. You can freely select the delay insert point. You can select the delay time unit from the following: meter, feet, sample, msec, frame, depending on your application.

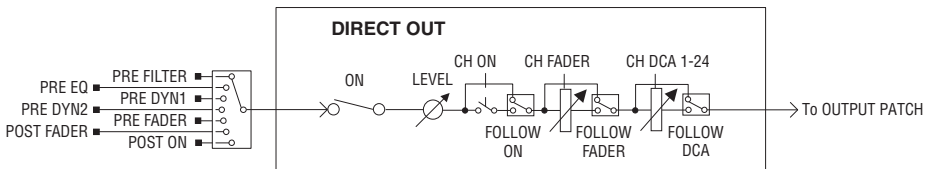

8 DIRECT OUT

• **DIRECT OUT POINT**

For each channel, a variety of points can be selected as the signal that is output to direct out.

• **DIRECT OUT LEVEL**

For each channel, sets the output level of direct out.

• **FOLLOW**

This function enables the direct out signal to “follow” channel parameter settings (FADER/ON/DCA) regardless of the direct out point. For example, if you want to route a signal from immediately after the HA to the direct out for recording, you can make the direct out signal follow the channel OFF setting to avoid possible noise caused by connecting or disconnecting cables or turning phantom power on or off.

Patching > Input channel mixing engine section

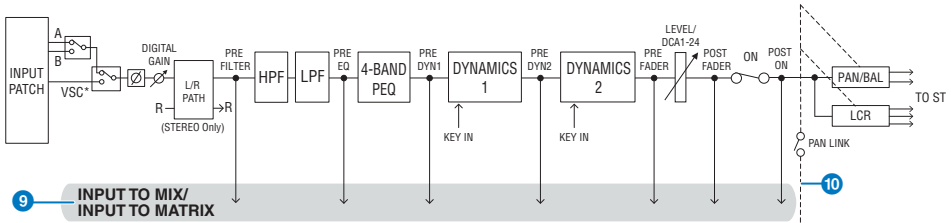

* Virtual Sound Check

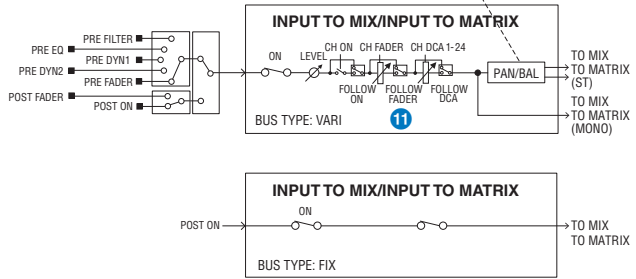

9 INPUT TO MIX/INPUT TO MATRIX

A signal can be sent from the input channel to MIX buses 1 – 72. In addition to the conventional MIX sends, there are also direct sends to MATRIX buses 1 – 36, so by using these together you can use them as up to 108 mix buses.

- **Send Point**

This allows you to flexibly select the send point for each channel. You can set the send point selected here to PRE or POST using the PRE button. You can select each send point on the BUS SETUP screen.

PRE	POST
PRE FILTER	POST FADER
PRE EQ	POST ON
PRE DYN1	
PRE DYN2	
PRE FADER	

10 PAN LINK

With this setting, the signal sent from an input channel to the MIX/MATRIX bus can be made to follow the PAN of the STEREO bus send regardless of the send point.

11 FOLLOW

With this setting, the signal sent from an input channel to the MIX/MATRIX bus can be made to “follow” the channel FADER/ON/DCA settings regardless of the send point. For example, you can select whether or not a PRE FADER monitoring signal will follow the ON/OFF setting for the STEREO bus send.

Pair setting

Adjacent channels can be paired and used as a stereo module. Either odd-numbered/even-numbered channels or even-numbered/odd-numbered channels can be specified as a combination. For single input channels (monaural), the pan level is nominal at the center, and +3 dB at hard left or hard right. If channels are paired, the level response of their balance will be nominal at center and +3 dB at far left or right.

Library

Patching > Input channel mixing engine section

The “INPUT CHANNEL LIBRARY” lets you store and recall various input channel parameters.

Patching the input ports

You can assign input channel patches into two groups (A and B) and switch between these groups. This function is convenient in the following applications:

- Assigning back-up patches as group B, and switching to this group in case of emergency.
- Quickly switching between the input channel groups depending on the programs on the stage or situations.

1 Press the PATCH button on the menu bar to access the PATCH screen.

2 Press the INPUT tab.

The “INPUT patch window” (p.368) appears.

3 Use the knob in the upper right to display the desired input ports.

4 Use the knob in the lower left corner to display the input channels.

5 Press the desired grid cell to patch a desired channel.

NOTE

- You can patch a single input port to multiple input channels, but you cannot patch multiple input ports to a single input channel.
- Input ports for an I/O rack that is not assigned to the TWINLANe network will not be displayed. During off-line setting, no I/O racks will be displayed unless the DSP engine has been set as the word clock leader. If you want to patch the input ports for an I/O rack while off-line, set the DSP engine as the word clock leader temporarily to assign the I/O rack to the TWINLANe network band.

Display when patching conflicts between engines

When performing an operation that tries to steal a patch from an output port already patched to another DSP engine on a TWINLANE network, a confirmation message will be displayed on the control surface that initiated the operation, and the control surface from which the patch was stolen now shows that a modification was made.

For instance, when output patching to the same port of an I/O rack is performed from multiple DSP engines on the same TWINLANE network, the last patch will be given priority, and the DSP engine that was first patched will have its patch stolen by the DSP engine patched afterwards. A message is shown in this case.

Display when patch is stolen

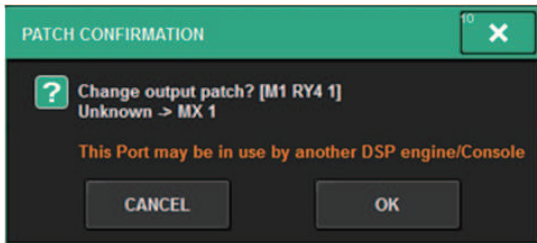

This confirmation dialog is displayed only when the STEAL button in the PREFERENCES popup window is turned on.

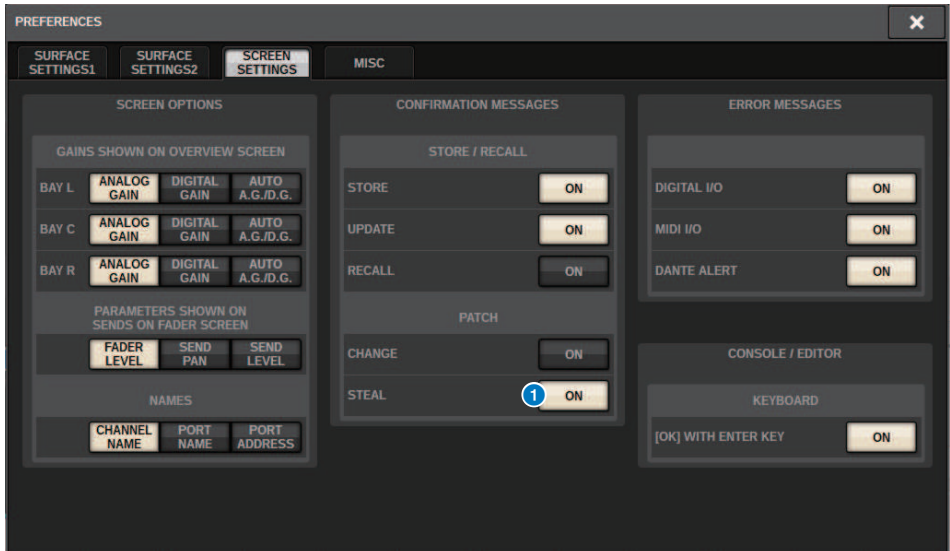

1 STEAL button

Display when patch is stolen

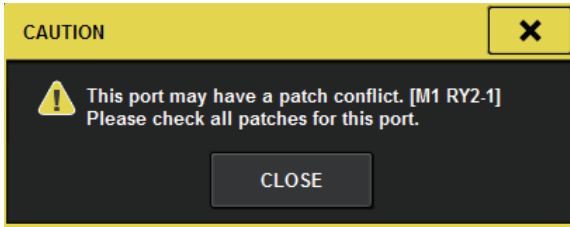

Patch screen display

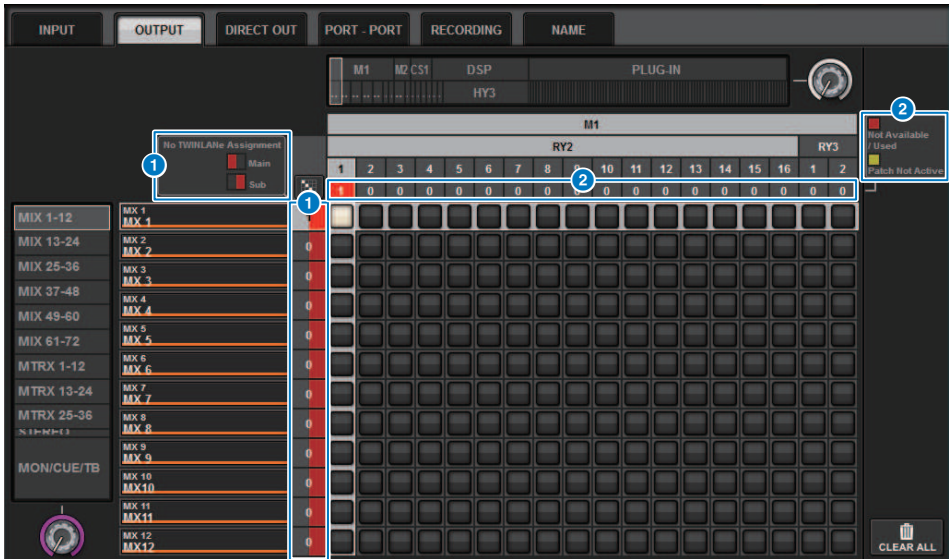

1 TWINLANE network (Main, Sub) assignment display

Output channels that are not assigned to the TWINLANE network are shown with the number of patches in red. (left half is Main, right half is Sub)

2 Display when not correctly patched

When the box containing the number of assignments for the applicable port is red or yellow, patching to the port is not yet enabled.

The status is color-coded. Red: Not Available/Used, Yellow: Not Active

• Not Available

The port is not available because the number of ports is limited due to the sampling rate setting for the card. If you try to patch this port under this status, patching will not be enabled, and the box will remain red.

• Used

Another DSP engine has already been patched to this port. If you try to patch to this port under this status, the “Change output patch?” dialog box appears. Touch OK to “steal” a patch from the other DSP engine, and the patch will be enabled. At this time, the red box disappears, indicating that the patch is now enabled. On the other hand, if the currently-used patch is “stolen” by another DSP engine and becomes disabled, the red box will appear, indicating that the patch is being used. However, the button in the patch grid will remain white, indicating that the port is patched. If you remove the patches and then redo the patches again, the patches will be enabled. However, use caution when removing the patches, as you might remove patches used by other engines as well.

• Not Active

The port was once patched from another DSP engine, but then the patch was canceled. The button in the patch grid will stay in white, indicating that the port is patched. To enable patching, you must remove and then redo the patch.

NOTE

- When there is a patching conflict, PORT IDENTIFY on the I/O rack will be disabled. Also, the message shown below will be shown at the bottom of the screen in yellow.
- “PORT IDENTIFY not available! This channel is not currently patched to an Output Port.”

INPUT patch window

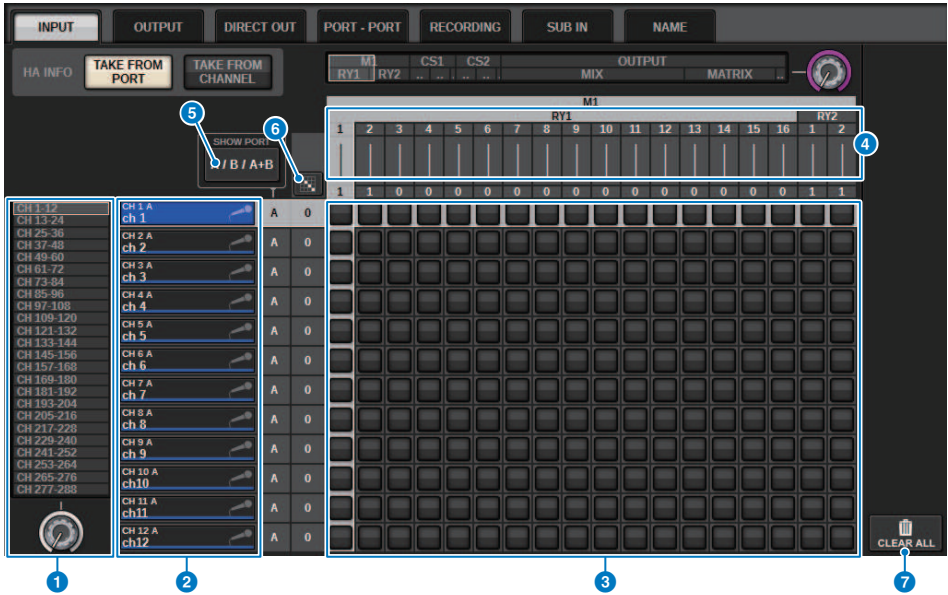

This screen contains the following items.

1 Channel list (Input channels)

Indicates the input channel numbers as patching destinations.

2 Channel display

Indicates the channels that will be assigned to the input port.

3 Grid

This grid lets you patch input ports (horizontal lines) to input channels (vertical columns). Currently-patched grids are indicated by white squares. Press or click a desired grid to set or disable the patch.

4 INPUT COMPONENT/SLOT/CH (input components/slots/channels)

This section indicates the type of the input component, slot number, and channel number for the input port. The abbreviations displayed in this section have the following meaning.

- **M1-M8, S1-S8** I/O rack 1-8
- **CS1, CS2**.....Control surface
- **DSP**..... DSP engine
- **PLUG-IN**.....Effect plug-in already mounted in PLUG-IN [SEND]







NOTICE

- The number below is the number of channels that are patched. If the background is red, no sound is output even if the channel is patched (such as when the HY144-D is used and ROUTING MODE is set to MODE1).

5 SHOW PORT button

Enables you to select the ports that are displayed in the grid from A, B, and A+B.

6 Continuous Patch  button

Press the continuous patch  button, and then rotate the select knob to in the upper right to patch the intersecting channels continuously. If you press the continuous patch  button, the  button and the  button will appear. Press the  button again to confirm the selected continuous patches. Press the  button to revert the continuous patches to their previous state.

7 CLEAR ALL button

Press this button to clear all patches.

8 HA INFO button

When modifying an input patch, you can select whether the HA settings of the patched port will be used as-is (TAKE FROM PORT), or whether the HA settings of the channel will be copied to the patched port (TAKE FROM CHANNEL).

When the TAKE FROM CHANNEL button is selected, the HA settings below will be copied from the channel side to the patched port. The default settings will be used when patching a (non-HA) input that does not have these settings to an input channel.

HA settings and defaults

- HA gain (-6 dB)
- HPF ON/OFF (OFF)
- +48V ON/OFF (OFF)
- GC ON/OFF (OFF)
- φON/OFF (OFF)
- HPF frequency (80 Hz)
- SILK ON/OFF (OFF)
- SILK RED/BLUE (RED)
- SILK (0.0)
- M/S ON/OFF (OFF)
- M/S S-GAIN (STEREO)

Output channel mixing engine section

This section describes the mixing engine section for the output channels.

MIX bus

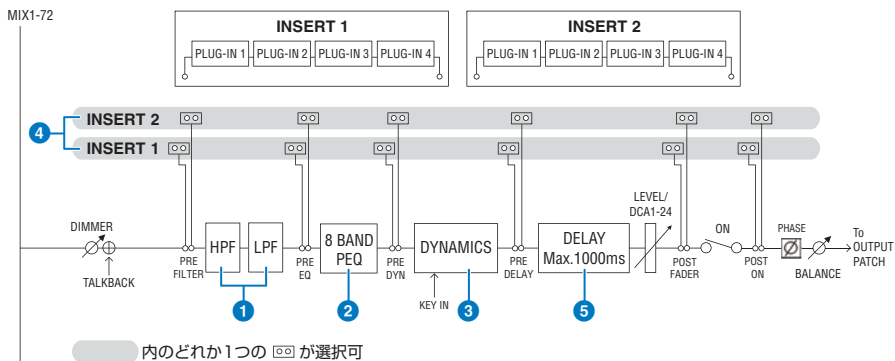

1 FILTER

- **HPF**

The slope of the high-pass filter can be specified as -6 dB/oct, -12 dB/oct, -18 dB/oct, and -24 dB/oct.

- **LPF**

The slope of the low-pass filter can be specified as -6 dB/oct or -12 dB/oct.

2 EQ

This is an eight-band parametric EQ.

- **8 BAND PEQ**

The following EQ types can be selected: PRECISE, AGGRESSIVE, SMOOTH, or LEGACY. Two sets of EQ parameter settings (A and B) can be saved for convenient comparison. The FREQUENCY parameter of each band is normally set in 1/12 octave steps, but if you need more precise adjustment, you can set it in 1/24 octave steps. The two bands LOW and HIGH can be switched to L SHELF (Low Shelving) and H SHELF (High Shelving) respectively.

The selectable EQ types are the same as for input channels (Input channel mixing engine section).

3 DYNAMICS

One dynamics processor module is provided. You can select a dynamics function from six types, including GATE and COMP. Two types of compressor are provided: LEGACY COMP and COMP 260. Two sets of dynamics parameter settings (A and B) can be saved for convenient comparison.

The selectable EQ types are the same as for input channels (Input channel mixing engine section).

- **KEY IN SOURCE**

Selects the source of the key-in signal. In addition to SELF, the key-in signal can also be selected directly from another channel or input patch.

4 INSERT

Two inserts are provided: Insert 1 and Insert 2. In each insert, you can insert up to four plug-ins/GEQ/PEQ/external devices (via the I/O jacks). Any insert point can be selected independently for INSERT 1 and INSERT 2.

5 DELAY

Up to 1000 msec of delay is provided on each channel. You can freely select the delay insert point. You can select the delay time unit from the following: meter, feet, sample, msec, frame, depending on your application.

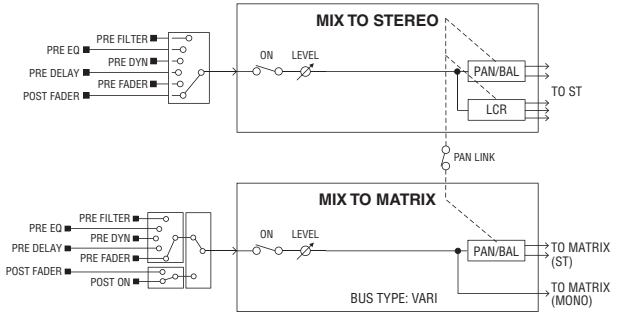
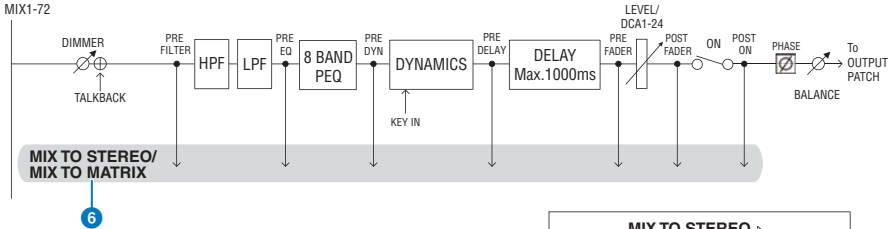

6 MIX TO STEREO/MIX TO MATRIX

Signals can be sent from MIX buses 1 – 72 to the STEREO bus or MATRIX buses 1 – 36.

• **Send Point (MIX TO STEREO)**

You can select the send source point for each channel from the following options.

- PRE FILTER
- PRE EQ
- PRE DYNA
- PRE DELAY
- PRE FADER
- POST FADER

• **Send Point**

This allows you to flexibly select the send point for each channel. You can set the send point selected here to PRE or POST using the PRE button. You can select each send point on the BUS SETUP screen.

PRE	POST
PRE FILTER	POST FADER
PRE EQ	POST ON
PRE DYN1	
PRE DYN2	
PRE FADER	

Pair setting

You can pair adjacent odd/even MIX buses (in that order), and use them as a stereo module.

BUS TYPE

MIX buses can be either the FIXED type whose send level is fixed or the VARI type whose send level is variable; you can switch each odd/even-numbered pair to either type.

Library

The “OUTPUT CHANNEL LIBRARY” lets you store and recall various output channel parameters.

MATRIX bus

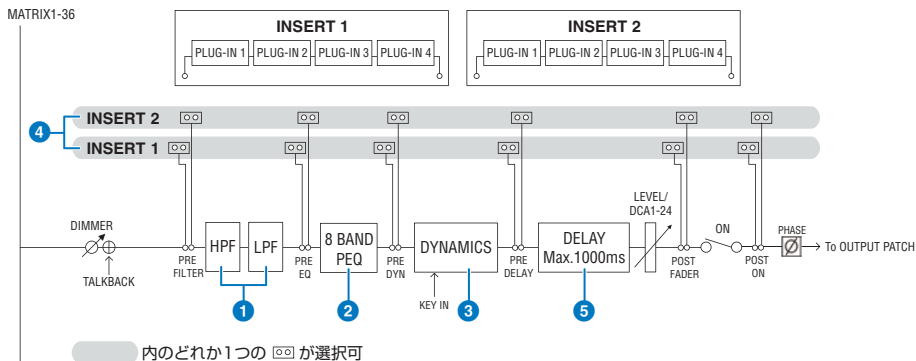

1 FILTER

- **HPF**

The slope of the high-pass filter can be specified as -6 dB/oct, -12 dB/oct, -18 dB/oct, and -24 dB/oct.

- **LPF**

The slope of the low-pass filter can be specified as -6 dB/oct or -12 dB/oct.

2 EQ

This is an eight-band parametric EQ.

- **8 BAND PEQ**

The following EQ types can be selected: PRECISE, AGGRESSIVE, SMOOTH, or LEGACY. Two sets of EQ parameter settings (A and B) can be saved for convenient comparison. The FREQUENCY parameter of each band is normally set in 1/12 octave steps, but if you need more precise adjustment, you can set it in 1/24 octave steps. The two bands LOW and HIGH can be switched to L SHELF (Low Shelving) and H SHELF (High Shelving) respectively.

The selectable EQ types are the same as for input channels (Input channel mixing engine section).

3 DYNAMICS

One dynamics processor module is provided. You can select a dynamics function from six types, including GATE and COMP. Two types of compressor are provided: LEGACY COMP and COMP 260. Two sets of dynamics parameter settings (A and B) can be saved for convenient comparison.

The selectable EQ types are the same as for input channels (Input channel mixing engine section).

- **KEY IN SOURCE**

Selects the source of the key-in signal. In addition to SELF, the key-in signal can also be selected directly from another channel or input patch. You can use an HPF, BPF, or LPF as a KEY IN FILTER.

4 INSERT

Two inserts are provided: Insert 1 and Insert 2. In each insert, you can insert up to four plug-ins/GEQ/PEQ/external devices (via the I/O jacks). Any insert point can be selected independently for INSERT 1 and INSERT 2.

5 DELAY

Up to 1000 msec of delay is provided on each channel. You can freely select the delay insert point. You can select the delay time unit from the following: meter, feet, sample, msec, frame, depending on your application.

Pair setting

Adjacent channels can be paired and used as a stereo module. Adjacent odd/even MATRIX buses (in that order) can be specified as a pair.

Library

The “OUTPUT CHANNEL LIBRARY” lets you store and recall various output channel parameters.

BUS TYPE

MATRIX buses are only VARI type.

STEREO bus

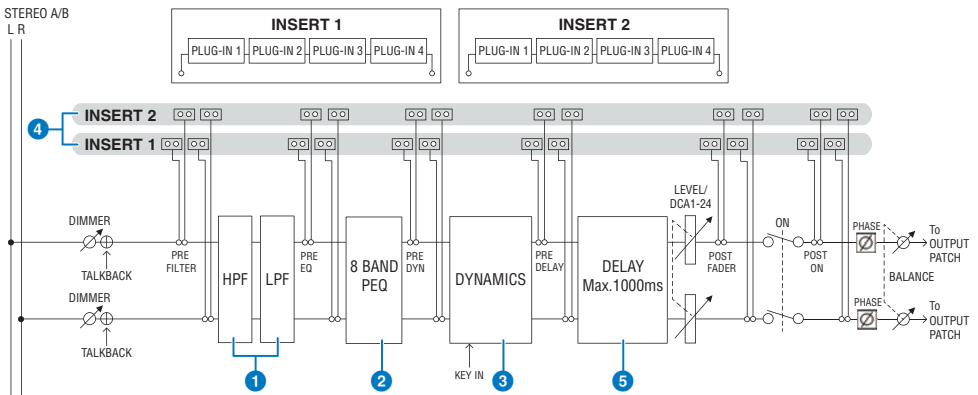

内のどれか1つの [] が選択可

1 FILTER

- **HPF**
The slope of the high-pass filter can be specified as -6 dB/oct, -12 dB/oct, -18 dB/oct, and -24 dB/oct.
- **LPF**
The slope of the low-pass filter can be specified as -6 dB/oct or -12 dB/oct.

2 EQ

This is an eight-band parametric EQ.

- **8 BAND PEQ**
The following EQ types can be selected: PRECISE, AGGRESSIVE, SMOOTH, or LEGACY. Two sets of EQ parameter settings (A and B) can be saved for convenient comparison. The FREQUENCY parameter of each band is normally set in 1/12 octave steps, but if you need more precise adjustment, you can set it in 1/24 octave steps. The two bands LOW and HIGH can be switched to L SHELF (Low Shelving) and H SHELF (High Shelving) respectively.

The selectable EQ types are the same as for input channels (Input channel mixing engine section).

3 DYNAMICS

One dynamics processor module is provided. You can select a dynamics function from six types, including GATE and COMP. Two types of compressor are provided: LEGACY COMP and COMP 260. Two sets of dynamics parameter settings (A and B) can be saved for convenient comparison.

The selectable EQ types are the same as for input channels (Input channel mixing engine section).

4 INSERT

Two inserts are provided: Insert 1 and Insert 2. In each insert, you can insert up to four plug-ins/GEQ/PEQ/external devices (via the I/O jacks). Any insert point can be selected independently for INSERT 1 and INSERT 2.

5 DELAY

Up to 1000 msec of delay is provided on each channel. You can freely select the delay insert point. You can select the delay time unit from the following: meter, feet, sample, msec, frame, depending on your application.

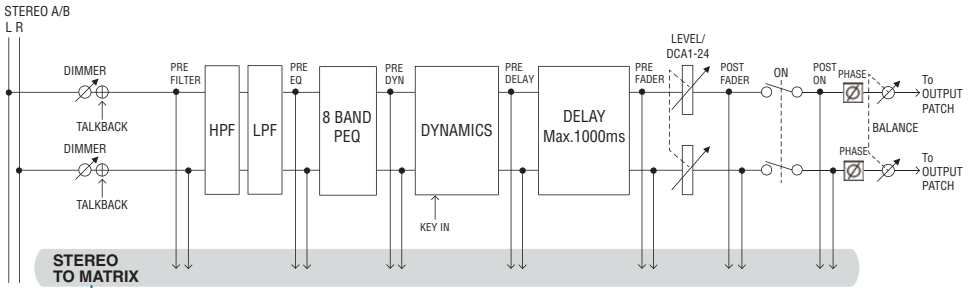

6

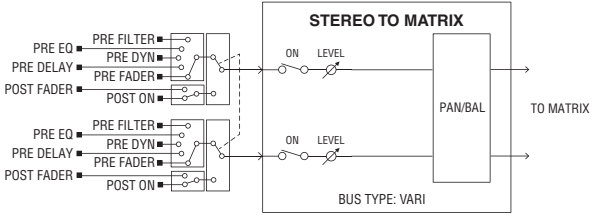

6 STEREO TO MATRIX

A signal can be sent from the STEREO channel to MATRIX buses 1 – 36.

• **Send Point**

This allows you to flexibly select the send point for each channel. You can set the send point selected here to PRE or POST using the PRE button. You can select each send point on the BUS SETUP screen.

PRE	POST
PRE FILTER	POST FADER
PRE EQ	POST ON
PRE DYN1	
PRE DYN2	
PRE FADER	

Library

The “OUTPUT CHANNEL LIBRARY” lets you store and recall various output channel parameters.

Patching > Output channel mixing engine section

MONO

STEREO B can be set to MONO. If it is set to MONO, the same signal is sent to L and R of STEREO B. This is also used as the CENTER channel of LCR. If it is set to MONO, the same signal is sent to L and R of STEREO B.

LCR

By using STEREO A as L/R and STEREO B (set to MONO) as CENTER, the two stereo buses can be used as an LCR bus.

Output channel I/O unit section

DELAY, GAIN, and PORT TRIM can be specified for the output signal from the output channel.

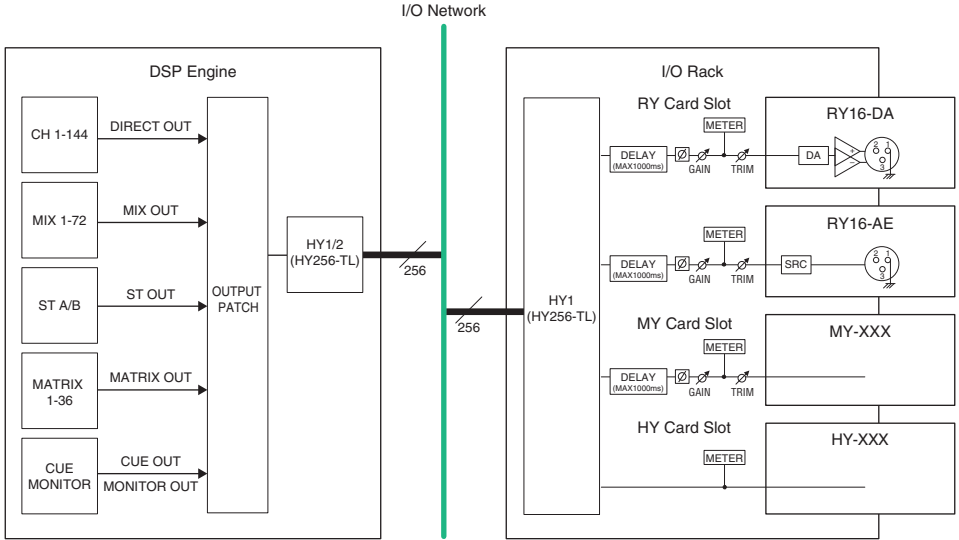

Patching the output ports

This section explains how to edit the output patching.

- 1 Press the PATCH button on the menu bar to access the PATCH screen.**
- 2 Press the OUTPUT tab.**

The “OUTPUT patch window” (p.378) appears.
- 3 Use the knob in the upper right to display the desired output ports.**
- 4 Use the knob in the lower-left corner to display the output channels.**
- 5 Press the desired grid cell to patch a desired channel.**

NOTE

On the RPi0622 or RPi0222, the output to HY slot 2 can be patched if the routing mode is set to Mode 2. (I/O rack settings popup window) However, the routing mode setting is not included in scene data. Therefore, if you recall a scene, you must switch to Mode 2.

OUTPUT patch window

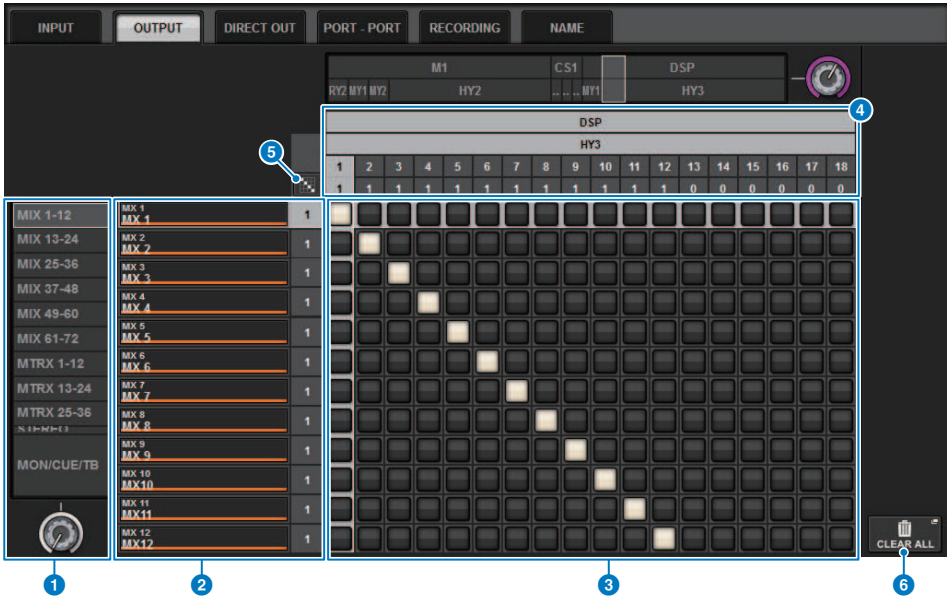

This screen contains the following items.

- 1 **Channel list (Output channels)**
Indicates the output channel numbers as patching destinations.
- 2 **Channel display**
Indicates the channels that will be assigned to the output port.

NOTE

The number at right is the number of channels that are patched. If the background is red, no sound is output even if the channel is patched, since sound is not being output to the TWINLANE network by the TWINLANE CONFIGURATION settings. In the case of the CS-R10 or CS-R10-S, if the left half is red, there is no output to the TWINLANE (MAIN) network; if the right half is red, there is no output to the TWINLANE (SUB) network. In the case of the CSD-R7, if the entire area is red, there is no output to the TWINLANE network.

- 3 **Grid**
This grid lets you patch output ports (horizontal lines) to output channels (vertical columns). Currently-patched grids are indicated by white squares. Press or click a desired grid to set or disable the patch.

4 OUTPUT COMPONENT/SLOT/CH (input components/slots/channels)







This section indicates the type of the output component, slot number, and channel number for the output port. The abbreviations displayed in this section have the following meaning.

- **M1-M8, S1-S8** I/O rack 1-8
- **CS1, CS2**.....Control surface
- **DSP**..... DSP engine
- **PLUG-IN**.....Effect plug-in already mounted in PLUG-IN [SEND]

NOTICE

- The number below is the number of channels that are patched. If the background is red, no sound is output even if the channel is patched (such as when the HY144-D is used and ROUTING MODE is set to MODE1).

5 Continuous Patch  button

Press the continuous patch  button, and then rotate the select knob to in the upper right to patch the intersecting channels continuously. If you press the continuous patch  button, the  button and the  button will appear. Press the  button again to confirm the selected continuous patches. Press the  button to revert the continuous patches to their previous state.

6 CLEAR ALL button

Press this button to clear all patches.

Changing the name

In the PATCH/NAME popup window, you can view and change the icon, channel color, and name of the input channels, output channels and DCAs.

1 Press the PATCH button on the menu bar to access the PATCH screen.

2 Press the NAME tab.

The “PATCH/NAME screen” (p.381) appears.

3 Press the NAME EDIT popup button of the channel, DCA, or MUTE group for which you want to edit the channel name, icon or channel color.

The NAME/ICON EDIT popup window appears.

4 Use the icon select buttons to select the icon you want to use for the channel. You can use the channel color select buttons to select the color of the channel. The selected icon and color are shown in the icon button in the upper part of the window.

5 To edit the channel name based on a template name, use the template select buttons to select a template. The selected template will be entered in the channel name field in the upper part of the window.

To enter the channel name directly, proceed to step 6.

NOTE

You can also add or edit characters in the channel name field after you have entered the name from the template. If you want to quickly assign channel names that consist of a common name plus a consecutive number, such as “Vocal 1” or “Vocal 2,” enter the name from a template first, and then add a number.

6 If you want to directly enter a channel name from one of the touch screens, press the keyboard switch button in the upper part of the window.

The keyboard window will appear, allowing you to enter or edit the text. For details on how to assign a name, refer to (“Entering names” (p.123)).

7 When you are finished with your input, press the X symbol in the upper right of the window.

NOTE

Press the TAB button to switch to the next channel. You can also press the ENTER button to close the popup window in the same way as using the “x” symbol.

PATCH/NAME screen



This screen contains the following items.

1 Tabs

Use these tabs to switch between items.

2 NAME EDIT popup buttons

Indicate the current name of channels, DCAs and MUTE group. Press one of these buttons to display the keyboard window or icon edit window, in which you can edit the name.

3 LIBRARY button

Press this button to open the NAME library window.

4 Channel/group select tab

Use the corresponding screen encoder or the [TOUCH AND TURN] knob.

NAME/ICON EDIT popup window



This window contains the following items.

- 1 **Channel name edit box**
Displays the name of the channel that is currently selected for editing. You can also directly enter the name from the USB keyboard.
- 2 **Keyboard switch button**
Toggles between the keyboard window and CH COLOR/ICON popup window.
- 3 **SAVE AS A TEMPLATE button**
Turn this button on and press a template select button (7) to store the setting as a template.
- 4 **HIDE ICON button**
Press this button to hide the icon.
- 5 **Channel color select buttons**
Allows you to select a channel color. Pressing the button will immediately apply the change. If you select OFF, the channel color and icon will be grayed out.
- 6 **Icon select buttons**
Allows you to select a channel icon. Pressing the button will immediately apply the change.
- 7 **Template select buttons**
Allows you to select a template. Pressing the button will immediately apply the change.

Patching > NAME/ICON EDIT popup window

NOTE

The channel to be operated can be changed by using the keyboard's TAB to move to the next channel and SHIFT + TAB to move to the previous channel.

Port to port

This function freely routes the input and output of each component from an input port to an output port via the TWINLANe network without passing it through a mixing channel.

Port to port can be used with the following inputs and outputs.

- RPiO622/222 (RY/MY/HY card slots)
- DSP-R10 (MY/HY card slots)
- Console 1/2 (OMNI IN connectors, OMNI OUT connectors, AES/EBU connectors, MY card slots)

Port to port within the same HY slot (HY1 or HY2 (only on the RIVAGE PM10 system)) can be patched directly.

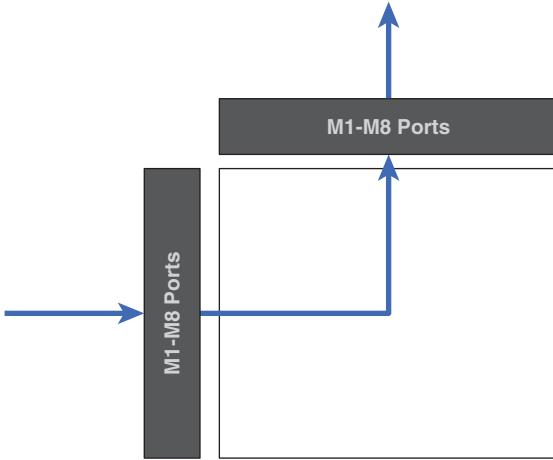

Between slots, patching can be done via SLOT BRIDGE patch (36 outputs and 36 inputs for each slot).

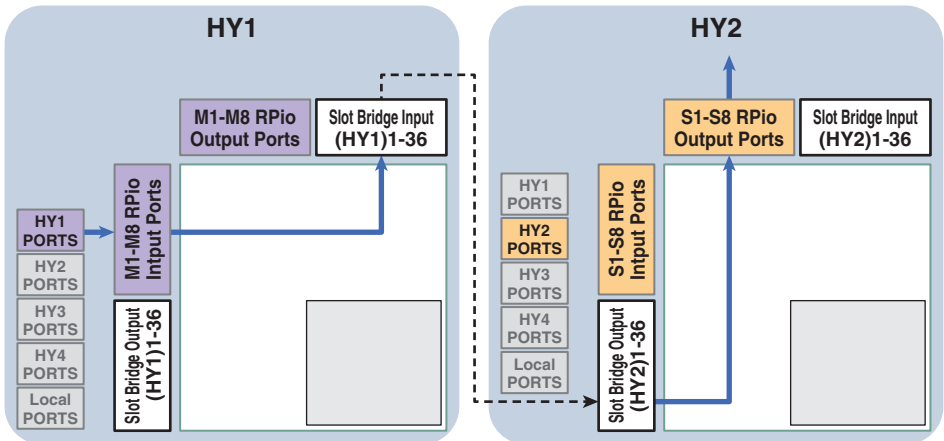

As an example here, we explain the procedure for patching from an RPiO of a RIVAGE PM10 system's main network to an RPiO of a sub network. In this case, multiple patches are required.

Patch 1 (patch target HY1):

Patching > Port to port

Patch from an RPIO on the main network to SLOT BRIDGE input (BRIDGE IN: HY1)

Patch 2 (patch target SLOT BRIDGE):

Patch from a SLOT BRIDGE input (BRIDGE IN: HY1) to SLOT BRIDGE output (BRIDGE OUT: HY2)

Patch 3 (patch target HY2):

Patch from a SLOT BRIDGE output (BRIDGE OUT: HY2) to an RPIO on the sub network

- 1 Press the PATCH button on the menu bar to access the PATCH screen.**
- 2 Press the PORT-PORT tab.**

The “PORT-PORT patch window” (p.386) appears.
- 3 Use the knob in the lower left to display the desired input ports.**
- 4 Use the knob in the upper right to display the desired output ports.**
- 5 Press a grid cell to patch the corresponding channel.**
- 6 Create patches 2 and 3 by repeating steps 3–5.**

NOTE

The Port-to-port patch setting will not be included in a scene nor overwritten by scene recall. Also, output ports that have been patched Port-to-port will appear to be patchable in the OUTPUT/DIRECT OUT patch screens; however, the audio will not be output (the Port-to-port patch takes priority). On these patch screens, the number of output ports that have been patched Port-to-port will be displayed in red. The number of patches is also shown in red for the SLOT BRIDGE output channel numbers of HY slot 1 and HY slot 2 that are not assigned to the TWINLANe network, or for any HY slots that are not configured for the Dante network.

PORT-PORT patch window

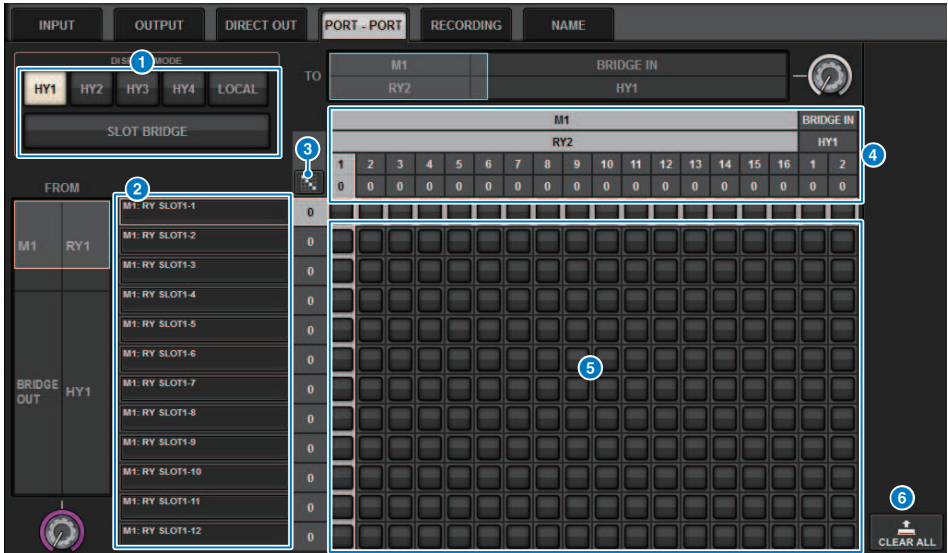

This screen contains the following items.







1 DISPLAY MODE buttons

Press a button to switch the patch target that is shown in the patch grid. The upper line of buttons are for patching within a slot and to the bridge, and the lower line of buttons are for bridge patching between slots.

2 Input components/slots/channels

This section shows input component and bridge information, slot numbers, and channel numbers.

3 Continuous Patch  button

Press the continuous patch  button, and then rotate the select knob to in the upper right to patch the intersecting channels continuously. If you press the continuous patch  button, the  button and the  button will appear. Press the  button again to confirm the selected continuous patches. Press the  button to revert the continuous patches to their previous state.

4 Output components/slots/channels

This section shows output component and bridge information, slot numbers and channel numbers.

5 Grid

This grid lets you patch output jacks (horizontal lines) to input jacks (vertical columns). Currently patched grid cells are shown in white. Press (or click) a desired grid cell to set or disable the patch.

6 CLEAR ALL button

Press this button to clear all selections.

PORT NAME tab



This screen contains the following items.

1 Network selection tab

Press this tab to select the device network. TWINLANe, DANTE, DSP/CS

2 Device selection buttons

Press these buttons to select the device to edit.

3 Device label

Press this to input the device name.

4 Slot list

Press a slot label to input a slot name.

5 Port list

Press a port label to input the port name.

6 List selection tab

Use the screen encoder or the [TOUCH AND TURN] knob to select a slots and ports.

7 Keyboard button

Press this to toggle between direct input and inputting using the NAME EDIT popup window.

8 DEVICE SYNC/DANTE SETUP popup button

Press this button to access the DEVICE SYNC popup window, where you can sync the port names and so on.

NOTE

- To enable the label you set, synchronize data from the control surface to the device side. Synchronizing in the opposite direction

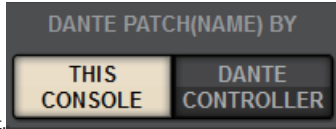

will overwrite the labels you set.

- When a Dante network is selected, this displays the DANTE SETUP popup window. When THIS CONSOLE is on, the label set using the control surface will be enabled, and the label set on the device side will be overwritten. When DANTE CONTROLLER is on, the label set on the device side will be enabled.

SUB IN

SUB IN is a function that enables you to route signals directly from the input ports to the output bus. You can use this to make cascading connections from the bus outputs of other consoles to expand the number of inputs.

SUB IN patch screen

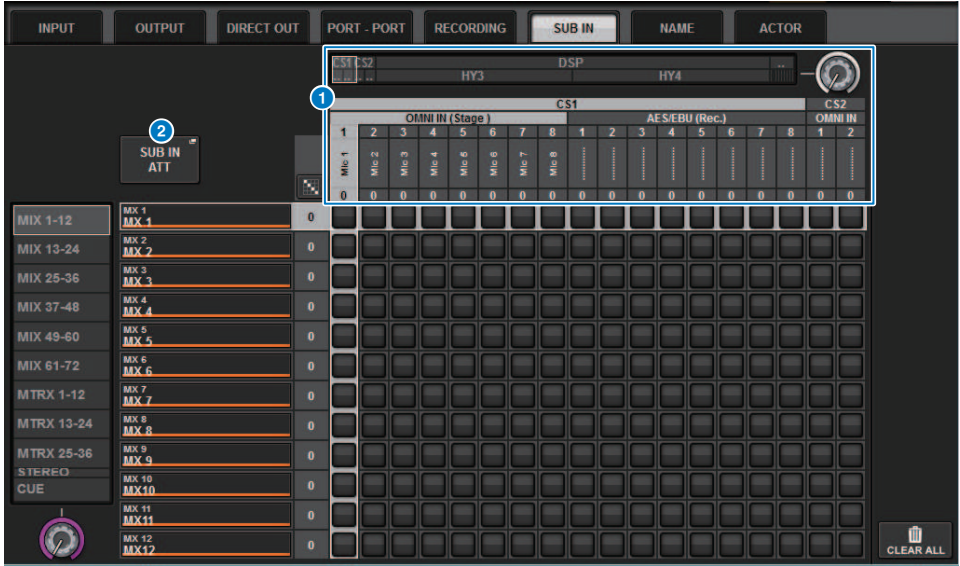

1 Selection list

These are the input ports for the input source.

2 SUB IN ATT button

Press this to display the SUB IN ATT popup window, in which you can adjust the input level.

SUB IN ATT popup window



Use the tabs to select an output channel, and use the knobs to adjust the gain for each channel.

Monitor

About monitoring

The RIVAGE PM series features two monitor outputs (MONITOR A and MONITOR B). You can select the monitor source and set the output level for each monitor output individually. They include the following features:

- You can specify, mix and monitor up to eight channel signals.
- You can select not only channel or bus signals, but signals directly from input patches as monitor signals.
- You can assign and switch out up to eight combinations of monitor signals.
- The monitor section provides an 8-band parametric EQ specialized for monitoring.

In order to check the sound of a selected individual channel or DCA, you can output it to MONITOR OUT, CUE OUT, or PHONES OUT for auditioning. The RIVAGE PM series provides two cue outputs, CUE A and CUE B.

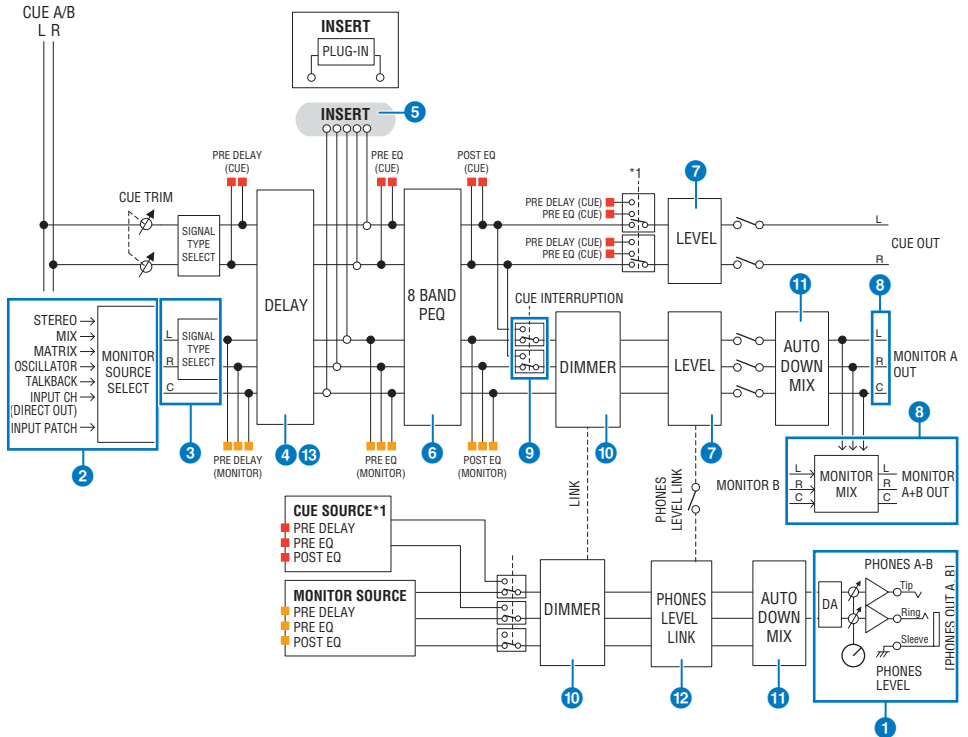

Number of systems

There are two sets of monitor output, MONITOR A and MONITOR B.

1 Headphone output

Two headphone outputs are provided, PHONES A and PHONES B.

2 **Input selector**

You can provide eight sources to be monitored, and switch between them. The signals of up to eight channels can be assigned to one monitor source. You can select not only channel or bus signals, but signals directly from input patches as monitor signals.

3 **Monitor circuit structure**

This consists of three channels: L-channel, R-channel, and CENTER channel.

4 **DELAY**

Allows the monitor signal to be delayed. You can specify up to 1000 msec. You can select the delay time unit from the following: meter, feet, sample, msec, frame, depending on your application.

5 **INSERT**

A plug-in, GEQ, or PEQ can be inserted. The insert point is fixed at PRE EQ (immediately before the EQ). An insert point is also provided for the PHONES OUT.

6 **PEQ**

The monitor section provides an 8-band parametric EQ specialized for monitoring.

7 **MONITOR LEVEL**

The MONITOR OUT L-channel, R-channel, and CENTER channel output levels can be adjusted. The monitor level can also be assigned to a fader.

8 **Output structure**

- L-channel, R-channel, and CENTER channel of MONITOR A
- L-channel, R-channel, and CENTER channel of MONITOR B

9 **CUE INTERRUPTION**

Causes the CUE signal to interrupt the monitor output when CUE is active. The CENTER channel can be turned on/off independently.

10 **DIMMER ON CUE**

Attenuates the monitor signal by a fixed amount. When CUE INTERRUPTION is disabled and CUE is active, the monitor signal is attenuated by a certain level.

11 **PHONES LEVEL LINK**

The level of the signal sent to the PHONES A/PHONES B jacks is linked with the MONITOR A/MONITOR B LEVEL.

12 **MONITOR OUT MODE**

Downmixes the L/R signals to monaural. This also downmixes the L/R/C signals to L/R.

13 **L R+C DOWNMIX**

Allows you to downmix the L/R/C signals to L/R.

14 **DIMMER ON CUE**

When the CUE signal has interrupted the monitor output, this attenuates the signal that is being input to the monitor.

NOTE

Monitor assignments and on/off switching can also be assigned to a USER DEFINED key.

Using the Monitor function (top panel)

Controlling the Monitor function via the UTILITY section

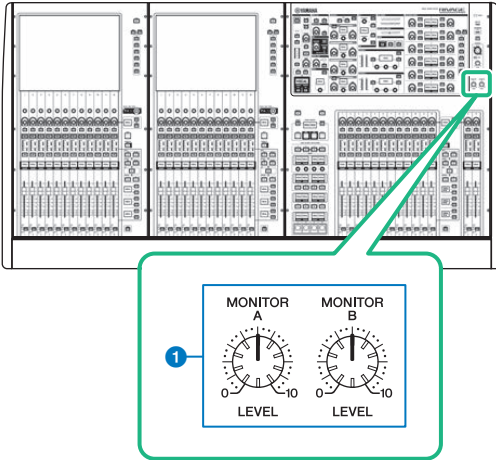

1 MONITOR A/B knobs

Adjust the output level of the monitoring signals.

Using the Monitor function

Controlling the Monitor function via the MONITOR screen

In this screen, you can select desired monitor sources to monitor them from the PHONES A/B output jacks or external monitor speakers.

1 Connect your monitor system to the OMNI OUT jacks or AES/EBU jack on the rear panel.

Monitor signals can be sent to any desired output jack or output channel. If you are monitoring through headphones, make sure that your headphones are connected to the front panel PHONES A/B output jacks.

2 Press the MONITOR button on the menu bar.

The MONITOR screen appears. The MONITOR field on the MONITOR screen enables you to check the current monitoring settings, and turn monitoring on or off.

3 Press the MONITOR popup button or the meter field.

The MONITOR SETTINGS popup window appears. In the MONITOR SETTINGS popup window you can make detailed monitoring settings.

4 Press the tab.

The “MONITOR SOURCE popup window” (p.402) appears. This window enables you to view the list of monitor sources that have been assigned to DEFINE 1– 8.

5 Press the desired MONITOR SOURCE DEFINE button to open the MONITOR SOURCE SELECT popup window, then select the monitor sources.

“MONITOR SOURCE SELECT popup window (INPUT)” (p.403)

“MONITOR SOURCE SELECT popup window (OUTPUT)” (p.404)

“MONITOR SOURCE SELECT popup window (DIRECT INPUT)” (p.405)

You can assign up to 8 channel signals to each DEFINE. Pressing the CLEAR ALL button will clear all selections. You can choose from the following monitor sources.

6 Use the SOURCE SELECT DEFINE buttons to select “Monitor sources” (p.396).

7 To specify a port as the output destination for monitor signals L, R, and C, press one of the OUTPUT PATCH buttons (L/R/C) on the MONITOR SETTINGS popup window to open the OUTPUT PATCH popup window. In this window, choose from the following monitor signal output destinations (multiple selections are allowed).

When you have selected an output port, press the CLOSE button to close the popup window. In the same way, specify the output ports for MONITOR OUT L, R, and C.

NOTE

If desired, you can specify output ports only for MONITOR OUT L and R to monitor through two speakers.

8 To enable monitoring, press the MONITOR OUTPUT button to turn it on.

The monitor source you selected in step 5 will be sent to the output destination you specified in step 7.

NOTE

The PHONES A/B output jacks will always output the monitor signal, regardless of whether the MONITOR OUTPUT button is on or off.

9 To adjust the monitor level, use the corresponding MONITOR LEVEL knob located in the UTILITY section of the top panel.

If PHONES LEVEL LINK is ON, use the MONITOR LEVEL knob and the monitor fader, as well as the PHONES LEVEL knob to adjust the monitor level when monitoring through headphones.

10 Make settings for Dimmer, Delay, Monaural, and Cue Interruption as desired.

NOTE

Monitor on/off operations, selection of the monitor source, and dimmer on/off operations can also be assigned to USER DEFINED keys (USER DEFINED key).

Monitor sources

You can choose from the following sources.

INPUT 1-288 (DSP-RX-EX) INPUT 1-144 (DSP-R10, CSD-R7) INPUT 1-120 (DSP-RX)	Input channel signals (DIRECT OUT)
MIX 1-72 (DSP-RX-EX, DSP-R10, CSD-R7) MIX 1-48 (DSP-RX)	MIX channel signals (DIRECT OUT)
MTX 1-36 (DSP-RX-EX, DSP-R10, CSD-R7) MTX 1-24 (DSP-RX)	MATRIX channel signals
STA, STB	STEREO A L channel, STEREO A R channel, STEREO B L channel and STEREO B R channel signals
TALKBACK	TALKBACK signal
DIRECT IN1-16	Signals directly input from the external terminals

MONITOR screen



This screen contains the following items.

1 MONITOR popup button

Enables you to access the MONITOR SETTINGS popup window, in which you can make detailed monitoring settings. Select MONITOR A or B as the control target, and set the parameters in the corresponding field.

2 DIMMER field

Enables you to make settings for the Dimmer function, which temporarily attenuates monitor signals.

- **DIMMER LEVEL knob**

Adjusts the amount by which the monitor signals will be attenuated when the dimmer is on.

- **DIMMER ON button**

Turn on this button to enable the dimmer function and attenuate the monitor signal.

3 Console select buttons

When using Dual Console, these buttons select whether the MONITOR knob of Console 1 or 2 is used.

4 PHONES LEVEL LINK button

If this button is on, the MONITOR FADER LEVEL knob will adjust the level of signals sent to the PHONES A or PHONES B output jack.

5 MONITOR SOURCE SELECT buttons

Enable you to select one of the DEFINE 1– 8 sources that will be output to the MONITOR bus.

6 MONITOR FADER LEVEL knob

Adjusts the monitor fader level.

Monitor > MONITOR screen

7 MONITOR OUTPUT button

Switches Monitor Out on or off.

8 Meter field

Indicates the output level of Monitor Out channels L, R, and C. Press this field to open the MONITOR SETTINGS popup window.

MONITOR SETTINGS popup window

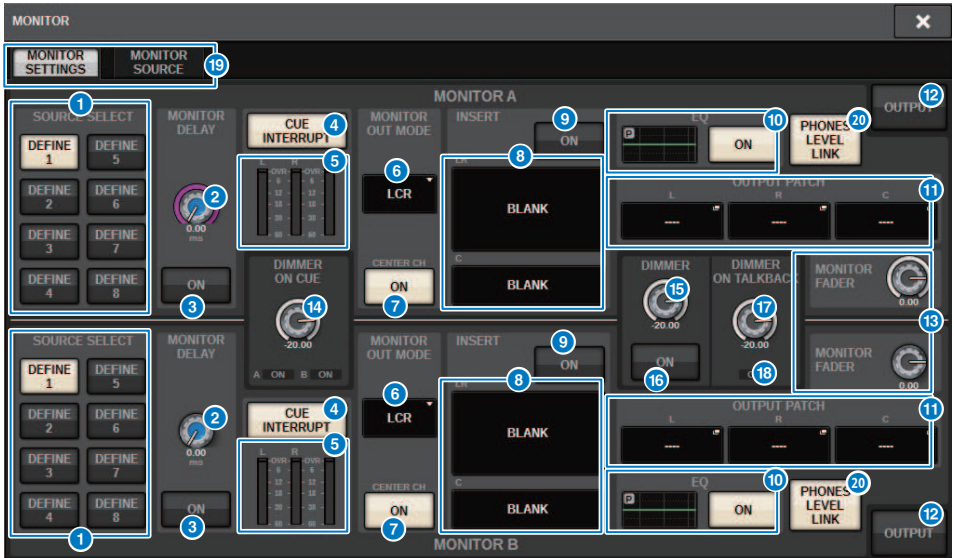

This window contains the following items.

1 SOURCE SELECT DEFINE buttons

Allows you to select one of the DEFINE 1– 8 sources that will be output to the MONITOR bus.

2 MONITOR DELAY knob

Displays the currently-specified delay time. The delay time (in ms) is displayed above the knob, and the delay time value in currently-selected units and the currently-selected units (scale) type are displayed below the knob. However if the scale is set to ms, the delay time value is not shown above the knob.

3 MONITOR DELAY ON button

If this button is on, the monitor signal will be delayed according to the setting of the MONITOR DELAY knob.

4 CUE INTERRUPT button

Press this button to interrupt the monitor signal with the cue signal. If this button is on and the cue is enabled, the cue signal will be sent to the monitor output.

5 Meter

This field displays the output level of the monitor L/R/C channels.

6 **MONITOR OUT MODE**

This section allows you to select one of the following monitor output modes:

- **LR + C DOWNMIX**
In this mode, the L/C/R channel signals will be downmixed and output in stereo.
- **MONO**
In this mode, signals will be output in monaural.
- **LCR**
In this mode, the L/C/R channel signals will be output.

7 **CENTER CH ON button**

If you plan not to monitor the center channel, turn this button off. If this button is off, the center channel will not be included in the downmix signal.

8 **INSERT button**

Press this button to display the window, where you can insert plug-ins into the monitor signal.

9 **INSERT ON button**

Switches the plug-in insert on or off. The currently-specified plug-ins are displayed to the left of the button.

10 **EQ field**

- **EQ graph**
This field displays the approximate response characteristics of the EQ. Press this field to open the window, where you can set the EQ parameters.
- **EQ ON button**
Switches the EQ on or off.

11 **OUTPUT PATCH popup buttons**

Displays the monitor output destination slot or port for the L, C and R channels respectively. Press these buttons to open the OUTPUT PATCH popup window.

12 **MONITOR OUTPUT button**

Switches Monitor Out on or off.

13 **MONITOR FADER LEVEL knob**

Adjusts the monitor fader level.

14 **DIMMER ON CUE knob**

Adjusts the amount by which the monitor signal will be attenuated when cue is on.

DIMMER ON CUE indicators

When cue is active, CUE A and/or CUE B will be illuminated.

15 **DIMMER LEVEL knob**

Adjusts the amount by which the monitor signal will be attenuated when dimmer is on.

16 **DIMMER ON button**

Turn this button on to enable the dimmer function and attenuate the monitor signal.

Monitor > MONITOR SETTINGS popup window

17 DIMMER ON TALKBACK LEVEL knob

Adjusts the amount by which the monitor signal will be attenuated when talkback is on.

18 DIMMER ON TALKBACK indicator

Indicates the on/off status of the talkback dimmer function.

19 Tabs

Use these tabs to switch between the MONITOR SETTINGS popup window and MONITOR SOURCE popup window.

20 PHONES LEVEL LINK button

If this button is on, the MONITOR FADER LEVEL knob will adjust the level of signals sent to the PHONES A or PHONES B output jack.

MONITOR SOURCE popup window

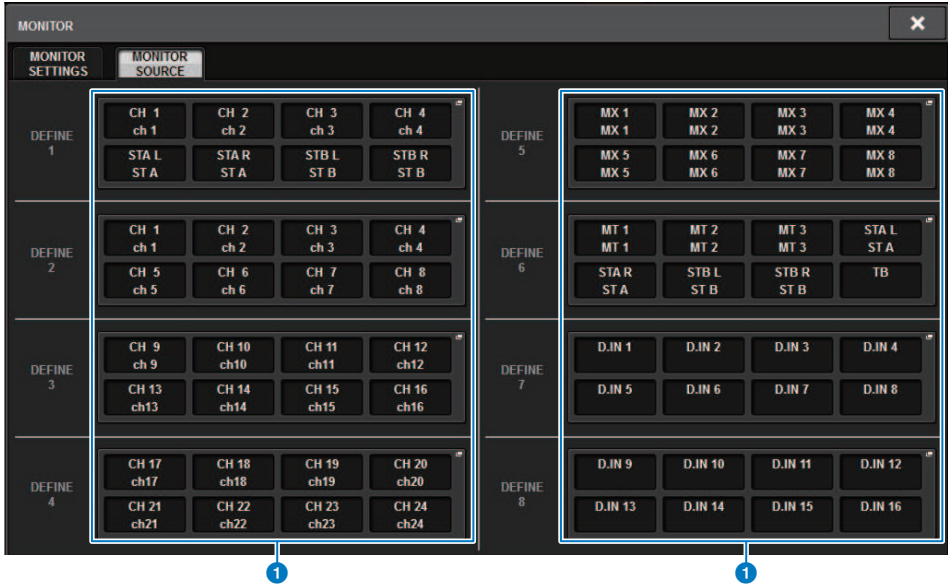

This screen contains the following items.

1 MONITOR SOURCE DEFINE buttons

Each button displays the name of the assigned monitor source. Press these buttons to access the MONITOR SOURCE SELECT popup window, in which you can assign monitor sources to individual DEFINE buttons.

MONITOR SOURCE SELECT popup window (INPUT)

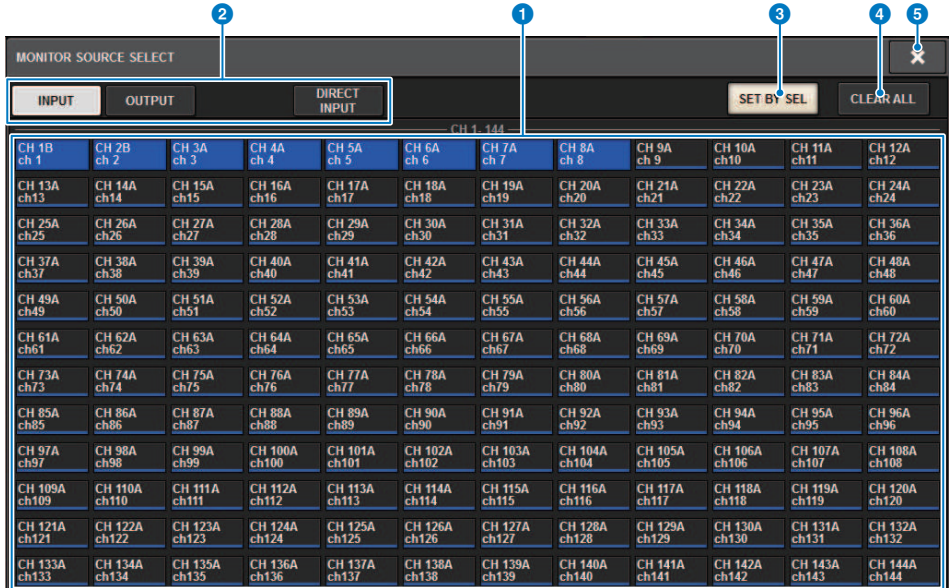

This screen contains the following items.

1 Monitor source selection buttons

Enable you to select monitor sources that will be assigned to the DEFINE buttons. The selected monitor sources will be highlighted. Press the same button again to cancel the selection.

NOTE

You can select up to eight monitor sources. If you select eight monitor sources, no further selections will be possible. First, turn off the buttons for unneeded sources.

2 Display switching tabs

Use these tabs to select the type of channels, buses, output jacks, etc. that you want to view on the screen.

3 SET BY SEL button

If this button is on, you will be able to add a channel by using the corresponding [SEL] key.

4 CLEAR ALL button

Press this button to clear all selections.

5 CLOSE button

Press this button to close the popup window and return to the previous screen.

MONITOR SOURCE SELECT popup window (OUTPUT)

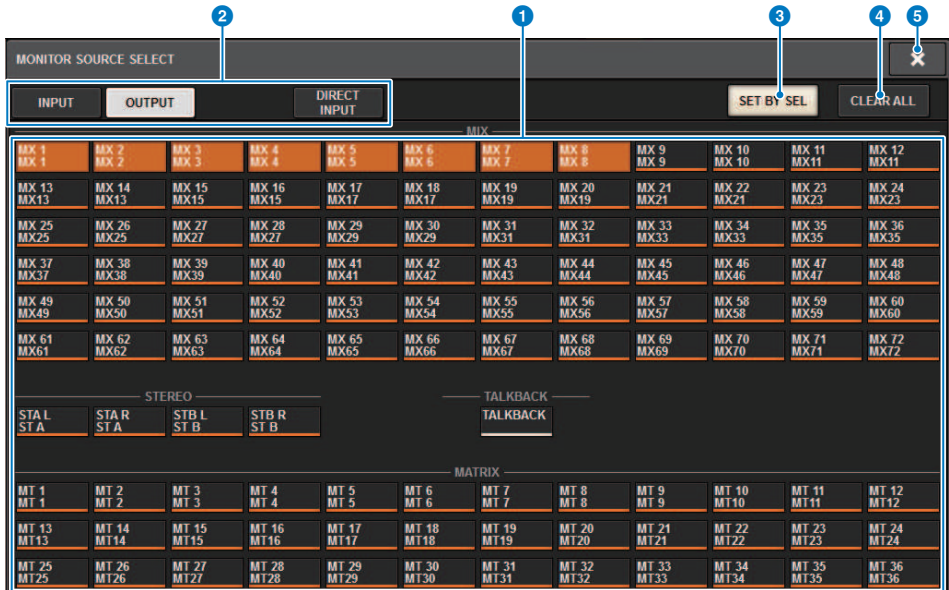

This screen contains the following items.

1 Monitor source selection buttons

Enable you to select monitor sources that will be assigned to the DEFINE buttons. The selected monitor sources will be highlighted. Press the same button again to cancel the selection.

NOTE

You can select up to eight monitor sources. If you select eight monitor sources, no further selections will be possible. First, turn off the buttons for unneeded sources.

2 Bus display switching tabs

Use these tabs to select the type of channels, buses, output jacks, etc. that you want to view on the screen.

3 SET BY SEL button

If this button is on, you will be able to add a channel by using the corresponding [SEL] key.

4 CLEAR ALL button

Press this button to clear all selections.

5 CLOSE button

Press this button to close the popup window and return to the previous screen.

MONITOR SOURCE SELECT popup window (DIRECT INPUT)

In this window you can assign the slots or ports to up to 16 channel direct inputs as the possible direct monitor sources. You can select up to eight direct monitor sources.

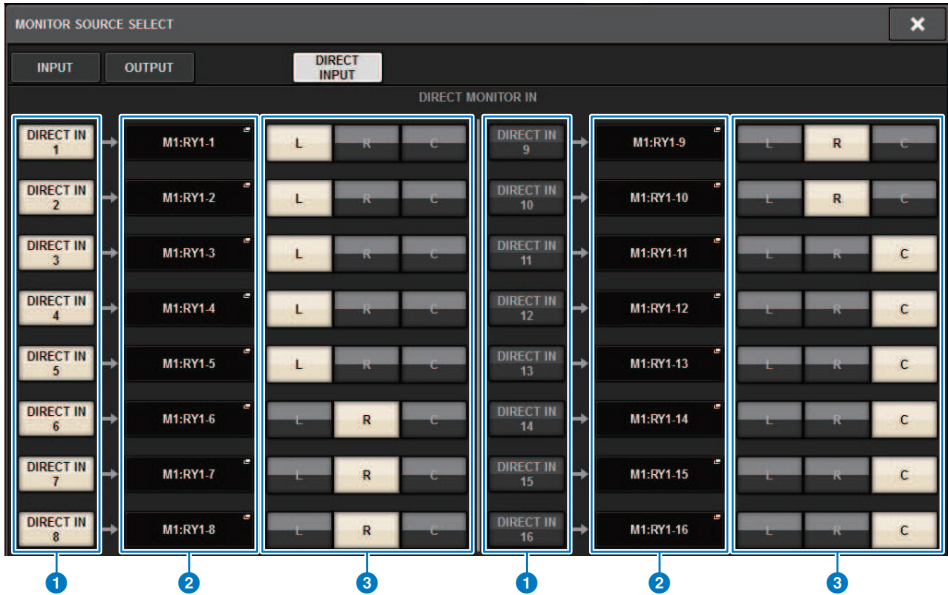

1 Monitor source selection buttons

Enable you to select the direct inputs.

NOTE

You can select up to eight monitor sources. If you select eight monitor sources, no further selections will be possible. First, turn off the buttons for unneeded sources.

2 INPUT PATCH popup buttons

Indicate the selected jacks. When you press one of these buttons, the INPUT PATCH popup window will appear, in which you can select input jacks, slots and channels.

3 L/R/C select buttons

Enable you to select to which channel (L/R/C) the monitor signal is input.

INPUT PATCH popup window

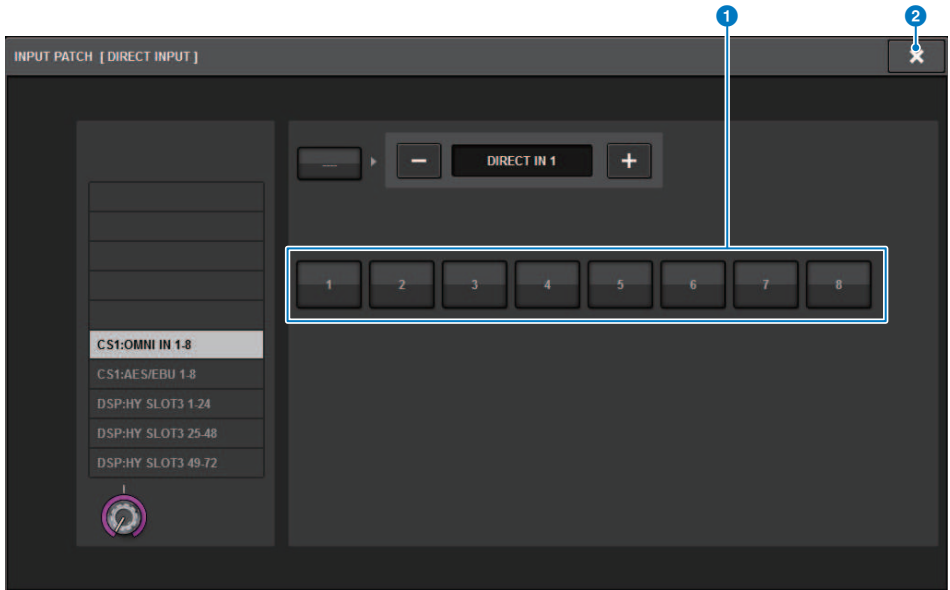

This screen contains the following items.

- 1 Input jack select buttons**
Enable you to select the input jacks from which you want to monitor the signals.
- 2 CLOSE button**
Press this button to close the popup window and return to the previous screen.

Inserting a plug-in into monitor signals

You can insert a plug-in into the monitor signals (L, R and C) of MONITOR A and MONITOR B individually. You can insert plug-ins and GEQ/PEQ.

1 Press the MONITOR button on the menu bar to access the MONITOR screen.

2 Press the MONITOR popup button or the meter field.

The “MONITOR SETTINGS popup window (insert)” (p.408) appears.

3 Press the INSERT button.

The “MONITOR INSERT popup window” (p.409) appears. If effects have already been inserted, the EDIT window for the plug-ins will appear.

4 Press the MOUNT popup button.

The “INSERT MOUNT screen” (p.410) appears.

5 Press the desired insert plug-in button.

6 Press the OK button.

7 Edit the effect parameters as desired.

For details on editing the effect parameters, refer to “Controlling the parameters of a plug-in.”

MONITOR SETTINGS popup window (insert)

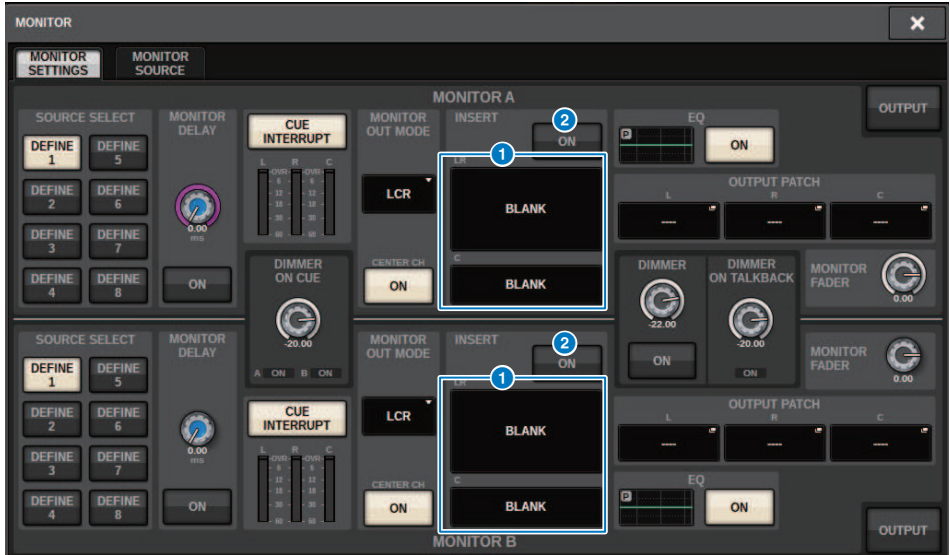

This screen contains the following items.

1 INSERT button

Press this button to display the window, in which you can insert plug-ins into the monitor signal.

2 INSERT ON button

Switches the plug-in insert on or off. The currently-specified plug-ins are displayed to the left of the INSERT ON button.

MONITOR INSERT popup window

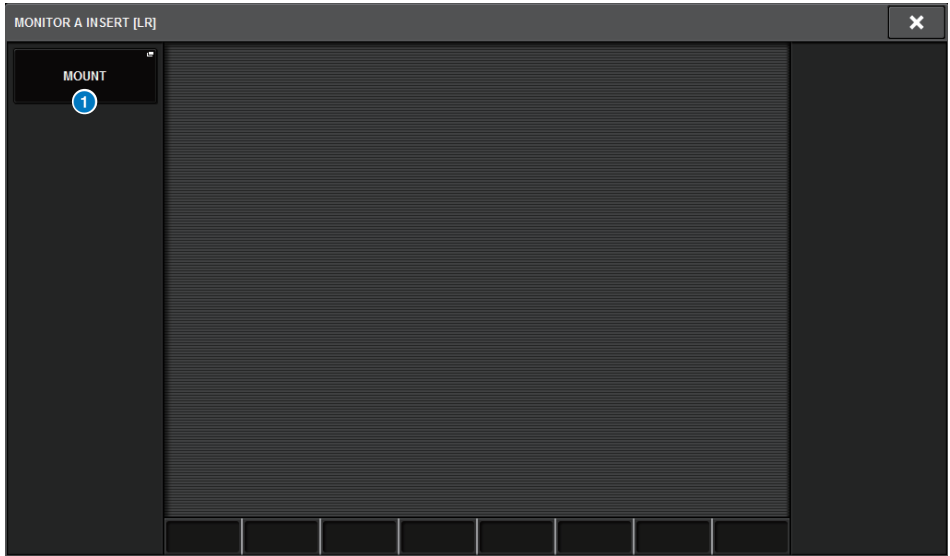

This screen contains the following items.

1 MOUNT popup button

Press this button to display the window, in which you can insert plug-ins to the monitor signal.

INSERT MOUNT screen



This screen contains the following items.

- 1 Tabs**
Enable you to select REVERB, DELAY/MOD, EQ/DYNAMICS, or GEQ/PEQ.

About cue

In order to check the sound of a selected individual channel or DCA, you can output it to MONITOR OUT, CUE OUT, or PHONES OUT for auditioning. The RIVAGE PM series provides two cue outputs, CUE A and CUE B.

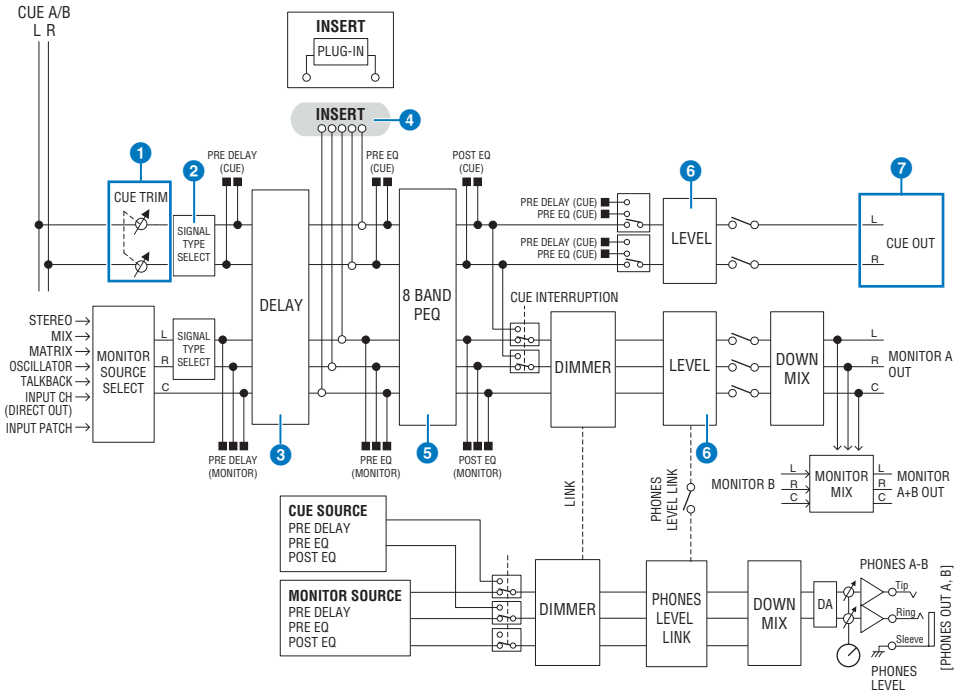

Number of systems

The RIVAGE PM10 features two cue outputs: CUE A and CUE B.

Structure of the cue circuit

The cue circuit is stereo, with an L-channel and R-channel.

1 CUE TRIM

INPUT CUE/OUTPUT CUE specify the monitor level when PFL is selected. DCA CUE specifies the monitor level when DCA is cued. DCA Unity lets you monitor each DCA at unity gain (the same level as when the DCA fader is set to 0 dB).

2 CUE OUT MODE

Downmixes the L/R signals to monaural.

3 DELAY

Allows you to delay the cue signal. You can specify up to 1000 msec.

4 INSERT

A plug-in, GEQ, or PEQ can be inserted. This is a single insert point which is fixed at PRE EQ (immediately before the EQ).

5 PEQ

A dedicated 8-band parametric EQ for the cue is provided.

6 CUE LEVEL

This adjusts the output level of the CUE channel. The CUE level can also be assigned to a fader.

7 Output structure

- L-channel and R-channel of CUE A
- L-channel and R-channel of CUE B

CUE MODE

You can select either MIX CUE or LAST CUE as the cue mode.

MIX CUE: All selected channels will be mixed and auditioned.

LAST CUE: Only most recently selected channel will be auditioned.

CUE stack

Cue signals are divided into four groups: INPUT CUE group, DCA CUE group, OUTPUT CUE group, and other CUE group.

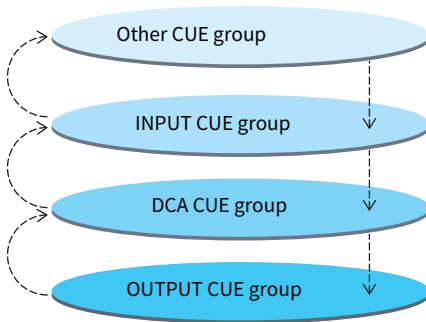

The illustration above shows the priority of the [CUE] keys. After you have switched groups from lower to upper levels, if you then defeat cue for the upper group, the previous [CUE] key status of the group immediately below will be restored. For example, if you switch groups in the order of OUTPUT CUE group -> DCA CUE group -> INPUT CUE group -> Other CUE group, you can then successively defeat the [CUE] keys (CUE/ KEY IN buttons) to successively restore the [CUE] key status of the previously-selected group.

CUE/SEL LINK

The [SEL] keys can be linked to the [CUE] key that is pressed. For more information, refer to Part 2.

SOLO

“Solo” is a function that outputs only the signal of a specific input channel or output channel. Only the signal of the channel whose [CUE] key is pressed is output, and the other channels are muted. The signal of a channel whose [CUE] key is pressed can also be monitored from the CUE OUT jacks, MONITOR OUT jacks, and PHONES jack.

- **SOLO SAFE**

As necessary, you can select channels that will not be muted when Solo is performed.

Channel Mode/Bay Mode

You can choose one of two modes: “Channel Mode” which lets you specify the CUE A/B destination of each channel, and “Bay Mode” which lets you specify the cue destination of each control surface bay being operated. The choice of Channel Mode or Bay Mode is made in the PREFERENCES page.

• Channel Mode

This mode assumes that one operator is using two cue buses separately. Each channel’s cue audio destination (Cue A, B, A+B) can specified individually.

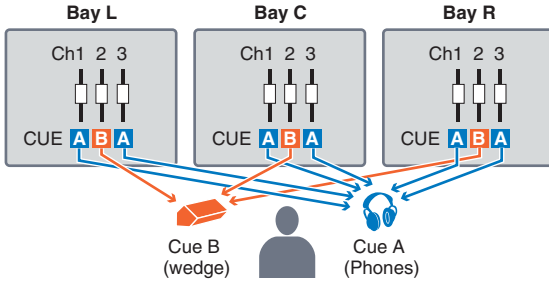

• Bay Mode

This mode assumes two operators will operate the system. You can specify the cue destination (CUE A and B) for each Bay.

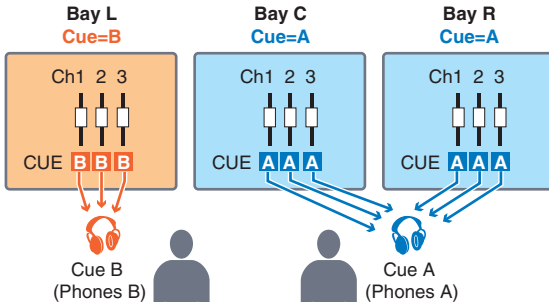

About Cue mode and Solo mode

All input channels, output channels, and DCAs feature the [CUE] key for the Cue/Solo function. The [CUE] key provides two modes: Cue mode and Solo mode. These modes differ as follows.

- **Cue mode**

If you press the [CUE] key for the channels or DCAs, the corresponding cue signals will be sent to the dedicated CUE bus and then output from MONITOR OUT, PHONES OUT, and CUE OUT (Cue function). Choose this mode if you want to monitor certain channel signals without affecting other output buses.

- **Solo mode**

If you press the [CUE] key for the channels or DCAs, only the solo signals will be output from the MIX/MATRIX/STEREO buses. Other channels/DCAs will be muted (Solo function). The same signal can also be monitored from MONITOR OUT, PHONES OUT, and CUE OUT.

NOTE

In Solo mode, you can exclude specific certain channels from Solo operations (“Using the Cue function” (p.419)).

About cue/solo groups

The cue signals can be categorized into the following four groups.

1 OUTPUT CUE group

The cue/solo signals of output channels make up this group. To switch Cue/Solo for this group, in the Channel Strip section, press the OUTPUT [MIX]/[MATRIX] key, and then press the desired [CUE] key.

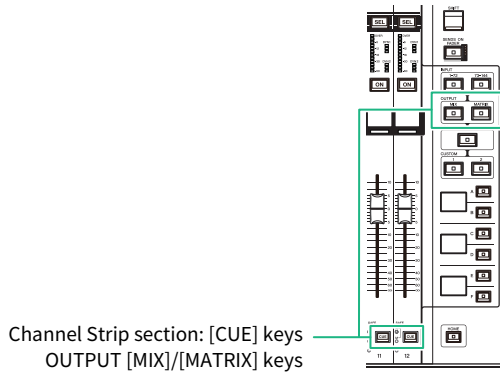

2 DCA CUE group

The cue/solo signals of DCAs make up this group. To enable Cue/Solo for this group, in the Channel Strip section, press the [DCA] key, and then press the desired [CUE] key.

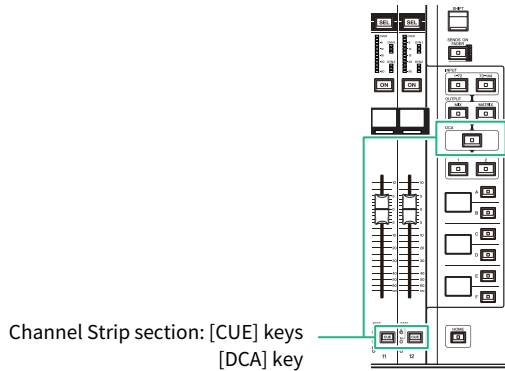

3 INPUT CUE group

The cue/solo signals of input channels make up this group. To enable Cue/Solo for this group, in the Channel Strip section, press the INPUT [1-72]/[73-144] key, and then press the desired [CUE] key.

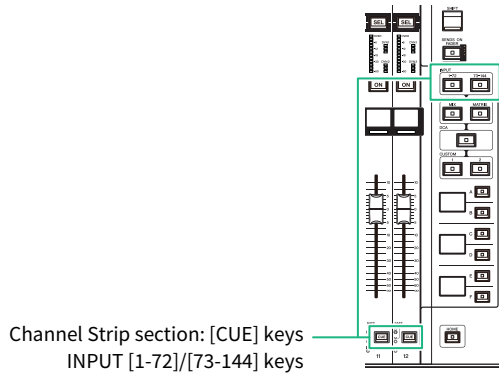

4 Other CUE group

These cue signals are operated via buttons displayed on the touch screen. This group is enabled if you turn on the KEY IN CUE button in any plug-in's popup window or in the DYNAMICS 1/2 popup window. This group will automatically be disabled when you exit the corresponding popup window. You cannot turn Cue on for different groups simultaneously. Normally, the group to which the most recently-pressed [CUE] key (or on-screen CUE/KEY IN CUE button) belongs will take priority, and the [CUE] keys for the previously-selected group will be defeated. However, if you have switched the cue signal group in a specific order, the state of the [CUE] keys for the previously-selected group will be restored when the current cue signal is defeated.

The illustration shows the priority of the [CUE] keys. After you have switched groups from lower to upper levels, if you then defeat cue for the upper group, the previous [CUE] key status of the group immediately below will be restored. For example, if you switch groups in the order of OUTPUT CUE group -> DCA CUE group -> INPUT CUE group -> Other CUE group, you can then successively defeat the [CUE] keys (CUE/KEY IN buttons) to successively restore the [CUE] key status of the previously selected group.

Monitor > About cue/solo groups

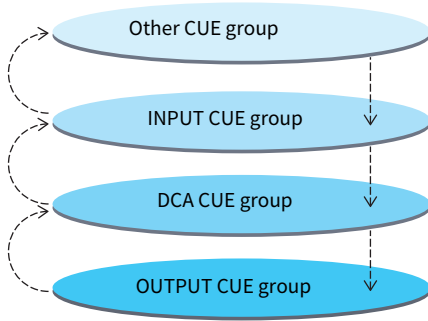

CUE OPERATION mode

About CUE OPERATION mode in Cue mode

- **CH (Channel) mode**

This mode assumes only one operator will operate the system. You can specify the cue destination (CUE A, B, and A+B) for each channel individually. You can change this destination for each channel individually by holding down the [SHIFT] key and pressing the desired [CUE] key. (A->B->A+B->A->B->...)

- **BAY mode**

This mode assumes two operators will operate the system. You can specify the cue destination (CUE A and B) for each bay. For example, you can send the same channel signal from bay L to CUE B, and bay C to CUE A.

NOTE

You can also set the mode in the OPERATION MODE field in the PREFERENCES popup window ("SURFACE SETTINGS1" (p.920)).

Using the Cue function

This section explains how to use the [CUE] key of a desired channel or DCA to monitor the Cue signal.

NOTE

Be aware that if you turn CUE INTERRUPTION off in the MONITOR SETTINGS popup window, the cue signal will not be sent to the connected monitor speakers. However, the PHONES output jacks on the front panel will always output cue signals regardless of the Monitor on/off setting. For details on the Monitor function settings, refer to “Using the Monitor function” (p.394).

1 Press the **MONITOR** button on the menu bar.

The “MONITOR screen (cue)” (p.421) appears. The CUE field on the MONITOR screen enables you to check the current cue settings, and turn Cue on or off.

2 Press the **CUE** popup button or the **INPUT/DCA/OUTPUT CUE** field.

The CUE popup window appears.

3 Press the **CUE SETTINGS** popup button.

The “CUE SETTINGS popup window” (p.426) appears. You can select the cue destination (CUE A, CUE B, or A+B).

4 Use the **CUE MODE** buttons to select either the mode in which channels are mixed for monitoring, or the mode in which only the last-selected channel is monitored.

Select the MIX CUE button or LAST CUE button.

NOTE

In MIX CUE mode, it is not possible to simultaneously turn on Cue for different Cue groups. The Cue group to which the last-cued signal belongs will be turned on, allowing only the signals of that Cue group to be monitored. However, if CUE OPERATION MODE is set to BAY and if LAST CUE is selected, the cue setting in each bay will be active individually.

5 Use the buttons and knobs of the **INPUT CUE** field, **DCA CUE** field, and **OUTPUT CUE** field to specify the output position and output level for each Cue group.

Refer to the explanation for each item in the Cue popup window, and make the desired settings.

6 To specify a port as the output destination for cue signals **L** and **R**, press one of the **CUE OUTPUT PATCH** buttons (**L/R**).

The “OUTPUT PATCH popup window” (p.427) appears. Choose from the following cue signal output destinations (multiple selections are allowed).

When you have selected output ports, press the CLOSE button to close the CUE OUTPUT PATCH popup window.

7 To enable Cue Out for the ports you specified in step 4, press the **CUE OUTPUT** button to turn it on.

8 Press the [CUE] key of a desired channel or DCA to turn it on.

The cue signal of the corresponding channel will be sent to the output destination specified in step 4, and also to the monitor output. You can also view the Cue meter in the meter area to check the output level of the cue signal.



NOTE

- When using the MIX/MATRIX bus select buttons in the SENDS ON FADER popup window, you can press the selected button once again to turn on Cue for the corresponding MIX/MATRIX channel ("Using the Selected Channel section to make send level settings(CS-R10, CSR10- S, CSD-R7)" (p.542)).
- If you want cue operations and channel select operations to be linked, open the SETUP window, choose PREFERENCES popup window, and then turn on "[CUE]→[SEL] LINK."

9 If you are auditioning the cue signal in the monitor, adjust the cue signal level by using the MONITOR A/B knobs located in the UTILITY section of the top panel. Also adjust the MONITOR FADER LEVEL in conjunction with this.

If PHONES LEVEL LINK is ON, you can use the MONITOR A/B knob, the monitor fader, and the PHONES A/B LEVEL knob to adjust the cue signal level while monitoring through headphones.

NOTE

To adjust the level of the signal sent to the Cue Out port (which you specified in step 6), use OUTPUT PORT GAIN for the patch destination.

10 To defeat cue, press the currently-on [CUE] key once again.

You can press the CLEAR CUE button in the CUE popup window to clear all cue selections.

NOTE

- If you press the cue meter in the meter area, all cue selections will be cleared.
- All cue selections will be cleared if you switch between MIX CUE mode and LAST CUE mode in the CUE MODE section.
- You can also assign the function of the CLEAR CUE button to a USER DEFINED key (see USER DEFINED keys).

MONITOR screen (cue)

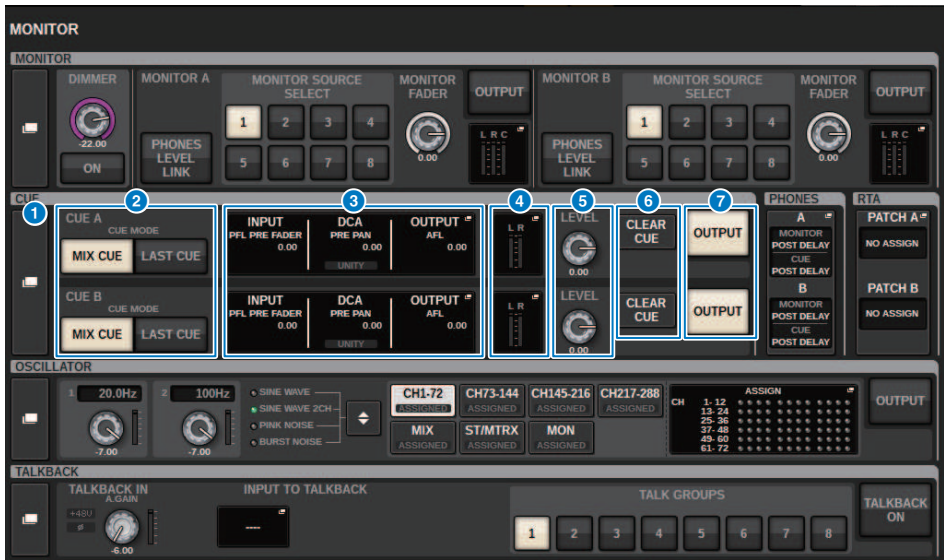

This screen contains the following items.

1 CUE popup button

Enables you to access the CUE popup window, in which you can make detailed cue settings. Select CUE A or B as the control target, and set the parameters in the corresponding field.

2 CUE MODE buttons

Enable you to specify the operation mode when multiple [CUE] keys are on.

- **MIX CUE mode**

All selected channels will be cue-monitored.

- **LAST CUE mode**

Only most recently selected channel will be cue-monitored.

3 INPUT/DCA/OUTPUT CUE field

Indicates the settings for input cue, DCA cue, and output cue. Press this field to open the CUE popup window.

4 Meter popup button

This field indicates the output level of the cue L/R channels.

5 CUE LEVEL knob

Sets the output level of each Cue bus.

6 CLEAR CUE button

Cancels all cue selections simultaneously. If the CUE MODE setting is MIX CUE, all of the selected channels will be cleared.

Monitor > MONITOR screen (cue)

7 CUE OUTPUT button

Switches Cue Out on or off.

CUE popup window

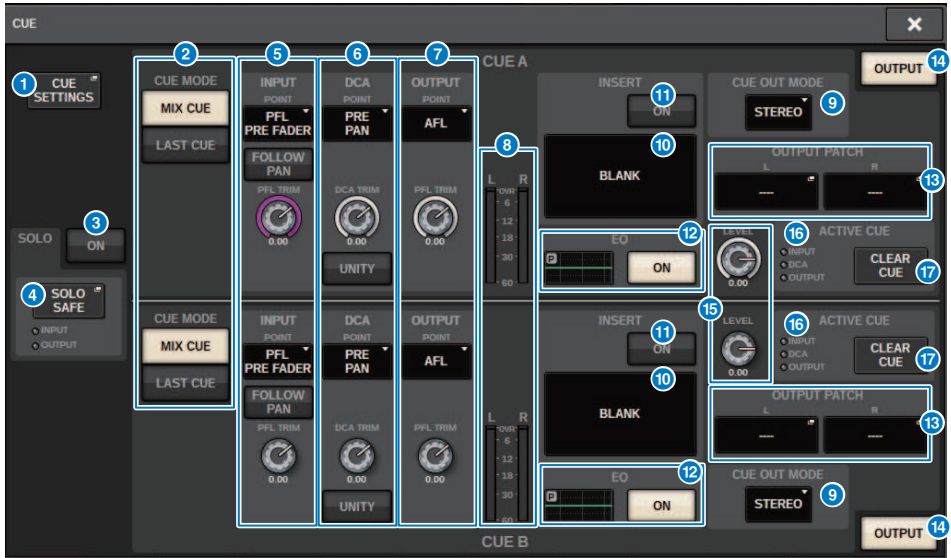

This screen contains the following items.

1 CUE SETTINGS popup button

Press this button to access the CUE SETTINGS popup window, in which you can select the cue destination. You can select the cue destination (CUE A, CUE B, or A+B) for each channel.

NOTE

If CUE OPERATION MODE is set to BAY on the PREFERENCES popup window the cue destination will be specified for each bay. Therefore, this setting will be invalid. (“SURFACE SETTINGS1” (p.920))

2 CUE MODE buttons

Select one of the following two cue modes:

- **MIX CUE**

All selected channels will be mixed and auditioned.

- **LAST CUE**

Only most recently selected channel will be auditioned.

3 SOLO ON button

Switches the Solo function on or off.

4 SOLO SAFE popup button

Press this button to access the “SOLO SAFE popup window” (p.430), in which you can exclude a channel from the mute target in Solo mode.

5 INPUT CUE field

This field enables you to make settings related to the input channel cue.

- **Cue point select button**

Sets the cue point to PRE FILTER (immediately before the filter), PRE FADER (immediately before the fader), AFL (immediately after the fader), or POST PAN (immediately after PAN).

NOTE

Be aware that if you select POST PAN, you will be unable to monitor signals sent to the MONO bus from an input channel that is set to LCR mode.

- **INPUT FOLLOW PAN button**

If this button is on, the TO STEREO PAN setting will be applied to the pan setting of the signal sent from input channels to the CUE bus.

- **PFL TRIM knob**

Specifies the monitor levels when PFL is selected. Use the screen encoder to adjust the value.

6 DCA CUE field

This section enables you to make settings related to DCA cue.

- **Cue point select button**

Sets the cue point for DCA to PRE PAN (immediately before PAN) or POST PAN (immediately after PAN).

- **DCA TRIM knob**

Indicates the monitor level of cue signals from a DCA. Use the screen encoder to adjust the value.

- **UNITY button**

Turn on this button to monitor signals at the same volume level that was obtained when the main level for each DCA was set to 0 dB (unity gain).

7 OUTPUT CUE field

Enables you to make settings related to output channel cue.

- **Cue point select button**

Enables you to set the cue point for the output channel to PFL (immediately before fader) or AFL (immediately after fader).

- **PFL TRIM knob**

Indicates the monitor levels when PFL is selected. Use the screen encoder to adjust the value.

8 Meters

This field indicates the output level of the cue L/R channels.

9 CUE OUT MODE select button

You can output the cue signal in stereo or monaural.

10 INSERT button

Press this button to display the window, in which you can insert plug-ins into the cue signal.

11 INSERT ON button

Switches the plug-in insert on or off. The currently-specified plug-ins are displayed to the left of the INSERT ON button.

12 EQ field

- **EQ graph**

This field graphically indicates the approximate response of the EQ. Press this field to open the window, in which you can set the EQ parameters.

- **EQ ON button**

Switches the EQ on or off.

13 CUE OUT PATCH button

Press this button to access the PORT SELECT popup window, in which you can select output ports to patch to the cue out L/R channels.

14 CUE OUTPUT button

Switches cue output on or off.

15 CUE LEVEL knob

Indicates the cue output level. Use the screen encoder to adjust the value.

16 ACTIVE CUE indicator

Lights to indicate the type of cue currently being monitored.

17 CLEAR CUE button

Press this button to clear all cue selections simultaneously.

CUE SETTINGS popup window



This screen contains the following items.

1 Channel select list

Enables you to select a channel.

2 ALL button

Press this button to apply or cancel the selected cue destination (CUE A, CUE B) for all channels simultaneously. If the send point is not selected for some channels in the column, “...” will appear.

3 CUE select buttons

Enable you to select the cue destination for each channel.

OUTPUT PATCH popup window

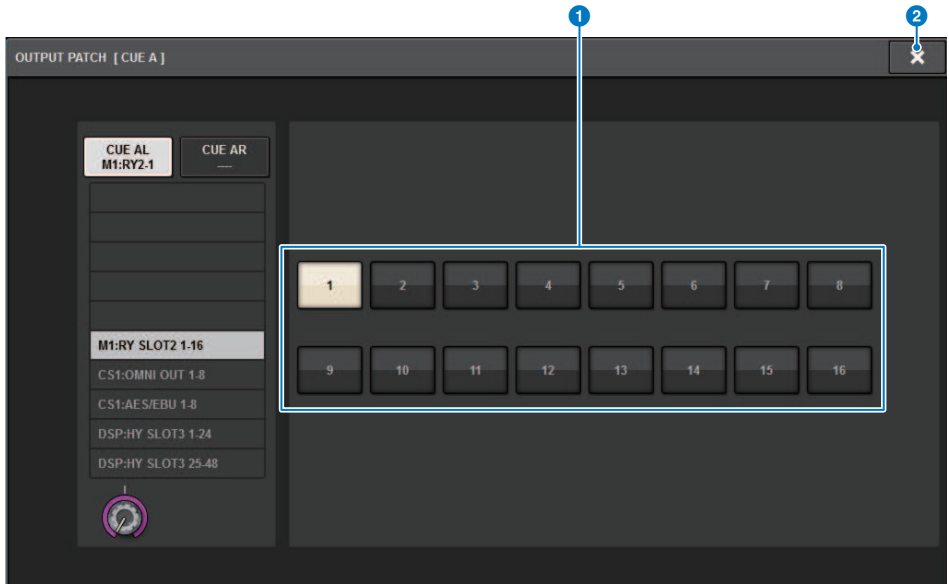

This screen contains the following items.

1 Output jack select buttons

Enable you to select the output jacks to which the signals will be routed.

2 CLOSE button

Press this button to close the popup window and return to the previous screen.

Using the Solo function

This function enables you to monitor the signals routed from one or more specified channels to the main mix outputs.

- 1 On the MONITOR screen, press the CUE popup button or the INPUT/DCA/OUTPUT CUE field to open the CUE popup window.**



- 2 Use the CUE MODE buttons to select either the mode in which channels are mixed for monitoring, or the mode in which only the last-selected channel is monitored.**

Select the MIX CUE button or LAST CUE button.

- 3 Press the SOLO ON button to turn Solo on.**

The confirmation window for solo operation appears.

- 4 To execute the solo operation, press the OK button.**

The button will light up and Solo mode will be enabled.

- 5 If you want to exclude certain channels or groups from Solo operations as necessary, press the SOLO SAFE popup button.**

The "SOLO SAFE popup window" (p.430) appears.

6 Select input channels that will be excluded from Solo operations. (You can specify more than one.)

The channels specified here will not be muted in Solo mode. The Solo Safe function is useful if you do not want to accidentally mute certain channels during Solo operations, such as the main Stereo channels, or Mix channels that send out mix signals to an external recorder.

7 Press the [CUE] key of a desired channel or DCA to turn it on.

Only the corresponding channel or DCA will be output to the buses and output jacks; other channels and DCAs will be muted. The same signal will also be output from the CUE OUT jacks and the MONITOR OUT jacks.

NOTE

If you turn on the [CUE] key of an output channel, the signal will be sent only to the corresponding bus.

8 To defeat Solo, press the currently-on SOLO ON/OFF button once again.

NOTE

If you select the LAST CUE button to switch from LAST CUE mode to MIX CUE mode (or vice versa), all previously-enabled Cue (Solo) signals will be defeated.

SOLO SAFE popup window

SOLO SAFE popup window (INPUT)

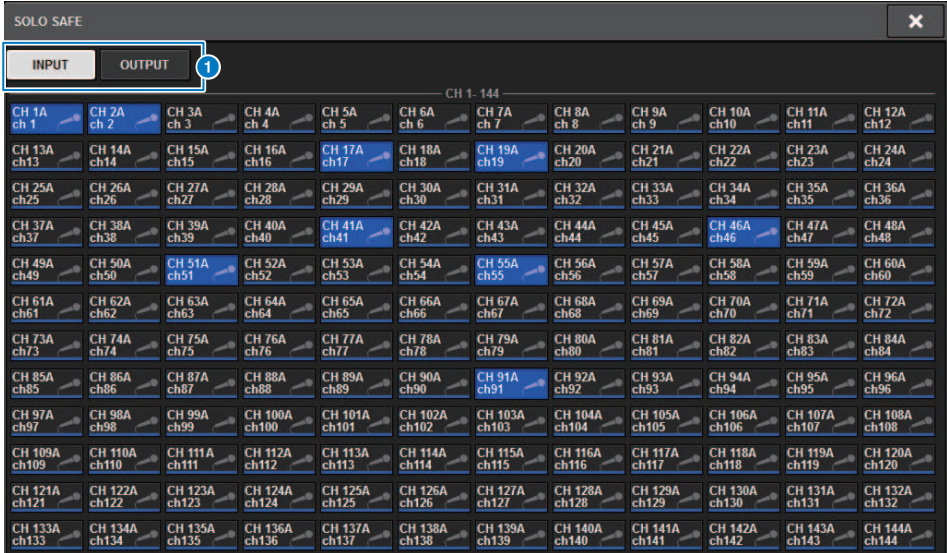

This screen contains the following items.

1 Tabs

You can select desired input channels and/or output channels as the Solo Safe target. When you switch the INPUT/ OUTPUT tabs, the following buttons will appear to enable you to select channels.

- **If you select the INPUT tab:**

CH 1-CH144 button

- **If you select the OUTPUT tab:**

MIX 1-MIX 72, MATRIX 1-MATRIX 36, ST A L, ST A R, ST B L, and ST B R buttons

SOLO SAFE popup window (OUTPUT)

SOLO SAFE											
INPUT		OUTPUT									
MIX											
MX 1 MX 1	MX 2 MX 2	MX 3 MX 3	MX 4 MX 4	MX 5 MX 5	MX 6 MX 6	MX 7 MX 7	MX 8 MX 8	MX 9 MX 9	MX 10 MX10	MX 11 MX11	MX 12 MX12
MX 13 MX13	MX 14 MX14	MX 15 MX15	MX 16 MX16	MX 17 MX17	MX 18 MX18	MX 19 MX19	MX 20 MX20	MX 21 MX21	MX 22 MX22	MX 23 MX23	MX 24 MX24
MX 25 MX25	MX 26 MX26	MX 27 MX27	MX 28 MX28	MX 29 MX29	MX 30 MX30	MX 31 MX31	MX 32 MX32	MX 33 MX33	MX 34 MX34	MX 35 MX35	MX 36 MX36
MX 37 MX37	MX 38 MX38	MX 39 MX39	MX 40 MX40	MX 41 MX41	MX 42 MX42	MX 43 MX43	MX 44 MX44	MX 45 MX45	MX 46 MX46	MX 47 MX47	MX 48 MX48
MX 49 MX49	MX 50 MX50	MX 51 MX51	MX 52 MX52	MX 53 MX53	MX 54 MX54	MX 55 MX55	MX 56 MX56	MX 57 MX57	MX 58 MX58	MX 59 MX59	MX 60 MX60
MX 61 MX61	MX 62 MX62	MX 63 MX63	MX 64 MX64	MX 65 MX65	MX 66 MX66	MX 67 MX67	MX 68 MX68	MX 69 MX69	MX 70 MX70	MX 71 MX71	MX 72 MX72
STEREO											
STA L ST A	STA R ST A	STB L ST B	STB R ST B								
MATRIX											
MT 1 MT 1	MT 2 MT 2	MT 3 MT 3	MT 4 MT 4	MT 5 MT 5	MT 6 MT 6	MT 7 MT 7	MT 8 MT 8	MT 9 MT 9	MT 10 MT10	MT 11 MT11	MT 12 MT12
MT 13 MT13	MT 14 MT14	MT 15 MT15	MT 16 MT16	MT 17 MT17	MT 18 MT18	MT 19 MT19	MT 20 MT20	MT 21 MT21	MT 22 MT22	MT 23 MT23	MT 24 MT24
MT 25 MT25	MT 26 MT26	MT 27 MT27	MT 28 MT28	MT 29 MT29	MT 30 MT30	MT 31 MT31	MT 32 MT32	MT 33 MT33	MT 34 MT34	MT 35 MT35	MT 36 MT36

About oscillators

The RIVAGE PM10 features two oscillators that output individual sine waves with different frequencies to the desired channels. Also, LPF and HPF are provided for noise output.

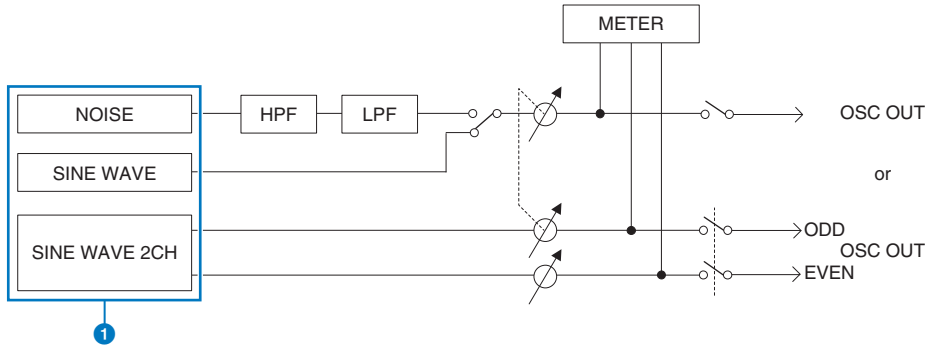

1 Oscillator operation mode

- SINE WAVE
- SINE WAVE 2CH
- NOISE (PINK NOISE/BURST NOISE)

NOTE

Oscillator assignments and on/off switching can also be assigned to a USER DEFINED key.

Using the oscillators

You can send a sine wave or pink noise from the internal oscillator to a desired bus.

1 Press the MONITOR button on the menu bar.

The “MONITOR screen (oscillator)” (p.435) appears. The OSCILLATOR field in the MONITOR screen lets you check the current oscillator settings, and turn the oscillator on or off.

If you want to view or edit the oscillator settings in greater detail, use the OSCILLATOR popup window described in step 2 and subsequent steps.

2 Press the OSCILLATOR popup button or the ASSIGN field.

The “OSCILLATOR popup window” (p.436) appears. In this popup window, you can make detailed settings for the oscillator.

3 Press a button in the MODE field to select the type of signal you want to output.

4 Use the knobs and buttons in the parameter field to adjust the oscillator parameters.

The displayed parameters will vary depending on the oscillator selected in the MODE field. To control the knobs shown in the parameter field, use the corresponding screen encoders.

5 Press a button in the ASSIGN field to specify the input channel(s) or bus(es) to which the oscillator signal will be sent (multiple selections are allowed).

The buttons correspond to the following buses. (“Destination of oscillator signals” (p.434))

6 To enable the oscillator, press the OUTPUT button to turn it on.

The oscillator signal will be sent to the input channel or bus you selected in step 5. When you press the button again, the oscillator will turn off.

NOTE

You can also assign oscillator on/off or an ASSIGN change to a USER DEFINED key (USER DEFINED keys).

Destination of oscillator signals

The buttons correspond to the following buses.

CH1-72 button	Input channels 1-72
CH73-144 button ¹	Input channels 73 -144 ¹
MIX button	MIX bus
ST / MTRX button	STEREO A bus L, STEREO A bus R, STEREO B bus L, STEREO B bus R, MATRIX buses
MONITOR button	MONITOR A L, MONITOR A R, MONITOR A C, MONITOR B L, MONITOR B R, MONITOR B C

* 1 The number of channels varies depending on the connected DSP engine.

INPUT 1-144 (DSP-R10, CSD-R7)

INPUT 1-288 (DSP-RX-EX)

INPUT 1-120 (DSP-RX)

MONITOR screen (oscillator)



This screen contains the following items.

1 OSCILLATOR pop up button

Enables you to access the OSCILLATOR popup window, in which you can make detailed oscillator settings.

2 OSCILLATOR LEVEL field

Adjusts the level of the oscillator. A meter beside the LEVEL knob indicates the output level of the oscillator. If OSCILLATOR MODE is set to SINE WAVE, the frequency of the oscillator is shown. Press the LEVEL knob to adjust the oscillator level using the corresponding screen encoder. The range is -96.00 dB to 0.00 dB.

3 OSCILLATOR MODE field

Indicates the selected oscillator mode. Pressing the MODE button repeatedly will switch modes.

- SINE WAVE
- SINE WAVE 2CH
- PINK NOISE
- BURST NOISE

4 OSCILLATOR ASSIGN field

An indicator lights to indicate the currently-selected oscillator output destination (input channels, buses or monitor). Use the buttons at the left to switch the indicators. A green "ASSIGNED" indicator lights up on buttons that contain a channel/bus selection. Press this field to open the OSCILLATOR popup window, in which you can assign the oscillator output to buses.

5 OSCILLATOR OUTPUT button

Turns the oscillator output on or off.

OSCILLATOR popup window

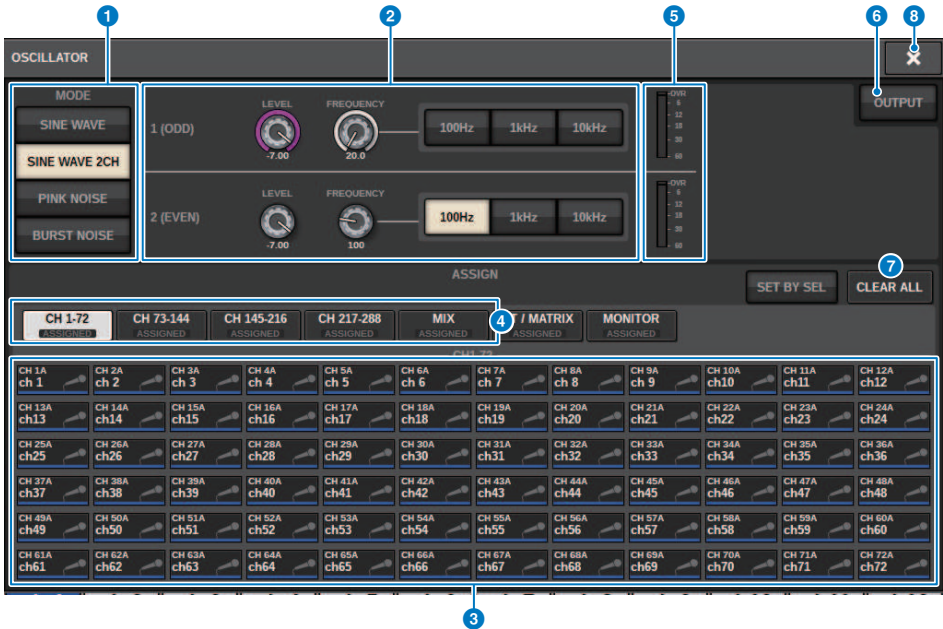

This screen contains the following items.

1 OSCILLATOR MODE buttons

Select one of the following four oscillator operating modes:

SINE WAVE A sine wave is output continuously.

SINE WAVE 2CH Two sine waves (with different frequencies) are output separately.

PINK NOISE Pink noise is output.

BURST NOISE Pink noise is output intermittently.

2 Parameter field

Enables you to set the oscillator parameters. The controllers and their functions in this field vary depending on the operating mode **1**.

SINE WAVE:



• LEVEL knob

Indicates the output level of the sine wave. Use the screen encoder to adjust the value.

• FREQUENCY knob

Indicates the frequency of the sine wave. Use the screen encoder to adjust the value.

Monitor > OSCILLATOR popup window

- **FREQUENCY buttons**

Enables you to select the sine-wave frequency from 100 Hz, 1 kHz, and 10 kHz.

SINE WAVE 2CH:

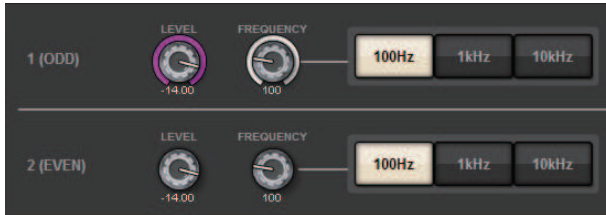

- **LEVEL knob (ODD)**

Indicates the output level of the odd-channel sine wave. Use the screen encoder to adjust the value.

- **FREQ knob (ODD)**

Indicates the frequency of the odd-channel sine wave. Use the screen encoder to adjust the value.

- **LEVEL knob (EVEN)**

Indicates the output level of the even-channel sine wave. Use the screen encoder to adjust the value.

- **FREQ knob (EVEN)**

Indicates the frequency of the even-channel sine wave. Use the screen encoder to adjust the value.

- **FREQUENCY buttons**

Enables you to select the sine-wave frequency from 100 Hz, 1 kHz, and 10 kHz.

The default frequency is 1 kHz for the odd channel and 400 Hz for the even channel. Two meters (odd and even) will be displayed.

PINK NOISE:



- **LEVEL knob**

Indicates the output level of the pink noise. Use the screen encoder to adjust the value.

- **HPF knob**

Indicates the cutoff frequency of the HPF that processes the pink noise. Use the screen encoder to adjust the value. Use the button below the knob to switch the HPF on or off.

- **LPF knob**

Indicates the cutoff frequency of the LPF that processes the pink noise. Use the screen encoder to adjust the value. Use the button below the knob to switch the LPF on or off.

For BURST NOISE:



Monitor > OSCILLATOR popup window

- **LEVEL knob, HPF knob, LPF knob**

These are the same as for the PINK NOISE mode.

- **WIDTH knob**

Indicates the length of noise being output intermittently. Use the screen encoder to adjust the value.

- **INTERVAL knob**

Indicates the length of silence between noise bursts. Use the screen encoder to adjust the value.

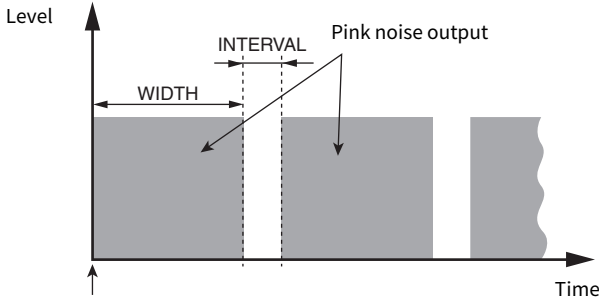

The BURST NOISE button is turned on.

3 ASSIGN section

Enables you to select a channel to which the oscillator signal will be sent. Press one of the five tabs below to select the type of channels/buses displayed, and then press the button(s) for the desired channels/buses (multiple selections are allowed). If SINE WAVE 2CH mode is selected, output signals will vary depending on whether the selected channel number is odd or even. For example, the odd-channel signal will be routed to MIX1 and the even-channel signal will be routed to MIX2. You can press the CLEAR ALL button to defeat all selections.

4 Channel display select buttons

Select the type of channels that you want to view on screen. Available options are CH1-72, CH73-144, MIX, ST/MTRX, and MONITOR. (The number of channels varies depending on the connected DSP engine.) A green “ASSIGNED” indicator lights up on buttons that contain a channel/bus selection.

5 Meter section

Indicates the oscillator output level.

6 OSCILLATOR OUTPUT button

Turns the oscillator on or off. If this button is turned on, the oscillator signal will be sent to the input channel or bus you selected in the ASSIGN section. When you press the button again, the oscillator will turn off.

7 CLEAR ALL button

Excludes all output channels from the oscillator signal destination.

8 CLOSE button

Closes the OSCILLATOR popup window.

About talkback

As a talkback input, you can select any input jack from input patches, as well as the TALKBACK jack on the top panel of the Control Surface.

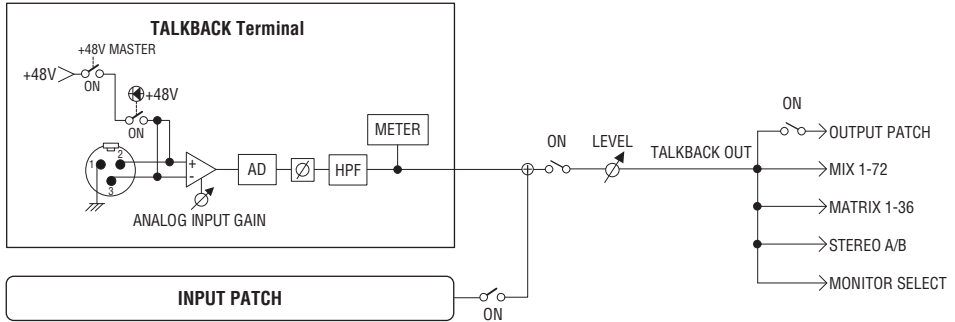

TALKBACK DIMMER

The dimmer function temporarily attenuates the monitor signal level when talkback is on. Two types of talkback dimmer are provided.

- **Talkback dimmer for monitor out**

Temporarily attenuates the monitor out volume so that the sound from the monitor speakers will not interfere with the input of the talkback mic.

- **Talkback dimmer for MIX, MATRIX, and STEREO**

Temporarily attenuates the volume of each MIX, MATRIX, and STEREO bus output signal so that excessive output from these buses will not make the talkback inaudible.

Using talkback (top panel)

Controlling the Monitor function via the UTILITY section

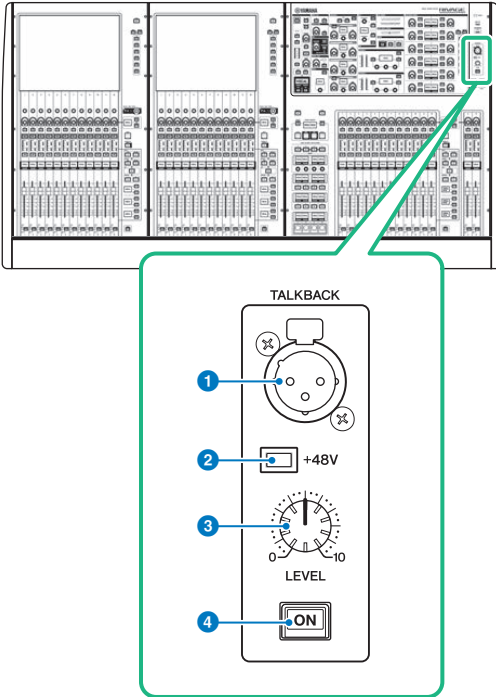

1 TALKBACK jack

This is a balanced XLR-3-31 jack to which a talkback mic can be connected.

2 +48V indicator

Lights up when +48V phantom power is supplied to the TALKBACK jack.

3 TALKBACK LEVEL knob

Adjusts the input level of the mic connected to the TALKBACK jack.

4 TALKBACK [ON] key

Switches the Talkback function on or off.

Using talkback

Controlling the Monitor function via the MONITOR window

The Talkback function sends the signal (that is input at the input ports) to the desired bus.

1 Press the **MONITOR** button on the menu bar.

The “MONITOR screen (talkback)” (p.443) is displayed. In the MONITOR window, the TALKBACK field allows you to check the current talkback settings, and turn talkback on or off.

If you want to view or edit the talkback settings in greater detail, use the TALKBACK popup window described in step 2 and following.

2 Press the **TALKBACK** popup button.

The “TALKBACK SETTINGS popup window” (p.445) is displayed. In this popup window, you can make detailed settings for talkback.

3 Connect a mic to the **TALKBACK** jack on the front panel, and then rotate the **TALKBACK** gain knob to adjust the input sensitivity of the mic signal. (CS-R10, CS-R10S, CSD-R7 only)

The meter in the TALKBACK IN field indicates the input level of the mic connected to the TALKBACK jack. Turn phantom power on or off, and set the phase to normal or reverse, as required by the connected mic.

4 If you want to use an input jack other than the **TALKBACK** jack as supplementary input for talkback, follow the steps below.

1 Press the INPUT TO TALKBACK button to open the INPUT PATCH popup window.

2 Press the button for the input that you want to use for talkback. You can select only one input at a time.

3 Use the GAIN knob and level meter in the INPUT TO TALKBACK field to adjust the input level of the connected mic.

5 Press the tab.

The “TALK GROUPS popup window” (p.448) opens.

6 Press the target **DEFINE** button.

The “TALKBACK ASSIGN popup window” (p.449) appears.

7 Select the bus(es) or output jack(s) as the destination of the talkback signal (multiple selections are allowed).

8 When you finish making settings, press the **CLOSE** button to close the popup window.

- 9 Repeat steps 6–8 to assign the buses to other DEFINE buttons, as needed.**
- 10 Select a DEFINE that you want to use for talkback, using DEFINE buttons in the TALK GROUPS field on the MONITOR screen or in the TALK GROUPS field in the TALKBACK SETTINGS popup window.**
- 11 To enable talkback, press the TALKBACK ON button to turn it on.**

The TALKBACK ON button will alternately turn on or off each time you press the button (Latch operation). While talkback is on, signals from the TALKBACK jack and the selected INPUT jack will be output to the destination buses.

NOTE

- You can also assign talkback on/off or an ASSIGN change to a USER DEFINED key. In this case, you can select either a Latch operation or an Unlatch operation (the function will be enabled only while you continue holding down the key) (USER DEFINED keys).
- You can also use the DIM LEVEL FOR BUSES function to attenuate the monitor level of the non-talkback signals while talkback is on (TALKBACK SETTINGS popup window).

MONITOR screen (talkback)

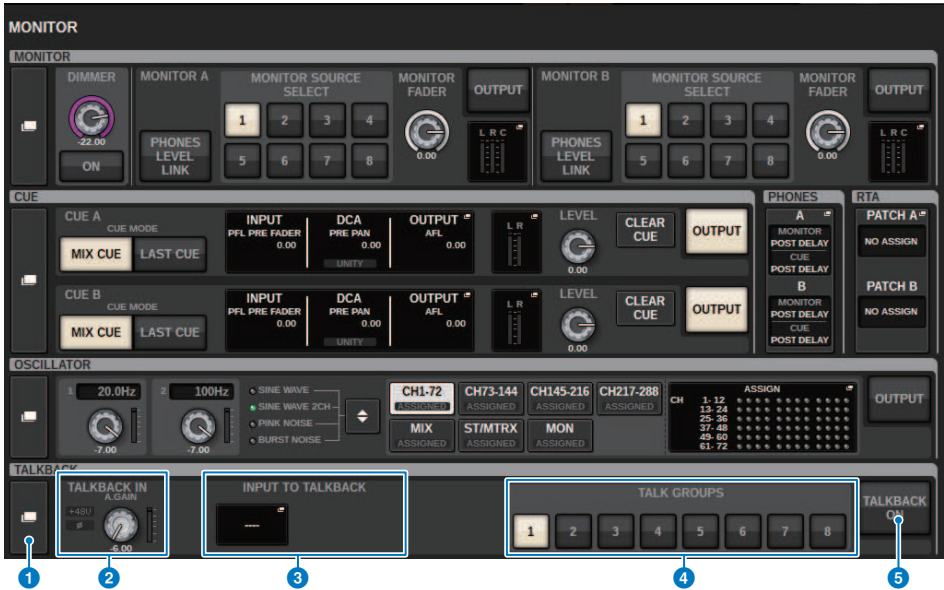

This screen contains the following items.

1 TALKBACK popup button

Enables you to access the TALKBACK popup window, in which you can make detailed talkback settings.

2 TALKBACK IN field

- **TALKBACK IN +48 indicator**

Indicates the +48V on/off status for the TALKBACK jack.

- **TALKBACK IN ∅ indicator**

Indicates the normal-phase/reverse-phase status for the TALKBACK jack.

- **ANALOG GAIN knob**

Sets the analog gain of the TALKBACK jack. Use the screen encoder to adjust the value.

- **TALKBACK IN level meter**

Indicates the level of signals after the input gain at the TALKBACK jack.

3 INPUT TO TALKBACK field

• **INPUT TO TALKBACK patch button**

Press the button to open the INPUT PORT SELECT popup window, in which you can patch a desired input port/slot to talkback. The selected port/slot name will appear on the button. If no patch is assigned, button will indicate “----”.

• **INPUT TO TALKBACK +48 indicator**

Indicates the +48V on/off status for the corresponding input port/slot.

• **INPUT TO TALKBACK Ø indicator**

Indicates the normal-phase/reverse-phase status for the corresponding input port/slot.

• **ANALOG GAIN knob**

Indicates the analog gain setting for the corresponding input port/slot. Use the screen encoder to adjust the value.

• **INPUT TO TALKBACK level meter**

Indicates the level of signals after the input gain at the corresponding input port/slot.

4 TALK GROUPS DEFINE buttons

Enable you to select one of the DEFINE monitor sources assigned via the “TALK GROUPS popup window” (p.448).

5 TALKBACK ON button

Switches talkback out on or off. This button is effective for the talkback signals selected in the TALKBACK IN field and the INPUT TO TALKBACK field.

TALKBACK SETTINGS popup window

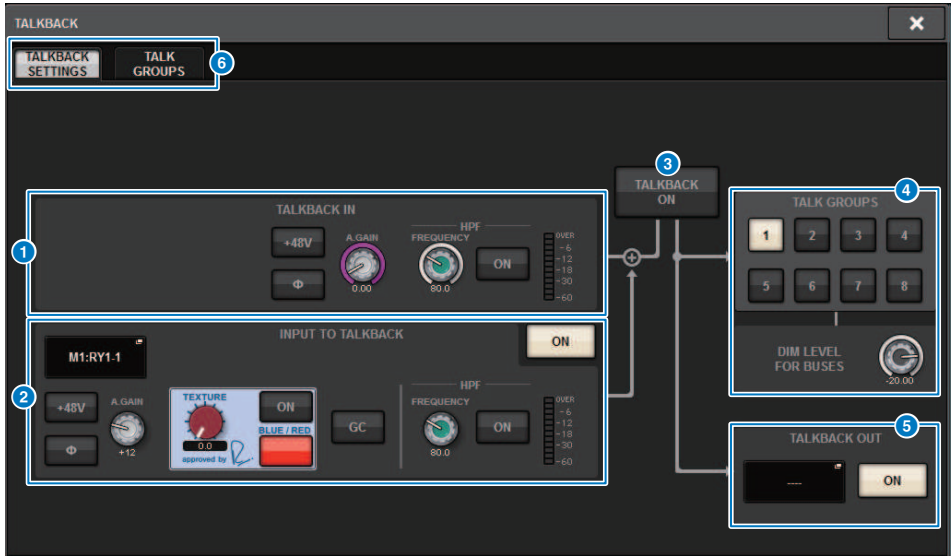

This screen contains the following items.

1 TALKBACK IN field

- **TALKBACK IN +48V button**
Switches on or off the phantom power (+48V) supplied to the TALKBACK jack.
- **TALKBACK IN Ø button**
Switches between normal and reverse phase settings for the corresponding head amp.
- **ANALOG GAIN knob**
Sets the analog gain of the TALKBACK jack. Use the screen encoder to adjust the value.
- **TALKBACK IN HPF knob**
Sets the cutoff frequency of the HPF for the TALKBACK jack. Use the button to the right of the knob to switch the HPF on or off.
- **TALKBACK IN level meter**
Indicates the input level of the mic connected to the TALKBACK jack.

2 INPUT TO TALKBACK field

This field allows a mic connected to a conventional input port to be used as a talkback input. If you want to use an input jack other than the TALKBACK jack as supplementary input for talkback, select an input port here, and set the input level and other parameters.

- **INPUT TO TALKBACK patch button**

Press the button to open the INPUT PATCH popup window, in which you can patch a desired input port to talkback. The selected port name will appear on the button.

- **INPUT TO TALKBACK +48V button**

This is an on/off switch for the phantom power (+48V) supplied to an input port.

- **INPUT TO TALKBACK Ø button**

Sets the phase for the corresponding jack to normal or reverse when you use an input port as a talkback input.

- **INPUT TO TALKBACK gain knob**

Sets the input gain of the corresponding HA when you use any input port as a talkback input.

- **INPUT TO TALKBACK SILK**

Adjusts the corresponding SILK setting when you use any input port as a talkback input.

- **INPUT TO TALKBACK GC**

Turns the corresponding gain compensation on or off when you use any input port as a talkback input.

- **INPUT TO TALKBACK HPF knob**

Sets the cutoff frequency for the HPF when you use any input port as a talkback input. Use the button to the right of the knob to switch the HPF on or off.

- **INPUT TO TALKBACK meter**

Indicates the level of signals input from the corresponding HA when you use any input port as a talkback input.

- **INPUT TO TALKBACK ON button**

Switches talkback on or off when you use any input port as a talkback input.

NOTE

These parameters and meters will not appear if no input port is selected.

3 TALKBACK ON button

Switches talkback on or off.

4 TALK GROUPS field

This field enables you to set the output destination of the talkback signal.

- **ASSIGN select button**

Specifies the output destination of the talkback signal that is assigned by DEFINE.

- **DIM LEVEL FOR BUSES knob**

Adjusts the amount by which the talkback signal (that is being output to the selected bus) will be attenuated.

NOTE

The setting in this field is linked with the setting in the TALKBACK field on the MONITOR screen. (“MONITOR screen (talkback)” (p.443))

5 **TALKBACK OUT field**

In this field, you can patch the TWINLANe network and assign talkback out signals directly to the output jack of an I/O rack, any OMNI OUT jack, or an output jack on a card slot.

NOTE

- **TALKBACK OUT patch button**

Press the button to open the OUT PATCH popup window, in which you can patch any desired output port to talkback.

- **TALKBACK OUT ON button**

This button switches talkback output on or off when you use any output port as a talkback out.

Use the TWINLANe CONFIGURATION popup window to assign the talkback direct out to the TWINLANe network.
("TWINLANe CONFIGURATION popup window" (p.259))

6 **Tabs**

Use these tabs to switch between the TALKBACK SETTINGS popup window and TALK GROUPS popup window.

TALK GROUPS popup window

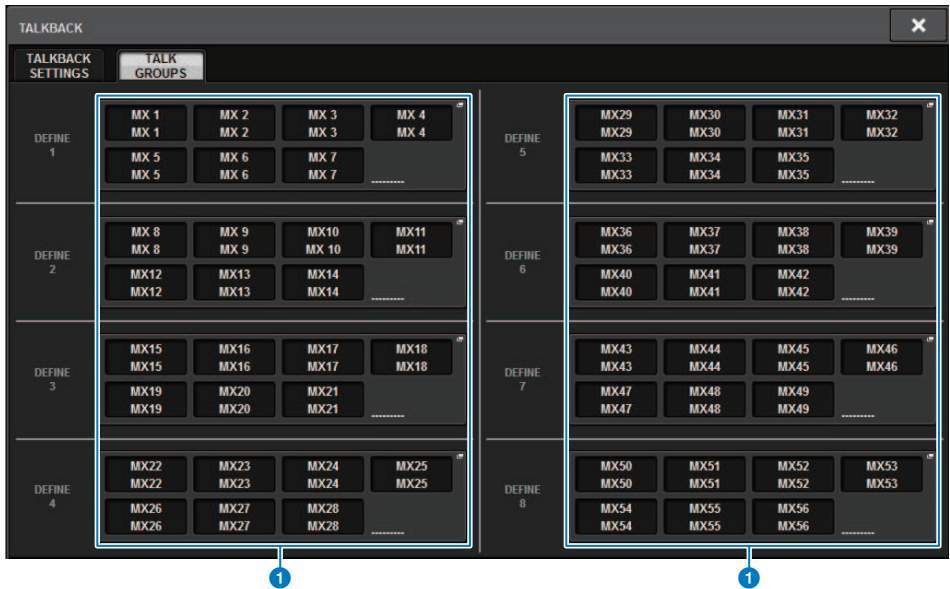

This screen contains the following items.

1 DEFINE 1-8 buttons

Press these buttons to access the bus selection popup window, in which you can select the signal destination.

TALKBACK ASSIGN popup window

The screenshot shows the TALKBACK ASSIGN popup window. At the top, there is a title bar with the text "TALKBACK ASSIGN" and a close button (X) on the right. Below the title bar, there are two buttons: "SET BY SEL" (labeled 2) and "CLEAR ALL" (labeled 3). The main area is divided into three sections: "MIX", "STEREO", and "MATRIX".

The "MIX" section contains a 12x12 grid of buttons labeled MX 1 to MX 72. The buttons are arranged in 12 rows and 12 columns. The buttons in the first row are MX 1 to MX 12. The buttons in the second row are MX 13 to MX 24. The buttons in the third row are MX 25 to MX 36. The buttons in the fourth row are MX 37 to MX 48. The buttons in the fifth row are MX 49 to MX 60. The buttons in the sixth row are MX 61 to MX 72. The button MX 6 is highlighted in orange.

The "STEREO" section contains a 2x2 grid of buttons labeled STA L, STA R, STB L, and STB R. The buttons are arranged in 2 rows and 2 columns. The buttons in the first row are STA L and STA R. The buttons in the second row are STB L and STB R. The button STA L is highlighted in orange.

The "MATRIX" section contains a 12x12 grid of buttons labeled MT 1 to MT 36. The buttons are arranged in 12 rows and 12 columns. The buttons in the first row are MT 1 to MT 12. The buttons in the second row are MT 13 to MT 24. The buttons in the third row are MT 25 to MT 36. The button MT 5 is highlighted in orange.

Four numbered callouts (1, 2, 3, 4) point to the close button (X), the "SET BY SEL" button, the "CLEAR ALL" button, and the close button (X) respectively.

This screen contains the following items.

1 Bus selection buttons

Select the bus as the signal destination from the following options:

- **MX(MIX) 1–72**..Output signals of MIX bus 1–72 output signal
- **MT(MATRIX)1–36**..Output signals of MATRIX bus 1–36
- **STA L–ST B R**..Output signals of STEREO A L–STEREO B R

2 SET BY SEL button

If this button is on, you'll be able to add a bus by using the corresponding [SEL] key.

3 CLEAR ALL button

Press this button to clear all selections.

4 CLOSE button

Press this button to close the popup window and return to the previous screen.

About PHONES

This section explains how to set parameters related to monitoring using headphones. The following diagram shows the PHONES signal flow.

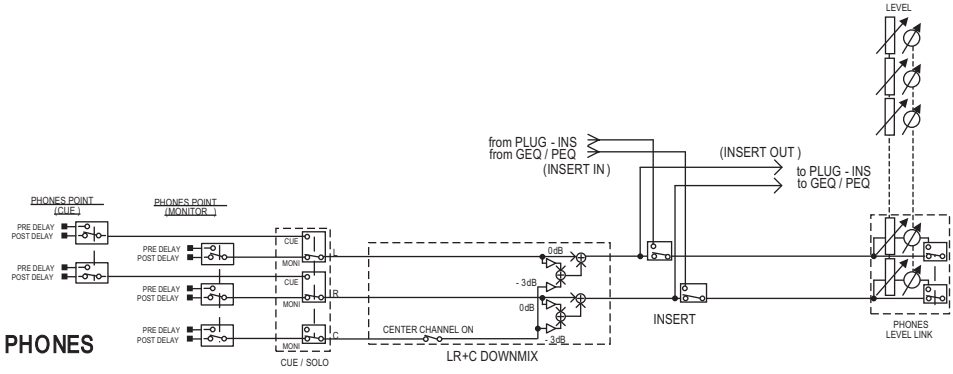

PHONES

- **PHONES POINT (headphone send point)**
Monitor signals are typically output from this point. However, if Cue is on, the cue signal will be output.
- **CENTER CHANNEL**
If you plan not to monitor the center channel, turn this button off.
- **INSERT (plug-in insert)**
You can insert plug-ins into the PHONE signal.
- **PHONES LEVEL (headphone volume level)**
Adjusts the output level at the PHONES output jack.
- **PHONES LEVEL LINK (Headphone Level Link function)**
You can adjust the level of the signal sent to the PHONE output jack using the MONITOR LEVEL knob.

Using PHONES

1 Press the MONITOR button on the menu bar.

The “MONITOR screen (PHONES)” (p.452) appears.

2 2. Press the PHONES popup button.

The PHONES popup window appears.

3 Use the buttons on screen to make PHONES settings.

4 When you finish making settings, press the CLOSE button.

MONITOR screen (PHONES)



This screen contains the following items.

1 PHONES popup display buttons

Indicate the PHONES POINT assigned to PHONES A and PHONES B respectively. Press these buttons to access the PHONES popup window, in which you can make detailed PHONES settings.

PHONES popup window

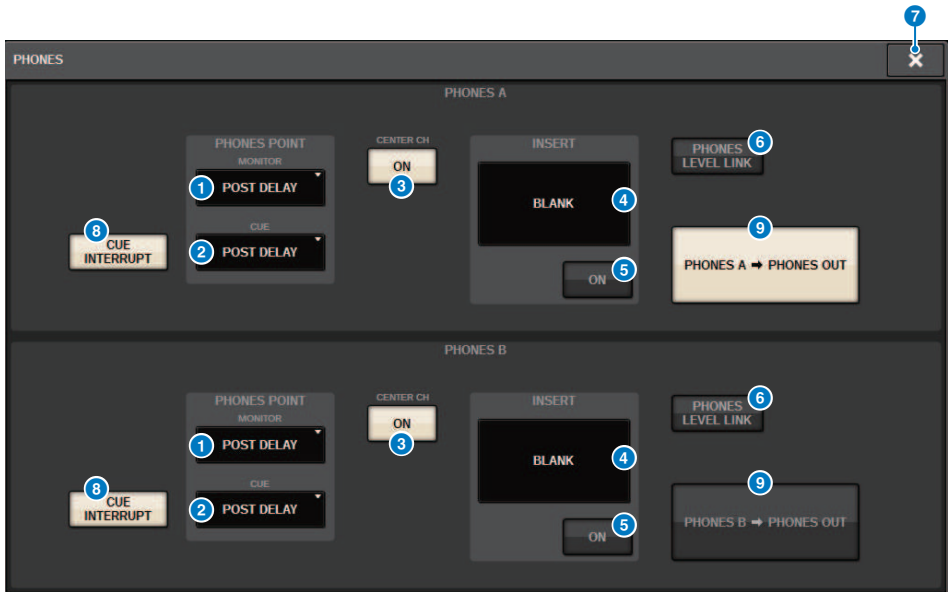

This screen contains the following items.

1 MONITOR PHONES POINT button

Select one of the following monitor source points:

- PRE DELAY
- POST DELAY

2 CUE PHONES POINT button

Select one of the following cue source points:

- PRE DELAY
- POST DELAY

3 CENTER CH ON button

If you plan not to monitor the center channel, turn this button off. When this button is off, the center channel will not be monitored.

4 INSERT button

Indicates the mount status of the currently-selected rack. If nothing is selected, the button will indicate “BLANK.” Press this button to display the window, in which you can set the insert for the PHONES signal.

5 INSERT ON button

Switches the insert on or off.

6 PHONES LEVEL LINK button

If this button is on, the MONITOR FADER LEVEL knob will adjust the level of signals sent to the PHONES A or PHONES B output jack.

7 CLOSE button

Press this button to close the popup window and return to the previous screen.

8 CUE INTERRUPT button

Switches the INTERRUPT on/off.

NOTE

When the monitor source is selected for the CUE, we recommend that you turn CUE INTERRUPT off, to prevent the monitor source from being shut off due to cue operations.

9 PHONES output button (CS-R3 only)

Select whether to output PHONES A or B to the PHONES jack, which has only one CS-R3.

NOTE

You can assign a function to switch the PHONES output (A/B) to a USER DEFINED key.

Using RTA

The RIVAGE PM10 features a real time analyzer (RTA), which provides visual feedback of the frequency spectrum of cued sources for 1/12 octaves (121 bands). The RTA accepts a single-channel signal, and enables you to switch between inputs A and B. If you select A+B MIX, the signal with higher levels will be displayed.

There are four ways to access the RTA.

- “Using a popup window dedicated to the RTA” (p.456)
- “Using the HPF/EQ popup window for the channel parameters” (p.460)
- “Using the GEQ popup window for the inserted GEQ” (p.461)
- “Using the PEQ popup window for the inserted PEQ” (p.462)

Using a popup window dedicated to the RTA

1 Press the MONITOR button on the menu bar.

The “MONITOR screen (RTA)” (p.457) appears.

2 Press the RTA popup button.

The “RTA popup window” (p.458) appears.

About the RTA display

Only one RTA module is installed for the following three popup windows. Therefore, the RTA response graph will be displayed in only one of these windows. If you try to open two or more windows, the latest popup window will display the response graph. If you want to view the response graph while two or more windows are open, the popup window in which you clicked the EQ graph will display the response graph.

- HPF/EQ popup window (1ch)
- GEQ popup window
- PEQ popup window

MONITOR screen (RTA)



This screen contains the following items.

1 RTA popup display buttons

Indicate the name of ports assigned to RTA A and RTA B. If CUE OVERRIDE is on, these buttons will indicate the name of cues set by CUE OVERRIDE. Press these buttons to access the RTA popup window, in which you can make detailed RTA settings.

RTA popup window

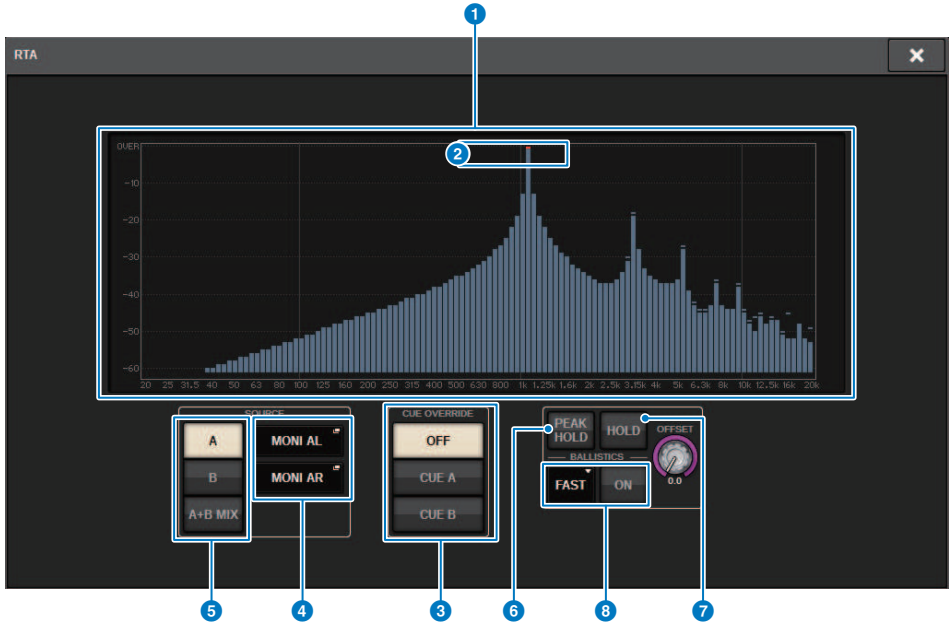

This screen contains the following items.

1 Frequency response graph

The frequency response graph indicates the result of frequency analysis by 1/12 octave bands.

2 OVER indicators

If data exceeds 0 dB, OVER indicators will appear.

3 CUE OVERRIDE button

The frequency response of the cue signal selected here will be displayed in the graph.

4 INPUT PATCH popup buttons

Press this button to display a popup window, in which you can select a signal that will be input to the RTA.

5 Input switch buttons

You can select A, B, or A+B MIX as the input channel displayed on the RTA graph. If you select A+B MIX, signals A and B will be compared and the signal with higher levels will be displayed.

6 PEAK HOLD

If this button is on, the analyzed frequency response graph will hold the peak level indication.

7 HOLD button

If this button is on, the frequency response graph will indicate and hold the result of the frequency analysis.

Monitor > RTA popup window

8 BALLISTICS field

- BALLISTICS button
If this button is on, you will be able to add rate of decay to the analyzed frequency response graph.
- FAST/SLOW switch button
Switches the decay rate of graph rendering (FAST/SLOW).

9 OFFSET knob

Sets the offset for the RTA display.

Using the HPF/EQ popup window for the channel parameters

Press the EQ graph field on the SELECTED CHANNEL VIEW screen, or press the EQ field on the OVERVIEW screen to open the HPF/EQ popup window.

HPF/EQ popup window (1ch)



1 RTA button

If this button is on, a semi-opaque frequency analysis graph of the input signal (immediately after EQ) will be superimposed on top of the EQ frequency response graph.

2 PEAK HOLD

If this button is on, the analyzed frequency response graph will hold the peak level indication.

3 HOLD button

If this button is on, the frequency response graph will indicate and hold the result of the frequency analysis.

4 BALLISTICS field

- BALLISTICS button
If this button is on, you will be able to add rate of decay to the analyzed frequency response graph.
- FAST/SLOW switch button
Switches the decay rate of graph rendering (FAST/SLOW).

Using the GEQ popup window for the inserted GEQ

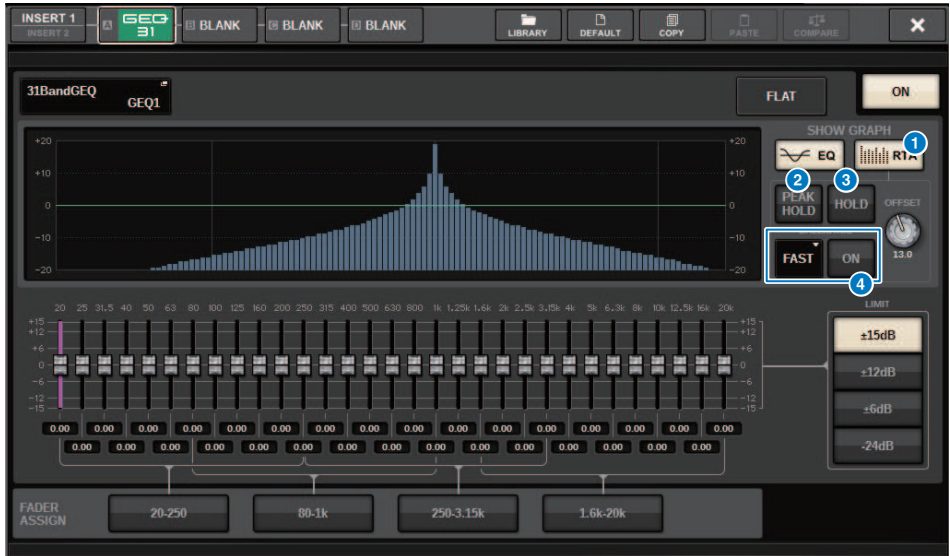

Press the rack container of the rack (which contains an inserted GEQ) to open the GEQ popup window.

GEQ popup window

1 RTA button

If this button is on, a semi-opaque frequency analysis graph of the input signal (immediately after EQ) will be superimposed on top of the EQ frequency response graph.

2 PEAK HOLD

If this button is on, the analyzed frequency response graph will hold the peak level indication.

3 HOLD button

If this button is on, the frequency response graph will indicate and hold the result of the frequency analysis.

4 BALLISTICS field

- BALLISTICS button
 - If this button is on, you will be able to add rate of decay to the analyzed frequency response graph.
- FAST/SLOW switch button
 - Switches the decay rate of graph rendering (FAST/SLOW).

Using the PEQ popup window for the inserted PEQ

Press the rack container of the rack (which contains an inserted PEQ) to open the PEQ popup window.

PEQ popup window



1 RTA button

If this button is on, a semi-opaque frequency analysis graph of the input signal (immediately after EQ) will be superimposed on top of the EQ frequency response graph.

2 PEAK HOLD

If this button is on, the analyzed frequency response graph will hold the peak level indication.

3 HOLD button

If this button is on, the frequency response graph will indicate and hold the result of the frequency analysis.

4 BALLISTICS field

- BALLISTICS button
If this button is on, you will be able to add rate of decay to the analyzed frequency response graph.
- FAST/SLOW switch button
Switches the decay rate of graph rendering (FAST/SLOW).

Meters

Meter area

The meter area displays various meters. Press any part of the meter area to recall the corresponding fader layer to the panel.

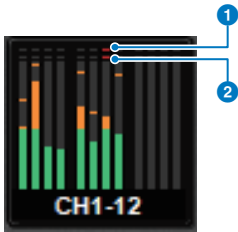

1 Σ clipping indicator

This indicator lights when a signal is clipping at some point in the channel.

2 OVER indicator

Lights to indicate that a signal is clipping at the meter point in the channel.

NOTE

Use the METERING POINT field to toggle the meter point.

Press the button shown with an icon on the right edge of the menu bar in the meter area to switch between popup windows in the display.

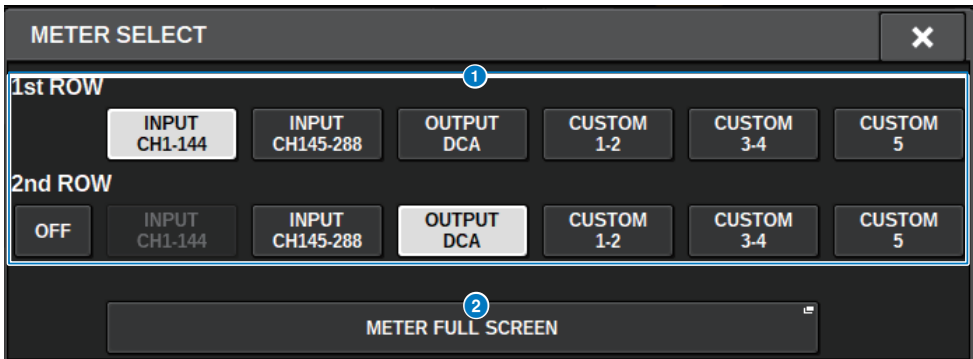

1 Meter area display selection buttons

Select one of the meters shown on rows 1 and 2 of the meter area.



Press OFF to display as a single row.

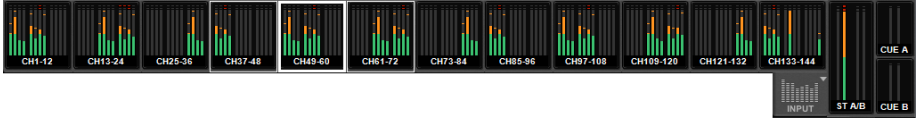

The number of channels for INPUT changes depending on the system

2 METER FULL SCREEN button

Displays the METER screen (FULL SCREEN).

NOTE

- Press the CUE METER section when the cue is on, to clear the cue.
- When using Surround mode, SURROUND A/B will display in the MIX1-12 position, and SURROUND CUE will display in the CUE B position.

Operating the METER screen

You can call up the METER screen (FULL SCREEN) to display the input/output levels for all channels onscreen, or to switch between meter points (the locations where level is detected) on the level meters.

Tabs

Use these tabs to switch between the INPUT METER, OUTPUT METER and DCA METER screens.



METER FULL SCREEN (INPUT) screen

This screen shows the input channel meters, faders and ON buttons.



METER FULL SCREEN (OUTPUT) screen

This screen shows the meters for all output channels, STEREO A/B, CUE A/B and MONITOR A/B.

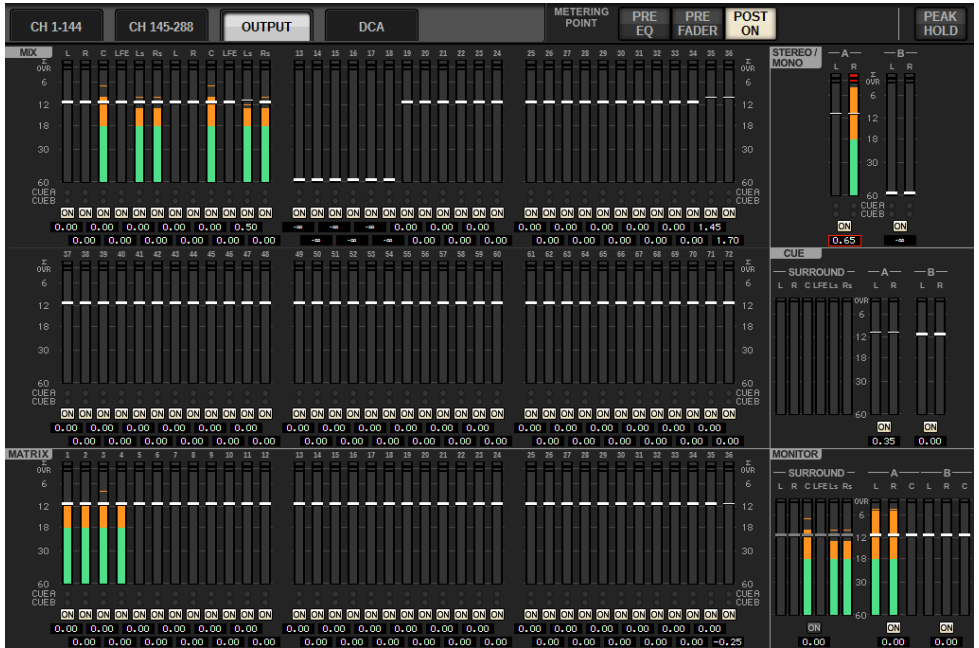

NOTE

When using Surround mode, SURROUND A/B will display instead of MIX1-12, SURROUND CUE will display to the left of CUE, and SURROUND MONITOR will display to the left of MONITOR.

METER FULL SCREEN (DCA) screen

This screen shows the meters for DCA, STEREO A/B, CUE A/B and MONITOR A/B.



NOTE

When using Surround mode, SURROUND CUE will display to the left of CUE, and SURROUND MONITOR will display to the left of MONITOR.

Fader level/meter display

This screen shows the meters and faders for each channel.

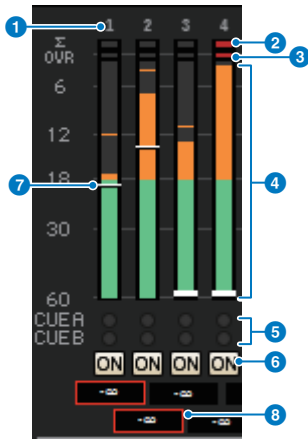

- 1 Channel number**
Indicates the channel number.
- 2 Σ clipping indicator**
This indicator lights when a signal is clipping at some point in the channel.
- 3 OVER indicator**
Lights to indicate that a signal is clipping at the meter point in the channel.
- 4 Meter**
Indicates the input or output level of the channel. Click this with your mouse to switch fader banks.
- 5 CUE A/B indicators**
Shows the CUE status.
- 6 ON indicators**
Indicates the channel on/off status. Click the indicators with your mouse to toggle them on/off.
- 7 Fader**
Indicates the channel level as a fader position. When the channel's [ON] key is turned OFF, the fader will turn gray. Drag with the mouse to adjust the level. Use CTRL+click to return to the default value, or CTRL+SHIFT+click to set the nominal value.
- 8 Fader level/Channel name**
Indicates the channel level as a value (in dB). Click this with your mouse to toggle between fader level display and channel name display.
The ISOLATE status is indicated by a red box.

NOTE

Touch (or click) the 12-channel fader bank to recall the corresponding fader level on the panel.

METERING POINT field

Select one of the following meter points used for level detection. The meter points for level meters can be set separately for input and output channels.

■ For the INPUT METER

- PRE GC
- PRE D.GAIN
- PRE HPF
- PRE FADER
- POST ON

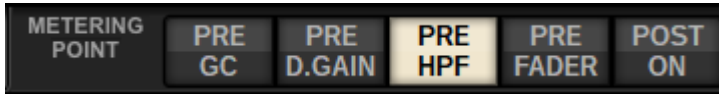

PRE GC is enabled when the device patched into the input features a GC. If the channel does not feature GC, the meter will indicate the PRE D.GAIN value at the PRE GC metering point.

■ For the OUTPUT METER

- PRE EQ
- PRE FADER
- POST ON



PEAK HOLD button

When this button is on, the peak level for each meter will be maintained. When the button is turned off, the peak levels will be cleared. Turning the PEAK HOLD button on/off will affect both the input and output channel. Turn the button off to clear the peak level indicator that was previously maintained.

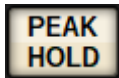

NOTE

You can assign the function for toggling the PEAK HOLD button on/off to the USER DEFINED key.

CH Parameter

About GAIN/SILK

Here you can make settings for the input channel's HA (head amp), such as phantom power on/off, gain, phase, and SILK.

There are three ways to control GAIN/SILK.

- “Controlling GAIN/SILK via the Selected Channel section(CS-R10, CSR10- S, CSD-R7) ” (p.471)
- “Controlling GAIN/SILK via the OVERVIEW screen” (p.475)
- “GAIN/SILK popup window” (p.476)

Controlling GAIN/SILK via the Selected Channel section(CS-R10, CSR10- S, CSD-R7)

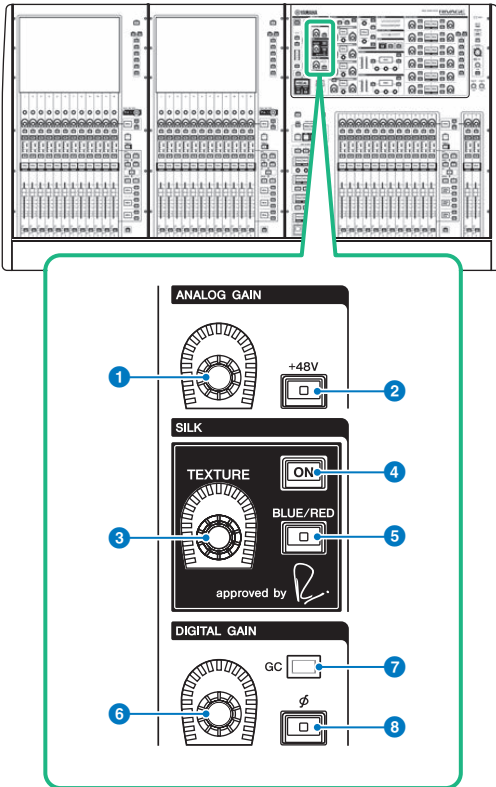

This section contains the following items.

- 1 [ANALOG GAIN] knob**
Sets the analog gain for the head amp.
- 2 [+48V] key**
Switches phantom power (+48V) on or off.
- 3 SILK [TEXTURE] knob**
Adjusts the intensity of SILK processing.
- 4 SILK [ON] key**
Switches the SILK on or off. SILK processing can be applied only to specific channels to bring the corresponding parts to life within the mix, or to all channels to add depth and perspective to the mix overall.

5 SILK [BLUE/RED] key

Toggles between two SILK characteristics (BLUE and RED): “BLUE” for solidity and power, and “RED” for sparkling energy.

6 [DIGITAL GAIN] knob

Sets the digital gain of the channel.

7 GC indicator

Lights up when GC (GAIN COMPENSATION) is enabled.

8 [Φ] Phase key

Reverses the phase of the input signal.

Controlling GAIN via the Selected Channel section (CS-R5, CS-R3)

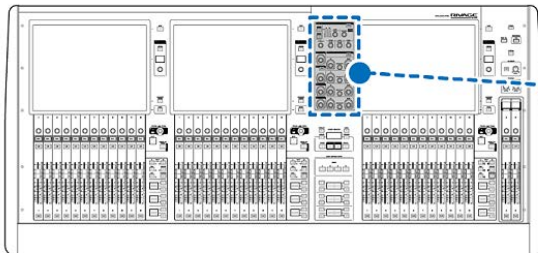

DYNAMICS 1/2 ON

<input type="checkbox"/> 1	<input type="checkbox"/> OVER	<input type="checkbox"/> OR	<input type="checkbox"/> RANGE	<input type="checkbox"/> GATE
<input type="checkbox"/> 2	<input type="checkbox"/> 4	<input type="checkbox"/> 8	<input type="checkbox"/> 16	<input type="checkbox"/> CCMP
<input type="checkbox"/> 30	<input type="checkbox"/> 60	<input type="checkbox"/> 12	<input type="checkbox"/> 30	<input type="checkbox"/> OUTGAIN

THRESHOLD	ATTACK	HOLD	RELEASE	DECAY
<input type="checkbox"/>	<input type="checkbox"/>	<input type="checkbox"/>	<input type="checkbox"/>	<input type="checkbox"/>

GAIN	EQUALIZER <input type="checkbox"/> ON		
<input type="checkbox"/>	Q	FREQUENCY	GAIN
<input type="checkbox"/>	<input type="checkbox"/>	<input type="checkbox"/>	<input type="checkbox"/>
HPF <input type="checkbox"/> ON	Q	FREQUENCY	GAIN
<input type="checkbox"/>	<input type="checkbox"/>	<input type="checkbox"/>	<input type="checkbox"/>
PAN	Q	FREQUENCY	GAIN
<input type="checkbox"/>	<input type="checkbox"/>	<input type="checkbox"/>	<input type="checkbox"/>
Fa	Q	FREQUENCY	GAIN
<input type="checkbox"/>	<input type="checkbox"/>	<input type="checkbox"/>	<input type="checkbox"/>

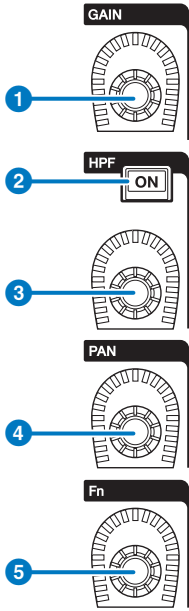

- 1 **[GAIN] knob**
Controls the analog gain or digital gain.
- 2 **HPF [ON] key**
Switches the HPF on or off.
- 3 **[HPF] knob**
Adjusts the HPF cutoff frequency.
- 4 **[PAN] knob**
Adjusts the panning of the signal sent to the stereo buses.
- 5 **[Fn] (Function) knob**
While pressing and holding down this knob, touch a parameter to assign the function.

Controlling GAIN/SILK via the OVERVIEW screen

NOTE

- The PAD will be switched on or off internally when the HA gain is adjusted between +11 dB and +12 dB.
- Keep in mind that noise may be generated when using phantom power if there is a difference between the Hot and Cold output impedance of an external device connected to the input jack.
- The ANALOG GAIN knob and +48V button are enabled for the input jacks of an I/O rack and the OMNI IN jacks of the control surface.
- HA settings can also be made in the SYSTEM CONFIG parameter settings screen (“Editing the internal parameters of each component” (p.262)).

- 1 Press the [VIEW] key to access the OVERVIEW screen.**
- 2 Select the channel that you want to operate.**
- 3 Press the ANALOG GAIN knob or the SILK field.**

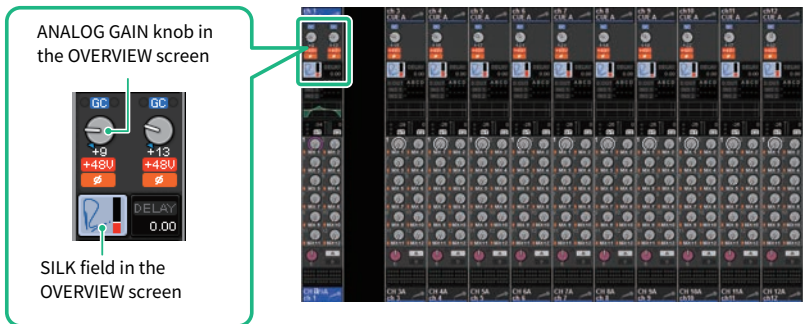

The “GAIN/SILK popup window” (p.476) appears.

- 4 Use the on-screen buttons and screen encoders to make HA settings.**
- 5 Edit the SILK settings as needed.**
- 6 Perform the same operations for other input channels as desired.**

If you are viewing the GAIN/SILK popup window, you can also use the [SEL] keys to switch the channel for editing.

- 7 When you finish making settings, press the X symbol in the upper right of the window.**

GAIN/SILK popup window



This screen contains the following items.

- 1 Channel select button**
 Indicates the channel. Press this button to select the on-screen selected channel. The current channel icon, number, and color appear on the button, and the channel name appears below the button.
- 2 PATCH display**
 Displays the channel's patch status.
- 3 +48V button**
 Switches the HA phantom power (+48V) on or off.
- 4 A.GAIN knob**
 Indicates the HA analog gain setting. Use the screen encoder to adjust the value. If gain compensation is on, an indicator shows the analog gain position at the time that gain compensation was turned on.
- 5 HA meter**
 Displays the level (PRE GC) of the HA input signal.
- 6 SILK ON button**
 Switches the SILK on or off.
- 7 BLUE/RED selection button**
 Toggles between two SILK characteristics (BLUE and RED): "BLUE" for solidity and power, and "RED" for sparkling energy.

CH Parameter > GAIN/SILK popup window

- 8 SILK [TEXTURE] knob**
Adjusts the TEXTURE parameter of SILK.
- 9 GC (GAIN COMPENSATION) button**
Switches the gain compensation on or off for that channel.
- 10 HPF indicator**
Indicates the high pass filter on/off status for each port.
- 11 D.GAIN knob**
Indicates the digital gain setting. Use the screen encoder to adjust the value.
- 12 Meter (channel input)**
This meter indicates the level after passing through GC (before D.GAIN).
- 13 Meter (post digital gain)**
This meter indicates the level after passing through digital gain.
- 14  Phase button**
Switches the phase of the input signal.
- 15 GANG button**
This is shown only in the case of stereo. If this is on, the difference in the LR analog gain is maintained as the value changes. The same applies to digital gain.

Controlling GAIN/SILK via the SELECTED CHANNEL VIEW screen

- 1 Press the [VIEW] key to access the SELECTED CHANNEL VIEW screen.**
- 2 Select the channel that you want to operate.**
- 3 Press the ANALOG GAIN knob, the SILK [TEXTURE] knob, or the DIGITAL GAIN knob to open the “GAIN/SILK popup window” (p.476).**



ANALOG GAIN knob in the SELECTED CHANNEL VIEW screen

SILK [TEXTURE] knob in the SELECTED CHANNEL VIEW screen

DIGITAL GAIN knob in the SELECTED CHANNEL VIEW screen

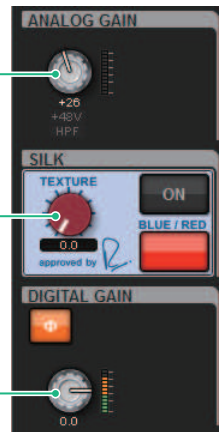

Signal level that flows on the TWINLANe network when gain compensation is on

If gain compensation is turned on, changing the analog gain will cause the signal being output to the TWINLANe network to be compensated by an equal and opposite amount as the change in the analog gain. This means that the signal on the audio network will be compensated to a consistent level in the digital domain. For example, if the analog gain value is set to +30 dB and you turn gain compensation on, raising the analog gain to +45 dB will apply -15 dB of compensation to the audio network so that the signal is sent at a +30 dB level.

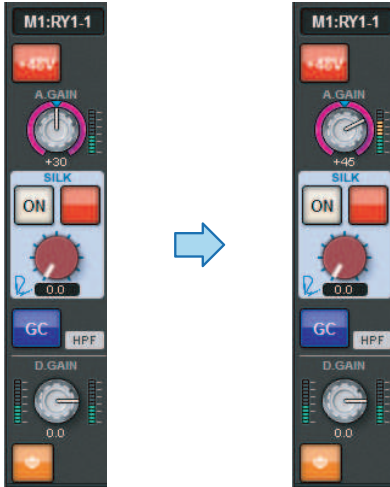

When a single I/O rack unit is shared by the FOH console and the monitor console, even if the analog gain is changed on the FOH console, the signal that flows on the audio network stays at the same level, so that the input level to the monitor console is not affected. It is important to note that if the analog gain is raised excessively so that the signal after GC is distorted, you must temporarily turn gain compensation off, readjust the input level appropriately, and then turn gain compensation on again. If you lower the analog gain while gain compensation is still on, gain compensation operates to boost the signal on the audio network by the same amount, so the signal will still be distorted.

About EQ

The RIVAGE PM10 features a full-parametric channel EQ (4-band for input and 8-band for output). It includes the following features:

- EQ can be used on all input channels and all output channels.
- High/low pass filters are independent of the EQ, and they can be used on either input channels or output channels.
- You can store and switch between two sets (A/B) of parameter settings.
- The FREQUENCY parameter for each band can be set in 1/24 oct steps.
- Two bands can be changed to L SHELL (Low Shelving) and H SHELL (High Shelving).

The available EQ types include:

PRECISE	This EQ strives for ultimate precision and controllability. It enables you to adjust the target point precisely, and flexibly satisfies various requirements for sound making. Low/High Shelving filters feature a “Q” parameter, which enables you to adjust the knee characteristics.
AGGRESSIVE	This EQ is musical and effective. It enables you to add a powerful, creative edge and serves as a powerful tool for artistic expression.
SMOOTH	This EQ focuses on smooth sound qualities. It contributes to a natural sound without changing the atmosphere of the original.
LEGACY	This is a standard EQ that has been equipped with many of Yamaha’s legacy digital mixers, such as PM1D and PM5D.

There are three ways to control EQ.

- Controlling the EQ via the Selected Channel section
- “Controlling the EQ via the OVERVIEW screen” (p.487)
- “Controlling an EQ via the SELECTED CHANNEL VIEW screen” (p.488)

EQUALIZER section(CS-R10, CSR10- S, CSD-R7)

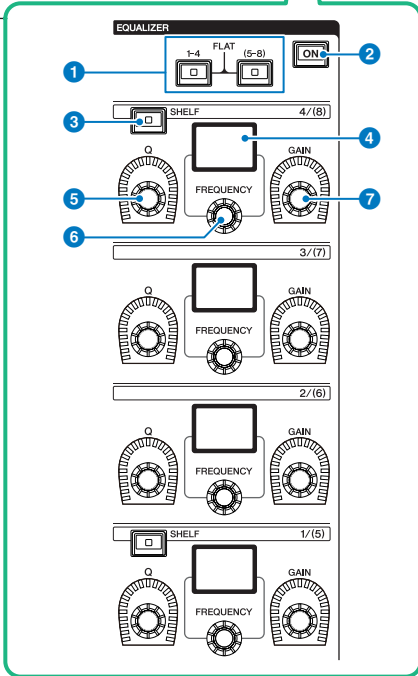
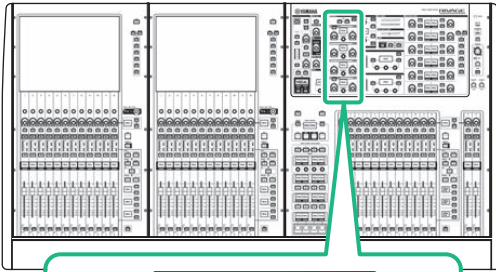

1 EQUALIZER [1-4]/[(5-8)] keys

Switch the EQ bands for which you want to make settings. Pressing both [1-4] and [5-8] keys simultaneously will set the gain for all bands to 0 (FLAT).

2 EQUALIZER [ON] key

Switches EQ on or off.

3 EQUALIZER [SHELF] key

Switches peaking filter to shelving filter.

4 Display

Indicates the selected EQUALIZER parameter.

5 EQUALIZER [Q] knob

Specifies the Q value.

6 EQUALIZER [FREQUENCY] knob

Sets the frequency.

7 EQUALIZER [GAIN] knob

Sets the gain.

Controlling the EQ via the Selected Channel section (CS-R10, CSR10- S, CSD-R7)

1 Select the channel that you want to operate.

Four-band EQ (HIGH, HIGH MID, LOW MID, LOW) is provided on all input channels. Eight-band EQ is provided on all output channels. (Control is divided into [1-4] and [5-8] groups of four bands each.)

2 If you selected an output channel in step 1, use the [1-4]/[(5-8)] keys in the Selected Channel section to select the [1-4]/[(5-8)] group of four bands.

3 Use the [Q] knob (EQUALIZER section 5), [FREQUENCY] knob (EQUALIZER section 6), and [GAIN] knob (EQUALIZER section 7) for each band in the Selected Channel section to set the Q, center frequency, and gain for each band.

NOTE

- Pressing the [FREQUENCY] knob and the [GAIN] knob simultaneously enables you to bypass the corresponding band.
- Pressing the [Q] knob and the [GAIN] knob simultaneously enables you to reset the boost/cut amount of the corresponding band to 0 dB.
- If you want to use the LOW band as a shelving-type EQ, press the band 1 [Q] knob and band 1 [FREQUENCY] knob simultaneously. If you want to use the HIGH band as a shelving-type EQ for input channels, press the band 4 [Q] knob and band 4 [FREQUENCY] knob simultaneously. For output channels, press the band 8 [Q] knob and band 8 [FREQUENCY] knob simultaneously.

4 If you want to restore the EQ of the currently-operated channel to a flat state, simultaneously press the [1-4] and [(5-8)] keys in the Selected Channel section.

When you press these two keys simultaneously, the boost/cut amount of all bands will be reset to 0 dB.

5 If you want to use the HIGH band or LOW band as a shelving-type EQ, turn on the [SHELF] key for the corresponding band.

EQUALIZER(CS-R5, CS-R3)

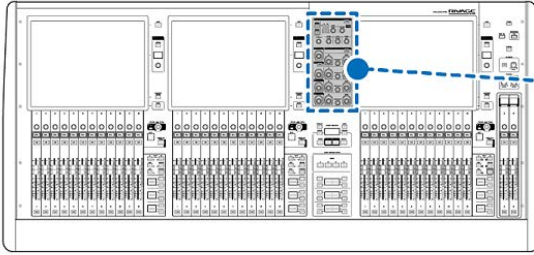

DYNAMICS 1/2 ON

1 **OVER** IN **OR** **RANGE** **GATE**
4 12 18 24 30 36 42 48 54 60 66 72 78 84 90 96 100

2 **RATIO** **OUTGAIN** **CCOMP**

THRESHOLD **ATTACK** **HOLD** **DECAY**
RELEASE **KNEE**

GAIN **EQUALIZER** ON

HPF ON

PAN

Fa

Q GAIN
FREQUENCY

Q GAIN
FREQUENCY

Q GAIN
FREQUENCY

Q GAIN
FREQUENCY

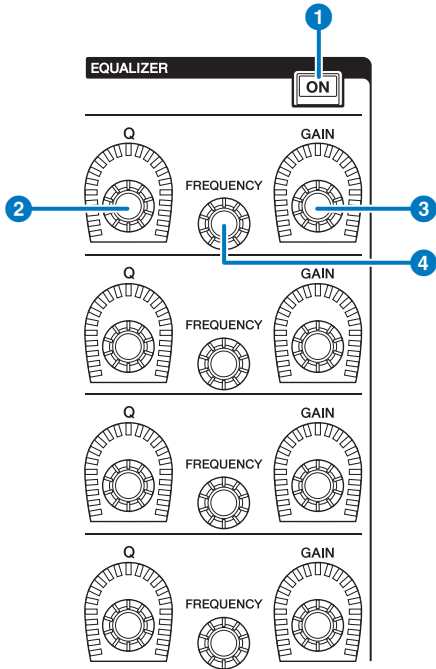

- 1 EQUALIZER [ON] key**
Switches EQ on or off.
- 2 EQUALIZER [Q] knob**
Specify the Q value.
- 3 EQUALIZER [GAIN] knobs**
Adjust the gain.
- 4 EQUALIZER [FREQUENCY] knobs**
Adjust the frequency.

Controlling the EQ via the Selected Channel section (CS-R5, CS-R3)

1 Select the channel that you want to operate.

Four-band EQ (HIGH, HIGH MID, LOW MID, LOW) is provided on all input channels. Eight-band EQ is provided on all output channels. (Control is divided into [1-4] and [5-8] groups of four bands each.)

2 Use the [Q] knob (EQUALIZER section ②), [FREQUENCY] knob (EQUALIZER section ④), and [GAIN] knob (EQUALIZER section ③) for each band in the Selected Channel section to set the Q, center frequency, and gain for each band.

NOTE

- Pressing the [FREQUENCY] knob and the [GAIN] knob simultaneously enables you to bypass the corresponding band.
- Pressing the [Q] knob and the [GAIN] knob simultaneously enables you to reset the boost/cut amount of the corresponding band to 0 dB.
- If you want to use the LOW band as a shelving-type EQ, press the band 1 [Q] knob and band 1 [FREQUENCY] knob simultaneously. If you want to use the HIGH band as a shelving-type EQ for input channels, press the band 4 [Q] knob and band 4 [FREQUENCY] knob simultaneously. For output channels, press the band 8 [Q] knob and band 8 [FREQUENCY] knob simultaneously.

Controlling the EQ via the OVERVIEW screen

1 Press the [VIEW] key to access the OVERVIEW screen.

The EQ field shows the response of the EQ.



EQ field

OVERVIEW screen

2 Select the channel that you want to operate.

3 Press the EQ field.

The EQ popup window (1ch) is displayed, and you will be able to adjust all of the EQ parameters.

4 Use the corresponding screen encoder or the [TOUCH AND TURN] knob to adjust the EQ parameters.

Controlling an EQ via the SELECTED CHANNEL VIEW screen

- 1 Press the [VIEW] key to access the SELECTED CHANNEL VIEW screen.**

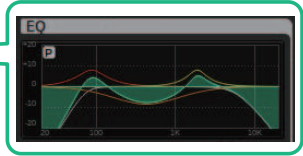

EQ graph field

SELECTED CHANNEL VIEW screen

- 2 Select the channel that you want to operate.**
- 3 Press the EQ field to access the EQ popup window.**
- 4 Use the corresponding screen encoder or the [TOUCH AND TURN] knob to adjust the EQ parameters.**

EQ popup window (CH 1-72, CH 73-144, MIX, MTRX/ST)

This window displays the corresponding input channels (or output channels) simultaneously. This page is only for display, and does not allow the parameters to be edited. It is useful when you need to quickly check multiple EQ settings, or when you want to copy and paste EQ settings between distant channels.



This screen contains the following items.

1 Channel select button

Enable you to select the channel that you want to operate. The current channel icon, channel number, channel name, and color appear on the button.

2 EQ graph

This field graphically indicates the approximate EQ/filter response.

3 Tabs

Use these tabs to select a channel that you want to view on the screen.

EQ popup window (1ch)

This window enables you to edit all EQ parameters of the currently-selected channel. This is convenient if you want to make detailed EQ settings for a specific channel.

Input channels



Output channels

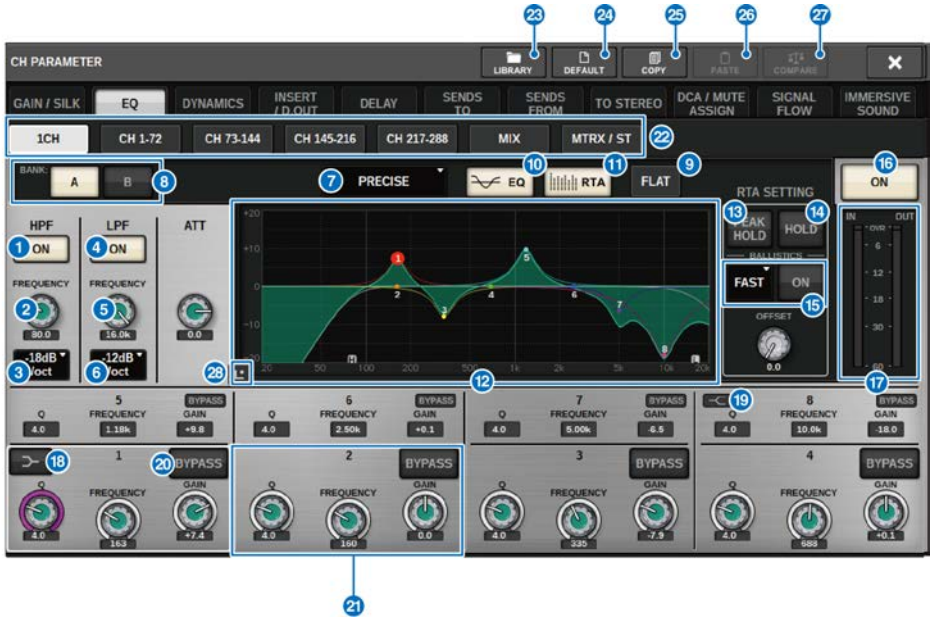

This screen contains the following items.

- 1 **HPF ON/OFF button**
Switches the HPF on or off.
- 2 **HPF FREQUENCY knob**
Indicates the cutoff frequency of the HPF. Use the screen encoder to adjust the value.
- 3 **HPF type select button**
Enables you to set the HPF attenuation per octave to -6 dB/oct, -12 dB/oct, -18 dB/oct, or -24 dB/oct.
- 4 **LPF ON/OFF button**
Switches the LPF on or off.
- 5 **LPF FREQUENCY knob**
Indicates the cutoff frequency of the LPF. Use the screen encoder to adjust the value.
- 6 **LPF type select button**
Enables you to set the LPF attenuation per octave to -6 dB/oct, or -12 dB/oct.
- 7 **EQ type select button**
Switches the EQ type to PRECISE, AGGRESSIVE, SMOOTH, or LEGACY.
- 8 **A/B switch buttons**
Enable you to switch between A and B as the storing destination for the EQ parameters.

CH Parameter > EQ popup window (1ch)

9 **EQ FLAT button**

Press this button to reset the GAIN parameters of all EQ band to 0 dB.

10 **EQ button**

Press this button to display the EQ graph.

11 **RTA button**

If this button is on, a semi-opaque frequency analysis graph of the EQ-processed input signal will be superimposed on top of the EQ frequency response graph.

12 **EQ graph**

Displays the parameter values for the EQ and filters.

13 **PEAK HOLD**

The frequency response graph holds the peak level indication.

14 **HOLD button**

If this button is on, the RTA graph will continue to be displayed.

15 **BALLISTICS field**

- **BALLISTICS button**
Setting this button to ON allows you to add rate of decay to the graph.
- **FAST/SLOW switch button**
Switches the decay rate of graph rendering (FAST/SLOW).

16 **EQ ON/OFF button**

Switches the EQ on or off.

17 **EQ IN/OUT level meters**

Indicate the peak level of signals before and after the EQ. For a stereo channel, these meters indicate the level of both the L and R channels.

18 **LOW SHELIVING ON/OFF button**

Turn on this button to switch the LOW band to a shelving type filter.

19 **HIGH SHELIVING ON/OFF button**

Turn on this button to switch the HIGH band to a shelving type filter.

20 **BYPASS button**

Temporarily bypasses the EQ.

21 **EQ parameter setting knobs**

Indicate the Q, FREQUENCY, and GAIN parameters for the LOW, LOW MID, HIGH MID, and HIGH bands. Press this button, and you will be able to use the screen encoder to adjust the value.

22 **Tabs**

Use these tabs to select a channel that you want to view on the screen.

23 **LIBRARY button**

Press this button to open the EQ library window.

CH Parameter > EQ popup window (1ch)

24 **DEFAULT button**

Press this button to reset all EQ/filter parameters to the initial values.

25 **COPY button**

Copies the EQ parameter settings stored in the bank (selected via the A/B switching buttons) to buffer memory.

26 **PASTE button**

Press this button to paste the settings copied in buffer memory to the EQ of the currently-selected bank. If valid data has not been copied into buffer memory, you will be unable to paste it.

27 **COMPARE button**

Press this button to switch between and compare the settings stored in buffer memory and the currently-selected settings. If valid data has not been stored in buffer memory, you will be unable to compare the data.

28 **Touch EQ button**

Press to enlarge the EQ graph and touch to adjust EQ parameters.

Touch EQ screen

This screen enables you to adjust EQ parameters by using and sliding your fingers on the touch panel.

Touch operations

This section explains the EQ operations you can make by touching the Touch EQ screen.

Use the multi-band operations to adjust parameters for multiple bands at once.

-Boost band: A band set in the boost area (the region above 0 dB) You can change the boost amount for the band using the Multi-band function or multi-touch operations.

-Cut band: A band set in the cut area (the region below 0 dB) You can change the cut amount for the band using the Multi-band function or a multi-touch operations.



Single finger control

1 Peak of the selected band

Use your finger to drag the peak of the band to adjust the band frequency or gain.

Double-tap the solid circle to reset the gain.

If the solid circles for multiple bands are overlapping, the selection will change when you tap.

2 G axis

Drag to lock the frequency value and adjust the gain.

3 F axis

Drag to lock the gain value and adjust the frequency.

4 HPF/LPF

Drag to adjust the frequency. Double-tap to turn on/off.

5 MULTI BAND OPERATION

Turn this on to adjust multiple bands at once.



• **BOOST**

When this option is selected, you can magnify or reduce the boost amount for all bands to be boosted by dragging the boost band to slide it up or down with one finger.

• **CUT**

When this option is selected, you can amplify or attenuate the cut amount for all bands to be cut by dragging the cut band to slide it up or down with one finger.

• **ALL**

When this option is selected, you can magnify or reduce the amount of gain adjustment for all bands by dragging to slide the EQ graph up or down with one finger.

Multi-touch operations (CS-R5 only)

• **PINCH**

Pinch to adjust the Q settings for the selected band.

• **BOOST**

When tapping on a region above 0 dB with three fingers and dragging to slide it up or down, you can magnify or reduce the boost amount for all bands to be boosted.

• **CUT**

When tapping on a region below 0 dB with three fingers and dragging to slide it up or down, you can amplify or attenuate the cut amount for all bands to be cut.

• **EXPAND**

When this is turned on, you can magnify or reduce the amount of gain adjustment for all bands by tapping a region with four fingers and sliding it up and down. Alternatively, you can tap and pinch both sides of the 0 dB line with three fingers to obtain the same effect.

About DYNAMICS

Input Channels feature two dynamics processors: Dynamics 1 and Dynamics 2. Output Channels feature one dynamics processor. They include the following features:

- You can assign a dynamics function from six types, including GATE and COMP.
- You can store two sets (A/B) of parameter settings.
- You can use the parameter copy, paste, and library functions for Dynamics 1 and Dynamics 2 individually.
- The key-in signals can be selected from other input or output channels, or from input patches.

The available dynamics types include:

LEGACY COMP	This is a standard compressor that has been equipped with many of Yamaha's legacy digital mixers, such as PM1D and PM5D.
COMP 260	This is an analog-flavored compressor built using Yamaha's proprietary VCM (Virtual Circuitry Modeling) technology. It emulates the characteristics of compressors and limiters of the mid-1970s, which are now a standard for live sound reinforcement. This compressor has faithfully modeled the VCA (Voltage Controlled Amplifier) circuit and the RMS (Root Mean Square) detection circuit. Compression curve (Knee) can be set to Hard, Medium, or Soft. Attack time and release time are variable. The preset settings recreate the fixed value of the early legacy models. Designed under the supervision of top SR engineers, the parameter effects have been optimized for live sound reinforcement.
GATE	This dynamics type reduces the output by a fixed value (RANGE) when a signal smaller than the THRESHOLD level is input.
DE-ESSER	This dynamics type detects only the sibilants and other high-frequency consonants of the vocal, and compresses its bandwidth.
EXPANDER	This dynamics type reduces the output by a fixed ratio (RATIO) when a signal smaller than the THRESHOLD level is input. DUCKING This dynamics type reduces the output by a fixed value (RANGE) when a signal greater than the THRESHOLD level is input. This is effective if you want to lower the volume level of background music using the KEY IN SOURCE signal.
DUCKING	This dynamics type reduces the output by a fixed value (RANGE) when a signal greater than the THRESHOLD level is input. This is effective if you want to lower the volume level of background music using the KEY IN SOURCE signal.
FET LIMITER *1	Models a FET compressor/limiter used standard in studios. Because THRESHOLD is fixed internally, the amount of compression applied is adjusted by adjusting the INPUT level.
DIODE BRIDGE COMP *1	Models a compressor that uses a Diode Bridge.

*1 Cannot be selected for input channel Dynamics 1.

There are three ways to control the dynamics processors.

- "Controlling a dynamics processor via the Selected Channel section" (p.498)
- "Controlling a dynamics processor via the OVERVIEW screen" (p.499)
- "Controlling a dynamics processor via the SELECTED CHANNEL VIEW screen" (p.501)

DYNAMICS section

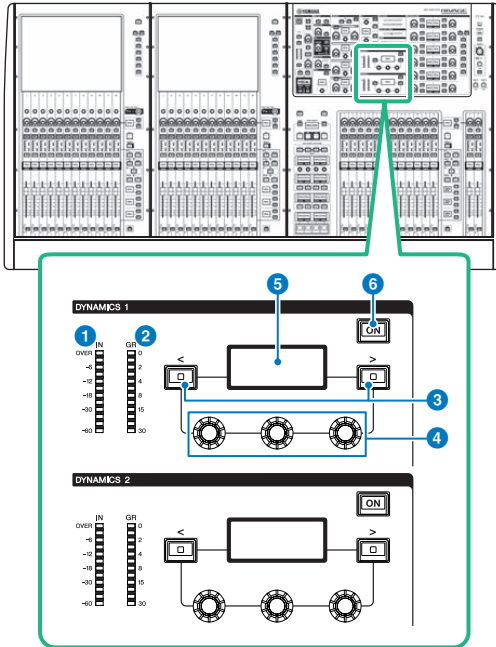

- 1 DYNAMICS 1/2 IN LED**
Indicates the Dynamics input level.
- 2 DYNAMICS 1/2 GR LED**
Indicates the amount of Dynamics gain reduction.
- 3 DYNAMICS 1/2 [<|/>] keys**
Switch parameters that are indicated on the DYNAMICS display.
- 4 DYNAMICS 1/2 setting knobs**
Set parameters that are indicated on the DYNAMICS display.
- 5 DYNAMICS 1/2 display**
Indicates the Dynamics parameters.
- 6 DYNAMICS 1/2 [ON] key**
Switches Dynamics on or off.

Controlling a dynamics processor via the Selected Channel section

- 1 Use a [SEL] key to select the channel you want to control.**
- 2 Turn on the DYNAMICS 1/2 [ON] key in the Selected Channel section.**
- 3 Use the DYNAMICS 1/2 [<]/[>] keys to select the parameter that you want to adjust.**
- 4 Use the DYNAMICS 1/2 setting knobs to adjust the corresponding parameter.**

Controlling a dynamics processor via the OVERVIEW screen

1 Press the [VIEW] key to access the OVERVIEW screen.

The DYNAMICS 1/2 field displays the dynamics processor on/off status and the amount of gain reduction.

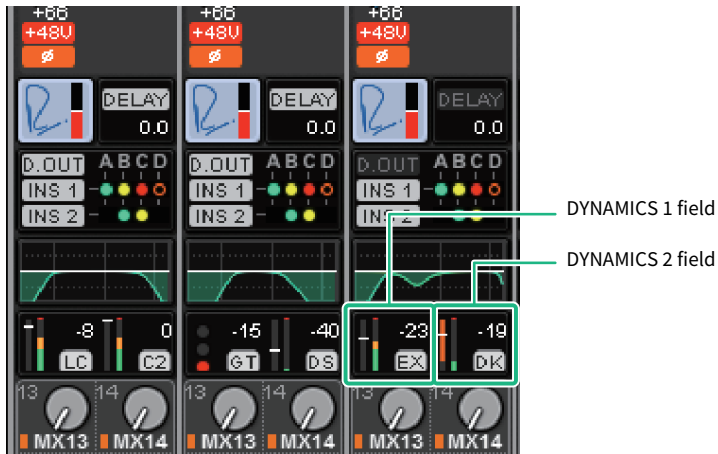

2 Select the channel that you want to operate.

3 Press the DYNAMICS 1/2 field to access the DYNAMICS 1/2 popup window.

In the DYNAMICS 1/2 popup window, you can edit the dynamics settings and turn the processor on or off.

4 Press the DYNAMICS ON button to adjust the dynamics settings.

NOTE

Even when the DYNAMICS 1/2 popup window is displayed, you can use the knobs in the Selected Channel section to control dynamics.

Dynamics fields

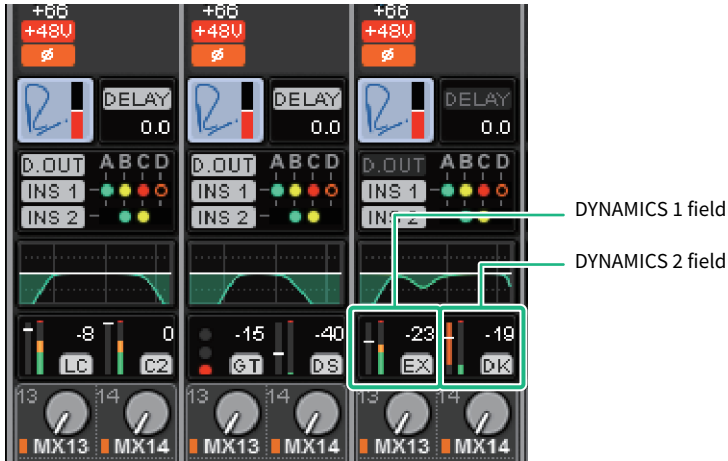

These fields include the following items.



1 Dynamics IN/OUT level meters

This green bar graph shows the level of the signal before it passes through dynamics processing.

2 GR meter

This orange bar graph indicates the amount of gain reduction produced by the dynamics processor.

3 Dynamics processor type

Indicates the abbreviated name of the currently-selected dynamics processor type.

Displays the Dynamics on/off status.

4 Threshold

The horizontal line indicates the currently-specified threshold value and its approximate position in the GR meter.

Controlling a dynamics processor via the SELECTED CHANNEL VIEW screen

- 1 Press the [VIEW] key to access the SELECTED CHANNEL VIEW screen.**



SELECTED CHANNEL VIEW screen

DYNAMICS field

- 2 Select the channel that you want to operate.**
- 3 Press the DYNAMICS field to access the DYNAMICS 1/2 popup window.**
- 4 Use the corresponding screen encoder or the [TOUCH AND TURN] knob to adjust the EQ parameters.**

DYNAMICS 1/2 popup window (1CH)

All dynamics parameters can be viewed and edited. This is convenient when you want to make detailed dynamics settings for a specific channel.

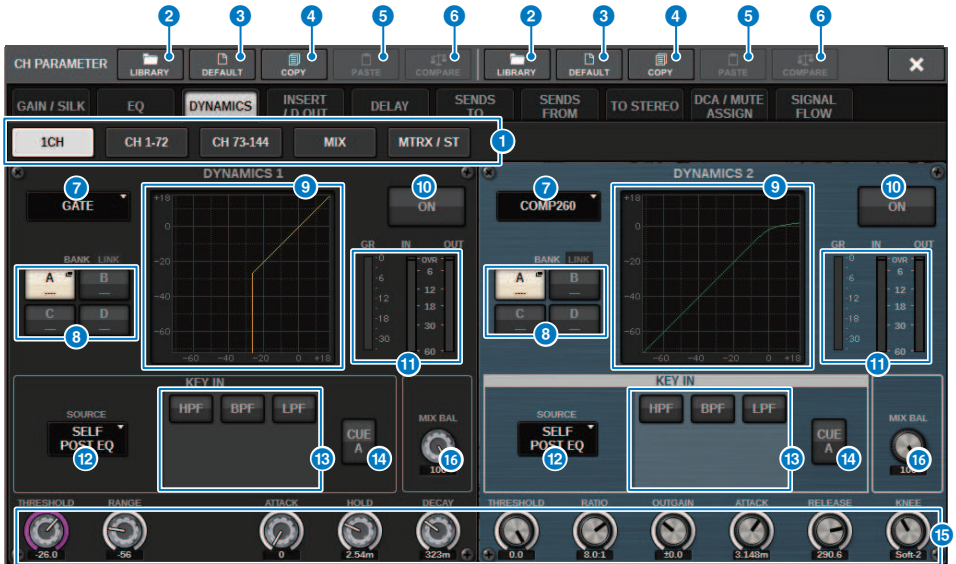

1 Tabs

Use these tabs to select a channel that you want to view on the screen.

2 LIBRARY button

Press this button to open the DYNAMICS library window.

3 DEFAULT button

Press this button to reset all dynamics parameters to the initial values.

4 COPY button

Copies the dynamics parameter settings stored in the bank (selected via the A/B switching buttons) to buffer memory.

5 PASTE button

Press this button to paste the settings that were copied in buffer memory to the dynamics of the currently-selected bank. If valid data has not been copied into buffer memory, you will be unable to paste anything.

NOTE

You can copy and paste the parameters between DYNAMICS1 and Dynamics 2.

6 COMPARE button

Press this button to switch between and compare the settings stored in buffer memory and the currently-selected settings. If valid data has not been stored in buffer memory, you will be unable to compare the data.

7 Dynamics processor type switch button

allows you to select the dynamics processor type from the following: LEGACY COMP, COMP260, GATE, DE-ESSER, EXPANDER, DUCKING, FET LIMITER, DIODE BRIDGE COMP.

8 A/B switch buttons

Enable you to switch between A and B as the store destination for the dynamics parameters.

9 Dynamics graph

Displays the input/output response of the dynamics processors.

10 DYNAMICS ON/OFF button

Switches the dynamics processor on or off.

11 Dynamics IN/OUT level meters, GR meter

These meters indicate the peak level of the signals before and after the dynamics processing, and the amount of gain reduction. For a stereo channel, these meters indicate the level of both the L and R channels.

12 KEY IN SOURCE select button

allows you to select one of the following as the key-in signal that will trigger dynamics processing.

- **SELF PRE EQ**The pre-EQ signal of the same channel
- **SELF POST EQ**The post-EQ signal of the same channel
- **OTHER PRE EQ**The signal immediately after the EQ of other input or output channels. Press this button to display a window where you can select a signal.
- **DIRECT INPUT**Press this button to display the INPUT PATCH window that allows you to select the key-in signal.

13 KEY IN FILTER field (This area will not appear if the dynamics type is DE-ESSER, FET LIMITER or DIODE BRIDGE COMP)

allows you to make various settings for a filter that lets the key-in signal pass.

- **Filter select buttons**

Select the type of filter from HPF, BPF, or LPF. To disable the filter, press the button that is turned on.

- **Q knob**

Indicates the filter Q setting. Use the screen encoder to adjust the value.

- **FREQUENCY knob**

Displays the filter's cutoff frequency setting. Use the screen encoder to adjust the value.



14 KEY IN CUE button

This button cue-monitors the signal that is selected as the KEY IN SOURCE. CUE will be cleared if you select a dynamics processor for which this button is not displayed, or if you move to a different screen.

NOTE

Even if the Cue mode is set to MIX CUE (the mode in which all channels whose [CUE] key is on are mixed for monitoring), turning on the KEY IN CUE button will cause only the signal for the corresponding channel to be monitored. All [CUE] keys that had been turned on at that time will be forcibly cleared.

15 Dynamics parameter setting knobs

Displays the dynamics parameter values. Use the corresponding screen encoder to adjust the values. The type of parameters will vary depending on the currently-selected dynamics processor type.

LEGACY COMP, COMP206, or EXPANDER:



GATE or DUCKING:



DE-ESSER:



FET LIMITER:



DIODE BRIDGE COMP:



16 MIX BALANCE knob

Adjusts the balance of the input signals.

DYNAMICS 1/2 popup window (CH 1-72, CH 73-144, MIX, MTRX/ST)

This window allows you to specify the settings of the global dynamics parameters for the corresponding channel.

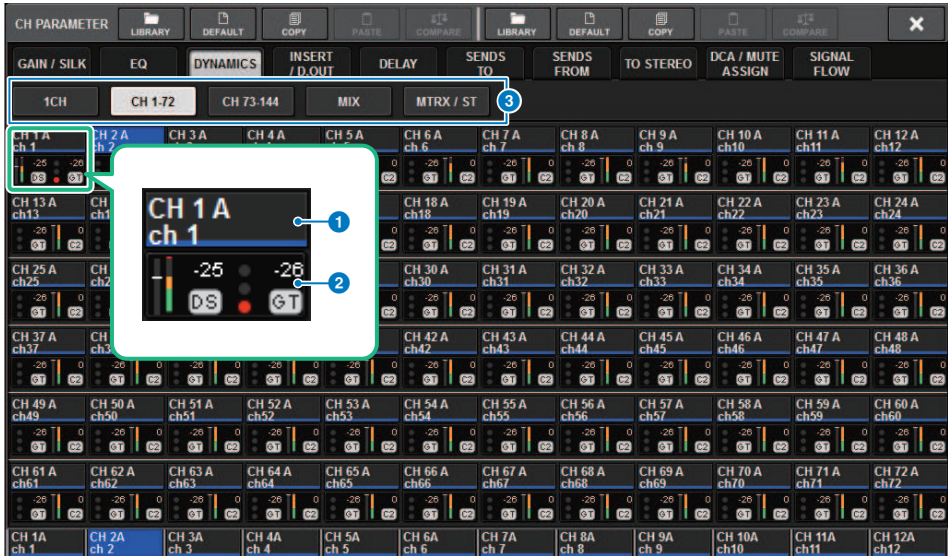

1 Channel select button

Enable you to select the channel that you want to operate. The current channel icon, number, threshold, and color are displayed on the button.

2 Dynamics parameter

Displays the type of dynamics processor, meters that indicate the levels of signals after dynamics processing, the GR meter, and the threshold (a numeric value). Press the area to open the DYNAMICS 1ch window for that channel. If LEGACY COMP, COMP260, DE-ESSER, EXPANDER, DUCKING, FET LIMITER or DIODE BRIDGE COMP has been selected as the dynamics processor type, the abbreviated name of the type appears near the top of this area.

The meaning of each abbreviated name is as follows:

LC: LEGACY COMP

C2: COMP260

GT: GATE

DS: DE-ESSER

EX: EXPANDER

DK: DUCKING

FL: FET LIMITER

DC: DIODE BRIDGE COMP

Displays the Dynamics on/off status.

If the dynamics processor is any type other than GATE, the threshold setting is indicated as a horizontal line in the meter area.

Type = Any type other than GATE

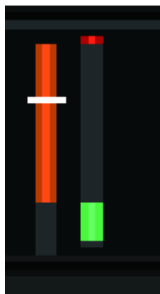

Type = GATE

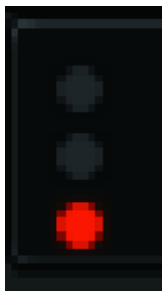

If GATE is selected as the dynamics processor type, the indicator status means the following:

Gate status indicator				
On/Off status	On	On	On	Off
Open/Close status	Close	Open	Open	—
Amount of gain reduction	30 dB or higher	30dB	0dB	—

3 Tabs

Use these tabs to select a channel that you want to view on the screen.

About insert

Each channel provides two inserts: Insert 1 and Insert 2. In each insert, you can insert up to four plug-ins, GEQ/PEQ, or external devices (via the I/O jacks). Each insert point can be selected independently for INSERT 1 and INSERT 2. For details on inserting plug-ins, refer to “Using plug-ins” (p.649). For details on inserting GEQ/PEQ, refer to “Inserting a GEQ/PEQ into a channel”.

Inserting an external device (OUTBOARD) into a channel

An external device such as an effect processor can be inserted into the signal route of each channel. There are three ways to control the external device.

- “Using the Selected Channel section to make INSERT settings (only for CS-R10, CS-R10-S, CSD-R7)” (p.509)
- “Using the OVERVIEW screen to make INSERT settings” (p.512)
- “Using the SELECTED CHANNEL VIEW screen to make INSERT settings” (p.513)

Using the Selected Channel section to make INSERT settings (only for CS-R10, CS-R10-S, CSD-R7)

- 1 Select the channel that you want to operate.**
- 2 Press the INSERT [PLUG-INS] key.**

The INSERT screen appears.
- 3 Use the INSERT 1/2 switch button and INSERT [A]-[D] buttons to select an insert channel and block for which you want to assign the external device.**
- 4 Press the MOUNT popup button to access the MOUNT popup window.**



CH Parameter > Using the Selected Channel section to make INSERT settings (only for CS-R10, CS-R10-S, CSD-R7)

5 Press the OUTBOARD tab and select OUTBOARD.

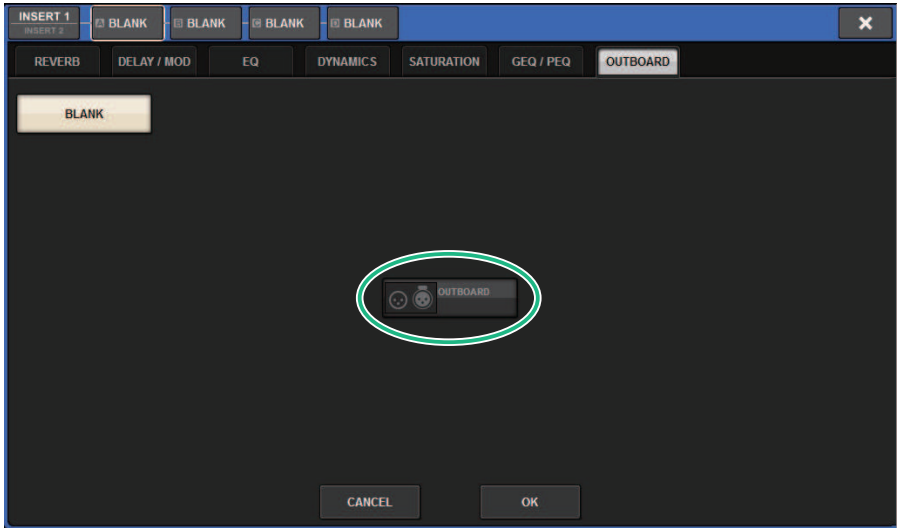

6 Press the OK button.

The OUTBOARD screen appears.

7 Press the INSERT OUT patch select popup button to access the OUTPUT PATCH popup window.

8 Specify the output port that you want to use as the insert out.

9 Press the INSERT IN patch select popup button to access the INPUT PATCH popup window.

10 Specify the input port that you want to use as the insert in.

11 If necessary, make insert settings for other channels in the same way.

INSERT section

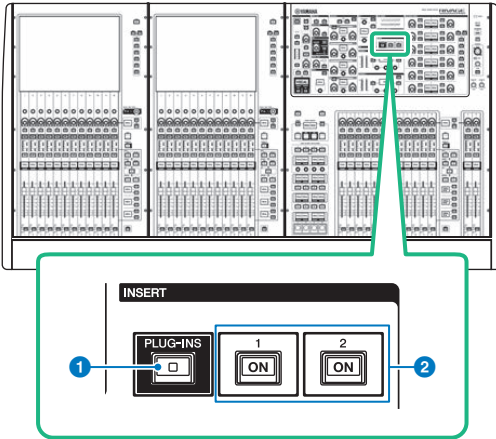

- 1 INSERT [PLUG-INS] key**
Enables you to recall a parameter setting screen for the inserted plug-in.
- 2 INSERT 1/2 [ON] keys**
Switch INSERT1 and INSERT2 on or off respectively.

Using the OVERVIEW screen to make INSERT settings

- 1 Press the [VIEW] key to access the OVERVIEW screen.**

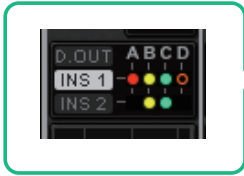

INSERT/DIRECT
OUT field



OVERVIEW screen

- 2 Press the INSERT/DIRECT OUT field for the channel into which you want to insert.**
The INSERT/D.OUT popup window appears. There are two types of INSERT/D.OUT popup window: 1CH, and 12CH INSERT 1/2.
- 3 Press the INSERT block button to which you want to assign the external device: The MOUNT screen appears.**
- 4 Follow steps 5–11 under “Using the Selected Channel section to make INSERT settings (only for CS-R10, CS-R10-S, CSD-R7)” (p.509).**

Using the SELECTED CHANNEL VIEW screen to make INSERT settings

- 1** Select the channel that you want to operate.
- 2** Press the [VIEW] key to access the SELECTED CHANNEL VIEW screen.



SELECTED CHANNEL VIEW screen

- 3** Press the INSERT field to access the MOUNT screen.
- 4** Follow steps 5–11 under “Using the Selected Channel section to make INSERT settings (only for CS-R10, CS-R10-S, CSD-R7)” (p.509).

INSERT screen

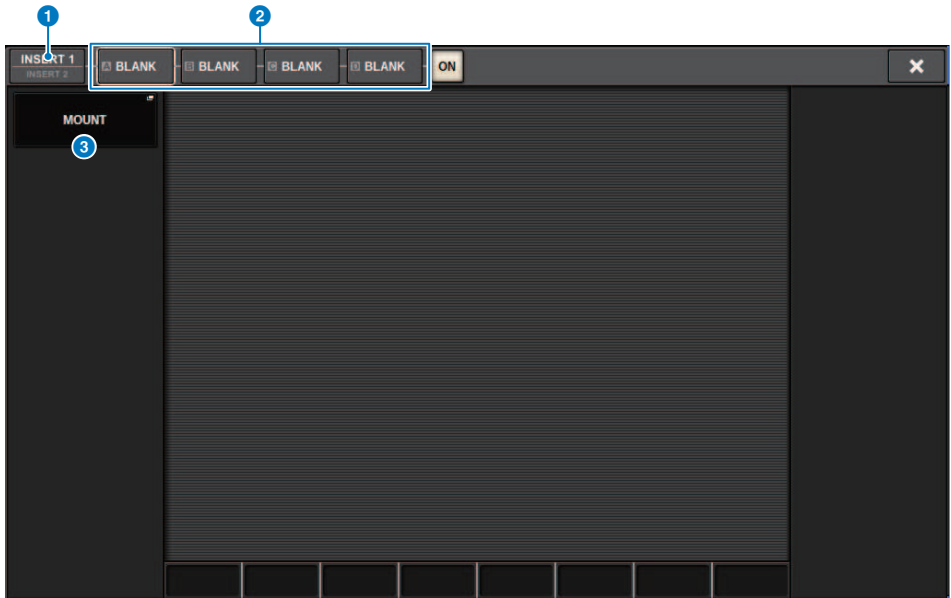

This screen contains the following items.

- 1 INSERT 1/2 switch buttons**
Switches between INSERT1 and INSERT2.
- 2 INSERT block [A]–[D] buttons**
Indicate four plug-ins that have been assigned to INSERT1 and INSERT2 respectively. Press this button to display the edit screen for the assigned plug-in.
- 3 MOUNT popup button**
Press this button to display the MOUNT screen.

OUTBOARD screen



This screen contains the following items.

- 1 MOUNT popup button**
Press this button to display the MOUNT screen.
- 2 INSERT OUT patch select popup button**
Press this button to access a popup window in which you can select an output port. The currently-selected port is indicated on the button. To insert an external device to a channel via the RPi, you must assign the channel to the TWINLANe network.
- 3 INSERT IN patch select popup button**
Press this button to access a popup window in which you can select an input port. The currently-selected port is indicated on the button.
- 4 Level meter**
Indicates the level of the signal being output from the insert, and the level of the signal being input to the insert.

INSERT/D.OUT popup window (1CH)



This screen contains the following items.

1 INSERT block [A]–[D] buttons

Indicate four plug-ins that have been assigned to INSERT1 and INSERT2 respectively. Press this button to display the edit screen for the assigned plug-in.

INSERT/D.OUT popup window (12CH INSERT 1, 12CH INSERT 2)

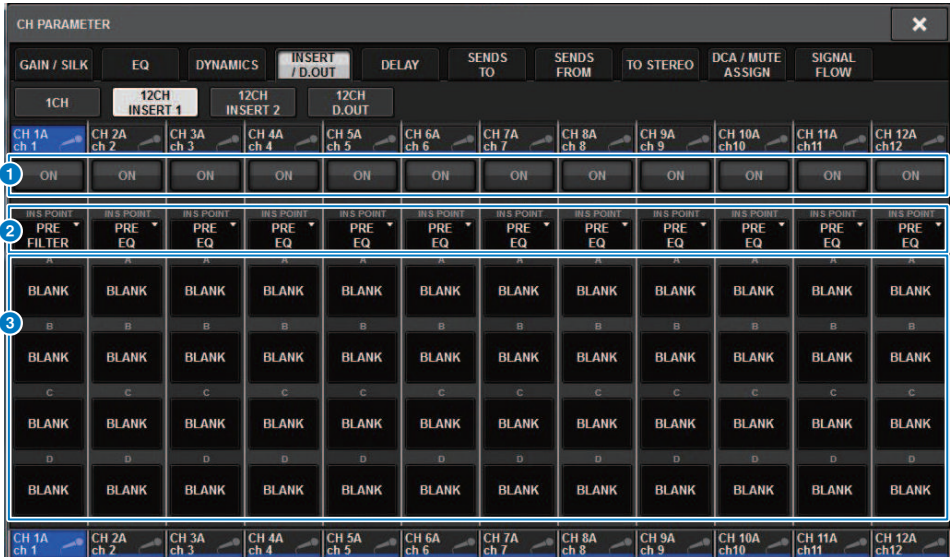

This screen contains the following items.

1 INSERT ON button

Switches the insert on/off.

2 Insert point

Enables you to select the signal source point from the following:

Input channels: PRE FILTER, PRE EQ, PRE DYN1, PRE DYN2, PRE FADER, POST ON

Output Channels: PRE FILTER, PRE EQ, PRE DYNA, PRE DELAY, PRE FADER, POST ON

3 INSERT block [A]–[D] buttons

Indicate four plug-ins that have been assigned to INSERT1 and INSERT2 respectively. Press this button to display the edit screen for the assigned plug-in.

Inserting an external device into a channel

You can insert an external device (compressor, EQ, etc.) into a channel via on the RPiO. Only the INSERT 1C for channels 1-36 supports this function.

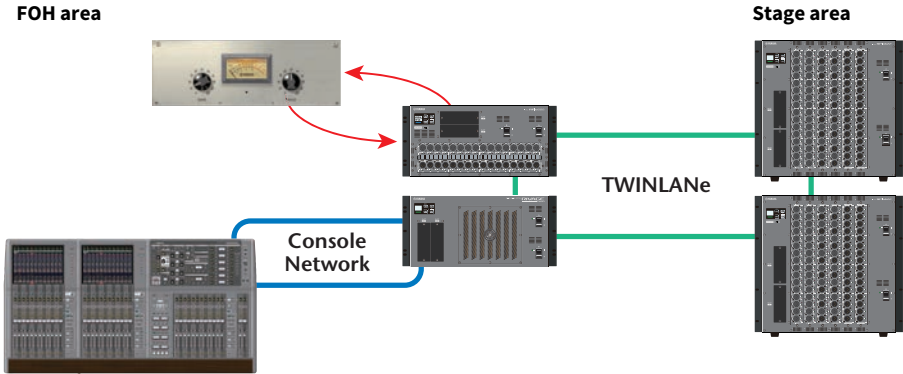

1 Assign the channels that will be used by the DSP engines to the TWINLANE network.

DSP popup window

The screenshot shows the DSP popup window with the following settings:

- OUTPUT/D.OUT:** INSERT OUT(1C)
- HY SLOT 1:** OPT.POWER (Lo limit: 11uW), IN: 367uW, OUT: 106uW, TOTAL LENGTH: 100mm
- HY SLOT 2:** OPT.POWER (Lo limit: --uW), IN: --, OUT: --, TOTAL LENGTH: --
- Channel Assignments:**
 - CH 1-72: 1-72
 - CH 73-144: 73-144
 - CH 145-216: 145-216
 - CH 217-288: 217-288
- Network Settings:**
 - MIX: 8
 - STEREO: 0
 - MATRIX: 0
 - MONITOR: 0
 - OUT: 0
 - (1C): 0
 - SLOT BRIDGE OUT: 0
 - SLOT OUT: 8/256
 - SLOT IN: 0/256
- Buttons:** REVERT ALL, APPLY

2 Specify the input/output ports that you want to use as the insert out for INSERT 1C of channels 1-36.



Directly outputting an input channel

The signal of an input channel can be directly output from the OUTPUT jack of an I/O rack, any desired OMNI OUT jack, or an output channel of a desired card slot.

- 1 In the OVERVIEW screen of the input channel that you want to directly output, press the INSERT/DIRECT OUT field, or press the DIRECT OUT field in the SELECTED CHANNEL VIEW screen.**

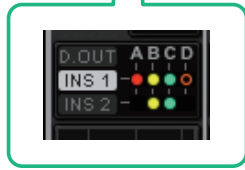
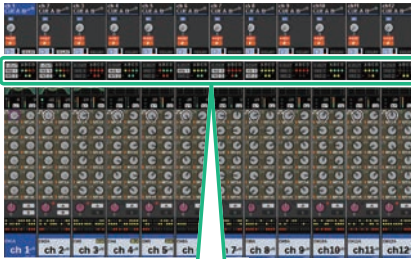

INSERT/DIRECT OUT field in the OVERVIEW screen



DIRECT OUT field in the SELECTED CHANNEL VIEW screen

The “INSERT/D.OUT popup window (1CH)” (p.516) appears There are two types of INSERT/D.OUT popup window: 1CH and 12CH D. OUT.

- 2 Press the DIRECT OUT PATCH popup button to access the DIRECT OUT PATCH popup window.**
- 3 In the DIRECT OUT PATCH popup window, select the output port that you want to use for Direct Out, and then press the CLOSE button.**
You will return to the INSERT/D.OUT popup window.
- 4 Use the DIRECT OUT point to switch the point from which the Direct Out signal is taken.**
- 5 Use the DIRECT OUT LEVEL knob to adjust the output level of the Direct Out.**

6 Press the DIRECT OUT ON button to turn it ON.

Direct output is now enabled. Adjust the input level and other settings on the external device as necessary.

7 If necessary, make Direct Out settings for other channels in the same way.

INSERT/D.OUT popup window (1CH/D.OUT)



This screen contains the following items.

1 DIRECT OUT point

Enables you to select the signal extraction point as PRE FILTER, PRE EQ, PRE DYN1, PRE DYN2, PRE FADER, POST FADER, or POST ON.

2 DIRECT OUT LEVEL knob

Indicates the output level of the Direct Out. You can press this knob and then use the screen encoder or the [TOUCH AND TURN] knob to adjust the level.

3 DIRECT OUT PATCH popup button

Indicates the currently-selected port. If nothing is selected, the button indicates ----. Press this button to access the patch window.

4 DIRECT OUT ON button

Switches direct out on/off. The currently-specified Direct Out point is indicated in the lower part of the button.

INSERT/D.OUT popup window (12CH/D.OUT)

This window is convenient if you want to make settings for multiple channels at one time.

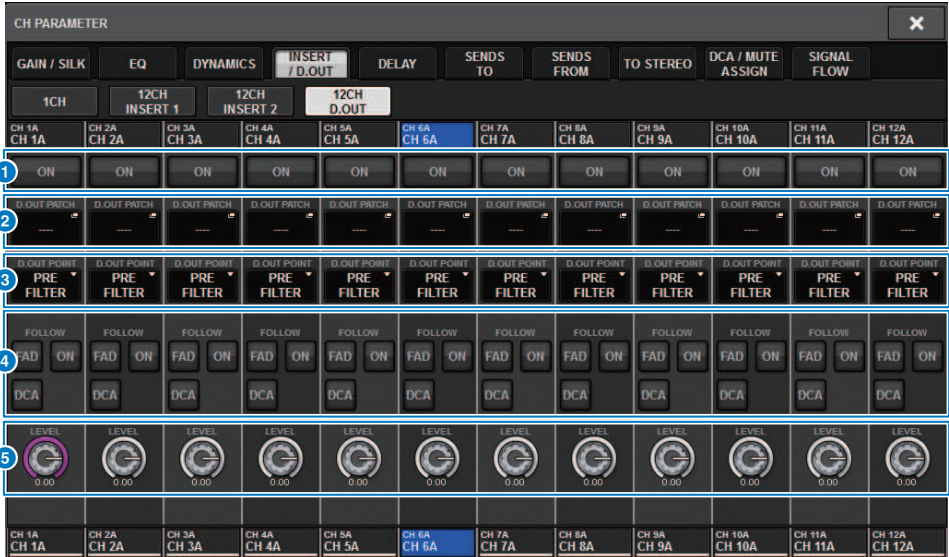

This screen contains the following items.

1 DIRECT OUT ON button

Switches direct out on/off. The currently-specified Direct Out point is indicated in the lower part of the button.

2 DIRECT OUT PATCH popup button

Indicates the currently-selected port. If nothing is selected, the button indicates “----”. Press this button to access the patch window.

3 DIRECT OUT point

Enables you to select the signal extraction point as PRE FILTER, PRE EQ, PRE DYN1, PRE DYN2, PRE FADER, POST FADER, or POST ON.

4 FOLLOW setting buttons

Enable you to set parameters for signals routed from input channels to the direct out so that the parameters will follow the FADER/ON/DCA settings.

5 DIRECT OUT LEVEL knob

Indicates the output level of the Direct Out. You can press this knob and then use the screen encoder or the [TOUCH AND TURN] knob to adjust the level.

Patching multiple Direct Outs simultaneously

1 Press the **PATCH** button on the menu bar to access the **PATCH** screen.

This screen includes several pages, which you can switch between using the tabs located at the top of the screen.



2 Press the **DIRECT OUT** tab.

The “DIRECT OUT page” (p.525) opens.

3 Use the port select knob to display the ports of the slot that will be used for **DIRECT OUT**.

4 Use the channel select knob to display channels.

5 Press a grid cell to patch the corresponding channel.

DIRECT OUT page

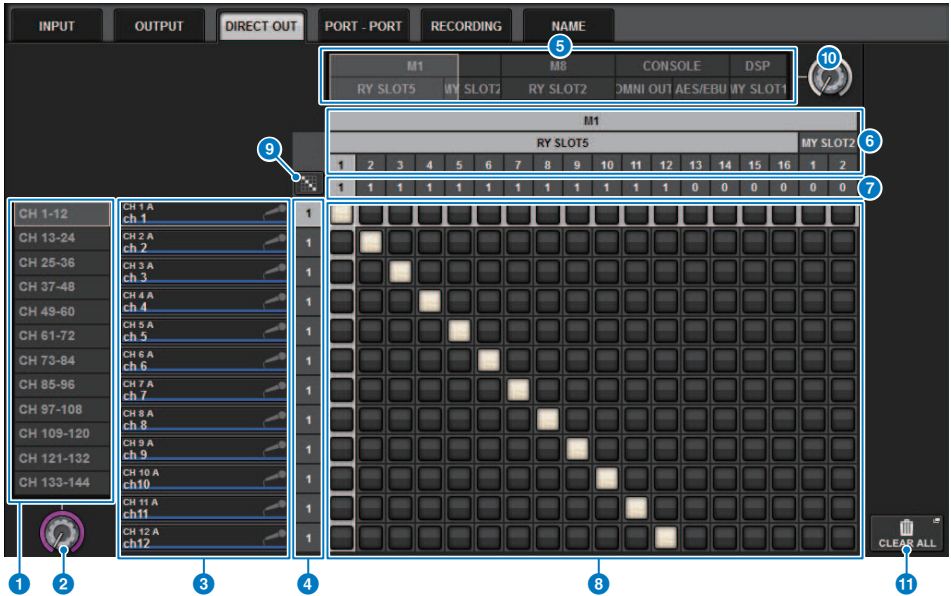

This screen contains the following items.

1 Channel select list

Enables you to select the channels that you want to view on the screen.

2 Channel select knob

Enables you to select the channel that you want to use for Direct Out.

3 Channel display

This area displays the channel name of each input channel that will be a patch source.

4 Output patch number indication

Indicates the number of Direct Outs assigned to each input channel.

5 Category select list

Select the ports that you want to view on the screen.

6 OUTPUT COMPONENT/SLOT/CH

From the top, this section indicates the type of the output component, slot number, and channel number for the output port. The abbreviations displayed in the output component column have the following meaning.

- **Mx, Sx**I/O rack (x is the UNIT ID number)
- **CS1, CS2**.....Control surface
- **DSP**.....DSP engine







7 DIRECT OUT ASSIGN (assign)

Indicates the number of channels assigned to each port.

8 Grid

This grid enables you to patch input channels (vertical columns) to output ports (horizontal lines). Currently-patched grids are indicated by white squares. Press or click a desired grid to set or disable the patch.

9 Continuous Patch  button

Press the continuous patch  button, and then rotate the select knob (2) (10) to patch the intersecting channels continuously. If you press the continuous patch  button, the  button and the  button will appear. Press the  button again to confirm the selected continuous patches. Press the  button to revert the continuous patches to their previous state.

10 Port select knob

Selects the port that will be used for Direct Out.

11 CLEAR ALL button

Press this button to clear all patches.

About delay

Each input/output channel features a channel delay of up to 1000 msec. You can select the delay time unit from the following: meter, feet, sample, msec, frame, depending on your application. You can also specify insert points for the delay on each channel individually.

There are three ways to set the delay:

- “Controlling the delay via the Selected Channel section(CS-R10, CSR10- S, CSD-R7) ” (p.529)
- “Controlling the delay via the OVERVIEW screen” (p.530)
- “Controlling the delay via the SELECTED CHANNEL VIEW screen” (p.531)

DELAY section(CS-R10, CSR10- S, CSD-R7)

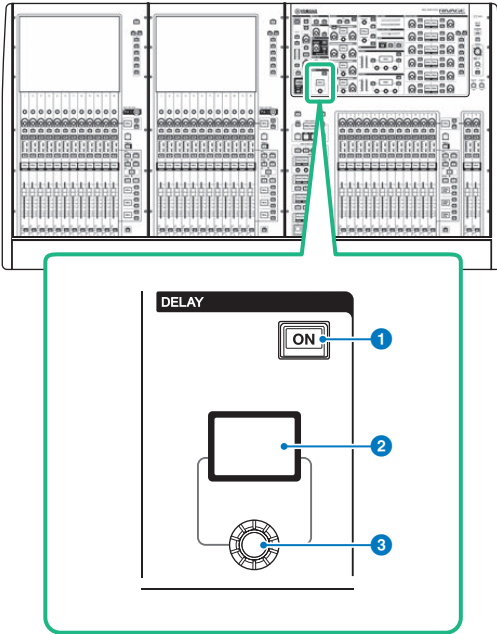

This screen contains the following items.

- 1 DELAY [ON] key**
Switches the delay on or off.
- 2 DELAY display**
Indicates the delay value.
- 3 [DELAY] knob**
Sets the delay value.

Controlling the delay via the Selected Channel section(CS-R10, CSR10- S, CSD-R7)

- 1 Use a [SEL] key to select the channel you want to control.**
- 2 Turn on the DELAY [ON] key in the Selected Channel section.**
- 3 Use the [DELAY] knob to adjust the DELAY value.**

Controlling the delay via the OVERVIEW screen

- 1 Press the [VIEW] key to access the OVERVIEW screen.**
- 2 Press the DELAY field to access the DELAY popup window.**

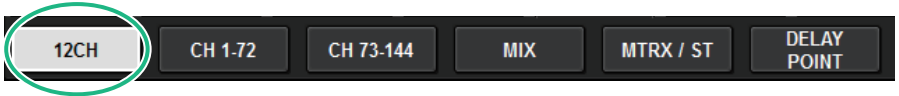

This window includes several pages, which you can switch between using the tabs located at the top of the window.

- 3 Press the 12CH tab to open the DELAY popup window (12CH).**
- 4 Use the on-screen buttons, screen encoders, and the [TOUCH AND TURN] knob to set the delay.**
- 5 Perform the same operations for other channels as desired.**

If you are viewing the 12ch DELAY popup window, you can use the Layer Select keys to switch the channels being controlled in groups of twelve. You can also press the meter area to switch channels.
- 6 When you finish making settings, press the X symbol in the upper right of the window.**

Controlling the delay via the SELECTED CHANNEL VIEW screen

- 1 Press the [VIEW] key to access the SELECTED CHANNEL VIEW screen.**



- 2 Select the channel that you want to operate.**
- 3 Use the corresponding screen encoder or the [TOUCH AND TURN] knob to adjust the delay parameters.**
- 4 Set the insert point if necessary.**

Use the “DELAY popup window (12ch)” (p.532) to set the insert point.

NOTE

For information on monitor/cue delay, refer to MONITOR SETTINGS popup window.

DELAY popup window (12ch)



This screen contains the following items.

1 DELAY SCALE popup button

Press this button to access the DELAY SCALE popup window in which you can select the unit for the delay time.

2 Channel select buttons

Each button will light to indicate that the corresponding channel is selected. Press the button to select the channel.

3 DELAY ON buttons

Switch delay on or off.

4 Delay insert point select buttons

Enable you to select the delay insert point from the following: PRE HPF, PRE EQ, PRE DYN1, PRE DYN2, PRE FADER, POST FADER.

5 Delay setting knobs

Indicate the channel delay value. Use the corresponding screen encoder or the [TOUCH AND TURN] knob to adjust the parameters. You can view the current value immediately above the knob (always shown in unit of ms) and below the knob (shown using the currently-selected scale). Press the knob to display a popup window, in which you can set the delay time.

NOTE

If msec (millisecond) has been selected for the DELAY SCALE, nothing will appear above the knob.

6 Tabs

Use these tabs to select a channel that you want to view on the screen.

CH Parameter > DELAY popup window (12ch)

7 COPY button

Copies the delay parameter settings to buffer memory.

8 PASTE button

Press this button to paste the settings that were copied in buffer memory to the delay of the currently-selected channel. If valid data has not been copied into buffer memory, you will be unable to paste it.

DELAY popup window (CH 1-72, CH 73-144, MIX, MTRX/ST)

This window displays the corresponding input channels (or output channels) simultaneously. It is useful when you want to quickly check the delay setting for multiple channels.

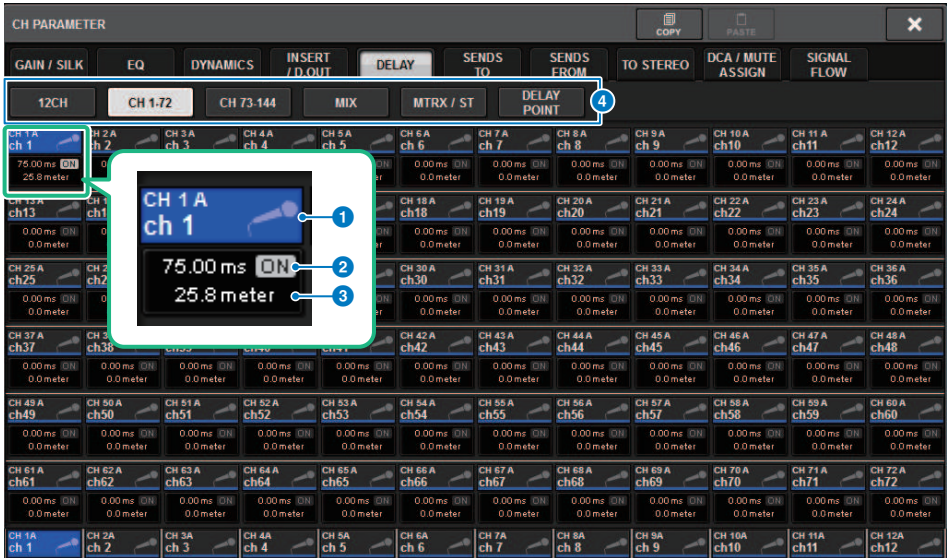

This screen contains the following items.

1 Channel select button

Enable you to select the channel that you want to operate. The current channel icon, number, and color appear on the button.

2 DELAY ON indicator

Indicates the on/off status of the delay.

3 DELAY TIME button

You can view the delay value when the delay is turned on (always displayed in units of ms on the upper row, and in the currently-selected scale on the bottom row). Press one of these values to display the "DELAY TIME popup window" (p.536), in which you can set the delay time.

4 Tabs

Use these tabs to select a channel that you want to view on the screen.

DELAY SCALE popup window

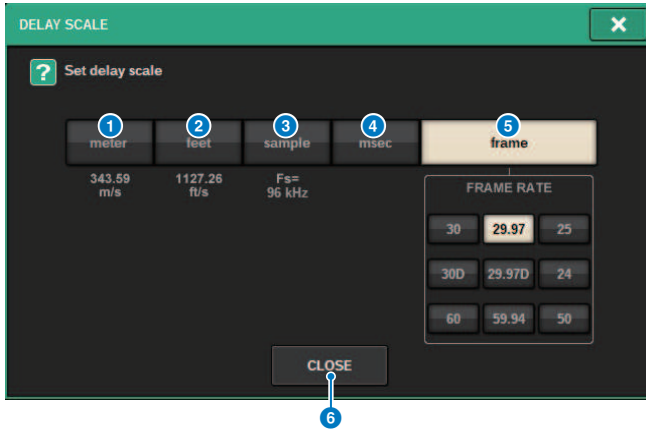

You can select the delay scale from the following five options.

1 METER

The distance in meter, calculated as the speed of sound at an air temperature of 20 °C (343.59m/s) × the delay time (seconds).

2 FEET

The distance in feet, calculated as the speed of sound at an air temperature of 20 °C (68 °F) (1127.26 feet/s) × the delay time (seconds).

3 SAMPLE (number of samples)

The delay time is shown as the number of samples. If you change the sampling frequency on which the RIVAGE PM series operates, the number of samples will change accordingly.

4 msec (milliseconds)

The delay time is shown in units of milliseconds.

5 FRAME

The delay time is shown in units of frames. Use the six buttons located below the FRAME button to select the number of frames per second.

6 CLOSE button

Closes the DELAY SCALE popup window.

DELAY TIME popup window

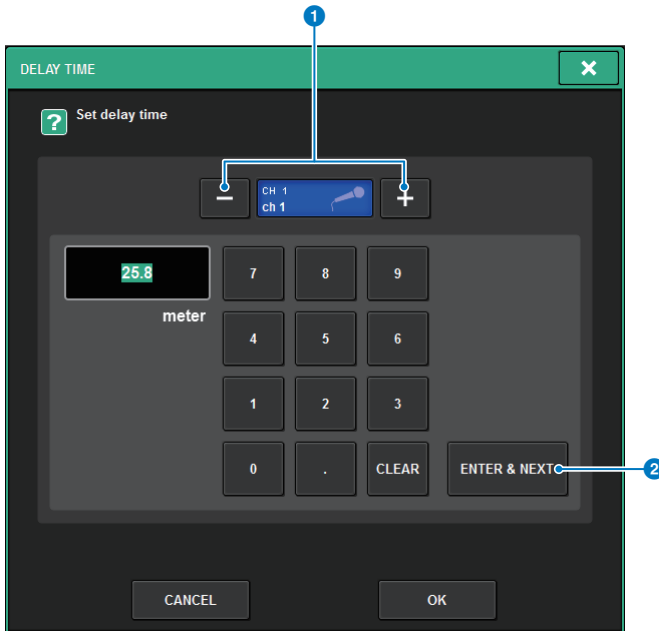

Using the ENTER & NEXT button enables you to set the delay time for each channel consecutively.

1 Channel select +/- buttons

Indicates the currently-selected channel. Press the + button to select the next channel. Press the - button to select the previous channel.

2 ENTER & NEXT button

Press this button to confirm the delay time setting, and then move to the next channel.

Using SENDS TO

By using SENDS TO, you can specify the sends to a specific MIX or MATRIX bus for 12 channels at a time.

1 Press the [VIEW] key to open the OVERVIEW window.



2 Use the MIX/MATRIX SENDS [MIX]/[MATRIX] keys to switch the type of send-destination bus.

3 Use the MIX/MATRIX SENDS [1-12]/[13-24]/[25-36]/[37-48]/[49-60]/[61-72] keys to select a bank of send-destination buses.

NOTE

Press the [SHIFT] key to display the bank select button in the DCA/Mute group field. That button allows you to select a bank for the send destination bus.

4 Select the SEND knob of the corresponding send-destination MIX/MATRIX bus, and press it again to open the “SENDS TO popup window” (p.543).

NOTE

When MATRIX channels are selected, pressing the SEND knob again will access the “SENDS FROM popup window” (p.545).

5 You can use the SEND ON button to turn on/off the signal that is sent from each input or MIX channel to the currently-selected MIX/MATRIX bus.

6 If necessary, use the PRE button to select the send point of the signal that is sent from each input channel, MIX channel, or STEREO channel to a VARI-type MIX bus or MATRIX bus.

NOTE

- This allows you to flexibly select the send point for each channel (SEND POINT (INPUT)).
- The PRE button is not shown for a FIXED-type MIX bus.

7 Use the SEND LEVEL knob to adjust the send level.

Using SENDS FROM

By using SENDS FROM, you can specify the sends from a specific channel to the MIX or MATRIX buses for 12 channels at a time.

1 Press the [VIEW] key to access the OVERVIEW screen.



2 Press the MIX popup button or the MATRIX popup button.

The SENDS FROM popup window appears.

3 Use the SEND ON button to switch on/off the signal that is sent from the currently-selected channel to the MIX or MATRIX bus.

4 If necessary, use the PRE button to select the send point of the signal that is sent to the MIX or MATRIX bus.

NOTE

- This allows you to flexibly select the send point for each channel (see SEND POINT (INPUT)).
- The PRE button is not shown for a FIXED-type MIX bus.

MIX/MATRIX SEND section(CS-R10, CSR10- S, CSD-R7)

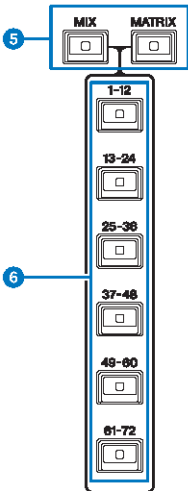
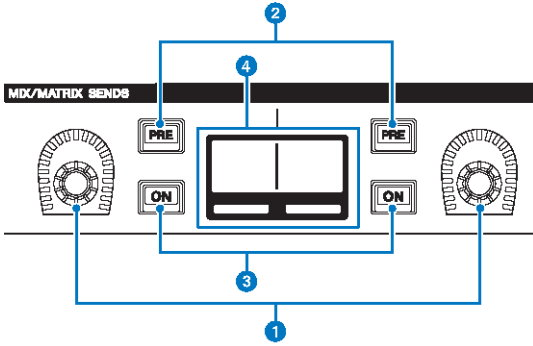

- 1 MIX/MATRIX SENDS knobs**
Adjust the send levels for the corresponding buses.
- 2 MIX/MATRIX SENDS [PRE] keys**
Toggle the send point between PRE and POST. If a key lights up, the send point is set to PRE.
- 3 MIX/MATRIX SENDS [ON] keys**
Switch the send signal to the corresponding bus on or off.
- 4 MIX/MATRIX SENDS display**
Indicates the corresponding bus.
- 5 MIX/MATRIX SENDS [MIX]/[MATRIX] keys**
Switch the type of the send destination bus.

CH Parameter > MIX/MATRIX SEND section(CS-R10, CSR10- S, CSD-R7)

6 MIX/MATRIX SENDS [1-12]/[13-24]/[25-36]/[37-48]/[49-60]/[61-72] keys

Selects a bank for the send destination bus.

Using the Selected Channel section to make send level settings(CS-R10, CSR10- S, CSD-R7)

You can use the knobs of the Selected Channel section to adjust the send levels.

- 1 Verify that an output port is assigned to the MIX/MATRIX bus to which the signal is sent, and that the corresponding output port is connected to the monitor system or an external effect processor.**
- 2 Use the top panel [SEL] keys to select the channel that will send a signal to the MIX/MATRIX bus.**
- 3 Press the MIX/MATRIX SENDS [PRE] key to switch the send point to PRE or POST.**

NOTE

If the send destination is set to FIXED, the MIX/MATRIX SENDS [PRE] key is unavailable.

- 4 Press the MIX/MATRIX SENDS [ON] key to turn it on.**
- 5 Use the MIX/MATRIX SENDS knobs of the Selected Channel section to adjust the send levels to the MIX/MATRIX buses.**

NOTE

- If the send-destination bus is stereo, the left knob adjusts the pan/balance and the right knob adjusts the send level.
- To monitor the signal that is being sent to a specific MIX/MATRIX bus, recall the corresponding MIX/MATRIX channel and press the corresponding [CUE] key.

- 6 Use the top panel [SEL] keys to switch channels, and adjust the send levels to all MIX/MATRIX buses in the same way.**

SENDS TO popup window

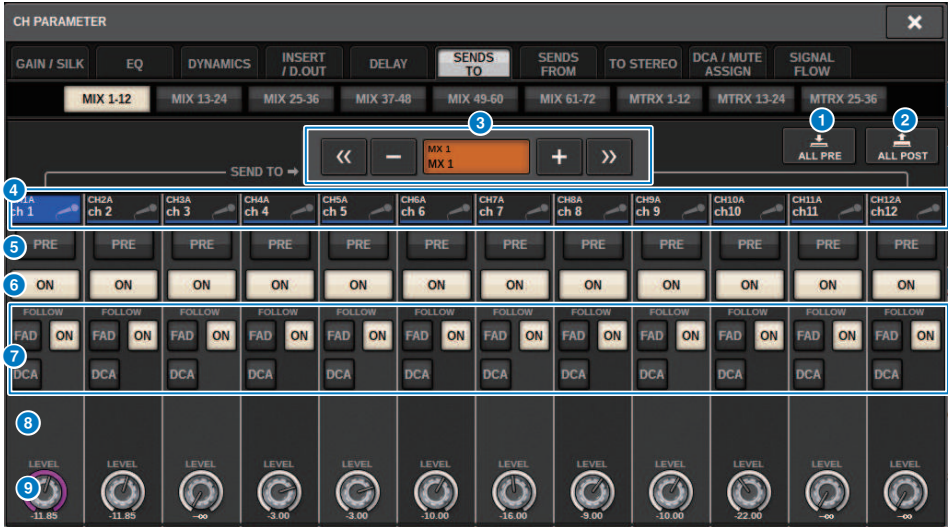

This screen contains the following items.

1 ALL PRE button

Sets the send point to “PRE” for all send sources (input channels, MIX channels, STEREO channels) of the selected send destination. At this time, the PRE button (5) will light up.

2 ALL POST button

Sets the send point to “POST” for all send sources (input channels, MIX channels, STEREO channels) of the selected send destination. At this time, the PRE button goes dark.

3 Send destination select button

Indicates the currently-selected send destination. You can use the -/+ buttons at left and right to switch to adjacent channels. You can use the << / >> buttons to switch in steps of 12 channels.

NOTE

Use the [MIX]/[MATRIX] keys to switch the send-destination selection. You can also switch this by holding down the [SHIFT] key and pressing the meter area display section.

4 Channel select buttons

Indicate the send-source channel being controlled. Press this button to select the on-screen selected channel. The current channel icon, number, and color appear on the button, and the channel name appears below the button.

NOTE

You can use the layer select keys to switch the send-source selection.

5 PRE button

Switches the send point to PRE or POST for each send-source channel. If a button is lit, the send point is set to PRE.

6 SEND ON button

Switches send on/off for each send-source channel.

7 FOLLOW setting buttons

Enable you to set parameters for signals routed from input channels to the MIX/MATRIX bus so that the parameters will follow the FADER/ON/DCA settings.

8 SEND PAN/BALANCE knob

Adjusts the pan or balance when the send-destination bus is stereo. If the send destination is monaural or is set to FIXED, this knob does not appear. If the send source is monaural, the knob adjusts pan. If the send source is stereo, the knob adjusts balance.

9 SEND LEVEL knob

Indicates the send level to the selected send destination. You can press this and then use the screen encoder or the [TOUCH AND TURN] knob to adjust it. If the send destination is set to FIXED, this knob will not appear.

SENDS FROM popup window

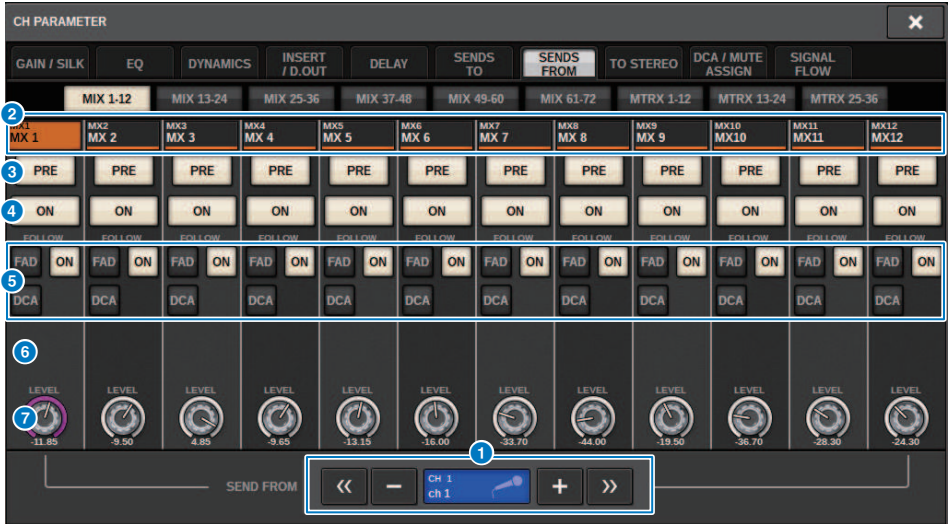

This screen contains the following items.

1 Send-source select button

Indicates the currently-selected send source. You can use the $-/+$ buttons at left and right to switch to adjacent channels. You can use the \ll / \gg buttons to switch in steps of 12 channels. This indication is linked with the on-screen selected channel.

2 Bus indication

Shows the send-destination bus. Use the [MIX]/[MATRIX] keys to switch the send-destination selection. You can also switch this by holding down the [SHIFT] key and pressing the meter area display section.

3 PRE button

Selects either PRE or POST as the send point of the signal that is sent to each bus. If a button is lit, the send point is set to PRE.

4 SEND ON button

This button switches send to each bus on/off.

5 FOLLOW setting buttons

Enable you to set parameters for signals routed from input channels to the MIX/MATRIX bus so that the parameters will follow the FADER/ON/DCA settings.

6 SEND PAN/BALANCE knob

Adjusts the pan/balance when the send-destination bus is stereo. If the bus is monaural or is set to FIXED, this knob will not be shown. If the send source is monaural, the knob adjusts pan. If the send source is stereo, the knob adjusts balance.

CH Parameter > SENDS FROM popup window

7 SEND LEVEL knob

Adjusts the send level to the corresponding bus. If the send-destination bus is set to FIXED, this knob will not be shown.

Using the faders to adjust the sends (SENDS ON FADER mode)

You can use the top panel faders to adjust the signals that are sent from a specific channel to the MIX/MATRIX buses.

- 1 Verify that an output port is assigned to the MIX/MATRIX bus to which the signal is sent, and that the corresponding output port is connected to the monitor system or an external effect.**
- 2 Press the SENDS ON FADER button on the menu bar or press the top panel [SENDS ON FADER] key.**

The SENDS ON FADER popup window appears. The RIVAGE PM series switches to SENDS ON FADER mode, and the SENDS ON FADER popup window appears. The faders in the Channel Strip section move to indicate the send level of the signals that are routed from each channel to the currently-selected MIX/MATRIX bus. The [ON] keys also change to the SEND ON status.

NOTE

In the CS-R3, the SENDS ON FADER button on the menu bar indicates the status of the BAY L, C, and R SENDS ON FADER mode.

- In the example below, BAY C is in SENDS ON FADER mode.



- 3 Press a tab to switch between MIX and MATRIX.**
- 4 Use the MIX/MATRIX select buttons to select the send-destination MIX/MATRIX bus.**

NOTE

If you press the currently-selected MIX/MATRIX select button once again, cue monitor turns on for the corresponding MIX/MATRIX channel. This method is convenient when you want to monitor the signal that is being sent to the selected MIX/MATRIX bus.

- 5 Using the faders of the top panel Channel Strip section, adjust the send level to the selected MIX/MATRIX bus from the channels that are recalled (rolled out) to the layer.**
- 6 Repeat steps 4–5 to adjust the send levels for other MIX/MATRIX buses in the same way.**
- 7 When you finish adjusting the MIX/MATRIX send levels, press the [SENDS ON FADER] key or the SENDS ON FADER button.**

The main area display returns to its previous state, and the RIVAGE PM series exits SENDS ON FADER mode and returns to normal mode.

CH Parameter > Using the faders to adjust the sends (SENDS ON FADER mode)

NOTE

If you press the × button in the upper right of the screen, SENDS ON FADER mode will be maintained when you close the screen. To exit SENDS ON FADER mode, perform step 7.

SENDS ON FADER popup window

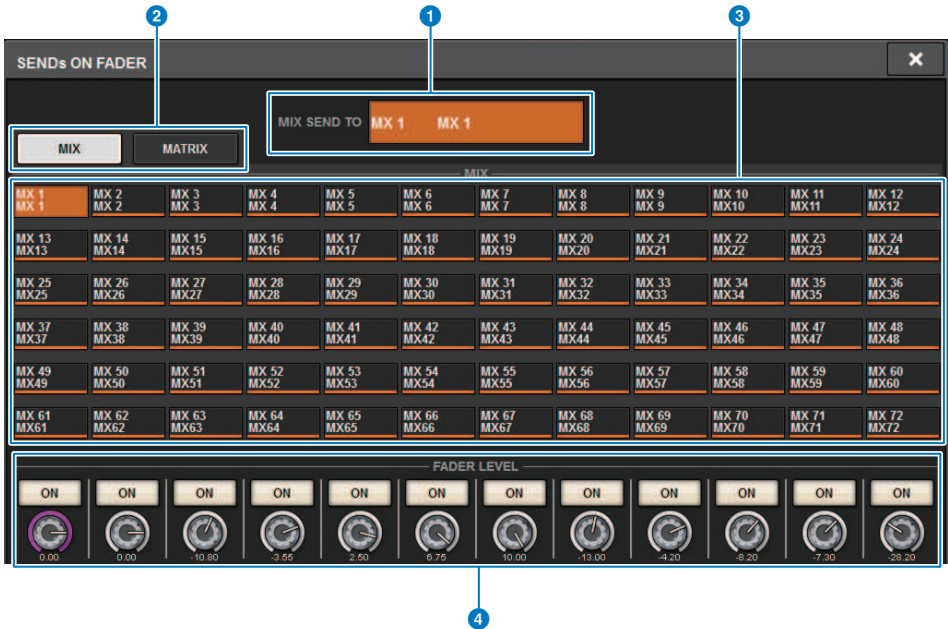

This screen contains the following items.

- 1 SEND TO indication**
Indicates the currently-selected send destination. This is linked with the on-screen selected channel/parameter.
- 2 Tabs**
Switch between MIX and MATRIX.
- 3 MIX/MATRIX bus select buttons**
You can press a button to select the send destination. This is linked with the on-screen selected channel/parameter.
- 4 FADER LEVEL ON field**
This field displays the content selected by PARAMETER SHOWN ON SENDS ON FADERSCREEN of the Preferences settings. You can select FADER LEVEL, SEND PAN, or SEND LEVEL.

Using the Touch Screen section to make send level settings (CS-R5, CS-R3)

Adjust the send level using the touch screen and knob.

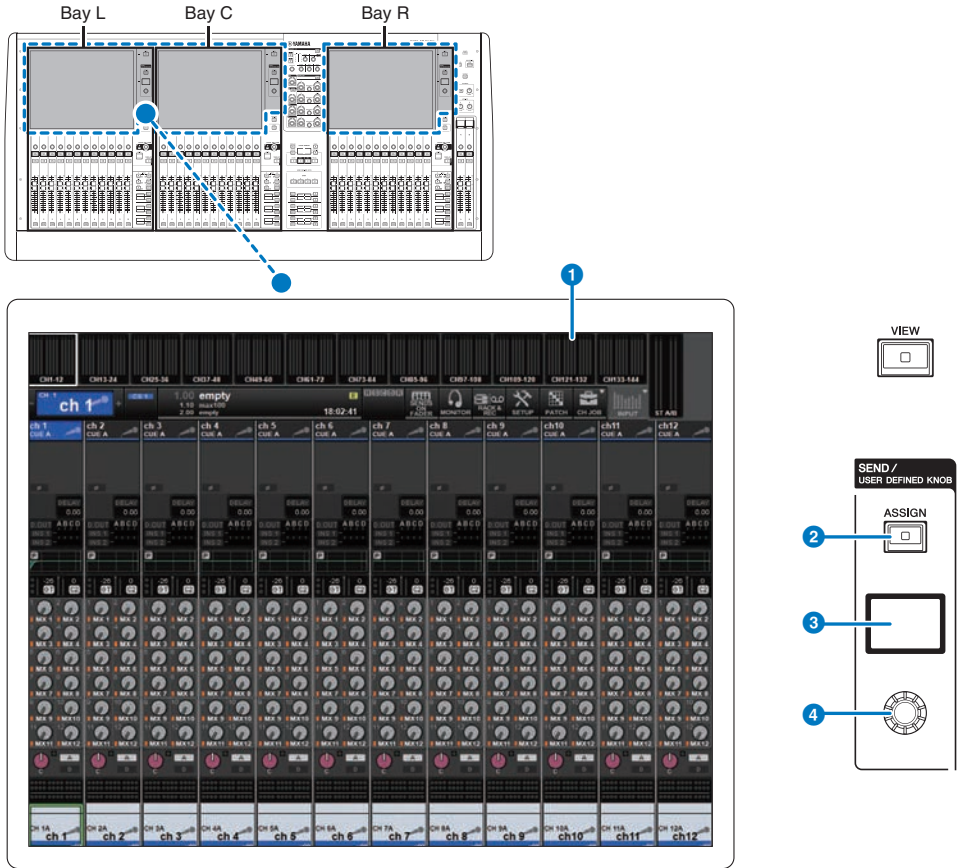

1 Touch screen

This is a touch screen that you can operate. Use the screen to select menus or set parameters.

2 [ASSIGN] key

Displays a screen that enables you to specify the send destination bus and switch to the USER DEFINED KNOB function. The factory default bus is set to SEND TO MIX 1.

3 Display

While the SEND function is enabled, the display indicates the selected bus and its send level. While the USER DEFINED KNOB function is enabled, the display indicates the assigned function parameter and its value.

4 SEND / USER DEFINED knob

Adjusts the send level for the corresponding bus while the SEND function is enabled. Enables you to control the assigned function while the USER DEFINED KNOB function is enabled.

- 1 Verify that an output port is assigned to the MIX/MATRIX bus to which the signal is sent, and that the corresponding output port is connected to the monitor system or an external effect processor.**
- 2 Use the top panel [SEL] keys to select the channel that will send a signal to the MIX/MATRIX bus.**
- 3 Press the [ASSIGN] key.**
The SENDS/USER DEFINED KNOB popup window appears.
- 4 Select a MIX/MATRIX bus to which the signal will be sent.**
- 5 Use the SEND/USER DEFINED knob to adjust the level to send to the MIX/MATRIX bus.**
- 6 Use the top panel [SEL] keys to switch channels, and adjust the send levels to all MIX/MATRIX buses in the same way.**

SEND/USER DEFINED KNOB popup window



This window contains the following items.

1 SENDS/USER DEFINED KNOBS switching button

Switches when specifying the SENDS setting or the USER DEFINED knob setting.

2 Selected channel

This area shows the number, name, icon, and channel color of the channel that is currently selected for operation. Press the left side of the selected channel area to select the preceding channel. Press the right side of the area to select the next channel.

3 PAN/LEVEL switch button

If the selected destination bus is stereo, the display switches to pan or send level.

4 MIX/MATRIX overview

The feed from the channel to the MIX/MATRIX bus is displayed in the level display. The area currently displayed in detail is indicated by a white frame. The area can be changed by tapping or sliding.

5 Send destination bus select button

Press this to select the send destination MIX/MATRIX bus.

6 SEND channel area

Displays the send level and pan for 12 channels.

The bus send level and pan can be controlled with the SEND/USER DEFINED knob or the [TOUCH AND TURN] knob. It can also be controlled by sliding on the touch screen.

NOTE

If the selected channel is an input channel or a mix bus, the send level from the selected channel/MIX bus to the destination MIX bus/MATRIX bus can be set. If the selected channel is a MATRIX bus, the send level from the selected channel/MIX bus to the destination MIX bus/MATRIX bus can be set.

7 SEND ON button

This button switches the send to a bus on or off.

Using the Quick data copy function

This copies parameters from the desired channel to multiple channels. This is useful for getting ready efficiently. The parameters that can be copied include send level, send on/off, pan/balance, send point, EQ and dynamics type, and FOLLOW settings.

- **Send level**

This copies the send level from a desired input channel to the send levels going to multiple MIX or MATRIX buses from multiple input channels.

- **Send on/off**

This copies the send on/off setting from a desired input channel to the send on/off going to multiple MIX or MATRIX buses from multiple input channels.

- **Pan/balance**

This copies the pan/balance from a desired input channel to the pan/balance of multiple MIX or MATRIX buses from multiple input channels.

- **Send Point**

This copies the send on/off setting from a desired input channel to send points going to multiple MIX or MATRIX buses from multiple input channels.

- **EQ or dynamics type**

This copies the EQ or dynamics type from a desired input channel to multiple input channels. You can also copy the EQ and dynamics type for the MIX or MATRIX bus to multiple MIX or MATRIX buses.

- **FOLLOW settings**

This lets you copy settings that follow the FADER/ON/DCA from a desired input channel, for signals sent to the MIX/MATRIX bus or the parameters of signals outputted directly.

Operating the Quick Data Copy function from the OVERVIEW screen or SENDS TO/SENDS FROM popup windows

The controls and corresponding parameters are shown below.

Screen/window	Control	Parameter
OVERVIEW screen	SEND knob	Send level*
	SEND ON/OFF button	Send on/off
SENDS TO popup window	SEND LEVEL knob	Send level*
	SEND PAN/BALANCE knob	Pan/balance
	SEND ON button	Send on/off
	PRE button	Send Point
SENDS FROM popup window	SEND LEVEL knob	Send level*
	SEND PAN/BALANCE knob	Pan/balance
	SEND ON button	Send on/off
	PRE button	Send Point
SENDS TO popup window	FOLLOW setting buttons	Settings to follow the FADER/ON/DCA
SENDS FROM popup window		

*Overlay offset values will not be copied.

1 On the OVERVIEW screen, hold down the [SHIFT] key and press the SEND LEVEL knob or the SEND ON/OFF button.

The “PARAMETER COPY popup window” (p.556) appears.

2 Select the copy destination and press the EXECUTE button.

The parameters will be copied to the selected channel numbers. To cancel the copy operation, press the CANCEL button instead of EXECUTE.

PARAMETER COPY popup window



This window contains the following items.

- 1 Copy source display**
Indicates the copy source channel (as well as the send-destination bus) and its parameter values.
- 2 Copy destination selection knob**
Selects the copy destination channel (or the send-destination bus).
- 3 SELECT ALL button**
Sets all channels (or send-destination buses) as the copy destination.
- 4 REVERT button**
Returns the copy destination to the screen status when the PARAMETER COPY popup window is displayed.
- 5 EXECUTE button**
Copies the parameter and closes the window/screen.
- 6 CANCEL button**
Cancels the copy operation and closes the window/screen.

Operating the Quick Data Copy function from the HPF/EQ and DYNAMICS 1/2 popup windows

The controls and corresponding parameters are shown below.

Screen/window	Control	Parameter
HPF/EQ popup window	EQ type select button	EQ type
DYNAMICS 1/2 popup window	Dynamics processor type button	Dynamics processor type
INSERT/D.OUT popup window (12CH/D.OUT)	FOLLOW setting buttons	Settings to follow the FADER/ON/DCA

1 On the HFP/EQ popup window, press the EQ type switch button while holding the [SHIFT] key.

The “PARAMETER SET popup window” (p.558) appears.

2 Select the copy destination and press the EXECUTE button.

The parameters will be copied to the selected channel numbers. To cancel the copy operation, press the CANCEL button instead of EXECUTE.

PARAMETER SET popup window

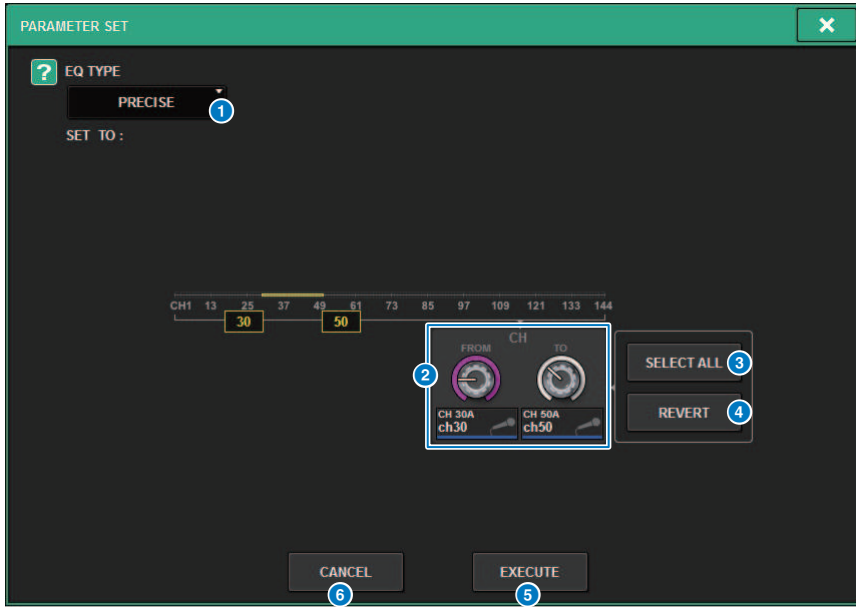

This window contains the following items.

- 1 Copy source type**
Displays the type to copy. You can switch the type as needed.
- 2 Copy destination selection knob**
Selects the copy destination channel number.
- 3 SELECT ALL button**
Sets all channels as the copy destination.
- 4 REVERT button**
Clears the SELECT ALL button settings.
- 5 EXECUTE button**
Copies the parameter and closes the window/screen.
- 6 CANCEL button**
Cancels the copy operation and closes the window/screen.

Operating the Quick Data Copy function from the SELECTED CHANNEL VIEW and TO STEREO popup windows

The controls and corresponding parameters are shown below.

Screen/window	Control	Parameter
TO ST field in the SELECTED CHANNEL VIEW window	TO ST A/B button	STEREO A/B on/off
TO STEREO popup window		

1 On the SELECTED CHANNEL VIEW window, press the TO ST A/B button while holding the [SHIFT] key.

The “PARAMETER SET popup window” (p.560) appears.

2 Select the copy destination and press the EXECUTE button.

The parameters will be copied to the selected channel numbers. To cancel the copy operation, press the CANCEL button instead of EXECUTE.

PARAMETER SET popup window

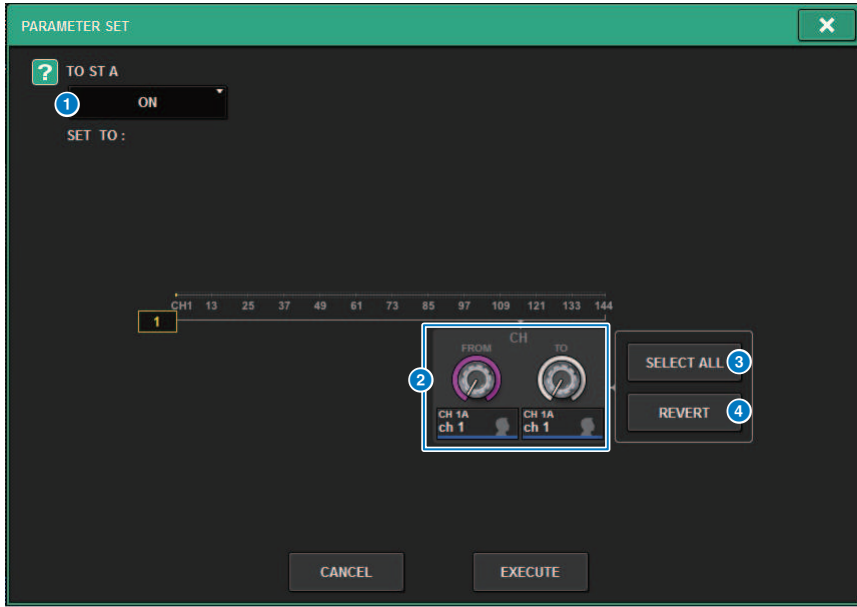

This window contains the following items.

- 1 Set parameter**
Selects the parameter (ON/OFF) to set.
- 2 Setting destination selection knob**
Selects the channel number for the parameter to set.
- 3 SELECT ALL button**
Sets all channels as the copy destination.
- 4 REVERT button**
Clears the SELECT ALL button settings.

Controlling via the TO STEREO section

The TO STEREO buses are used for outputting signals to the main speakers.

- 1** Verify that an input source is connected to the channel that you are controlling, and set the head amp's phantom power, gain, and phase to obtain the optimal input signal.
- 2** Press the TO STEREO field knob in the OVERVIEW screen of the input channel or MIX channel whose signal you want to send to the STEREO A bus and STEREO B bus, or press the knob in the TO STEREO field of the SELECTED CHANNEL VIEW screen.
The TO STEREO popup window appears.
- 3** Use the ST/LCR mode select button to select either ST mode or LCR mode for each channel.
- 4** In the channel strip section of the top panel, verify that the [ON] key is turned on for the input channel or MIX channel that you want to operate, and then raise the fader to an appropriate position.
- 5** Press the top panel TO ST [A]/[B] key to turn it on.
- 6** In the channel strip section of the top panel, verify that the [ON] key is turned on for the STEREO channel that you want to operate, and then raise the fader to an appropriate position.

TO STEREO section

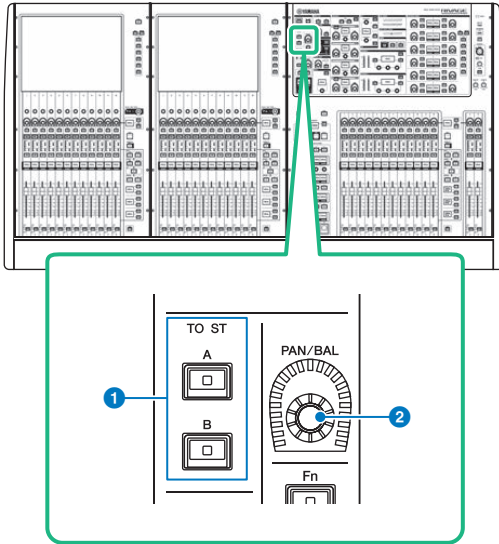

1 TO ST [A]/[B] keys

Switch on or off the signal sent from the input channel to stereo bus A or B.

2 [PAN/BAL] knob

Sets the panning/balance of the signal sent to the stereo buses.

ST mode and LCR mode

The STEREO buses are used for outputting signals to the main speakers. Signals can be sent to a STEREO bus in one of two modes, ST mode or LCR mode, and you can make this selection individually for each channel. These modes differ in the following ways.

ST mode

This method allows an input channel or MIX channel to individually send independent signals to the STEREO A bus and STEREO B bus.

- The signals sent to the STEREO A bus and STEREO B bus can be switched on or off individually.
- The pan of the signal sent from the input channel or MIX channel to L/R of the STEREO A bus or STEREO B bus is controlled by the TO ST PAN knob.

About MONO

By using the L/R PATH pull-down menu in the SELECTED CHANNEL VIEW screen, STEREO B can be set to MONO. If it is set to MONO, the same signal will be output to L and R of STEREO B.



L/R PATH pull-down menu in the SELECTED CHANNEL VIEW screen

L/R PATH pull-down menu in the SELECTED CHANNEL VIEW screen

LCR mode

This method allows an input channel or MIX channel to send its signals to the three buses: STEREO A (L and R) and STEREO B (C) simultaneously.

- The signals sent to the STEREO A bus and STEREO B bus can be switched on/off together.
- The level difference between the signals sent from the input channel or MIX channel to the STEREO A (L and R) buses and to the STEREO B (C) bus is controlled by the CSR (center/side ratio) knob.
- The level of the signal sent from the input channel or MIX channel to the STEREO A (L and R) buses and the STEREO B (C) bus will change according to the settings of the TO ST PAN knob and the BALANCE knob.

CH Parameter > ST mode and LCR mode

NOTE

- When using LCR mode, set STEREO B to MONO.
- STEREO B is used as the CENTER channel.

Sending a signal to a STEREO bus

- 1** Verify that an input source is connected to the channel that you are controlling, and set the head amp's phantom power, gain, and phase to obtain the optimal input signal.
- 2** Access the TO STEREO popup window, either by pressing the TO STEREO field knob in the OVERVIEW screen of the input channel or MIX channel whose signal you want to send to the STEREO A bus and STEREO B bus, or by pressing the knob in the TO STEREO field of the SELECTED CHANNEL VIEW screen.

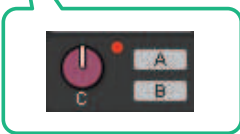

TO STEREO field in the OVERVIEW screen

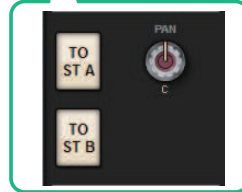

TO STEREO field in the SELECTED CHANNEL VIEW screen

The TO STEREO popup window appears.

- 3** Use the ST/LCR mode select button to select either ST mode or LCR mode for each channel.
- 4** In the channel strip section of the top panel, verify that the [ON] key is turned on for the input channel or MIX channel that you want to operate, and then raise the fader to an appropriate position.
- 5** Press the top panel TO ST [A]/[B] key to turn it on.

- 6 In the channel strip section of the top panel, verify that the [ON] key is turned on for the STEREO channel that you want to operate, and then raise the fader to an appropriate position.**

TO STEREO popup window



This window contains the following items.

1 Channel select button

Displays the channel. Press this button to select the on-screen selected channel. The current channel icon, number, and color appear on the button, and the channel name appears below the button.

2 ST/LCR mode select button

Press this to switch the mode between ST and LCR. The currently selected mode is highlighted.

3 TO ST A button

Turns the signal sent to the STEREO A bus on and off.

4 TO ST B button

Turns the signal sent to the STEREO B bus on and off.

5 TO ST PAN/TO ST BALANCE knob

For a MONO channel, this knob functions as a PAN knob that adjusts the left/right position of the signal sent to the STEREO bus. For a STEREO channel, this knob functions as a BALANCE knob that adjusts the volume balance of the left/right signals sent to the STEREO bus. To edit a value, press a knob to select it, and then use the corresponding screen encoder.

6 Σ clipping indicator

This indicator lights to indicate that a signal is clipped at some point in the channel.

NOTE

This is also shown for MATRIX channels that do not have a stereo send

If the ST/LCR mode select button is set to LCR mode, the following button and knob will be shown instead of the TO ST A button (3), and TO ST B button (4).



7 LCR button

Switches all signals sent from the channel to the STEREO bus on and off. If this button is off, the corresponding channel will send no signals to the STEREO bus.

8 CSR knob

Adjusts the ratio of the signal level sent from the channel to the STEREO A (L and R) buses and the signal level sent to the STEREO B (C) bus, in a range of 0–100%. To edit a value, press a knob to select it, and then use the corresponding screen encoder.

In the case of a MIX channel, the following pull-down menu is shown above the ST/LCR select button.



9 TO STEREO send point

Allows you to select the send point as PRE FILTER, PRE EQ, PRE DYNA, PRE DELAY, PRE FADER, or POST FADER.

In the case of a STEREO bus MIX channel, the following button is displayed.



10 PAN/BALANCE select button

This button selects whether the volume balance (BALANCE) or the pan (PAN) of the signal sent to the STEREO bus will be adjusted.

11 NOMINAL select button

Selects either LR NOMINAL or CENTER NOMINAL.

When this is on and LR NOMINAL is selected, the center of the mono channel is set to -3 dB and the LR sweep is set to 0 dB.

The default (CENTER NOMINAL) mono channel center is 0 dB and +3 dB for LR sweep.

Signal flow

A signal flow window enables you to view the entire signal flow of a single channel. You can also specify the insert points, delay point, and direct out point in this window. In addition, you can view the location within the signal flow at which clipping may have occurred.

1 Press the [VIEW] key to access the SELECTED CHANNEL VIEW screen.



2 Press the SIGNAL FLOW popup button.

The "SIGNAL FLOW popup window" (p.571) appears.

3 Review the signal flow.

4 If necessary, review the levels and the location of each insert point.

The settings in this window link with the settings in the INSERT/D.OUT popup window and the DELAY popup window.

SIGNAL FLOW popup window

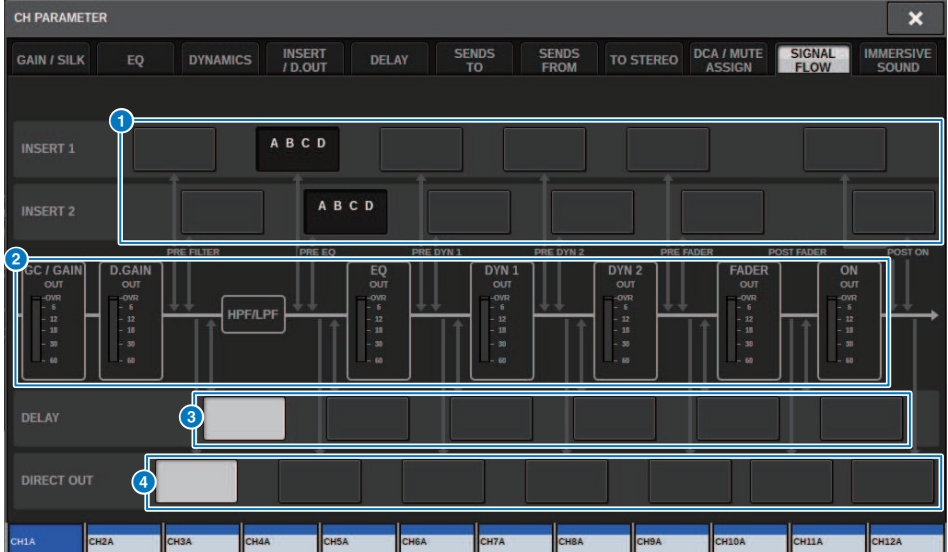

This window contains the following items.

1 Insert point select buttons

Enable you to select insert points. The following indicators indicate the status of the corresponding insert point:



A plug-in, GEQ/PEQ, or outboard unit is inserted at the insert point.

Bypassed.

Level indicator

Green: -18 dB or lower

Yellow: higher than -18 dB to 0 dB or lower

Red: higher than 0 dB and clipping

2 Level meters

These meters indicate the levels at various points in the signal flow. Levels are detected at the following locations.

INPUT

- GC GAIN OUT (immediately after the analog gain)
- D.GAIN OUT (immediately after the digital gain)
- EQ OUT (immediately after the EQ)
- DYN1 OUT (immediately after the dynamics 1)
- DYN2 OUT (immediately after the dynamics 2)
- FADER OUT (immediately after the fader)
- ON OUT (immediately after the channel ON)

OUTPUT

- BUS OUT (immediately after the bus)
- EQ OUT (immediately after the EQ)
- DYN OUT (immediately after the dynamics)
- DELAY OUT (immediately after the delay)
- FADER OUT (immediately after the fader)
- ON OUT (immediately after the channel ON)

3 DELAY POINT select buttons (input channels only)

Enable you to select the delay insert point.

4 DIRECT OUT POINT select buttons (input channels only)

Enable you to select the direct out point.

Channel Job

About DCA/Mute groups library

The RIVAGE PM series provides 24 DCAs and 12 mute groups. A group name can be assigned to each DCA and mute group.

DCA

DCA 1 – 24 can be used with both input channels and output channels. Both types of channel can exist in the same group.

NOTE

DCA settings can be saved and recalled using the dedicated library. The library contains channel information for the channels that belong to the DCA, and the name and color of the DCA.

- **DCA Cue**

All channels assigned to a DCA can be cued simultaneously.

- **DCA Unity**

Allows you to monitor the corresponding DCA at unity gain (the same level as when the DCA fader is set to 0 dB).

- **DCA ROLL-OUT**

The channels belonging to the DCA are temporarily assigned to the panel faders, allowing them to be operated individually.

Mute groups

Mute groups 1 – 12 can be used with both input channels and output channels. Both types of channel can exist in the same group.

- **Mute Safe**

Specific channels that belong to a mute group can be temporarily excluded from mute group operations.

- **Mute Dimmer**

A fixed amount of attenuation can be specified for each mute group.

NOTE

Mute settings can be saved and recalled using the dedicated library. The library contains channel information for the channels that belong to the mute group, and the name of the mute group.

About DCA

The RIVAGE PM series features 24 DCAs that enable you to control the level of multiple channels simultaneously. It includes the following features:

- DCA1–24 can be used for all input channels and all output channels.
- Both input channels and output channels can be assigned to the same group at the same time.
- All channels assigned to a DCA can be cued simultaneously.
- You can monitor the corresponding DCA at unity gain (which is equivalent to the level obtained when the DCA fader is set to 0 dB).
- All channels assigned to a DCA can be temporarily recalled (rolled out) on the panel and controlled individually (DCA ROLL-OUT).

There are two ways to assign a channel to a DCA.

- You can select a specific DCA first and then specify the channels to be assigned to the group, or
- You can select specific channel and then specify a DCA to which it should be assigned.

NOTE

DCA settings are saved as part of the scene.

Assigning channels to a DCA (Selecting the channels that will belong to a specific DCA)

1 Press the CH JOB button on the menu bar, and then select DCA GROUP ASSIGN.

When you select DCA GROUP ASSIGN, the DCA/MUTE ASSIGN window (ALL DCA) appears.



2 Use the DCA select buttons to select the DCA to which you want to assign channels.

3 Press the DCA assign popup field.

The “DCA GROUP ASSIGN window (ALL DCA)” (p.581) appears.

4 In the DCA GROUP ASSIGN window, select the channels that will be assigned to a DCA (multiple selections are allowed).

5 Assign channels to other DCAs in the same way.

NOTE

You can assign a single channel to more than one DCA. In this case, the value will be the sum of the levels of all assigned DCA faders.

6 When you finish assigning the channels, press the CLOSE button to close the popup window.

The DCA/MUTE ASSIGN field of the OVERVIEW screen indicates the DCA(s) to which each channel is assigned. Indicators that are lit yellow in the upper and middle row of this field indicate the DCAs to which the corresponding channel belongs.

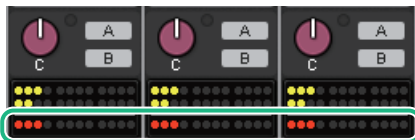

Assigning channels to a DCA (Selecting the DCAs to which a specific channel will belong)

- 1 Press the DCA/MUTE ASSIGN field on the OVERVIEW screen, or press the DCA/MUTE ASSIGN field on the SELECTED CHANNEL VIEW screen.**



DCA/MUTE ASSIGN field on the OVERVIEW screen

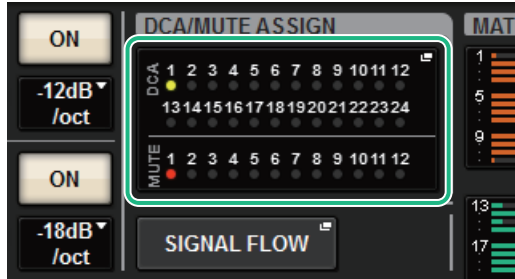

DCA/MUTE ASSIGN field

The DCA/MUTE ASSIGN (1CH) popup window appears.

- 2 Use the channel select +/- buttons to select the channel you want to assign to the group.**
- 3 Press a DCA ASSIGN button(s) to select the DCA(s) to which the currently-selected channel will be assigned (multiple selections are allowed).**
- 4 Select the DCA(s) for other channels in the same way.**

Using DCAs

- 1 Assign input channels and output channels to a DCA.**
- 2 Using the faders in the Channel Strip section of the top panel, adjust the relative balance between the input channels and output channels that belong to the DCA you want to use.**
- 3 Press to illuminate the [DCA] key so that you will be able to control the DCA.**
- 4 In the Channel Strip section, operate the fader corresponding to the DCA you want to use.**

The level of the channels assigned to that DCA will change while preserving the level differences you established in step 2.

NOTE

Operating a DCA fader will not cause the input faders to move in tandem.

- 5 To switch a DCA on/mute, press the [ON] key for that DCA.**

When you press an [ON] key to make the key indicator go dark, the [ON] key for each channel assigned to that DCA will flash, and these channels will be muted (the same state as when the faders are lowered to the $-\infty$ dB position).

- 6 To cue-monitor a DCA, press the [CUE] key for that DCA.**

When you press the [CUE] key to make the key indicator light, the [CUE] keys for the channels assigned to that DCA will blink, and cue monitoring will be enabled. For more information about cue, refer to the following section.

Please refer to “Using the Cue function” (p.419).

NOTE

You can also press the [DCA], [DCA 1-8], or [DCA 9-16] key in the Channel Strip section to select the DCA that you want to control.

Viewing the list of DCA status on the OVERVIEW screen

The OVERVIEW screen enables you to view the list of DCA status and make Recall Safe and other settings. Press the [VIEW] key to switch to the OVERVIEW screen, and then press the [DCA] key on the top panel to select the DCA layer.



1 ISO button

If this button is on, the selected DCA will be unaffected by scene/library recall operations (Isolate mode).

2 R.SAFE button

Switches Recall Safe on/off for the selected DCA.

3 buttons (PM Editor only)

If there are 12 or more channels that are assigned to the corresponding DCA, use these buttons to view every channel that belongs to that DCA.

NOTE

You can also access the corresponding DCA GROUP ASSIGN window by pressing the DCA [SEL] key while holding down the [SHIFT] key.

These buttons do not appear on the control surface. Use the corresponding screen encoder to scroll.

Using DCAs

Use the Channel Strip section to control the DCAs.

Level adjustment: fader

You can adjust the level of the channels assigned to that DCA while preserving the relative level differences among the channels. The channel fader operation will not be linked at this time.

Toggling between on and mute: [ON] key

When you press an [ON] key in the Channel Strip section to make the key indicator go dark, the [ON] key for each channel assigned to that DCA will flash, and these channels will be muted (the same state as when the faders are lowered to the $-\infty$ dB position).

NOTE

While DCA is muted, these DCA channels will not be muted if the send point for MIX/MATRIX SENDS is set to PRE. If it is set to POST, these channels will be muted.

Cue monitoring: [CUE] key

When you press a [CUE] key in the Channel Strip section to make the key indicator light, the [CUE] keys for the channels assigned to that DCA will blink, and cue monitoring will be enabled. For more information about cue, please refer to “Using the Cue function” (p.419).

DCA ROLL-OUT

All channels assigned to a DCA can be temporarily recalled (rolled out) to other bays and controlled individually.

You can use the Preferences settings to change how the channels will rolled out.

DCA ROLL-OUT operation

1 Press the [DCA] key on the top panel to select the DCA layer.

2 Press the [SEL] key for the DCA you want to roll out.

The corresponding channels will be rolled out on the panel according to the DCA ROLL-OUT setting in PREFERENCES.

3 To exit from ROLL-OUT mode, select a different bank, or press the [SEL] key again for the same DCA.

NOTE

- You cannot turn Roll-out mode on while operating a DCA (for example, while assigning channels or editing the group name).
- If the number of channels assigned to a DCA exceeds the number of faders in the block (that is a roll-out target), you will be unable to control extra channels.
- If the number of channels assigned to a DCA exceeds the number of faders on a particular bay for roll-out, you will be able to scroll extra channels to the left or right inside the block using the channel strip encoder or screen encoder (only on bay L or C). While you are turning the knob, a message “DCA ROLLOUT: DCA members scrolling” will appear on the bottom of the touch screen or external monitor screen.

Rolling-out channels using the DCA Roll-out function

You can use the Preferences settings to change how the channels will rolled out.

The SEL LINK and No. OF BAYS TO USE settings will determine which bay will be used for the roll-out.

- If you use the DCA ROLL-OUT function on a bay that is not linked in the SEL LINK section, channels will be rolled out only on that bay.
- If you use the DCA ROLL-OUT function on a bay that is linked to another bay in the SEL LINK section, channels will be rolled out on that bay and its linked bay. The No. OF BAYS TO USE parameter in the PREFERENCES settings will determine the number of bays on which to roll out the channels.

NOTE

You cannot use the DCA ROLL-OUT function on multiple bays simultaneously. If you try to do so, the message “Only one DCA can be rolled out at one time” will appear near the bottom of the touch screen or external monitor screen.

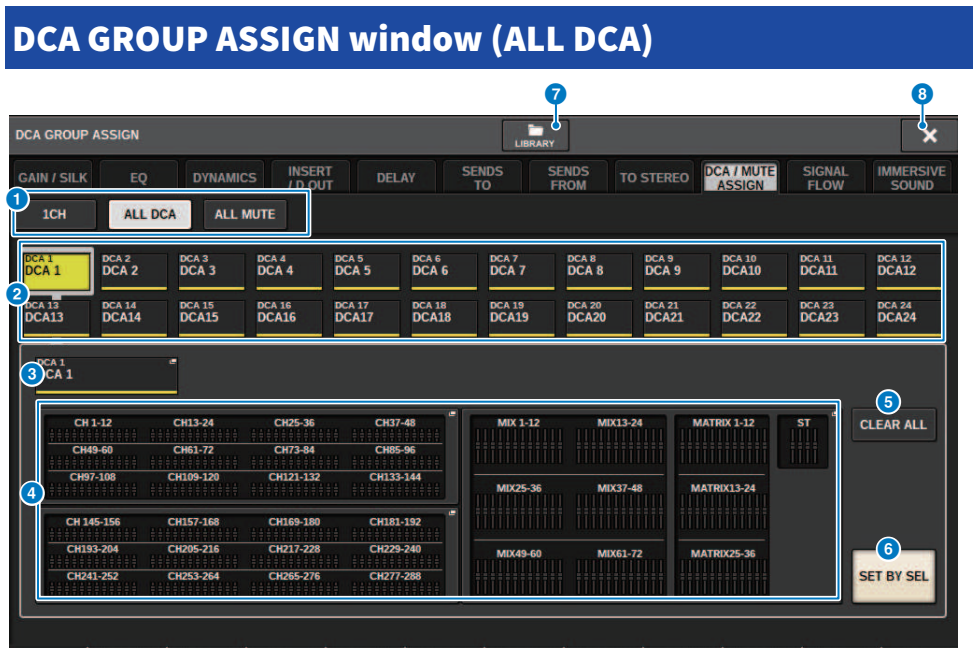

- 1 Tabs**
Use these tabs to select 1CH, ALL DCA, or ALL MUTE window.
- 2 DCA select buttons**
Enable you to select a target DCA.
- 3 NAME EDIT popup button**
Indicates the name of the currently-selected DCA. Press this button to display the keyboard window or icon edit window, in which you can edit the DCA name.
- 4 DCA assign popup field**
Highlights in yellow the channels that are assigned to the currently-selected DCA. Press this field to open the assign popup window.
- 5 CLEAR ALL button**
Press this button to clear all selections.
- 6 SET BY SEL button**
If this button is on, you will be able to add a channel by using the corresponding [SEL] key. To select more channels, turn the SET BY SEL button on, and then press the corresponding [SEL] keys for the desired channels.
- 7 LIBRARY button**
Press this button to open the DCA NAME/ASSIGN library window.
- 8 CLOSE button**
Press this button to close the popup window and return to the previous screen.

DCA ASSIGN popup window

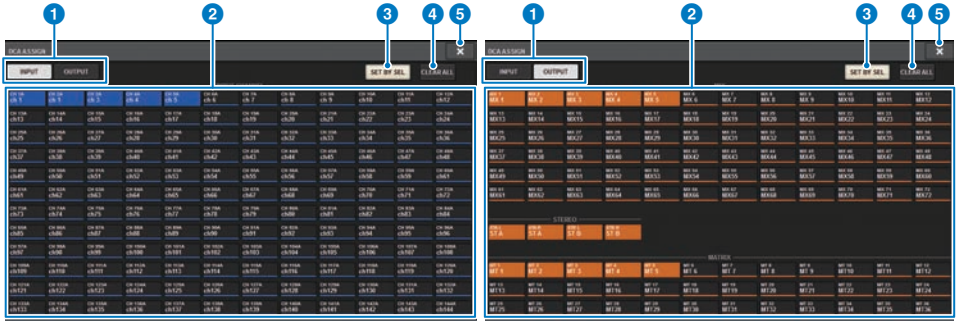

1 Switching tabs

Enable you to switch between the input channel page and output channel page.

2 Channel select buttons

Enable you to select the channels that will be assigned to a DCA.

3 SET BY SEL button

If this button is on, you will be able to select a channel by using the corresponding [SEL] key.

4 CLEAR ALL button

Press this button to clear all selections.

5 CLOSE button

Press this button to close the popup window and return to the previous screen.

DCA/MUTE ASSIGN window (1CH)

This window enables you to view and edit the DCAs to which each channel is assigned.

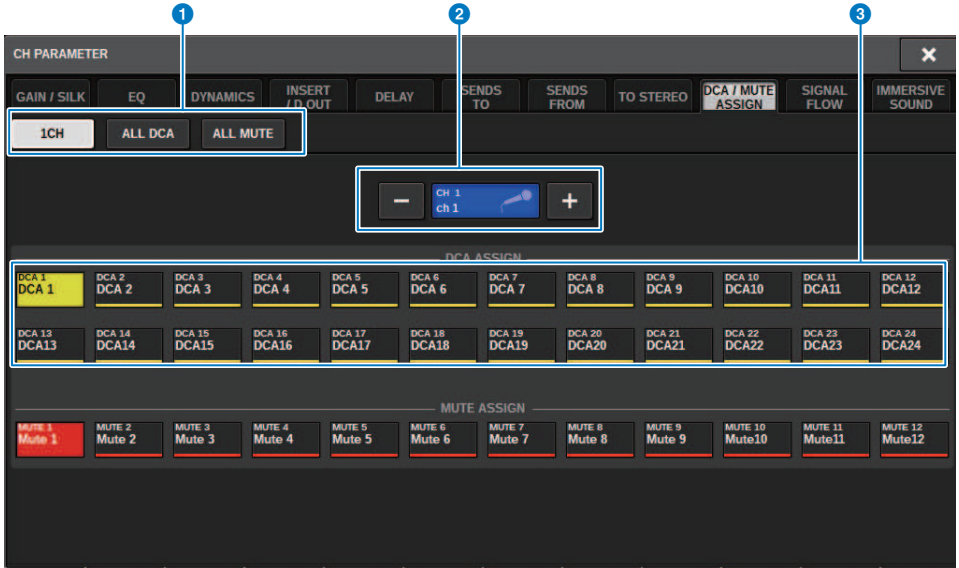

1 Tabs

Use these tabs to select 1CH, ALL DCA, or ALL MUTE window.

2 Channel select +/- buttons

Indicates the currently-selected channel. Press the + button to select the next channel. Press the - button to select the previous channel.

3 DCA ASSIGN buttons

Press a button to assign the selected channel to the corresponding DCA.

About mute groups

The RIVAGE PM series features twelve mute groups. It includes the following features:

- Mute groups 1–12 can be used for all input channels and all output channels.
- Both input channels and output channels can be assigned to the same group at the same time.
- You can temporarily defeat the muted state of an individual channel.
- You can also assign the mute group control function to a USER DEFINED key.
- Although a mute group can be completely muted, using the Dimmer function enables you to adjust attenuation for the mute group.
- The Mute Safe function enables you to exclude (safely) certain channels from mute group operations.
- You can change the name of the mute group control.

As with the DCAs, you can assign channels to mute groups in the following ways.

- You can select a specific mute group first and then specify the channels to be assigned to the group, or
- You can select a specific channel and then specify the mute group to which it should be assigned.

Channel Job > Assigning channels to a mute group (Selecting the channels that will belong to a specific mute group)

Assigning channels to a mute group (Selecting the channels that will belong to a specific mute group)

1 Press the CH JOB button on the menu bar, and then select MUTE GROUP ASSIGN.

When you select MUTE GROUP ASSIGN, the DCA/MUTE ASSIGN window (ALL MUTE) appears.

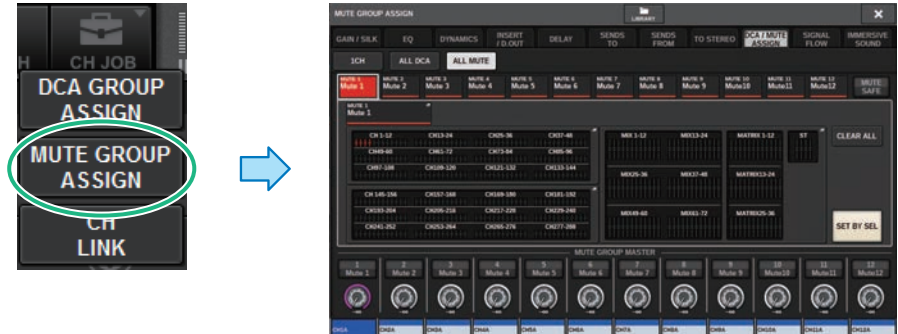

2 Use the MUTE GROUP 1-12 buttons to select the mute group to which you want to assign channels.

3 Press the [SEL] key for the input channels/output channels that you want to assign (multiple selections are allowed).

The [SEL] keys of the assigned channels will light, and the corresponding channels will be highlighted in red in the mute group assign indication field. To cancel an assignment, press a lit [SEL] key once again to make it go dark.

4 Assign channels to other mute groups in the same way.

NOTE

You may assign a single channel to more than one mute group.

5 When you finish assigning the channels, press the CLOSE button to close the popup window.

You will return to the previous screen. The DCA/MUTE ASSIGN field of the OVERVIEW screen indicates the mute group(s) to which each channel is assigned. Indicators that are lit red in the lower line of this field indicate the mute groups to which that channel belongs.

Channel Job > Assigning channels to a mute group (Selecting the channels that will belong to a specific mute group)

NOTE

- You may assign a single channel to more than one mute group.
- If the dimmer level is set to any level other than $-\infty$ dB, these indicators will light orange.

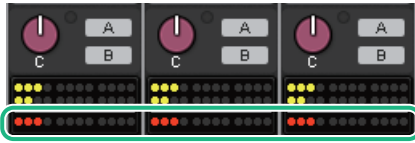

Channel Job > Assigning channels to a mute group (Selecting the mute group to which a specific channel will belong)

Assigning channels to a mute group (Selecting the mute group to which a specific channel will belong)

- 1 Press the DCA/MUTE ASSIGN field on the OVERVIEW screen, or press the DCA/MUTE ASSIGN field on the SELECTED CHANNEL VIEW screen.**



DCA/MUTE ASSIGN field on the OVERVIEW screen

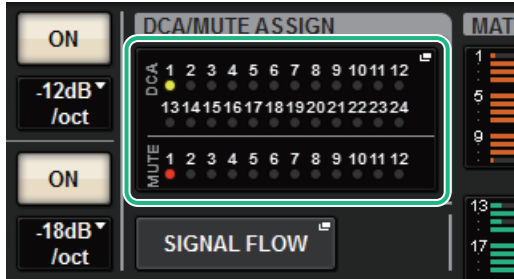

DCA/MUTE ASSIGN field

The “DCA/MUTE ASSIGN window (1CH)” (p.591) appears.

- 2 Use the channel select +/- buttons to select the channel you want to assign to the group.**
- 3 Press a DCA ASSIGN button(s) to select the mute group(s) to which the currently-selected channel will be assigned (multiple selections are allowed).**
- 4 Select the mute group(s) for other channels in the same way.**

Temporarily defeating the Mute function

Temporarily defeating the Mute function

You can temporarily defeat the Mute function for specific channels in a mute group by pressing the corresponding channel [ON] keys. This is possible only when [ON] KEYS BEHAVIOR DURING MUTE is enabled in the Preferences settings.

ON button blinking operation

The ON key for each muted channel in a mute group will blink in the SELECTED CHANNEL VIEW window or in the METER screen.

MUTE GROUP ASSIGN window (ALL MUTE)

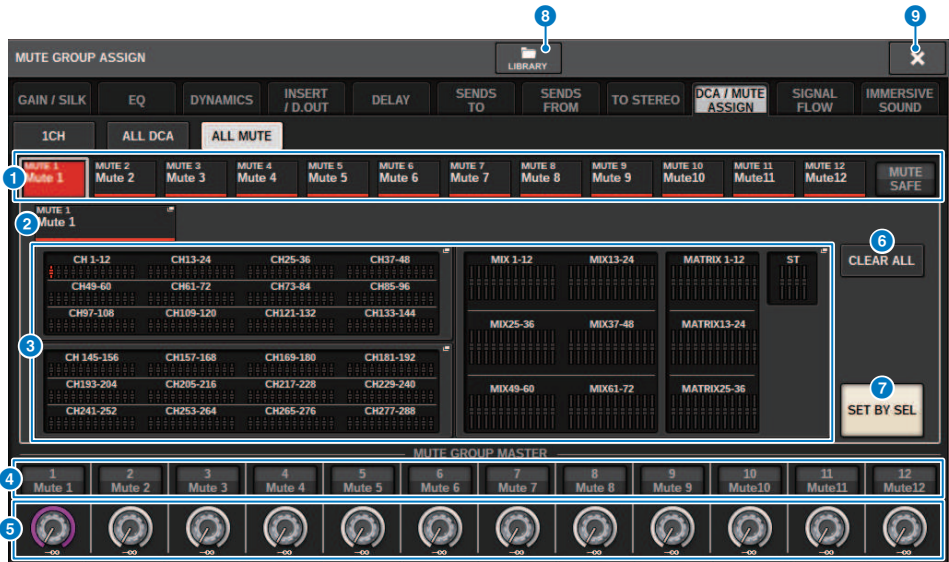

1 MUTE group and MUTE SAFE buttons

Enable you to select a mute group or Mute Safe to which you want to assign channels.

2 NAME EDIT button

Press this button to access a keyboard window, in which you can enter the mute group name.

3 Mute group assign field

This area displays the channels assigned to the currently-selected mute group.

While this window is displayed, press the [SEL] key for the channel that you want to assign to the mute group. The channel will be assigned to the mute group, and the on-screen fader for that channel will turn red. Press the same [SEL] key once again if you want to remove the channel from the group.

If you select the MUTE SAFE button, this field will display the channels that are in Mute Safe status (that is, excluded from the mute groups). The procedure for enabling or cancelling Mute Safe for channels is the same as when assigning or removing channels to or from a mute group.

4 MUTE GROUP CONTROL button

Switches mute on or off for the corresponding mute group.
The [ON] key for each muted channel in a mute group will flash.

5 DIMMER LEVEL knob

Sets the dimmer level for the corresponding mute group when the Dimmer function is enabled.

NOTE

If the dimmer level is set to any level other than $-\infty$ dB, and the corresponding MUTE GROUP CONTROL button is turned on, this button will light orange.

Channel Job > MUTE GROUP ASSIGN window (ALL MUTE)

6 **CLEAR ALL button**

Press this button to clear all selections.

7 **SET BY SEL button**

If this button is on, you will be able to add a channel by using the corresponding [SEL] key. To select more channels, turn the SET BY SEL button on, and then press the corresponding [SEL] keys for the desired channels.

8 **LIBRARY button**

Press this button to open the MUTE NAME/ASSIGN library window.

9 **CLOSE button**

Press this button to close the popup window and return to the previous screen.

DCA/MUTE ASSIGN window (1CH)

This window enables you to view and edit the mute groups to which each channel is assigned.

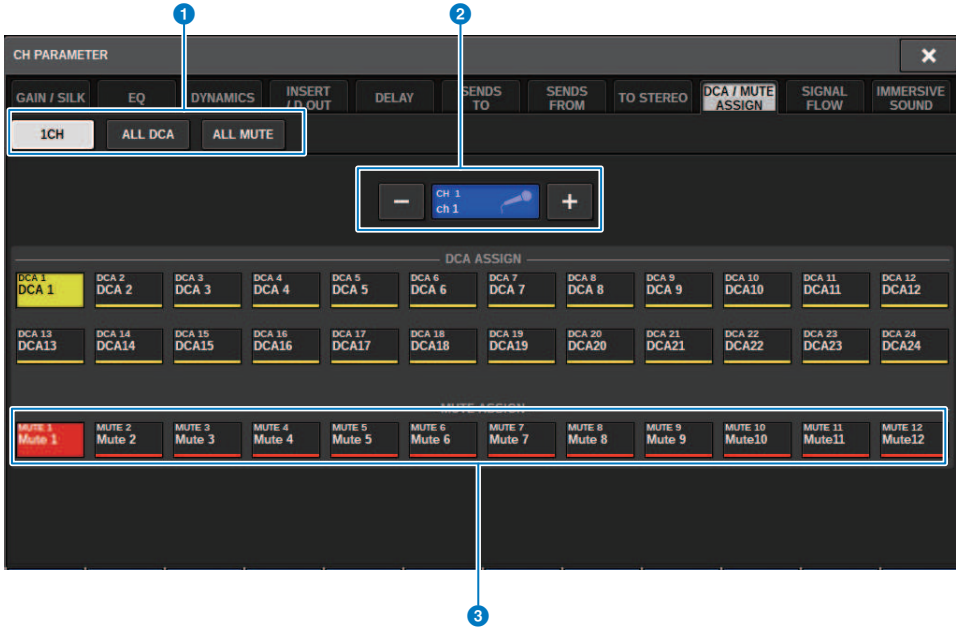

1 Tabs

Use these tabs to select 1CH, ALL DCA, or ALL MUTE window.

2 Channel select +/- buttons

Indicates the currently-selected channel. Press the + button to select the next channel. Press the - button to select the previous channel.

3 MUTE ASSIGN buttons

Press a button to assign the selected channel to the corresponding mute group.

Channel link

Channel link is a function that links the operations (such as fader movements or EQ parameters) of input channels or output channels. Two or more channels that are linked are called a link group. You can create up to 52 link groups for input channels and up to 52 link groups for output channels. The type of parameters to be linked can be individually selected for each link group. However, input channels and output channels cannot coexist in a single link group. While pairing is limited to use on two adjacent channels, the channel link function allows multiple channels to be joined. If you want to link channels provisionally, you can use temporarily link.

- 1 Press the CH JOB button on the menu bar, and then select CH LINK.**



When you select CH LINK, the CH LINK MODE popup window will appear.

- 2 Press an INPUT/OUTPUT button to select the channels that you want to link.**
- 3 Link channels by holding down the the [SEL] key of the link-source channel and pressing the [SEL] key of the link-destination.**
- 4 Using the buttons of the LINK PARAMETER field in the CH LINK MODE screen, select the parameters that you want to link.**
- 5 If a MIX ON, MIX SEND, MATRIX ON, or MATRIX SEND button was turned on in step 4, use the buttons of the SEND PARAMETER field to specify the applicable buses.**
- 6 To close the CH LINK MODE popup window, press the CLOSE button.**

Channel link operations

Channel link operations

- **Linking three or more channels**

Hold down the [SEL] key of the link-source, and successively press the [SEL] keys of the input channels that you want to add to the link group.

- **Adding new channels to an existing link group**

Hold down any [SEL] key within the group, and press the [SEL] keys that you want to add to the group.

- **Canceling a link**

Hold down any [SEL] key that is registered within the same link group, and press the [SEL] key of the channel that you want to remove from the group.

- **Editing the level balance between channels assigned to a link group**

Hold down the [SEL] key of any linked channel, and operate the parameter that you want to edit.

CH LINK popup window

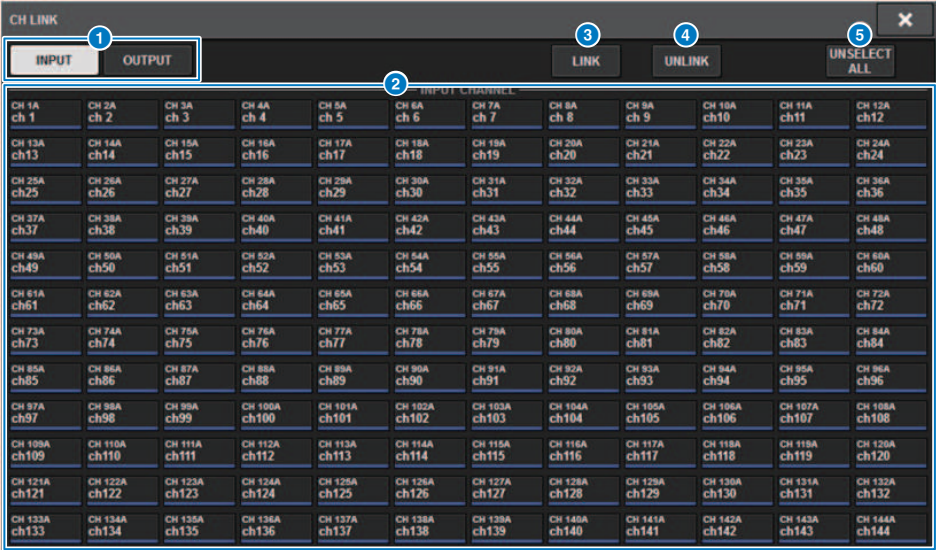

1 INPUT/OUTPUT buttons

These buttons switch between the input channel page and output channel page.

2 Channel select buttons

Use these buttons to select the channels that you want to link. Linked channels will show an alphabetical character that indicates the link group.

NOTE

- When you select a linked channel, all channels of the same group are selected.
- If you want to add a channel to a group, select the group and the channel that you want to add, and then press the LINK button.
- By selecting two groups and pressing the LINK button, you can combine two groups into one group. In this case, the subsequent group is combined into the preceding group. (If you combine group A and group B, the result will be group A.)
- To unlink a channel, select the group and then press the channel that you want to remove, deselecting it.

3 LINK button

Links the channels that you selected in **2**.

4 UNLINK button

Unlinks the channels that you selected in **2**.

5 UNSELECT ALL

Clears all channel selections.

Temporary link

The Temporary link function enables you to link multiple channels temporarily so that you can simultaneously change the settings for only the parameters of the linked channels. This useful function enables you to adjust parameters in real time and more quickly than a copy or recall operation, if you want to apply fader operations or EQ adjustments to multiple channels quickly. This link is not permanent, and only one group of channels can be linked. However, the number of channels in the group is unlimited. Please note that you cannot link input channels and output channels in this temporary link group at the same time.

The following parameters will be linked.

Gain and level settings will change relatively.

Input channels:

- Digital gain and analog gain settings
- Insert on/off and point settings
- Direct out on/off, level, point, and FOLLOW settings
- HPF settings
- LPF settings
- PEQ settings
- Dynamics settings
- Delay settings
- On/off, level, PRE/POST, and FOLLOW settings for signals sent to MIX buses
- On/off, level, PRE/POST, and FOLLOW settings for signals sent to MATRIX buses
- TO STEREO settings
- DCA/MUTE ASSIGN settings
- Fader operations
- [ON] key operations

Output channels:

- Insert on/off and insert point settings
- Direct out on/off, level, point, and FOLLOW settings
- HPF settings
- LPF settings
- PEQ settings
- Dynamics settings
- Delay settings
- On/off, level, PRE/POST, and FOLLOW settings for signals sent to MATRIX buses
- TO STEREO settings
- DCA/MUTE ASSIGN settings
- Fader operations
- [ON] key operations

Configuring a temporary channel link

Press and hold down the [SHIFT] key and press the [SEL] key. Alternatively, press and hold down the [SHIFT] key and press the channel name area located at the bottom of the OVERVIEW screen. The [SEL] keys for the specified channels will flash. The meter area, and the channel name areas in the OVERVIEW screen will be marked by a yellow frame and a link icon.



If you press any [SEL] key, the temporary link will be canceled. Also, if you turn off the power to the unit or load a file, the temporary link will be canceled. In general, scene recall will not cancel the temporary link. However, if the channel pair setting is changed due to a scene recall, the temporary link will be canceled.

Copying channel parameters

You can copy channel mix parameter settings to other channels. When the copy operation is executed, the parameter settings will overwrite those of the copy destination.

You can copy parameter settings between the following channel combinations.

- Between input channels
- Between MIX channels
- Between MATRIX channels
- Between Stereo A and B

NOTE

Analog HA, patch, channel name, and phantom settings will not be copied.

1 Press the CH JOB button on the menu bar, and then select CH COPY.

When you select CH COPY, the CH COPY popup window will appear.

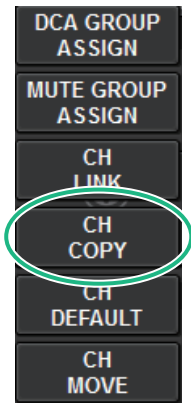

When you select CH COPY, the CH COPY popup window will appear.

2 Select the copy source channel.

Once you select the copy source channel, the system automatically engages a mode that enables you to select the copy destination. The fader graphics for the copy source channel will be highlighted in green.

3 Select the copy destination channel(s) (multiple selections are allowed).

The fader graphics for the copy destination channel(s) will be highlighted in pink.

4 To execute the copy operation, press the PASTE button.

The copy operation will be executed, and the parameter settings will overwrite those of the copy destination(s).

5 To close the CH COPY popup window, press the CLOSE button.

CH COPY popup window

You can register and use eight patterns for the input and output respectively.

CH COPY popup window (input channel)



CH COPY popup window (output channel)



1 Preset button

Enables you to select the preset in which you registered the parameter to copy. Press the selected preset button once more to open the INPUT (OUTPUT) “CH COPY PRESET popup window” (p.601), where you can select the parameters to register in the preset. The settings of the preset button **2** at bottom right are also used as parameter settings that are copied when the “PASTE” key in the Selected Channel section of the panel is pressed.

CH COPY PRESET popup window

INPUT CH COPY PRESET popup window

INPUT CH COPY PRESET[#1]

1 ALL

2

3 WITH PLUGINS

MIX GENERATOR MATRIX SELECT ALL

MIX

MX 1	MX 2	MX 3	MX 4	MX 5	MX 6	MX 7	MX 8	MX 9	MX 10	MX 11	MX 12
MX 13	MX 14	MX 15	MX 16	MX 17	MX 18	MX 19	MX 20	MX 21	MX 22	MX 23	MX 24
MX 25	MX 26	MX 27	MX 28	MX 29	MX 30	MX 31	MX 32	MX 33	MX 34	MX 35	MX 36
MX 37	MX 38	MX 39	MX 40	MX 41	MX 42	MX 43	MX 44	MX 45	MX 46	MX 47	MX 48
MX 49	MX 50	MX 51	MX 52	MX 53	MX 54	MX 55	MX 56	MX 57	MX 58	MX 59	MX 60
MX 61	MX 62	MX 63	MX 64	MX 65	MX 66	MX 67	MX 68	MX 69	MX 70	MX 71	MX 72

OUTPUT CH COPY PRESET popup window

OUTPUT CH COPY PRESET[#1]

ALL ON ALL OFF

1 ALL

2

3 WITH PLUGINS 4 WITH SENDS

MATRIX GENERATOR ALL ON ALL OFF

MATRIX

MT 1	MT 2	MT 3	MT 4	MT 5	MT 6	MT 7	MT 8	MT 9	MT 10	MT 11	MT 12
MT 13	MT 14	MT 15	MT 16	MT 17	MT 18	MT 19	MT 20	MT 21	MT 22	MT 23	MT 24
MT 25	MT 26	MT 27	MT 28	MT 29	MT 30	MT 31	MT 32	MT 33	MT 34	MT 35	MT 36

This window contains the following items.

1 **NAME EDIT button**

Press this button to display the NAME EDIT popup window, where you can edit the preset name.

2 **Parameter buttons**

Turn this on to register the parameters in the preset.

3 **WITH PLUGINS button**

Turn this on to include the plugins inserted into the channel, the patches and the parameters into the content to be copied.

4 **WITH SENDS button**

Turn this on to include all SEND settings (ON/OFF and level, pan, etc.) for that bus (output channel) into the content to be copied.

Moving channel parameters

You can move the settings of a specific input channel to a different input channel. When you execute a move, the channels between the move-source and move-destination are renumbered forward or backward.

NOTE

The channel insert assignment (INSERT OUT (1C)) settings of the SYSTEM CONFIG [DSP] popup window will not move.

1 Press the CH JOB button on the menu bar, and then select CH MOVE.



When you select CH MOVE, the “CH MOVE popup window” (p.605) will appear.

2 Select the move-destination channel(s) (multiple selections are allowed).

The fader graphics for the move-source channel will be highlighted in green.

3 Press the TO button, and then select the move-destination channel.

The fader graphics for the move-destination channel(s) will be highlighted in pink.

4 To execute the move operation, press the MOVE button.

A dialog box will ask you to confirm the operation.

5 Press the OK button.

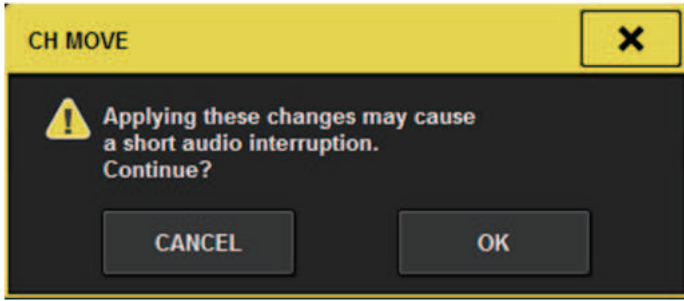

- When you execute CH MOVE, the audio might be interrupted in some cases.

6 To close the CH MOVE popup window, press the CLOSE button.

About CH MOVE

If the channels being moved include channels that are located before the move-destination channels, they are moved after the move-destination channels.

If the channels being moved include channels that are located after the move-destination channels, they are moved before the move-destination channels.

Before move

ch 1	ch 2	ch 3	ch 4	ch 5	ch 6	ch 7	ch 8	ch 9	ch 10
------	------	------	------	------	------	------	------	------	-------

After move

ch 1	ch 3	ch 4	ch 5	ch 7	ch 2	ch 6	ch 9	ch 8	ch 10
------	------	------	------	------	------	------	------	------	-------

Before move

ch 1	ch 2	ch 3	ch 4	ch 5	ch 6	ch 7	ch 8	ch 9	ch 10
------	------	------	------	------	------	------	------	------	-------

After move

ch 1	ch 4	ch 7	ch 9	ch 2	ch 3	ch 5	ch 6	ch 8	ch 10
------	------	------	------	------	------	------	------	------	-------

CH MOVE popup window

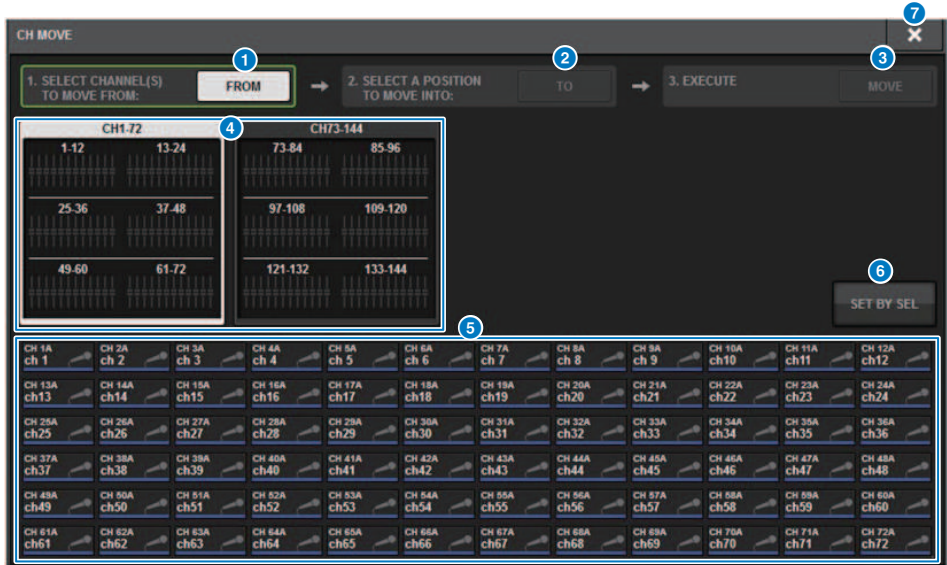

1 FROM button

This button is automatically selected when the CH MOVE popup window opens. Press this button if you want to select a different move-source channel.

2 TO button

Switches to a mode in which you can select the move-destination.

3 MOVE button

After specifying the move-source and destination channels, press this button to execute the channel move operation.

4 Channel display select buttons

Select the type of channels that you want to view on screen. You can select CH1-72 or CH73-144.

5 ASSIGN section

Enables you to select the move-source and destination channels.

6 SET BY SEL button

If this button is on, you will be able to select a channel by using the corresponding [SEL] key.

7 CLOSE button

Press this button to close the popup window and return to the previous screen.

Initializing channel parameters

You can restore the parameters of a channel to an initialized state. This operation can be performed on any channel(s).

NOTE

Analog HA, channel name, patch, and Recall Safe settings will not be initialized.

1 Press the CH JOB button on the menu bar, and then select CH DEFAULT.

When you select CH DEFAULT, the CH DEFAULT popup window will appear.

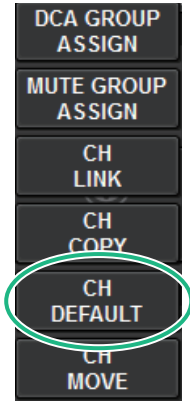

2 Select the channel(s) that you want to initialize (multiple selections are allowed).

The corresponding channel will be highlighted.

3 To execute the initialization, press the DEFAULT button.

A dialog box will ask you to confirm the Initialization operation.

4 Press the OK button in the confirmation dialog box.

The parameters of the selected channel(s) will be initialized.

5 To close the CH DEFAULT popup window, press the CLOSE button.

CH DEFAULT popup window



1 DEFAULT button

After selecting the channel, press this button to execute the initialization operation.

2 Channel display select buttons

Select the type of channels that you want to view on screen. Available options include CH1-72, CH73-144, MIX, and ST/MATRIX.

3 ASSIGN section

Enables you to select the channels for which you want to restore parameters to their initial values.

4 SET BY SEL button

If this button is on, you will be able to select a channel by using the corresponding [SEL] key.

5 CLOSE button

Press this button to close the popup window and return to the previous screen.

Parameters to be copied

The parameters to be copied are shown below.

Parameter	Description
NAME	Channel name, color, icon
ANALOG GAIN	Gain, phantom power on/off, GANG, gain compensation, M/S decode
SILK	SILK settings
PHASE	Ø
DIGITAL GAIN	Gain, GANG
HPF/LPF	On/off, cutoff frequency, type
EQ	On/off, type, attenuator, band settings
DYNA 1	On/off, type, type parameter, key-in (filter, Q, cutoff frequency)
DYNA 2	
INSERT 1	On/off, point
INSERT 2	
MIX SEND	Level, PRE/POST, FOLLOW settings
MATRIX SEND	Level, PRE/POST, FOLLOW settings
DIRECT OUT	On/off, level, point, FOLLOW settings
DELAY	On/off, delay time, point, GANG
FADER	Level
CH ON	On/off
MIX ON	On/off
MATRIX ON	On/off
SURR	Surround settings (on/off, positioning, DIV, LFE)
TO STEREO	TO STEREO settings (on/off, mode, point ¹ , PAN, BALANCE, CSR)
DCA ASSIGN	DCA assign settings
MUTE ASSIGN	Mute assign settings

*1: Output channels only

Settings will be made as follows when the pair setting for the copy source channel and for the copy destination channel differs, in the case where the WITH PLUGINS button is on and plugins are included.

Copy source is a mono channel, and copy destination is a mono channel

Copy source	Copy destination
31BandGEQ	Copy source will be copied and patched (On, Band/Gain, Limit)
Flex15GEQ	Copy source will be copied and patched (On, Band/Gain, Limit)
8BandPEQ	Copy source will be copied and patched (On, Type, Band/Gain, Band/Q, Band/Bypass, Band/Freq., Low Shel., High Shel.)

Copy source	Copy destination
AutoMixer	Open channels will be assigned (parameters will not be copied)
OutBoard	Copy destination is changed to OutBoard (no patching)
Effect	When the copy source is a Dual type, copy and patch (including the parameters and bypass). When the copy source is a Normal type ^{*1} , copy and patch the L side (including the parameters and bypass).
BLANK	Clear the copy destination insert module patch (leave the DSP allocation used by the copy destination)

*1: Except for Dual type and Stereo type

Copy source is stereo (pair), copy destination in stereo (pair)

Copy source	Copy destination
31BandGEQ	Copy source will be copied and patched (On, Band/Gain, Limit) ^{*1}
Flex15GEQ	Copy source will be copied and patched (On, Band/Gain, Limit) ^{*1}
8BandPEQ	Copy source will be copied and patched (On, Type, Band/Gain, Band/Q, Band/Bypass, Band/Freq., Low Shel., High Shel.) ^{*1}
AutoMixer	Two open channels will be assigned (parameters will not be copied)
OutBoard	Copy destination is changed to OutBoard (no patching)
Effect	When the copy source is a Stereo type, copy and patch (including the parameters and bypass). When the copy source is a Normal type ^{*2} , copy and patch the L side (including the parameters and bypass).
BLANK	Clear the copy destination insert module patch (leave the DSP allocation used by the copy destination)

*1: The GEQ link settings for the copy destination will not be changed.

*2: Except for Dual type and Stereo type

Copy source is a stereo (pair) channel, and copy destination is a mono channel

Copy source	Copy destination
31BandGEQ	31-band GEQ of copy source (L side) will be copied and patched (On, Band/Gain, Limit)
Flex15GEQ	Copy source of A side will be copied and patched (On, Band/Gain, Limit)
8BandPEQ	Copy source of A side will be copied and patched (On, Type, Band/Gain, Band/Q, Band/Bypass, Band/Freq., Low Shel., High Shel.)
AutoMixer	One open channel will be assigned (parameters will not be copied)
OutBoard	Copy destination is changed to OutBoard (no patching)

Copy source	Copy destination
Effect	When the copy source is a Stereo type, replace with Dual type, and copy and patch (including the parameters and bypass). When the copy source is a Normal type ^{*1} , copy and patch the L side (including the parameters and bypass).
BLANK	Clear the copy destination insert module patch (leave the DSP allocation used by the copy destination)

*1: Except for Dual type and Stereo type

Copy source is a mono channel, and copy destination is a stereo (pair) channel

*1: The GEQ link settings for the copy destination will not be changed.

Copy source	Copy destination
31BandGEQ	Copy source will be copied and patched to the L and R sides (On, Band/Gain, Limit) ^{*1}
Flex15GEQ	Copy source will be copied and patched to the L and R sides (On, Band/Gain, Limit) ^{*1}
8BandPEQ	Copy source will be copied and patched to the L and R sides (On, Type, Band/Gain, Band/Q, Band/Bypass, Band/Freq., Low Shel., High Shel.) ^{*1}
AutoMixer	Two open channels will be assigned (parameters will not be copied)
OutBoard	Copy destination is changed to OutBoard (no patching)
Effect	When the copy source is a Dual type, replace with Stereo type, and copy and patch (including the parameters and bypass). When the copy source is a Normal type ^{*2} , 1-in/1-out and 1-in/2-out effects will not be copied. The effect will be BLANK. Everything else will be copied and patched to the L and R sides (including parameters and bypasses).
BLANK	Clear the copy destination insert module (leave the DSP allocation used by the copy destination)

*2: Except for Dual type and Stereo type

NOTE

An alert screen will be displayed when copying if a mount or patch operation using the PM Editor or other means cannot be performed, or when there are insufficient resources.

GEQ/PEQ/Automixer

Graphic EQ, parametric EQ and Automixer

The RIVAGE PM series features 31BandGEQ, Flex15GEQ, 8BandPEQ and Automixer. Each type can be used by inserting it in an insert point.

EQ Type	Number usable
31BandGEQ	48
Flex15GEQ	96
8Band PEQ	96
Automixer	1

About using a graphic EQ (GEQ)

31BandGEQ

This is a monaural 31-band GEQ. The bands have a width of 1/3 octave, and the gain can be adjusted in the range of ± 15 dB for each of the 31 bands.

Flex15GEQ

This is a monaural 15-band GEQ. Each band is 1/3 octave wide, and the adjustable gain range is ± 15 dB. The Flex15GEQ enables you to adjust the gain for any fifteen of the same bands as the thirty-one bands of the 31bandGEQ. (Once you have used up fifteen bands of adjustment, you will not be able to adjust the gain of another band until you reset a previously-adjusted band to the flat setting.) The GEQ features a 1/12 oct (121-band) Real Time Analyzer (also called a spectrum analyzer). The range of gain adjustment can be selected from the following: ± 15 dB, ± 12 dB, ± 6 dB (these are valid in both the boost and cut directions), or -24 dB (valid only in the cut direction). If you are using a stereo source, you can link the two GEQ units.

About using a parametric EQ (PEQ)

8BandPEQ

This is a monaural 8-band PEQ. It also features four notch filters. The PEQ features a 1/12 oct (121-band) Real Time Analyzer (also called spectrum analyzer).

NOTE

Notch filters A–D are independent of the PEQ, and thus not affected by the PEQ's BYPASS buttons. You can bypass the PEQ and use only the notch filters.

About Automixer

Automixer

Automixer provides high-clarity sound mixing, and enables you to automatically adjust the microphone input levels when multiple persons are speaking.

DSP resource management for GEQ

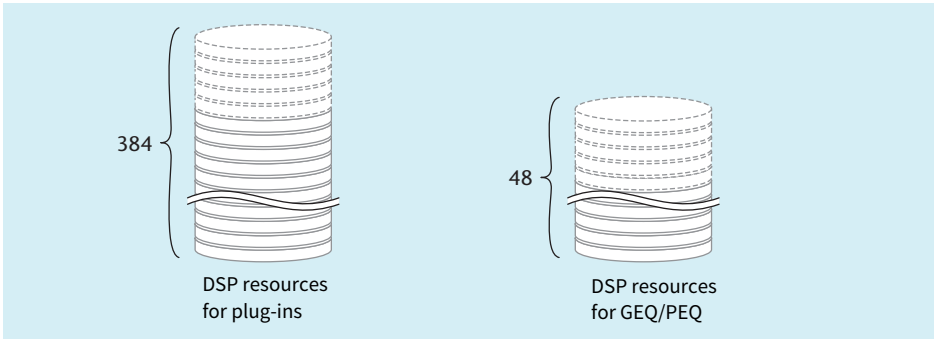

Plug-ins and GEQ/PEQ each feature their dedicated DSP resources. DSP resources are consumed each time a plug-in is mounted or a GEQ/PEQ is inserted. DSP resources usable by plug-ins are divided into 384 units, and the DSP resources that are usable by GEQ/PEQ are divided into 48 units. For details on the DSP resources used by each plug-in or GEQ/PEQ, refer to the data list.

You can view the GEQ resource allocation on the GEQ RACK page.

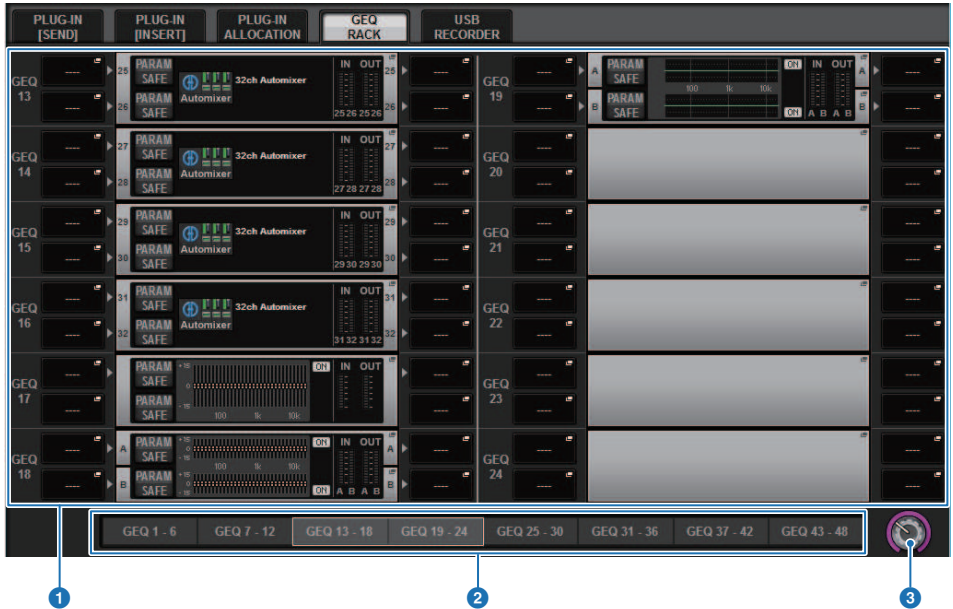

This screen contains the following items.

1 GEQ allocation field

Indicates the GEQ allocation status. You can view 48 available DSP resources.

2 GEQ position bar

Indicates the location of the page associated with the current display of the GEQ allocation field.

3 Page select knob

Use the corresponding screen encoder or the [TOUCH AND TURN] knob to select a page to view.

Inserting a GEQ/PEQ into a channel via the Selected Channel section (CS-R10、CS-R10-S、CSD-R7 only)

This section explains how to insert a GEQ/PEQ into the selected channel for use.

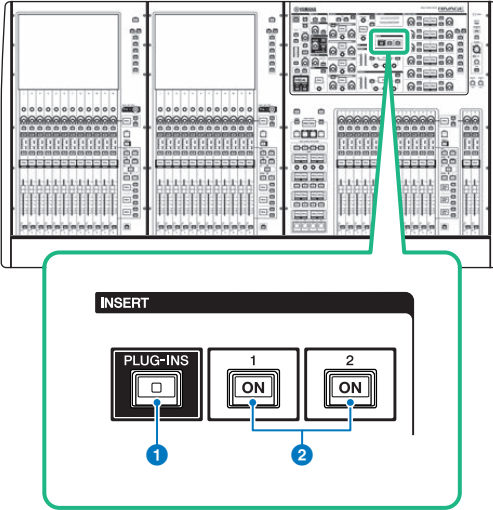

- 1 INSERT [PLUG-INS] key**
Enables you to recall a parameter setting screen for the inserted plug-in.
- 2 INSERT 1/2 [ON] keys**
Switch INSERT1 and INSERT2 on or off respectively.

- 1 Select the channel that you want to operate.**
- 2 Press the INSERT [PLUG-INS] key.**
The “INSERT screen” (p.619) appears.
- 3 Use the INSERT 1/2 switch buttons and INSERT [A]–[D] buttons to select an insert channel and block for which you want to assign the GEQ/PEQ.**

GEQ/PEQ/Automixer > Inserting a GEQ/PEQ into a channel via the Selected Channel section (CS-R10, CS-R10-S, CSD-R7 only)

4 Press the MOUNT popup button to access the MOUNT popup window.



5 Press the GEQ/PEQ tab.

The MOUNT GEQ/PEQ popup window appears.

6 Use the MODULE SELECT buttons to select the item you want to insert, and then press the OK button.

The GEQ_ASSIGNMENT popup window will appear.

7 Rotate the GEQ/PEQ allocation knob to specify the location for GEQ/PEQ (indicated in a pink frame).

8 Press the OK button to allocate GEQ/PEQ.

INSERT screen

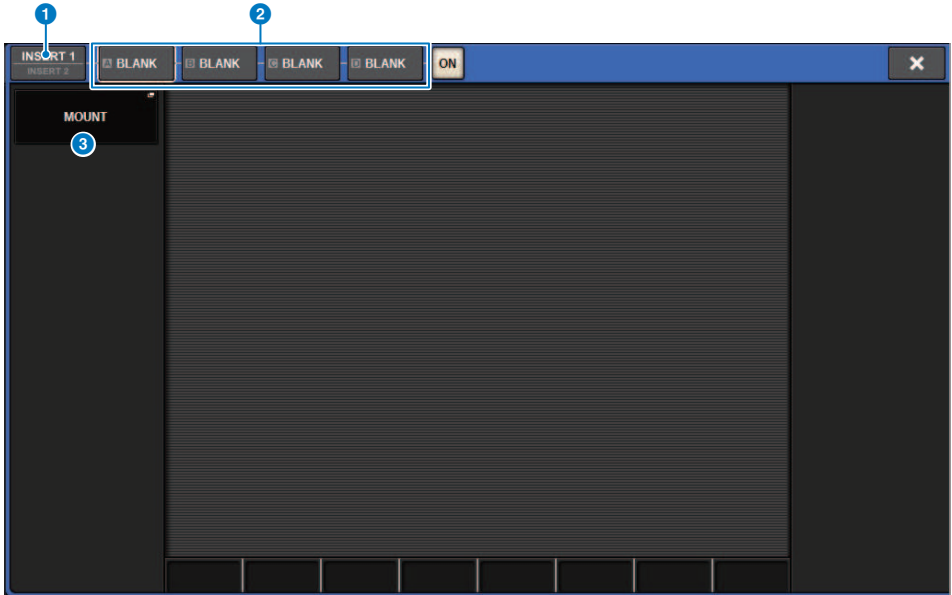

This screen contains the following items.

1 INSERT 1/2 switch buttons

Switches between INSERT1 and INSERT2.

2 INSERT block [A]-[D] buttons

Indicate four plug-ins that have been assigned to INSERT1 and INSERT2 respectively. Press this button to display the edit screen for the assigned plug-in.

3 MOUNT popup button

Press this button to display the MOUNT screen.

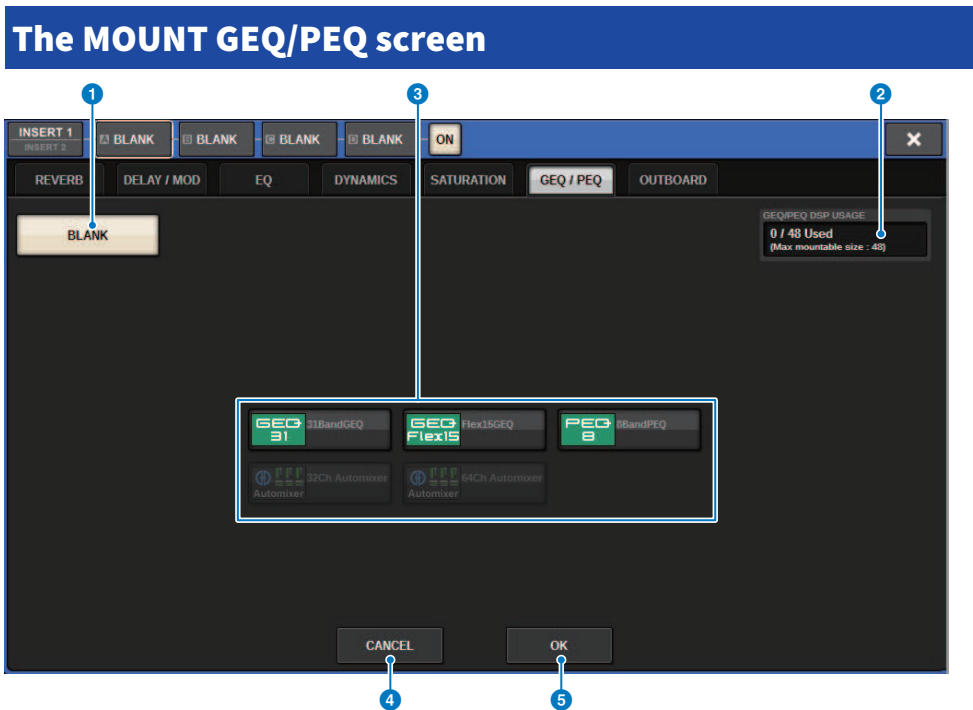

This screen contains the following items.

- 1 **BLANK button**
Defeat the currently-inserted GEQ/PEQ.
- 2 **Used slots indicator**
Indicates the number of slots that are being used.
- 3 **MODULE SELECT**
Use these buttons to select the GEQ or PEQ that will be inserted. Each button has the following function.
 - 31BandGEQ button.....Inserts a 31BandGEQ in the specified channel.
 - Flex15GEQ button.....Inserts a Flex15GEQ in the specified channel.
 - 8Band PEQ button.....Inserts a 8Band PEQ in the specified channel.
- 4 **CANCEL button**
Cancels the changes you made in the INSERT popup window, and closes the window.
- 5 **OK button**
Applies the changes you made in the INSERT popup window, and closes the window.

GEQ ASSIGNMENT popup window

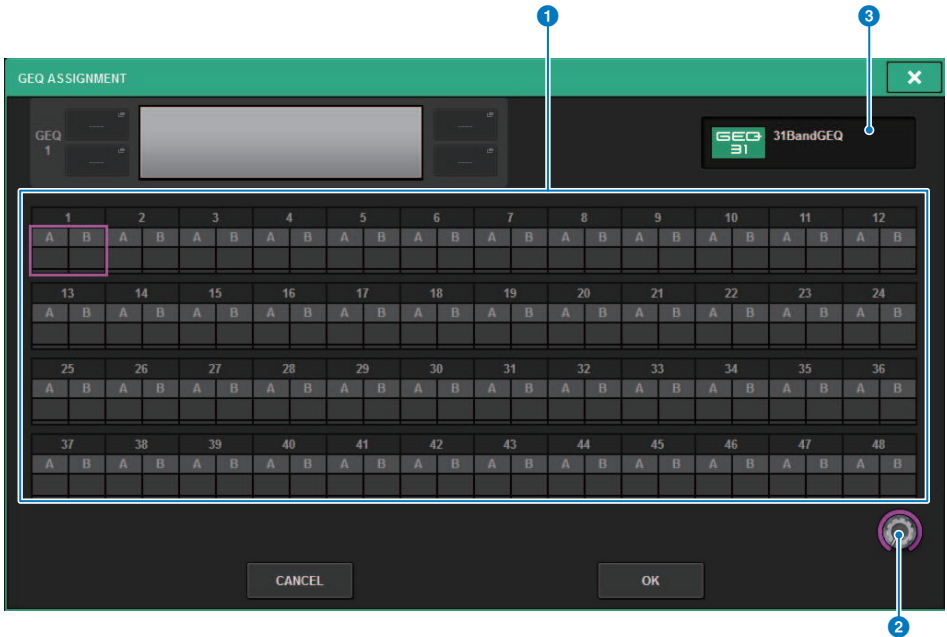

This window contains the following items.

1 GEQ/PEQ allocation field

Indicates the GEQ/PEQ allocation status. You can view 48 available DSP resources at a glance. A location to which you can allocate GEQ/PEQ is indicated in a pink frame. A gray frame means a GEQ/PEQ cannot be allocated to that location.

2 GEQ/PEQ allocation knob

Allocates GEQ/PEQ. You can also allocate them by tapping the touch screens.

3 GEQ/PEQ name

Indicates the name of GEQ/PEQ to be allocated.

Inserting a GEQ/PEQ into a channel via the OVERVIEW screen

1 Press the [VIEW] key to access the OVERVIEW screen.



OVERVIEW screen

2 Press the INSERT/DIRECT OUT field of the channel into which you want to insert the GEQ/PEQ. The INSERT/D.OUT popup window (1CH) will appear.

1 INSERT block [A]–[D] buttons

Indicate four plug-ins that have been assigned to INSERT1 and INSERT2 respectively. Press this button to display the edit screen for the assigned plug-in.

3 Press the INSERT block button to which you want to assign the GEQ/PEQ to access the INSERT screen.

4 Follow steps 4–8 under Inserting a GEQ/PEQ into a channel via the Selected Channel section.

Inserting a GEQ/PEQ into a channel via the SELECTED CHANNEL VIEW screen (CS-R10, CS-R10-S, CSD-R7)

- 1** Select the channel that you want to operate.
- 2** Press the [VIEW] key to access the SELECTED CHANNEL VIEW screen.



INSERT field

SELECTED CHANNEL VIEW screen

- 3** Press the INSERT field to access the INSERT screen.

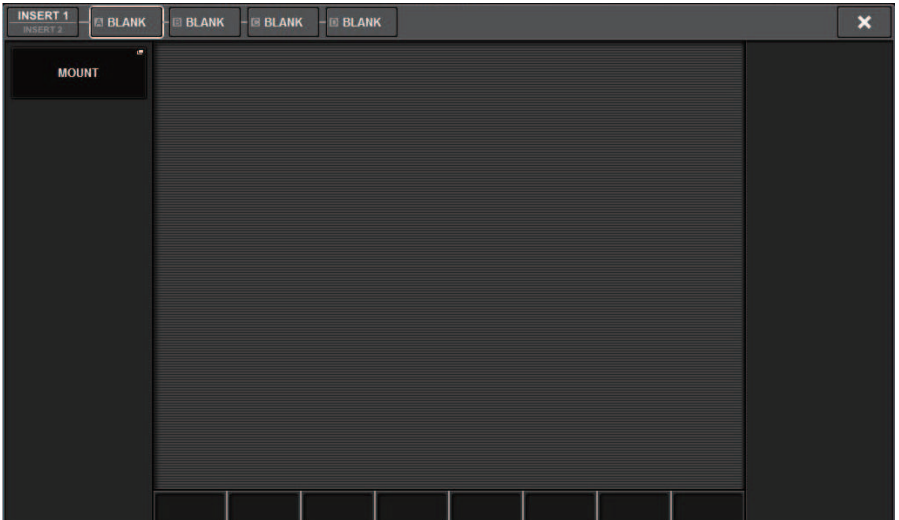

GEQ/PEQ/Automixer > Inserting a GEQ/PEQ into a channel via the SELECTED CHANNEL VIEW screen (CS-R10, CS-R10-S, CSD-R7)

4 Follow steps 4–8 under Inserting a GEQ/PEQ into a channel via the Selected Channel section.

Using the 31BandGEQ

1 Follow steps 1–8 under Inserting a GEQ/PEQ into a channel via the Selected Channel section, insert the 31BandGEQ into a channel.

The system displays the EDIT screen for the GEQ/PEQ that you inserted.

2 If you are using a stereo source, link two GEQ units.

When you press the GEQ LINK button, the following popup window will appear. To enable linking, press any button other than CANCEL. The popup window contains the following items.

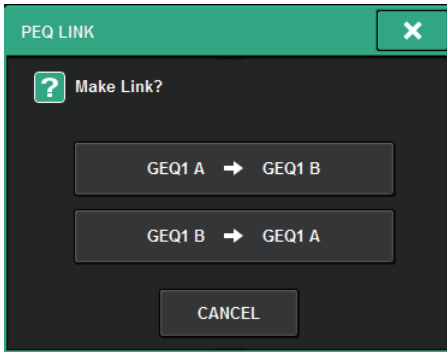

GEQ*A->GEQ*B button

The channel L parameter values will be copied to channel R, and then those parameters will be linked. An asterisk (*) represents the GEQ location.

GEQ*B->GEQ*A button

The channel R parameter values will be copied to channel L, and then those parameters will be linked. An asterisk (*) represents the GEQ location.

CANCEL button

Cancels the link and closes the popup window.

3 Press the GEQ ON/OFF button to turn the 31BandGEQ on.

4 Press one of the buttons in the FADER ASSIGN field to select the group of bands you will control using the faders in the Channel Strip section.

The buttons in the FADER ASSIGN field correspond to the following groups of bands.

20-250: Twelve bands within 20.0Hz–250Hz

80-1k: Twelve bands within 80.0Hz–1.00 kHz

250-3.15k: Twelve bands within 250Hz–3.15 kHz

1.6k-20k: Twelve bands within 1.60kHz–20.0 kHz

When you press one of these buttons, the faders for the bands selected on screen will turn white, and the numbers of the corresponding faders in the Channel Strip section will be displayed. Also, you will be able to use the faders in the Channel Strip section to control the corresponding bands.

NOTE

The above operation is possible even if the Channel Strip section is locked. When you turn off the button in the FADER ASSIGN field, the faders will return to the locked state.

5 Raise the corresponding fader of the Channel Strip section.

The corresponding frequency region will be boosted or cut.

NOTE

When a fader in the Channel Strip section is set to the center (flat) position, the corresponding [ON] key indicator will turn off. This indicates that the corresponding band is not being modified. If you raise or lower the fader even the slightest amount, the [ON] key will light, indicating that this band is being modified. If you press a lit [ON] key to make it go dark, the corresponding band will immediately return to the flat state.

6 Repeat steps 4 and 5 to adjust each band.

NOTE

If you switch the touch screen display to a different screen or to the GEQ window, the fader assignments in the Channel Strip section will forcibly be defeated. However, if you once again display the same GEQ, the group of bands you had previously been controlling will automatically be assigned to the faders.

7 When you finish making settings, turn off the buttons in the FADER ASSIGN field.

The faders and [ON] keys in the Channel Strip section will return to their previous function.

NOTE

When you close the GEQ popup window, the buttons in the FADER ASSIGN field automatically turn off.

GEQ/PEQ EDIT screen

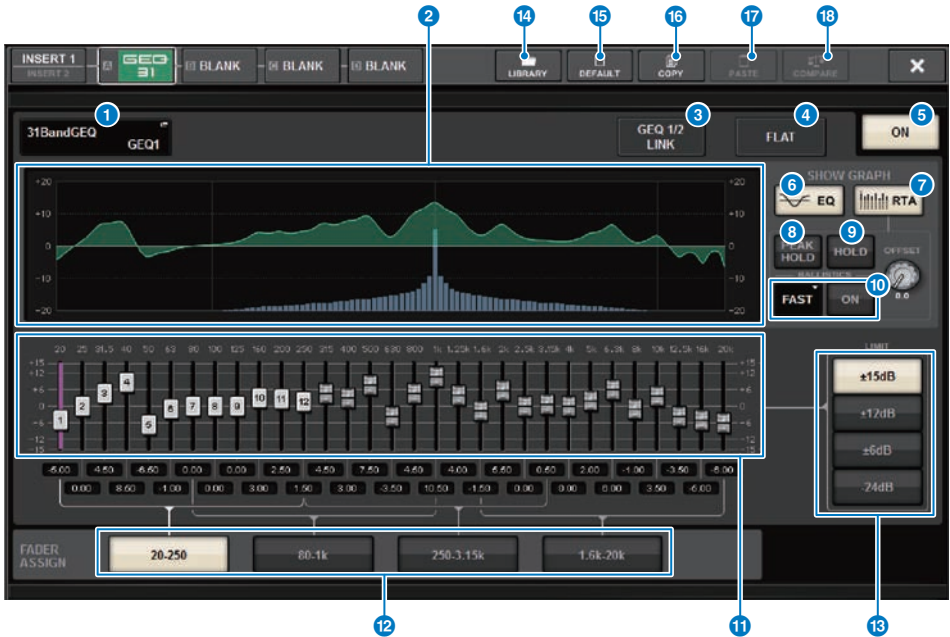

This screen contains the following items.

1 MOUNT GEQ/PEQ popup button

Press this button to access the MOUNT GEQ/PEQ popup window.

2 EQ graph

Indicates the approximate current response of the 31BandGEQ.

3 GEQ LINK button

Press this button to access the GEQ LINK window, in which you can link the GEQ of paired channels.

NOTICE

- The GEQ LINK button appears only for paired GEQs.

4 FLAT button

Press this button to reset the GAIN parameters of all GEQ bands to 0 dB.

5 GEQ ON button

Switches the currently-selected GEQ on or off.

6 EQ button

Press this button to display the EQ graph.

7 RTA button

If this button is on, a semi-opaque frequency analysis graph of the input signal (immediately after EQ) will be superimposed on top of the EQ frequency response graph.

8 PEAK HOLD

If this button is on, the analyzed frequency response graph will hold the peak level indication.

9 HOLD button

If this button is on, the frequency response graph will indicate and hold the result of the frequency analysis.

10 BALLISTICS field

- BALLISTICS button
If this button is on, you will be able to add rate of decay to the analyzed frequency response graph.
- FAST/SLOW switch button
Switches the decay rate of graph rendering (FAST/SLOW).

11 Fader

This fader indicates the boost/cut amounts for each band of the 31-band GEQ. You can check the actual values shown in the numerical boxes below. You can control the faders (that have been selected for operation on the touch screen) by using the screen encoder or the [TOUCH AND TURN] knob.

12 FADER ASSIGN field

In this field you can select the group of bands that will be controlled by the faders in the Channel Strip section.

13 LIMIT select buttons

Enable you to select the range of gain adjustment from the following options: ± 15 dB, ± 12 dB, ± 6 dB (these are valid in both the boost and cut directions), or -24 dB (valid only in the cut direction).

14 LIBRARY button

Press this button to open the GEQ library window.

15 DEFAULT button

Press this button to restore the default parameter setting.

16 COPY button

Copies the selected GEQ settings to buffer memory.

17 PASTE button

Press this button to paste the settings that were copied in buffer memory to the current GEQ. If valid data has not been copied into buffer memory, you will be unable to paste it.

18 COMPARE button

Press this button to switch between the current GEQ settings and the data in buffer memory. If valid data has not been copied into buffer memory, you will be unable to compare the data.

Using the Flex15GEQ

You can use faders 1–12 and [ON] keys in the Channel Strip section to control the Flex15GEQ.

- 1 Follow steps 1–8 under Inserting a GEQ/PEQ into a channel via the Selected Channel section, insert the Flex15GEQ into a channel.**

The system displays the EDIT screen for the GEQ/PEQ that you inserted.

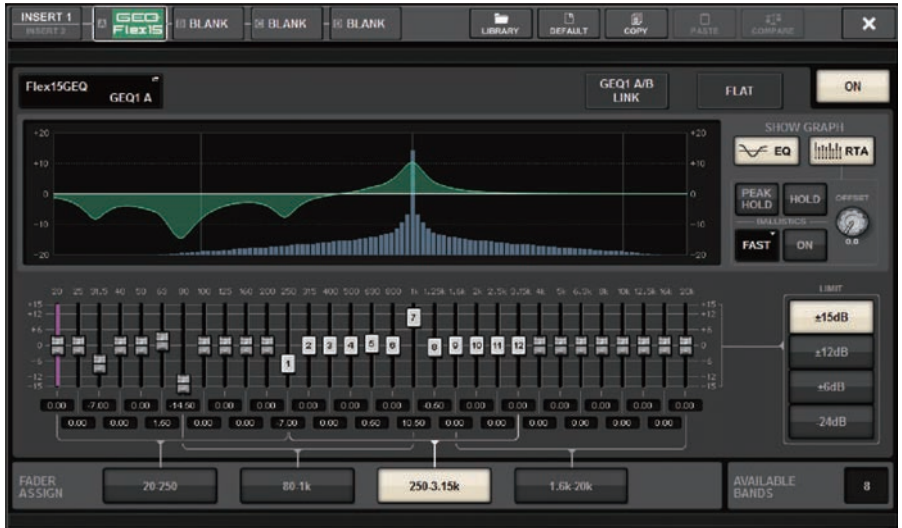

This window is the same as that for the 31BandGEQ, except that the AVAILABLE BANDS field is a real-time indication of the number of additional bands (maximum 15) that can be controlled for the current GEQ.

- 2 Press the GEQ ON/OFF button to turn the Flex15GEQ on.**
- 3 Press one of the buttons in the FADER ASSIGN field to select the group of bands you will control using the faders in the Channel Strip section.**

For details on the bands corresponding to each button in the FADER ASSIGN field, refer to step 4 under “Using the 31BandGEQ” (p.625). When you press one of these buttons, the faders for the bands selected on the touch screen will turn white, and the numbers of the corresponding faders in the Channel Strip section will be displayed. Also, you will be able to use the faders in the Channel Strip section to control the corresponding bands.

NOTE

The above operation is possible even if the Channel Strip section is locked. When you turn off the button in the FADER ASSIGN field, the faders will return to the locked state.

4 Raise the corresponding fader of the Channel Strip section.

For each of a Flex15GEQ's two GEQ units (A and B), a maximum of fifteen bands can be controlled. The real-time number of additional bands that can be controlled is shown to the right of "AVAILABLE BANDS" in the FADER ASSIGN field. If you have used all fifteen bands, you will have to return one of these bands to the flat position before you can operate any other band.

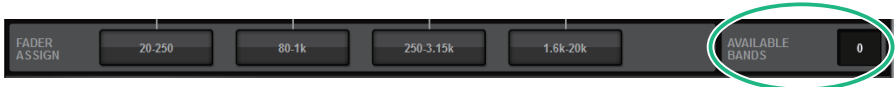

NOTE

- The [ON] key will light if you raise or lower a fader even the slightest amount. This indicates that the corresponding band is being modified.
- To quickly return a boosted or cut band to the flat position, press the corresponding [ON] key in the Channel Strip section to make it go dark.

5 Repeat steps 3 and 4 to adjust up to fifteen bands.

NOTE

If you switch the touch screen display to a different screen or to the GEQ window, the fader assignments in the Channel Strip section will forcibly be defeated. However, if you once again display the same GEQ, the group of bands you had previously been controlling will automatically be assigned to the faders.

6 When you finish making settings, turn off the buttons in the FADER ASSIGN field.

The faders and [ON] keys in the Channel Strip section will return to their previous function.

NOTE

When you close the GEQ popup window, the buttons in the FADER ASSIGN field automatically turn off.

Using the 8BandPEQ

1 Follow steps 1–8 under Inserting a GEQ/PEQ into a channel via the Selected Channel section, insert the 8BandGEQ into a channel.

The system displays the EDIT screen for the GEQ/PEQ that you inserted.

2 If you are using a stereo source, link two GEQ units.

When you press the GEQ LINK button, the following popup window will appear. To enable linking, press any button other than CANCEL. The popup window contains the following items.

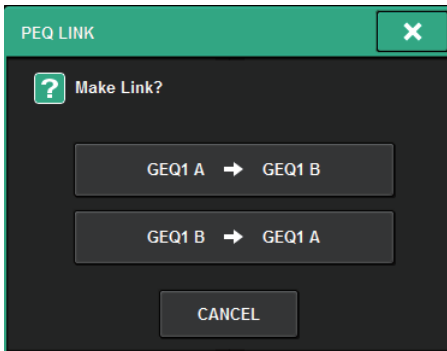

GEQ*A->GEQ*B button

The channel L parameter values will be copied to channel R, and then those parameters will be linked. An asterisk (*) represents the GEQ location.

GEQ*B->GEQ*A button

The channel R parameter values will be copied to channel L, and then those parameters will be linked. An asterisk (*) represents the GEQ location.

CANCEL button

Cancels the link and closes the popup window.

NOTE

The PEQ LINK button appears only for paired PEQs.

3 Press the PEQ ON/OFF button to turn the PEQ on.

GEQ/PEQ EDIT screen (8BandPEQ)

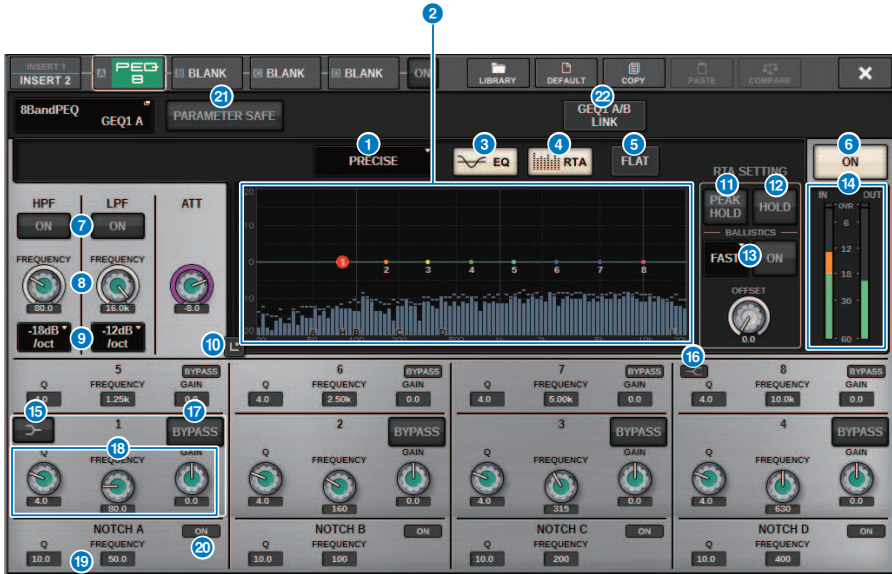

This screen contains the following items.

- 1 **EQ type select button**
Switches the EQ type to PRECISE, AGGRESSIVE, SMOOTH, or LEGACY.
- 2 **PEQ graph**
Displays the parameter values for the PEQ and filters.
- 3 **EQ button**
Press this button to display the EQ graph.
- 4 **RTA button**
If this button is on, a semi-opaque frequency analysis graph of the input signal (immediately after EQ) will be superimposed on top of the EQ frequency response graph.
- 5 **FLAT button**
Press this button to reset the GAIN parameters of all PEQ bands to 0 dB. All ON buttons for the notch filter will be turned off. All parameter values other than those above will retain the same values, without being reset.
- 6 **PEQ ON button**
Switches the currently-selected PEQ on or off.
- 7 **HPF/LPF ON button**
Switches the HPF/LPF on or off.

8 HPF/LPF FREQUENCY knob

Sets the cutoff frequency of the HPF/LPF. Use the screen encoder or the [TOUCH AND TURN] knob to adjust the value.

9 HPF/LPF type select button

Enables you to set the HPF/LPF attenuation per octave.

10 Touch EQ button

Press to enlarge the EQ graph and touch to adjust the EQ parameters.

11 PEAK HOLD

If this button is on, the analyzed frequency response graph will hold the peak level indication.

12 HOLD button

If this button is on, the frequency response graph will indicate and hold the result of the frequency analysis.

13 BALLISTICS field

- BALLISTICS button
If this button is on, you will be able to add rate of decay to the analyzed frequency response graph.
- FAST/SLOW switch button
Switches the decay rate of graph rendering (FAST/SLOW).

14 EQ IN/OUT level meters

Indicate the peak level of signals before and after the EQ. For a stereo channel, these meters indicate the level of both the L and R channels.

15 LOW SHELIVING ON/OFF button

Turn on this button to switch the LOW band to a shelving type filter.

16 HIGH SHELIVING ON/OFF button

Turn on this button to switch the HIGH band to a shelving type filter.

17 BYPASS button

Enables you to bypass bands independently.

18 EQ parameter setting field

Indicate the Q, FREQUENCY, and GAIN parameters for BAND 1–8. Select a field to display the knobs. Use the corresponding screen encoder or the [TOUCH AND TURN] knob to adjust the parameters.

19 Notch parameter setting field

Indicate the Q and FREQUENCY parameters for the notch filter. Select a field to display the knobs. Use the corresponding screen encoder or the [TOUCH AND TURN] knob to adjust the parameters.

20 Notch ON button

Each of four notch filters features an ON button.

21 PARAMETER SAFE button

Switches Recall Safe on/off for the parameters.

22 PEQ LINK button

Press this button to access the PEQ LINK window, in which you can link the PEQ of paired channels.

About Automixer

Automixer detects effective audio from multiple microphones and automatically optimizes the gain distribution for multiple live microphones in unpredictable dialog situations. In this way, the sound engineer can maintain consistent system gain throughout multiple microphones without having to focus on the operation of multiple faders.

Theory of Automixer operation

Automixer employs the Dugan Speech System, which automatically adjusts the automix gain of up to 64 live speech microphones.

One person speaking with multiple microphones

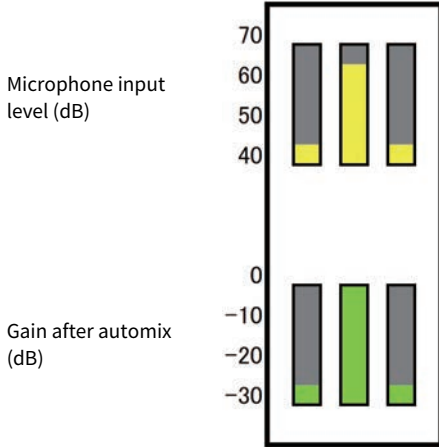

Two people speaking with multiple microphones

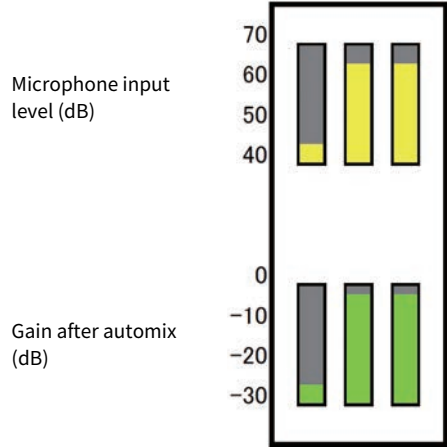

If one person speaks, that microphone's gain level will fade up instantly, while the other microphone gains will be reduced. If a different person speaks, the same effect will be obtained.

If two people speak, the gain of two microphones will be automatically distributed so that the total gain will stay constant. The gain of the third microphone will be reduced.

The behavior of the Dugan Speech System is different than that of a limiter or auto-level controller function. This system enables an engineer to adjust the level balance as usual, even for multiple speakers. Also, while no one is speaking, the system detects the microphone input levels and automatically distributes the gain. So, the faders can be left in a raised position.

Automixer distributes automix gain more preferentially to channels with higher input levels. Therefore, insert it to POST ON. Automixer provides the following benefits:

- It prevents the annoying fluctuation of levels and uneven ambient noise that is input from microphones on the channels with Channel Off or the minimum fader setting.
- It adjusts the gain and fader settings according to the speaker's voice level on each microphone, and inputs even signal levels, resulting in more accurate automix gain distribution.
- It achieves preferential distribution of automix gain for the speaker you want to emphasize by raising the fader for that speaker or lowering others.

Inserting Automixer into a channel

1 Press the RACK&REC button on the menu bar to access the RACK&REC screen.

This screen includes several pages, which you can switch between using the tabs located at the top of the screen.

2 Press the GEQ RACK tab on the RACK&REC screen that displays GEQs.

The “GEQ RACK screen” (p.637) appears.

3 Press the GEQ MOUNT popup button.

NOTE

You can mount Automixer only to GEQ1.

The “GEQ MOUNT popup window” (p.638) appears.

4 In the GEQ MOUNT popup window, use the GEQ/PEQ/Automixer select buttons to select the item you want to mount, and then press the OK button.

The “GEQ RACK screen” (p.639) appears.

5 Press the INPUT popup button.

6 In the INPUT PATCH popup window, select the input source and then press the x button to close the window.

7 Press the OUTPUT popup button.

8 In the OUTPUT PATCH popup window, select the output destination and then press the x button to close the window.

9 Repeat steps 5–8 to insert Automixer into the desired channels.

GEQ RACK screen



This screen contains the following items.

1 GEQ MOUNT popup button

Press this button to display the GEQ MOUNT popup window, in which you can select a plug-in to mount.

GEQ MOUNT popup window

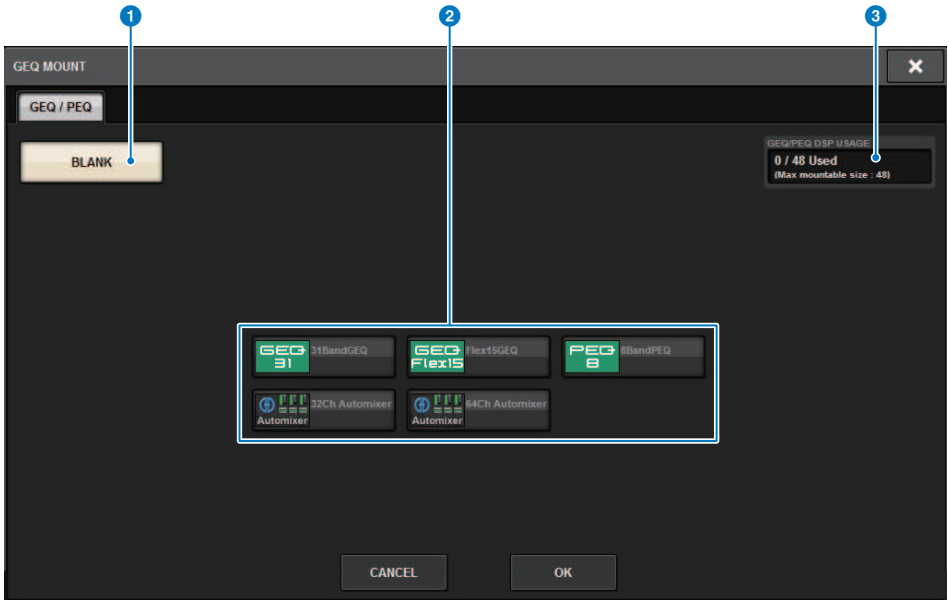

NOTE

The GEQ MOUNT popup window is displayed on only one of the bays.

This screen contains the following items.

- 1 BLANK button**
Unmounts the GEQ/PEQ/Automixer from the rack.
- 2 GEQ/PEQ/Automixer select buttons**
Select the GEQ/PEQ/Automixer that will be mounted in the rack.
- 3 GEQ/PEQ DSP USAGE indication**
Shows the state of GEQ/PEQ resource usage.

GEQ RACK screen

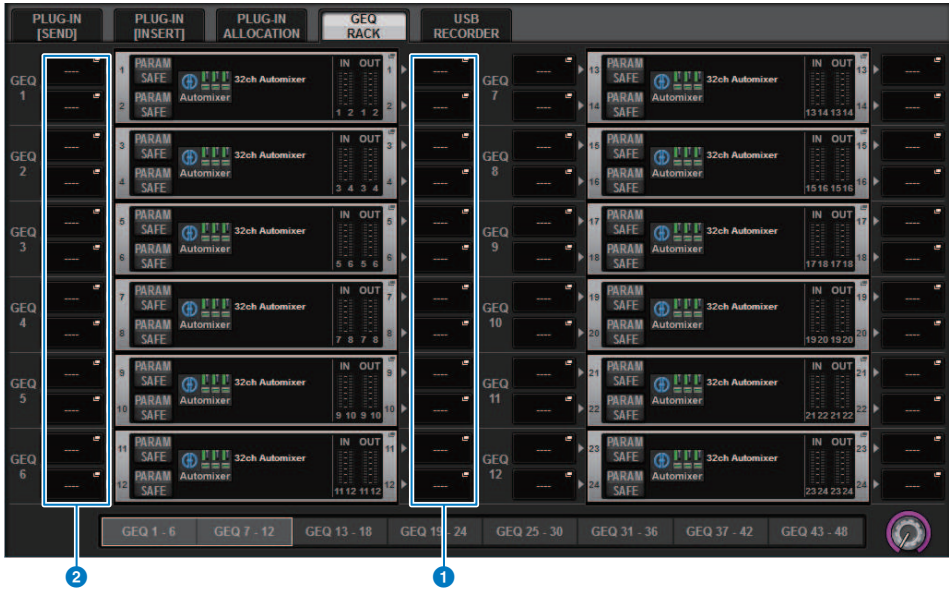

This screen contains the following items.

1 INPUT popup button

Press these buttons to access the INPUT PATCH popup window, in which you can select a signal to patch to the channel.

2 OUTPUT popup buttons

Press these buttons to access the OUTPUT PATCH popup window, in which you can select a signal to patch to the channel.

Controlling the Automixer parameters

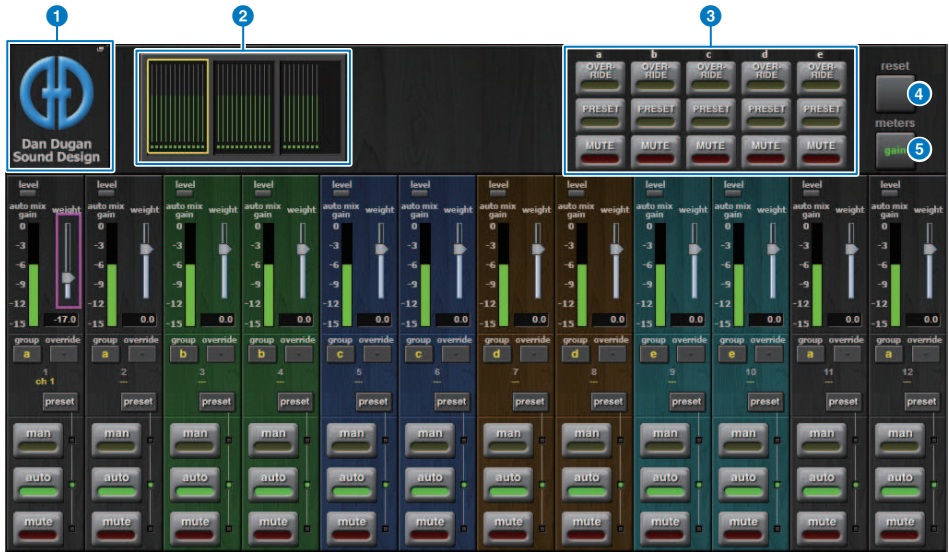

This window contains the following items.

■ Master field

1 MOUNT popup button

Press this button to display the GEQ MOUNT popup window.

2 Channel display select buttons

These buttons contains the auto mix gain meters and mode indicators: man[ual] (yellow), auto (green), or mute (red) for each channel. Press one of these buttons to select channels to be displayed in the channel control field below.

3 OVERRIDE/PRESET/MUTE buttons

These buttons are used to set up each group (a/b/c/d/e) selected in the channel control field. Only the buttons for the selected groups will be displayed.

- OVERRIDE

Press this button to smoothly fade-in the levels of the channels (for which the override buttons are turned on) to 0 dB (unity gain). All channels for which the override buttons are turned off will be muted.

- PRESET

Press this button to place the corresponding group of channels into a mode (man, auto, or mute) as indicated next to the lit preset indicator.

- MUTE

Press this button to fade out all channels immediately (in 0.5 seconds).

4 meters button

Switches the meter indicators displayed in the channel control field. Pressing the button repeatedly will switch among gain (auto mix gain), input (input level), and output (output level).

NOTICE

- “gain” is the most useful choice during normal operations.

5 reset button

Initializes the Automixer settings.

Channel control field

Each channel is always in man, auto, or mute mode. The indicators for the engaged channel mode will light up. To select a mode, press the corresponding mode button or the PRESET button in the master field.

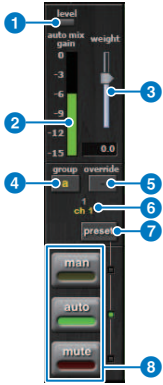

1 Level indicator

Lights up green when the audio signal reaches the level appropriate for automatic mixing.

NOTICE

- If the level indicator flashes, raise the input gain. If the level indicator lights up red, lower the input gain.

2 Meter indicator

The meter indicator features three indication modes. Pressing the meters button in the master field repeatedly will switch modes.

gain (green): Indicates auto mix gain.

input (yellow): Indicates the input level.

output (blue): Indicates the output level.

NOTICE

- “gain” is the most useful choice during normal operations.

3 **weight**

The weight controls balance relative sensitivity of the input channels. Balance the weight controls so that the auto mix gain meters will display approximately equal levels when no one is talking. For example, if there is ongoing noise near one microphone (e.g., computer fan or air vent), suppress it by reducing that channel's weight. To change the channel's weight level, use the [TOUCH AND TURN] knob to manipulate the weight slider.

Automixer calculates the ratios of the input levels of a specific channel against all input channels within the group. The following example explains how the weight control works.

■ **Raising the weight control for one channel:**

- Increases that channel's auto mix gain, and slightly decreases other channels' auto mix gains.
- Makes it easier for the channel with the higher weight setting to obtain auto mix gain (thus, easier to be heard) than other channels.

■ **Lowering the weight control for one channel:**

- Decreases that channel's auto mix gain, and increases other channels' auto mix gains.
- Makes it more difficult for that channel's speaker to be heard over other speakers when multiple people are speaking on multiple microphones.

4 **group**

Each channel can be assigned to one of five groups (a/b/c/d/e). This group function is helpful in the following applications:

- Using multiple rooms: Assign the microphones in each room to different groups so that they can function as separate automixers.
- Stereo panning: Assign the microphones panned left, right, and center to separate groups to maintain a stable stereo ambience.

5 **override**

Turning on the OVERRIDE button in the master field will place the corresponding channels into man or mute mode, according to the channels' override button status.

- While the channels' override buttons are on, turning on the OVERRIDE button in the master field will place the corresponding channels into man[ual] mode.
- While the channels' override buttons are off, turning on the OVERRIDE button in the master field will place the corresponding channels into Mute mode.
- Turn off the Master OVERRIDE button to restore the previous channel mode.

The Override function is useful when the panel discussion leader wants to control the system.

Follow the steps below.

1. Turn on the override button on the channel for the leader.
2. Turn off the override button on all other channels.
3. Turn on the OVERRIDE button in the master field as necessary.

6 **Channel number**

This area displays the channel number and name, where a specific channel is inserted.

7 **preset button**

Press this button to select a channel mode (man, auto, or mute) that will be engaged if the PRESET button in the master field is turned on. The channel preset button will light up indicating that the preset has been programmed for that channel.

8 man/auto/mute buttons

Pressing each button repeatedly toggles the corresponding mode on and off.

man: There is no automixing, and the audio signal passes through at unity gain. Use this mode for singing through a microphone.

auto: Auto mixing is turned on. Use this mode for dialog.

mute: The channel's output is muted.

Plug-ins

About plug-ins

Plug-ins can be used by inserting them into a channel, or via send or return. The RIVAGE PM series provides 50 types of plug-in, including the Rupert EQ 773 and Rupert Comp 830 designed in a collaboration with Rupert Neve Designs, and the VSS4HD and NonLin 2 made by TC Electronic. The maximum number of plug-ins that can be mounted depends on the type of plug-in. For example in the case of the Portico EQ or Portico Comp, up to 192 units can be used. For details on the amount of DSP resources that can be used for each plug-in, refer to the plug-in type list.

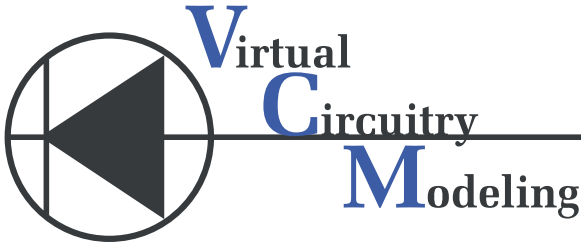

VCM (Virtual Circuitry Modeling) is a technology for modeling analog circuits at the element level (resistors, capacitors, etc.). Plug-ins use VCM technology.

The following functionality is also provided.

- The plug-in mount status and parameters can be saved in scene memory.
- A “PLUG-IN LIBRARY” is available that lets you store and recall plug-in parameters.
- Tap tempo functionality can be used for plug-ins that support it. Tap tempo can be used via a USER DEFINED key or GPI.

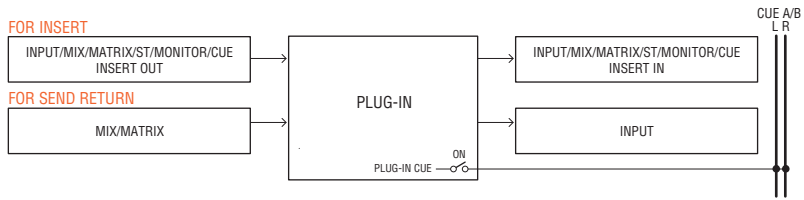

FOR INSERT (例)

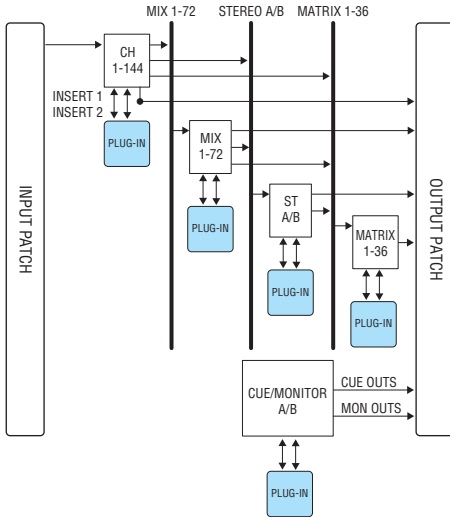

FOR SEND RETURN (例)

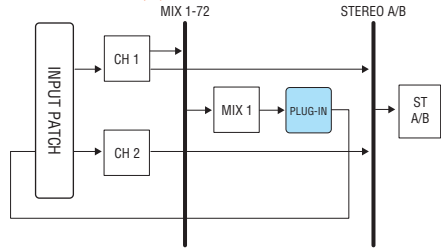

Plug-in type list

Plug-in type	Explanation	Amount of DSP resources	Tap tempo function
REV-X	A 2-in/2-out reverb algorithm that provides a high-density, richly reverberant sound quality, smooth decay, and spaciousness and depth that enhance the original sound. You can choose one of three programs to suit the acoustic environment and your purpose: REV-X Hall, REV-X Room, and REV-X Plate.	6	-
SP2016 Reverb	The SP2016 is a reverb that is a faithful reproduction of Eventide's flagship rackmount processor, the SP2016.	16	-
VSS4HD (DSP-R10 only)	Room simulation reverb by TC Electronic. A variety of reflection settings provide a musical-sounding reverberation that gives you detailed control of room size and distance to the walls.	16	-
NonLin 2 (DSP-R10 only)	Stereo reverb effect by TC Electronic. As a gate reverb that uses an envelope filter and does not require a trigger, this can be used in a variety of creative applications.	16	-
Y7	A reverb plug-in jointly developed by Bricasti Design and Yamaha.	16	-
Reverb	Yamaha's legendary 1-in/2-out SPX reverb. You can choose one of four programs to suit the acoustic environment and your purpose: HALL, ROOM, STAGE, and PLATE.	5	-
Stereo Reverb	2-in/2-out stereo reverb.	6	-

Plug-in type		Explanation	Amount of DSP resources	Tap tempo function
Early Reflection		1-in/2-out early reflections.	7	-
Gate Reverb		1-in/2-out gate reverb. You can choose from two types: Gate Reverb and Reverse Gate.	7	-
Mono Delay		Basic 1-in/2-out repeat delay.	3	✓
Stereo Delay		Basic 2-in/2-out repeat delay.	3	✓
Modulation Delay		Simple 1-in/2-out repeat delay with modulation.	4	✓
Delay LCR		1-in/2-out 3-tap delay.	4	✓
Echo		2-in/2-out stereo delay with cross-feedback loop	4	✓
Analog Delay		This delay effect is based on the Yamaha E1010 analog delay	4	✓
Chorus		2-in/2-out chorus effect.	4	✓
Flanger		2-in/2-out flanger effect.	4	✓
Symphonic		Yamaha's proprietary 2-in/2-out symphonic effect, providing a modulation effect that is richer and more complex than chorus.	5	✓
Dynamic Flanger		Flanger that changes the delay time according to the input level.	2	-
Dynamic Phaser		Stereo phaser that uses 16-stage phase shift.	2	-
Phaser		Phaser that changes the phase shift point according to the input level.	2	✓
Max100		Complete reproduction of a vintage effect that was manufactured only during the late 1970s.	1	✓
Dual Phaser		Complete reproduction of a vintage effect that was manufactured during the middle of the 1970s.	1	✓
Vintage Phaser		Phaser that provides a high degree of sound-shaping flexibility, and is not intended as a reproduction of any specific model.	2	✓
High Quality Pitch		Monaural pitch shifter that produces a stable effect.	4	✓
Dual Pitch		1-in/2-out high-quality pitch shifter.	4	✓
H3000 Live		This is a newly-developed harmonizer that offers the same performance as the Eventide H3000 Ultra-Harmonizer optimized for live-sound applications.	12	-
Tremolo		2-in/2-out tremolo effect.	2	✓
Auto Pan		2-in/2-out auto pan effect.	2	✓
Rotary		1-in/2-out rotary speaker simulation.	5	-
Ring Modulation		2-in/2-out ring modulator.	2	✓
Modulation Filter		2-in/2-out modulation filter.	2	✓
Dynamic Filter		2-in/2-out dynamic filter that changes the cutoff frequency according to the input level.	2	-
Rupert EQ 773	Dual Stereo	Models a console EQ module that Rupert Neve designed in the 1970s.	3	-
Rupert EQ 810	Dual Stereo	Models a console EQ module that Rupert Neve designed in the 1980s.	3	-
Portico 5033	Dual Stereo	Models an analog 5-band EQ made by Rupert Neve Designs.	2	-

Plug-in type		Explanation	Amount of DSP resources	Tap tempo function
EQ-1A	Dual Stereo	Models a classic vacuum tube passive-type vintage EQ.	3	-
Equalizer601		Equalizer that emulates the characteristics of an analog equalizer used in the 1970s. It can be used to obtain a sense of drive.	2	-
DynamicEQ	Dual Stereo	Equalizer that dynamically changes the gain, allowing the cut/boost amount to be controlled in response to the input level.	2	-
Dynamic EQ4	Dual Stereo	Dynamic EQ4 is a two-band dynamic equalizer that has been expanded to feature four bands.	3	-
Rupert Comp 754	Dual Stereo	Models a console compressor/limiter module that Rupert Neve designed in the 1970s.	3	-
Rupert Comp 830	Dual Stereo	Models a console compressor/limiter module that Rupert Neve designed in the 1980s.	3	-
Portico 5043	Dual Stereo	Models an analog compressor/limiter made by Rupert Neve Designs.	2	-
Portico 5045	Dual Stereo	Models the Primary Source Enhancer made by Rupert Neve Designs.	2	-
U76	Dual Stereo	Models a classic vintage compressor/limiter.	3	-
Opt-2A	Dual Stereo	Models a classic vacuum tube (optical type) compressor.	4	-
Comp276 Comp276S		This compressor emulates the characteristics of an FET compressor commonly used in recording studios.	2	-
Buss Comp 369	Dual Stereo	This compressor emulates a standard bus compressor that has been used in recording studios and broadcasting stations.	3	-
MBC4	Dual Stereo	This four-band compressor offers intuitive operability.	3	-
DaNSe	Dual Stereo	Dynamic Noise Suppressor with very good sound quality and ease of use.	3	-
P2MB		This is a processor that accurately models the Portico II Master Bus Processor made by Rupert Neve Designs.	4	-
Distortion		1-in/2-out distortion effect.	2	-
Amp Simulate		1-in/2-out guitar amp simulator.	3	-
Interphase		This tool adjusts the phase between two voices.	2	-
OpenDeck		This mastering plug-in emulates the tape compression created by two open reel tape recorders (a recording deck and a reproduction deck).	4	-

NOTE

Plug-ins are categorized into two types: Dual plug-ins that are used by two monaural channels; and Stereo plug-ins that are used by one stereo channel.

Plug-ins > About plug-ins

Unavailable Plug-in

Some plug-ins (VSS4HD and NonLin2) cannot be used on the CSD-R7 or DSP-RX(-EX).



These are shown for the sake of file compatibility with the RIVAGE PM10 series, but will not perform audio processing. They can be changed to another plug-in or unmounted.

Using plug-ins

This section explains how to use plug-ins.

- 1 Press the RACK&REC button on the menu bar to access the RACK&REC screen.**
- 2 Press the PLUG-IN RACK tab on the RACK&REC screen that displays plug-ins.**

The “PLUG-IN RACK page of the RACK&REC screen” (p.650) appears.
- 3 Press the MOUNT popup button.**

The “RACK MOUNT popup window” (p.653) appears.

NOTE
The RACK MOUNT popup window is displayed on only one of the bays.
- 4 In the RACK MOUNT popup window, use the PLUG-IN select buttons to select the item you want to mount, and then press the OK button.**

The “PLUG-IN ASSIGNMENT popup window” (p.654) appears.
- 5 Rotate the plug-in allocation knob to specify the location for the plug-in (indicated in a pink frame).**
- 6 Press the OK button to allocate the plug-in.**

If you decide to cancel the operation, press the CANCEL button instead of the OK button.
The plug-in screen appears.
- 7 Press the INPUT popup button.**
- 8 In the INPUT PATCH popup window, select the input source and then press the x button to close the window.**
- 9 Press the OUTPUT popup button.**
- 10 In the OUTPUT PATCH popup window, select the output source and then press the x button to close the window.**

PLUG-IN RACK page of the RACK&REC screen



This screen contains the following items.

1 MOUNT popup button

Press this button to display the RACK MOUNT popup window, in which you can select a plug-in to mount.

2 Plug-in allocation bar

You can view the plug-in allocation status at a glance.

3 Rack select knob

Use the corresponding screen encoder or the [TOUCH AND TURN] knob to select a rack.

PLUG-IN ALLOCATION page of the RACK&REC screen

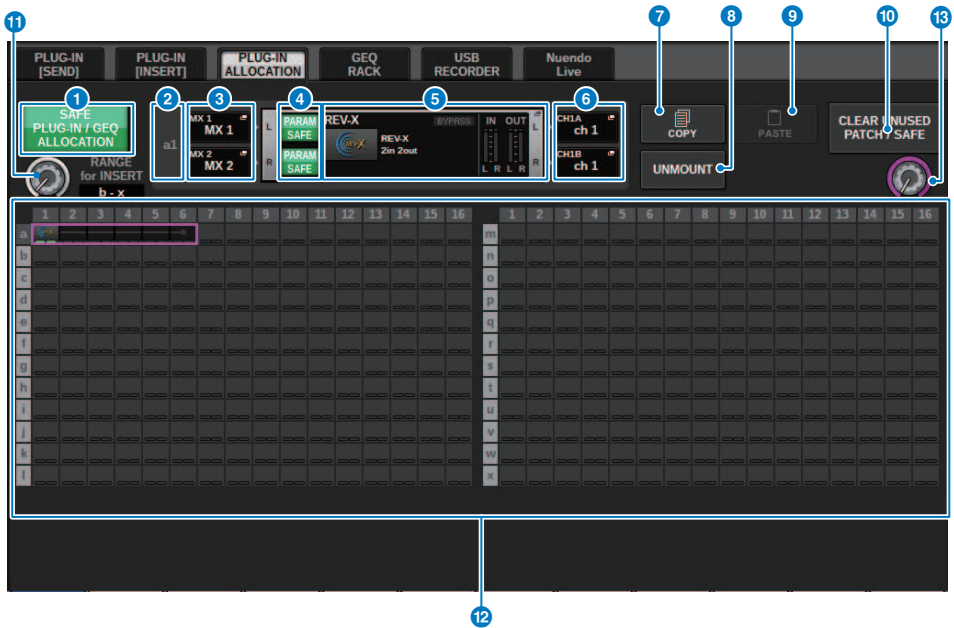

This screen contains the following items.

1 SAFE PLUG-IN/GEQ ALLOCATION button

This button turns on/off recall safe for resource allocation used to mount plug-ins and GEQ.

2 Plug-in allocation number

Indicates the locations of the allocated plug-ins (expressed by the row name a-x and the column number).

3 INPUT popup buttons (L/R)

Press these buttons to access the INPUT PATCH popup window, in which you can select a signal to patch to the L/R channel.

4 PARAM SAFE button (L/R)

Switches Recall Safe on/off for plug-in parameters.

5 RACK MOUNT popup button

Press this button to access the popup window of the currently-selected plug-in. While a plug-in is not allocated in the selected location, press this button to display the RACK MOUNT popup window, in which you can select a plug-in to mount.

6 OUTPUT popup buttons (L/R)

Press these buttons to access the OUTPUT PATCH popup window, in which you can select a signal to patch to the L/R channel.

7 COPY button

Use this button to copy the currently-selected plug-in when you want to mount a single plugin in multiple locations.

8 UNMOUNT button

Use this button to unmount the currently-selected plug-in.

9 PASTE button

Use this button to paste the copied plug-in to the selected location.

10 CLEAR UNUSED PATCH/SAFE button

Use this button to cancel unused patches or recall safe.

11 Insert plug-in allocation knob

This knob specifies the position at which the inserted plug-in will be placed.

12 Plug-in allocation field

Indicates the plug-in allocation status. You can view 384 available DSP resources at a glance. The currently-selected plug-in is indicated in a pink frame.

13 Plug-in allocation knob

Allocates plug-ins. You can also allocate plug-ins by tapping the touch screens.

RACK MOUNT popup window

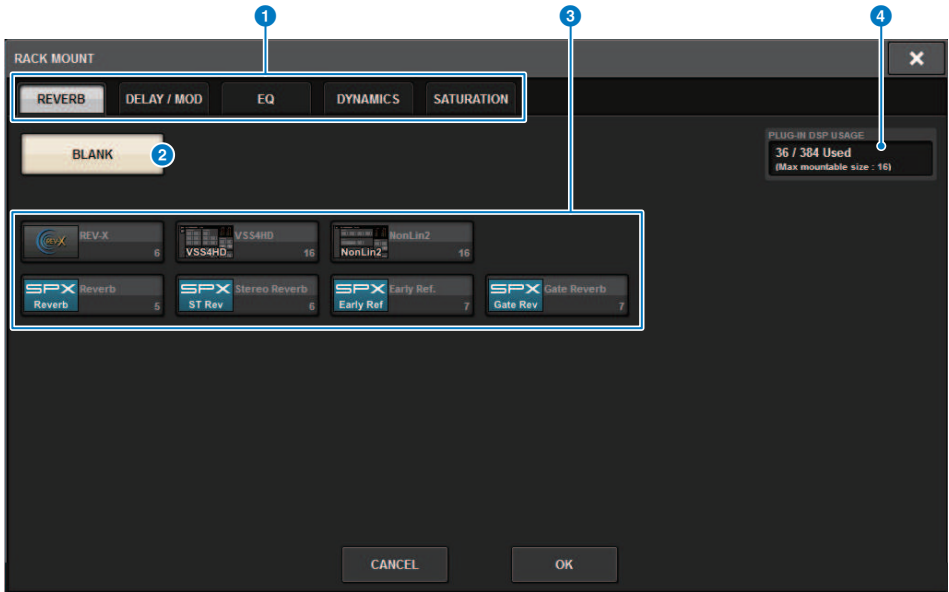

This screen contains the following items.

- 1 Category select tabs**
Enable you to select the category of plug-in that will be mounted in the rack.
- 2 BLANK button**
Unmounts the plug-in from the rack.
NOTE
If you open this window by pressing the MOUNT button on the PLUG-IN RACK page, you will see this BLANK button and be able to select a plug-in to unmount. However, if you press the BLANK button, a message will appear and you will be unable to unmount the plug-in.
To unmount a specific plug-in, open the plug-in popup window for the corresponding RACK, and then press the MOUNT button to display the RACK MOUNT popup window, in which you can select a plug-in to unmount.
- 3 PLUG-IN select buttons**
Select the plug-in that will be mounted in the rack.
- 4 PLUG-IN DSP USAGE indication**
Shows the state of plug-in resource usage.

PLUG-IN ASSIGNMENT popup window

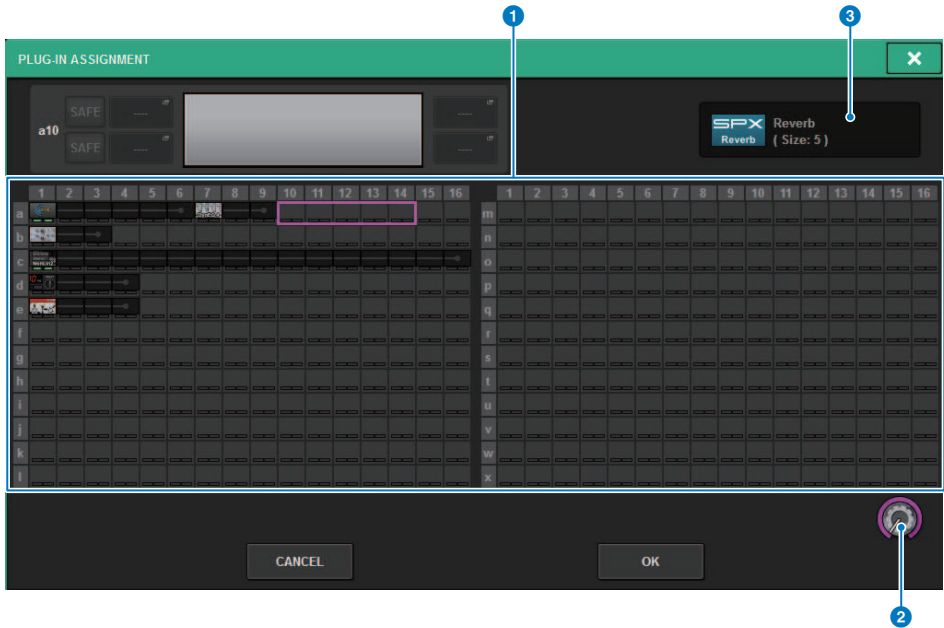

This screen contains the following items.

1 Plug-in allocation field

Indicates the plug-in allocation status. You can view 384 available DSP resources at a glance. A location to which you can allocate the selected plug-in is indicated in a pink frame. A gray frame means you cannot allocate the selected plug-in to that location.

2 Plug-in allocation knob

Allocates plug-ins. You can also allocate plug-ins by tapping the touch screens.

3 Plug-in indicator

Indicates the plug-in to be allocated.

Plug-in screen

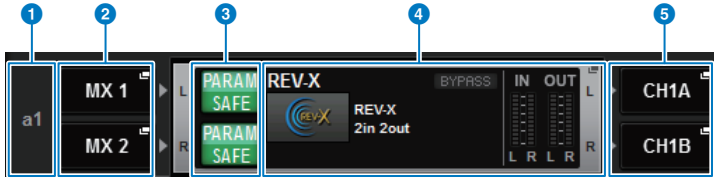

This screen contains the following items.

- 1 Plug-in allocation number**
Indicates the locations of plug-ins (expressed by the row name <a-x> and the column number).
- 2 INPUT popup buttons (L/R)**
Press these buttons to access the INPUT PATCH popup window, in which you can select a signal to patch to the L/R channel.
- 3 PARAM SAFE button (L/R)**
Switches Recall Safe on/off for plug-in parameters.
- 4 RACK MOUNT popup button**
Press this button to access the popup window of the currently-selected plug-in.
- 5 OUTPUT popup buttons (L/R)**
Press these buttons to access the OUTPUT PATCH popup window, in which you can select a signal to patch to the L/R channel.

Controlling the plug-in parameters

The popup window for each plug-in contains the following items.



1 RACK MOUNT popup button

Press this button to display the RACK MOUNT popup window, where you can select a plug-in to mount.

2 PARAM SAFE button

Switches Recall Safe on and off for plug-in parameters.

3 INPUT popup buttons (L/R)

Press these buttons to open the INPUT PATCH popup window, where you can select a signal to patch to the L/R channel.

4 TEMPO button

allows you to select the tempo of the tap tempo function. For details on the plug-ins that can be used, refer to the data list. This button will appear if a delay-type or modulation-type effect is selected.

The tap tempo BPM can be adjusted using the [TOUCH AND TURN] knob.

5 LIBRARY button

Press this button to open the corresponding plug-in library window.

6 DEFAULT button

Restores the default parameter settings.

7 COPY button

Copies the setting of the selected plug-in to buffer memory.

8 PASTE button

Press this button to paste the settings that were copied in buffer memory to the current plug-in. If valid data has not been copied into buffer memory, you will be unable to paste anything.

9 COMPARE button

Press this button to switch between the current plug-in settings and data in buffer memory. If valid data has not been copied into buffer memory, you will be unable to compare the data.

10 Parameter field

Shows the parameters of the currently-selected plug-in. The edit points of dials, sliders, and graphs can be adjusted by sliding on the touch panel and other operation actions.

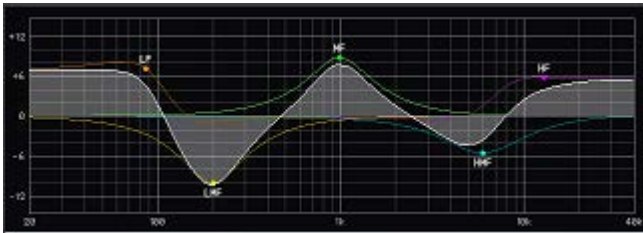

11 Screen encoder access field

Displays the name and value of the parameters that are assigned to the screen encoders. To switch the parameters that are being controlled, press a tab within the screen.

12 BYPASS button

Sets plug-ins to the bypass state.

13 OUTPUT popup buttons (L/R)

Press these buttons to open the OUTPUT PATCH popup window, where you can select a signal to patch to the L/R channel.

14 IN/OUT meters

These indicate the level of the signal before and after it passes through the plug-in.

15 CUE A/B buttons

When this is turned on, you can audition the signal processed by the plug-in. You can choose CUE A, or CUE B.

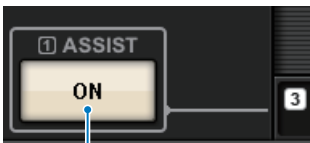

16

16

ASSIST button

When you press this button, the screen shows the parameter assignments that can be operated by the screen encoders.

NOTE

If the ASSIST button is on, you will be able to easily identify the parameters that are currently available for editing, and the parameters that will be available for editing after you select them.

Rotate while holding the screen encoder down to fine-tune the parameter value.

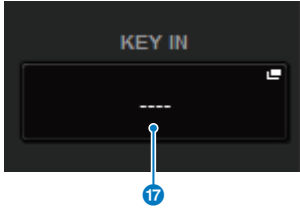

17

KEY IN button

Press the button to open the KEY IN SOURCE SELECT popup window, where you can select a key-in signal source.

Controlling the REV-X plug-in parameters

REV-X is a reverb algorithm that provides a high-density, richly reverberant sound quality, with smooth attenuation, and spread and depth that work together to enhance the original sound. You can choose one of three programs to suit the acoustic sound field and your intentions: REV-X Hall, REV-X Room, and REV-X Plate.

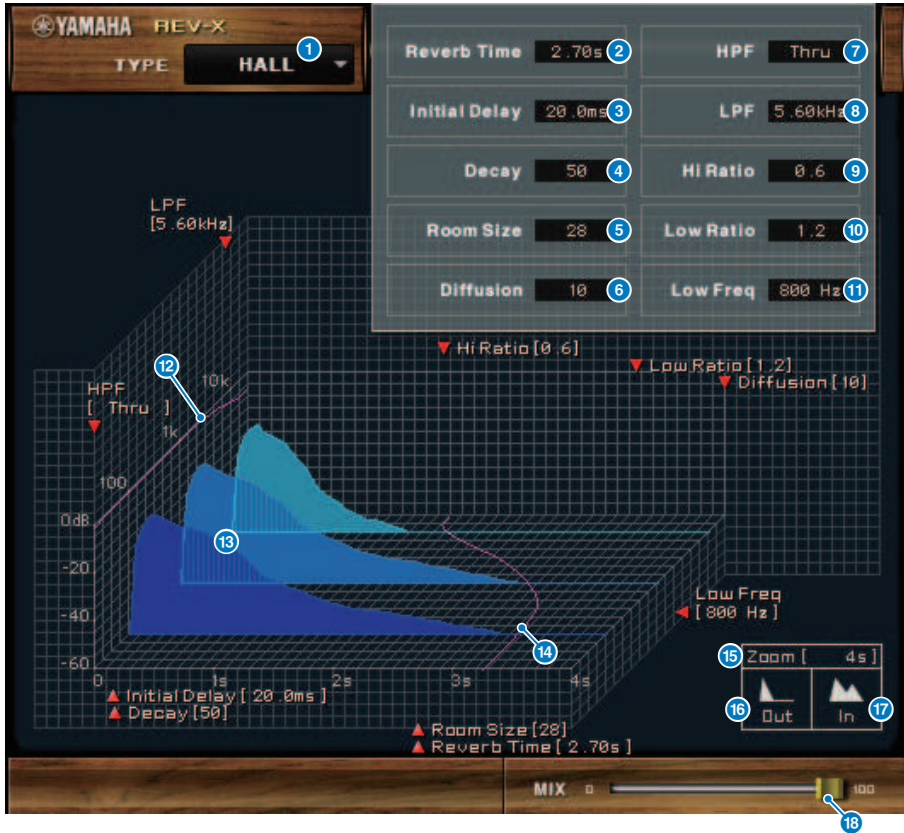

- 1 EFFECT TYPE**
Enables you to select an effect type.
- 2 Reverb Time**
Duration of time until the reverberation attenuates and stops. Higher values extend the reverberation.
- 3 Initial Delay**
Duration of time between sound input and the start of reverberation. Higher values delay the start of reverberation.

4 **Decay**

Shape of reverberation envelope. Reverberation characteristics are determined by the value.

5 **Room Size**

Size of space. Higher values simulate larger spaces. This value is linked with the Reverb Time value. When you change this value, the Reverb Time value changes.

6 **Diffusion**

Density and spread of reverberation. Higher values increase the density and enhance the spread.

7 **HPF**

This filter cuts the low frequency range of the reverberation. The range below the frequency specified by this value is cut. This filter does not affect the original source sound.

8 **LPF**

This filter cuts the high frequency range of the reverberation. The range above the frequency specified by this value is cut. This filter does not affect the original source sound.

9 **Hi Ratio**

Length of reverberation in the high frequency range. The reverberation duration of the high frequency range is expressed as a ratio relative to Reverb Time.

10 **Lo Ratio**

Length of reverberation in the low frequency range. The reverberation duration of the low frequency range is expressed as a ratio relative to Reverb Time.

11 **Low Freq**

Frequency value that serves as the basis for the Lo Ratio value. The frequency band below this value is affected by the Lo Ratio parameter setting.

12 **Filter frequency response curve**

The curve changes depending on the HPF and LPF values.

13 **Reverberation images**

These images represent the high-range (10kHz), mid-range (1kHz), and low-range (100Hz) reverberation. These images change shape depending on the parameter values. The vertical axis represents the level; the horizontal axis represents reverb time; the shape represents the envelope.

14 **Reverb time curve**

This curve represents the high-range (10kHz), mid-range (1kHz), and low-range (100Hz) reverb time. The curve changes depending on the Reverb Time, Hi Ratio, and Lo Ratio parameter values.

15 **Zoom**

This field indicates the time duration (in seconds) as displayed by the time axis (horizontal axis).

16 **Zoom Out button**

Click this button to increase the time value (in seconds) as displayed by the time axis (horizontal axis). As a result, the display zooms out on the horizontal axis.

- 17** **Zoom In button**

Click this button to decrease the time value (in seconds) as displayed by the time axis (horizontal axis). As a result, the display zooms in on the horizontal axis.

- 18** **MIX slider**

This control enables you to adjust the mix balance of the dry and wet (effect) sounds. When the balance is 0%, only the dry sound is output. When the balance is 100%, only the wet sound is output.

Controlling the SP2016 parameters

The SP2016 Reverb is an authentic recreation of the original rack processor from the Eighties. Highly regarded for its signature reverbs, the SP2016 was used in countless hit records for nearly 40 years. The SP2016 Reverb plug-in includes vintage and modern versions of Room, Stereo Room and Hi-Density Plate. The plug-in naturally captures every aspect of the sound of a real physical environment - from the complex early reflections, to the natural way in which the echo density increases with time, to the smooth Gaussian decay of the reverb tail. The structure of the reverb can be modified by fine-tuning the controls - including PreDelay, Decay, Position and Diffusion. The EQ section allows for simple high and low filtering of the reverb with adjustable filter ranges. The unique Position control takes the listener from the stage to back of the room increasing the early reflections while retaining all other settings.

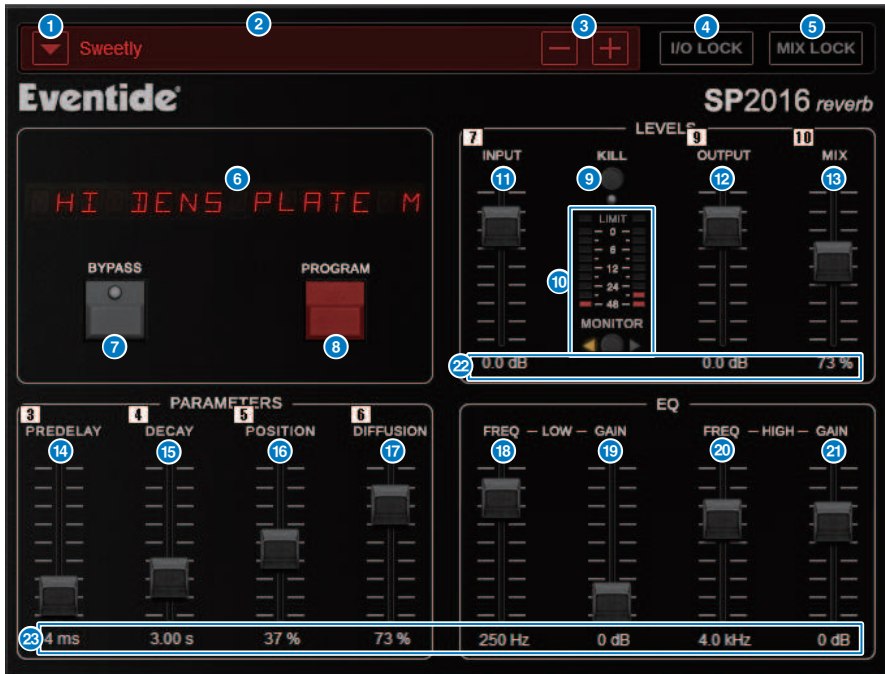

1 PRESET list button

Switches the preset. When the preset is switched, the program and other parameters will change accordingly.

2 PRESET display

Indicates the name of the selected preset.

3 PRESET -/+ buttons

The “-” button switches to the previous preset, and the “+” button switches to the following preset.

4 I/O LOCK button

When this button is on, the input/output level will not change when switching between presets. It will be disabled for other operations such as the library recall except for switching between presets.

5 MIX LOCK button

When this button is on, the mix balance will not change when the preset is changed. It will be disabled for other operations such as the library recall except for switching between presets.

6 LED DISPLAY

Displays information for the selected program or parameters that are being modified.

7 BYPASS button

Bypasses the effect.

8 PROGRAM button

Switches between programs (algorithms).

9 KILL button

Shuts off the input (except when bypass is on).

10 Level meter

Displays the input/output level selected using the MONITOR button. The LIMIT LED indicator will light up if the level exceeds 0 dB. Press the LIMIT LED to clear the LED that is lit. The LIMIT LED for the output side is also used for the internal limit indicator of the reverb.

11 INPUT fader

Adjusts the input level.

12 OUTPUT fader

Adjusts the output level.

13 MIX fader

Adjusts the mix balance between dry and wet signals.

14 PREDELAY fader

Adjusts the amount of predelay.

15 DECAY fader

Adjusts the reverberation time. Use caution when LOW GAIN is set to boost (+), as lengthening the DECAY may cause oscillation.

16 POSITION fader

Adjusts the front/rear listening position.

17 DIFFUSION fader

Adjusts the spread of the reverb.

18 LOW FREQ fader

Adjusts the frequency of the low-range EQ (shelving).

19 LOW GAIN fader

Adjusts the gain of the low-range EQ (shelving). Use caution with long DECAY settings, as boosting (+) the LOW GAIN may cause oscillation.

20 **HIGH FREQ fader**

Adjusts the frequency of the high-range EQ (shelving).

21 **HIGH GAIN fader**

Adjusts the gain of the high-range EQ (shelving).

22 **Parameter text**

23 Indicates the values of the parameters to be operated. Click these values with your mouse to input the values via keyboard.

Controlling the VSS4HD plug-in parameters

VSS4HD is a room simulation reverb made by TC Electronic. It provides musical-sounding reverberation with a variety of reflected sounds. This plug-in includes several pages, which you can switch between using the tabs. (only for DSP-R10)

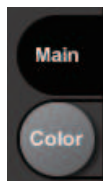

Main page

- 1 Decay button**
Adjusts the decay time of the reverb.
- 2 Hi Cut button**
Adjusts the frequency of the high cut filter at the input stage of the reverb.
- 3 Rev Size button**
Adjusts the perceptual size of the reverb.

- 4 Pre Delay button**
Adjusts the delay of the reverb input.
- 5 Rev Delay button**
Adjusts the delay of the reverb tail.
- 6 Rev Width button**
Adjusts the width of the reverb tail.
- 7 Decrease button**
Adjusts the number of reflections for the early reflections.
- 8 Lo Color button**
Adjusts the low-frequency range of the early reflections.
- 9 Early Start button**
Adjusts the first early reflections to eliminate them.
- 10 Hi Color button**
Adjusts the high-frequency range of the early reflections.
- 11 Early Stop button**
Adjusts the end of the early reflections to reduce them.
- 12 Location Type list**
Selects the type of location.
- 13 Positions indicator**
Indicates the positions of the input sources.
- 14 Source 1/2 buttons**
Select the position of input sources 1/2.
- 15 Input meter**
Indicates the input level.
- 16 Output meter**
Indicates the output level.
- 17 In Level button**
Adjusts the input level.
- 18 Mute Input button**
Mutes the input.
- 19 Out Level button**
Adjusts the output level.
- 20 Mute Output button**
Mutes the output.

21

Reverb Level button

Adjusts the level of the reverb tail.

22

Mute Reverb button

Mutes the reverb.

23

Early Level button

Adjusts the level of the early reflections.

24

Mute Early button

Mutes the early reflections.

Color page

Color page

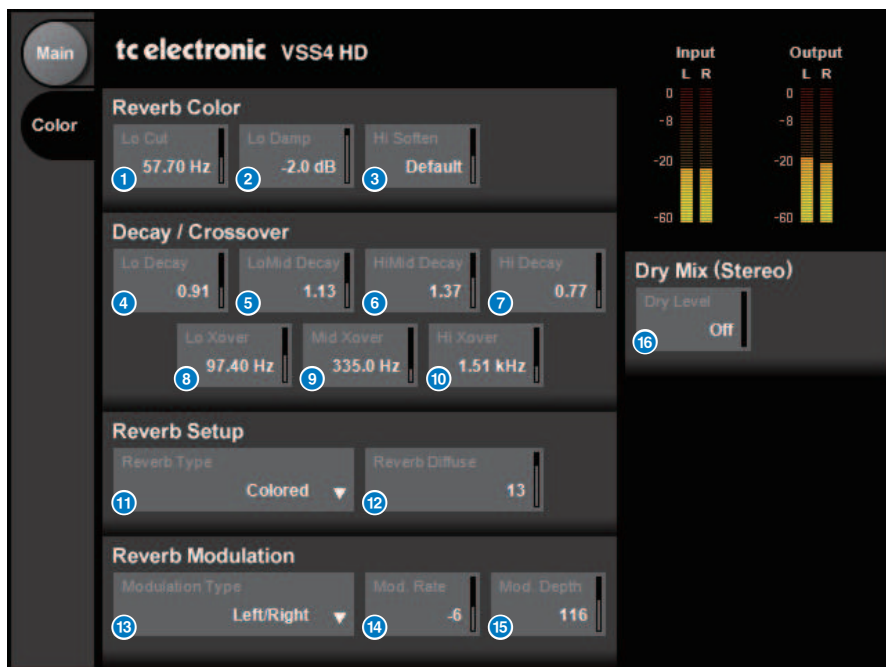

- 1 Lo Cut button**
Adjusts the low-cut frequency.
- 2 Lo Damp button**
Adjusts the low-cut amount in dB units.
- 3 Hi Soften button**
Adjusts the high-frequency range of the reverb tail.
- 4 Lo Decay button**
Adjusts the multiple of decay for the frequency range below Lo Xover.
- 5 Lo Mid Decay button**
Adjusts the multiple of decay for the low-mid frequency range.
- 6 Hi Mid Decay button**
Adjusts the multiple of decay for the middle frequency range.
- 7 Hi Decay button**
Adjusts the multiple of decay for the frequency range above Hi Xover.

- 8 Lo Xover button**
Adjusts the crossover frequency between the low and low-mid frequency ranges of the reverb tail.
- 9 Mid Xover button**
Adjusts the crossover frequency between the low-mid and middle frequency ranges of the reverb tail.
- 10 Hi Xover button**
Adjusts the crossover frequency between the middle and high frequency ranges of the reverb tail.
- 11 Reverb Type button**
Selects the type of reverb effect.
- 12 Reverb Diffuse button**
Adjusts the diffusion for the decay time.
- 13 Modulation Type button**
Selects the type of modulation.
- 14 Modulation Rate button**
Selects the rate of modulation.
- 15 Modulation Depth button**
Selects the depth of modulation.
- 16 Dry Level button**
Adjusts the level of the dry signal at the output stage.

Controlling the NonLin2 plug-in parameters

NonLin2 is a processor that emulates an effect reverb made by TC Electronic that enables the user to adjust an envelope. It provides vocal ambience, drum sound, reverse reverb, and a Twist effect. (only for DSP-R10)

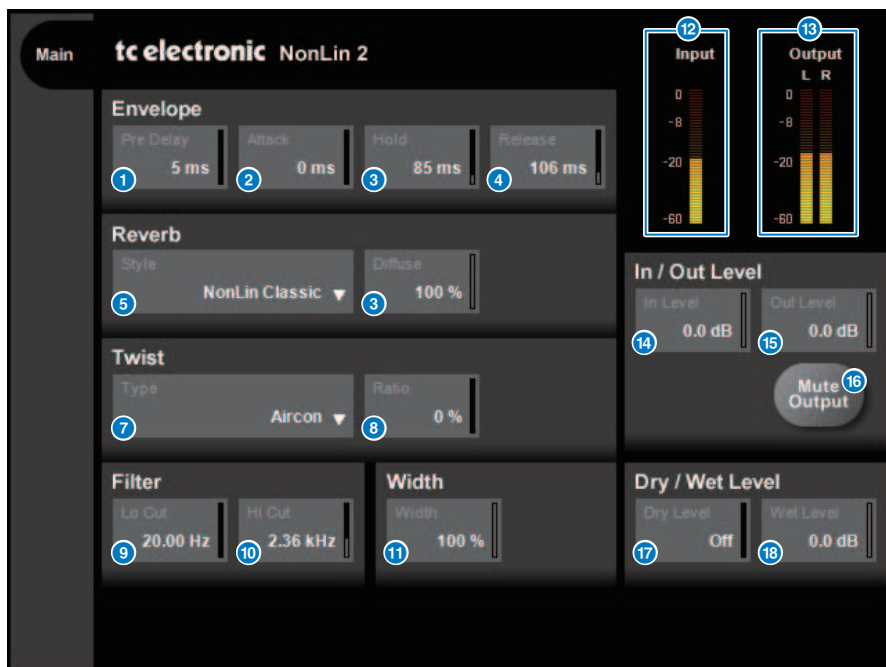

- 1 Pre Delay button**
Adjusts the delay of the envelope.
- 2 Attack button**
Adjusts the attack time of the envelope.
- 3 Hold button**
Adjusts the hold time of the envelope.
- 4 Release button**
Adjusts the release time of the envelope.
- 5 Style list**
Selects the basic reverb style.
- 6 Diffuse button**
Adjusts the diffusion (spread) for the selected reverb style.

7

Type list

Selects the type of Twist that affects the reverb.

8

Ratio button

Adjusts the proportion of Twist for the reverb.

9

LoCut button

Adjusts the frequency of the low cut filter at the input stage of the reverb.

10

HiCut button

Adjusts the frequency of the high cut filter at the input stage of the reverb.

11

Width button

Adjusts the stereo width of the output.

12

Input meter

Indicates the input level.

13

Output meter

Indicates the output level.

14

In Level button

Adjusts the input level.

15

Mute Output button

Mutes the output.

16

Dry Level button

Adjusts the level of the dry signal.

17

Wet Level button

Adjusts the level of the wet signal (reverb component).

Controlling the Bricasti Design Y7 Stereo Reverb Processor plug-in parameters

Y7 Stereo Reverb Processor is a new, live-use reverb plug-in developed jointly by Bricasti Design, the world's premier manufacturer of hardware digital reverbs, and Yamaha. The sound is deep, dense, smooth and exceptionally natural. The Y7 also has a wonderfully characteristic Bricasti sound with a natural envelope from rise to decay, and a gorgeously smooth reverb tail. The UI has a simple structure of 5 dials and 5 buttons, is easy to use, and conveniently features many built-in presets of high quality that can be applied in the field.



- 1 Reverb Time knob**
Adjusts the reverb time.
- 2 Pre Delay knob**
Adjusts the delay of the reverb input.
- 3 Size knob**
Adjusts the apparent size of the space.
- 4 RT Damping knob**
Adjusts the high-frequency attenuation of the rear reverberation.

- 5 Rolloff knob**
Adjusts the LPF of the output part.
- 6 Rich button**
When this button is on, the density of the reverb is increased.
- 7 High Diffusion button**
When this button is on, the amount of reverb spread is increased.
- 8 VLF (Very Low Frequency) button**
When this button is on, the reverb component of the ultra-low frequencies is increased.
- 9 Bandpass button**
Turns on BPF in the output section.
- 10 Presence button**
When this button is on, the tone becomes brighter.
- 11 Dry/Wet knob**
Adjusts the mix of input signal and reverb signal.
- 12 Lock button**
When this button is on, the Dry / Wet control is locked so that it cannot be changed.
- 13 Program button**
For calling up the programs, which are divided into 5 program groups, containing 35 programs.
- 14 LED display**
Shows the currently selected program. When a knob or button is operated, the corresponding parameters are displayed.
- 15 Input meter**
Indicates the input level.
- 16 Output meter**
Indicates the output level.

Controlling the Analog Delay plug-in parameters

This delay effect is based on the Yamaha E1010 analog delay released in the 1970s, with a few refinements to bring it up to date for modern applications. It delivers the same deep, organic echo sound that was a characteristic of the BBD analog delay devices used in the original E1010. Modulation can be added for a thick chorus sound. And, taking versatility to the next level, it is possible to select BBD sounds that were not available in the original E1010 so characters ranging from clear and precise to warm are available for use.



1 Drive meter

This meter indicates the amount of drive by input level. Because Analog Delay features BBD and dynamics circuits, higher input level would bring the delayed sound up to maximum and increase the drive amount.

2 Delay time indicator

Indicates the current delay time and converted BPM value. The tap tempo function can be used, and pressing the Sync button changes the delay time and BPM display to match the tap tempo.

3 BBD TYPE switches

Adjust the characteristics of the delay sound. The characteristics become stronger in the order of A to E.

A: Clear sound as heard from a vintage digital delay

B to D: Natural sound, equivalent to the E1010

E: Warm sound similar to an instrumental stomp box

4 TIME RANGE switches

Specify the delay time range controlled via the DELAY knob.

5 INPUT knob

Adjusts the input gain. As the input increases, the delay's drive amount also increases. If the input level is lower, a cleaner sound is produced. If the input level is higher, a deeper delay sound is produced.

6 BASS knob

Adjusts the low frequency range level at the input stage.

7 TREBLE knob

Adjusts the high frequency range level at the input stage.

Plug-ins > Controlling the Analog Delay plug-in parameters

- 8 DELAY knob**
Adjusts the delay time.
- 9 FEEDBACK knob**
Adjusts the feedback amount of the delay signal.
- 10 FREQUENCY knob**
Adjusts the frequency of modulation.
- 11 DEPTH knob**
Adjusts the depth of modulation.
- 12 MIX knob**
Adjusts the mix balance between dry and delay sounds.

Controlling the Max100 plug-in parameters

Max100 reproduces a classic phaser that appeared in the second half of the 1970s and continues to be popular today. With just four modes and a speed knob, it produces a variety of distinctive phase sounds.



- 1 MODE knob**
Switches the tonal character. There are four types that differ in modulation amplitude and feedback amount.
- 2 SPEED knob**
Adjusts the modulation speed.
- 3 FOOT switch**
Switches the effect on/off.

Controlling the Dual Phaser plug-in parameters

Dual Phaser reproduces a vintage phaser that was manufactured during the middle of the 1970s. Two phasers, two LFOs, and four selectable modes allow a wide range of sounds to be produced.



- 1 LFO 1 RATE knob**
Adjusts the LFO 1 speed.
- 2 LFO 1 SHAPE switch**
Selects the LFO 1 waveform.
- 3 LFO 2 RATE knob**
Adjusts the LFO 2 speed.
- 4 LFO 2 SHAPE switch**
Selects the LFO 2 waveform.
- 5 PHASER A DEPTH knob**
Adjusts the modulation depth of Phaser A.
- 6 PHASER A FEEDBACK knob**
Adjusts the feedback amount of Phaser A.
- 7 PHASER A ON/OFF switch**
Switches Phaser A on/off.
- 8 PHASER B DEPTH knob**
Adjusts the modulation depth of Phaser B.
- 9 PHASER B FEEDBACK knob**
Adjusts the feedback amount of Phaser B.
- 10 SWEEP LFO1/LFO2 switch**
Selects the Phaser B LFO.

- 11 **SWEEP NORM/REV switch**
Selects the LFO phase of Phaser B. NORM is normal phase, and REV is reverse phase.
- 12 **PHASER B ON/OFF switch**
Switches Phaser B on/off.
- 13 **MODE knob**
Rearranges the two phasers.
I: After mixing the stereo input, the sound processed by Phaser A is output from the L-channel and the sound processed by Phaser B is output from the R-channel.
II: After mixing the stereo input, the sound processed by Phaser A is output from the L-channel, and the sound processed by Phaser B is additionally processed by Phaser B and output from the R-channel.
III: After mixing the stereo input, the sound processed by Phaser A and then by Phaser B is output from both the L-channel and the R-channel.
IV: The L-channel input is processed by Phaser A and output from the L-channel, and the R-channel input is processed by Phaser B and output from the R-channel.

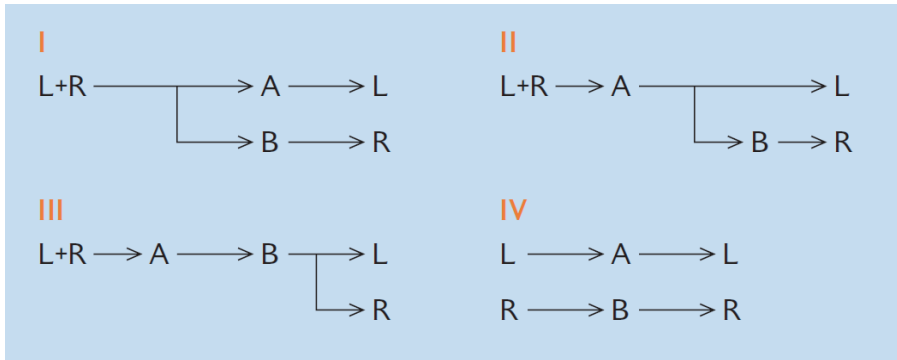

Controlling the Vintage Phaser plug-in parameters

Vintage Phaser provides the high degree of sound-shaping flexibility that is expected of a phaser, but is not intended as a reproduction of any specific model. With 4/6/8/10/12/16 stages and two different modes, it can become several different types of phaser. It provides speed, center frequency, depth, feedback, and color settings for detailed control of the sound.



- 1 SPEED knob**
Adjusts the modulation speed.
- 2 MANUAL knob**
Adjusts the center frequency of modulation.
- 3 DEPTH knob**
Adjusts the depth of modulation.
- 4 FEEDBACK knob**
Adjusts the feedback amount.
- 5 COLOR knob**
Makes fine adjustments to the tone. MODE and STAGE are valid only in the following combinations.

MODE	STAGE
I	10
II	6/8/12/16

- 6 MODE switch**
Switches the type of circuit structure that is modeled. The tonal character will be changed.
- 7 STAGE switch**
Selects the extent of the circuit that is modeled. The tonal character will be changed
- 8 FOOT switch**
Switches the effect on/off.

Controlling the H3000 Live plug-in parameters

The Eventide H3000 Ultra-Harmonizer features outstanding effect quality that has made it an enduring favorite of engineers and musicians everywhere. Now the newly-developed H3000 Live offers that same performance optimized for live-sound applications. This powerful processor provides pitch shift, delay, reverb, modulation, filter, and other modules that can be combined as required with an advanced algorithm that delivers remarkably organic overall sound. Carefully crafted presets make it is easy to achieve intricate, sonorous effects, adding rich harmonization or chorus to vocals, creating big guitar sounds with lush harmonics, or providing top-quality delay and reverb.



1 PROGRAM display

This area shows the name of the selected preset (PROGRAM) and algorithm.

2 PROGRAM SELECT list button

Switches the preset. If you switch the preset, the internal algorithm and parameters will change accordingly.

3 Level meters

Indicate the input and output levels. The OVER indicator will light up if the output level exceeds 0 dB.

4 Value enter buttons

Use this numeric pad to enter a value for the parameter selected by the PARAMETERS buttons. Press the numeric and [+]/[-] buttons to enter a value, and then press the [ENT] button to confirm the setting. Press the [CXL] button to cancel the value before you confirm it. Up or down arrow increases or decreases the value by one.

5 PARAMETERS display

Indicates the parameter values.

6 PARAMETERS buttons

Enable you to select parameters so you can modify assigned values.

Parameter	Description
MIX	Adjusts the mix balance between dry and wet signals.
MODULATION	Adjusts the amount of modulation.
SHIFT (LEFT, RIGHT)	Adjusts the pitch shift amount for each channel.
DELAY (LEFT, RIGHT)	Adjusts the delay time for each channel.
FEEDBACK (LEFT, RIGHT)	Adjusts the feedback amount for each channel.

Controlling the Rupert EQ 773 plug-in parameters

Rupert EQ 773 is a processor that emulates the equalizer section built into numerous classic consoles developed by Rupert Neve during the 1960s and 1970s. It accurately models this peerless EQ that is loved by engineers around the world and has been used on numerous historic sessions. With a distinctive EQ curve and rich overtones, this unit is notable for the way in which slight adjustments in the gain can produce vivid changes in the sound's expressiveness and sense of airiness. Even large EQ boosts do not fatigue the ear, but still allow the musical component of the source to be emphasized. When the EQ is used to cut, or when the HPF is turned on, the sound becomes solid, yet without impairing the presence of that region, allowing you to control the tone while preserving the musical balance. Also, the EQ precisely emulates the input and output circuits that make lavish use of audio transformers and discrete class-A amps (which are the signature of Rupert Neve). Simply passing the signal through these circuits enhances the solidity of the sound, letting you obtain the depth and spaciousness associated with the Rupert Neve sound.

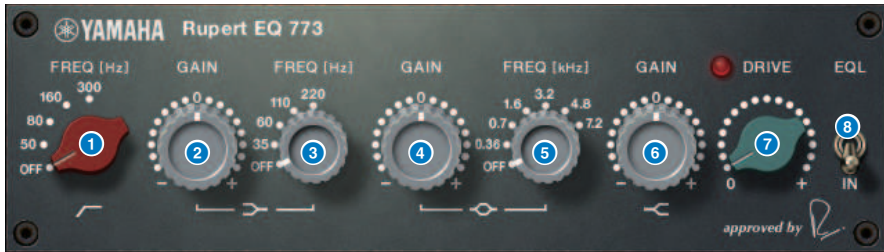

- 1 **LC FREQ knob**
Selects the frequency of the low cut filter.
- 2 **LF GAIN knob**
Adjusts the gain of the low shelving filter.
- 3 **LF FREQ knob**
Selects the frequency of the low shelving filter.
- 4 **MF GAIN knob**
Adjusts the peaking gain.
- 5 **MF FREQ knob**
Selects the peaking frequency.
- 6 **HF GAIN knob**
Adjusts the gain of the high shelving filter.
- 7 **DRIVE knob**
Adjusts the amount of head amp overtones.
- 8 **EQL switch**
Switches the equalizer on/off.

Controlling the Rupert EQ 810 plug-in parameters

Rupert EQ 810 is a processor that emulates the equalizer section built into the top recording consoles developed by Rupert Neve during the 1980s. A notable aspect of this EQ is that whether it is used to boost or to cut, the tonal changes it produces are effective and easy to understand. In contrast to the dramatic sound of Rupert EQ773, this provides refined, detailed, and smooth tonal change, while also giving you a broad range of control, making it an all-around EQ that lets you create the sound you want. By using VCM technology, this EQ precisely models the meticulously designed audio transformer and amp circuit. Simply passing the signal through the EQ will improve the definition of the sound, and ring it to the foreground. In particular, this is ideal for channels you want to sound more present, adding a bright, colorful, and rich spatiality to the sound.

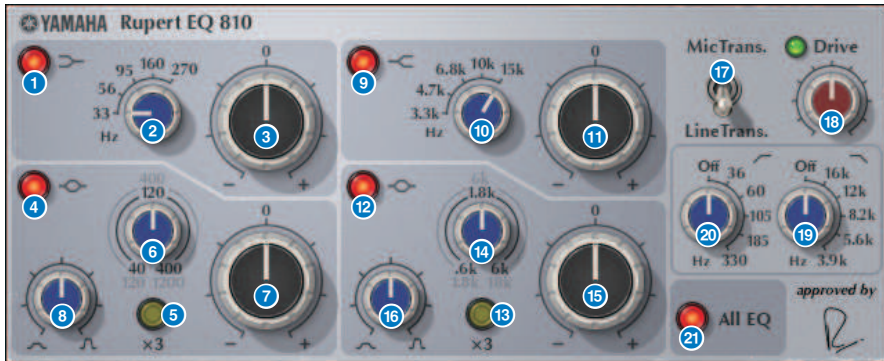

- 1 **LF IN button**
Switches the LF band (low shelving) on/off.
- 2 **LF FREQ knob**
Adjusts the cutoff frequency of the LF band (low shelving).
- 3 **LF GAIN knob**
Adjusts the gain of the LF band (low shelving).
- 4 **LMF IN button**
Switches the LMF band (peaking) on/off.
- 5 **LMF x3 button**
Triples the center frequency value of the LMF band (peaking).
- 6 **LMF FREQ knob**
Adjusts the center frequency of the LMF band (peaking).
- 7 **LMF GAIN knob**
Adjusts the gain of the LMF band (peaking).
- 8 **LMF Q knob**
Adjusts the Q (steepness) of the LMF band (peaking).

- 9 **HF IN button**
Switches the HF band (high shelving) on/off.
- 10 **HF FREQ knob**
Adjusts the cutoff frequency of the HF band (high shelving).
- 11 **HF GAIN knob**
Adjusts the gain of the HF band (high shelving).
- 12 **HMF IN button**
Switches the HMF band (peaking) on/off.
- 13 **HMF x3 button**
Triples the center frequency value of the HMF band (peaking).
- 14 **HMF FREQ knob**
Adjusts the center frequency of the HMF band (peaking).
- 15 **HMF GAIN knob**
Adjusts the gain of the HMF band (peaking).
- 16 **HMF Q knob**
Adjusts the Q (steepness) of the HMF band (peaking).
- 17 **TRANS. switch**
Switches the type of input transformer that is emulated. You can choose a mic input transformer or a line input transformer.
- 18 **DRIVE knob**
Adjusts the input level to adjust the amount of overtones. If the “DRIVE indicator” at the upper left of the DRIVE knob is bright green, the overtone amount is appropriate.
- 19 **LPF FREQ knob**
Adjusts the cutoff frequency of the high pass filter.
- 20 **HPF FREQ knob**
Adjusts the cutoff frequency of the low pass filter.
- 21 **ALL EQ button**
Turns the LF/LMF/HMF/HF bands on/off together. (This does not affect HPF/LPF.) If the ALL EQ button is off, you cannot use the LF IN, LMF IN, HMF IN, or HF IN buttons to turn individual bands on/off.

Controlling the Portico 5033 plug-in parameters

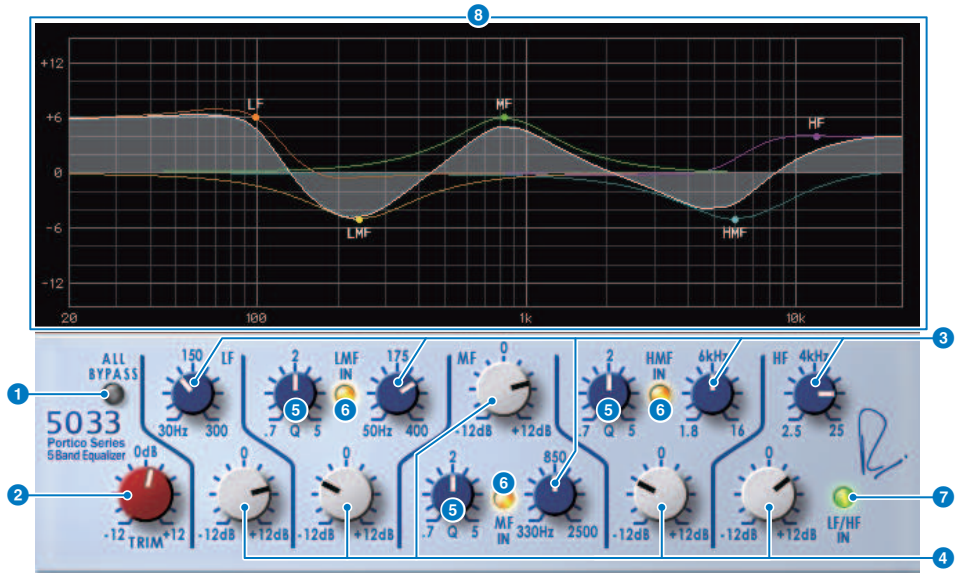

- 1 **ALL BYPASS button**
Switches EQ bypass on/off. Even in the bypassed state, the signal passes through the input/output transformer and amp circuit.
- 2 **TRIM knob**
Adjusts the input gain of the effect.
- 3 **LF/LMF/MF/HMF/HF frequency knobs**
Adjust the frequency of each band.
- 4 **LMF/MF/HMF Q knobs**
Adjust the Q (steepness) of each band. Increasing the Q value will narrow the range whose gain is controlled in that band.
- 5 **LMF/MF/HMF IN buttons**
Turn the EQ on/off for the LMF/MF/HMF bands respectively.
- 6 **LF/HF IN buttons**
Turn the EQ on/off for the LF and HF bands simultaneously.
- 7 **Graph display**
Visually indicates the EQ response.

Controlling the EQ-1A plug-in parameters

EQ-1A is a processor that emulates a vintage EQ that is considered the classic passive EQ. It uses a distinctive style of operation, with controllable boost and attenuation (cut) for each of two regions, low and high. The frequency response is completely different from that of a typical EQ, giving this model its unique character. The input/output circuit and vacuum tubes also give the sound an extremely musical character, producing a well-balanced sound.



- 1 IN switch**

Switches the processor on/off. If this is off, the filter section is bypassed but the signal passes through the input/output transformer and amp circuit.
- 2 LOW FREQUENCY knob**

Adjusts the frequency of the low-range filter.
- 3 (LOW) BOOST knob**

Adjusts the amount of boost for the frequency region specified by the LOW FREQUENCY knob.
- 4 (LOW) ATTEN knob**

Adjusts the amount of attenuation for the frequency region specified by the LOW FREQUENCY knob.
- 5 BAND WIDTH knob**

Specifies the width of the band controlled by the high-range filter. Turning the knob toward the right (Broad) makes the band wider and also lowers the peak level. This affects only the response of the boost.
- 6 HIGH FREQUENCY knob**

Adjusts the frequency of the high-range filter. This affects only the response of the boost.
- 7 (HIGH) BOOST knob**

Adjusts the amount of boost for the frequency region specified by the HIGH FREQUENCY knob.
- 8 (HIGH) ATTEN knob**

Sets the amount of attenuation applied to the frequency band specified by the ATTEN SEL knob.
- 9 (HIGH) ATTEN SEL knob**

Switches the frequency band to which attenuation is applied by the ATTEN knob.

Controlling the Equalizer601 plug-in parameters

Equalizer601 emulates the characteristics of an analog equalizer of the 1970s. It can create a sense of drive by reproducing the distortion that is distinctive of an analog circuit.



- 1 Frequency response curve graph**

Shows the frequency response curve of all bands combined, and the frequency response curve of each band. You can change the filter frequency or gain by dragging the line in the graph using the mouse.
- 2 +/- buttons**

Zoom-in or out the vertical axis of the graph display.
- 3 TYPE switch**

Selects one of two equalizer types with different effects. DRIVE emulates the changes in frequency response produced by an analog circuit, adding distortion to create a sense of drive in which the analog character is emphasized. CLEAN produces a clear, undistorted sound that is typical of digital, while emulates the changes in frequency response produced by an analog circuit.
- 4 INPUT knob**

Adjusts the input level.
- 5 Level meters**

Indicates the output level of the effect.
- 6 OUTPUT knob**

Adjusts the output gain.



- 7 **FLAT button**
Resets the gain of all bands to 0 dB.
- 8 **Q/TYPE knobs**
Control the shape of the frequency response curve for the filter of each band. For MID 1–4 you can set the steepness (Q) of the frequency response curve. For the LO band and HI band, you can individually specify one of four filter types.
- 9 **F (frequency) knobs**
Specify the center frequency of each filter.
- 10 **G (gain) knobs**
Specify the gain of each filter.
- 11 **SW button**
Toggle each filter on/off. Bands whose filter is turned off are disabled.

Controlling the Dynamic EQ plug-in parameters

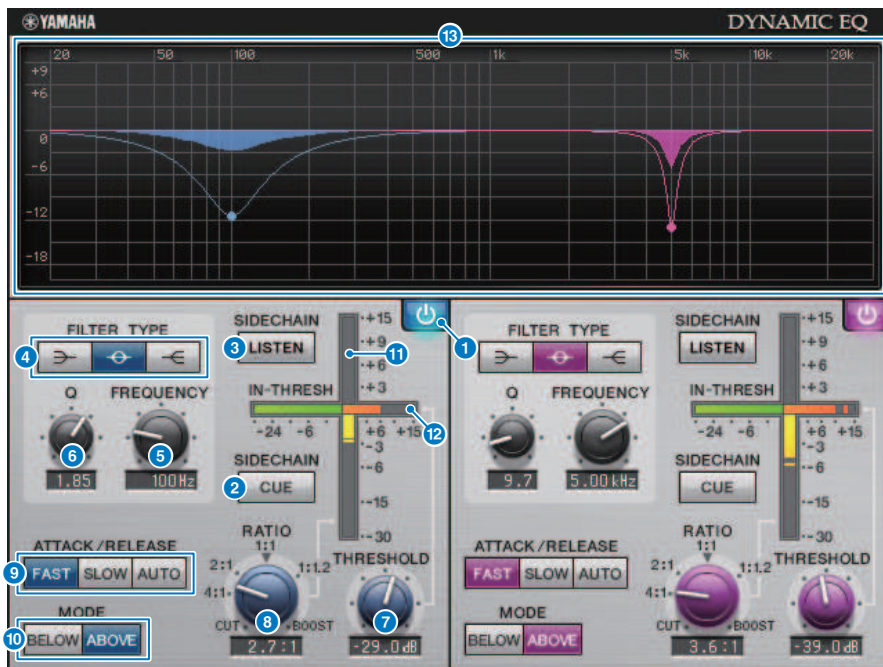
Dynamic EQ is a newly developed equalizer; it does not emulate any specific model. It provides a filter through which the same frequency band as the EQ is extracted to a sidechain, allowing the EQ gain to be varied dynamically when a specific band of the input signal becomes louder or softer, so that EQ is applied just as you might apply a compressor or expander to a specific frequency band. For example, by using this on a vocal as a de-esser, you can apply EQ to only that specific band when sibilants and high-frequency scratchy sounds reach an obtrusive level, obtaining a natural sound without impairing the original character. There are two full-band Dynamic EQ units, so you can use them on a variety of material.



- 1 **BAND ON/OFF button**
Switches the corresponding band on/off.
- 2 **SIDECHAIN CUE button**
If this button is on, the sidechain signal is sent to the CUE bus for monitoring. In this case, the graph shows the response of the sidechain filter.
- 3 **SIDECHAIN LISTEN button**
If this button is on, the sidechain signal linked to the dynamics is output to the bus (e.g., STEREO bus or MIX/MATRIX bus) to which the inserted channel is being sent. In this case, the graph shows the response of the sidechain filter.
- 4 **FILTER TYPE buttons**
Switch the type of the main bus equalizer and sidechain filter. The main EQ and sidechain filter are linked as follows.

FILTER TYPE			
	(Low Shelf)	(Bell)	(Hi Shelf)
Main EQ	Low Shelf	Bell	Hi Shelf
Sidechain filter	LPF	BPF	HPF

5 FREQUENCY knob

Specifies the frequency that is controlled by the equalizer and the sidechain filter.

6 Q knob

Specifies the Q (steepness) of the equalizer and the sidechain filter. Turning the knob toward the right will broaden the region affected by the equalizer and sidechain filter.

7 THRESHOLD knob

Specifies the threshold value at which the processing effect begins to apply.

8 RATIO knob

Specifies the ratio of boost/cut for the input signal. Turning this toward the right applies boost, and turning it toward the left applies cut; turning the knob all the way in either direction produces the maximum effect.

9 ATTACK/RELEASE buttons

Enable you to select one of three settings for the attack time and release time at which compression or boost is applied. FAST produces a fast attack and fast release, SLOW produces a fast attack and slow release, and AUTO automatically adjusts the attack and release according to the frequency region.

10 MODE button

Specify whether processing operates when the sidechain signal exceeds the threshold value (ABOVE) or when it falls below it (BELOW).

11 EQ GAIN meter

Indicates the gain of the dynamically changing EQ.

12 THRESHOLD meter

Indicates the level of the sidechain signal, referenced to the threshold level.

13 Graph display

Indicates the response of the equalizer. Normally this area shows the reference EQ graph, which indicates the frequency and depth; and the dynamic EQ graph, which indicates the response of the dynamically changing EQ. If SIDECHAIN CUE or SIDECHAIN LISTEN is on, this graph shows the response of the sidechain filter.

Plug-ins > Controlling the Dynamic EQ plug-in parameters

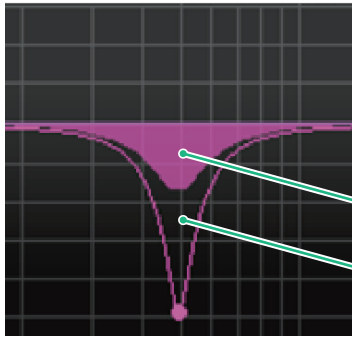

Dynamic EQ graph

Reference EQ graph

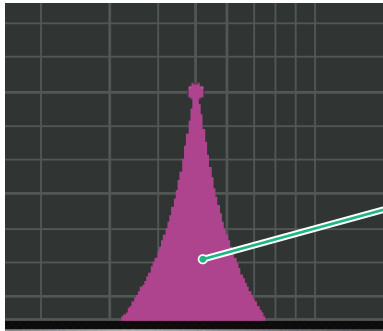

Sidechain filter graph

Controlling the Dynamic EQ4 plug-in parameters

Dynamic EQ4 is a two-band dynamic equalizer that has been expanded to have four bands. The extra bands provide broader sound-shaping capability, and a KEY IN source selection function enables a variety of new applications. For example, if Dynamic EQ4 is applied to acoustic guitar and the vocal microphone is selected as the KEY IN source, the guitar midrange can automatically be dipped a little whenever the vocals come in, to give the vocals more space and make them stand out. Also, de-essing effects have been improved through modifications to the algorithm for making a high-shelf cut.

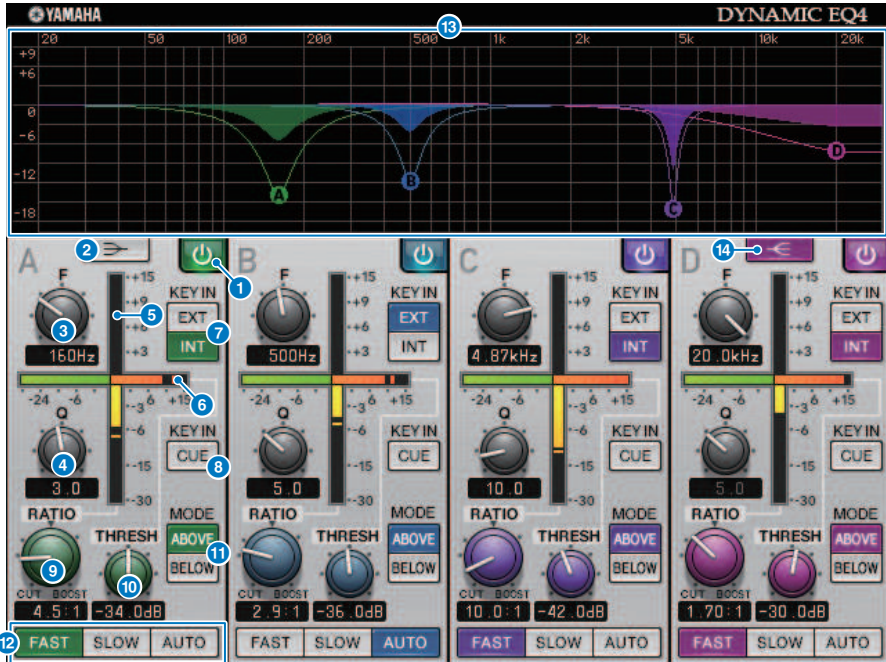

- 1 **BAND ON/OFF button**
Switches the corresponding band on/off.
- 2 **LOW SHELVE ON/OFF button**
Turn on this button to switch the LOW band to a shelving type filter, and switch the sidechain filter from BPF to LPF.
- 3 **FREQUENCY knob**
Specifies the frequency that is controlled by the equalizer and the sidechain filter.
- 4 **Q knob**
Specifies the Q (steepness) of the equalizer and the sidechain filter. Turning the knob toward the right will broaden the region affected by the equalizer and sidechain filter.

- 5 EQ GAIN meter**
Indicates the gain of the dynamically changing EQ.
- 6 THRESHOLD meter**
Indicates the level of the sidechain signal, referenced to the threshold level.
- 7 KEY IN source buttons**
Select main (INT) or external (EXT) as the source for the KEY IN signal used for the corresponding band.
- 8 KEY IN CUE button**
If this button is on, the sidechain signal is sent to the CUE bus for monitoring. In this case, the graph shows the response of the sidechain filter.
- 9 RATIO knob**
Specifies the ratio of boost/cut for the input signal. Turning this toward the right applies boost, and turning it toward the left applies cut; turning the knob all the way in either direction produces the maximum effect.
- 10 THRESHOLD knob**
Specifies the threshold value at which the processing effect begins to apply.
- 11 MODE button**
Specify whether processing operates when the sidechain signal exceeds the threshold value (ABOVE) or when it falls below it (BELOW).
- 12 ATTACK/RELEASE buttons**
Enable you to select one of three settings for the attack time and release time at which compression or boost is applied. FAST produces a fast attack and fast release, SLOW produces a fast attack and slow release, and AUTO automatically adjusts the attack and release according to the frequency region.
- 13 Graph display**
Indicates the response of the equalizer. Normally this area shows the reference EQ graph, which indicates the frequency and depth; and the dynamic EQ graph, which indicates the response of the dynamically changing EQ. If KEY IN CUE is on, this graph shows the response of the sidechain filter.
- 14 HIGH SHELVING ON/OFF button**
Turn on this button to switch the HIGH band to a shelving type filter, and switch the sidechain filter from BPF to HPF.

Controlling the Rupert Comp 754 plug-in parameters

Rupert Comp 754 is a processor that emulates the compressor/limiter section built into numerous classic consoles developed by Rupert Neve during the 1960s and 1970s. It is a model that lies at the root of the bus compressors used as standard items in studios and broadcast stations, and is noted for its smooth and natural compression sound that does not impair the expressive power of the source. By using VCM technology, this compressor models the circuits that make lavish use of the audio transformers and discrete class-A amps (which are the signature of Rupert Neve). Simply applying the compressor lightly will help you obtain the rich, solid Rupert Neve sound. Even if applied deeply, it will not produce ear-fatiguing peaks or cause the sound to break up, allowing you to retain the natural tonality while controlling the dynamics and enhancing the depth and power of the sound.

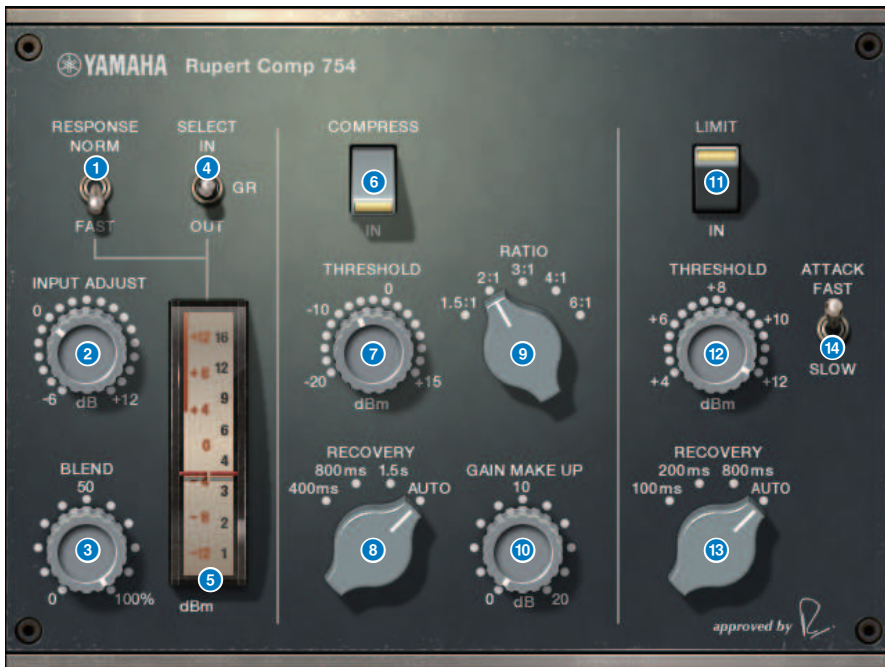

1 METER RESPONSE switch

Selects the meter response speed.

2 INPUT ADJUST knob

Adjusts the input gain. However, the output gain changes inversely in tandem with the level of this knob so that the volume remains the same as the pass-through volume (the volume when COMP IN and LIMIT IN are off). For example if INPUT ADJUST is +5 dB, the input gain is +5 dB and the output gain is -5 dB.

INPUT ADJUST can be used in the following ways.

- If the input signal level to the effect is too low to reach the threshold, you can raise the input gain.
- You can change the input level to the input circuit (audio transformer or class-A amp) in order to modify the tonal character.

[How INPUT ADJUST works]

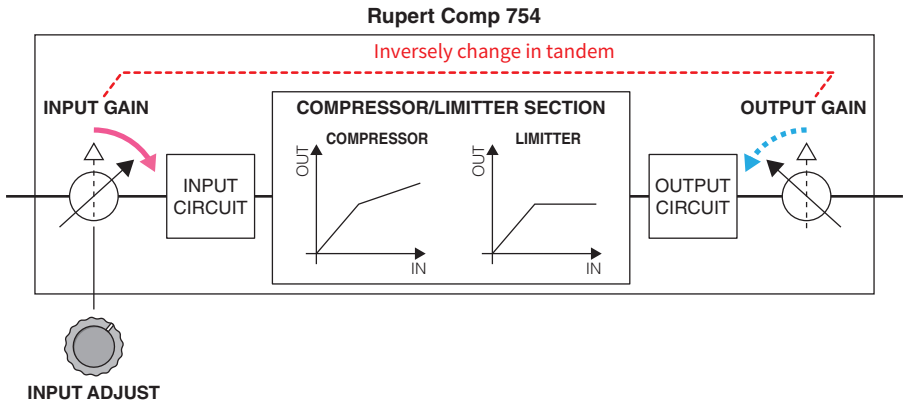

- 3 **BLEND knob**
Adjusts the dry/wet balance of the compressor/limiter.
- 4 **METER SELECT switch**
Selects the signal source of the meter as input level, output level, or gain reduction.
- 5 **Meter**
Indicate the signal that is selected by the METER SELECT switches.
- 6 **COMPRESS IN switch**
Switches the compressor on/off.
- 7 **COMPRESS THRESHOLD knob**
Adjusts the threshold of the compressor.
- 8 **COMPRESS RECOVERY knob**
Adjusts the release time of the compressor. With the AUTO setting, the release time changes automatically in the range of 50 ms to 5 sec.
- 9 **COMPRESS RATIO knob**
Adjusts the ratio of the compressor.
- 10 **COMPRESS GAIN knob**
Adjusts the makeup gain of the compressor. This applies before the limiter stage.
- 11 **LIMIT IN switch**
Switches the limiter on/off.
- 12 **LIMIT THRESHOLD knob**
Adjusts the threshold of the limiter.

- 13** **LIMIT RECOVERY knob**

Selects the release time of the limiter. With the AUTO setting, the release time changes automatically in the range of 50 ms to 5 sec.
- 14** **LIMIT ATTACK switch**

Switches the attack time of the limiter. FAST: 2ms, SLOW: 3ms

Controlling the Rupert Comp 830 plug-in parameters

Rupert Comp 830 is a processor that emulates the compressor section built into the top recording consoles developed by Rupert Neve during the 1980s. In addition to providing a broad range of control for Attack and Release, this compressor provides an EQ and filter on the sidechain, giving you an extremely broad range of tone-shaping possibilities, and letting you create nearly any sound. The compression is transparent and smooth-sounding, and can be used on any source in any situation. By using VCM technology, this compressor models a circuit with a further-evolved audio transformer by Rupert Neve. A shiny, colorful, and well-defined sound can be obtained simply by routing the signal through this processor.

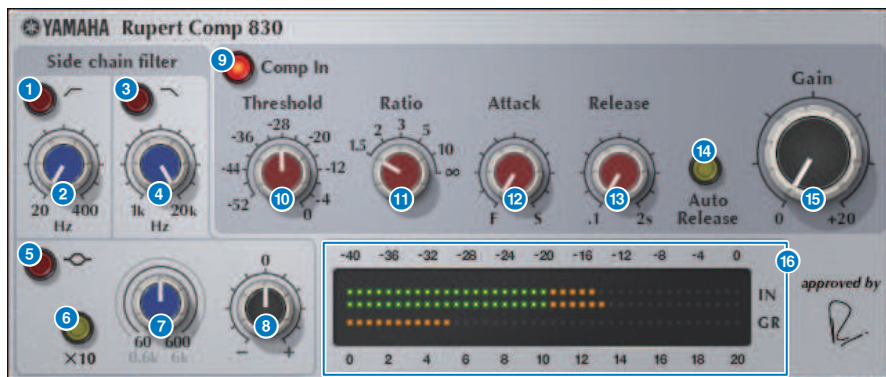

- 1 **HPF ON button**
Toggles the sidechain's high pass filter on/off.
- 2 **HPF FREQ button**
Adjusts the cutoff frequency of the sidechain's high pass filter.
- 3 **LPF ON button**
Toggles the sidechain's low pass filter on/off.
- 4 **LPF FREQ knob**
Adjusts the cutoff frequency of the sidechain's low pass filter.
- 5 **MF ON button**
Toggles the sidechain's MF band (peaking) on/off.
- 6 **MF FREQ x10 button**
Switches the sidechain's MF band (peaking) center frequency to 10 times its value.
- 7 **MF FREQ knob**
Adjusts the sidechain's MF band (peaking) center frequency.
- 8 **MF GAIN knob**
Adjusts the gain of the sidechain's MF band (peaking).

9

COMP IN button

Switches the compressor on/off.

10

THRESHOLD knob

Adjusts the threshold of the compressor.

11

RATIO knob

Adjusts the ratio of the compressor.

12

ATTACK knob

Adjusts the attack time of the compressor.

13

RELEASE knob

Adjusts the release time of the compressor. Adjusts the release time of the compressor.

14

AUTO RELEASE button

Toggles the compressor's auto release on/off.

15

GAIN knob

Adjusts the gain of the compressor.

16

Meter

Indicate the input level and the gain reduction.

Controlling the Portico 5043 plug-in parameters

Portico 5043 is a processor that emulates an analog compressor made by Rupert Neve Designs, as was the Portico 5033. The actual 5043 compressor featured the input/output transformer that was also provided on the 5033 EQ, and its natural, analog-like tonal character and method of action makes it widely usable for any source from drums to vocals. Its greatest feature is that the gain reduction type can be switched. You can switch between the FF (Feed-Forward) circuit gain reduction that is currently mainstream and the FB (Feed-Back) circuit used on vintage compressors, letting you create differing characters of sound as needed.

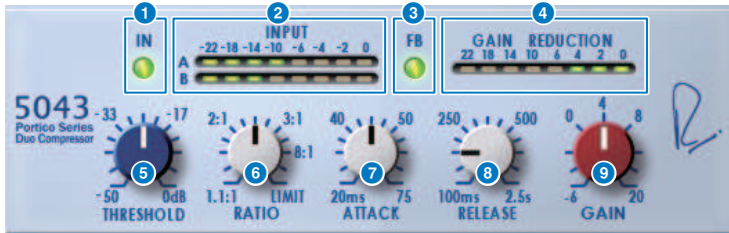

1 IN button

Switches compressor bypass on/off. When bypassed, the button is unlit. However even in the bypassed state, the signal passes through the input/output transformer and amp circuit.

2 INPUT meter

Shows the level of the input signal. One meter is shown in the case of DUAL, and two meters in the case of STEREO.

3 FB button

Switches the gain reduction method between a FF (Feed-Forward) circuit and a FB (Feed-Back) circuit. The button is lit if the FB circuit type is selected. The FF circuit is the type used by most compressors today. Use it when you want to apply firm compression while minimizing changes in the tonal character. The FB circuit is the type used by vintage compressors. Use it when you want to apply smooth compression while adding device-specific coloration to the sound.

4 GAIN REDUCTION meter

Indicates the amount of gain reduction.

5 THRESHOLD knob

Adjusts the level at which the compressor begins to apply.

6 RATIO knob

Adjusts the compression ratio. If the knob is turned all the way to the right, this becomes a limiter.

7 ATTACK knob

Adjusts the attack time over which the compressor begins to apply.

8 RELEASE knob

Adjusts the release time of the compressor.

9 GAIN knob

Adjusts the output gain.

Controlling the Portico 5045 plug-in parameters

This is a processor that accurately models the Portico 5045 Primary Source Enhancer made by Rupert Neve Designs. Operation is extremely easy, allowing you to suppress background noise that enters the mic while increasing clarity, enhancing the primary source and also improving the feedback margin. It is suitable not only for a hand-held mic but also for a lavalier mic or headset mic, and can be used in a variety of situations including event PA, concerts, or broadcast. This processor is also equipped with the audio transformer and discrete amp circuit that are the signature of the Portico series, so that simply passing the signal through it will increase the luster and depth of the sound.



- 1 **PROCESS ENGAGE button**
Turns the enhancement circuit on/off.
- 2 **RMS/Peak button**
Selects the operation mode for the level detector. You can select RMS mode or Peak mode.
- 3 **TIME CONSTANT knob**
Switches the attack time and release time. The settings are as follows.

RMS Mode	Peak Mode
A: 50 ms	Attack: fixed at 20 ms
B: 100 ms	Release:
C: 200 ms	A: 20 ms
D: 750 ms	B: 200 ms
E: 1.5 s	C: 1 s
F: 3 s	D: 2 s
	E: 5 s
	F: 30 s

- 4 **THRESHOLD knob**
Adjusts the level at which enhancement begins. Signals below the THRESHOLD are attenuated.
- 5 **PROCESS ACTIVE indicator**
This indicator is lit when the input signal exceeds the THRESHOLD. Adjust the THRESHOLD so that this indicator is lit when the primary audio source is being input, and unlit during periods of silence or between phrases.
- 6 **DEPTH knob**
Adjusts the amount of attenuation for signals below the THRESHOLD.

Controlling the U76 plug-in parameters

U76 is a processor that emulates a standard vintage compressor used in a wide variety of situations. It does not provide the threshold parameter that is typically found on a compressor; instead, the compressor's effect is adjusted by the balance between the input gain and output gain. Setting the **RATIO** parameter to “All mode” produces an extremely powerful compression sound that is considered to be the character of this model. It adds rich overtones that produce an aggressive-sounding tonal character.

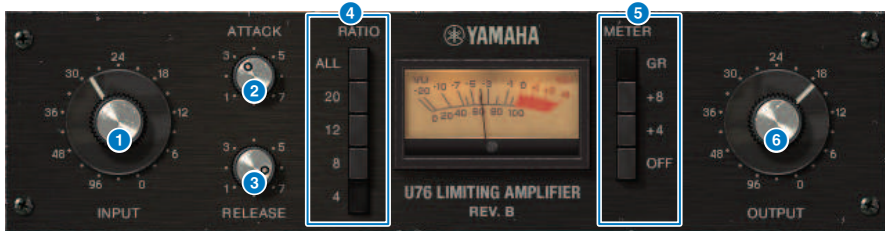

1 INPUT knob

Adjusts the input gain. As the input increases, the compressor's effect also becomes stronger.

2 ATTACK knob

Adjusts the attack time over which the compressor begins to apply. Turning the knob all the way to the right produces the fastest attack time.

3 RELEASE knob

Adjusts the release time of the compressor. Turning the knob all the way to the right produces the fastest release time.

4 RATIO switching buttons

Use these five buttons to set the compression ratio. Buttons with higher numbers produce a higher compression ratio. Pressing the **ALL** button selects All mode, which not only raises the **RATIO** but also makes the release faster, producing sharp compression with a distorted, aggressive sound.

5 METER switching buttons

Switch the meter display.

- **GR**: The amount of gain reduction applied by the compressor is shown.
- **+4/+8**: With the reference of the output signal level as -18 dB, a value of $+4$ dB or $+8$ dB relative to that reference is shown as 0 VU.
- **OFF**: The meter display is turned off.

6 OUTPUT knob

Adjusts the output level. If you use the **INPUT** knob to adjust the amount of gain reduction, the perceptual volume will also change. In this case, use the **OUTPUT** knob to adjust the volume.

Controlling the Opt-2A plug-in parameters

Opt-2A is a processor that emulates a standard vintage model of vacuum tube optical compressor. The level is controlled using optical components such as a CdS-Cell and EL panel to produce smooth compression. The beautiful high-frequency overtones in the warm distortion created by the vacuum tube circuit generate an elegant and sophisticated sound.



1 GAIN knob

Adjusts the output level.

2 PEAK REDUCTION knob

Adjusts the compression amount of the signal.

3 RATIO knob

Adjusts the compression ratio.

4 METER SELECT knob

GAIN REDUCTION shows the amount of gain reduction when the compressor is operating. With the OUTPUT +10 or OUTPUT +4 settings, the output signal level reference is considered as -18 dB, and a value of +10 dB or +4 dB relative to that reference is shown as 0 VU.

Controlling the Comp276 plug-in parameters

Comp276 emulates the characteristics of a sought-after analog compressor commonly used in recording studios. It produces a thick and solid sound that is suitable for drums or bass.



- 1 INPUT knob**
Adjusts the input level.
- 2 RATIO knob**
Adjusts the ratio of the compressor.
- 3 ATTACK knob**
Adjusts the attack time of the compressor.
- 4 OUTPUT knob**
Adjusts the output gain.
- 5 AUTO MAKEUP switch**
If this switch is on, the decrease in the output gain when the compressor is applied will be compensated automatically.
- 6 SIDECHAIN HPF switch**
If this switch is on, the compressor applies less to the low-frequency region, strengthening the low-frequency output.
- 7 RELEASE knob**
Adjusts the release time of the compressor.
- 8 VU meters**
Indicate the signal that is selected by the GR/-10/-20/OFF switches.
- 9 GR/-10/-20/OFF switches**
Select the signal that is monitored by the VU meters.
GR: Indicates the amount of gain reduction.
-10: The signal with -10 dBu as 0 VU is shown.
-20: The signal with -20 dBu as 0 VU is shown.
OFF: The VU meter is off.

Controlling the Buss Comp 369 plug-in parameters

Buss Comp 369 emulates a standard bus compressor that has been used in recording studios and broadcasting stations since the 1980s. It produces smooth, natural compression that does not interfere with source signal nuances, in contrast with the aggressive compression of the U76. Buss Comp 369 includes a compressor and a limiter that you can use individually or in combination. The rich overtones generated by the audio input and output transformers and discrete class-A circuitry are modeled too, adding depth and unity to the sound.

Stereo mount



Dual mount



1 INPUT ADJUST knob

Adjusts the input gain. However, the output gain changes inversely in tandem with the level of this knob so that the volume remains the same as the pass-through volume (the volume obtained when COMP IN and LIMIT IN are off). For example if INPUT ADJUST is +5 dB, the input gain is +5 dB and the output gain is -5 dB.

[How INPUT ADJUST works]

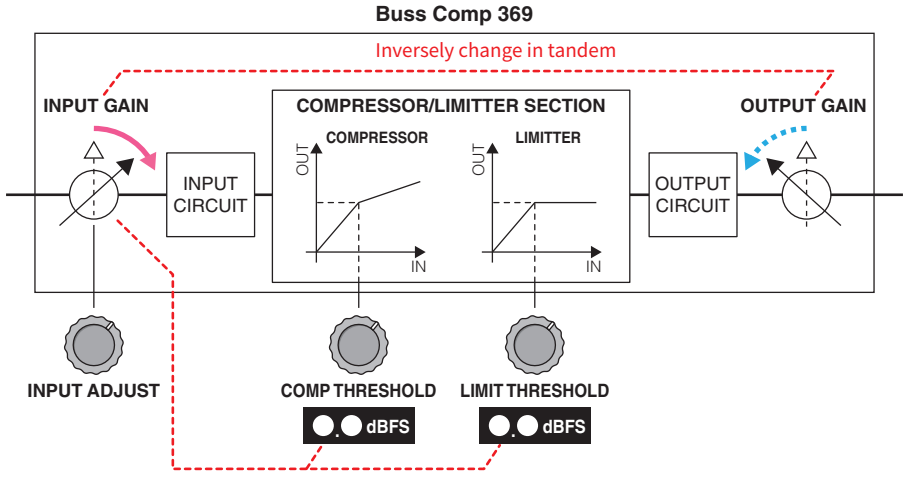

Practically, since the threshold changes, the indicated value will change in tandem. However, the internal status of the COMPRESSOR/LIMITER section will not change.

Practically, since the threshold changes, the indicated value will change in tandem. However, the internal status of the , COMPRESSOR/LIMITER section will not change.

- 2 **LINK switch (for Stereo mount)**
Turns the stereo link on/off
- 3 **COMP IN switch**
Turns the compressor on/off.
- 4 **COMP THRESHOLD knob**
Adjusts the threshold of the compressor. Note that the value changes in tandem with the INPUT ADJUST setting.
- 5 **COMP RECOVERY knob**
Adjusts the release time of the compressor. For a1 (auto 1) and a2 (auto 2), the release time changes automatically.
a1: automatically changes in the range of 100 ms to 2sec.
a2: automatically changes in the range of 50 ms to 5 sec.

- 6 COMP GAIN knob**
Adjusts the makeup gain of the compressor. This applies before the limiter stage.
- 7 COMP RATIO knob**
Specifies the compressor ratio.
- 8 METER SELECT switch (for Stereo mount)**
Selects the signal source of the meter. You can select from IN (input level) /GR (gain reduction) / OUT (output level). If you change this selection, the meter design also changes to VU, GR, or VU respectively.
- 9 VU SELECT switch (for Dual mount)**
Selects the signal source for the VU meter. You can select either the input level or output level.
- 10 LIMIT IN switch**
Turns the limiter on/off.
- 11 LIMIT ATTACK switch**
Specifies the attack time of the limiter.
FAST: 2 ms
SLOW: 4 ms
- 12 LIMIT THRESHOLD knob**
Adjusts the threshold of the limiter. Note that the value changes in tandem with the INPUT ADJUST setting.
- 13 LIMIT RECOVERY knob**
Selects the release time of the limiter. For a1 (auto 1) and a2 (auto 2), the release time changes automatically.
a1: automatically changes in the range of 100 ms to 2sec.
a2: automatically changes in the range of 50 ms to 5 sec.

Controlling the MBC4 plug-in parameters

This high-quality four-band compressor utilizes VCM technology and features a GUI that offers outstanding operability and visibility. All advantages of the musical behavior of analog compressors have been built into the gain reduction circuitry of the MBC4, allowing smooth control of dynamics while retaining the overall image of the original sound. The sound image can also be visually manipulated via a graphical display.

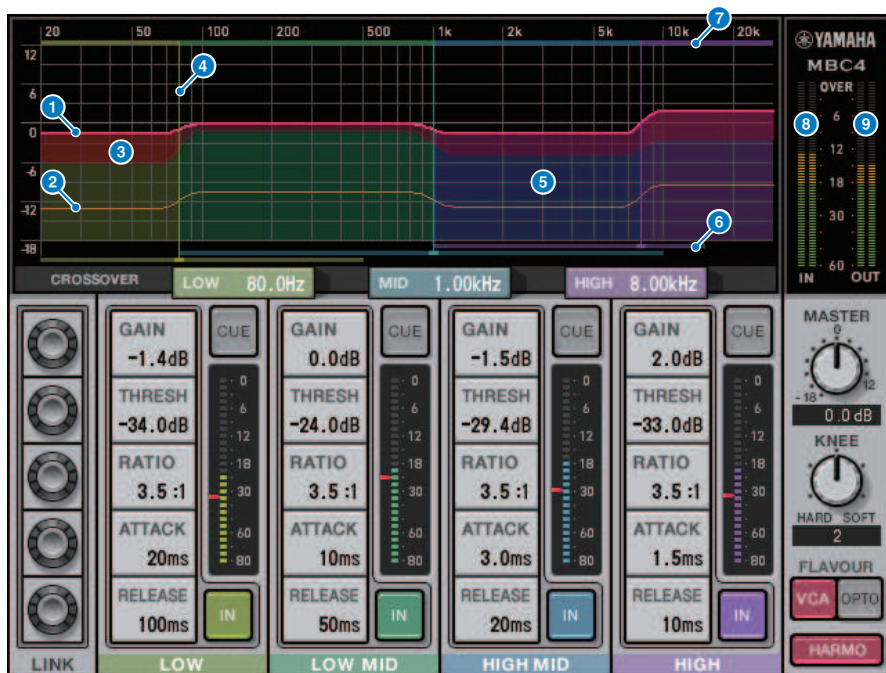

1 GAIN LINE

This red horizontal line indicates the GAIN parameter values for the corresponding band.

2 MAXIMUM GR GUIDELINE

This orange horizontal line indicates a guideline for the maximum gain reduction. This amount is approximate, and does not necessarily show a precise maximum gain reduction amount.

3 GR ZONE

This red area changes according to the gain reduction amount for the corresponding band.

4 CROSSOVER LINE

This vertical line indicates the crossover point for the corresponding band.

5 CROSSOVER ZONE

This band-color area changes according to the CROSSOVER parameter value for the corresponding band.

6 CROSSOVER RANGE

This band-color horizontal bar graph indicates a variable range of the CROSSOVER parameter value for the corresponding band.

7 CROSSOVER BAND WIDTH

This band-color horizontal bar graph changes according to the CROSSOVER parameter value for the corresponding band.

8 INPUT meter

Shows the level of the input signal. One meter is shown in the case of DUAL, and two meters in the case of STEREO.

9 OUTPUT meter

Shows the level of the output signal. One meter is shown in the case of DUAL, and two meters in the case of STEREO.



10 GAIN

Adjusts the output gain for the corresponding band.

11 THRESHOLD

Adjusts the level at which the compressor begins to apply for the corresponding band. The value will be also indicated by a red marker on the INPUT meter.

12 RATIO

Adjusts the compression ratio for the corresponding band.

13 **ATTACK**

Adjusts the attack time at which the compressor begins to apply for the corresponding band.

14 **RELEASE**

Adjusts the release time of the compressor for the corresponding band.

15 **LINK knob**

If you select the parameter's LINK knob, the display color will change as shown below. The corresponding parameters for four bands will link together, and the values will change collectively. Note that if the parameter value of one of the bands reaches the maximum or minimum, the link operation will stop. Parameters that can be linked are displayed in the corresponding band color.

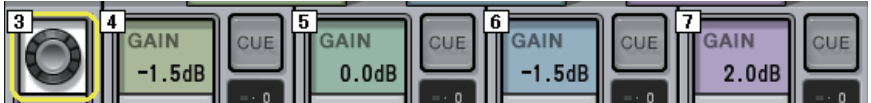

16 **CROSSOVER**

Adjusts the crossover frequencies used to divide the signal into bands.

17 **CUE button**

Press this button to cue-monitor the output of the corresponding band. If the IN button is off, a signal without compressor effects will be monitored. You can turn on the CUE buttons for multiple bands.

18 **MASTER GAIN knob**

Adjusts the gain of the final output signal.

19 **INPUT meter**

Displays the level of the audio signal input to each band.

20 **KNEE knob**

Adjusts the knee of the compressor.

21 **IN button**

Switches the compressor on/off for the corresponding band. Even if this button is off, you will be able to adjust the corresponding band parameters.

22 **FLAVOUR button**

Switches the type of the compressor between VCA (accurate effects) and OPTO (natural effects).

23 **HARMONICS button**

Switches on/off musical harmonics that emulate analog circuitry.

Controlling the DaNSe plug-in parameters

DaNSe is a dynamic noise suppressor with exceptional sound quality and operability, developed by K's Lab (Dr. K), of which Yamaha is a proud supporter. DaNSe features a revolutionary "learn" feature (LEARN), which analyzes noise frequency characteristics and applies automatic settings to provide the optimum noise suppression effect. The controls and graphics are designed in a way that's easy to understand, making settings quick through simple operations. DaNSe also allows for individually bands to be finely adjusted for handling even difficult noises. Although DaNSe can be used with a variety of mics, it works particularly well with mics intended for speech or lapel mics, suppressing fan noises such as from the air conditioning or moving lights onstage. It is also quite effective in suppressing various noises in theater settings, bringing greater clarity to the speaker's voice.



1 LOW FREQUENCY knob

Adjusts the lower limit frequency band for suppressing noise. This cannot be set to a frequency 1/4 higher than the HIGH FREQUENCY. As this uses a LEARN function to analyze the sound, you should adjust the frequency band before learning.

2 HIGH FREQUENCY knob

Adjusts the upper limit frequency band for suppressing noise. This cannot be set to a frequency less than 4x higher than the LOW FREQUENCY. As this uses a LEARN function to analyze the sound, you should adjust the frequency band before learning.

3 LEARN button

Starts the LEARN function. When the LEARN function starts working, the input signal will be analyzed for 10 seconds, and the THRESHOLD, GAIN 1–6 and internal signal processing parameters will automatically be adjusted to create the optimum noise suppression effect for the usage environment. After LEARN ends, adjust the THRESHOLD and TIGHTNESS a bit to your liking to achieve the sound quality that's even closer to what you had in mind. Pressing the LEARN button during learning or when closing the GUI will make the LEARN function stop.

Note: since the internal signal processing parameters as well are automatically adjusted, using LEARN in a different environment even with the same parameters displayed set in the same way may have different results. If scene recall or library recall are used during learning when Recall Safe is not on, the learning may fail.

4 REVERT

This reverts the parameters to their state just before using the LEARN function, if you have adjusted the parameters manually. The button will be enabled after learning.

5 TIGHTNESS knob

Adjusts the release time. Turning the knob to the right produces a shorter release time.

6 THRESHOLD

Adjusts the THRESHOLD for all bands.

7 LINK knob

This adjusts GAIN 1–6 simultaneously, while keeping their positions relative to each other.

8 GAIN 1–6

Adjust the maximum gain reduction for BAND 1–6.

Controlling the P2MB plug-in parameters

This is a processor that accurately models the Portico II Master Buss Processor made by Rupert Neve Designs. It has many functions required for master buses such as Compressor, Limiter, Stereo Field Editor, and Silk, and is useful in various situations such as live performances and broadcasting. The compressor has many functions such as RMS / Peak and FF / FB, in which the operation mode can be selected according to the sound source and purpose. By installing an adaptive release, Limiter operates optimally for various sound sources with single-knob operation. The Stereo Field Editor is a new design based on MS technology that allows you to manipulate the spatial image as you wish, and to add the natural comp and saturation of an audio transformer with Silk.

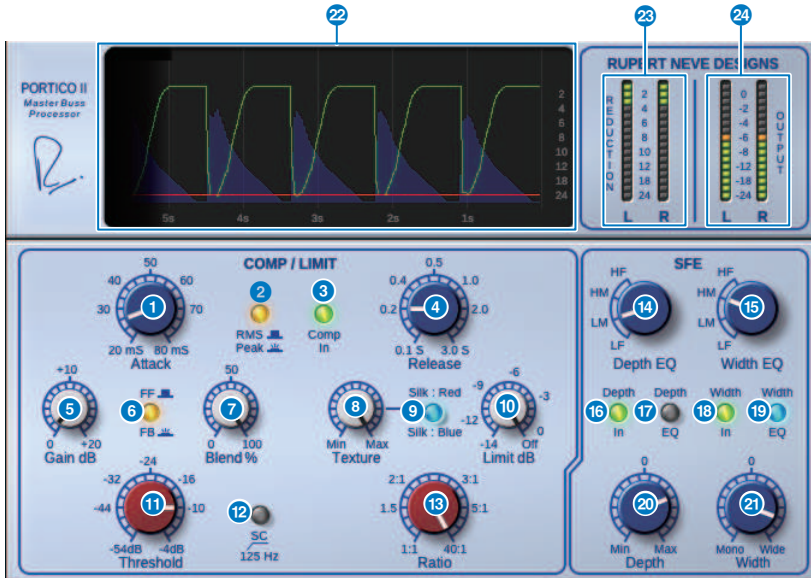

- 1 **Attack knob**
Adjusts the attack time of the compressor.
- 2 **RMS/Peak button**
Selects the operating mode for the compressor level detector. The button lights up in Peak mode.
- 3 **Comp In button**
Turns compressor and limiter bypass on and off. The button goes dark when bypass is on.
- 4 **Release knob**
Adjusts the release time of the compressor.
- 5 **Gain knob**
Adjusts the output gain of the compressor. It acts as an input gain to the limiter, and the limiter works to suppress the compressor with gain make-up.

6 FF/FB button

Switches the gain reduction method between a FF (Feed-Forward) circuit and a FB (Feed-Back) circuit. The button is lit if the FB circuit type is selected. The FF circuit is the type used by most compressors today. Use it when you want to apply firm compression while minimizing changes in the tonal character. The FB circuit is the type used by vintage compressors. Use it when you want to apply smooth compression while adding device-specific coloration to the sound.

7 Blend knob

Adjusts the dry / wet values of the compressor and limiter.

8 Texture knob

When Silk's Red / Blue is selected, this adjusts the tone including incidental overtones according to each character.

9 Silk button

Selects two characters, Silk OFF and Red / Blue. Even in the OFF state, the natural compression and saturation of the audio transformer is added, and you can also actively control the tone by selecting Red / Blue and using Texture. When it is OFF, the button goes dark, when it is Red, it lights up in red, and when it is Blue, it lights up in blue.

10 Limit knob

Adjusts the limiter threshold. Turn the knob all the way to the right to turn off the limiter. By installing an adaptive release, the optimum operation for various sound sources can be achieved simply by operating the Limit knob.

11 Threshold knob

Adjusts the threshold of the compressor.

12 SC 125Hz button

When turned on, the button lights up. By reducing the amount of compressor applied to the low frequencies, the output of the low frequencies is emphasized.

13 Ratio knob

Adjusts the ratio of the compressor.

14 Depth EQ knob

Selects the Depth EQ band from LF: low range, LM: mid-low range, HM: mid-high range, and HF: high range.

15 Width EQ knob

Selects the Width EQ band from LF: low range, LM: mid-low range, HM: mid-high range, and HF: high range.

16 Depth In button

Turns the effect of the Depth knob on / off. When on, the button lights up.

17 Depth EQ In button

When turned on, the button lights up, limiting the effect of the Depth knob to the band selected with the Depth EQ knob. When turned off, it goes out and the effect of the Depth knob is full band.

18 Width In button

Turns the effect of the Width knob on and off. When turned on, the button lights up.

- 19 **Width EQ In button**

When turned on, the button lights up, limiting the effect of the Depth knob to the band selected with the Width EQ knob. When turned off, it goes out and the effect of the Width knob is full band.
- 20 **Depth knob**

Adjusts the volume of stereo center localization.
- 21 **Width knob**

Adjusts the volume of stereo side localization. You can adjust the spread of the stereo image from mono to wide.
- 22 **History**

Lists the threshold value, Limit value, input level and GR amount for the previous five seconds.
- 23 **REDUCTION meter**

Indicates the amount of gain reduction by the compressor and limiter.
- 24 **OUTPUT meter**

Indicates the output level.

Controlling the Interphase parameters

Interphase is a tool that adjusts the phase between two sound sources, such as the bass mic and line, the front and back of a snare, or the inside and outside of a bass drum. It incorporates Delay, Polarity and a phase filter. By adjusting the phase, you can maximize the energy of the instrument or adjust the tone to your preferred sound. Interphase can capture the waveforms of the main and reference signals on a graph for easy visual time alignment. There is also a helpful correlation meter, which indicates the degree of agreement between waveforms. The Align function can also be used to automatically set Delay Time and Polarity. It also features a phase alignment filter (all-pass filter), which allows the user to adjust the phase according to the frequency response and more aggressively adjust the timbre.

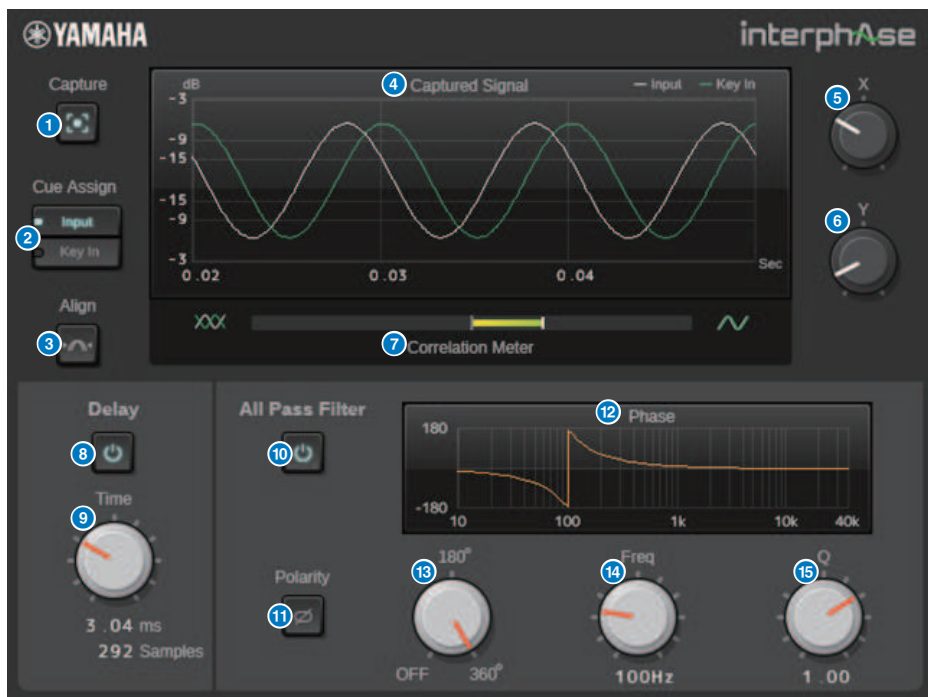

- 1 **Capture button**
While this is off, the graph functions as an oscilloscope. When it is turned on, capture begins and the plug-in automatically captures 40 ms of audio. After that, all parameter changes are then displayed on the graph.
- 2 **Cue Assign button**
Selects the output (input or key-in) to the cue bus.
- 3 **Align button**
Automatically sets the delay time and polarity. Available only if the signal is captured.
- 4 **Graph**
Displays the signal waveforms.

- 5 **X knob**
Selects the graph's X-axis scale.
- 6 **Y knob**
Selects the graph's Y-axis scale.
- 7 **Correlation meter**
Displays the degree of agreement between the main signal and the reference signal. A large swing to the right indicates a high degree of agreement, while a large swing to the left indicates a high degree of agreement but the opposite polarity. A small swing indicates that the degree of agreement is low.
- 8 **Delay button**
Enables delay.
- 9 **Time knob**
Sets the delay time.
- 10 **All Pass Filter button**
Enables all-pass filtering and polarity.
- 11 **Polarity button**
Reverses polarity.
- 12 **Phase Response graph**
Displays the all-pass filter's phase response.
- 13 **Order knob**
Switches the degree of phase rotation. Corresponds to the all-pass filter's degree. There is no filter when this is OFF.
- 14 **Frequency knob**
Adjusts the frequency of the all-pass filter. The 180° mode corresponds to a phase change of 90°, while the 360° mode corresponds to a change of 180°.
- 15 **Q knob**
Adjusts the slope of the phase change. This can only be used in 360° mode.

Controlling the OpenDeck plug-in parameters

OpenDeck emulates the tape compression created by two open reel tape recorders (a recording deck and a reproduction deck). You can change the sound quality by adjusting various elements, such as the deck type, tape quality, playback speed, etc.



- 1 RECORD: DECK TYPE**
Selects the recording deck type.
- 2 RECORD: LEVEL knob**
Adjusts the input level of the recording deck. As you raise the level, tape compression is generated, which narrows the dynamic range and distorts the sound.
- 3 RECORD: ADJUST HIGH knob**
Adjusts the high range gain of the recording deck.
- 4 RECORD: BIAS knob**
Adjusts the bias of the recording deck.
- 5 AUTO MAKE UP switch**
If you turn this switch on, when you adjust the level of the recording deck (by using the RECORD/REC LVL knob, the level of the reproduction deck (the REPRODUCE/REPR LVL] knob) will also change, maintaining the relative output level. You can change the amount of distortion without changing the output level.
- 6 REPRODUCE: DECK TYPE**
Selects the reproduction deck type.

7 REPRODUCE: LEVEL knob

Adjusts the output level of the reproduction deck.

8 REPRODUCE: ADJUST HIGH knob

Adjusts the high range gain of the reproduction deck.

9 VU ADJUST switch

When you turn this button on, the VU ADJUST knob, instead of the VU meter for Channel 2, appears in the meter section. If you turn this button off, the VU meter for Channel 2 appears.



VU ADJUST knob

Specifies the level assigned to 0VU on the VU meter. This knob will appear only if the VU ADJUST button is turned on.

10 SPEED switch

Selects the tape speed.

11 TAPE KIND switch

Selects the tape type.

12 RECORD/REPRO switch

Enables you to select RECORD (input to the recording deck) or REPRO (output from the reproduction deck) as the signals to be monitored via the level and VU meters.

13 Level meter

Shows the effect level of the monitoring signals selected via the RECORD/REPRO switch.

14 VU meters

The VU meters of the deck selected via the RECORD/REPRO switch are displayed here. The number of VU meters varies depending on the status of the VU ADJUST button. If the VU ADJUST button is turned on, the meter for one channel will be displayed. If the VU ADJUST button is turned off, the meters for two channels will be displayed.

Using the Tap Tempo function

“Tap tempo” is a function that lets you specify the delay time of a delay effect or the modulation speed of a modulation effect by striking a key at the desired interval. To use the Tap function, you must first assign Tap Tempo to a USER DEFINED key, and then operate that USER DEFINED key.

1 Assign one of TAP TEMPO 1–4 to a USER DEFINED key.

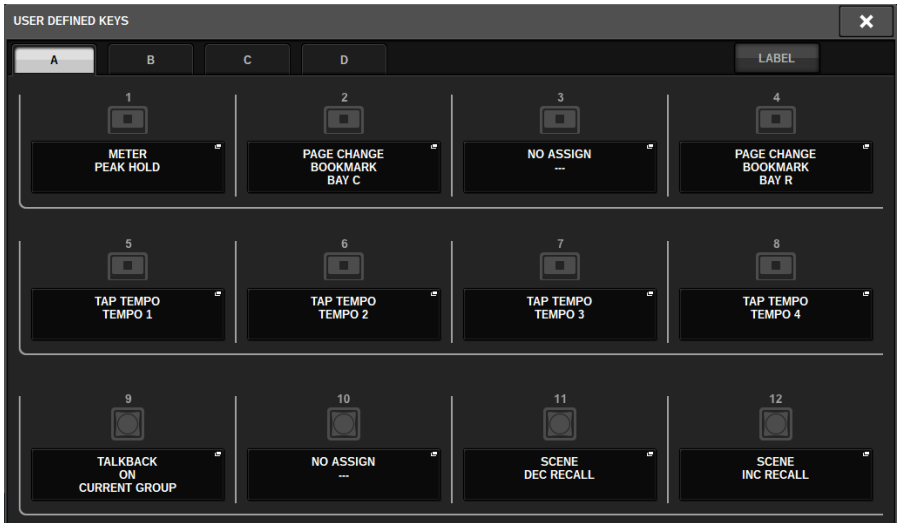

2 Open the popup window for an effect you want to control.



3 Set the SYNC parameter in the parameter field to ON.

4 Select one of TEMPO 1-4 on the left of the popup menu.

NOTE

If you select MIDI CLK, the BPM parameter value will change according to the tempo of the MIDI timing clock received from the MIDI port.

5 At the desired tempo, repeatedly press the USER DEFINED key to which you assigned the Tap Tempo function.

The average interval (BPM) at which you press the key will be calculated, and that value will be applied to the BPM parameter.

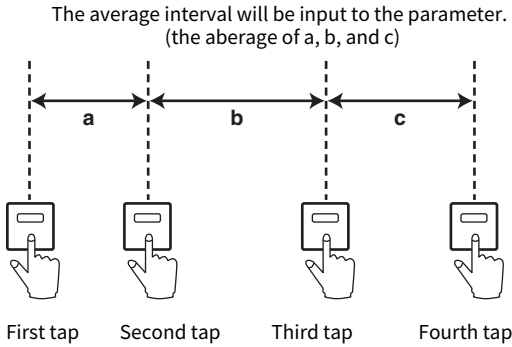

NOTE

If the average value is outside the range of 20–300 BPM, the tapping sequence will be ignored.

Effects and tempo synchronization

Some effects can be synchronized with the tempo. There are two such types of effect: delay-type effects and modulation-type effects. For delay-type effects, the delay time will change according to the tempo. For modulation-type effects, the frequency of the modulation signal will change according to the tempo.

Parameters related to tempo synchronization

The following five parameters are related to tempo synchronization.

1) SYNC 2) NOTE 3) TEMPO 4) DELAY 5) FREQ.

SYNC: This is the on/off switch for tempo synchronization.

NOTE and TEMPO: These are the basic parameters for tempo synchronization.

DELAY and FREQ.: DELAY is the delay time, and FREQ. is the frequency of the modulation signal. These parameters directly affect the way in which the effect sound will change. DELAY is relevant only for delay-type effects, and FREQ. is relevant only for modulation-type effects.

How the parameters are related

Tempo synchronization calculates the DELAY (or FREQ.) value *a from the TEMPO and NOTE parameter values.

Turn SYNC ON

Change NOTE → DELAY (or FREQ.) will be set

In this case, the DELAY (or FREQ.) value is calculated as follows.

DELAY (or FREQ.) = NOTE x 4 x (60/TEMPO)

Change TEMPO → DELAY (or FREQ.) will be set

In this case, the DELAY (or FREQ.) value is calculated as follows.

DELAY = NOTE x 4 x (60/TEMPO) sec

FREQ. = (TEMPO/60) / (NOTE x 4) Hz

Example 1:

When SYNC=ON, DELAY=250 ms, TEMPO=120, you change NOTE from 8th note to quarter note

DELAY = new NOTE x 4 x (60/TEMPO)

= (1/4) x 4 x (60/120)

= 0.5 (sec)

= 500 ms

Thus, the DELAY will change from 250 ms to 500 ms.

Example 2:

When SYNC=ON, DELAY=250 ms, NOTE=8th note, you change TEMPO from 120 to 121

DELAY = NOTE x 4 x (60 / new TEMPO)

= (1/8) x 4 x (60/121)

= 0.2479 (sec)

= 247.9 (ms)

Thus, the DELAY will change from 250 ms to 247.9 ms.

*a: Approximate values are used for the calculation results.

Special characteristics of the TEMPO parameter

Plug-ins > Effects and tempo synchronization

The TEMPO parameter has the following characteristics that are unlike other parameters.

- The TEMPO parameter can be shared by multiple effects.
- You cannot store it to or recall it from the Plug-in Library. (You can store it to and recall it from a scene.)

This means that the TEMPO value may not necessarily be the same when an effect is recalled as when that effect was stored. Here is an example.

Store the effect: TEMPO=120 → Change TEMPO to 60: TEMPO=60 → Recall the effect:

TEMPO=60

Normally when you change the TEMPO, the DELAY (or FREQ.) will be re-set accordingly. However if the DELAY (or FREQ.) were changed, the effect would sound differently when recalled than when it was stored. To prevent the effect from changing in this way between store and recall, the RIVAGE PM series does not update the DELAY (or FREQ.) value when an effect is recalled, even if the TEMPO is no longer the same as when that effect was stored.

* The NOTE parameter is calculated based on the following values.

Label	1/32(3)	1/16(3)	1/16	1/8(3)	Dot 1/16	1/8	1/4(3)
Value	1/48	1/24	1/16	1/12	3/32	1/8	1/6
Label	Dot 1/8	1/4	Dot 1/4	1/2	Dot 1/2	Whole	2x Whole
Value	3/16	1/4	3/8	1/2	3/4	1/1	2/1

Recording

2-track USB recorder

The RIVAGE PM series features an easy-to-use 2-track USB recorder. The 2-track USB recorder enables you to record output signals from the STEREO bus or a MIX bus to a connected USB flash drive. You can also use it to play background music or sound effects that are stored on a USB flash drive by assigning them to an input channel. Due to a built-in SRC (sampling rate converter), as well as the input and output from the 2-track USB recorder, you do not have to worry about differences in sampling rates between the system and the recording/playback files. If the system's sampling rate is the same as that of the recording/playback files, the SRC will automatically be bypassed. The RIVAGE PM series supports WAV (uncompressed PCM) and MP3 (MPEG-1 Audio Layer-3) file formats for recording and playback.

■ Supported recording format

WAV files

- Bit depth: 16-bit/24-bit
- Sampling rate: 44.1 kHz, 48 kHz, 88.2 kHz, 96 kHz

MP3 files

- Bit rate: 192 kbps, 256 kbps, 320 kbps
- Sampling rate: 44.1 kHz, 48 kHz

■ Supported playback format

WAV files

- Bit depth: 16-bit/24-bit
- Sampling rate: 44.1 kHz, 48 kHz, 88.2 kHz, 96 kHz

MP3 files

- Bit rate: No restriction.
- Sampling rate: 44.1 kHz, 48 kHz

■ Title list

You can change the order of the audio files shown in the title list, and play them repeatedly in a desired order.

Recording audio to a USB flash drive

You can record desired output channel signals, as an audio file (WAV or MP3), to the USB flash drive inserted in the RECORDING connector.

1 Press the RACK&REC button on the menu bar to access the RACK&REC screen.

This screen includes several pages, which you can switch between using the tabs located at the top of the screen.

2 Press the USB RECORDER tab.

The “RECORDER screen” (p.730) appears.

3 Connect a USB flash drive with sufficient free capacity to the RECORDING connector.

The FREE SIZE field indicates the amount of free capacity. When you connect a USB flash drive to the RECORDING connector, a YPE folder and a SONGS folder within that YPE folder will be created automatically in the root directory of the USB flash drive. The files created by recording operations will be saved in the above SONGS folder, or in the currently-selected folder below that level.

■ Directory structure of a USB flash drive

When you connect a USB flash drive to the USB connector, a YPE folder and a SONGS folder within that YPE folder will be created automatically in the root directory of the USB flash drive. The files created by recording operations will be saved in the above SONGS folder, or in the currently-selected folder below that level.

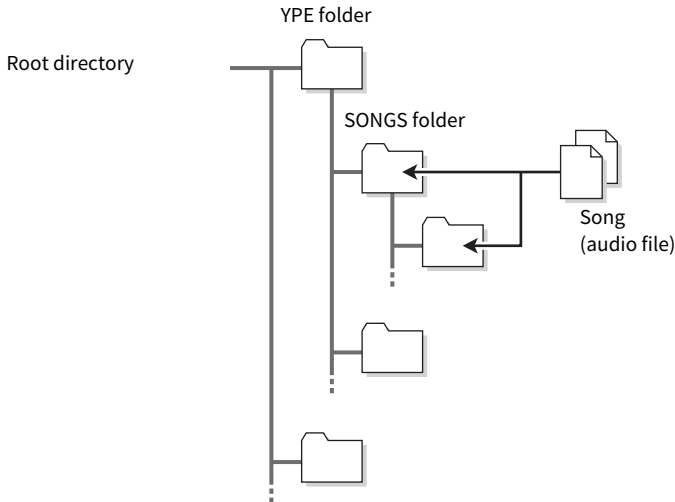

4 Assign desired channels to the input and output of the USB memory recorder. (“Assigning channels to the input/output of the recorder” (p.746))

5 To monitor the signal being recorded, raise the fader for the channel(s) that are patched to the input of the recorder.

The level of the input signal to the recorder is shown by the RECORDER INPUT field’s level meter in the RECORDER screen. If necessary, use the GAIN knob in the RECORDER INPUT field to adjust the input level to the recorder.

NOTE

- The signal being recorded will not be output from the recorder's output jacks (PLAYBACK OUT).
- Operating the GAIN knob will not affect the level of the signal being output to other ports from the corresponding output channel.

6 Press the REC FORMAT/RATE field in the lower right of the screen, then select the file format and sampling rate for the audio file that will be recorded.



■ **FORMAT (file format)**

- WAV 16-bit
- WAV 24-bit
- MP3 192 kbps
- MP3 256 kbps
- MP3 320 kbps

■ **F_s (sampling rate)**

- 44.1 kHz
- 48kHz
- 88.2kHz (WAV only)
- 96kHz (WAV only)

7 Press the REC button.

The REC button and the PAUSE indicator of the PLAY/PAUSE button will light up. The current song indicator area will show “----RECORDING----.”

8 To start recording, press the PLAY/PAUSE button.

During recording, the REC button and the PLAY indicator of the PLAY/PAUSE button will light up. You can also see the elapsed recording time.

9 To stop recording, press the STOP button.

The audio file will be saved to the USB flash drive.

NOTE

- In the default state, the recorded audio file will be saved in the SONGS folder within the YPE folder. You may also specify a folder of a level below the SONGS folder.
- The recorded file will be given a default title and file name. You can change these later.

10 To audition the recorded content, proceed as follows.

① Select a recorded audio file, and then press the PLAY/PAUSE button.

The recorded content will be played back via the input channel you specified in step 4. You can also turn on the CUE button in the PLAYBACK OUT field to audition it.

② To stop playback, press the STOP button.

RECORDER screen

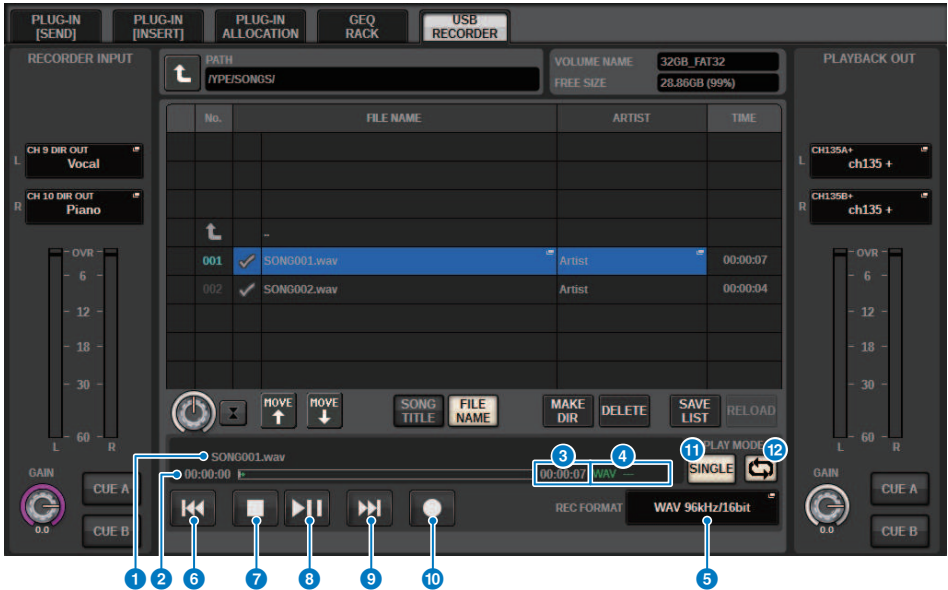

This screen contains the following items.

■ TRANSPORT field

Enables you to control recording and playback of a song.

1 Current song

Indicates the currently-selected song's track number, title and artist name. The following indicators will appear during playback or recording.

Playing



Recording



2 Elapsed time display

Indicates the elapsed playback time of the current song during playback, and the elapsed recording time during recording.

3 Remaining time display

Indicates the remaining playback time of the current song during playback.

4 Current song format

Indicates the file format and bit rate of the current song (the file being played back).

5 REC FORMAT/RATE popup button

Enables you to select the recording file format and recording rate.

6 REW button

Moves the playback point to the beginning of the current song. If the playback point is already at the beginning, the point will move to the beginning of the preceding song that has been selected for playback. If the playback point is not at the beginning of the current song, and if you press and hold down this button for two seconds or longer, the song will rewind. If you operate this button during playback, playback will resume from the point at which the button is released.

7 STOP button

The recorder will change from play/record/recording-standby mode to stop mode.

8 STOP button

The recorder will change from play/record/recording-standby mode to stop mode.

9 PLAY/PAUSE button

Changes the recorder mode as follows.

- **Stop mode**.....Playback mode, and then playback will start from the beginning of the current song.
- **Playback mode**.....Playback-pause mode
- **Playback pause mode**.....Playback mode, and then playback will resume from the paused point.
- **Recording standby mode**.....Recording mode
- **Recording mode**.....Recording-pause mode
- **Recording-pause mode**.....Recording mode, and then recording will resume from the paused point.

10 FF button

Moves the playback point to the beginning of the next song that is marked with a PLAY check symbol. If you press and hold down this button for two seconds or longer, the song will fast-forward. If you operate this button during playback, playback will resume from the point at which the button is released.

11 REC button

NOTE

Places the recorder in recording standby mode. The pause indicator on the PLAY/PAUSE button will light up. You can also assign the function of each button to USER DEFINED keys. (USER DEFINED KEYS)

■ PLAY MODE field

Enables you to specify how the recorder will behave when playback of the current song is complete.

12 SINGLE button

If this button is on, only the current song will play. If this button is off, when the current song finishes playing, the recorder will play the next song in the list that is marked with a PLAY check symbol.

13 REPEAT button

If this button is on, playback will repeat. If the SINGLE button is on, only the current song will play repeatedly. If the SINGLE button is off, all songs in the list that are marked with a PLAY check symbol will repeatedly play in the order of the list. If this is off, the song will play only once. If the SINGLE button is on, the current song will play only once, and then stop. If the SINGLE button is off, all songs in the list that are marked with a PLAY check symbol will play once in the order of the list, and then playback will stop.

Playing back audio files from a USB flash drive

You can play back audio files that have been saved on a USB flash drive. In addition to files that were recorded on the RIVAGE PM series, you can also play files that were copied from your computer to the USB flash drive. The RIVAGE PM series supports WAV (uncompressed PCM) and MP3 (MPEG-1 Audio Layer-3) file formats for playback.

1 Connect a USB flash drive that contains audio files to the RECORDING connector.

NOTE

If you want to play back an audio file, you must save it in the SONGS folder within the YPE folder, or in a folder you have created below the SONGS folder. Files located in other folders and files of unsupported formats will not be recognized.

2 Press the RACK&REC button on the menu bar.

The RACK&REC screen appears.

3 Press the RACK&REC button on the menu bar to access the RACK&REC screen.

This screen includes several pages, which you can switch between using the tabs located at the top of the screen.

4 Press the USB RECORDER tab.

The RECORDER screen appears.

5 You can use the change directory button on screen and the folder icon in the NO. column to view a content list of the folder that includes the desired file.

If the directory of the USB flash drive is displayed, you can navigate as follows:

• **Upper level**.....Press this button to move up to the directory that is one level higher than the current directory.



• **Subdirectory**.....Press this button to move to that sub-directory.



NOTE

- If you select a folder in this way, that folder will automatically be selected as the recording destination.
- The folders that can be selected are restricted to the SONGS folder inside the YPE folder, and folders located below the SONGS folder.
- The RIVAGE PM series can recognize a file name that is a maximum of 64 single-byte characters. If the file name is longer than this, the desired file may not play correctly.
- A maximum of 300 songs can be managed in a single directory. A maximum of 64 subdirectories can be managed.

6 Use the screen encoder or the [TOUCH AND TURN] knob, or press the on-screen file name to select the desired file.

7 Press a PLAY MODE button to select the playback mode.

You can choose from the four playback modes.

8 If you have selected a consecutive playback mode in step 6, press the PLAY check symbol column for each song you want to play.

When performing consecutive playback, files marked with a check symbol will be played.

9 Press the PLAY/PAUSE button.

10 The song you selected in step 5 will begin playing.

NOTE

- Even if the sampling rate at which the RIVAGE PM series is operating differs from the sampling rate of the audio file being played, the SRC (Sampling Rate Converter) function will automatically convert the rate so that the file will play back correctly.
- If the REPEAT button is on, playback will continue until you stop playback.

11 To stop playback, press the STOP button.

RECORDER screen



This screen contains the following items.

1 Title list

Indicates the playable audio files and the folders that are saved in the selected folder of the USB flash drive. The row with the blue background in the center of the list indicates the song file/folder that is selected for operations.

2 Status indicator

A symbol indicating whether the file is playing or paused is shown at the left edge of the title list.

3 Track number

Indicates the file number in the title list.

4 Sub-directory

If there is a folder at a lower level, a folder icon is shown at the track number position. You can move to the lower level by pressing the folder icon.

5 PLAY check symbol

Enables you to select multiple files that will be played back consecutively.

6 SELECT knob

Use the screen encoder to switch the current song. (The title list will scroll up or down.)

7 NOW PLAYING button

If this button is on, the currently-playing song will always be selected in the list (with the blue background).

8 MOVE UP/MOVE DOWN buttons

Change the order of the selected song in the list.

9 Display switch buttons

Toggles between the SONG TITLE display and the FILE NAME display in the list.

10 SAVE LIST button

Saves the order of the current title list and PLAY check symbol settings as a playlist.

11 RELOAD button

Loads the playlist that was saved most recently. Use this button to revert the current playlist you are editing back to the previous state.

Playback mode pattern

SINGLE button	REPEAT button	Mode
On	On	The currently-selected song will play repeatedly until you stop playback.
On	Off	The currently-selected song will play once and then stop.
Off	On	Starting with the currently-selected song on the title list, songs will play back consecutively until the last song. Then, playback will return to the first song and will continue until you stop playback.
Off	Off	Starting with the currently-selected song in the title list, songs will play back consecutively, and playback will stop at the last song in the list.

Editing the title list

Here is how you can change the order of the audio files shown in the title list, and edit the titles or artist names.

1 Connect a USB flash drive containing audio files to the RECORDING connector.

2 Press the RACK&REC button on the menu bar.

The “RECORDER screen” (p.740) appears.

3 In the screen, you can use the folder icon in the NO. column and the change directory button to view the contents of the folder that includes the desired file.

4 If you want to edit a title in the title list, press the SONG TITLE/FILE NAME EDIT button. If you want to edit the artist name, press the ARTIST EDIT button.

A popup window will appear, allowing you to edit the text.

NOTE

If the title or artist name contains characters that cannot be displayed, these characters will be converted into £ for display.

5 Edit the title or artist name.

A maximum of 128 single-byte characters (64 double-byte characters) can be input for both the title and for the artist name. If the text cannot be shown completely in the input field, the text will scroll horizontally.

6 Press the OK button to close the popup window.

7 If necessary, use the SONG TITLE/FILE NAME SORT button, ARTIST SORT button, and MOVE UP/MOVE DOWN buttons on screen to change the order of the title list.

Use the following buttons to change the order of the title list.

• **SONG TITLE/FILE NAME SORT button**

Press this button to sort the title list in numerical -> alphabetical order by title/file name. Pressing the button repeatedly will alternate between ascending and descending order.

• **ARTIST SORT button**

Press this button to sort the title list in numerical -> alphabetical order by artist name. Pressing the button repeatedly will alternate between ascending and descending order.

• **MOVE UP/MOVE DOWN buttons**

Press these buttons to move the track number of the file currently selected in the title list upward or downward by one.

• **SAVE LIST button**

Press this button to store the title list order and playback selections (the PLAY check symbol setting) to a USB flash drive as a play list. Perform this operation if you want to save the state of the title list even after you disconnect the USB flash drive or turn off the power to the system. Since these settings are stored for each folder, a confirmation dialog box will ask you whether you want to save them when you navigate through the directory.

RECORDER screen

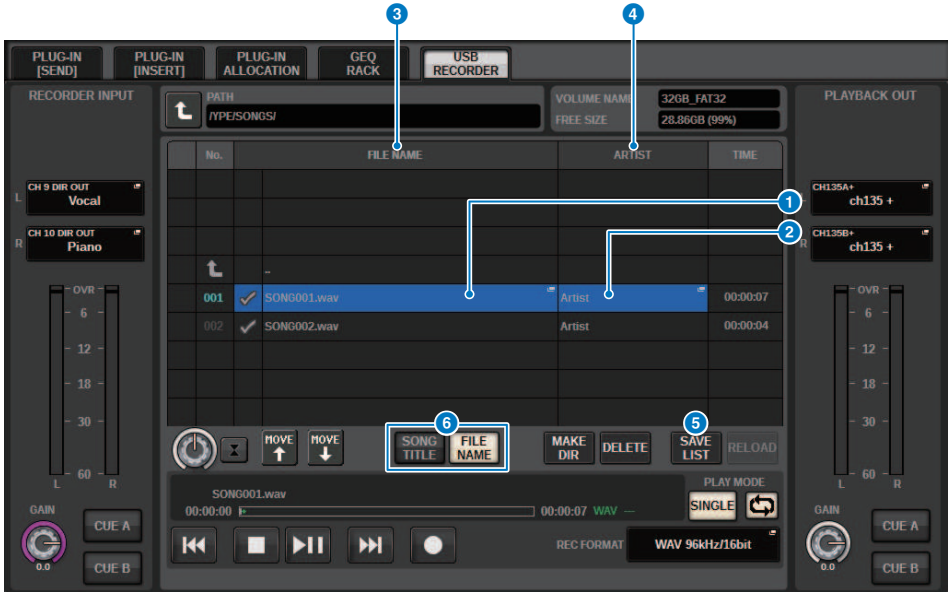

This screen contains the following items.

- 1 SONG TITLE/FILE NAME EDIT button**
Enables you to edit the title or file name of the song selected in the list.
- 2 ARTIST EDIT button**
Enables you to edit the artist name of the song selected in the list.
- 3 SONG TITLE/FILE NAME SORT button**
Sorts the list in numerical/alphabetical order by title or file name.
- 4 ARTIST SORT button**
Sorts the list in numerical/alphabetical order by artist name.
- 5 SAVE LIST button**
Saves the order of the current title list and PLAY check symbol settings to a USB flash drive as a playlist.
- 6 SONG TITLE/FILE NAME button**
Enables you to select either song title or file name to be displayed in the SONG TITLE/FILE NAME field.

Multitrack recording and virtual sound check

The RIVAGE PM series supports multitrack recording via a Dante network or MADI. To perform multitrack recording, you must install an HY144-D card (maximum 144-in/144-out) in HY card slot 4 of the DSP engine (in the case of the CSD-R7, in HY card slot 3), and then record using DAW software on your Dante network-connected computer. If your computer already has Dante Accelerator (AIC128-D) installed, you can perform up to 128-in/128-out (Fs=96 kHz), high-resolution recording. If you use Dante Virtual Soundcard (DVS), you can perform up to 64-in/64-out* (Fs=48 kHz) recording. Materials that were recorded by multitrack recording can be used for virtual sound check. For example, you can record a rehearsal session the day before the concert, and use that recording for sound check on the day of the concert. This “virtual sound check” will reduce the burden on both musicians and sound engineers, and will help them prepare better.

* The number of channels available for recording and playback varies depending on the specifications of the computer that has the DAW installed.

• RECORDING PATCH (HY card slot 4 on the DSP engine (or HY card slot 3 on the CSD-R7))

The HY card slot 4 on the DSP engine (HY card slot 3 on the CSD-R7) is used for multitrack recording exclusively. The HY card slot 4 features the RECORDING PATCH function for recording and playback. If you select channels into which you want to perform multitrack recording, the Direct Out of the selected channels will be automatically assigned. Since these can be switched to playback patching in a single operation, the DAW playback can be used for a virtual sound check.

• Recording using Split Out (HY card slot 2 on the RPi622/222)

In addition, if the RPi622/222 is in mode 1, all input signals (total 128 channels) from the RY slots and MY slots are always split and output from HY SLOT 2. This allows the input from the I/O rack to be recorded directly to a DAW.

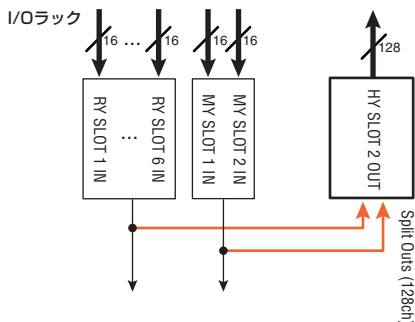

Conceptual diagram of recording system for a virtual sound check (an example)

■ **Recording**

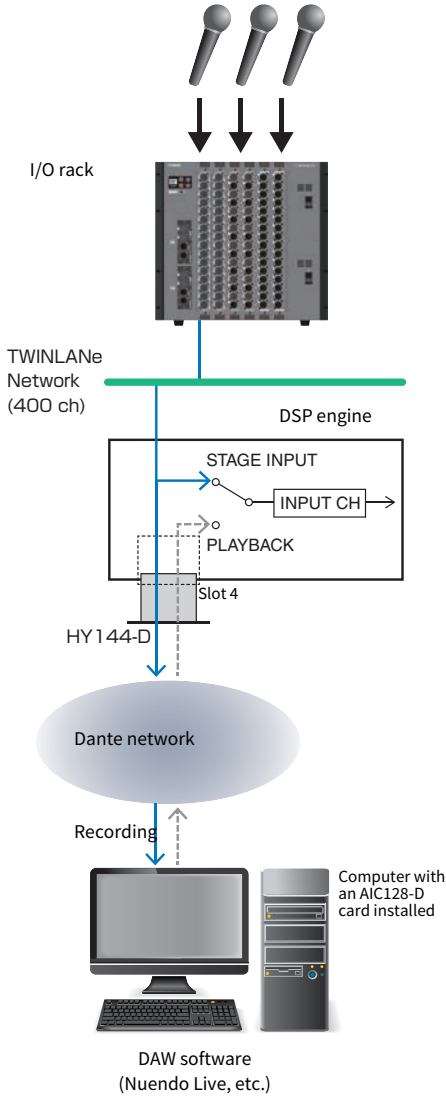

■ **Playback**

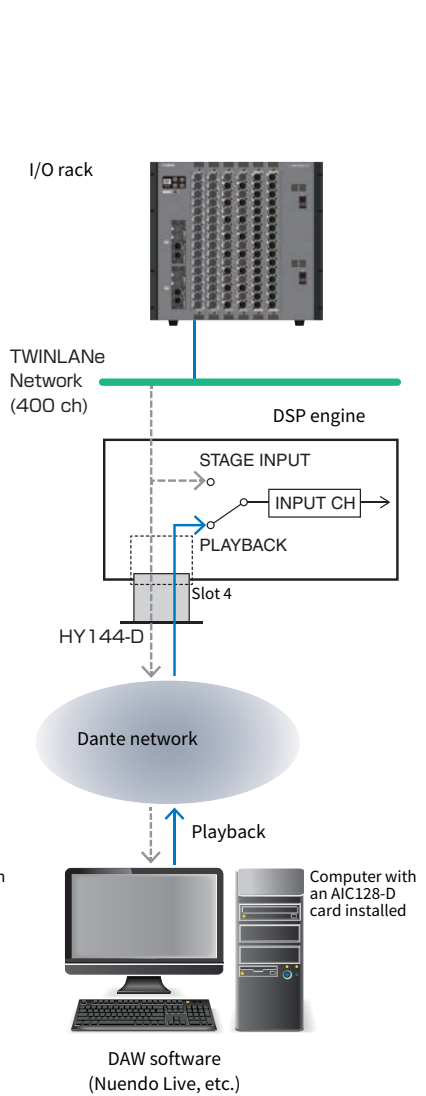

■ Sharing DAW playback with FoH and monitor

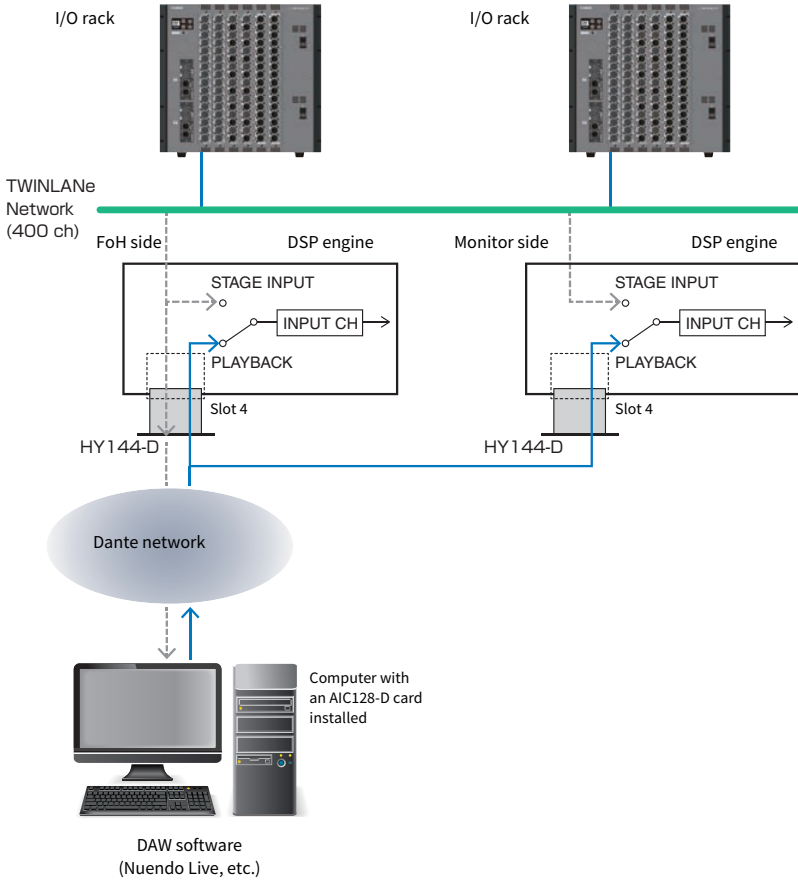

Signal flow during a virtual sound check (VSC)

DSP engine

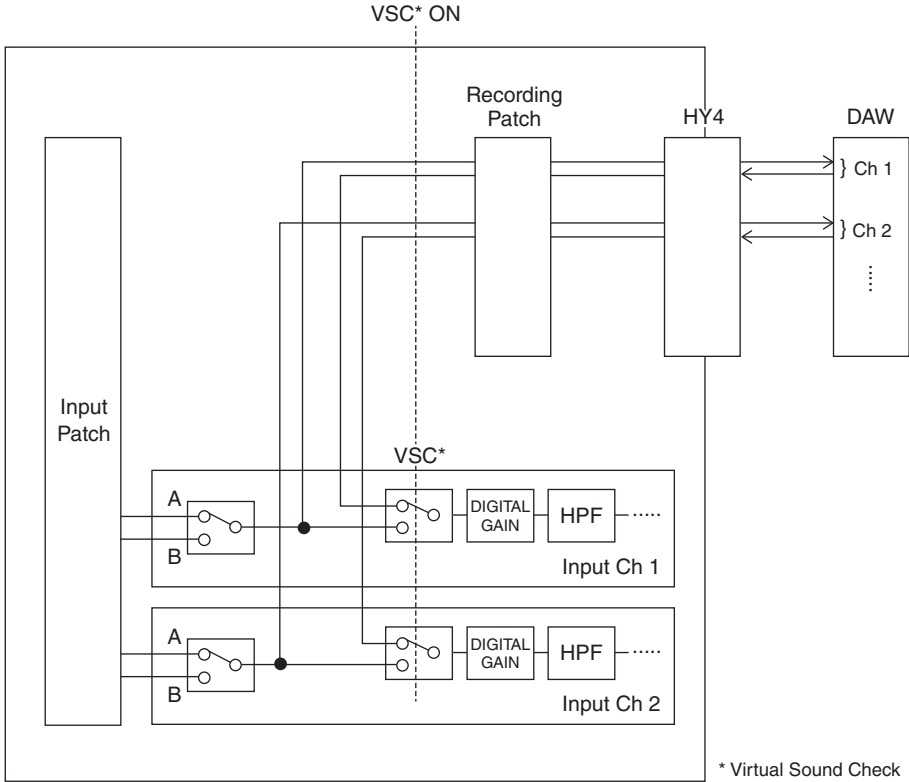

* Virtual Sound Check

* Each channel can individually be set to ON/OFF when switching to virtual sound check. This allows a virtual sound check that mixes playback from the recorder with actual stage inputs.

Signal flow for the USB memory recorder

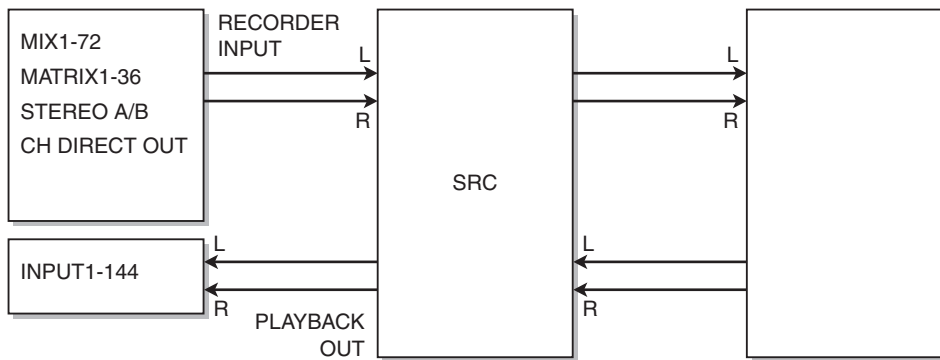

NOTE

Recording and playback cannot be done simultaneously.

Assigning channels to the input/output of the recorder

Follow the steps below to patch the desired channels to the input and output of the USB memory recorder. You can patch any output channel or the direct output of an input channel to the recorder's input. You can patch the recorder's output to any input channel.

1 Press the RACK&REC button on the menu bar to access the RACK&REC screen.

This screen includes several pages, which you can switch between using the tabs located at the top of the screen.

2 Press the USB RECORDER tab.

The "RECORDER screen" (p.747) appears.

3 To assign channels to the recorder's input, press the RECORDER INPUT popup button L or R.

The "INPUT PATCH popup window" (p.749) appears.

4 Use the category list and the channel select buttons to select the channel that you want to patch to the USB memory recorder's input.

If you select a channel to which a channel is already patched, a dialog box will ask you to confirm the patch change. Press the OK button in the dialog box.

5 When you finish assigning the channel, press the CLOSE button.

The system will return to the RECORDER screen.

6 The system will return to the RECORDER screen.

7 Assign a channel to the other input in the same way.

NOTE

The USB memory recorder always records and plays back in stereo. If you want to record in monaural, with the same signal for left and right, you must assign both of the recorder inputs to the same channel.

8 To assign channels to the recorder's playback output, press the PLAYBACK OUT popup button L or R.

The "OUTPUT PATCH popup window" (p.750) appears.

9 When you finish assigning the channels, press the CLOSE button.

The system will return to the RECORDER screen.

10 Assign a channel to the other output in the same way.

RECORDER screen



This window contains the following items.

1 RECORDER INPUT pop-up buttons (L/R)

Press these buttons to access the INPUT PATCH pop-up window, in which you can select a signal to patch to the L/R channel of the recorder input.

2 RECORDER INPUT GAIN knob

Sets the level of the signal input to the recorder.

3 RECORDER INPUT CUE buttons

NOTE

If CUE A, or CUE B is on, you will be able to audition the signal input to the recorder. You cannot turn on any of these buttons and the PLAYBACK OUT CUE button simultaneously.

4 RECORDER INPUT meter

Indicates the level of the signals input to the recorder.

5 PLAYBACK OUT pop-up buttons (L/R)

Press these buttons to access the OUTPUT PATCH pop-up window, in which you can select signals that will be patched to the recorder's L/R output channels for playback.

6 PLAYBACK OUT GAIN knob

Sets the level of the recorder playback output signal.

7 PLAYBACK OUTPUT CUE button

NOTE

If CUE A, or CUE B is on, you will be able to audition the playback signal output from the recorder. You cannot turn on any of these buttons and the RECORDER INPUT CUE button simultaneously.

8 PLAYBACK OUT meter

Indicates the level of the recorder playback output signal.

INPUT PATCH popup window



This screen contains the following items.

1 Category list

Enables you to select the channel category.

2 Channel select buttons

Enable you to select the channel (that you want to patch to the USB memory recorder's input) from the channels selected in the category list.

OUTPUT PATCH popup window

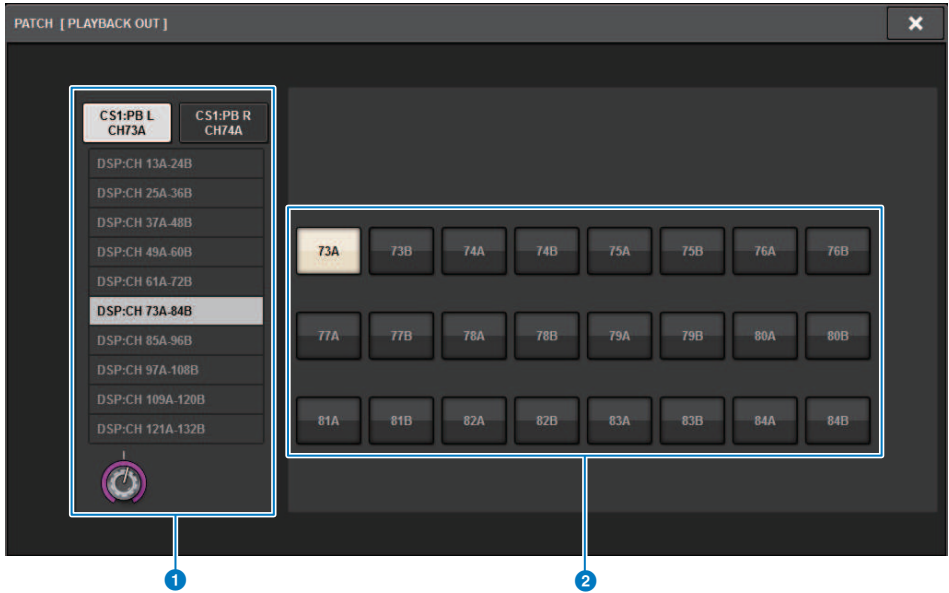

This screen contains the following items.

1 Category list

Enables you to select the channel category.

2 Channel select buttons

Enable you to select the channel (that you want to patch to the USB memory recorder's output) from the channels selected in the category list.

Virtual sound check

Materials that were recorded by multitrack recording can be used for virtual sound check. For example, you can record a rehearsal session the day before the concert, and use that recording for sound check on the day of the concert. This “virtual sound check” will reduce the burden on both musicians and sound engineers, and will help them get ready efficiently. In addition, a special patching allows for a virtual sound check that mixes multitrack material from the recorder with actual stage inputs.

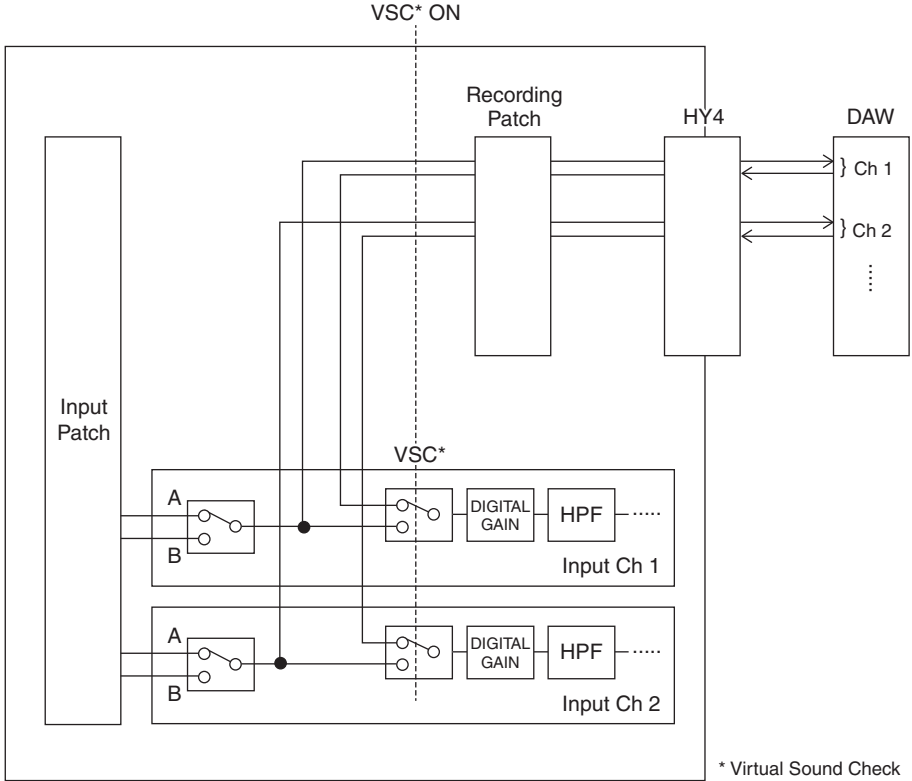

About Dante

Dante is a network protocol developed by Audinate. It is designed to deliver multi-channel audio signals at various sampling and bit rates, as well as device control signals over a Giga-bit Ethernet (GbE) network.

Visit the Audinate website for more details on Dante.

<http://www.audinate.com/>

More information on Dante is also posted on the Yamaha Pro Audio website:

<http://www.yamahaproaudio.com/>

Patching for multitrack recording and virtual sound check

HY card slot 4 on the DSP engine (or HY card slot 3 on the CSD-R7) features the Recording Patch function used for multitrack recording and virtual sound check (VSC). Patch channels (into which you want to record) to the ports of HY card slot 4 (or HY card slot 3 on the CSD-R7).

- 1 Press the PATCH button on the menu bar to access the PATCH screen.**
- 2 Press the RECORDING tab.**
- 3 The RECORDING PATCH screen appears.**

To display the patch grid, you must specify HY144-D for HY card slot 4 on the DSP engine (or HY card slot 3 on the CSD-R7). (You can also do so off-line.)
- 4 Use the REC OUT select knob to display the port on the slot that will be used for REC OUT.**
- 5 Use the knob in the category select list to display channels.**
- 6 Press the grid cell that corresponds to the REC OUT to patch the channel.**
- 7 Use the PLAYBACK IN select knob to display the port on the slot that will be used for PLAYBACK IN.**
- 8 Use the knob in the category select list to display channels.**
- 9 Press the grid cell that corresponds to the PLAYBACK IN to patch the channel.**

RECORDING PATCH screen

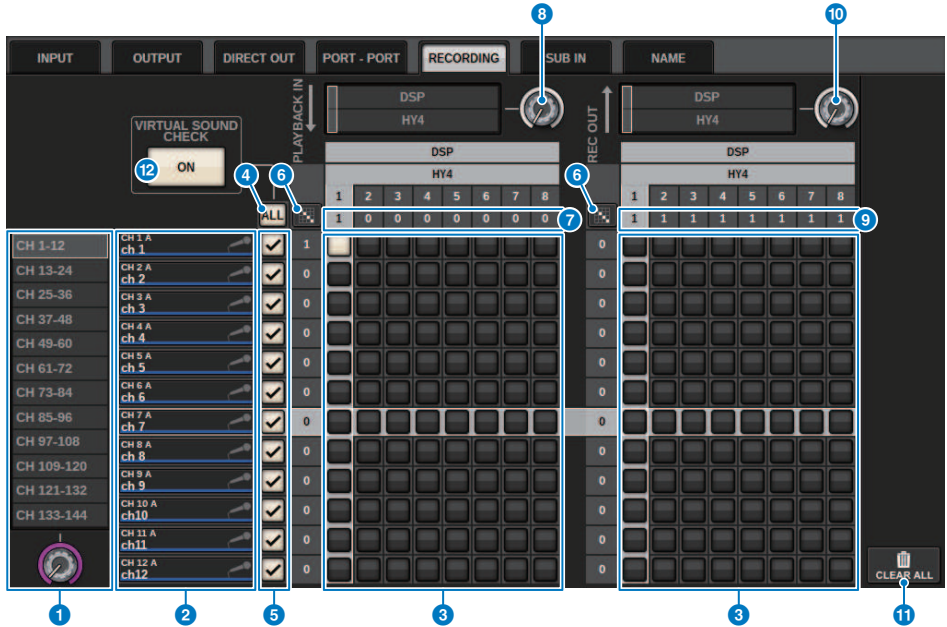

This screen contains the following items.

1 Category select list (channel)

You can select the channel category using the knob. The categories correspond to the following channels.

- CH1-144

2 Channel display

This area indicates channels that can be assigned to the RECORDING slot.

3 Grid

This grid lets you patch output jacks (horizontal lines) to channels (vertical columns). Currently-patched grids are indicated by white squares. Press or click a desired grid to set or disable the patch.







4 ALL button

All channels will be subject to or excluded from the virtual sound check simultaneously. If any one channel is turned off, this button will indicate "...".

5 Check buttons

Enable you to select channels that are subject to the virtual sound check.

6 Continuous Patch  button

Press the continuous patch  button, and then rotate the REC OUT select knob to patch the intersecting channels continuously. If you press the continuous patch  button, the  button and the  button will appear. Press the  button again to confirm the selected continuous patches. Press the  button to revert the continuous patches to their previous state.

7 PLAYBACK IN ASSIGN

This area indicates the number of PLAYBACK INs assigned to each channel.

8 PLAYBACK IN select knob

Enables you to select channels used for PLAYBACK INs.

9 REC OUT ASSIGN (assign)

This area indicates the number of REC OUTs assigned to each channel.

10 REC OUT select knob

Enables you to select a channel used for REC OUTs.

11 CLEAR ALL button



Press this button to clear all selections.

12 VIRTUAL SOUND CHECK ON button

If this button is on, the Virtual Sound Check function will be enabled, and the patches will be used for the virtual sound check. If virtual sound check is turned ON, it will be indicated on the status indicator on the menu bar or in the channel name area.

Virtual sound check display

When Virtual Sound Check is turned on, it is reflected in the display on the touch screen.

Channel name area	SELECTED CHANNEL VIEW screen PATCH field	
	<p>VSC ON</p> 	<p>VSC OFF</p> 

Channels with virtual sound check on and check button  on are set so that A/B Patch selection is disabled and virtual soundcheck patches are enabled.

Recording or playing back using a DAW on the computer

Follow the steps below to record or play back using a DAW.

- **Setting up the RIVAGE PM series**

To perform a virtual sound check, configure the recording patches. Recording/playback signals should be transferred from and received at HY card slot 4 on the DSP engine (or HY card slot 3 on the CSD-R7). If the RPi0622 or RPi0222 signal is split out, you do not need to configure the patches. The signals will be output to the Dante network directly from the HY144-D card inserted in HY slot 2 of the RPi0622.

- **Configuring Dante Accelerator or Dante Virtual Soundcard**

Configure the Dante network and the computer.

- **Setting up Dante patches**

Use Dante Controller to configure Dante patches.

- **Setting up for a DAW**

Select Dante Virtual Soundcard, or AIC128-D ASIO driver.

NOTE

- You must have a license ID to use a Dante Virtual Soundcard. The DVS token that is required for obtaining the license ID is printed on a sheet (supplied in the HY144-D / HY144-D-SRC package).
- The latest information about the Dante Virtual Soundcard and the Dante Controller is available at the following website:
 - <http://www.yamahaproaudio.com/>

Configuring Dante Accelerator

First, make sure that the Dante Accelerator card is installed in the PCIe slot of your computer. Then, install the Dante Accelerator driver. For information about installing the driver and about the control panel, refer to the Installation Guide supplied with the driver. To achieve a stable live recording, we recommend you use the maximum buffer size and latency. For more information on configuring Dante Accelerator, please refer to the Dante Accelerator Operation Manual.

Configuring a Dante Virtual Soundcard

Install a Dante Virtual Soundcard (DVS) and Dante Controller on the computer that you will use for audio recording. And then, make the following settings before you turn on the DVS.

- Connect the GbE-compatible network port of the computer to a GbE-compatible network switch.
- Configure the computer to obtain an IP address automatically (this is the default setting).
- Specify the Dante latency. (Choose a larger value for stable multi-channel recording/playback.)
- In the Advanced settings, select the number of channels to be used for recording and playback (the default is 8 x 8).

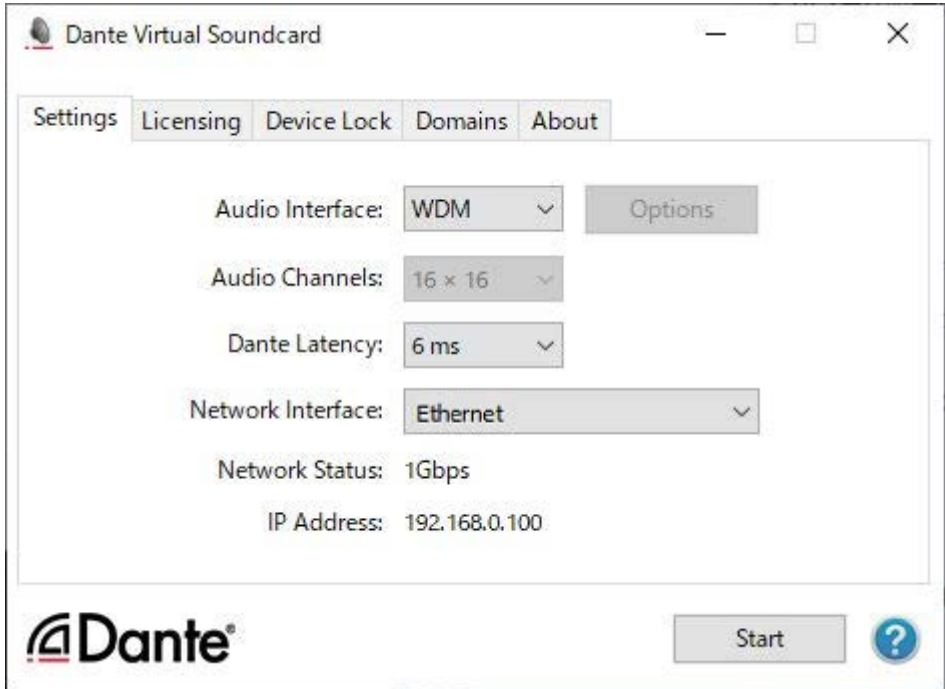

NOTE

Please refer to the Dante Virtual Soundcard User's Guide for more information on ASIO settings (Windows OS).

Configuring Dante Controller

Connect the network port of the computer to a GbE-compatible network switch. Configure the computer to obtain an IP address automatically (this is the default setting). You must make the following settings for Dante Controller.

- For multitrack recording: Patch audio signals from the I/O rack to the DVS or Dante Accelerator card for multitrack recording.
- For virtual sound check: Patch audio signals in such a way that they will be output from the computer to the Dante audio network, then routed to the channels on the RIVAGE PM series (“Patching for multitrack recording and virtual sound check” (p.753)).

The following example shows Dante Controller settings for when playback signals from Dante Accelerator are patched to HY144-D card for a virtual sound check.

The screenshot displays the Dante Controller Network View interface. At the top, it shows the 'Grand Master Clock: Y001-Yamaha-DSP-R0EX-HY2-26ad6c'. The interface is divided into several sections:

- Routing:** A central routing matrix with 27 rows (01-27) and 46 columns (01-46). A diagonal line of green circular icons indicates a virtual sound check configuration where each input channel is routed to its corresponding output channel.
- Filter Transmitters:** An empty text input field.
- Filter Receivers:** An empty text input field.
- Dante Transmitters:** A list of four transmitters: Y001-Yamaha-DSP-R0EX-HY2-26ad6c, Y001-Yamaha-DSP-R0EX-HY2-26ae72, Y001-Yamaha-DSP-R0EX-HY2-26ae9c, and Y001-Yamaha-DSP-R0EX-HY3-26ad9c.
- Dante Receivers:** A list of three receivers: Y001-Yamaha-DSP-R0EX-HY2-26ad6c, Y001-Yamaha-DSP-R0EX-HY2-26ae72, and Y001-Yamaha-DSP-R0EX-HY3-26ad9c.

At the bottom, the status bar shows 'Unmanaged Multicast Bandwidth: 0 bps', 'Event Log', 'Clock Status Monitor', and 'P: [green square]'.

During multitrack playback, you can switch these settings easily using the VIRTUAL SOUND CHECK ON button on the RECORDING PATCH screen.

NOTE

Please refer to the Dante Controller manual for more information about operations and settings of the Dante Controller.

Setting up DAW software

You must make the appropriate driver settings in your DAW software. In the device setting window, select “Dante Virtual Soundcard Card — ASIO” (or “Dante” for Mac) or “Yamaha AIC128-D” as the sound card (or audio driver) used for input/output. Some DAW software may require internal patching for the driver and the DAW software. For more information, refer to the DAW software manual.

Audio recording and playback

After you have made the driver settings in your DAW software, you can record and play back audio. For multitrack recording, set the input ports for tracks in DAW software to the ports that receive audio signals from the I/O rack. For a virtual sound check, you must route recorded audio signals to the input channels on the RIVAGE PM series. To do so, use Dante Controller to patch the signals so that the signals will be output from the DAW software to the RIVAGE PM series. Using the VIRTUAL SOUND CHECK ON button on the RECORDING PATCH screen, you can easily switch between two settings: one setting for routing audio signals from the I/O rack, and another setting for routing audio signals from DAW software. In addition, you will be able to patch a specific channel (such as a vocal) to the I/O rack to monitor during a virtual sound check using the RECORDING PATCH screen.

NUENDO Live

The RIVAGE PM series consoles can operate in an integrated manner with Steinberg's NUENDO Live DAW software. The "Yamaha Console Extension" software, which integrates the RIVAGE PM series and NUENDO Live, can be installed in your computer, allowing you to operate NUENDO Live from the RIVAGE PM series console to easily perform multi-track recording operations.

Refer to "Recording or playing back using a DAW on the computer" (p.756)" to make the following settings.

- Configuring Dante Virtual Soundcard
- Configuring Dante Controller
- Configuring NUENDO Live

Recording

1 Press the RACK&REC button on the menu bar to access the RACK&REC screen.

2 Press the NUENDO Live tab.

The "NUENDO Live Screen" (p.766)" appears.

3 Press the EASY RECORDING button to start recording.

4 When you finish recording, press the Record Lock button and then press the STOP button. Recordings created with NUENDO Live are saved as a project.

NUENDO Live SETUP Screen

In this window, choose one of the following methods by which to specify DVS or Dante Accelerator.

- **NO ASSIGN** Not assigned
- **DVS LIST** Select a DVS from the device list
- **SPECIFIED IP ADDRESS** When using Dante Accelerator, specify the IP address of the computer

■ DVS LIST

To choose from a list of the I/O devices on the Dante audio network, press the DVS button to display the DEVICE LIST field.

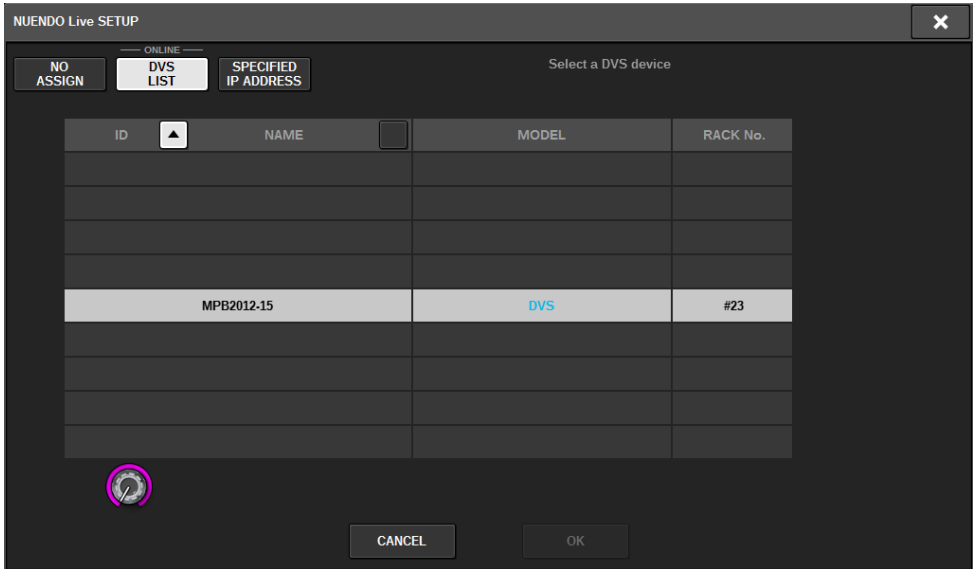

Shows a list of the DVS on the Dante audio network. From the list, choose the DVS that you want to use with Nuendo Live.

■ SPECIFIED IP ADDRESS

If you want to specify an IP address, press the SPECIFIED IP ADDRESS button to display the SPECIFIED IP ADDRESS field.

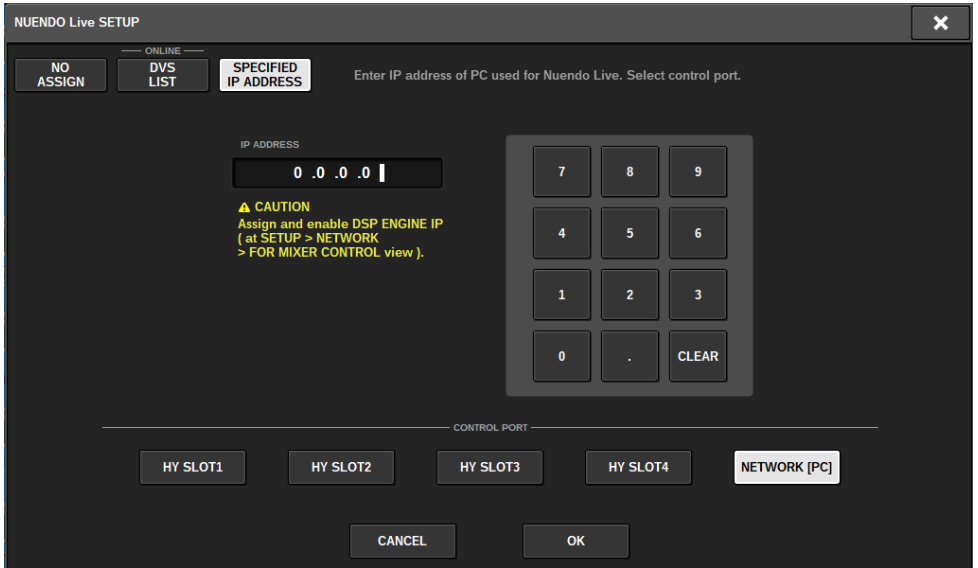

When using an interface other than DVS such as Dante Accelerator, specify the IP address of the Ethernet port of the computer running NUENDO Live in the SPECIFIED IP ADDRESS field. Since the IP address of Dante Accelerator will differ from the IP address used by Yamaha Console Extension, you must enter the IP address manually. Enter the IP ADDRESS and select the HY SLOT button or NETWORK [PC] button that connects the Ethernet port of the computer running NUENDO Live. When using the NETWORK [PC] terminal, turn on the ENABLE button of the DSP ENGINE IP SETTING.

Connection example when controlling NUENDO Live from HY SLOT

To control NUENDO Live from HY SLOT, connect your computer's Ethernet port to the Dante Primary network as shown in the following connection diagram.

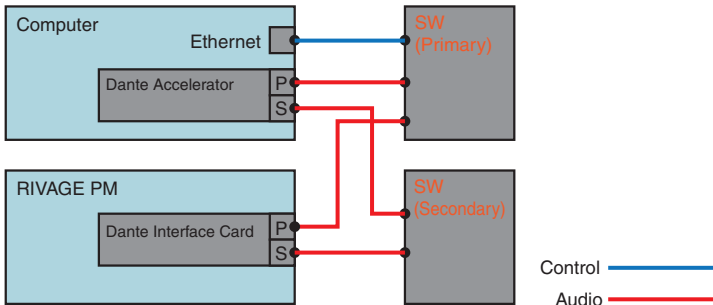

Connection example when controlling NUENDO Live from the NETWORK [PC] terminal of the SP engine

When controlling NUENDO Live from the external control computer connection terminal, connect the Ethernet port of the computer to the NETWORK [PC] terminal of the DSP engine as shown in the connection diagram below. NUENDO Live linkage can be performed using HY128-MD by controlling from the NETWORK [PC] terminal.

Recording > NUENDO Live SETUP Screen

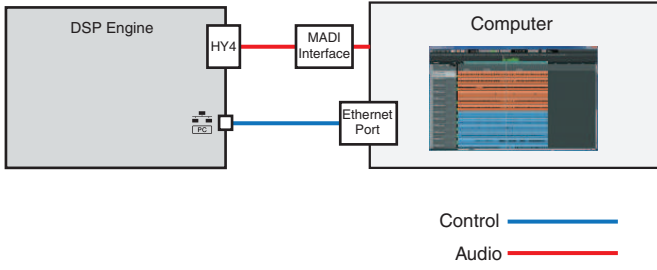

NUENDO Live Screen



This screen contains the following items.

1 Marker list field

Lists the marker information recorded in the current Nuendo Live project. You can scroll through the list by operating the knob with the screen encoder or the [TOUCH AND TURN] knob. When you press this field, a keyboard window allowing you to edit the marker information will appear.

2 NUENDO Live Setup button

The "“NUENDO Live SETUP Screen” (p.763)" will appear, where you can specify the device to be used for communication with NUENDO Live.

3 DVS information display

Shows the device label of the selected DVS.

If you are connecting with SPECIFIED IP ADDRESS, the IP address of the connection destination is displayed.

4 ADD MARKER button

Adds a marker to the project at the current playback position.

5 RECALL LINK button

Specifies whether a marker will be created when you recall a scene. If this function is turned on, the button will be lit.

6 Playback position information display

This displays information for the current position of the Nuendo Live project. You can press the button at the right to switch the time display format.

7 GO TO PROJECT START button

Returns the playback position to the start of the project.

- 8 GO TO PREVIOUS MARKER button**
Returns the playback position to the previous marker.
- 9 GO TO NEXT MARKER button**
Advances the playback position to the next marker.
- 10 GO TO PROJECT END button**
Advances the playback position to the end of the project.
- 11 CYCLE button**
Turns repeat on/off for the project.
- 12 STOP button**
Stops playback/recording of the project.
- 13 PLAY button**
Starts playback of the project.
- 14 RECORD button**
Starts/stops recording for the project.
- 15 EASY RECORDING button**
Immediately starts recording on all tracks. When you press this, the following occurs: the location moves to the last-recorded position, all tracks are set to record mode, recording begins, the record panel is displayed, and the panel is locked. Recording is done retroactively from the actual recording start position to the time set in Pre-Record Time. (Default setting: 10 seconds)
- 16 Record lock button**
Turns recording status lock on/off. This prevents recording from being accidentally stopped during recording.

Scene memory

About the conceptual memory diagram

The diagram below shows the relationship between current data, scene memory, and libraries.

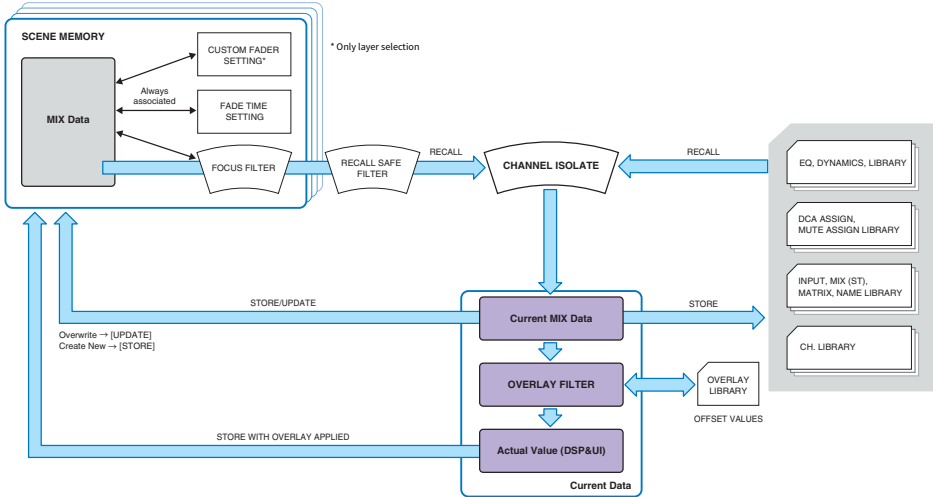

NOTE

For information regarding data that is not stored in scene memories, refer to Data handled by a settings file "Data handled by a settings file" (p.853).

The scene memories of the RIVAGE PM series hold mixing data such as channel fader levels and EQ, as well as all of the following:

- Patch settings
- Fader layer selection status of each bay
- Fade time settings
- Focus settings
- Playback link settings

When a scene is recalled, it is recalled to the current mix data through three filters: Focus, Recall Safe, and Channel Isolate.

Overlay and storing a scene

Overlay is a function that enables you to specify a temporary offset value for the fader or send levels in the current mix. Normally, these Overlay offset values are ignored when the scene is stored. However, you can also store the resultant values to which the offset values have been added.

Scene memory > About the conceptual memory diagram

Library function

Separately from scenes, various library functions allow data such as EQ settings and channel names to be saved and recalled.

About scene memories

On the RIVAGE PM series, scene numbers consist of an integer portion and a decimal portion, and can be assigned as desired. One way of organizing scenes would be to create integer-numbered scenes (main scenes) for each song, and then use the decimal portion to manage detailed changes within the song. Up to 1,000 scenes can be stored.

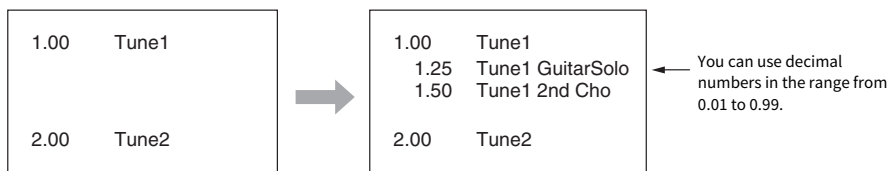

STORE

Stores the current mix data of the RIVAGE PM series as a new scene to the selected scene memory.

UPDATE

Updates scene data by overwriting the current scene (that has been recalled most recently) with the current mix data.

RECALL

Recall a stored scene from scene memory. When a scene is recalled, the data is applied according to the Focus settings included in that scene, the Recall Safe settings that are common to all scenes, and the Isolate setting for each channel.

COMMENT

For each scene, you can enter a comment as a reminder.

FOCUS

You can specify the parameters of a scene that will be selectively recalled (loaded) when that scene is recalled. This can be specified for each scene. For example, it can be convenient to use this function if you want to recall only the input channel settings of a certain scene.

FADE TIME

You can make the faders of specified channels/DCAs change smoothly to their new values over a specified duration when you recall a scene. The settings of the Fade function can be made independently for each scene.

Control via GPI/MIDI

You can use the GPI connector or MIDI connectors to execute scene recall from an external device, or to transmit signals to an external device in conjunction with scene recall.

Playback Link

You can specify an audio file that will play back from a USB flash drive when a specific scene is recalled. This can be convenient if you want a sound effect or background music to be played automatically for a specific scene. The Playback Link function can be turned on/off for each scene.

Global Paste

You can copy and paste channel or parameter settings from the current scene to scene data in memory (multiple scene selections are allowed).

Recall Safe

You can select specific channels/parameters that will be excluded from recall when scene recall occurs.

Protect

You can protect important scenes from being accidentally overwritten, erased, or moved.

Scene memory > About scene memories

Each scene contains the position of the top panel faders and [ON] key status, as well as the following parameters.

- Input/output port patching
- Bus settings
- Head amp settings
- EQ settings
- Dynamics 1 and 2 settings
- GEQ/PEQ and plug-In settings
- Pan/balance settings
- Insert/direct out settings
- On/off status and send level of signals sent to MIX buses
- On/off status and send level of signals sent to MATRIX buses
- DCA settings
- Mute group settings
- Channel pair settings

On the RIVAGE PM series, scene numbers consist of an integer portion and a decimal portion, and can be assigned as desired. One way of organizing scenes would be to create integer-numbered scenes for each song, and then use the decimal portion to manage detailed changes within the song.

• **Main scene**

A scene noted with a decimal portion of “00” (e.g., 1.00, 2.00 ... 999.00) is called a “main scene.”

• **Sub scene**

A scene noted with a decimal portion other than “00” (e.g., 1.10, 2.93 ... 3.51) is called a “sub scene.” You can create up to 99 sub scenes (x.01 to x.99) under one main scene. You can also create sub scenes without the main scene. (For example, you can create sub scene 1.01 without main scene 1.00.)

Using the keys in the SCENE MEMORY section

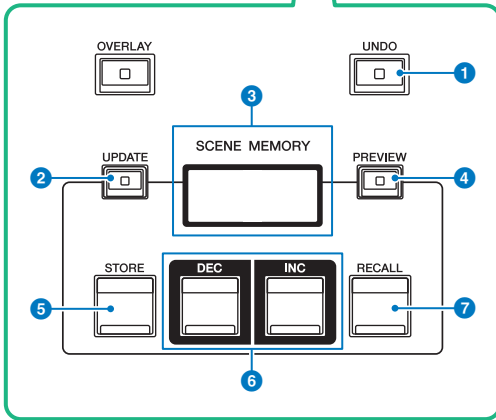
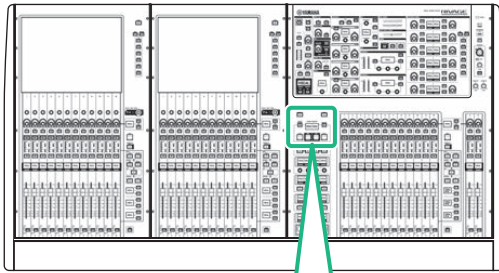

This screen contains the following items.

1 [UNDO] key

Cancels the most recent operation of storing, recalling or updating. After you cancel the operation by pressing the [UNDO] key, you can “redo” the canceled operation by pressing the [UNDO] key again.

NOTE

You cannot undo an operation to store a new scene. Delete the scene. If you recall scenes continuously during a short period of time, you might not be able to undo the operation.

2 [UPDATE] key

Updates scene data by overwriting the current scene (that has been recalled or stored most recently) with the current mix data.

3 SCENE MEMORY display

Indicates the selected scene memory.

4 [PREVIEW] key

Turns Preview mode on or off.

Scene memory > Using the keys in the SCENE MEMORY section

5 **[STORE] key**

Stores the current mix data as a new scene to the selected scene memory.

6 **[INC]/[DEC] keys**

Enable you to select the scene number of a scene that you want to store or recall.

7 **[RECALL] key**

Enables you to recall a stored scene from scene memory.

Storing scenes (Using the keys in the SCENE MEMORY section)

The current mix data on the RIVAGE PM series can be saved as new scene data, or overwritten onto existing scene data to update it.

1 Press the SCENE MEMORY [STORE] key.

The SCENE STORE window will appear, enabling you to assign a title or comment to the scene.

NOTE

- When you press the SCENE MEMORY [STORE] key, the system automatically suggests a scene number and name (“Automatic suggestion of scene numbers and names” (p.779)).
- If you want to store the scene with a decimal portion, press and hold down the [SHIFT] key, and press the SCENE MEMORY [STORE] key.

2 Enter a scene number as the store-destination.

To enter an integer, use the leftmost screen encoder on the bay. To enter a decimal portion, use the screen encoder located next to the right.

3 Assign a title or comment to the scene as desired.

For details on entering text, refer to “Entering names” (p.123).

4 Press the SCENE MEMORY [STORE] key or the OK button on the touch screen.

A dialog box will ask you to confirm the store operation.

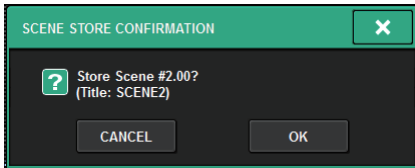

If Overlay is enabled and the STORE WITH OVERLAY APPLIED button is turned on, a dialog box will appear.

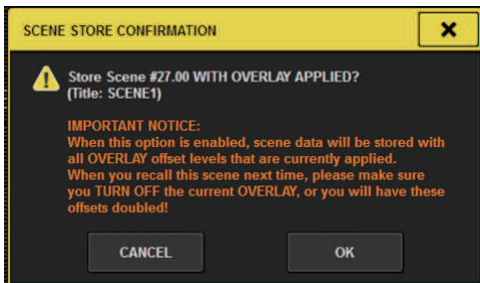

5 To execute the store operation, press the OK button.

The current mix data will be stored to the scene number you selected in step 2. If you decide to cancel the store operation, press the CANCEL button instead of the OK button.

NOTE

You can make settings such that the store confirmation dialog box will not appear (SCREEN SETTINGS). In this case, pressing the SCENE MEMORY [STORE] key once will display the SCENE STORE window, and pressing it once again will execute the store operation.

SCENE STORE screen

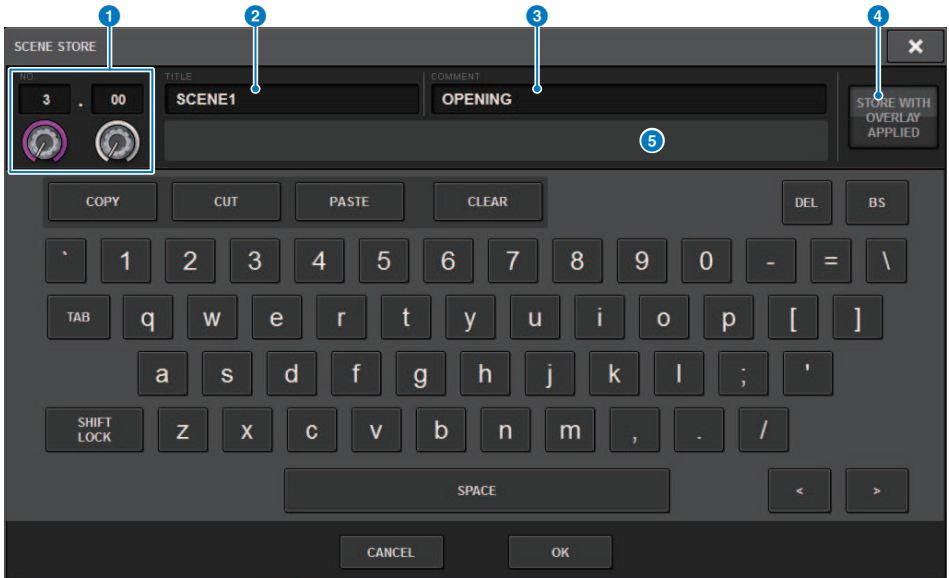

This screen contains the following items.

1 Scene number

Rotate the knob beneath the number to enter a scene number. If you enter a number that already exists for another scene, that scene will be overwritten.

2 SCENE TITLE field

Press this field to select it, and enter a title for the scene (maximum 16 characters).

3 COMMENT field

Press this field to select it, and enter a comment for the scene. You can use this as a memorandum for each scene (maximum 128 characters).

4 STORE WITH OVERLAY APPLIED button

If you press this button while Overlay is enabled, a dialog box will appear, enabling you to store scene data including all currently-applied Overlay offset values.

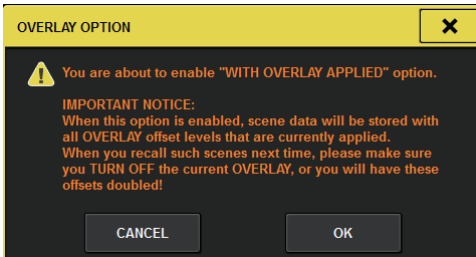



CAUTION

- While Overlay is enabled, if you recall a scene that was previously stored with added offset values, both the current offset values and the original offset values will be applied to the scene (thus doubling the offset value). An extremely high volume sound may be output as a result.

5 ADD TO GROUP button

When this is turned on, the current scene will enter the group to which it belongs. If the current scene does not belong to a group, it will not be displayed.

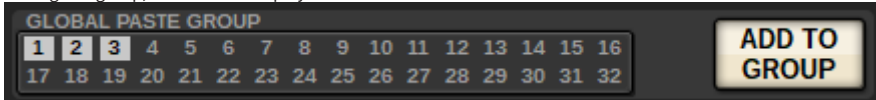

Automatic suggestion of scene numbers and names

If you press the [STORE] key, the next unused integer higher than the current scene number will be suggested. If you press the [SHIFT] key + [STORE] key, a number equivalent to the current sub scene number incremented by a decimal will be suggested. If there already exists a number with a decimal portion larger than the current scene number, then a number in-between the current scene number and the already-existing number will be suggested.



Press [STORE] key.

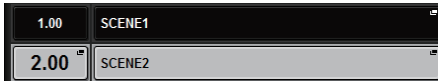

Press [SHIFT] key + [STORE] key.

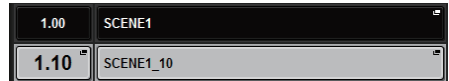

Scene list	1.00 (current scene)		1.00 (current scene) 1.10		1.00 (current scene) 1.05 1.10		1.00 (current scene) 1.50 2.00	
Procedure	Press [STORE] key.	Press [SHIFT] key + [STORE] key.	Press [STORE] key.	Press [SHIFT] key + [STORE] key.	Press [STORE] key.	Press [SHIFT] key + [STORE] key.	Press [STORE] key.	Press [SHIFT] key + [STORE] key.
Automatically-suggested scene numbers	2.00	1.10	2.00	1.05	2.00	1.02	3.00	1.25

The same name as the current scene will be suggested.

Updating scenes (Using the keys in the SCENE MEMORY section)

You can update scene data by overwriting the last-recalled scene with the current mix data.

1 Press the SCENE MEMORY [UPDATE] key.

A dialog box will ask you to confirm the update operation.

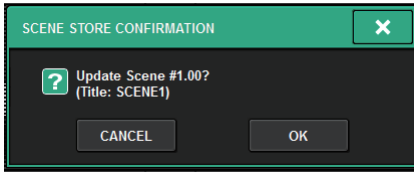

2 To execute the update operation, press the OK button.

The current mix data will overwrite the last-recalled scene.

NOTE

- You can make settings such that the Update Confirmation dialog box will not appear (SCREEN SETTINGS).
- During the update, the Overlay offset values (that are included in the current mix data) will not be added to the updated scene data. To add the offset values, you must select the existing scene data to overwrite and store it.

Recalling scenes (Using the keys in the SCENE MEMORY section)

You can recall scene data into current memory. Scene data is recalled through three filters: Focus, Recall Safe, and Channel Isolate.

1 Use the **SCENE MEMORY [INC]/[DEC]** keys to select the scene number that you want to recall.

The scene number of the currently-selected scene appears in the “SCENE field” (p.783) of the menu bar. If you recall any scene other than the last-recalled or stored scene (hereinafter called “current scene”), the scene number will flash.

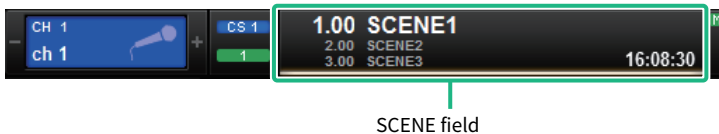

NOTE

To view the comments, press and hold down the [SHIFT] key and press the SCENE field.

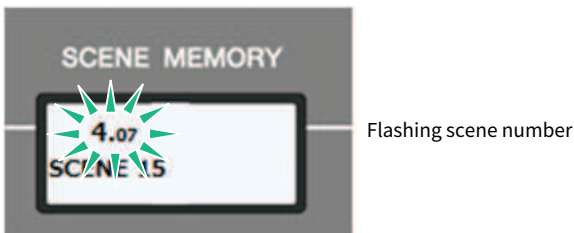

2 Press the **SCENE MEMORY [RECALL]** key.

A dialog box will ask you to confirm the recall operation.

3 To execute the recall operation, press the **OK** button.

The scene you selected in step 1 will be recalled. If you decide to cancel the recall operation, press the CANCEL button.



CAUTION

- While Overlay is enabled, if you recall a scene that was stored or globally-pasted with added offset values, both the current offset values and the original offset values will be applied to the scene, thus, doubling the offset value. In this case, extremely high volume sound may be output. Confirm the status of a scene to recall, and the on/off status of Overlay, before recalling the scene.

NOTE

- You can make settings such that the recall confirmation dialog box will not appear.
- If you press and hold down either of the SCENE MEMORY [INC]/[DEC] keys, the scene number will count up or down continuously. If you press and hold down either of the SCENE MEMORY [INC]/[DEC] keys, the scene number will increment or decrement quickly.
- If you press the SCENE MEMORY [INC] and [DEC] keys simultaneously, the SCENE field indication will return to the number of the currently-loaded scene.
- You cannot store data to a protected scene number.

SCENE field

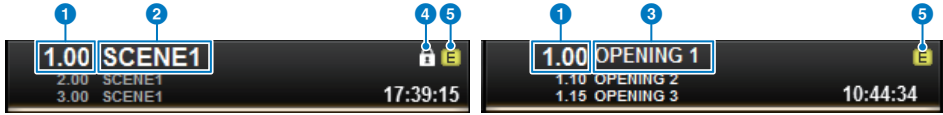

This screen contains the following items.

The SCENE field always displays general information about the scene. To switch between scene comment and scene title displays, hold down the [SHIFT] key and press the SCENE field. You can also press this field to access the SCENE LIST screen, in which you can view and edit more detailed settings for the scene.

- 1 Scene number**
Indicates the number of the currently-selected scene.
- 2 Scene title**
Indicates the title of the currently-selected scene.
- 3 Comment**
Indicates the comments for the currently-selected scene.

NOTE

In the bottom two rows, you can view the number, title and comments for two preceding scenes.

- 4 Protect symbol**
Write-protected scenes are indicated by a protect symbol.
- 5 E symbol (EDIT symbol)**
This symbol will appear when you edit the mix parameters for the currently-loaded scene. This symbol indicates that you must execute the store operation if you want to keep the changes you made.

Storing scenes (Using the SCENE LIST screen)

1 Press the SCENE field on the menu bar.

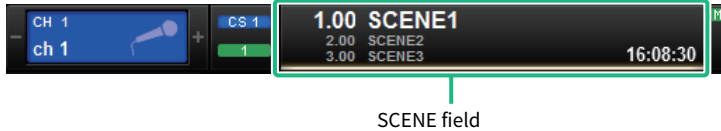

This screen includes several pages, which you can switch between using the tabs located at the top of the screen.

2 Press the SCENE LIST tab.

The view switches to the “SCENE LIST screen” (p.786).

3 Press the SCENE STORE button.

The SCENE STORE window will appear, enabling you to assign a title or comment to the scene.

4 Enter a scene number as the store-destination.

To enter an integer, use the leftmost screen encoder on the bay. To enter a decimal portion, use the screen encoder located next to the right.

NOTE

You can also use the SCENE MEMORY [INC]/[DEC] keys to select scene numbers. To select a decimal portion, hold down the [SHIFT] key and use the SCENE MEMORY [INC]/[DEC] keys. A yellow scene number indicates that the scene number has already been used.

A red scene number indicates that the scene number has already been used and protected.

5 Assign a title or comment to the scene as desired.

6 Press the OK button located at the bottom of the SCENE STORE window.

A dialog box will ask you to confirm the store operation.

7 To execute the store operation, press the OK button.

The current mix data will be stored to the scene number you selected in step 4. If you decide to cancel the store operation, press the CANCEL button instead of the OK button.



CAUTION

- While Overlay is enabled, if you recall a scene that was previously stored with added overlay offset values, both the current offset values and the original offset values will be applied to the scene (thus doubling the offset value). An extremely high volume sound may be output as a result.

8 If you want to cancel the overwrite-store operation that you just performed, press the UPDATE UNDO button.

Immediately after overwrite-storing a scene, you can use the UPDATE UNDO button to undo (cancel) the scene store operation that was executed most recently. When you press the UPDATE UNDO button, a dialog box will ask you to confirm the undo operation. Press the OK button if you want to execute the undo operation.

NOTE

The UPDATE UNDO button is available only immediately after overwrite-storing.

SCENE LIST screen

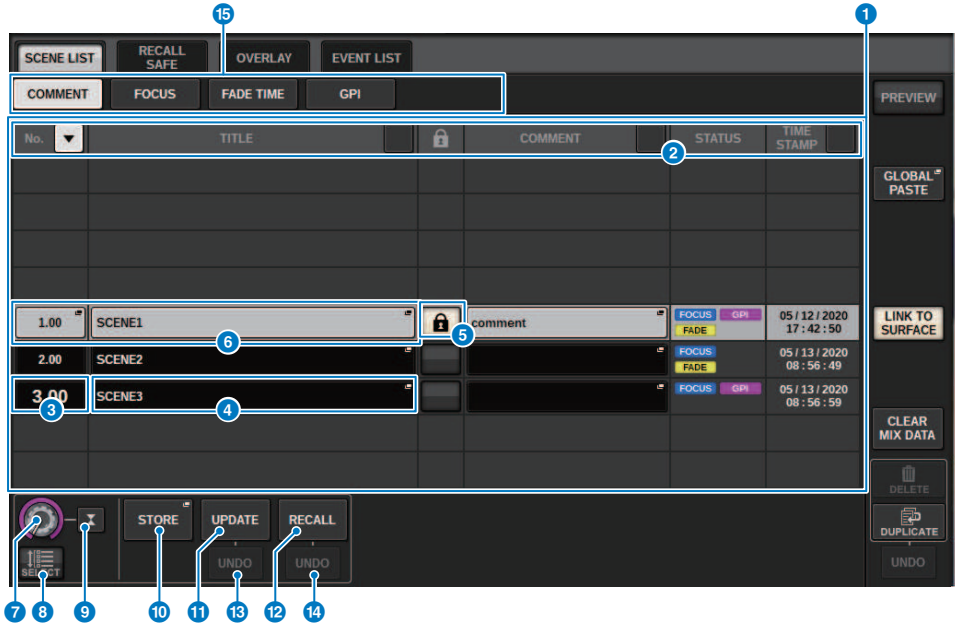

This screen contains the following items.

1 Scene list

This area shows information about the scenes stored in memory.

2 Sort buttons

The list will be sorted as follows, according to the column header you pressed.

- **NO.**
Sorts the list in order of scene number.
- **TITLE**
Sorts the list in numerical/alphabetical order by title.
- **COMMENT**
Sorts the list in numerical/alphabetical order of comments.
- **TIME STAMP**
Sorts the list by date and time of creation.

NOTE

By pressing the same location again, you can change the direction (ascending or descending order) in which the list is sorted.

3 Scene number

Indicates the current scene number. The scene number in a larger font indicates the current scene.

4 Scene title popup button

Indicates the title assigned to the scene. Press this button to access the SCENE STORE popup window, in which you can edit the title.

5 Protect (lock) symbol

Indicates the write protect on/off status. Press this button to write-protect the scene, and the button will light. Press it again to cancel write protection.

6 Selected scene

The currently-selected scene is highlighted in white in the list. If you press another scene number in the list, the list will scroll and that scene cell will be displayed in the center of the list.

7 SCENE SELECT knob

Use the screen encoder to select a scene.

8 MULTI SELECT button

You can select consecutive multiple scenes by turning on this button and rotating the screen encoder.

9 Current scene select button

Press this button to select the scene that was recalled or stored most recently.

10 STORE button

Stores the current mix data as a new scene. Press this button to access the SCENE STORE popup window, which will enable you to assign a name to a scene and store it.

11 UPDATE button

Updates scene data by overwriting the scene (that has been recalled or stored most recently) with the current mix data.

12 RECALL button

Press this button to recall the currently-selected scene.

13 UPDATE UNDO button

Undoes the store operation. This button is valid only immediately after you perform an overwrite-store operation.

14 RECALL UNDO button

Undoes the recall operation. This button is valid only immediately after you perform a recall operation.

15 Page switching tabs

Switch the views for the right side of the SCENE LIST screen.

Recalling scenes (Using the SCENE LIST screen)

- 1 Press the SCENE field on the menu bar.**
- 2 Rotate the screen encoder to select the scene number of the scene you want to recall.**

- 3 Press the RECALL button.**

A dialog box will ask you to confirm the recall operation.

- 4 To execute the recall operation, press the OK button.**

The scene you selected in step 3 will be recalled. If you decide to cancel the recall operation, press the CANCEL button instead of the OK button.



CAUTION

- While Overlay is enabled, if you recall a scene that was stored or globally-pasted with added offset values, both the current offset values and the original offset values will be applied to the scene, thus, doubling the offset value. In this case, extremely high volume sound may be output. Confirm the status of a scene to recall, and the on/off status of Overlay, before recalling the scene.

- 5 If you want to cancel the recall operation that you just performed, press the RECALL UNDO button.**

A dialog box will ask you to confirm the undo operation. Press the OK button if you want to execute the operation. After undoing the recall, you can press the RECALL UNDO button once again to Redo (re-execute).

NOTE

You can also use “Using Program Changes to recall scenes” (p.977).

Using USER DEFINED keys to recall a scene (Direct Recall function)

You can use the USER DEFINED keys to recall a selected scene with a single keystroke, or to step through the scenes. To do this, you must first assign a scene recall operation to a USER DEFINED key. The following recall operations can be assigned to a USER DEFINED key.

- **INC RECALL**

Immediately recalls the scene of the number that follows the currently-loaded scene.

- **DEC RECALL**

Immediately recalls the scene of the number that precedes the currently-loaded scene.

- **DIRECT RECALL**

Directly recalls the scene number that you assigned to the USER DEFINED key. When you press a USER DEFINED key to which this function is assigned, the assigned scene will be recalled immediately.

To assign one of these functions to a USER DEFINED key so that a scene can be recalled in a single keystroke, proceed as follows.

1 Press the **SETUP** button on the menu bar to access the **SETUP** screen.



2 Press the **USER DEFINED KEYS** button to access the **USER DEFINED KEYS** popup window.

The USER DEFINED KEYS page enables you to assign functions to USER DEFINED keys [1]–[12].

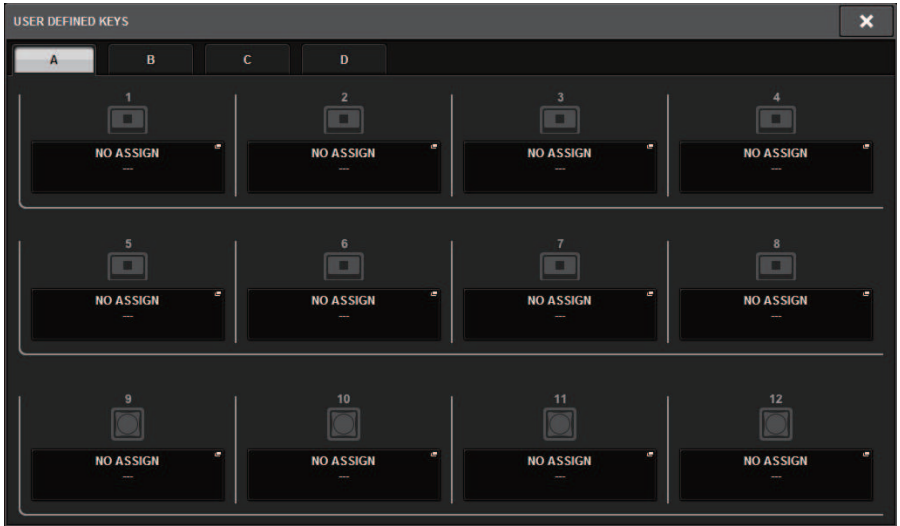

3 Press the popup button for the **USER DEFINED** key (to which you want to assign a function) to open the popup window.

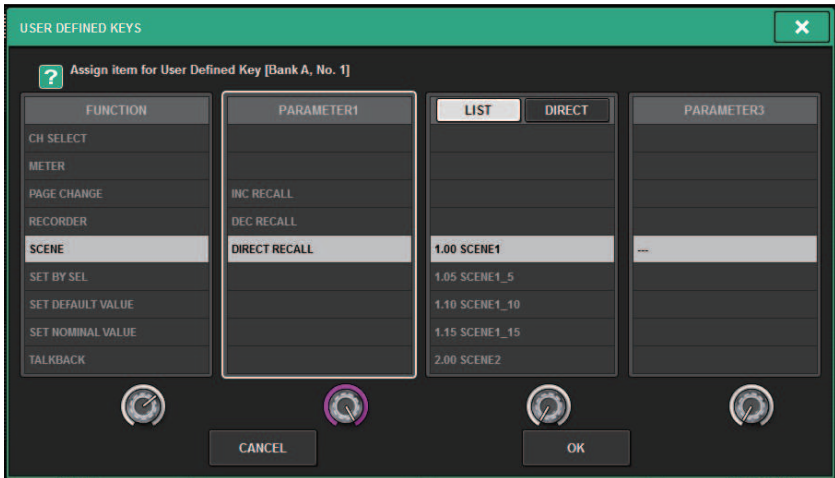

Scene memory > Using USER DEFINED keys to recall a scene (Direct Recall function)

4 In the FUNCTION column, select “SCENE.”

Proceed as follows, depending on the function you want to assign.

- **To assign INC RECALL or DEC RECALL**

Choose “INC RECALL” or “DEC RECALL” in the PARAMETER 1 column.

- **To assign DIRECT RECALL**

Choose “DIRECT RECALL” in the PARAMETER 1 column, and choose “SCENE #xxx” (xxx is the scene number) in the PARAMETER 2 column.

5 When you finish making settings, press the OK button to close the popup window.

If desired, assign scene-recall functions to other USER DEFINED keys in the same way.

6 Press the USER DEFINED key to which you assigned a recall function.

The corresponding scene will be recalled.



CAUTION

- While Overlay is enabled, if you recall a scene that was stored or globally-pasted with added offset values, both the current offset values and the original offset values will be applied to the scene, thus, doubling the offset value. In this case, extremely high volume sound may be output. Confirm the status of a scene to recall, and the on/off status of Overlay, before recalling the scene.

Sorting scene memories

1 Press the SCENE field on the menu bar.

The SCENE LIST screen will appear, in which you can perform various scene-related operations. You can use the tabs located at the top of the SCENE LIST screen to select one of five different fields: COMMENT, FOCUS, FADE TIME, GPI OUT, or PLAYBACK LINK.

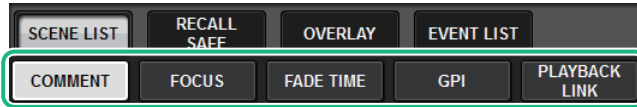

2 Press a desired tab at the top of the SCENE LIST screen.

The view of the right side of the SCENE LIST screen will change accordingly.

3 To select a scene number, rotate the screen encoder or the [TOUCH AND TURN] knob on the top panel.

The highlighted line in the scene list indicates that the corresponding scene is currently selected for operations.

4 To sort the list, press one of the column headers: “No.,” “TITLE,” “COMMENT,” or “TIME STAMP” at the top of the scene list and COMMENT field.

Scene list and COMMENT field

5 If you want to edit the title or comment field of a scene, press the TITLE field or COMMENT field of the scene to access the SCENE STORE window.

6 To enable/disable the protect setting, press the protect symbol.

A protect symbol is displayed for write-protected scenes. These scenes cannot be overwritten.

7 Use the tool buttons to edit scene memory.

For more information, refer to ““About editing scene memories” (p.795).”

SCENE LIST screen

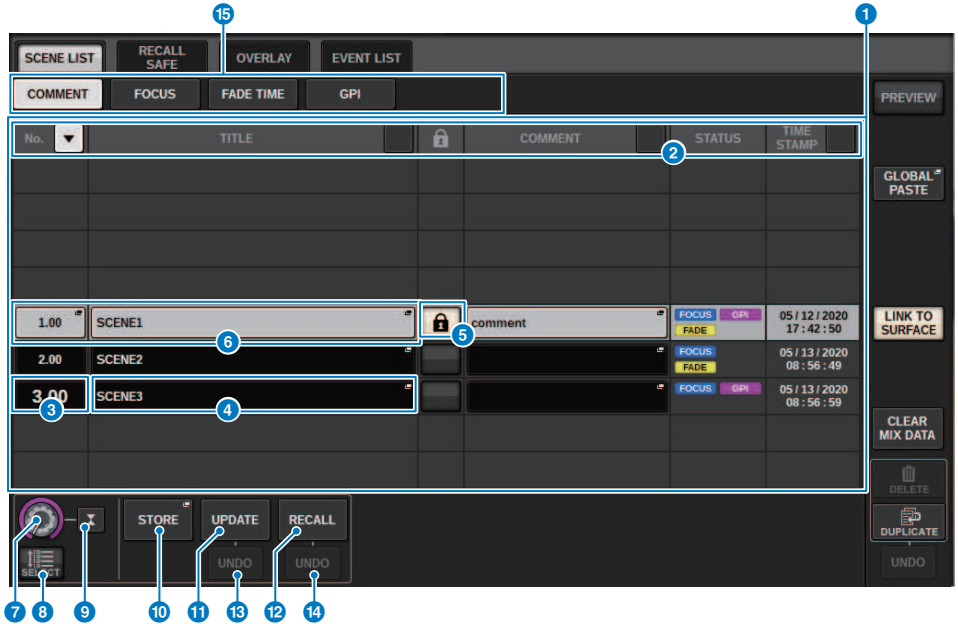

This screen contains the following items.

1 COMMENT sort button

Sorts scenes in alphabetical order of the comments in the COMMENT field. Pressing the button repeatedly will alternate between ascending and descending order.

2 COMMENT field

Press this field to open the SCENE STORE window, in which you can enter a comment for the scene.

3 STATUS field

Indicators in this field indicate the settings of FOCUS, FADE (fade time), GPI (general-purpose interface), and PLAY (playback link, which starts playing a desired song a certain period of time after a scene is recalled).

4 TIME STAMP sort button

Sorts scenes in chronological order based on the date and time in the TIME STAMP field. Pressing the button repeatedly will alternate between ascending and descending order.

5 TIME STAMP field

Indicates the date and time when the scene was stored. For details on the TIME STAMP display format, refer to "Setting the date and time of the internal clock".

6 CLEAR MIX DATA popup button

Press this button to access a popup window, in which you can confirm that you want to reset the current mix data to the default settings.

Scene memory > SCENE LIST screen

7 LINK TO SURFACE button

Turning this off will let you scroll the scene list without affecting the menu bar or scene number on the operating panel.

About editing scene memories

The scenes stored in scene memory can be erased or duplicated into different scene numbers.

1 Press the SCENE field on the menu bar.

The SCENE LIST screen appears, in which you can perform various scene-related operations.

2 Perform the desired editing operation.

For more information about these operations, refer to the explanations below.

Deleting a scene (DELETE)

This section explains how to delete a scene.

1 Press the **SCENE** field on the menu bar.

The SCENE LIST screen will appear.

2 Rotate the **CH1** screen encoder to select the scene you want to delete, and then press the **DELETE** button.

A dialog box will ask you to confirm the delete operation.

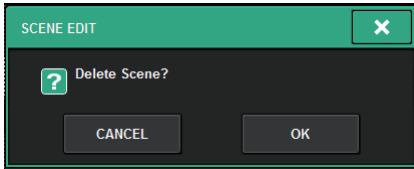

NOTE

- You can select multiple scenes to delete. To do so, press the MULTI SELECT button to turn it on, and then rotate the appropriate screen encoder.
- You can delete multiple main scenes and sub scenes all together. For example, you can delete scenes 1.00, 1.25, and 1.50 simultaneously.

3 To execute the delete operation, press the **OK** button.

The scene number(s) you selected in step 2 will be cleared. If you decide to cancel the delete operation, press the CANCEL button instead of the OK button.

NOTE

- You cannot delete protected scenes.
- To undo a scene deletion, press the UNDO button.
- If you select multiple scenes and delete them all at once, you will be unable to undo the delete operation.

Duplicating a scene (DUPLICATE)

You can duplicate a scene to create a new scene.

1 Press the **SCENE** field on the menu bar.

The SCENE LIST screen will appear.

2 Rotate the **CH1** screen encoder to select the scene you want to duplicate, and then press the **DUPLICATE** button.

The SCENE DUPLICATE window will appear, enabling you to assign a title or comment to the scene.

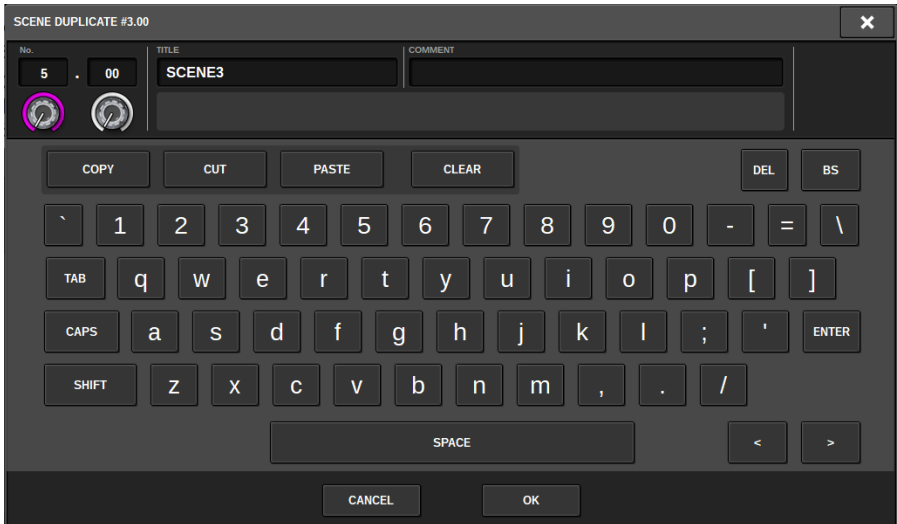

3 Assign a title or comment to the scene as desired.

NOTE

- You cannot select multiple scenes as a duplicate source.
- You can store duplicated scenes to any scene numbers.

4 To execute the duplicate operation, press the **OK** button.

The source scene will be duplicated and saved to the scene numbers specified in step 3. If you decide to cancel the duplicate operation, press the CANCEL button instead of the OK button.

Modifying the scene number and title (RENAME)

This section explains how to modify the scene number and title.

1 Press the SCENE field on the menu bar.

The SCENE LIST screen will appear.

2 Rotate the CH1 screen encoder to select the scene for which you want to modify the number or title, and then press the scene title popup button.

The SCENE EDIT window will appear, enabling you to assign a title or comment to the scene.

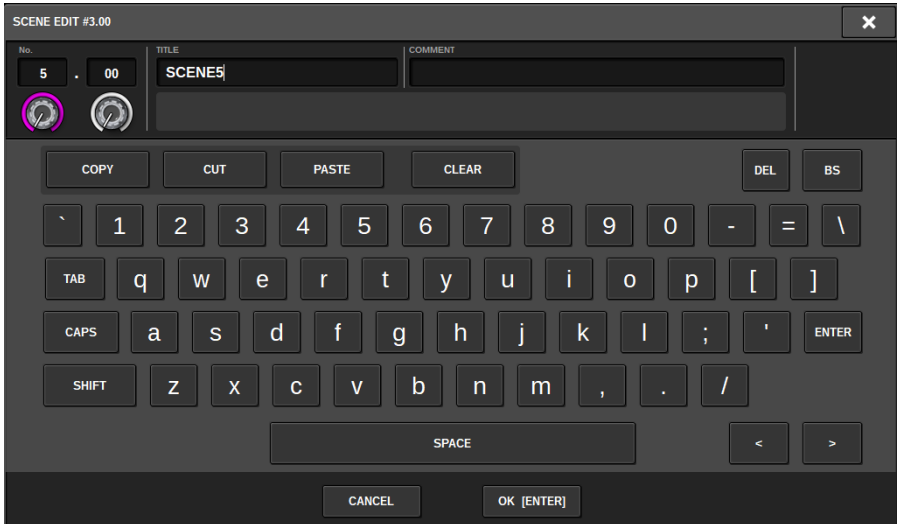

3 Modify the scene number and/or rename the scene, as desired.

4 To execute the rename operation, press the OK button.

The changes you made in step 3 will be applied to the selected scene.

About the Focus function

Focus is a function that lets you select which part of the data will be recalled when recalling scene data. Focus settings are saved in the data of each scene.

Example: In a live concert where the engineer also changes for each band, it might be desirable to adjust the GEQ for each engineer. The Focus function can be set for each scene, so even if the GEQ is adjusted for the first song, scenes for the second and subsequent songs can be recalled with Focus settings that exclude the GEQ, so that the GEQ settings of the first song are preserved.

Using the Focus function

“Focus” is a function that lets you specify the scene parameters that will be recalled (loaded) when you recall a scene. You can enable or disable this function for each scene individually. For example, it can be convenient to use this function if you want to recall only the input channel settings of a certain scene.

NOTE

In contrast to Focus, the RIVAGE PM series also features a “Recall Safe” function that enables you to exclude specific channels and parameters from recall operations. However, while the Focus Recall function can be specified individually for each scene, the Recall Safe function settings are common to all scenes.

1 Press the SCENE field on the menu bar to access the SCENE LIST screen.

2 Press the FOCUS tab at the top of the SCENE LIST screen.

The “FOCUS field” (p.802) appears in the right half of the SCENE LIST screen.

3 Press the SET popup button of the scene for which you want to make Focus settings.

The SCENE SETUP (FOCUS) popup window appears.

4 To select a target channel to be set, press the + button on the channel display ② to expand the channel display, and then scroll through the category select list (channel) ①.

5 If you want to apply the Focus function only to specific parameters, use the parameter buttons ⑨ to select those parameters (multiple selections are allowed). If you want to apply the Focus function to all parameters, turn on the ALL ON button ⑥.

6 Turn on the channel Focus ON button ⑤ for the channels to which you want to apply the Focus function.

If you want to apply the Focus function to all channels, turn on the ALL channel Focus ON button ④.

7 When you finish making settings, press the “x” symbol to close the window.

The FOCUS PARAMETER indicator on the FOCUS tab of the SCENE LIST screen will show the Focus setting status of the scene for which the Focus function is configured.

NOTE

Scenes for which the FOCUS button is turned on are marked by a “FOCUS” indicator in the STATUS field of the SCENE LIST window (COMMENT tab).

8 Recall a scene for which you have made Focus settings.

Only the channels/parameters selected in the SCENE SETUP (FOCUS) popup window will be recalled.

Scene memory > Using the Focus function

NOTE

You can use the Focus function in conjunction with the Recall Safe function. Channels or parameters that are excluded from recall operations by either Focus or Recall Safe will not be recalled.

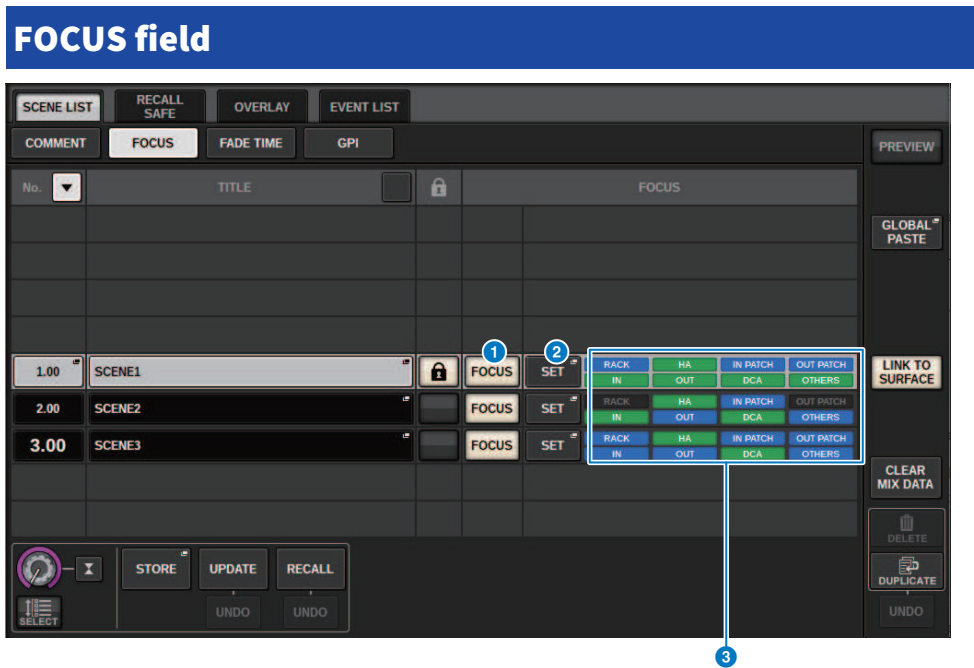

This screen contains the following items.

- 1 FOCUS button**

Enables or disables the Focus function for each scene.
- 2 SET popup button**

Press this button to access the SCENE SETUP (FOCUS) popup window, which enables you to select the parameters that you want to recall.
- 3 Focus parameter display section**

These indicators show the Focus settings that are specified for each scene (green: all parameters; blue: selected parameters).

SCENE SETUP (FOCUS) popup window

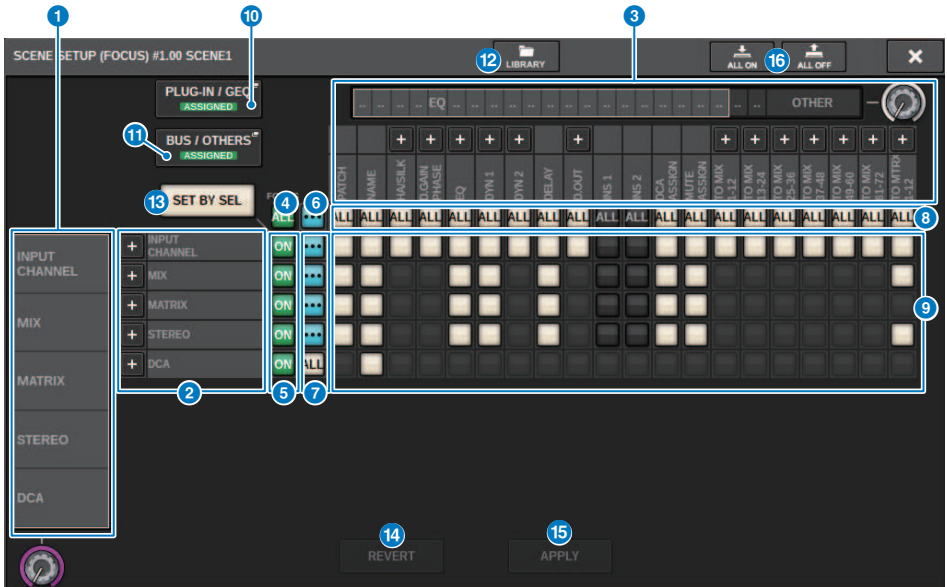

This screen contains the following items.

- 1 Category select list (channel)**
Enables you to select a channel category.
- 2 Channel display**
Indicates the channel name. You can press the + or – button located next to the channel name to expand or collapse the channel indication for each category.
- 3 Category select list**
Enables you to select the category of parameters to be displayed on screen. You can press the + or – button located below to expand or collapse the channel parameter indication for each category.
- 4 ALL channel Focus ON button**
Specifies whether you want to apply the Focus function to all channels.
- 5 Channel Focus ON button**
Turn Focus on or off for each channel.
- 6 ALL ON button**
Turns Focus on for all parameters on all channels.
- 7 ALL parameter ON buttons**
Turn Focus on for all parameters that belong to the corresponding channels.

Scene memory > SCENE SETUP (FOCUS) popup window

8 **ALL channel ON button**

Turn Focus on or off for all channels related to the selected parameter.

9 **Parameter ON buttons**

Turn Focus on or off for parameters on each channel.

10 **PLUG-IN/GEQ popup button**

Press one of these buttons to access the popup window, in which you can set the Focus function for each plug-in or GEQ.

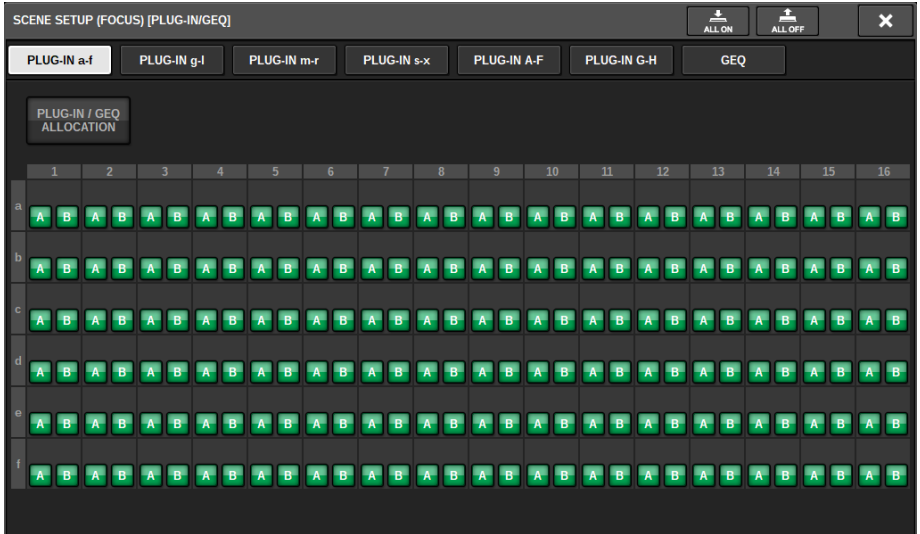

NOTE

If Focus Recall is set to on, the parameters of the RACK with different GEQs / PEQs or effect plug-ins are not recalled when Focus Recall for the PLUG-IN / GEQ ALLOCATION is turned off. To recall with the mount status, turn on Focus Recall for the PLUG-IN / GEQ ALLOCATION.

11 **BUS/OTHERS popup button**

Press this button to access a popup window where you can specify how the Focus function affects basic MIX bus settings, channel link, and fader layer position.

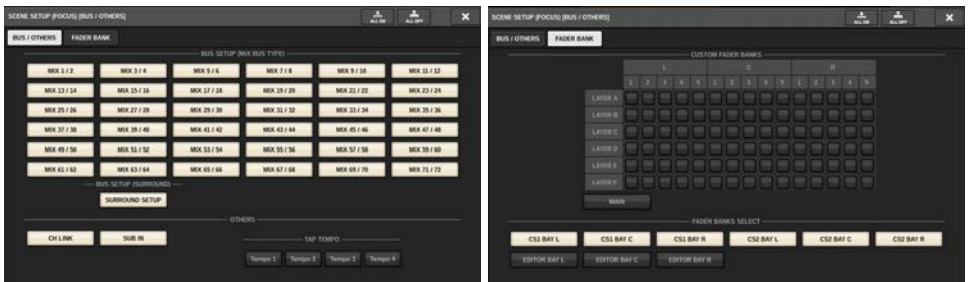

Scene memory > SCENE SETUP (FOCUS) popup window

12 **LIBRARY button**

Press this button to open the FOCUS library window.

13 **SET BY SEL button**

If this button is on, you will be able to add a channel by using the corresponding [SEL] key.

14 **REVERT button**

If you press this button, all changes that you made up to that point will be canceled, reverting to their prior state.

15 **APPLY button**

Pressing the button will apply the setting changes.

16 **ALL ON button/ALL OFF button**

Turns on/off all settings including those in the PLUG-IN/GEQ and BUS/OTHERS tabs.

Button indications

The button indications will change according to the parameter status.



ON



OFF



Partially ON



Channel off



Recall Safe is activated, or channel is isolated

Using the Fade function

“Fade” is a function that smoothly changes the faders of specified channels/DCAs to their new values over a specified duration when you recall a scene. You can set the Fade function independently for each scene.

1 Press the SCENE field on the menu bar to access the SCENE LIST screen.

2 Press the FADE TIME tab at the top of the SCENE LIST screen.

The “FADE TIME field” (p.807) will appear in the right half of the SCENE LIST screen.

3 Press the SET popup button.

The “SCENE SETUP (FADE TIME) popup window” (p.808) appears.

4 In the channel select field, select the channels to which the Fade effect will be applied (multiple selections are allowed).

The [SEL] keys for the selected channels or DCAs will light, and those channels or DCAs will be highlighted green in the channel display field. You can cancel the selection by pressing the lit [SEL] key once again to turn it off.

5 Use the screen encoder that corresponds to the FADE TIME knob, or use the [TOUCH AND TURN] knob to adjust the fade time.

The range is 0.0 sec – 60.0 sec. When you finish setting the fade time, press the OK button to close the FADE TIME setup window.

NOTE

The fade time you specify here is used for all channels/DCAs selected in step 4.

6 Press the FADE button to enable the Fade function.

You can turn the Fade function on or off individually for each scene.

NOTE

Scenes for which the Fade function is enabled are marked by a “FADE” indicator in the STATUS field of the SCENE LIST window (COMMENT tab).

7 Recall a scene for which the Fade function is turned on.

The faders will begin to move immediately after Recall occurs, and will reach the values of the recalled scene over the course of the specified fade time.

NOTE

- By touching a moving fader, you can stop the fade operation of the fader at that point.
- If you recall the same scene while faders are moving, the faders of all channels and DCAs will move immediately to their target positions.

FADE TIME field

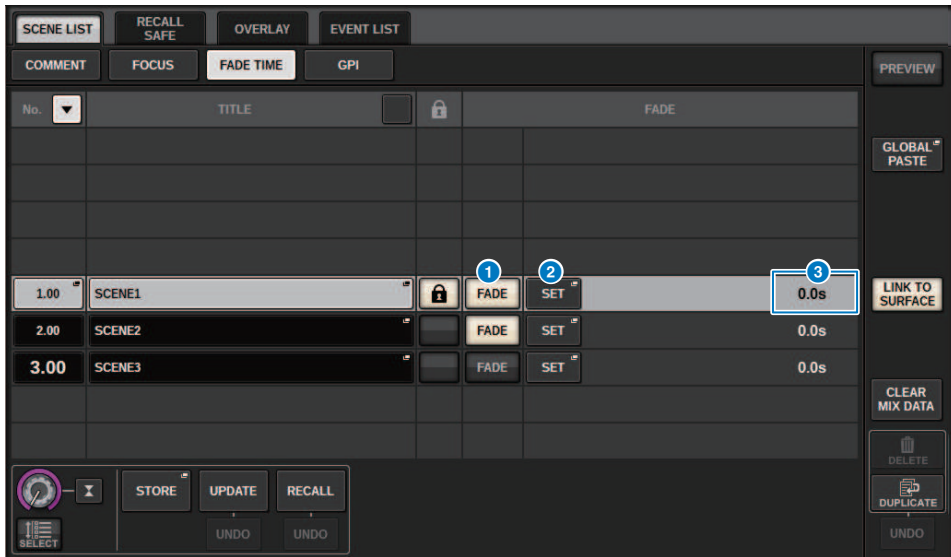

This screen contains the following items.

- 1 FADER button**
Enables or disables the Fade function for each scene.
- 2 SET popup button**
Press this button to access the FADE TIME setup window, in which you can select a channel for which you want to use the Fade function, and specify the fade time (the duration of time over which the fader will reach its new value).
- 3 FADE TIME display**
This area indicates the fade time specified for each scene.

SCENE SETUP (FADE TIME) popup window



In this popup window you can select the channels to which Fade will be applied, and adjust the fade time.

1 Channel display field

In this field, the channels or DCAs to which Fade is applied (selected in the channel select field 2) are highlighted.

2 Channel select field

Enables you to select the channels/DCAs to which Fade is applied.

3 SET BY SEL button

If this button is on, you will be able to add a channel by using the corresponding [SEL] key.

4 FADE TIME knob

Enables you to set the fade time. Use the corresponding screen encoder to adjust the value.

5 CLEAR ALL button

Press this button to restore the default settings of the selected channel or fade time.

Outputting a control signal to an external device in tandem with scene recall (GPI OUT)

A control signal can be output to an external device connected to the GPI connector of the RIVAGE PM series when you recall a specific scene. Proceed as follows.

NOTE

For more information about GPI OUT settings, refer to “Using GPI OUT” (p.992).

- 1 Press the SCENE field on the menu bar to access the SCENE LIST screen.**
- 2 Press the GPI tab at the top of the SCENE LIST screen.**
The “GPI field” (p.811) appears in the right half of the SCENE LIST screen.
- 3 Press the GPI SET popup button to access the SCENE SETUP (GPI) popup window.**



- 4 For each scene, specify the control signal that you want to output to each GPI OUT port.**

Pressing a button repeatedly will switch between the following functions.

- (OFF).....Nothing will be output.
- TRIGGER.....A trigger will be output when the scene is recalled.
- TALLY.....A tally will be output when the scene is recalled.

- 5 When you finish making settings, press the OK button.**

The setting will be finalized, and the popup window will close. If you press the CANCEL button instead of the OK button, your changes will be discarded and the popup window will close.

NOTE

Scenes for which the GPI settings are made are marked by a “TALLY” or “TRIG” indicator in the GPI PARAMETER display section of the SCENE LIST window (GPI tab).

- 6 Press the GPI button to enable the GPI OUT function.**

You can turn the GPI OUT function on or off individually for each scene.

Scene memory > Outputting a control signal to an external device in tandem with scene recall (GPI OUT)

NOTE

Scenes for which the GPI button is turned on are marked by a “GPI” indicator in the STATUS field of the SCENE LIST window (COMMENT tab).

7 Recall the scene for which you want to output GPI OUT signals.

When you recall the scene, the control signals will be output to an external device connected to the GPI OUT connector.

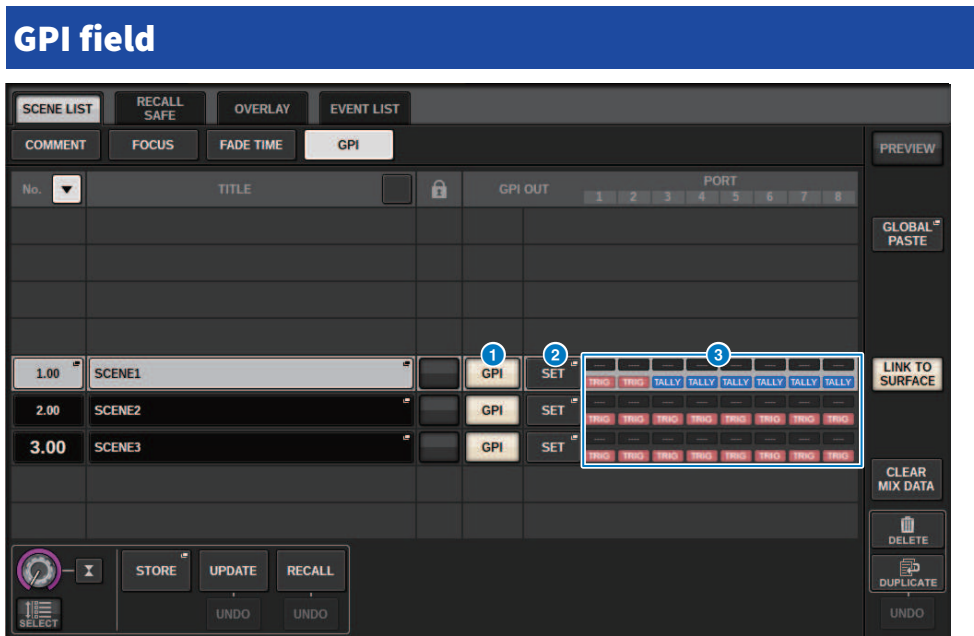

This screen contains the following items.

- 1 GPI button**

If this button is on and the selected scene is recalled, a control signal will be output.
- 2 SET popup button**

Press this button to access a popup window, in which you can specify the control signal output from each GPI OUT.
- 3 GPI PARAMETER display section**

In this section, indicators show the status of the GPI settings specified for each scene.

Playing back an audio file in tandem with scene recall (PLAYBACK LINK)

You can specify an audio file that will be played back from a USB flash drive when a specific scene is recalled. This can be convenient if you want a sound effect or background music to be played automatically for a specific scene. Follow the steps below to link a scene recall with audio file playback.

NOTE

- Audio files to be played should be saved in the SONGS folder inside the YPE folder. If you save them in the root directory or in other folders, you will be unable to specify them for playback. When an audio file is played, the path in the TITLE LIST screen will indicate \YPE\SONGS\.
- You cannot play audio files during recording or in recording standby mode.
- A specified audio file will be played back only once, regardless of the playback mode settings.
- A specified file is recognized by a file name with a maximum of 64 characters, plus three extension characters. If you change the file name after specifying the file for playback, or if you delete or copy the file repeatedly, the specified file may become unrecognizable in rare cases.
- You can only link audio files of the control surface whose CONSOLE ID=1.

1 Connect a USB flash drive that contains the audio files to the RECORDING connector.

2 Press the SCENE field on the menu bar. The SCENE LIST window will appear, in which you can perform various scene-related operations.

3 Press the PLAYBACK LINK tab located at the top of the SCENE LIST screen.

The “PLAYBACK LINK field” (p.814) will appear in the right half of the SCENE LIST screen.

4 Press the song select popup button for a scene to which you want to link the audio file.

The “PLAYBACK LINK popup window” (p.815) appears. In this popup window, you can select an audio file that you want to link with the scene, and set the offset time.

5 Press the SONG TITLE list or use the screen encoder to select a file that you want to link to a scene.

6 If desired, use the corresponding screen encoder to set the offset (the time duration until the start of audio file playback).

The offset time can be adjusted in the range of 0.0 – 99.0 in 0.1 sec steps.

7 Press the OK button.

The title of the selected song will appear in the middle of the song list. If you select the CANCEL button instead of the OK button, your settings will be discarded and the unit will return to the SCENE LIST window.

Scene memory > Playing back an audio file in tandem with scene recall (PLAYBACK LINK)

8 Press the PLAY button to turn on the link to the audio file.

You can turn the Playback function for audio files on or off individually for each scene.

NOTE

Scenes for which the PLAY button is turned on are marked by a "PLAY" indicator in the STATUS field of the SCENE LIST window (COMMENT tab).

9 Repeat steps 4–8 to link audio files to other scenes.

10 Recall a scene to which an audio file has been linked.

After the offset time duration has elapsed, the specified audio file will play once.

NOTE

If another song is playing during a scene recall, the song playback will stop when the scene is recalled, regardless of the offset time setting.

PLAYBACK LINK field

No.	TITLE	LINK	SONG TITLE	OFFSET
1.00	SCENE1	PLAY		0.0s
2.00	SCENE2	PLAY		0.0s
3.00	SCENE3	PLAY		0.0s

This screen contains the following items.

- 1 PLAY button**

Enables or disables the Playback Link function for each scene.
- 2 Song select popup button**

Press this button to access the PLAYBACK LINK popup window, in which you can select a song and set the offset time (time duration from scene recall until the start of playback). The title of the selected song will appear on the button.
- 3 Offset time display**

Indicates the time duration from scene recall until the start of playback of the specified audio file. You can set the offset time in the PLAYBACK LINK popup window.

PLAYBACK LINK popup window

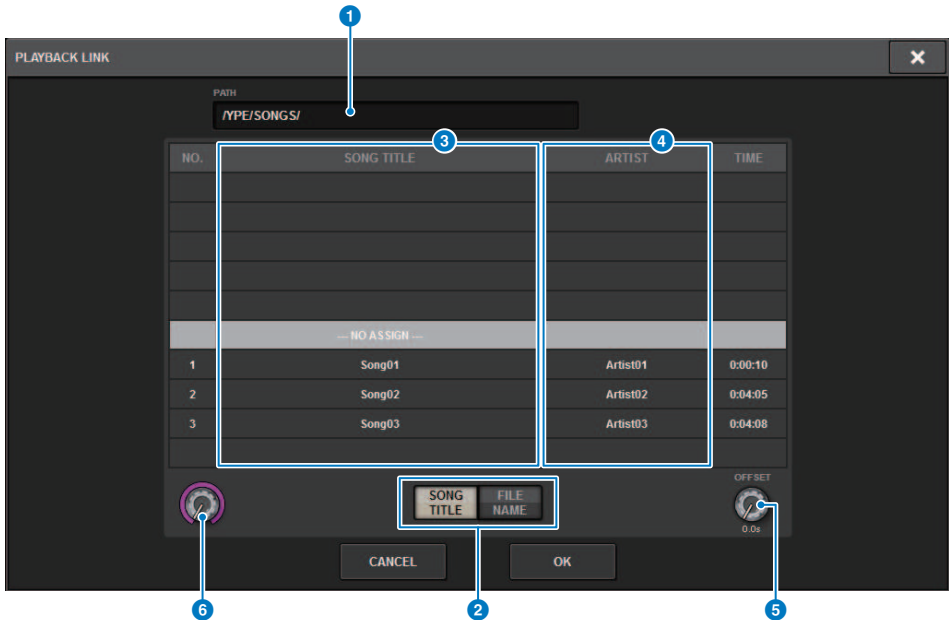

This screen contains the following items.

- 1 PATH indicator**
This area indicates the current directory path.
- 2 SONG TITLE/FILE NAME switch buttons**
Switch between the song title list and the file name list.
- 3 SONG TITLE/FILE NAME list**
Displays the song title and file name of the audio files in the \YPE\SONGS\ folder. You can select an audio file by pressing the name in the list.
- 4 ARTIST list**
Displays the artist name of the audio files in the \YPE\SONG\ folder. You can select an audio file by pressing the name in the list.
- 5 OFFSET knob**
You can use the screen encoder to set the time interval from scene recall until the start of audio file playback.
- 6 Scroll knob**
You can scroll the list using the screen encoder.

Using the Global Paste function

“Global Paste” is a function that enables you to copy-and-paste the settings of a desired channel or parameter from the current mix data to scene data in memory (multiple selections are allowed). This is a convenient way in which changes to the current scene can be applied to multiple scenes that have already been stored.

1 Press the SCENE field on the menu bar.

The SCENE LIST screen will appear.

2 Press the GLOBAL PASTE button on the right side of the SCENE LIST screen.

The “GLOBAL PASTE screen” appears.

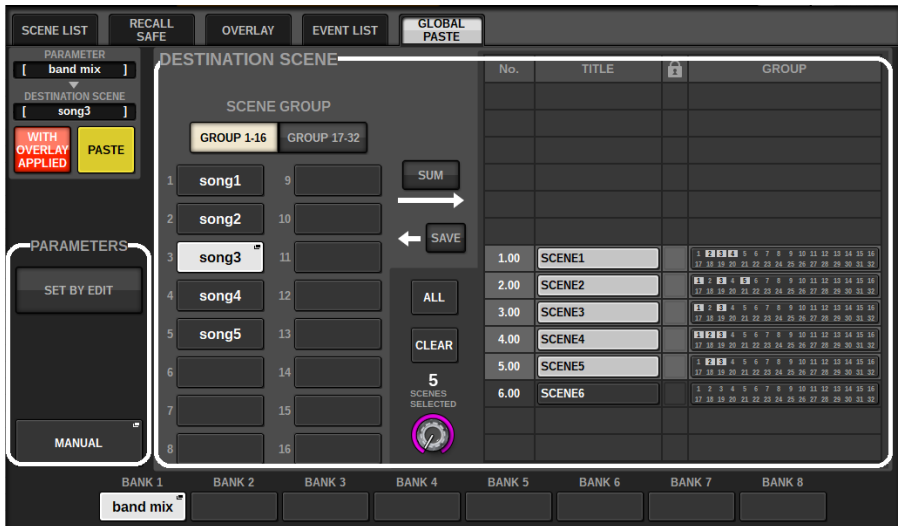

3 Select the Scene group to paste in the DESTINATION SCENE field.

Scene groups can be saved by selecting a scene.

4 Select the desired channel or parameter for the copy source in the PARAMETERS field.

Press the MANUAL button to access the GLOBAL PASTE PARAMETERS screen. In this screen you can select the copy source channels/parameters. When you finish making settings, press the CLOSE button. The system will return to the GLOBAL PASTE screen.

5 If necessary, press the WITH OVERLAY APPLIED button.

A dialog box will appear.

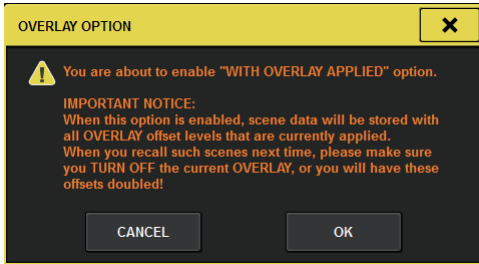

CAUTION

- While Overlay is enabled, if you recall a scene that was stored or globally-pasted with added offset values, both the current offset values and the original offset values will be applied to the scene, thus, doubling the offset value.

6 Press the PASTE button.

The selected item(s) in the current scene will be pasted to the specified scene(s) in memory. A progress bar will appear during the paste operation. Also, during the paste operation, a STOP button will appear, which you can press to cancel the paste operation. In this case, data will be pasted up until you press the STOP button. The operation cannot be reverted.

NOTE

- In any of the following cases, a dialog box will appear and data will not be pasted:
 - You attempted to paste data to a protected scene.

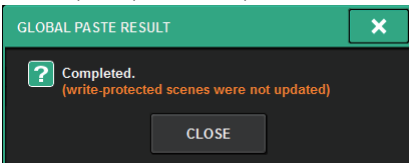

- The paste destination scene has been deleted by another operation (from PM Editor, etc.) just before the paste operation was executed.

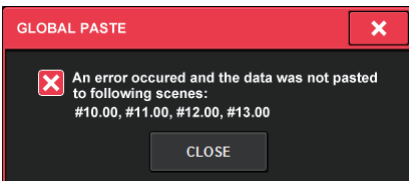

- If pasting data to one of the paired channels causes the pairing setting to be canceled, the other channel from that pair will be set to MONO.

GLOBAL PASTE screen

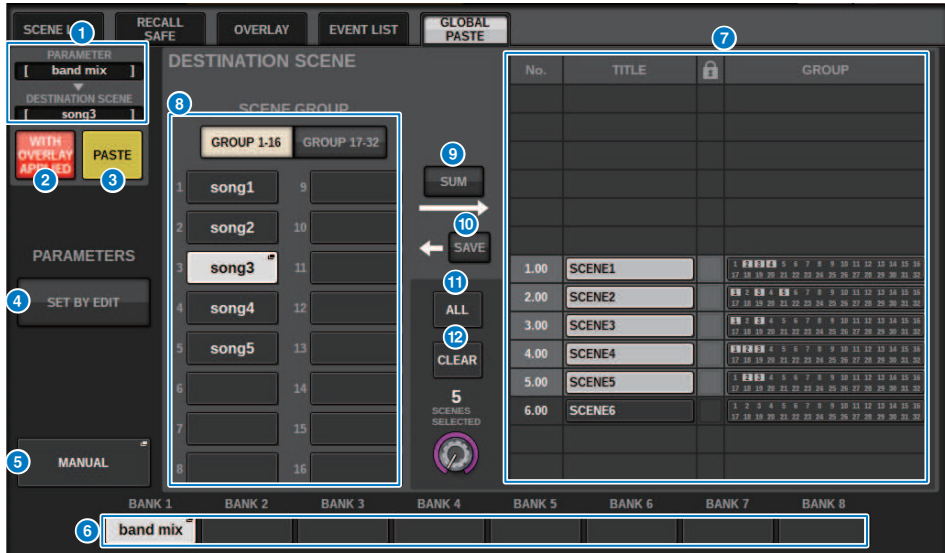

This screen contains the following items.

STATUS field

1 STATUS
Displays the parameters to be copied from and the scene to be pasted into.

2 WITH OVERLAY APPLIED button
If this button is turned on, the currently applied Overlay offset values will be added to the data to be pasted.

3 PASTE button
Press this button to paste the selected item(s) to the scenes in memory.

PARAMETERS field

4 SET BY EDIT button
When this is turned on, you can select channels and parameters by operating the panel or touchscreen. The SET BY EDIT status will be shown in the INFORMATION of the menu bar.

- State that can be pasted: **SET BY EDIT [PASTE READY]**
- State that cannot be pasted because no parameters or scenes are selected: **SET BY EDIT**

In addition, the CLEAR button will appear, and the selected parameter can be released with the same button. It can also be selected with the USER DEFINED key or GPI.

Scene memory > GLOBAL PASTE screen

5 MANUAL button

Press to display the GLOBAL PASTE PARAMETERS screen. In this screen, select the channel or parameter for the copy source.

6 BANK button

Press to recall the global paste settings saved in the BANK button. Press the selected BANK button again to display the NAME EDIT popup screen.

DESTINATION SCENE field

7 SCENE LIST

Select the scene to paste to (DESTINATION SCENE). The selected scene will be highlighted.

If you press the scene group list in the group column, only the groups to which each scene belongs will be displayed.

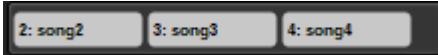

8 SCENE GROUP button

Press to expand the saved settings to DESTINATION SCENE in the SCENE LIST. Press the selected SCENE GROUP button again to display the NAME EDIT popup screen.

9 SUM button

When this is turned on, it goes into SUM mode. In SUM mode, you can expand multiple SCENE GROUP settings.

10 SAVE button

When this is turned on, it goes into SAVE mode. In SAVE mode, you can save the contents of the SCENE LIST to the selected SCENE GROUP.

11 ALL button

Select all scenes in the SCENE LIST.

12 CLEAR button

Clears the highlighted selection in the scene list.

GLOBAL PASTE PARAMETERS screen

This section explains how to select the parameters for global pasting.

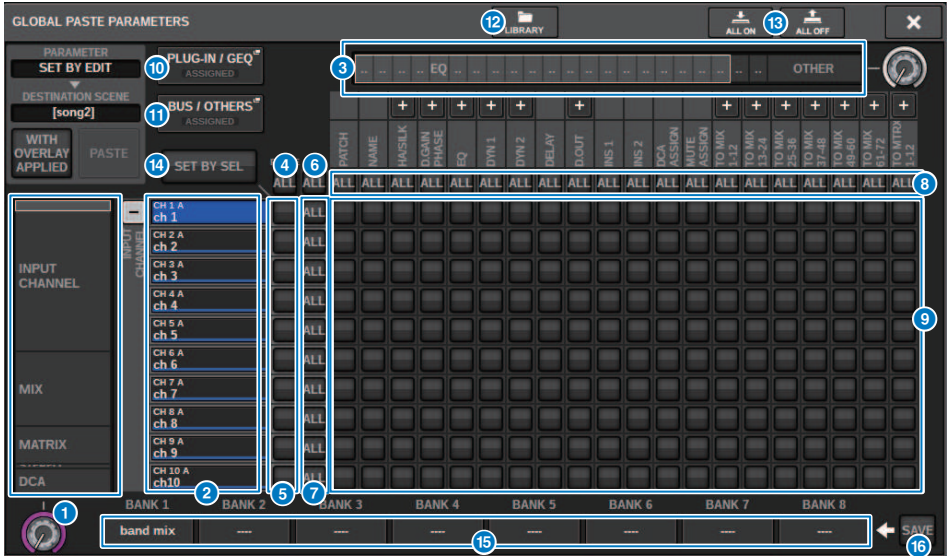

This screen contains the following items.

- 1 **Category select list (channel)**
Enables you to select a channel category.
- 2 **Channel display**
Indicates the channel name. You can press the + or – button located next to the channel name to expand or collapse the channel indication for each category.
- 3 **Category select list**
Enables you to select the category of parameters to be displayed on screen. You can press the + or – button located below to expand or collapse the channel parameter indication for each category.

NOTE

During SET BY EDIT, this screen scrolls and the channel and parameter display expands according to the manipulated parameters.

- 4 **ALL channel global paste ON button**
Specifies whether the Global Paste function is applied to all channels.
- 5 **Channel global paste ON buttons**
Turn Global Paste on or off for each channel.
- 6 **ALL ON button**
Turns Global Paste on or off for all parameters on all channels.

7 ALL parameter ON buttons

Turn Global Paste on or off for all parameters on the selected channel(s).

8 ALL channel ON buttons

Turn Global Paste on or off for all channels related to the selected parameter.

9 Parameter ON buttons

Turn Global Paste on or off for each parameter on each channel.

10 PLUG-IN/GEQ popup button

Press this button to access the popup window, in which you can set up global paste for each plug-in or GEQ.

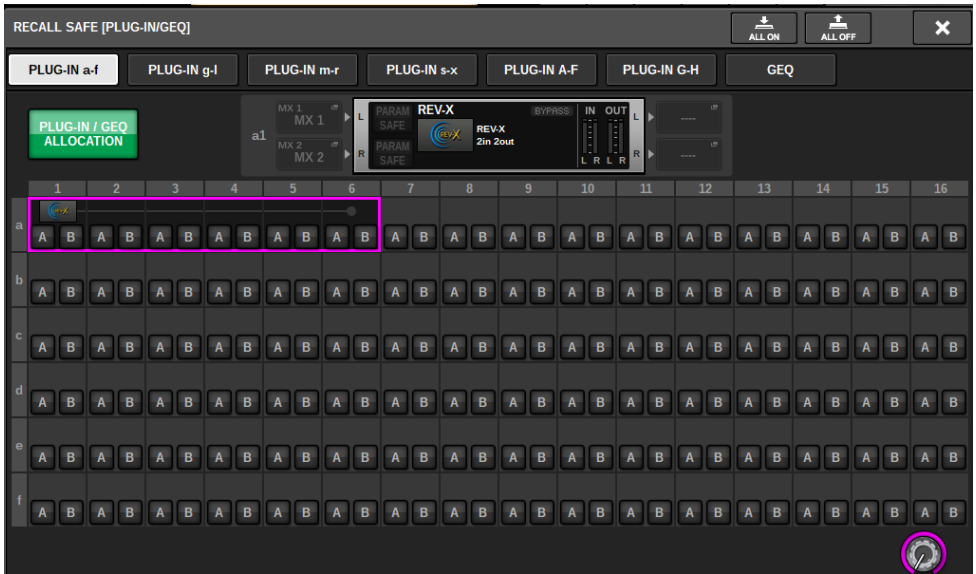

NOTE

If Global Paste is set to on, the parameters of the RACK with different GEQs / PEQs or effects plug-ins are not pasted when the PLUG-IN/GEQ ALLOCATION is not selected for Global Paste. To paste with the mount status, turn on Global Paste for the PLUG-IN/GEQ ALLOCATION.

11 BUS/OTHERS popup button

Press this button to access a popup window where you can specify how the Global Paste function affects the MIX bus type, surround settings, channel link, and fader layer position.

Scene memory > GLOBAL PASTE PARAMETERS screen

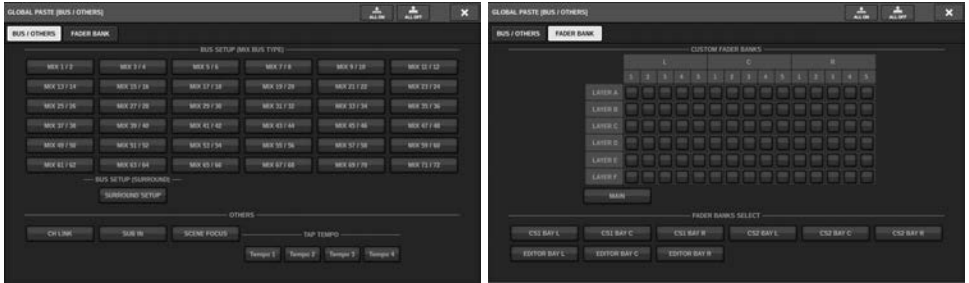

12 LIBRARY button

Press to display the library screen where the global paste parameter settings are stored. It is a parameter setting library and a common library for the focus function.

13 ALL ON button/ALL OFF button

Turns on/off all settings.

14 SET BY SEL button

When this is turned on, you can manipulate the panel and touch screen to set channels and parameters for global paste.

15 BANK button





Press to recall the global paste settings saved in the BANK button. Press the selected BANK button again to display the NAME EDIT popup screen.

16 SAVE button

When this is turned on, a yellow frame will appear. In that state, press the BANK button to save the selected global paste settings.

Button indications

The button indications will change according to the parameter status.

	ON
	OFF
	Partially ON
	Channel off

About the Recall Safe function

Recall Safe is a function that protects the parameters of the current mix from being affected by a scene memory that is recalled. Recall Safe settings are saved independently from the scene data.

Example: In a show that consists of numerous existing scenes, if a special mic (for a presenter or safety announcement) is added after the scenes were created, settings with this mic unused would be recalled each time a scene was recalled. In this case, that mic channel alone can be given the Recall Safe setting ALL so that it will be excluded from scene recall; that channel alone can be operated manually regardless of recalls. In the same way, if a rehearsal mic channel is to be turned off during the actual performance, that channel can be set to Recall Safe.

How Focus and Recall Safe are related

The Focus function and the Recall Safe function both apply filtering to the data that is recalled. However, they have an inverse relationship in that the Focus function determines “what portion of the scene data is recalled,” while the Recall Safe function determines “what parameters of the current mix data are not affected by the recall.”

Focus settings are saved in the data of each scene, and are used only when that specific scene is recalled. Recall Safe settings are common to all scenes.

Recall Safe and Focus can be used together; channels/parameters that either of the two functions excludes from recall (made safe / not in the focus) will not be recalled. In other words, only channels/parameters that are in Focus and are not in Recall Safe will be recalled.

When scene data is recalled, it is not usually the case that you want to recall all of the data every time; in most cases, you want to selectively recall only the needed data from the scene data.

By using either or both of these functions appropriately for your specific situation, you can flexibly meet a variety of mixing requirements.

Using the Recall Safe function

“Recall Safe” is a function that excludes only specific parameters/channels (DCAs) from Recall operations. Unlike the “Using the Focus function” (p.800) which lets you make settings for individual scenes, the Recall Safe settings are globally applied to all scenes.

- 1 Press the SCENE field on the menu bar to access the SCENE LIST screen.**
- 2 Press the RECALL SAFE tab.**

The RECALL SAFE screen appears.
- 3 To select a target channel to be set, press the + button on the channel display ② to expand the channel display, and then scroll through the category select list (channel) ①.**
- 4 If you want to apply the Recall Safe function only to specific parameters, use the parameter buttons ⑨ to select those parameters (multiple selections are allowed). If you want to apply the Recall Safe function to all parameters, turn on the ALL ON button ⑥.**
- 5 Turn on the channel Recall Safe ON button ⑤ for the channels to which you want to apply the Recall Safe function. If you want to apply the Recall Safe function to all channels, turn on the ALL channel Recall Safe ON button ④.**

NOTE

You can use the Recall Safe function in conjunction with the Focus function. Channels or parameters that are excluded from recall operations by either Focus or Recall Safe will not be recalled.

RECALL SAFE window

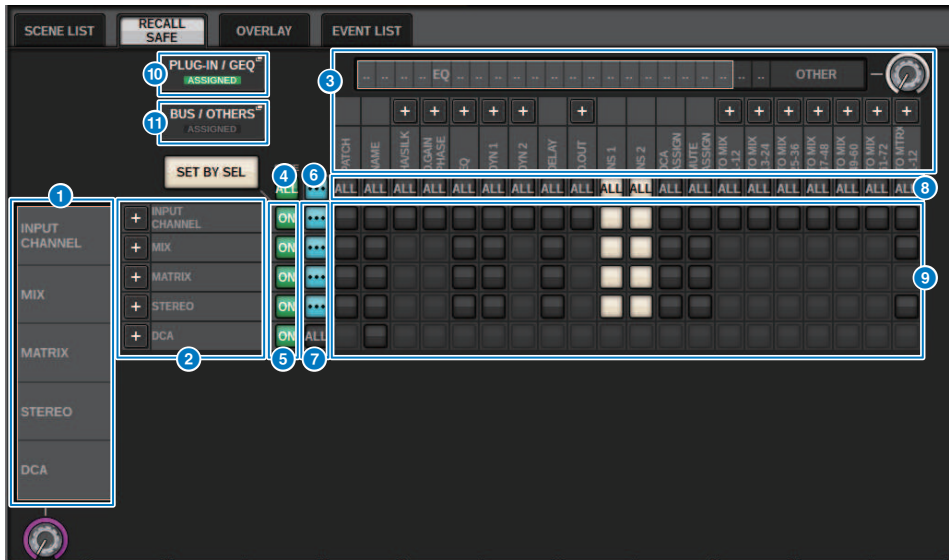

This window contains the following items.

- 1 Category select list (channel)**
allows you to select a channel category.
- 2 Channel display**
Displays the channel name. You can press the + or – button located next to the channel name to expand or collapse the channel display for each category.
- 3 Category select list**
allows you to select the category of parameters to be displayed on screen. You can press the + or – button located beneath the list to expand or collapse the channel parameter indication for each category.
- 4 ALL channel Recall Safe ON button**
Specifies whether the Recall Safe function is applied to all channels.
- 5 Channel Recall Safe ON buttons**
Turn Recall Safe on or off for each channel.
- 6 ALL ON button**
Turns Recall Safe on for all parameters on all channels.
- 7 ALL parameter ON buttons**
Turn Recall Safe on for all parameters that belong to the corresponding channels.
- 8 ALL channel ON buttons**
Turn Recall Safe on or off for all channels related to the selected parameter.

Scene memory > RECALL SAFE window

9 Parameter ON buttons

Turn Recall Safe on or off for parameters on each channel.

10 PLUG-IN/GEQ popup button

Press this button to open the popup window, where you can set up recall safe for each plug-in or GEQ.

NOTICE

- Even if Recall Safe is set to on, only individual parameters are the target. The mount status and insert patches are not subject to Recall Safe.



11 BUS/OTHERS popup button

Press this button to access a popup window where you can specify how the Global Paste function affects the MIX bus type, surround settings, tap tempo, custom fader bank, and fader layer position.

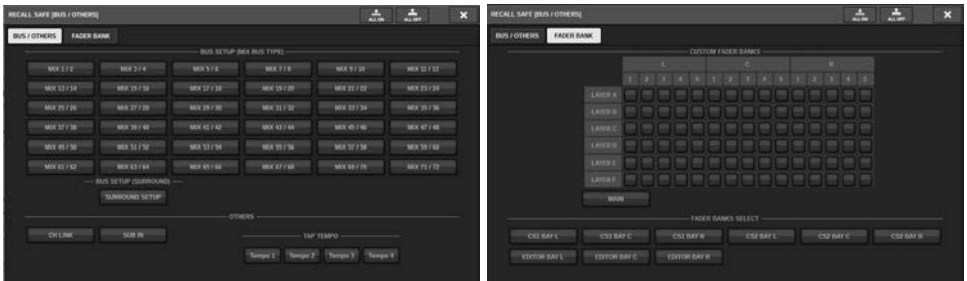





12 SET BY SEL button

If this button is on, you can add a channel by using the corresponding [SEL] key.

Button display

The button display changes depending on the parameter status.

	ON
	OFF
	Partially ON
	Channel off

Creating an event list

The Event List function lets you arrange scenes and library items in the order in which you will use them, so that they can be recalled automatically according to the time code or interval that you specify, or recalled manually.

NOTE

The event list can be controlled only from the control surface whose CONSOLE ID=1.

■ Creating an event list

1 Press the SCENE field on the menu bar.

2 Press the EVENT LIST tab.

The view switches to the EVENT LIST screen.

3 Press a button in the INSERT field (MANUAL, INTERVAL, TIMECODE) to add an event.

When you press the TRIGGER item for the selected event, the EVENT TRIGGER SETTING popup window appears, allowing you to edit the trigger settings.

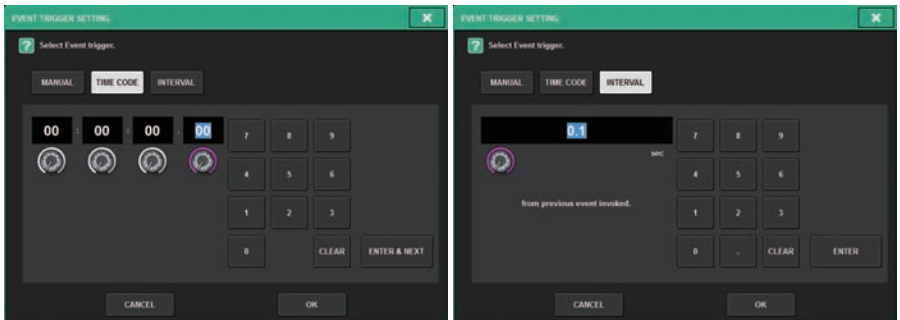

Edit the settings as needed.

4 Press the EVENT item of the selected event.

The “EVENT LIST EDIT popup window” (p.833) appears.

5 Select from the list to add the event content that you need.

Repeat these steps to add the necessary events and create an event list.

EVENT LIST window

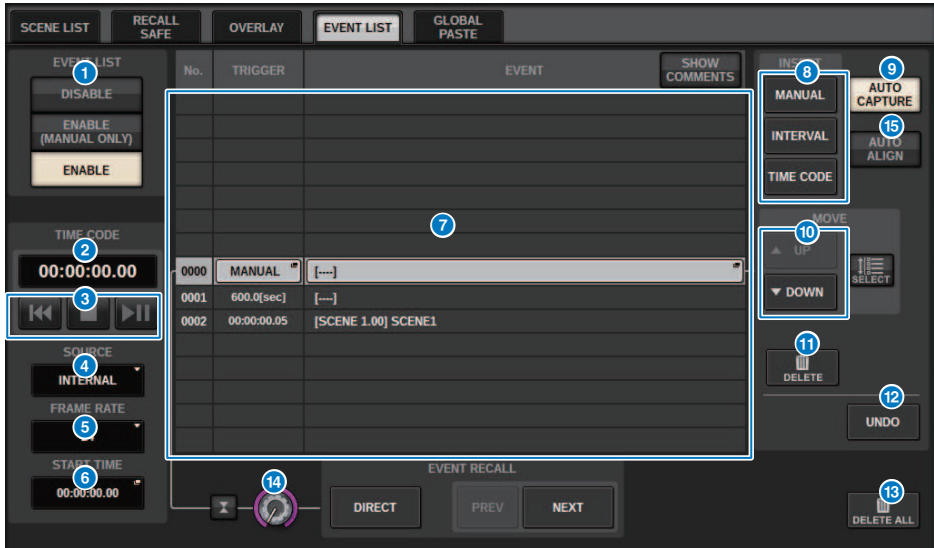

This window contains the following items.

1 EVENT LIST button

Enables or disables an event list. If an event list is enabled, the SCENE field on the menu bar will display the number and title of the next event to be recalled.

- **DISABLE button**
Disables the event list.
- **ENABLE (MANUAL ONLY) button**
Recall all events registered in the event list by manual operation.
- **ENABLE button**
Enables the event list.

2 Time code

Displays the current time code. If SOURCE is set to INTERNAL, you can press this to open the EVENT TRIGGER SETTING popup window, where you can edit the current time code. If time code is enabled, it is shown in the SCENE field of the menu bar.

3 Time code controllers

- **Rewind button**.....Rewinds the time code to the start time.
- **Stop button**.....Stops the time code.
- **Play/pause button**.....Starts (resumes) or pauses the time code.

4 Time code source

Selects the source of the time code that will be used.

- **OFF**.....The time code is not received.
- **INTERNAL**.....The time code internally generated by the control surface is used.
- **TIMECODE IN**.....The time code that is input from the TC IN connector of the DSP engine is used.
- **MTC CONSOLE**.....The MIDI time code that is input from the MIDI connector of the control surface is used.
- **MTC ENGINE**.....The MIDI time code that is input from the MIDI connector of the DSP engine is used.

5 Frame rate

Selects one of the following as the frame rate of the time code that is used.

- **30**.....30 frames/second (non-drop)
- **30D**.....30 frames/second (drop frame)
- **29.97**.....29.97 frames/second (non-drop)
- **29.97D**.....29.97 frames/second (drop frame)
- **25**.....25 frames/second
- **24**.....24 frames/second

6 Offset time / Start time

If INTERNAL is selected as the time code, this specifies the start time of the internal time code. If any other time code source is selected, this specifies the offset value. The offset value is the interval by which time code received from an external source is adjusted forward or backward when recalling a scene.

7 List

This area displays the events added to the event list. The list shows the following items.

- **No.**This column displays event numbers.
- **TRIGGER**.....This column displays the type of trigger that executes an event.
- **EVENT**.....This column displays a description of the event to be executed.

You can use the SHOW COMMENTS button to specify whether you want to show comments for a scene.

8 INSERT field

Adds a new event to the event list.

- **MANUAL** button.....The event is recalled by using the DIRECT button or an assigned USER DEFINED key.
- **INTERVAL** button.....The event is recalled when the specified length of time elapses after the previous event was recalled.
- **TIMECODE** button.....The event is recalled when the time code reaches the specified time.

9 AUTO CAPTURE button

This allows an event to be registered in real time based on the time code. When you turn this button on, the time code starts, and when a scene or library item is recalled using the SCENE MEMORY section, the corresponding scene number and time code location are captured and added as a new event.

10 MOVE field

- **UP button**
Moves the currently-selected event up step-by-step in the event list.
- **DOWN button**
Moves the currently-selected event down step-by-step in the event list.

Scene memory > EVENT LIST window

11 **DELETE button**

Deletes the currently-selected event.

12 **UNDO button**

Cancels the immediately preceding edit of the event list.

13 **DELETE ALL button**

Deletes all events in the list.

14 **EVENT SELECT knob**

Use the screen encoder or the [TOUCH AND TURN] knob to select an event.

Automatic alignment of events

When the AUTO ALIGN button is turned on, the events registered with the TIME CODE button (TIME CODE events) are automatically sorted.

When turned off, the TIME CODE event can be swapped freely. The TIME CODE events can be sorted by performance, greatly increasing the operational flexibility.

■ Difference in behavior when AUTO ALIGN is turned on / off

	AUTO ALIGN = ON	AUTO ALIGN = OFF
UP/DOWN button	You can switch events other than the TIME CODE event. ※ MANUAL and INTERVAL events can be replaced with TIMECODE events.	All events can be replaced.
Creating a new TIME CODE event	According to the time code, the event is inserted just before the next TIME CODE event. *1	The event will be inserted at the selected position on the list with the specified time code. *1
Change TIME CODE event MANUAL/INTERVAL → TIME CODE TIME CODE → TIME CODE (Time change)	The event moves according to the set time. *1	The event position does not change.*1
Change current timecode	If a TIME CODE event at the changed time exists, that event will be executed and you will be taken to that event. If the event at the changed time does not exist, it moves to the last TIME CODE event before that time. (Does not execute.)	If a TIME CODE event at the changed time exists, that event will be executed and you will be taken to that event.
Playback by timecode	When the time code being played reaches the time set in the TIME CODE event, that TIME CODE event is executed.	

*1 If an event with the same time exists, that previous event will be overwritten.

EVENT LIST EDIT popup window

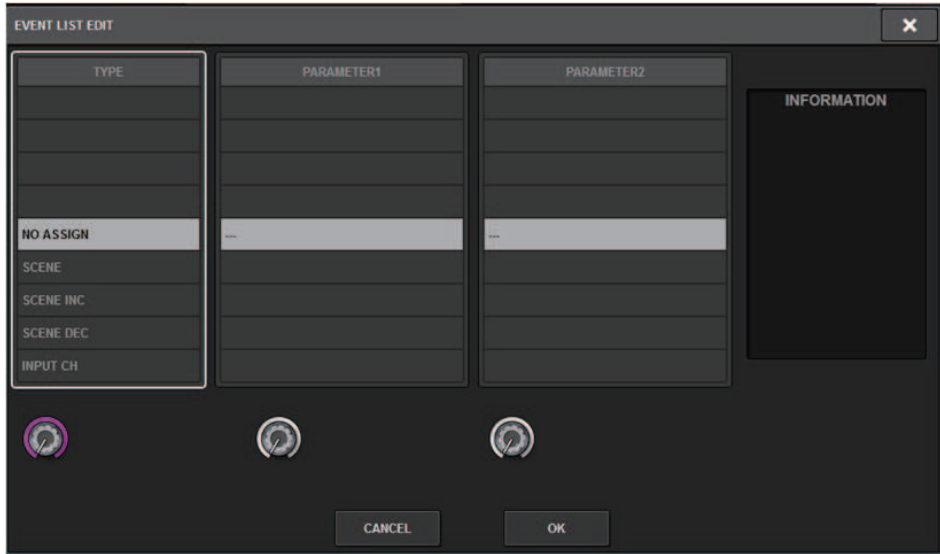

This window contains the following items.

TYPE	PARAMETER1	PARAMETER2	INFORMATION
NO ASSIGN	-	-	-
SCENE	Scene number and title	-	Comment
SCENE INC	-	-	-
SCENE DEC	-	-	-
INPUT CH	Library number and title	Input	MONO /STEREO
OUTPUT CH	Library number and title	Mix, Matrix, Stereo	MONO/STEREO, MIX/MATRIX/STEREO
INPUT EQ	Library number and title	Input	EQ Type
OUTPUT EQ	Library number and title	Mix, Matrix, Stereo, Monitor, Cue, GEQ	EQ Type, OUT CH/ MON CUE
DYNAMICS	Library number and title	Input, Mix, Matrix, Stereo	Dynamics Type
GEQ	Library number and title	GEQ	31GEQ / FLEX15
USER SETUP	Library number and title	-	-
<Plug-In> *	Library number and title	Plug-in rack that is mounted	-

* Each plug-in

Using MANUAL to recall scenes from an event list

In the case of MANUAL, you'll use the EVENT RECALL buttons to recall events. In the case of INTERNAL or TIME CODE, select a time code source to recall events.

1 Press the SCENE field on the menu bar.

2 Press the EVENT LIST tab.

The view switches to the “EVENT LIST screen” (p.835).

3 Rotate the screen encoder to select the event that you want to recall.

4 Press the EVENT RECALL button.

- While Overlay is enabled, if you recall a scene that was stored or globally-pasted with added offset values, both the current offset values and the original offset values will be applied to the scene, thus, doubling the offset value. In this case, extremely high volume sound may be output. Confirm the status of a scene to recall, and the on/off status of Overlay, before recalling the scene.

EVENT LIST screen

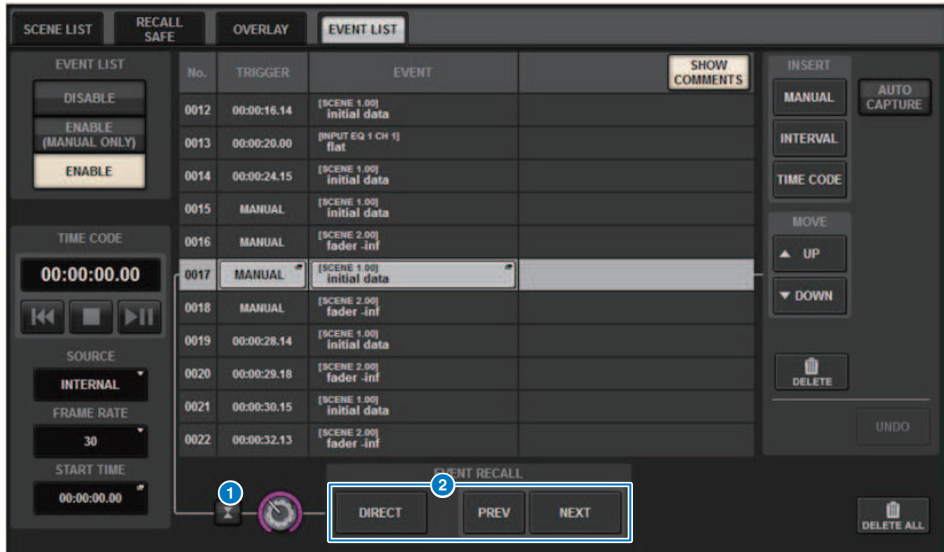

This screen contains the following items.

1 Automatic follow button

If you press this button, the selected event (shown as dark gray in the list) follows the event that is currently being executed (shown as light gray in the list).

2 EVENT RECALL buttons

- **NEXT button**

Directly recalls the event that immediately follows the most-recently executed event.

- **PREV button**

Directly recalls the event that immediately precedes the most-recently executed event.

- **DIRECT button**

Immediately recalls the currently-selected event.

NOTE

You can use the Direct Recall function to directly recall an event assigned to a USER DEFINED key, or to step through the events.

About the Isolate function

This function protects an entire channel module from any type of memory recall; not only scene memory but also libraries such as EQ or Dynamics. The Isolate function protects parameters of the isolated channel from scene recall and library recall.

NOTE

- If you load the setting file, the parameters of the isolated channel will not be protected by the Isolate function.
- The parameters of the isolated channel will not be protected from GEQ or plug-in library recall.

Example: Suppose that during the actual performance, you need to disconnect a certain input channel from the mixing. In this case, you could disconnect that channel by turning on all of its Recall Safe settings, but that channel is being used with partial Recall Safe for a different purpose. In this case, the desired operation will not be obtained unless you manually change the Recall Safe filter settings. However by using the Isolate function, you can instantly disconnect that channel regardless of Recall Safe. DCA operations will also be ignored.

The Isolate on/off parameter is provided on each channel.

Using Preview mode

Preview mode allows you to check and edit the scene settings that are stored in memory without affecting the signal processing of the current scene. When you recall a scene in this mode, the settings of the newly recalled scene are shown on the panel of the RIVAGE PM series unit, but the signal processing of the current scene continues as it had been prior to recall. Even if you edit the settings and store/overwrite them, the signal processing of the current scene continues as it had been prior to recall. This is convenient when you want to check the contents of the scene that you expect to recall next, or when you want to partially edit the settings and then store them.

Using Preview mode (Using the keys in the SCENE MEMORY section)

1 Press the [PREVIEW] key.

When you enter Preview mode, the SCENE MEMORY display of the SCENE MEMORY section indicates [PREVIEW], and the [PREVIEW] key is lit. The SCENE field in the menu bar flashes red, and the PREVIEW button in the SCENE LIST screen is lit red.



2 Use the SCENE MEMORY [INC]/[DEC] keys to select the scene number that you want to recall.

3 Press the SCENE MEMORY [RECALL] key.

4 As necessary, use the controllers of the panel to edit the settings.

5 If you want to store the settings that you made in step 4, press the SCENE MEMORY [STORE] key. If you want to overwrite and update the edited content onto the scene that is recalled or stored, press the SCENE MEMORY [UPDATE] key.

6 When you have finished checking or editing the settings of the scene, press the [PREVIEW] key.

NOTE

- PREVIEW mode applies to all the parameters that are included in the scene memory.
- Settings not included in a scene memory (such as Port to port PATCH settings) are reflected by the current scene even during in Preview mode.
- Even in PREVIEW mode, the Recall Safe function, Focus function, and Isolate function are operative.

Using Preview mode (Using the SCENE LIST screen)

- 1** Press the **SCENE** field on the menu bar.
- 2** Press the **SCENE LIST** tab to access the **SCENE LIST** screen.
- 3** Press the **PREVIEW** button of the **SCENE LIST** screen to enter **Preview mode**.
- 4** Use the screen encoder to operate the **SCENE SELECT** knob of the **SCENE LIST** screen, and select the scene number that you want to recall.
- 5** Press the **RECALL** button in the **SCENE LIST** screen.
- 6** As necessary, use the controllers of the panel to edit the settings.
- 7** If you want to store the settings that you made in step 6, press the **STORE** button of the **SCENE LIST** screen. If you want to overwrite and update the edited content onto the scene that is recalled or stored, press the **UPDATE** button in the **SCENE LIST** screen.
- 8** When you have finished checking or editing the settings of the scene, press the **PREVIEW** button in the **SCENE LIST** screen.

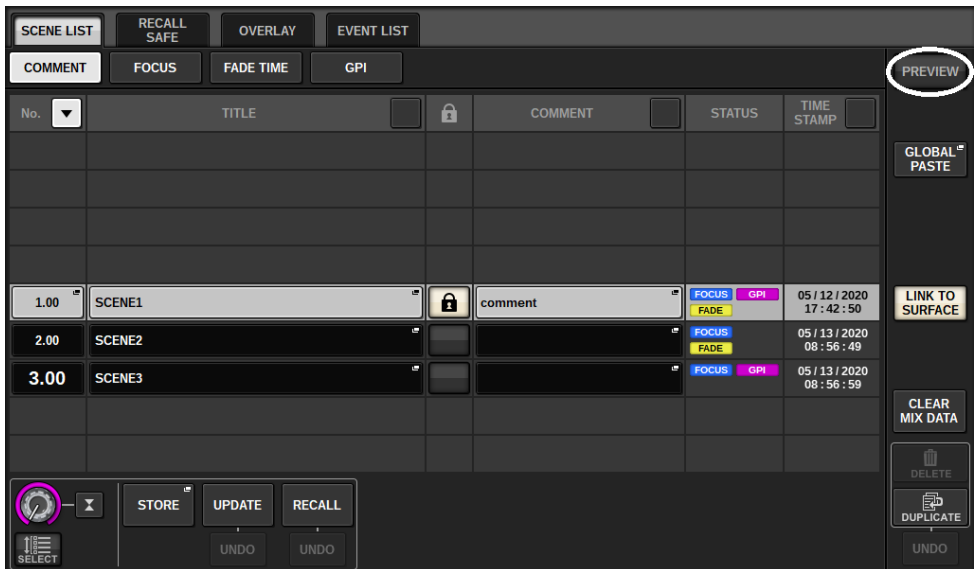

About the functions in Preview mode

The current scene will change in response to operations in the following software or external devices.

- RIVAGE PM Editor
- StageMix
- MIDI Rx
- GPI IN

In the same way, communication is sent to the following software or external devices when you change the current scene.

- RIVAGE PM Editor
- StageMix
- MIDI Tx
- GPI OUT

The meters display the state of signal processing for the current scene.

The following functions do not operate in Preview mode.

- Synchronization of settings (except when synchronization occurs automatically)
- File save/load functions
- Cue changes
- USER DEFINED keys
- USER DEFINED knobs
- USER DEFINED keys and USER DEFINED knobs in CONTROLS
- Change and display of monitor, cue, oscillator, talkback, PHONES, or RTA
- Change and display of the USB recorder
- Changes to DANTE SETUP or DANTE PATCH
- Fade function
- Plug-in MIDI CLOCK or tap tempo function
- Maintenance
- Cue changes for an insert or plug-in
- Cue or key-in changes for DynamicEQ, DynamicEQ4, or MBC4 plug-ins
- CSV import/export
- [HOME] key
- BOOKMARK operation (via GPI)
- VSC on/off switching
- Overlay function (the OVERLAY SETTING window and operations of the [OVERLAY] key)
- MACRO KEYS operation
- EXECUTE ACTION / EXECUTE REVERSE ACTION in the MACRO LIST window
- EXECUTE in the MACRO EDIT window

Additionally, it is not possible to enter Preview mode during the following operations.

- While pasting a scene or EQ

Scene memory > About the functions in Preview mode

- While executing Global Paste
- While synchronizing settings data
- While saving/loading a file
- While executing CSV import/export
- While updating the firmware
- While initializing channel parameters

Other restrictions

- Undo is not possible for a recall operation that was executed while in Preview mode (however, this does not apply to a recall that was performed from outside).

OVERLAY

About the Overlay function

Overlay is a function that enables you to add or “overlay” a temporary offset (+/-) value to fader levels or Mix/Matrix send levels in a current mix. The “overlayed” value is something like a transparent filter applied to the level values. It enables you to temporarily adjust the relative levels without modifying existing scene data.

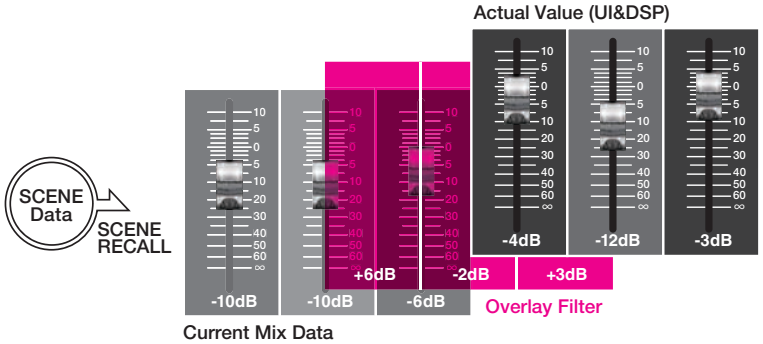

For example, assume that a regular musician for a show has been replaced by a new musician just before a take, and that the audio level on the channel for the new musician is lower than the original musician by 6dB. One way to correct this situation is to raise the head amp gain by 6dB. However, you should avoid this action. If you leave the gain raised after the take, there might be a risk of overloading the head amp when the original musician returns to the show. Another way is to simply raise the channel fader level. But, if the scene is recalled later, the fader will return to the original level. You might then think of enabling Recall Safe to this particular channel to avoid the level change caused by a scene recall. However, if you use Recall Safe, you will be unable to utilize the detailed fader level settings that have been painstakingly programmed for every scene.

This is where the Overlay function becomes very handy. Set an offset value of +6dB for the channel in question. In this way, +6dB will be temporarily added to the existing current mix, and applied to the DSP process. This Overlay filter (a set of offset values) is inserted between the current mix and the DSP process. Therefore, as long as Overlay is enabled, a relative value of +6dB (in this example) will always be added — even after the current mix is changed (e.g., by scene recall, etc.).

To troubleshoot these types of level issues, the RIVAGE PM series now features the Overlay function, in addition to the conventional Global Paste function. The Global Paste function enables you to paste and write a new value onto scene data, which is useful as a “permanent” editing function during programming. However, this function is not appropriate when you want to resolve an issue temporarily but you still want to return to the original value later. On the other hand, the Overlay function does not affect scene data directly. Once you disable the function, the value will revert to its original setting. Therefore, this function is useful in resolving real-time, temporary issues.

Selected Channel section (OVERLAY)

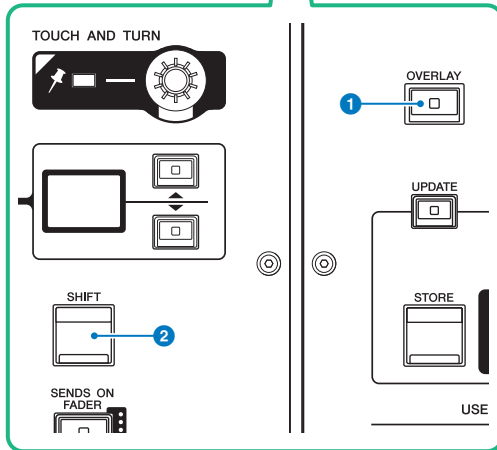
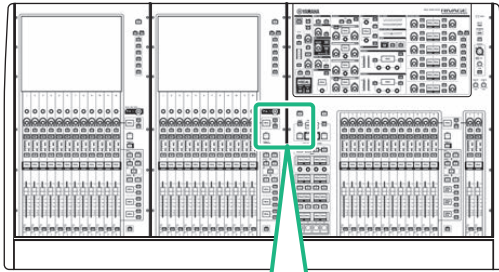

This screen contains the following items.

1 [OVERLAY] key

Press this button to display the OVERLAY SETTING screen. While pressing and holding down the [SHIFT] key, press the [OVERLAY] key to switch Overlay on or off. While Overlay is turned on, press and hold down the [OVERLAY] key to enter Overlay edit mode.

2 [SHIFT] key

Combine with another key to perform certain functions.

OVERLAY > Selected Channel section (OVERLAY)

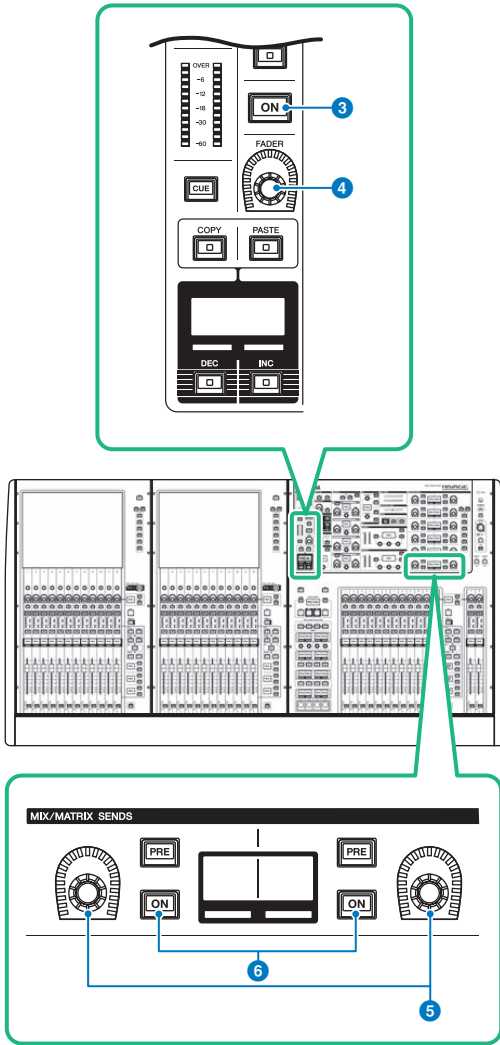

3 **[ON] key**

Switches the channel on or off.

4 **[FADER] knob**

Adjusts the channel fader level.

5 **MIX/MATRIX SENDS knobs**

Adjust the send levels for the corresponding buses.

6 MIX/MATRIX SENDS [ON] keys

Switch the send signal to the corresponding bus on or off.

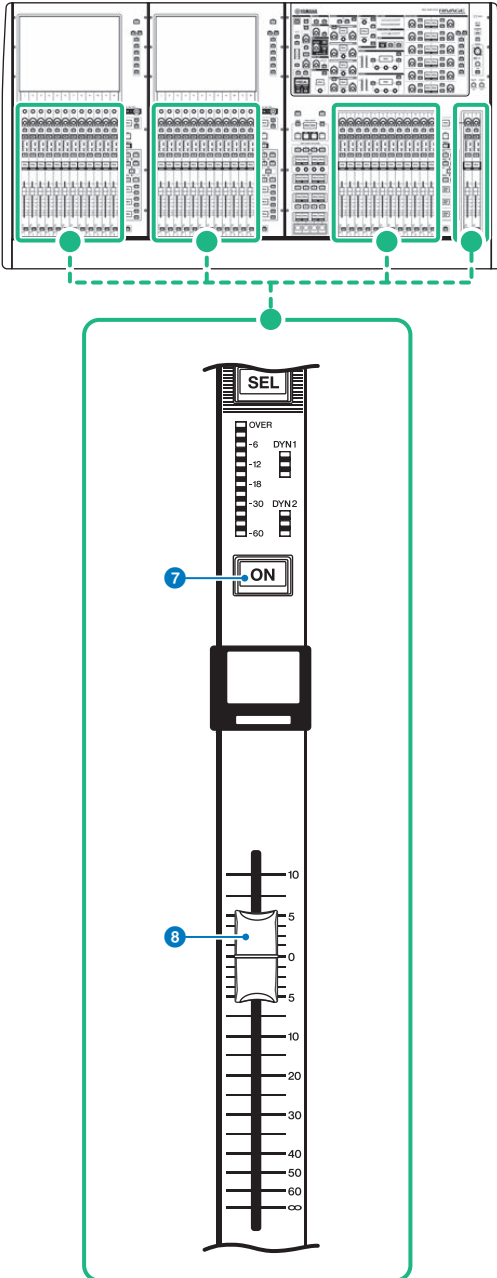

OVERLAY > Selected Channel section (OVERLAY)

7 **[ON] key**

Switches the channel on or off.

8 **Fader**

This is a touch-sensitive 100 mm motorized fader.

Controlling the Overlay function using the keys and knobs on the top panel

1 While pressing and holding down the [SHIFT] key, press the [OVERLAY] key to switch Overlay on.

The [OVERLAY] key LED will light.

2 Press and hold down the [OVERLAY] key to enter Overlay edit mode.

The indicators for editable channels and buses will flash.

NOTE

You will be unable to edit the Overlay settings if Isolate mode is enabled; if the bus type of the send destination is set to "FIXED" (only for the send level); or if the EXCLUDE button has been pressed.

3 Modify the offset values using the faders or knobs.

The following list shows the controllers and corresponding parameters.

• Fader level

Fader in the Channel Strip section

[FADER] knob in the Selected Channel section

• Mix/Matrix Send level

MIX/MATRIX SENDS knob in the Selected Channel section

NOTE

- You can change the levels within the range from -20dB to +10dB using the faders or knobs.
- You cannot change the value if the fader level is set to $-\infty$.

The setting value will appear in the channel name display or MIX/MATRIX SENDS display. The channel or bus [ON] keys will light up on the channels or buses for which the offset values are programmed. If you turn these [ON] keys off, the values will be reset to 0dB.

4 Press and hold down the [OVERLAY] key to exit Overlay edit mode.

5 After you finish, press and hold down the [SHIFT] key, and then press the [OVERLAY] key to switch Overlay off.

NOTE

- The fader levels and send levels (to which the offset values have been added) will be automatically modified so that the levels will fall within the range (-138.0dB to +10dB)
- For example, assuming that the fader level is -138dB and the offset value is -10dB, when Overlay is turned on, the limiter will kick in and the resultant fader level will change to -128dB. When Overlay is turned off, this value will not change.

Controlling the Overlay function from the touch screen

1 Press the [OVERLAY] key.

The “OVERLAY SETTING screen” (p.849) will appear.

2 Press the Overlay ON button to enable Overlay.

3 Select a channel or DCA and parameter to set the Overlay offset value.

A selected field will be surrounded by a frame.

4 Rotate the Overlay parameter setting knob to adjust the offset value.

The value will appear in the field. If the offset is a negative value, it will be indicated in light blue. If the offset is a positive value, it will be indicated in pink.

NOTE

- If the channel/parameter category indication is collapsed and if an offset value was set for the category, the parameter field for the corresponding channel will show “...”.
- The fader levels and send levels (to which the offset values have been added) will be automatically modified so that the levels will fall within the range (-138.0dB to +10dB)
- For example, assuming that the fader level is -138dB and the offset value is -10dB, when Overlay is turned on, the limiter will kick in and the resultant fader level will change to -128dB. When Overlay is turned off, this value will not change.

5 Turn the EXCLUDE buttons on as needed.

NOTE

The Overlay setting will be invalid if the EXCLUDE button has been pressed, if Isolate mode is enabled, or if the bus type of the send destination is set to “FIXED” (only for the send level).

6 After you finish, press the SCENE field on the menu bar to return to the previous screen.

“Example of panel and touch screen indication while Overlay is enabled” (p.851)

OVERLAY SETTING screen

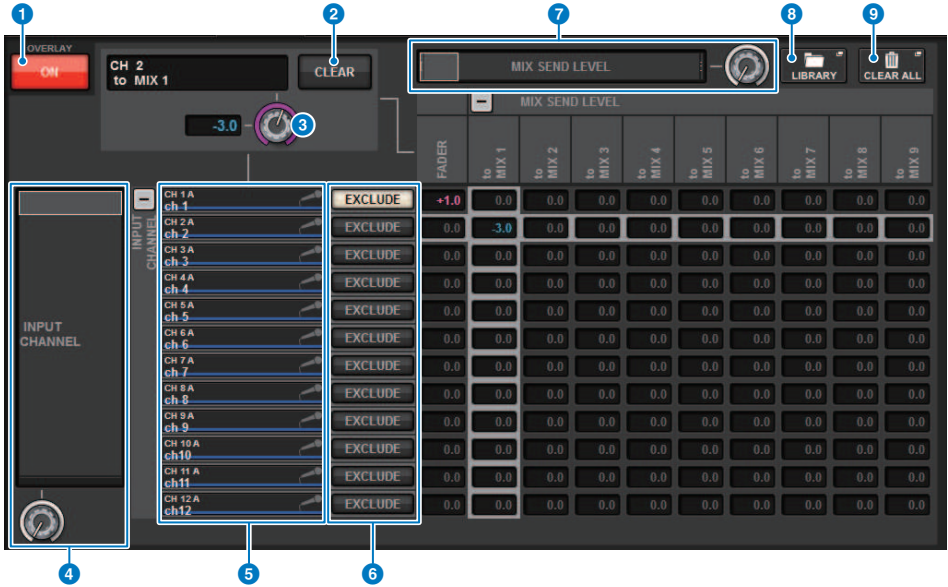

This screen contains the following items.

1 Overlay ON button

Turn this button on to enable the offset value.

2 CLEAR button

Press this button to clear the selected parameter setting.

3 Overlay parameter setting knob

While Overlay is turned on, you can set the value between -20.00dB and +10.00dB.

4 Category select list (channel)

Enables you to select a channel category. The categories correspond to the following channels.

- CH1-144 145-288 (only for DSP-RX-EX)
- MIX1-72
- MTX1-36
- STEREO.....ST A L, ST A R, ST B L, ST B R
- DCA GROUPS.....DCA1-24

You can press the + or - button located to the right to expand or collapse the channel parameter indication for each category.

5 Channel display

Indicates the channel name.

6 EXCLUDE button

If the EXCLUDE button is turned on, the corresponding channel will be excluded from the Overlay target.

7 Category select list (parameter)

Enables you to select the parameter category. The categories correspond to the following parameters.

- Fader
- Mix Send1 Level-Mix Send 72 Level
- Matrix Send1 Level-Matrix Send 36 Level

You can press the + or – button located beneath the list to expand or collapse the channel parameter indication for each category.

8 LIBRARY button

Press this button to open the OVERLAY library window.

9 CLEAR ALL button

Press this button to clear all specified parameters, other than the EXCLUDE parameter.

Example of panel and touch screen indication while Overlay is enabled

When Overlay is enabled, the panel and touch screen will update its indication (pink or light blue) using the Overlay setting.

Panel	SELECTED CHANNEL VIEW screen		OVERVIEW screen	
	<p>Fader strip field</p> 	<p>MIX/MATRIX SENDS field</p> 	<p>SEND field</p> 	<p>Channel name area</p> 

In addition to these examples, the parameters affected by the Overlay setting will update the level indication.

File

SAVE/LOAD

You can store and load all data of the RIVAGE PM series to and from a USB flash drive connected to the USB port on the control surface.

NOTE

- You cannot use the RECORDING connector (a USB port dedicated for recording) for save and load operations.
- The system will recognize only one USB flash drive that is connected to one of the USB ports. Do not connect multiple USB flash drives.
- The operation of USB 2.0 or 3.0 flash drives only is guaranteed.
- USB flash drives with capacities of up to 32GB can be used. (However, this does not necessarily guarantee the operation of all USB flash drives.) USB flash devices with capacities larger than 32GB cannot be used. The FAT16 and FAT32 formats are supported.

NOTICE

- “ACCESS” will appear on the status indicator while data is being accessed (i.e., saved, loaded, or deleted). During this time, do not remove the USB flash drive or power-off the control surface. Doing so may damage the data on the storage media.

Data handled by a settings file

Settings data of a system based on the RIVAGE PM series can be saved on a USB flash drive as a settings file. The settings file will have a file name extension of “.RIVAGEPM”. The settings file contains all data such as scenes, libraries, and system setup.

☒ indicates data stored in scene memory

SYSTEM SETUP

SYSTEM CONFIG	System settings (TWINLANe bandwidth settings, settings for the units that are part of the system)
★ BUS SETUP	Bus settings
MIDI/GPI	MIDI/GPI settings

ENVIRONMENTAL

CUSTOM FADER	Custom fader bank settings
USER DEFINED KEYS	USER DEFINED KEYS function assignments
USER DEFINED KNOBS	USER DEFINED KNOBS function assignments
PREFERENCES	Settings for the operating environment
BRIGHTNESS/ CONTRAST	Settings such as display brightness and contrast

PATCH

★ INPUT	Input port patching settings
★ OUTPUT	Output port patching settings
★ INSERT	Insert patching settings
★ DIRECT OUT	Patching settings for output ports that perform direct output
PORT TO PORT	Patching settings for Port to port
★ RECORDING	Patching settings for recording

MIXING DATA

★ HA	Head amp settings
★ INPUT CH	Input channel mixing data
★ MIX	MIX channel mixing data
★ STEREO	STEREO channel mixing data
★ MATRIX	MATRIX channel mixing data
★ GEQ/PEQ	GEQ/PEQ mount status and parameters
★ PLUG-IN	Plug-in mount status and parameters
★ NAME	Input channel/output channel names, colors, and icon settings

MONITOR/CUE/Other

MONITOR	Monitor settings
CUE	Cue settings
OSCILLATOR	Oscillator settings

File > Data handled by a settings file

TALKBACK	Talkback settings
RTA	Realtime analyzer settings
METERING POINT	Meter display point settings
PEAK HOLD	Peak hold on/off settings

SCENE

★ FOCUS	Focus settings
RECALL SAFE	Recall safe settings
★ PLAY BACK LINK	Playback link settings
★ FADE TIME	Fade function settings

OVERLAY

OVERLAY	Overlay settings
---------	------------------

ISOLATE

ISOLATE	Isolate settings
---------	------------------

SURROUND

★ SURROUND	Settings for surround mode
------------	----------------------------

Library

CHANNEL	Channel library settings
EQ	EQ library settings
DYNAMICS	Dynamics library settings
GEQ	GEQ library settings
PLUG-IN	Plug-in library settings
NAME	Name library settings
DCA NAME/ASSIGN	DCA Assign library settings
MUTE NAME/ASSIGN	Mute Group Assign library settings
USER SETUP	User Setup library settings
OVERLAY	Overlay library settings

Saving the RIVAGE PM series's settings on a USB flash drive

All internal data of the RIVAGE PM series can be saved to the USB flash drive in a single operation as a settings file. The stored file will have a file name extension of “.RIVAGEPM”.

1 Press the **SETUP** button on the menu bar to access the **SETUP** screen.



2 Press the **SAVE/LOAD** button to access the **SAVE/LOAD** popup window.

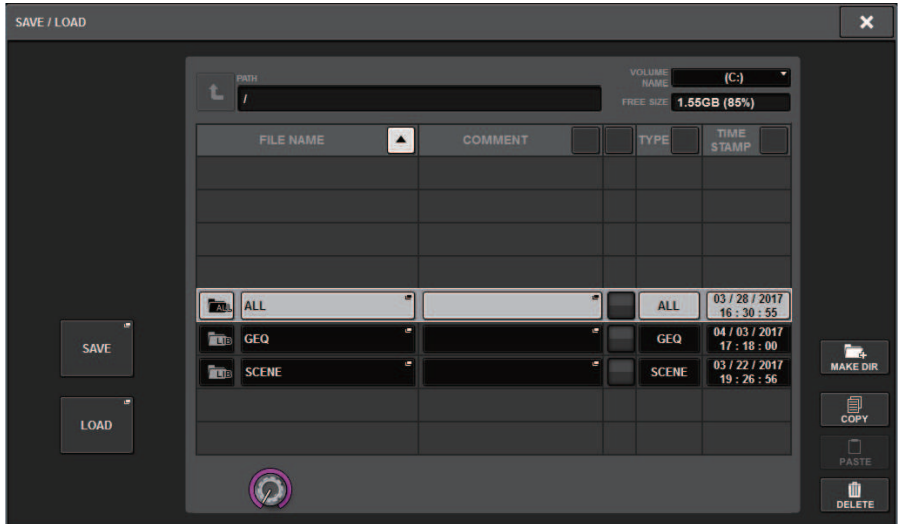

3 Press the **SAVE** button in the **SAVE/LOAD** popup window.

The SAVE SELECT screen will appear, in which you can select data to save.

4 In the **SAVE SELECT** screen, select a type of data to save.

NOTE

The SAVE button will become available if data to save exists.

5 Press the **SAVE** button in the **SAVE SELECT** screen.

A keyboard window will appear, allowing you to enter a file name and comment.

6 Enter a file name or comment, and press the **OK** button.

When the file has been saved, the PROCESSING popup window that shows the progress of the writing operation will close.

NOTE

- If you are going to overwrite a file or save a file with the same name in the same folder, a dialog will ask you to confirm the overwrite.
- You can enter a comment of up to 32 characters.
- You may enter a file name of up to 16 characters. However, the drive name, path name, and file name are limited to a total of 256 characters. If you exceed this limit, you may be unable to save the file, depending on the length of the file name. If this error indication appears at the bottom of the screen, shorten the file name and try saving the file again.

SAVE SELECT screen



This window contains the following items.

1 TYPE field

Enables you to select a type of data to save. The displayed items on this screen vary depending on the selected tab.

- **ALL tab**

All items are targeted. (Type: ALL)

- **SCENE LIST tab**

Scene memories are targeted. (Type: SCENE)

- **INPUT/OUTPUT tab**

The following table lists the items you can select.

Button	Data	Type
INPUT CH LIB	Input channel libraries	IN CH
OUTPUT CH LIB	Output channel libraries	OUT CH
INPUT EQ LIB	Input EQ libraries	IN EQ
OUTPUT EQ LIB	Output EQ libraries	OUT EQ
DYN LIB	Dynamics libraries	DYNA

- **PLUG-IN/GEQ tab**

The following table lists the items you can select.

Button	Data	Type
PLUG-IN	Plug-in library	

Button	Data	Type
PLUG-IN	REV-X library	P REVX
	SP2016 library	P 2016
	VSS4HD library	P VSS4
	NonLin2 library	P NL2
	Y7 library	P Y7
	Reverb library	P REV
	Stereo Reverb library	P STRV
	EarlyReflections library	P ER
	Gate Reverb library	P GTRV
	Mono Delay library	P MNDL
	Stereo Delay library	P STDL
	Mod.Delay library	P MDDL
	Delay LCR library	P DLCR
	Echo library	P ECHO
	Analog Delay library	P ADLY
	Chorus library	P CHOR
	Flange library	P FLNG
	Symphonic library	P SYMP
	Dyna.Flange library	P DYFL
	Dyna.Phaser library	P DYPH
	Phaser library	P PHAS
	Max100 library	P M100
	Dual Phaser library	P DUPH
	Vintage Phaser library	P VPHS
	HQ.Pitch library	P HQPT
	Dual Pitch library	P DPT
	H3000 Live library	P H3KL
	Tremolo library	P TRML
	Auto Pan library	P APAN
	Rotary library	P ROTR
	Ring Mod library	P RMOD
	Mod.Filter library	P MFIL
	Dyna.Filter library	P DFIL
	RupertEQ773 library	P Q773
	RupertEQ810 library	P Q810
	Portico5033 library	P5033
	EQ-1A library	P EQ1
	Equalizer601 library	P 601
	Dynamic EQ4 library	P DEQ4
	RupertComp754 library	P C754
RupertComp830 library	P C830	

Button	Data	Type
PLUG-IN	Portico5043 library	P5043
	Portico5045 library	P5045
	U76 library	P U76
	Opt-2A library	P OP2
	Comp276 library	P 276
	Buss Comp 369 library	P BCP
	MBC4 library	P MBC4
	DaNSe library	P DNSE
	P2MB library	P2MB
	Distortion library	P DIST
	Amp Simulate library	P ASIM
	OpenDeck library	P OPDK

Buttons	Data	Type
GEQ LIB	GEQ library	GEQ

- OVERLAY tab
This targets the overlay.

Button	Data	Type
OVERLAY LIB	Overlay library	OVERLAY

- Name/Assign button
The following table lists the items you can select.

Button	Data	Type
INPUT NAMELIB	INPUT NAME library	IN NAM
MIX/ST NAMELIB	MIX/STEREO NAME library	MX NAM
MTRX NAMELIB	MATRIX NAME library	MT NAM
DCA ASGNLIB	DCA assign library	DCA NM
MUTE ASGNLIB	Mute Group Assign library	MUT NM

- SETUP tab
The following table lists the items you can select.

Button	Data	Type
USER SET LIB	User Setup library	U SET
MONITOR SETUP	Monitor settings	MONITOR
MIDI PGM	MIDI Program Changes	PGM
MIDI CTL	MIDI Control Changes	CTL
CUSTOM FADER	Custom Fader	C FAD
MACRO LIB	MACRO	MACRO

2 Data field

Indicates data of the selected type.

File > SAVE SELECT screen

3 Data select knob

Use the corresponding screen encoder or the [TOUCH AND TURN] knob to select data.

Loading a file from a USB flash drive

Follow the steps below to load the RIVAGE PM series setting file from the USB flash drive into the console. You can use the same procedure to load the following files other than the setting file.

Extension	Type	Contents of file
.PM10ALL .PM7ALL	ALL	All data including internal settings for the RIVAGE PM series (the save format prior to V3.05)
.PM10PART .PM7PART	*1	Data including individual internal settings for the RIVAGE PM series (the save format prior to V3.05)*1
.RIVAGEPM	ALL	All data including internal settings for the RIVAGE PM series
.RIVAGEPM	*1	Data including individual internal settings for the RIVAGE PM series *1
.BMP	BMP	Image file for display in the CONSOLE LOCK screen (256 or more colors, uncompressed bitmap format)
.jpg	JPG	Image file for display in the CONSOLE LOCK screen (JPEG format)
.png	PNG	Image file for display in the CONSOLE LOCK screen (PNG format)

*1 For more information about the type and file details, refer to the “TYPE field” in the section entitled “Saving the RIVAGE PM series’s settings on a USB flash drive”.

NOTICE

- Some data may contain settings that will cause the console to output signals immediately after the data is loaded. Therefore, before loading data, turn off the power to the equipment connected to the control surface and/or lower the volume of such equipment so that there will not be a problem even if a signal is output from the control surface.

1 Press the SETUP button on the menu bar to access the SETUP screen.



2 Press the SAVE/LOAD button to access the SAVE/LOAD popup window.

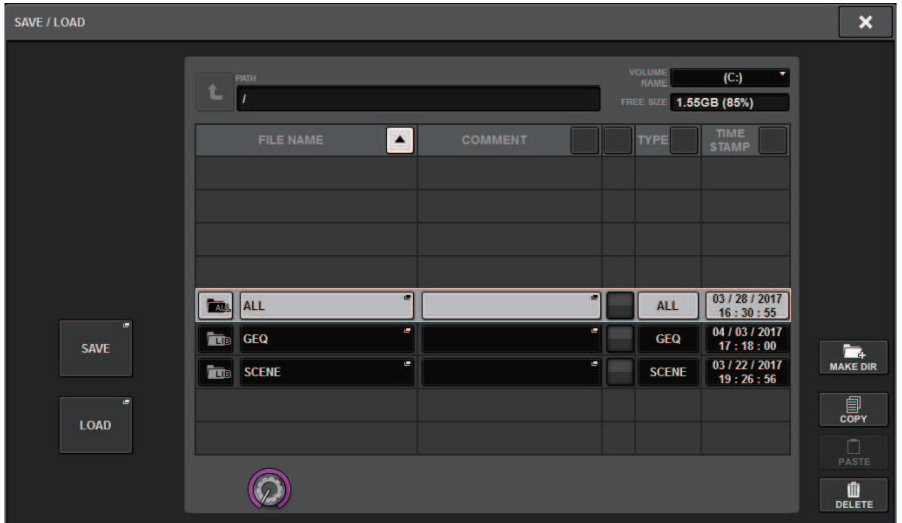

Select a file to load.

NOTE

The LOAD button will become available if you select loadable data.

3 Press the LOAD button in the SAVE/LOAD popup window.

The “LOAD SELECT screen” (p.864) will appear, in which you can select data to load.

4 In the “LOAD SELECT screen” (p.866), select a type of data, data to load, and load destination.

NOTE

If the SOURCE field and DESTINATION field are displayed, selecting data to load and the data destination in these fields will enable the LOAD button.

5 Press the LOAD button. A confirmation dialog box will appear.

6 Press the OK button to begin loading the data.

When the file has finished loading, the PROCESSING popup window that shows the progress of the loading operation will close.

LOAD SELECT screen

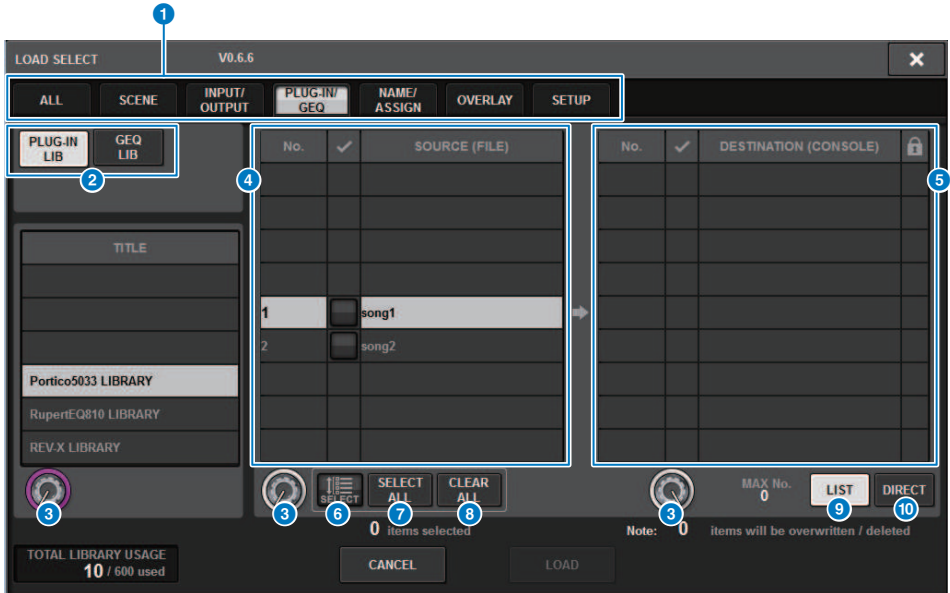

This screen contains the following items.

- 1 TYPE field**
Enables you to select a type of data to load. The displayed items in the TYPE field vary depending on the selected tab. (Saving the RIVAGE PM series's settings on a USB flash drive)
- 2 Data field**
Indicates data of the selected type.
- 3 Data select knob**
Use the corresponding screen encoder or the [TOUCH AND TURN] knob to select data.
- 4 SOURCE field**
This area lists data that are saved on the USB flash drive.
- 5 DESTINATION field**
This area lists the destination to which the selected data will be loaded.
- 6 MULTI SELECT button**
Press this button to select multiple setting data items simultaneously.
- 7 SELECT ALL button**
Press this button to select all items.

File > LOAD SELECT screen

8 **CLEAR ALL button**

Press this button to clear all selections.

9 **LIST button**

Press this button so that you can select a load destination from the list.

10 **DIRECT button**

Press this field so that you will be able to specify the destination by entering the number directly into the field.

LOAD SELECT screen

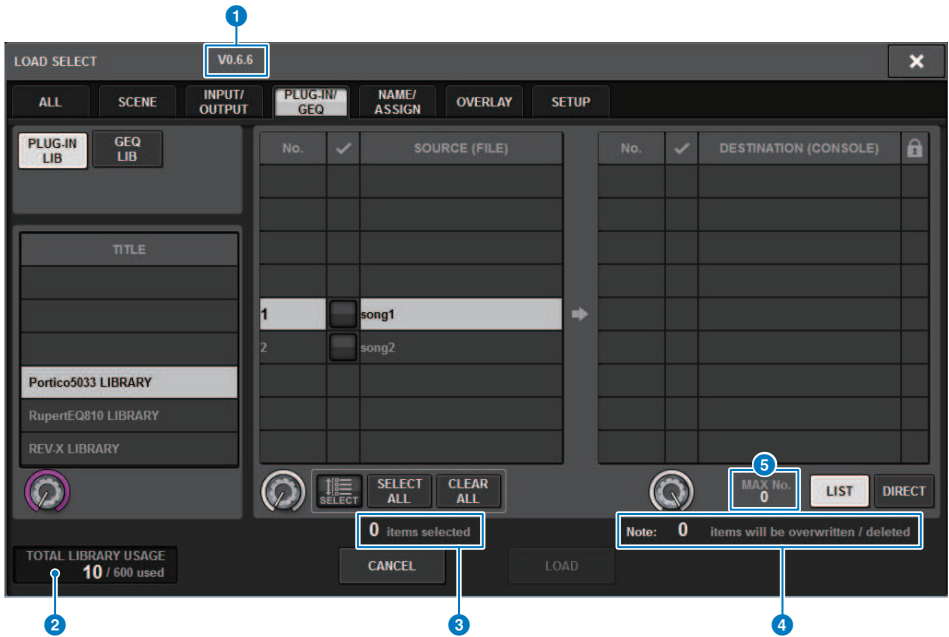

This screen contains the following items.

- 1 Firmware version indication**
Shows the version of firmware on which the data was created.
- 2 TOTAL LIBRARY USAGE indication**
Shows the state of library usage.
- 3 Number of selected data items**
Shows the number of items selected in the SOURCE field.
- 4 Number of data items to be deleted and to be updated**
Shows the total number of data items that will be deleted and data items that will be updated (overwritten) after the load operation is executed.
- 5 Maximum number of data items**
Indicates the maximum number of selected scenes and libraries.

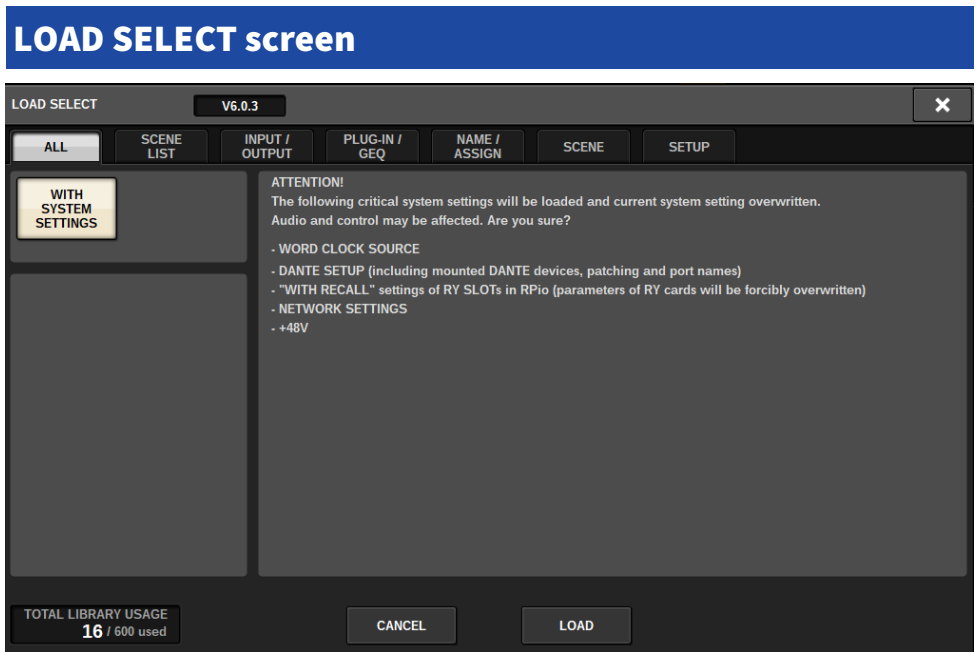

When loading data different from the current system configuration, a warning button will display.

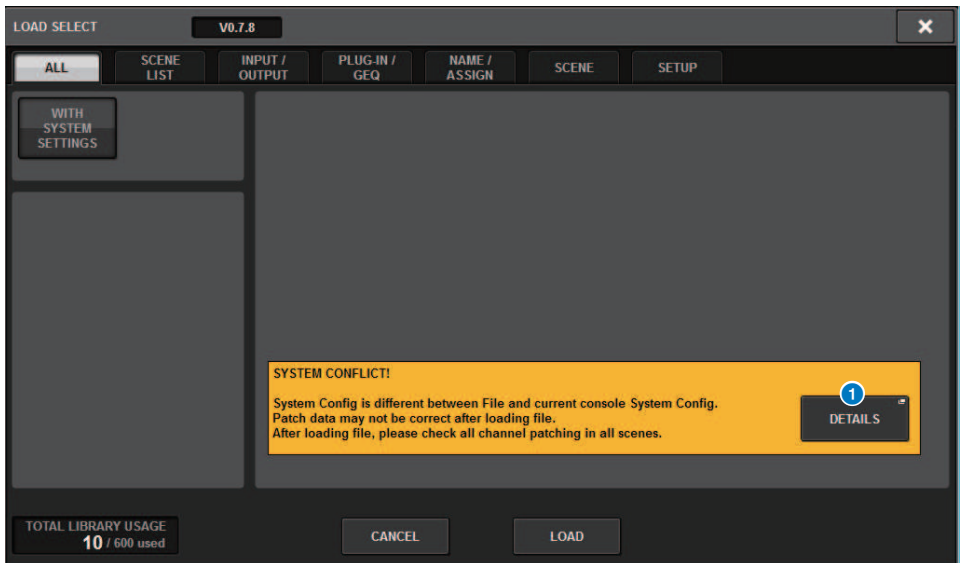

1 DETAILS button

Press this button to access the SYSTEM CONFLICT popup window, which shows the differences in configuration.

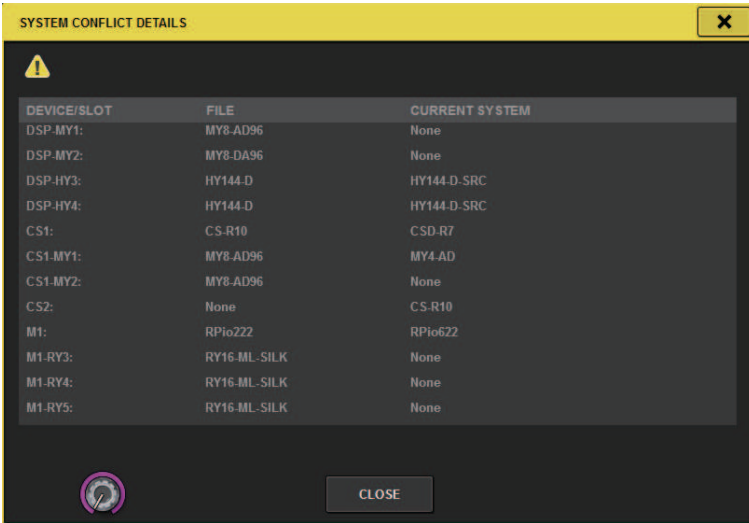

NOTE

When loading data with ALL type, press the WITH SYSTEM SETTINGS button to load the following items.

- Word clock settings
- DANTE SETUP (includes device mount, patch and port name)
- WITH RECALL settings for RY slot of RPio622/222 (parameter settings in the RY card will be loaded regardless of WITH RECALL settings)
- Network settings (HY slot or RIVAGE PM StageMix)
- +48V ACTIVE

About loading

If you select as the load destination a scene memory number for which an associated scene already exists, the existing scene will be deleted first, and then the data will be loaded into that scene memory.

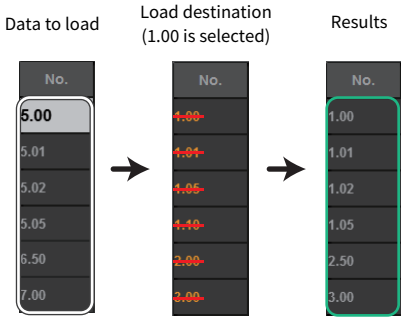

The same principle applies to the libraries. If the destination already contains data, it will be overwritten by loaded data.

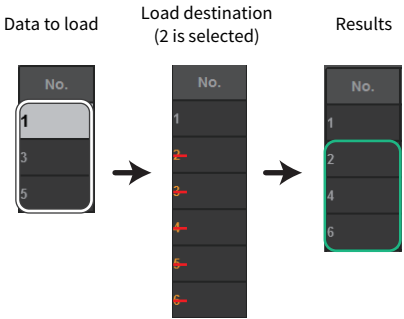

Editing the files saved on the USB flash drive

This section explains how to perform editing operations for the files and directories on the USB flash drive.

1 Press the SETUP button on the menu bar to access the SETUP screen.

2 Press the SAVE/LOAD button.

The “SAVE/LOAD popup window” (p.871) appears. The list will show the files and sub-directories that have been saved.

3 Perform the desired editing operation.

For more information about these operations, refer to the explanation for each operation.

SAVE/LOAD popup window

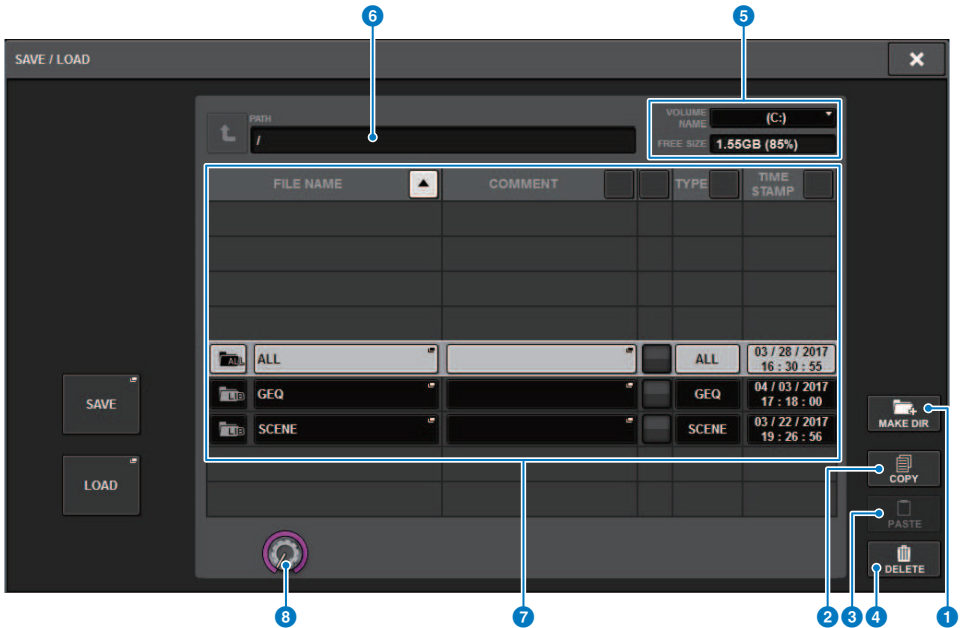

This screen contains the following items.

MAKE DIR button

Creates a new directory.

1 MAKE DIR button

Creates a new directory.

2 COPY button

Copies a file into a buffer memory (a temporary storage area).

3 PASTE button

Pastes the file from the buffer memory.

4 DELETE button

Deletes the currently-selected file.

NOTE

A directory cannot be deleted.

5 VOLUME NAME/FREE SIZE

Indicates the volume name and the amount of free space on the USB flash drive.

6 PATH

Indicates the name of the current directory. Press the arrow button to move to the next higher level. If the current directory is the top level, the arrow button is dimmed.

7 File List

This area lists files that are saved on the USB flash drive.

- **FILE NAME**

Indicates the file name, extension, and icon. If you press the file name, the TITLE EDIT popup window will appear, enabling you to edit the file name.

- **COMMENT**

Indicates comments added to the RIVAGE PM series file. **WARNING!**

- **READ ONLY**

A lock symbol is shown to indicate protected files. You can press this area to enable or disable the protect setting.

- **TYPE**

Indicates the file type. "ALL" or "LIB" represents a file containing the RIVAGE PM series's internal settings. "BMP" represents a bitmap image file, and [DIR] represents a directory. "???" indicates an MP3 file or WAV file, or a file that the RIVAGE PM series does not recognize.

- **TIME STAMP**

Indicates the date and time when the file or directory was created or updated.

8 Scroll knob

Scrolls up/down through the file list.

Sorting files and editing file names/comments

- 1 To sort the files, press one of the sort buttons located to the right of each column heading (“FILE NAME,” “COMMENT,” “READ ONLY,” “TYPE,” or “TIME STAMP”) at the top of the file list.**

To sort the one of the sort buttons located to the right of each column heading (“FILE NAME,” “COMMENT,” “READ ONLY,” “TYPE,” or “TIME STAMP”) at the top of the file list.

- 2 If you want to edit the file name or comment, press the FILE NAME field or COMMENT field of each file to access the keyboard window.**

Enter a file name or comment, and press the RENAME button or SET button.

- 3 To turn the protect setting on or off, press the READ ONLY field for the file.**

A protect symbol is displayed for write-protected files. These files cannot be overwritten.

NOTE

You cannot edit the file name or comment field of a write-protected file.

Sort buttons located at the top of the file list

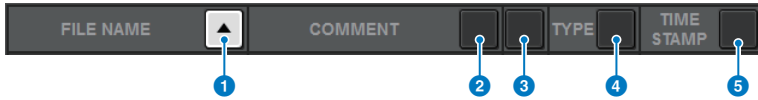

This screen contains the following items.

- 1 FILE NAME**
Sorts the list in numerical/alphabetical order of the file names.
- 2 COMMENT**
Sorts the list in numerical/alphabetical order of comments.
- 3 READ ONLY**
Sorts the list by Write Protect on/off status.
- 4 TYPE**
Sort the list by file type.
- 5 TIME STAMP**
Sorts the list by date and time of update.

NOTE

By pressing the same location again, you can change the direction (ascending or descending order) in which the list is sorted.

Copying and pasting a file

Follow the steps below to copy a file into buffer memory, and then paste it with a different file name.

1 Rotate the screen encoder to select the copy-source file, and press the COPY button.

The highlighted line in the file list indicates that the file is selected.

2 If necessary, press the directory icon and change the directory.

To move to the next higher level, press the arrow button in the PATH field.

3 Press the PASTE button.

A keyboard window will appear, allowing you to enter the file name.

4 Enter the file name, and press the PASTE button.

NOTE

You cannot paste an existing file name onto a second file.

Deleting a file

- 1 Rotate the screen encoder to select the file you want to delete, and press the DELETE button.**

A dialog box will ask you to confirm the Delete operation.

- 2 To execute the Delete operation, press the OK button.**

NOTE

You cannot delete a protected file.

Creating a directory

1 If necessary, press the directory icon and change the directory.

To move to the next higher level, press the arrow button in the PATH field.

2 Press the MAKE DIR button.

A keyboard window will appear, allowing you to enter a directory name.

3 Enter the name of the directory you want to create, then press the MAKE button.

NOTE

You cannot create a directory using a directory name that already exists.

Exporting a CSV file

The state of the channel names and patch connections of the RIVAGE PM series can be exported or imported as a CSV format file in order to edit the data or to exchange data between units.

The applicable parameters and file names are as follows. For details, refer to the data list.

	Parameter	File name
Channel name / channel color / icon	INPUT	InName.csv
	MIX	MixName.csv
	MATRIX	MtxName.csv
	STEREO	StName.csv
	MUTE/DCA	MuteDCAName.csv
Patch connection status	INPUT IN	InPatch.csv
	INPUT INSERT I/O	InInsPatch.csv
	OUTPUT INSERT I/O	OutInsPatch.csv
	PORTRACK	PortRackPatch.csv
	RECORDING	RecordingPatch.csv

1 Press the **SETUP** button to access the **SETUP** screen.



2 Press the **CSV EXPORT/IMPORT** button.

The “CSV EXPORT/IMPORT popup window” (p.880) appears.

3 Press the EXPORT button if you want to export a CSV file, or press the IMPORT button if you want to import a CSV file.

A dialog box will ask you to confirm the operation.

4 To execute, press the OK button.

CSV EXPORT/IMPORT popup window

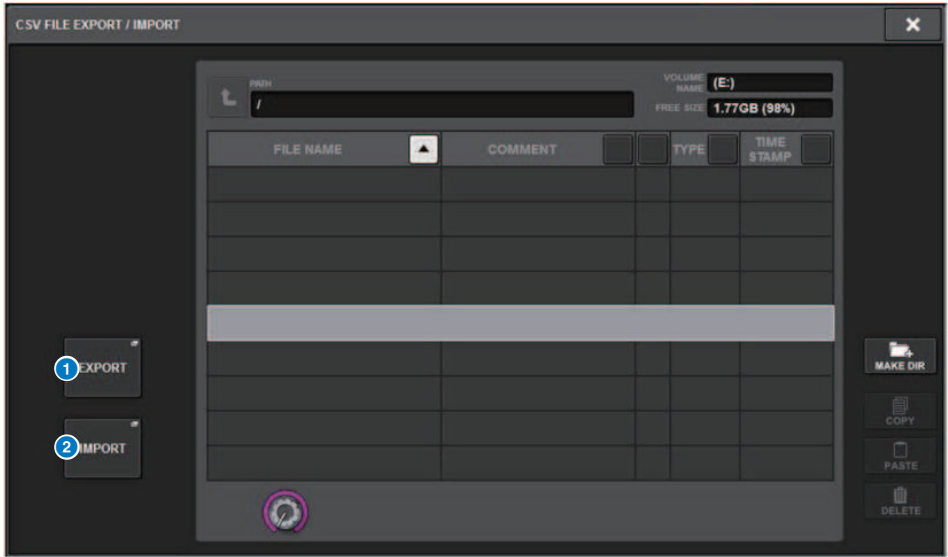

This screen contains the following items.

1 EXPORT button

When you press this button, a CSV file is exported to the current directory.

2 IMPORT button

When you press this button, a CSV file is imported from the current directory.

Theatre Mode

Theatre mode

The “Theatre mode” is a mode that is optimal for use in theaters, which allows for EQ and dynamics to be set over four banks and then allocated for each actor. In Theatre mode, the parameters for EQ and dynamics are not respectively stored in scene memory. Rather, only the information on what bank is used is stored. Owing to this, any detailed changes made during execution will be enabled by carrying over into all scenes that use the same bank, without the need to do a global paste. These four banks can be edited by managing the lists for each actor in the actor library. This gives you flexible control when there double cast members switch, when the cast abruptly changes hands and so on. The channel library in Theatre mode includes all content from the four banks. The EQ and dynamics set in a channel in Default mode will not carry over into Theatre mode, nor will the EQ and dynamics carry over in the reverse case.

NOTE

The EQ and dynamics parameters in Preview mode are not included.

How to configure the Theatre mode settings

This section explains the steps for configuring the Theatre mode settings.

1 Press the **SETUP** button to access the **SETUP** screen.



1 Press the **MAINTENANCE** button to access the **MAINTENANCE** popup window.

2 Press the UNIT MODE tab.

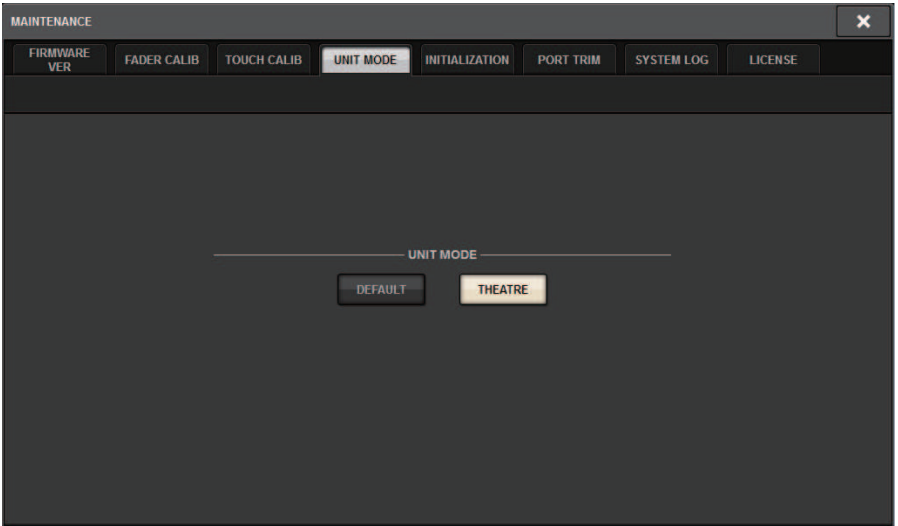

3 Press the THEATRE mode switching button.

After the mode switches, a confirm popup window will open to confirm that the control surface will be restarted.

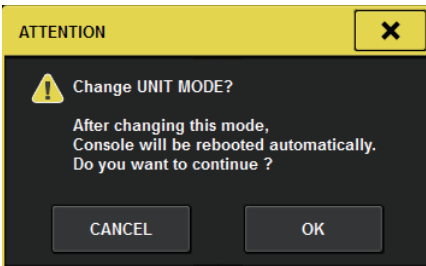

4 Press the OK button.

How to configure the Theatre mode settings for DSP engines

This section explains the steps for configuring Theatre mode settings for a DSP engine.

- 1 Press the [MENU] key on the front panel of the DSP engine.**
- 2 Use the [▲]/[▼] keys to select “Unit Mode”.**
- 3 Press the [ENTER] key.**
- 4 Use the [▲]/[▼] keys to select “Theatre”.**

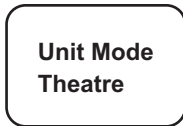

- 5 Press the [ENTER] key.**
- 6 After “DONE” is displayed, the DSP engine will reboot.**

SELECTED CHANNEL VIEW screen (Theatre mode)

When the Theatre mode setting is set in UNIT MODE and the BANK display button is pressed, the SELECTED CHANNEL VIEW screen for the input channel will show as follows.



1 BANK display button

When this is turned on, a selection button will be displayed to switch between the EQ for banks A–D and the graph for Dynamics 1/2.

2 EQ graph

This field graphically indicates the approximate EQ/filter response.

3 Bank switching buttons

Switches between the EQ and Dynamics 1/2 banks. Press the selected button to display the NAME EDIT popup window. Also, the bank and bank name will display in the EQ and Dynamics fields. The same bank name will be used for bank-linked EQ and Dynamics 1/2.

4 Bank link button

When this is turned on, the EQ and Dynamics 1/2 banks (A–D) can be switched together in tandem with the bank selection button.

5 Dynamics graph

Displays the input/output response of Dynamics 1/2.

Added indicators in Theatre mode

The actor library name has been added as an indicator for the NAME popup buttons.



The actor library name has been added as an indicator to the actor library popup buttons on the NAME/ICON EDIT popup window, which appears when a NAME popup button is pressed.



Pressing an actor library popup button will display the actor library popup window.

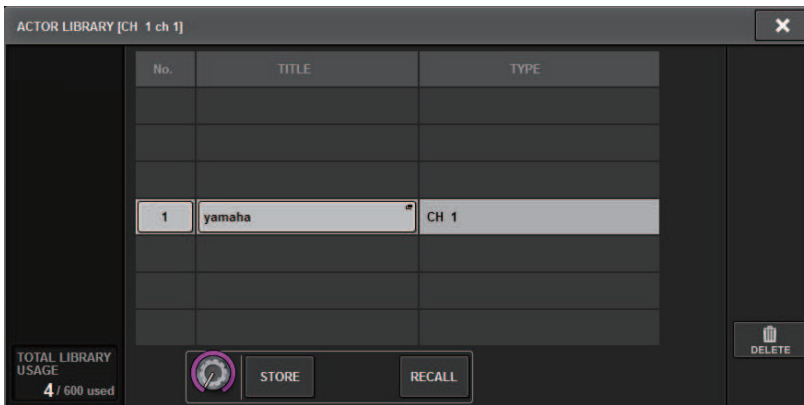

Theatre Mode > Added indicators in Theatre mode

When the Theatre mode setting is set in UNIT MODE, a CH ON FOLLOWS DCA ASSIGN button will be added on the DCA GROUP ASSIGN screen.



1 CH ON FOLLOWS DCA ASSIGN button

When this is turned on, the DCA-assigned channel will turn on.

OVERVIEW screen

When the Theatre mode setting is set in UNIT MODE, the OVERVIEW screen will appear as follows.



The actor library name has been added as an indicator for the channel name area. (Pressing the [SHIFT] key will display the CUE status, as with normal mode.) When the EQ or dynamics parameters have been changed, an asterisk will appear in the actor library name.

HPF/EQ popup window



DYNAMICS 1/2 popup window



1 Bank select buttons

Switches between the EQ and Dynamics 1/2 banks.

How to configure the actor library settings

This section explains how to configure the actor library settings.

1 Press the PATCH button to access the PATCH screen.

2 Press the ACTOR tab.

The “Actor library screen” (p.890) will display.

3 Edit the actor library settings as needed.

NOTE

- The actor libraries associated with a channel will not be copied when using the CH COPY function. Actor libraries can be moved with the CH MOVE function.
- Default mode and Theatre mode are the same for both the input EQ and dynamics libraries, but the input channel library EQ and dynamics settings are not the same. For this reason, the input channel EQ and dynamics parameters in Theatre mode are excluded from recall operations.

Actor library screen



This screen contains the following items.

1 INPUT NAME

Indicates the input channels that will be assigned to the actor library.

2 ACTOR LIBRARY

Shows the actor library name that was set. Press this to display the actor library popup window, where you can configure the actor library.

3 UPDATE button

Updates the library to the current data.

4 RECALL button

Recalls the library set in the respective channel. Changes to the current data will be overwritten by the recalled library.

5 DEFAULT button

Cancels the library settings and initializes the current data for the EQ and Dynamics 4 bank.

6 INPUT NAME select knob

Use the corresponding screen encoder or the [TOUCH AND TURN] knob.

7 UPDATE EDITED button

Updates the libraries for all channels that were modified.

8 RECALL EDITED button

Recalls the libraries for all channels that were modified.

Theatre Mode > Actor library screen

9 **DEFAULT ALL button**

Cancels the library settings for all channels and initializes the current data for the EQ and Dynamics 4 bank.

AFC IMAGE control

AFC IMAGE settings

AFC IMAGE allows you to intuitively create a variety of effects without worrying about individual speaker settings, by arranging large numbers of objects and moving them freely.

1 Press the SETUP button on the menu bar to access the SETUP screen.

2 Press the NETWORK button to display the NETWORK screen.

This screen includes several pages, which you can switch among using the tabs located at the top of the screen.

3 Press the IMMERSIVE SOUND tab to display the IMMERSIVE SOUND screen.

NOTE

Audio should be patched to the output card using DIRECT OUT.

NETWORK screen: IMMERSIVE SOUND tab



This screen contains the following items.

1 DEVICE MOUNT popup button

Press this button to display the IMMERSIVE SOUND DEVICE popup screen where you can select the device for mounting. Mount the device by selecting AFC and pressing the OK button.

2 SYNC STATUS indicator

Lights up when synchronized with the device.

3 NETWORK SETTING popup button

Press this button to display the NETWORK popup screen for setting the IP address and port number.

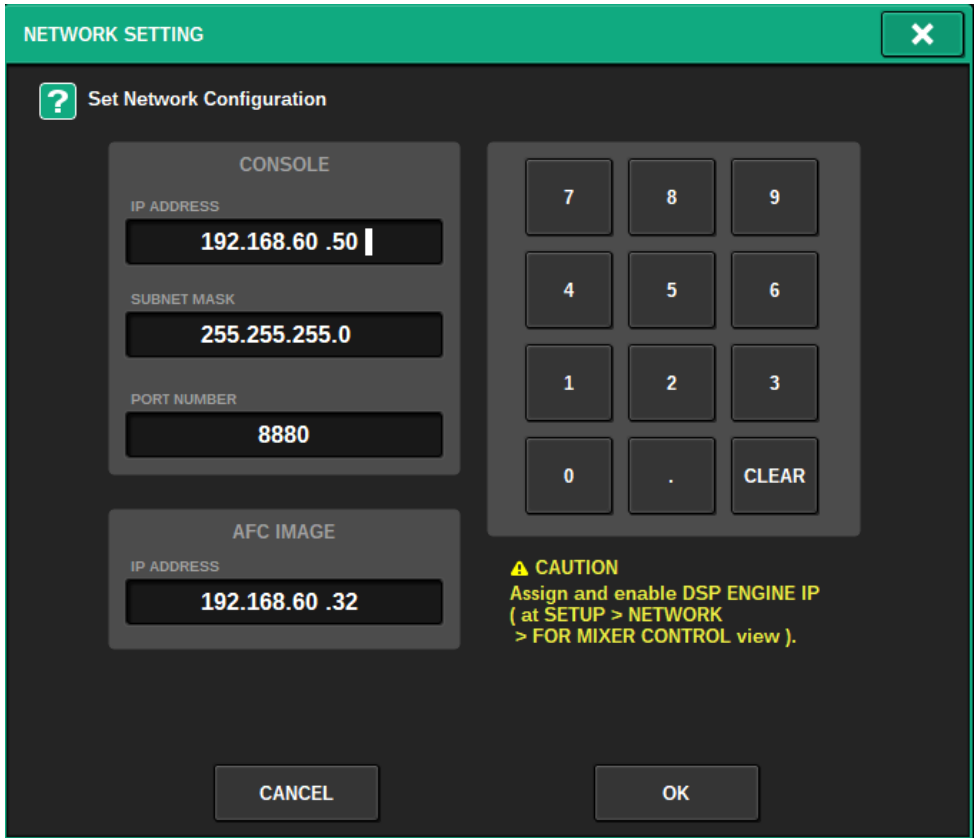

4 IP address / port number display

Press this button to display the NETWORK popup screen for setting the IP address and port number.

5 REFRESH

Match the pair status and name of the channel. Use the DIRECTION SETTING button to set the direction, and the REFRESH button to set it.

6 OBJECT ASSIGN

Sets the start channel and number of objects for the INPUT and MIX channels.

7 SCENE RECALL SYNC

When this is turned on, AFC scenes can be recalled from the console.

8 MAIN FADER RECALL SAFE

When this is turned on, the DCA24 main fader used by AFC is excluded from recall operations.

SELECTED CHANNEL VIEW screen

When the AFC IMAGE is set, the SELECTED CHANNEL VIEW screen will appear as follows.



1 Immersive sound graph

Pressing the graph highlights it with a white frame, indicating that you can use the screen encoders to control the parameters in the channel name area. Press the graph once again to access the IMMERSIVE SOUND popup window (1CH).

2 PAN/AFC switch button

Switches between stereo mode and immersive sound mode. You can display/change AFC IMAGE parameters on the IMMERSIVE SOUND popup screen.

IMMERSIVE SOUND popup window (1CH)

AFC IMAGE parameters can be viewed and edited for the corresponding multiple channels. (Example: Stereo channel)

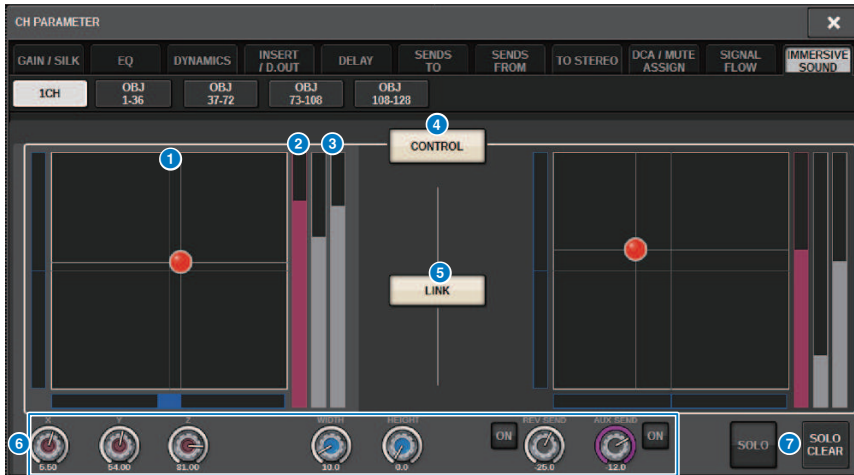

1 AFC IMAGE graph

Displays parameters for AFC IMAGE.

2 Z meter

Displays the Z axis of the object.

3 Send meter

Displays the send level.

4 AFC CONTROL button

Switches the control on or off. When this button is turned off, the position cannot be operated from the console.

5 LINK button (stereo channels only)

If you turn on the link button for a stereo channel, this links the left and right channel parameters.

6 Parameter knobs

Displays the position (X, Y, Z), size and send level of AFC IMAGE. Use the screen encoder or the [TOUCH AND TURN] knob to operate the parameters.

7 SOLO

Switches the Solo function on or off. The SOLO CLEAR button disables all solo functions.

The SOLO and SOLO CLEAR buttons for which show mode is turned on in AFC IMAGE will be hidden.

IMMERSIVE SOUND popup window (OBJ1-36, OBJ37-72, OBJ73-108, OBJ109-128)

AFC IMAGE parameters can be viewed and edited for the corresponding multiple channels.

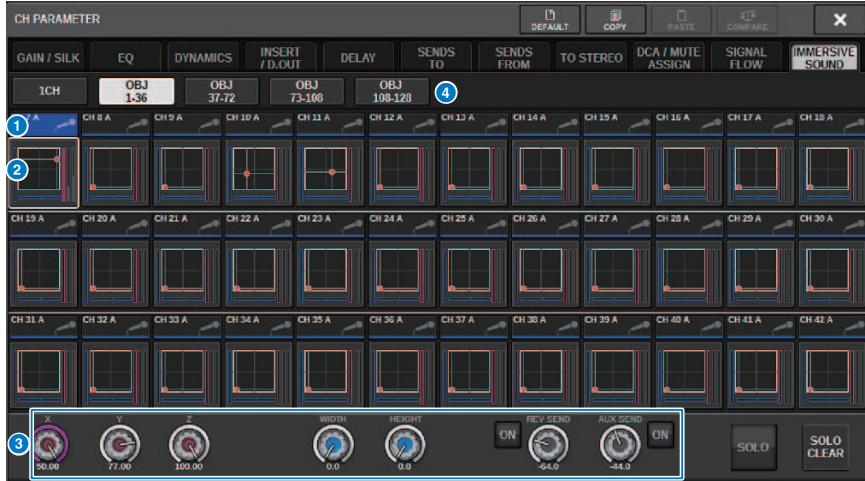

1 Channel select buttons

For selecting the desired channel for operating. The current channel icon, channel number, channel name, and color appear on the button.

2 Immersive sound graph

Displays AFC IMAGE parameters.

3 Parameter knobs

Displays the position (X, Y, Z), size and send level of AFC IMAGE. Use the screen encoder or the [TOUCH AND TURN] knob to operate the parameters.

4 Display switching buttons

For selecting the channels that you want to view on the screen.

AFC IMAGE field

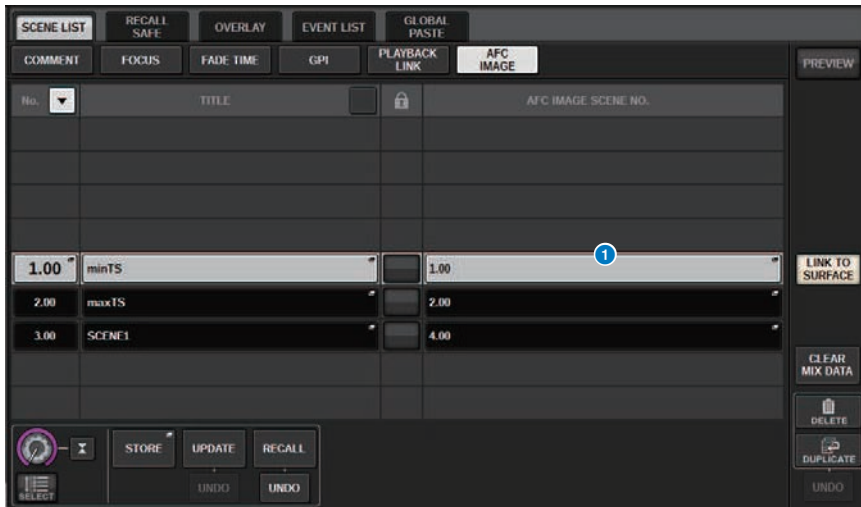

This screen contains the following items.

1 AFC IMAGE button

Sets the scene number to be linked to the AFC IMAGE when the RIVAGE PM series scene is recalled. This function can be turned on and off with SCENE RECALL SYNC.

Genius.lab

Genius.lab

Genius.lab is a function that allows you to freely set up macros ("If this condition is met, perform certain actions"). By using Genius.lab, you can perform a variety of arbitrary actions triggered by key presses or fader operations.

Some of the use cases are shown below.

- If the fader value for CH1 becomes greater than $-\infty$, the CH1 cue is turned off
- Toggle VSC on and off when a USER DEFINED key is pressed
- When a function key is pressed, TALKBACK ASSIGN for that bus is turned on or off
- When the USER DEFINED key [1] is pressed and the CH1 fader value is greater than -3dB , the gain of EQ Band4 is set to -3dB
- When the USER DEFINED key [1] is pressed, if the selected channel's MIX SEND level is $-\infty$, this turns off.

A macro consists of four sections: ACTION / REVERSE ACTION, which defines the action, and TRIGGER / CONDITION, which defines the conditions under which the action is executed. Each SECTION is composed of multiple ATOMs that define specific actions and conditions. Macros are set up by configuring their components or capturing parameter changes.

The macro is executed when the condition of the ATOM held by the TRIGGER changes. However, it is not executed when the CONDITION is FALSE. When the TRIGGER is TRUE, the ACTION is executed, and when it is FALSE, the REVERSE ACTION is executed.

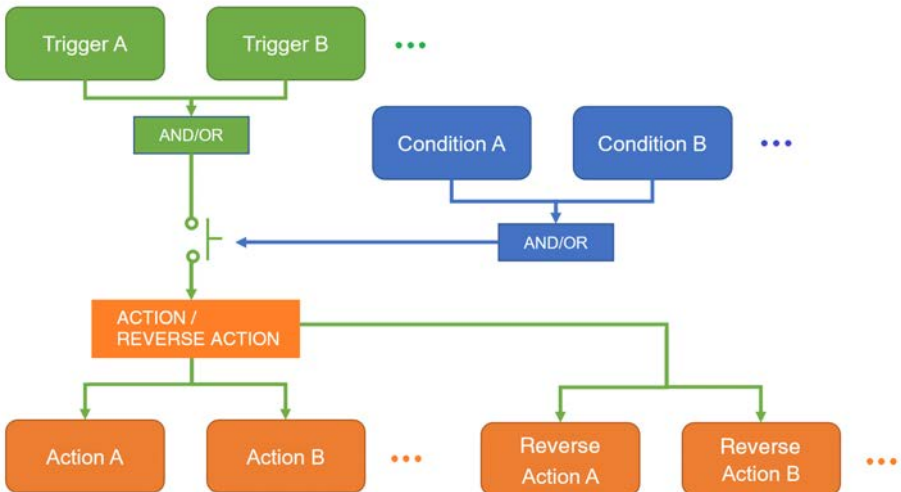

MACRO LIST window

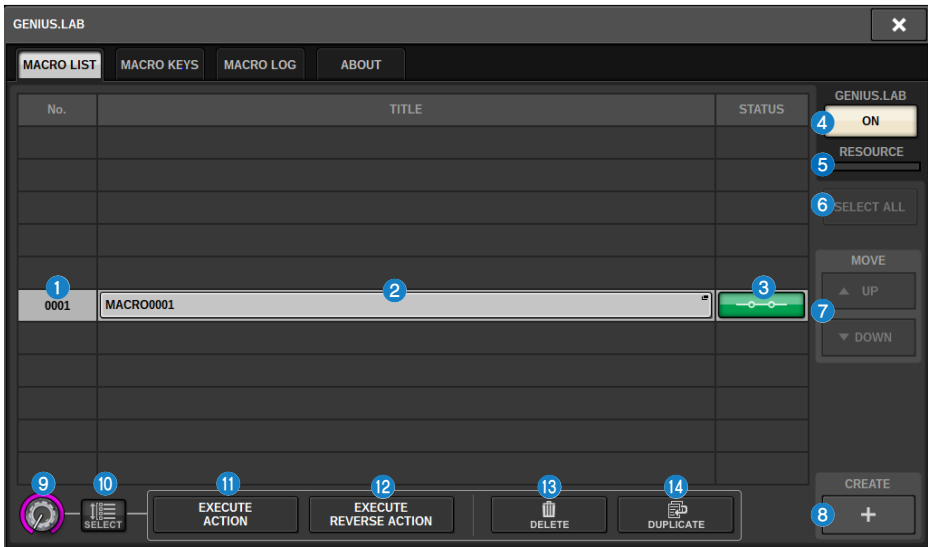

This window contains the following items.

- 1 **Macro number**
Indicates the macro number.
- 2 **Macro title button**
Indicates the title assigned to the macro. Press this to open the MACRO EDIT window used to set the macro.
- 3 **Macro status button**
Indicates the macro status. Press this to switch a macro on or off.
- 4 **GENIUS.LAB ON button**
When this is turned on, Genius.lab (macro function) is enabled.
- 5 **RESOURCE**
Shows the state of macro resource usage.
- 6 **SELECT ALL button**
Deletes all macros in the list.
- 7 **MOVE field**
 - **UP button**
Moves the currently-selected macro up step-by-step in the macro list.
 - **DOWN button**
Moves the currently-selected macro down step-by-step in the macro list.

8 CREATE button

Creates a macro.

9 SELECT knob

Use the corresponding screen encoder or the [TOUCH AND TURN] knob to select a macro.

10 MULTI SELECT button

You can select multiple consecutive macros by turning on this button and rotating the screen encoder.

11 EXECUTE ACTION button

Executes the ACTION of the selected macro.

12 EXECUTE REVERSE ACTION button

Executes the REVERSE ACTION of the selected macro.

13 DELETE button

Deletes the currently-selected macro.

14 DUPLICATE button

Duplicates the currently-selected macro.

MACRO EDIT window

Specifies the settings for the TRIGGER / CONDITION and ACTION / REVERSE ACTION that make up the macro.

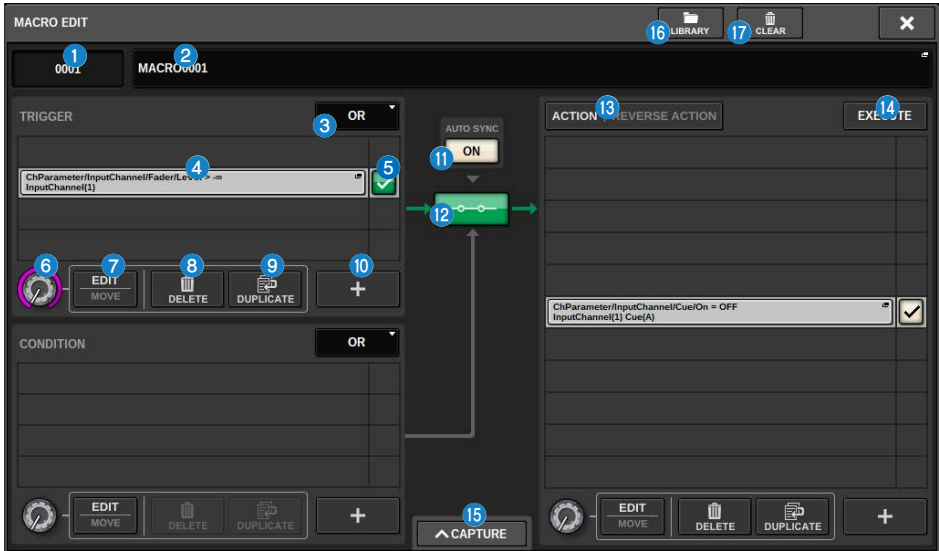

This window contains the following items.

- 1 Macro number**
Indicates the macro number.
- 2 Macro title popup button**
Indicates the title assigned to the macro. Press this button to access a window where you can edit the title.
- 3 Logic buttons**
Selects the logic (OR or AND) for the TRIGGER and CONDITION.
The TRIGGER / CONDITION state is determined based on the logic and ATOM states.
OR: If any one of the ATOM states is TRUE, the TRIGGER / CONDITION state is set to TRUE. It is set to FALSE for all other cases.
AND: If any one of the ATOM states is FALSE, the TRIGGER / CONDITION state is set to FALSE. It is set to TRUE for all other cases.
- 4 ATOM indicator**
Indicates the ATOM settings. Press this button to open the setting window.
- 5 ATOM status button**
Indicates the ATOM status. The statuses are shown below.
Press this to switches an ATOM on or off.

Status	Button color	Description
TRUE	Green	When the ATOM condition is TRUE
FALSE	Orange	When the ATOM condition is FALSE
Hi-Z	Ivory	When the status is not determined
OFF	Gray	

6 SELECT knob

Use the screen encoder to select an ATOM.

7 EDIT/MOVE button

This is a toggle button that edits and reorders ATOMS. During EDIT, the displayed DELETE button and DUPLICATE button are used to delete or duplicate. During MOVE, the UP button and DOWN button are used to rearrange the order.

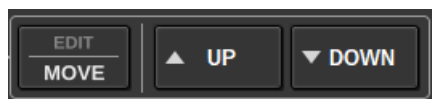

8 DELETE button

Deletes the selected ATOM.

9 DUPLICATE button

Duplicates the selected ATOM.

10 + button

Press this button to open a window to add ATOMS.

11 AUTO SYNC button

When AUTO SYNC is ON and a MACRO is set to on, the ACTION or REVERSE ACTION for which the conditions are met will be executed automatically.

12 STATUS button

Indicates the macro status. The statuses are shown below.

Press this to switch a macro on or off.

Macro status	Button color	Trigger status	CONDITION status
TRUE	Green	TRUE	TRUE / Hi-Z
FALSE	Orange	FALSE	TRUE / Hi-Z
Hi-Z	Ivory	Hi-Z	TRUE / Hi-Z
OPEN	Blue	TRUE / FALSE / Hi-Z	FALSE
OFF	Gray		

13 ACTION / REVERSE ACTION button

This is a toggle button that switches the ACTION / REVERSE ACTION display.

14 EXECUTE button

Press this to execute the ACTION or REVERSE ACTION of the selected macro.

15 CAPTURE button

Press to open the CAPTURE window, which allows you to capture parameter changes, etc. and add an ATOM.

16 LIBRARY button

Press this button to open the macro library window.

17 CLEAR button

Opens a window to reset any SECTION to its default value.

Using macros

This section explains how to use macros.

1 Press the **SETUP** button on the menu bar to open the **SETUP** window.

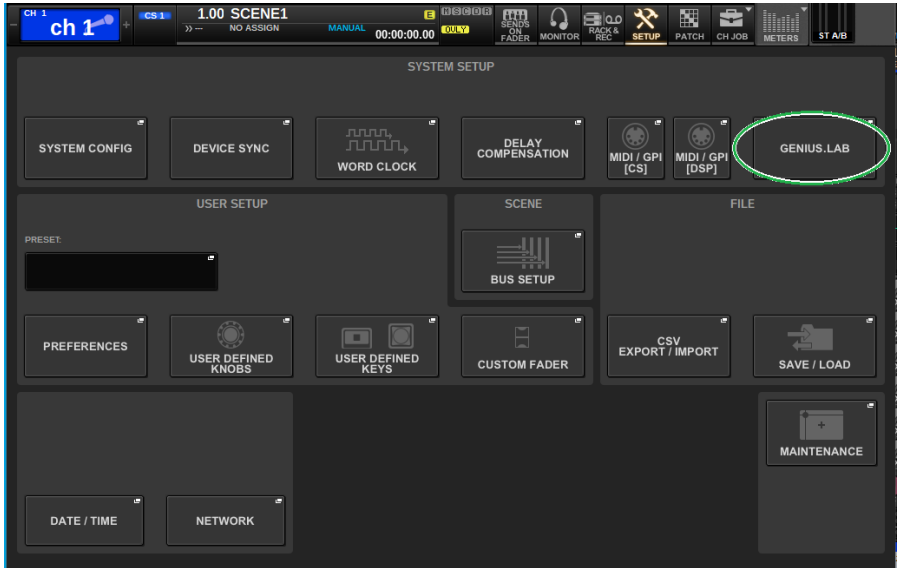

2 Press the GENIUS.LAB button to open the GENIUS.LAB window.

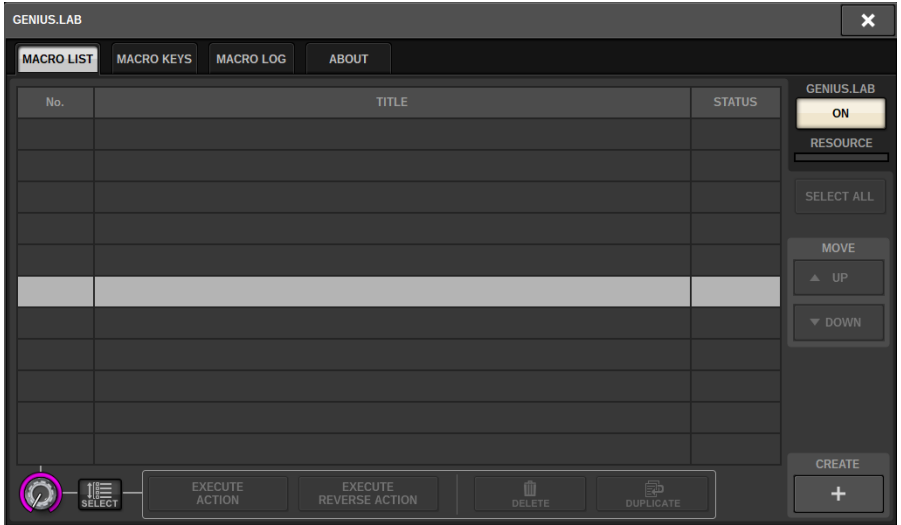

3 Turn the GENIUS.LAB button on.

4 Press the CREATE button and create a macro.

5 Press the macro title button to open the MACRO EDIT window.



6 Press the + button in the TRIGGER section to add an ATOM.

7 Select a CATEGORY.

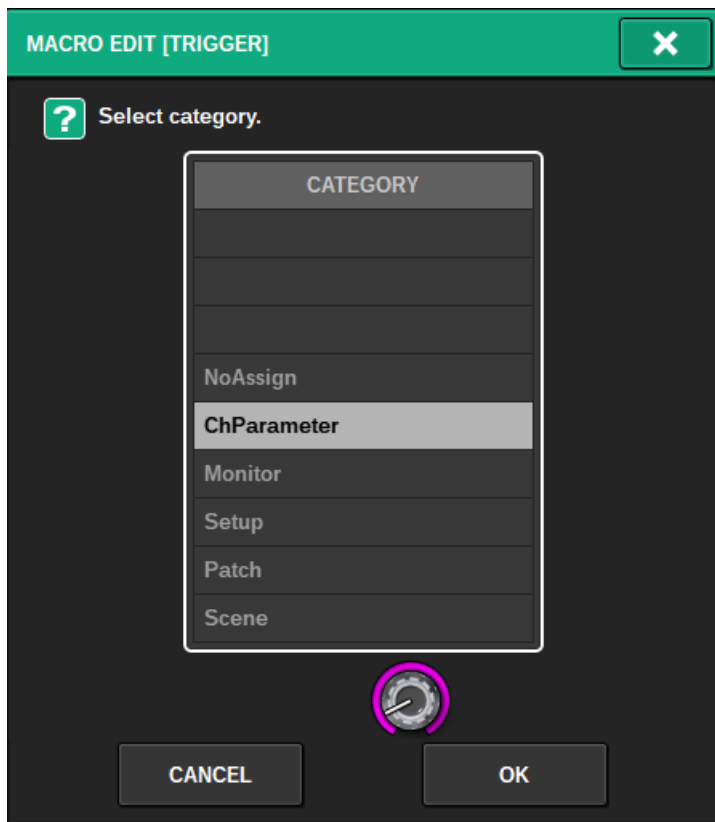

8 Select a FUNCTION.

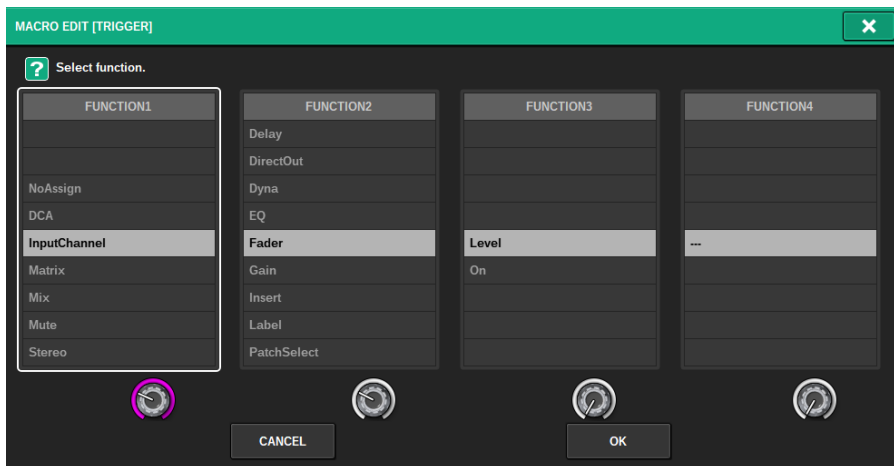

9 Select a PARAMETER.

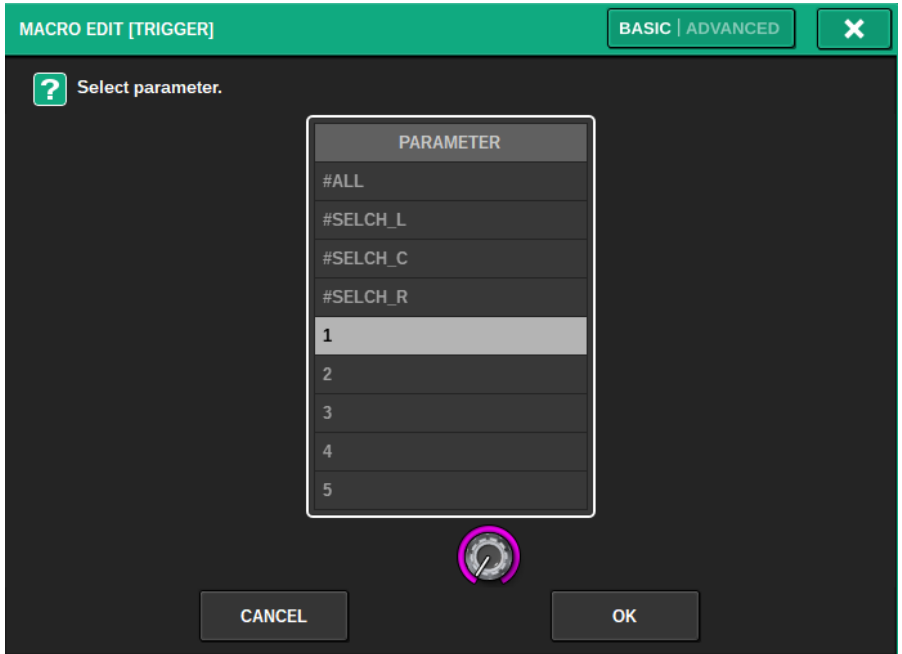

ALL (all parameters) and # SELCH (parameters for the selected channel) can also be selected.

Also, if the **PARAL** button is turned on, individual judgments can be made for that parameter.

For example, in the macro "CH1-4 is turned on when the FADER LEVEL of CH1-4 exceeds -60 dB," the difference in behavior when the channel parameter is set to PARAL off compared to when PARAL on is as follows. When PARAL is off, if the FADER LEVEL of any one of CH 1-4 exceeds -60dB, all of CH 1~4 will be turned on. When PARAL is on, if the FADER LEVEL of any one of CH 1-4 exceeds -60dB, only the channel that exceeds -60dB will be turned on.

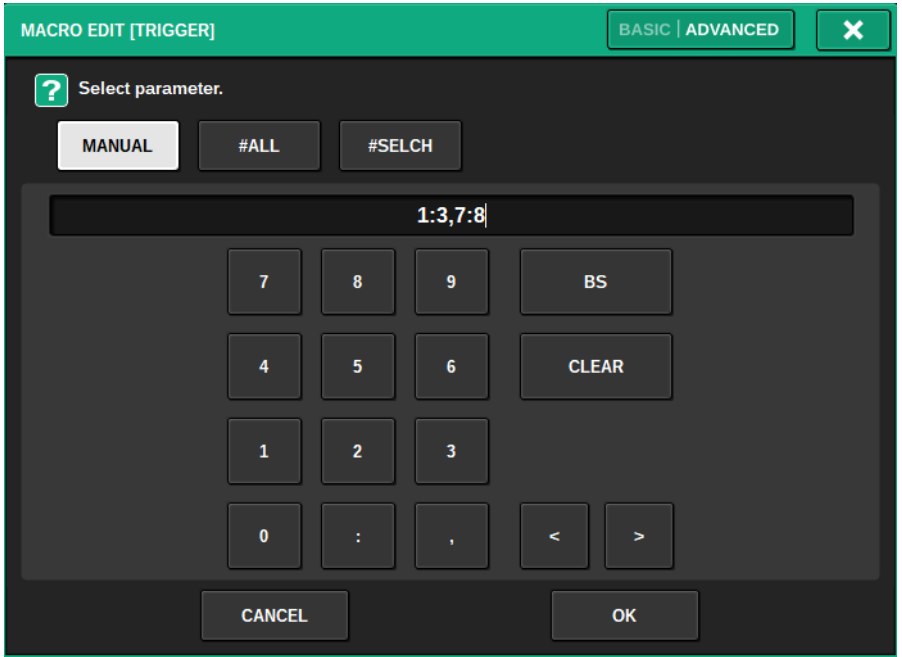

When ADVANCED is set to MANUAL input, a range of values can be specified using a: (colon) and values can be concatenated by separating them with a , (comma).

10 Select an OPERATOR.

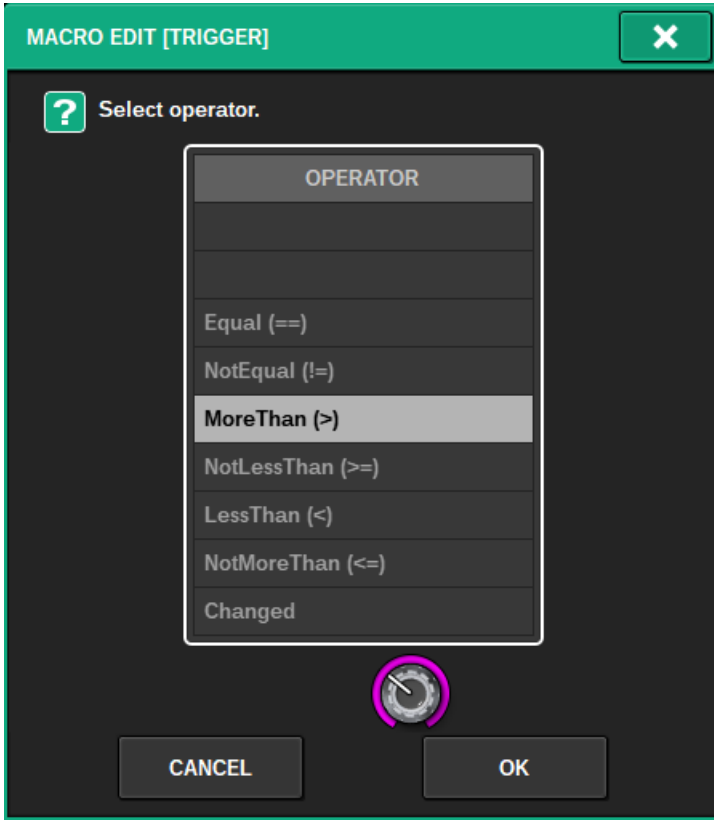

11 Select a VALUE.

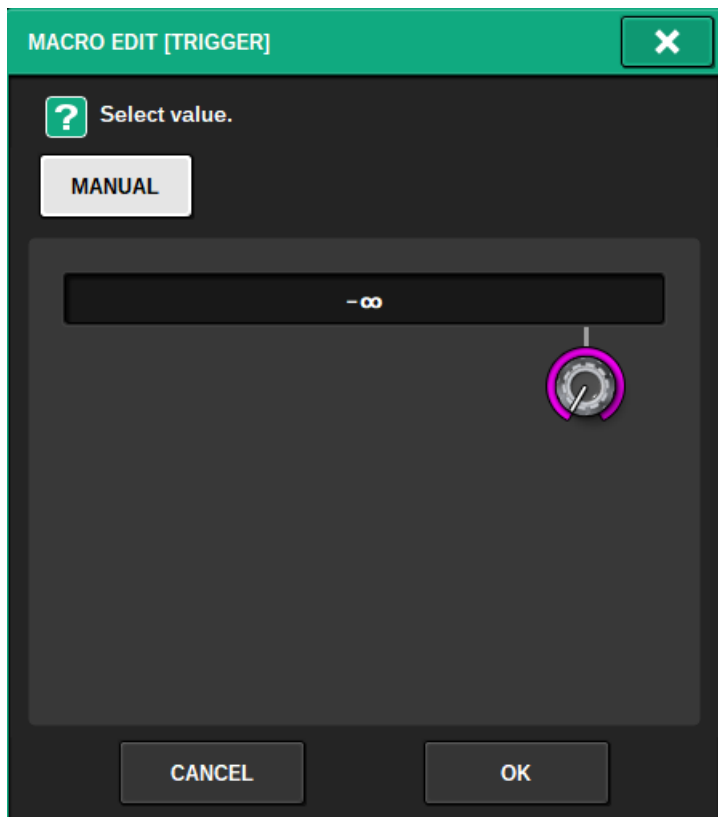

12 When adding an ATOM to a TRIGGER, repeat steps 5 through 10.

13 Set the **CONDITION** section in the same way, as necessary.

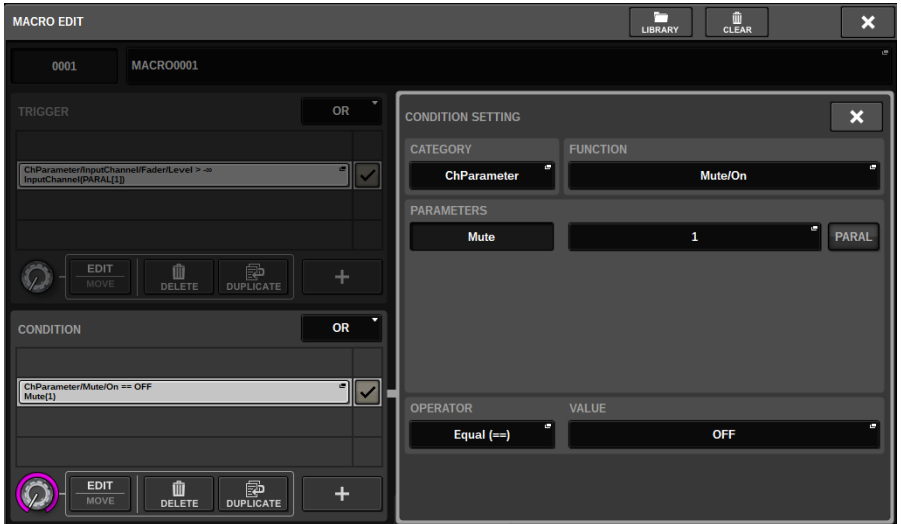

14 Press the + button in the **ACTION** section to add an ATOM.

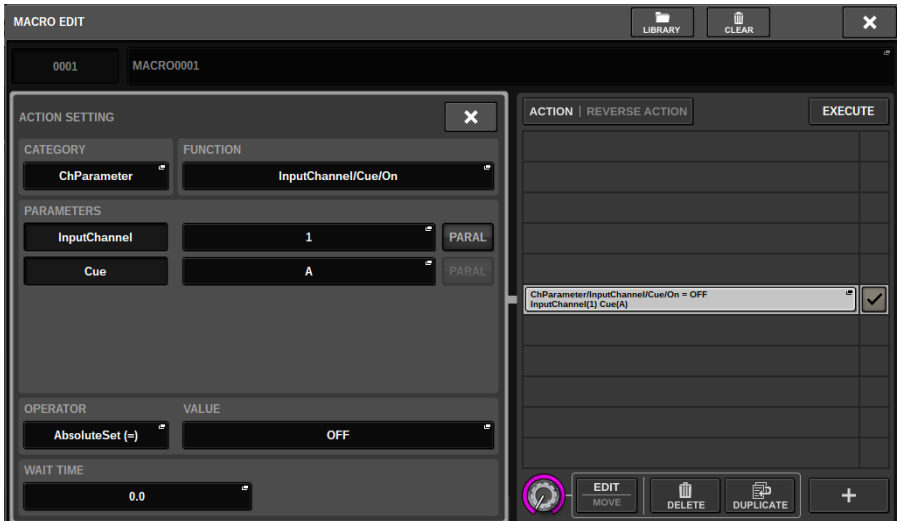

This is set in the same way as the TRIGGER section. WAIT TIME and FADE TIME can also be set as items.

15 ATOMs can also be added using the Capture function.

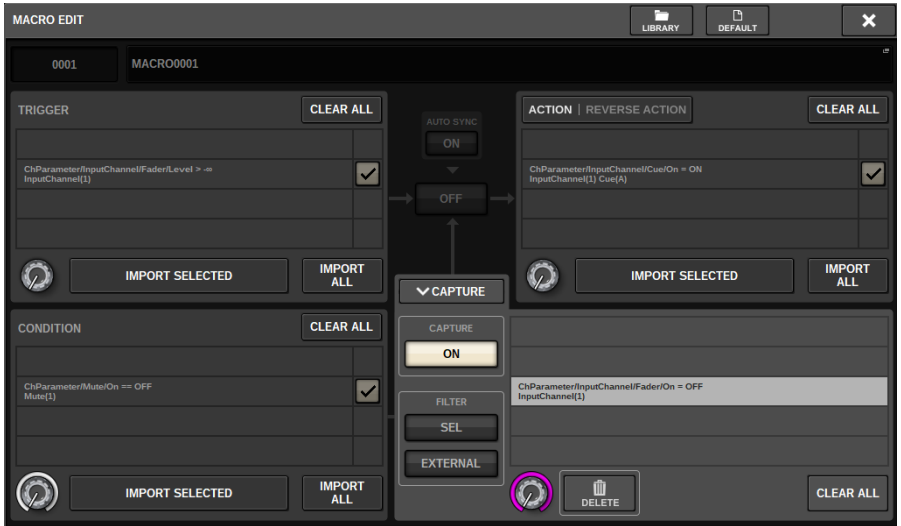

Import a captured ATOM.

16 When the macro setup is completed, turn the STATUS button on.

CAPTURE window

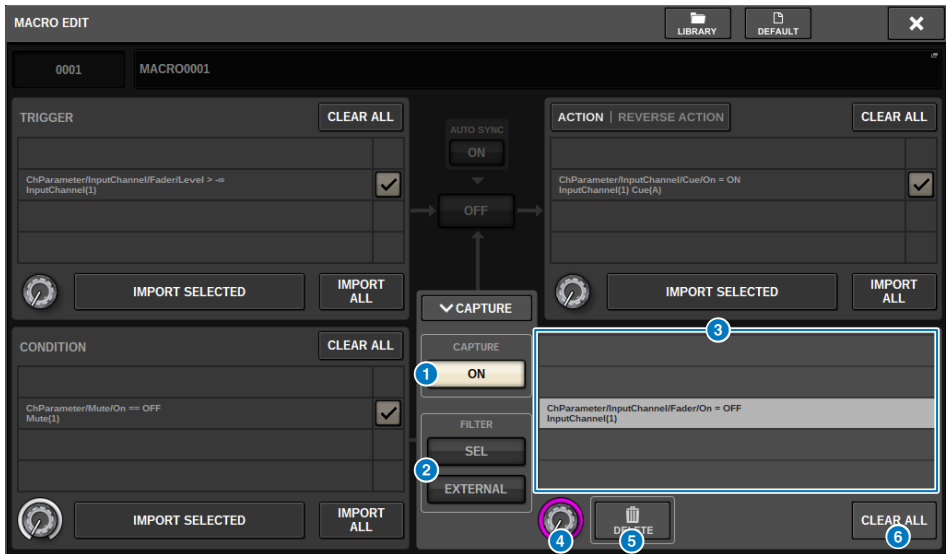

This window contains the following items.

1 CAPTURE ON button

When this is on, ATOMs corresponding to panel and touch screen operation can be captured. When the capture function is on, the SETUP button on the menu bar blinks with a CAPTURE icon.

NOTE

The MACRO EDIT window can be closed while the capture function turned on. Close the MACRO EDIT window to capture operations on any other window or screen. When you want to disable the capture function, return to the CAPTURE window again and turn it off.

2 FILTER

When this is on, certain operations are excluded from capture.

- SEL: Operations related to channel selection and layer selection
- EXTERNAL: External operation/control, such as GPI or MIDI

3 CAPTURE list

The captured ATOMs are displayed.

4 SELECT knob

Use the screen encoder to select an ATOM.

5 DELETE button

Deletes the selected ATOMs that have been captured.

6 CLEAR ALL button

All of the captured ATOMs are cleared.

MACRO KEYS window



This window contains the following items.

- 1 BANK tabs**
Switches between the banks (A/B/C/D) for the MACRO keys.
- 2 Macro keys 1-32**
This is a Genius.lab-specific button that can register the button press state as an ATOM. The label name, color, and PRESS/RELEASE of the key can be registered in the macro ATOM.
- 3 EDIT LABEL button**
When this button is on, press the macro key to switch to the MACRO KEY LABEL window.

MACRO KEY LABEL window



This window contains the following items.

1 MACRO key display

Displays the macro key. Press the + button to switch to the next candidate, or press the - button to switch to the previous candidate.

2 MACRO key display edit box

The functions (TITLE) and comments (LINE1-3) assigned to the macro key can be edited using the keyboard.

3 Color select button

The color of the macro key can be selected.

MACRO LOG window

The log allows you to identify and read about problems and reference information related to the macros.

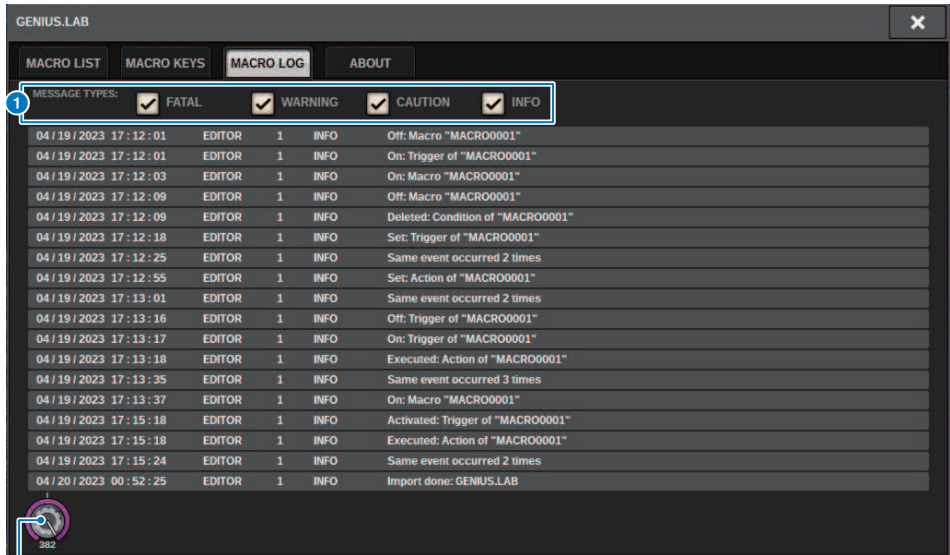

1 MESSAGE TYPES buttons

Allows you to select message types to display or hide on the SYSTEM LOG page. The following message types are included.

FATAL: Information regarding errors, such as malfunctions

WARNING: Information regarding problems that could lead to the unit's malfunction or intermittent audio, which might interrupt operation

CAUTION: Information regarding circumstances that require attention but do not necessarily interrupt operation

INFO: Reference information (such as power-on information) that will not lead to problems

NOTICE

- Message type selection is stored after the power is turned off.

2 Scroll knob

You can scroll the list using the screen encoder.

User Setup

Preference settings

You can make various settings for the RIVAGE PM10's operating environment, such as how popup windows appear, and whether [SEL] key on/off operations will be linked.

1 Press the **SETUP** button on the menu bar to access the **SETUP** screen.



2 Press the **PREFERENCES** button to access the **PREFERENCES** popup window.

This window includes several pages, which you can switch between using the tabs located at the top of the window.

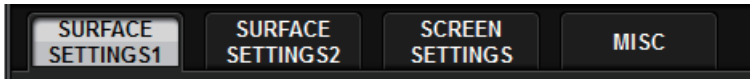

3 Use the buttons on screen to make Preference settings.

4 When you finish making settings, press the **CLOSE** button.

SURFACE SETTINGS1

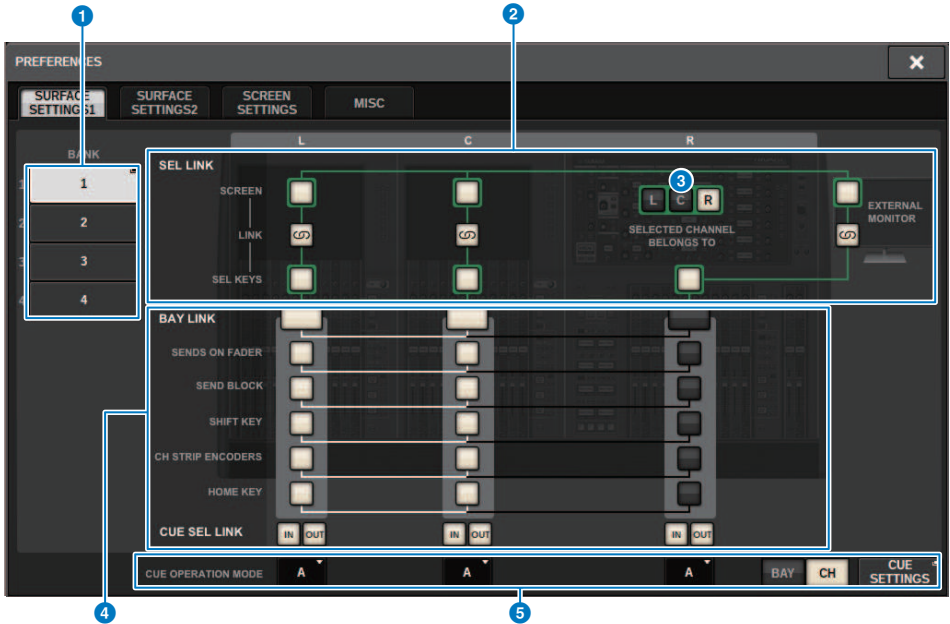

This screen contains the following items.

1 BANK

Selects the bank to which the settings for SurfaceSetting1 parameters (except for CUE SETTINGS) on this screen will be saved. You can save the settings, and call up a bank to switch between settings if desired. Press the selected bank once more to access the window where you can assign a name.

NOTE

You can assign the function to switch banks to USER DEFINED keys.

2 SEL LINK

Allows you to set up links with the SEL between bays on the screen, with the SEL on the screen and the [SEL] keys, and with the [SEL] keys between bays. Linked elements will be indicated in the same color.

3 Selected Channel section selections

In the Selected Channel section, you can operate the selected channels for the bay (screen) you select here.

4 **BAY LINK**

This sets the function for linking between multiple bays. White lines connect the linked bays.

- **BAY LINK:** Selects layer settings for faders, or settings for linked bays.
- **SENDS ON FADER:** SENDS ON FADER on/off and send-destination bus
- **SEND BLOCK:** Selects the 12 buses at the send destination when the OVERVIEW screen is selected
- **SHIFT KEY:** Turns the [SHIFT] key on/off
- **CH STRIP ENCODERS:** Switches the channel strip encoder selection
- **HOME KEY:** Saves and recalls [HOME] key settings
- **CUE→SEL:** Links the cue operations and channel selection

5 **CUE OPERATION MODE field**

Switches between cue's BAY mode and CH mode ("Using the Cue function" (p.419)). In BAY mode, you can select CUE A, CUE B, or CUE A+B for each bay. In CH mode, you can select CUE A, CUE B, or CUE A+B for each channel.

- CUE SETTINGS popup button

Press this button to display the window, in which you can configure the cue for each channel in CH mode ("CUE SETTINGS popup window" (p.426)).

SURFACE SETTINGS2

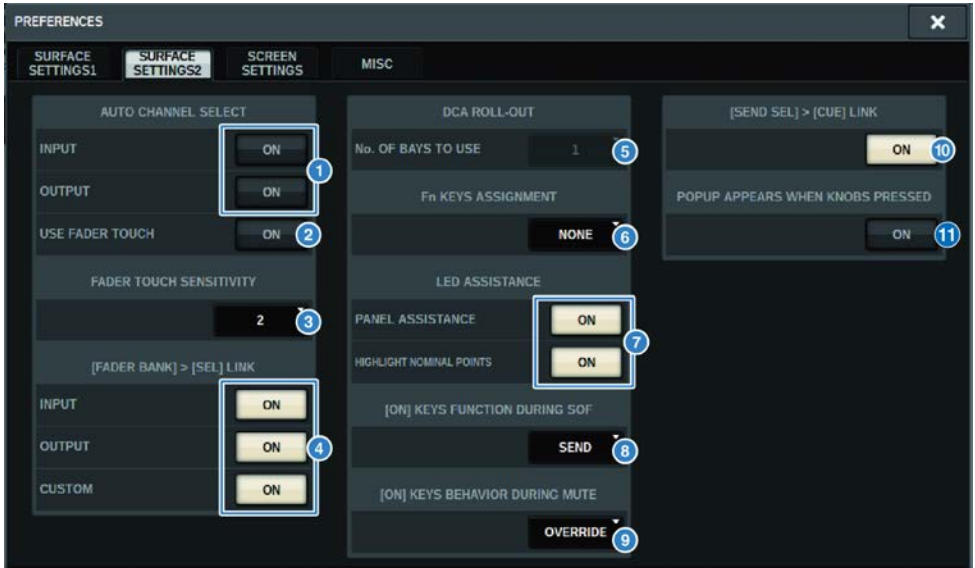

This screen contains the following items.

1 AUTO CHANNEL SELECT field

Specifies whether the corresponding channel will be selected when you operate the [ON] key or fader for the channel. This can be turned on/off separately for input channels and output channels.

2 USE FADER TOUCH

If this ON button is turned on, touching a fader will automatically select the corresponding channel via the Touch Sense function built into the channel fader.

3 FADER TOUCH SENSITIVITY

Touch sensitivity can be adjusted in five steps. Higher values provide greater touch sensitivity.

4 [FADER BANK] > [SEL] LINK

Specifies whether channel selection will be linked with fader bank selection. You can set this parameter separately for INPUT (input channels), OUTPUT (output channels), and CUSTOM (Custom fader bank). If this ON button is lit, and you select the corresponding fader bank, the channel in that bank that was selected most recently will be selected, and its [SEL] key will light. Changing the Bay Link setting will clear the position of the selected channel stored in each layer.

5 DCA ROLL OUT

No. OF BAYS TO USE

Enables you to select whether the DCA will be rolled out to one bay or two.

6 Fn KEYS ASSIGNMENT (CS-R10, CS-R10-S, CSD-R7)

Enables you to select one of the following functions to be assigned to each [Fn] key.

- **NONE**.....No function will be assigned.
- **INPUT A/B**.....Switches between INPUT A and B.
- **ISOLATE**.....Channel Isolate ON/OFF
- **ALTERNATE CUE**.....If the CUE button is set to CUE A, B will be cued. If the CUE button is set to CUE B, A will be cued. Nothing will happen if CUE button is set to A+B.
- **ENCODER PARAM**.....On/Off for parameters related to the channel strip encoders
- **SURROUND CUE**.....Surround Cue ON/OFF
- **GC ON/OFF**..... Gain compensation ON/OFF
- **EQ A/B** Switches EQ parameters A and B
- **DYNAMICS1 A/B** Switches Dynamics 1 parameters A and B
- **DYNAMICS2 A/B** Switches Dynamics 2 parameters A and B
- **VSC ON**..... VSC ON/OFF

7 LED ASSISTANCE

PANEL ASSISTANCE

If this is turned on when the PANEL parameter in the BRIGHTNESS field is set to less than 50%, this will softly light all LED indicators on the panel.

HIGHLIGHT NOMINAL POINTS

If this ON button is lit, the nominal value indication on the panel will be highlighted by the LEDs.

8 [ON] KEYS FUNCTIONS SOF

Selects the operation of the [ON] keys in SENDS ON FADER mode

NOTE

- **SEND** Send on/off
- **CHANNEL** Channel on/off
This is effective when the monitor engineer wishes to continually control the channel on/off, even in SENDS ON FADER mode.

9 [ON] KEYS BEHAVIOR DURING MUTE

Selects the operation of the [ON] keys while muted.

- **OVERRIDE**.....Disabled
- **CHANNEL OFF**.....Enabled

10 [SEND SEL]>[CUE] LINK button

Turns on/off the following of CUE status in SENDS ON FADER mode when switching the main bus.

11 POPUP APPEARS WHEN KNOBS PRESSED button

If this button is turned on, a popup window for the appropriate function will open when you press the knobs in the Selected Channel section on the panel. The touch screen (bay L, C, or R) that will display the popup window depends on which Selected Channel section you select on the SURFACE SETTINGS1 tab.



GAIN KNOB FUNCTION (CS-R5, CS-R3)

The target of the GAIN knob in the Selected Channel section can be selected from ANALOG GAIN, DIGITAL GAIN, and AUTO A.G./D.G. For bays with AUTO A.G./D.G. set, analog gain is displayed for each channel if analog gain is present at the patched port, and digital gain is displayed if it is not present.

SCREEN SETTINGS



This screen contains the following items.

■ SCREEN OPTIONS

1 GAINS SHOWN ON OVERVIEW SCREEN

Enables you to select either ANALOG GAIN, DIGITAL GAIN or AUTO A.G./D.G. for each bay displayed on the OVERVIEW screen.

For bays on which AUTO A.G./D.G. has been set, the analog gain will be shown for each channel on the ports that have been patched where analog gain exists; and if analog gain does not exist, digital gain is shown.

2 PARAMETERS SHOWN ON SoF SCREEN

Enables you to select the parameter displayed on the SENDS ON FADER popup window from FADER LEVEL, SEND PAN, and SEND LEVEL.

3 NAMES

Select a label to be shown, from either the CHANNEL NAME, PORT NAME or address (PORT ADDRESS; example: M1:RY1-1)

■ CONFIRMATION MESSAGES field

4 SCENE MEMORY

Enables you to turn on or off options related to scene store/update/recall operations. If these ON buttons are lit, a confirmation message will appear when you perform a Store, Update, or Recall operation respectively.

5 PATCH

Enables you to turn on or off options related to patch operations.

- **CHANGE**

If this ON button is lit, a confirmation message will appear when you edit an input patch or output patch.

- **STEAL**

If this ON button is lit, a confirmation message will appear when you edit an input or output patch item that is already patched to a port.

6 GLOBAL PASTE

When this is turned on, a confirmation message will be displayed when performing global paste.

■ **ERROR MESSAGES field**

7 DIGITAL I/O

If this button is on and a digital audio I/O error occurs, an error message will be displayed. (Digital audio I/O errors could involve AES/EBU input/output of the control surface, or digital input/output of the RY slot or MY slot).

8 MIDI I/O

If this ON button is lit, an error message will appear when a MIDI transmission/reception error occurs.

9 DANTE ALERT

If this ON button is lit, an error message will appear when Dante error occurs.

■ **CONSOLE/EDITOR field**

10 [OK] WITH ENTER KEY

Turn this on to enable the ENTER key.

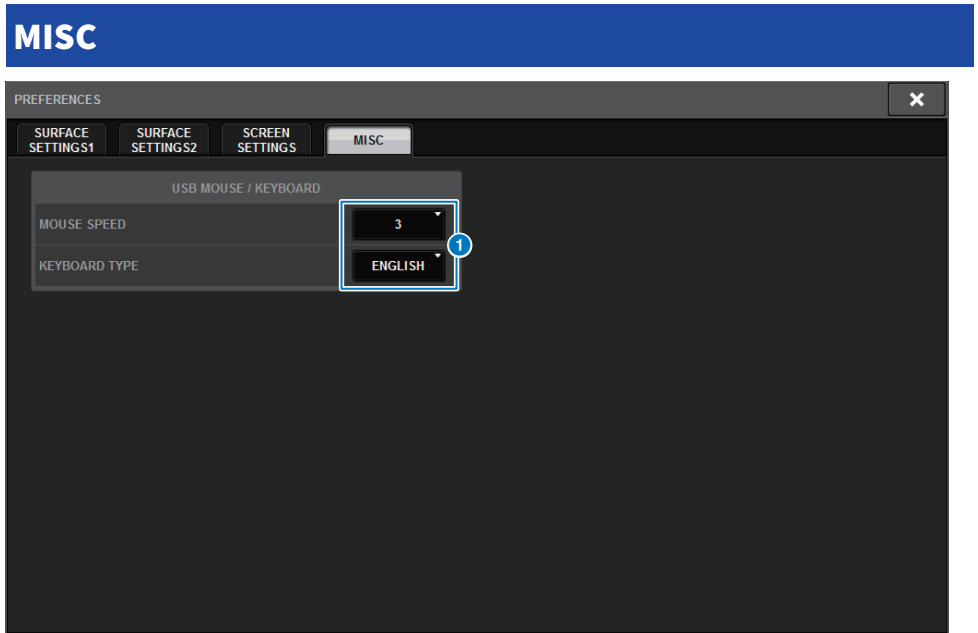

This screen contains the following items.

1 USB MOUSE/KEYBOARD

- **MOUSE SPEED**

Specifies the speed of cursor movement controlled via the USB mouse. The pull-down menu provides five speed options. The higher the value, the faster the speed.

- **USB KEYBOARD TYPE**

Select the USB keyboard type. Options include English, Japanese, German, French, Italian, and Spanish.

Channel Strip section: Using the CUSTOM [1]/[2] keys (CS-R10, CSD-R7)

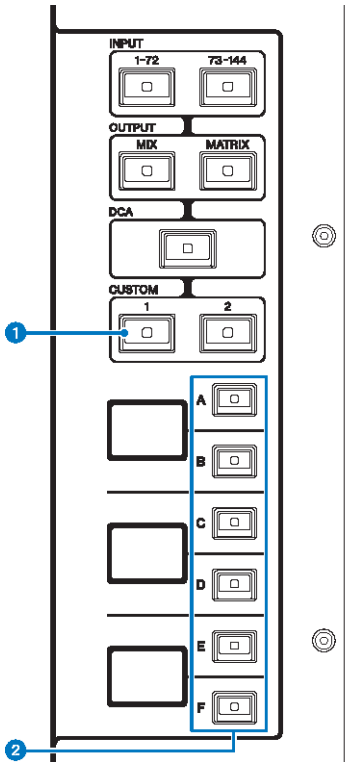

1 CUSTOM [1]/[2] keys

Enable you to select a custom layer. Normally, you can assign custom faders of two banks (total of 12 layers) to each custom layer.

Press CUSTOM [1] and CUSTOM [2] together to enter Custom fader mode, where you can assign custom faders of five banks (total of 60 layers). Use the INPUT [1-72] and [73-144] keys, the [MIX]/[MATRIX] keys, and the [DCA] key to select a Custom bank. Press these two keys simultaneously again to return to normal mode. Press and hold down to lock the Custom fader mode. To unlock the mode, press and hold down again.

2 Layer Select [A]/[B]/[C]/[D]/[E]/[F] keys

Enable you to select a layer.

Channel Strip section: Using the [CUSTOM] keys (CS-R5、CS-R3)

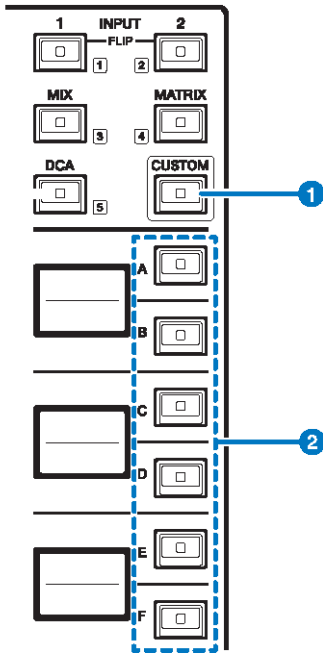

1 [CUSTOM] key

Turns Custom fader mode on or off. Use the INPUT [1]/[2] keys, the [MIX]/[MATRIX] keys, and the [DCA] key to select a Custom bank. The bank numbers (1-5) are labeled adjacent to these keys. Press and hold down to lock the Custom fader mode. To unlock the mode, press and hold down again.

2 Layer Select [A]/[B]/[C]/[D]/[E]/[F] keys

Enable you to select a layer.

Custom fader banks and main faders

A set of channels assigned to the top-panel faders is called a “fader bank.” There are input and output channel banks, as well as custom fader banks. Custom fader banks enable you to select various combinations of channels, regardless of channel types. You can also change the setting of the channels that will be controlled by the two main faders.

1 Press the **SETUP** button on the menu bar to access the **SETUP** screen.

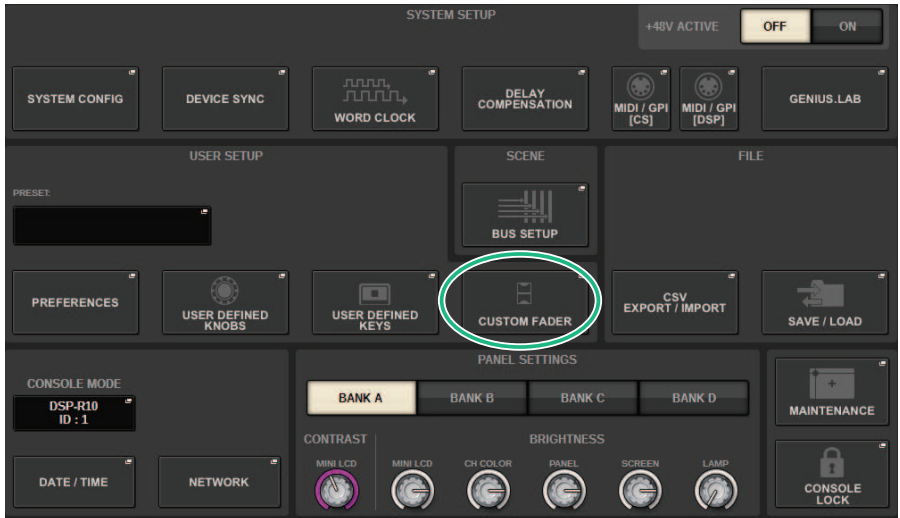

2 Press the **CUSTOM FADER** popup button.

The CUSTOM FADER BANK popup window appears.

NOTE

You can also press any custom fader bank key while holding down and pressing the [SHIFT] key to open the corresponding CUSTOM FADER BANK popup window.

3 Select the target bay or main fader, and the target bank.

4 Press the fader select button for the fader you want to set up.

5 On the top panel, press the [SEL] key of the channel that you want to assign to that fader.

The name of the selected channel will appear on the channel select popup button.

6 To assign channels to other faders, repeat steps 4 and 5.

7 If necessary, select channels by pressing the channel select popup buttons.

CH SELECT popup window

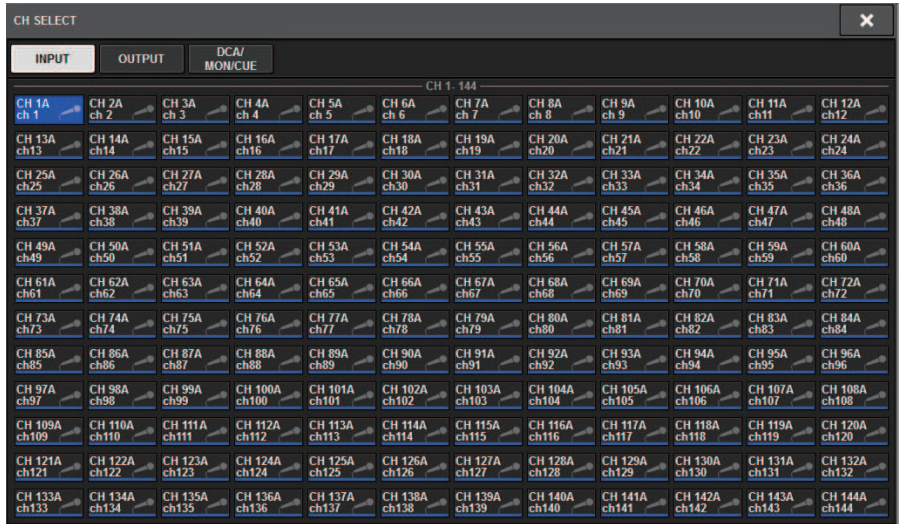

8 From the list, select desired channels.

9 When you finish selecting the channels, press the CLOSE button.

CUSTOM FADER BANK popup window

CUSTOM FADER BANK popup window (when a bay is selected)

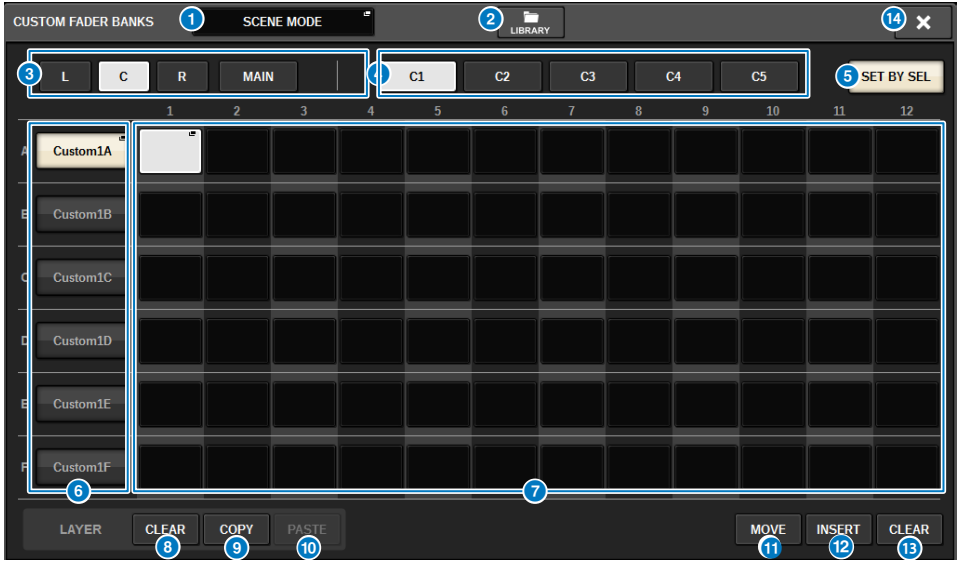

This window contains the following items.

1 Mode select popup button

Displays the custom fader bank mode. Press this button to open a popup window where you can select the mode. Each mode setting is stored as an independent parameter.

- **USER SETUP MODE** Custom fader banks are not included in the scene. They are included in the USER SETUP LIBRARY.
- **SCENE MODE** Custom fader banks are included in the scene. They are not included in the USER SETUP LIBRARY.

2 LIBRARY button

Press this button to open the custom fader bank library window.

3 Bay select buttons

Allows you to select a bay or master faders to which you want to assign a combination of channels.

- **L**Custom for Bay L
- **C**CUSTOM for Bay C
- **R**CUSTOM for Bay R
- **MAIN**Main fader

4 Bank select buttons

allows you to select a block you want to set up.

5 SET BY SEL button

When this is turned on, channels can be assigned to the currently selected fader assign button using the [SEL] key.

6 NAME popup buttons

Press one of these buttons to open the NAME popup window, where you can name the blocks.

7 Fader assign buttons

Select the position where a custom fader will be assigned. Press the selected fader assign button again to open the CH SELECT window for selecting the channel to assign. The assigned channels are also displayed.

8 LAYER CLEAR button

Clears the currently selected layer settings. Pressing this button will open a confirmation dialog box. Press OK to clear the assignment. Otherwise, press CANCEL to return to the previous screen without changing the setting.

9 LAYER COPY button

Copies the selected layer.

10 LAYER PASTE button

Pastes to the selected layer.

11 MOVE button

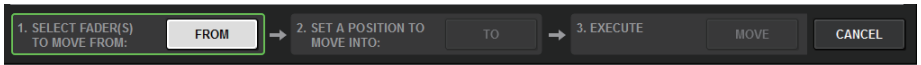

Press this to enter MOVE mode which is used to move a fader block. After selecting what will be moved with the fader assign button, press the TO button. Next, select the fader assign button for the target location and press the MOVE button.

12 INSERT button



Press this to enter INSERT mode which is used to insert a fader block. After selecting the position to be added with the fader assign button, select the number of additions (1-4). Next, press the INSERT button.

13 CLEAR button

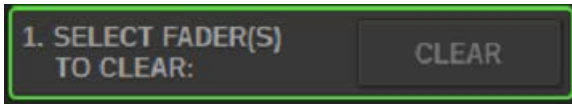

Press this to clear the assigned faders (no assignment).

Press this to enter CLEAR mode which is used to erase fader blocks. After selecting the bank to be deleted with the fader assign button, press the CLEAR button.

14 CLOSE button

Press this button to close the popup window and return to the previous screen.

NOTE

CUSTOM FADER settings can be saved in the user setup. The added parameters are the CUSTOM FADER bank label and assigned channels.

USER DEFINED KNOBS section

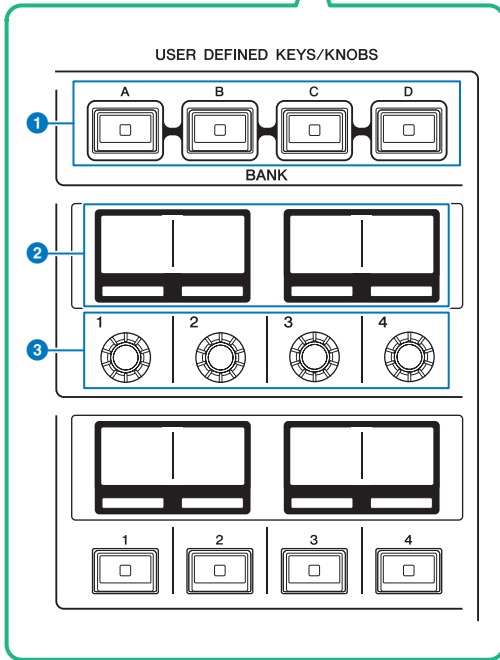
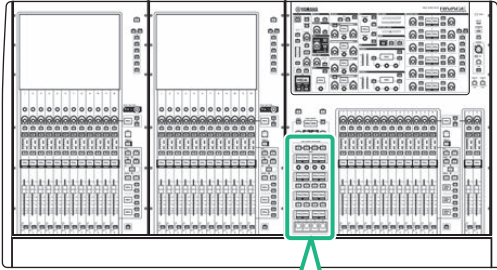

1 USER DEFINED [A]/[B]/[C]/[D] BANK keys

Select the bank ([A], [B], [C], or [D]) for the USER DEFINED knobs or USER DEFINED keys.

2 USER DEFINED KNOBS displays

Indicate the functions assigned to the USER DEFINED knobs.

3 USER DEFINED KNOBS [1]/[2]/[3]/[4]

Control the functions as assigned by the user.

Assigning a function to a USER DEFINED knob

- 1 Press the **SETUP** button on the menu bar to access the **SETUP** screen.

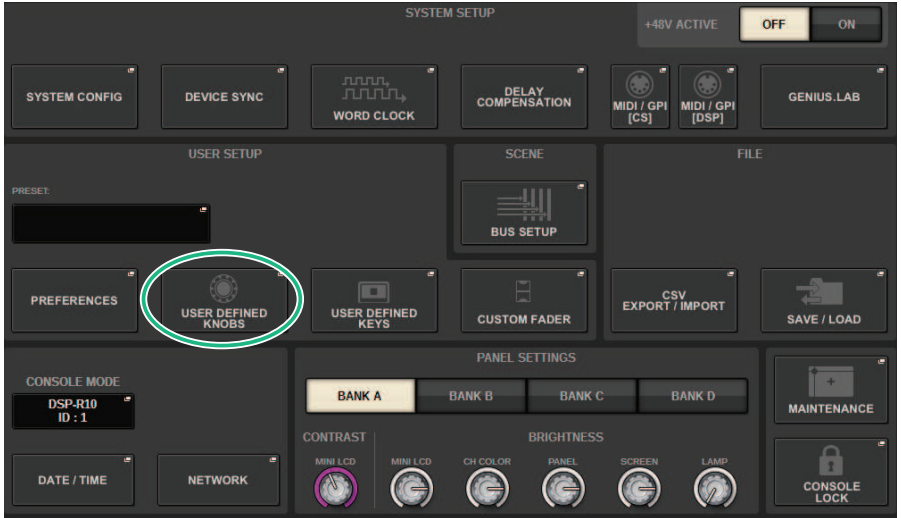

- 2 Press the **USER DEFINED KNOBS** button.

The “USER DEFINED KNOBS popup window” (p.937) appears.

3 Press the button corresponding to the USER DEFINED knob to which you want to assign a function.

The system displays a popup window, in which you can assign a function to the USER DEFINED knob.

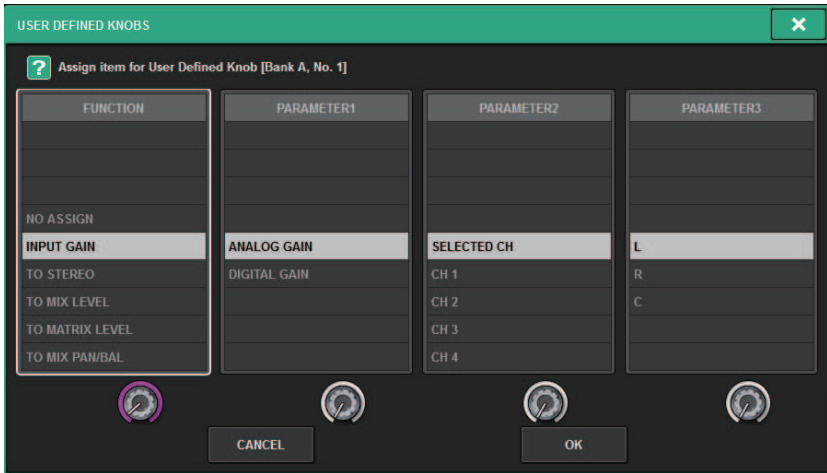

4 Make sure that the FUNCTION field is enclosed by a frame, and then use the screen encoder on the panel to select the function that you want to assign.

For details on the assignable functions and their parameters, refer to the data list.

5 If the selected function features parameters, specify the type of parameter you want to assign by selecting in the following order: PARAMETER1 field -> PARAMETER2 field -> PARAMETER3 field.

6 Press the OK button to close the popup window.

7 Assign the desired functions to other USER DEFINED knobs in the same way.

USER DEFINED KNOBS popup window



This screen contains the following items.

1 BANK A-D tabs

Enable you to select the bank ([A], [B], [C], or [D]) for the USER DEFINED knobs.

2 USER DEFINED KNOBS 1-4

Link to USER DEFINED knobs [1]-[4] on the panel. Press one of these buttons to access the USER DEFINED KNOBS SETUP popup window, in which you can assign a function to the selected button. If nothing is assigned to the button, an indication of “NO ASSIGN” is shown.

Functions that can be assigned to the USER DEFINED knobs

The functions that can be assigned to the USER DEFINED knobs are as follows.

Function	PARAMETER1	PARAMETER2	PARAMETER3
NO ASSIGN	---	---	---
INPUT GAIN	ANALOG GAIN	SELECTED CH	BAY L, BAY R, BAY C
		CH 1-288	---
	DIGITAL GAIN	SELECTED CH	BAY L, BAY R, BAY C
		CH 1-288、 MIX1-72	---
TO STEREO	PAN/BAL	SELECTED CH	BAY L, BAY R, BAY C
		CH 1-288、 MIX1-72	---
	CSR	SELECTED CH	BAY L, BAY R, BAY C
		CH 1-288	---
TO MIX LEVEL	MIX 1-72	SELECTED CH	BAY L, BAY R, BAY C
		CH 1-288	---
TO MATRIX LEVEL	MATRIX 1-36	SELECTED CH	BAY L, BAY R, BAY C
		CH 1-288、 MIX1-72	---
TO MIX PAN/BAL	MIX 1-72	SELECTED CH	BAY L, BAY R, BAY C
		CH 1-288	---
TO MATRIX PAN/BAL	MATRIX 1-36	SELECTED CH	BAY L, BAY R, BAY C
		CH 1-288、 MIX1-72	---
DYNAMICS 1	THRESHOLD	SELECTED CH	BAY L, BAY R, BAY C
		CH1-288, MIX 1-72, MATRIX 1-36, STEREO AL, STEREO AR, STEREO BL, STEREO BR	---
	RANGE	SELECTED CH	BAY L, BAY R, BAY C
		CH1-288, MIX 1-72, MATRIX 1-36, STEREO AL, STEREO AR, STEREO BL, STEREO BR	---
	RATIO	SELECTED CH	BAY L, BAY R, BAY C
		CH1-288, MIX 1-72, MATRIX 1-36, STEREO AL, STEREO AR, STEREO BL, STEREO BR	---
	FREQUENCY	SELECTED CH	BAY L, BAY R, BAY C
		CH1-288, MIX 1-72, MATRIX 1-36, STEREO AL, STEREO AR, STEREO BL, STEREO BR	---
	ATTACK	SELECTED CH	BAY L, BAY R, BAY C
		CH1-288, MIX 1-72, MATRIX 1-36, STEREO AL, STEREO AR, STEREO BL, STEREO BR	---
HOLD		SELECTED CH	BAY L, BAY R, BAY C

User Setup > Functions that can be assigned to the USER DEFINED knobs

Function	PARAMETER1	PARAMETER2	PARAMETER3	
DYNAMICS 1	HOLD	CH1-288, MIX 1-72, MATRIX 1-36, STEREO AL, STEREO AR, --- STEREO BL, STEREO BR		
		SELECTED CH	BAY L, BAY R, BAY C	
	DECAY	CH1-288, MIX 1-72, MATRIX 1-36, STEREO AL, STEREO AR, --- STEREO BL, STEREO BR		
		SELECTED CH	BAY L, BAY R, BAY C	
	RELEASE	CH1-288, MIX 1-72, MATRIX 1-36, STEREO AL, STEREO AR, --- STEREO BL, STEREO BR		
		SELECTED CH	BAY L, BAY R, BAY C	
	OUTGAIN	CH1-288, MIX 1-72, MATRIX 1-36, STEREO AL, STEREO AR, --- STEREO BL, STEREO BR		
		SELECTED CH	BAY L, BAY R, BAY C	
	KNEE	CH1-288, MIX 1-72, MATRIX 1-36, STEREO AL, STEREO AR, --- STEREO BL, STEREO BR		
		SELECTED CH	BAY L, BAY R, BAY C	
	TYPE	CH1-288, MIX 1-72, MATRIX 1-36, STEREO AL, STEREO AR, --- STEREO BL, STEREO BR		
		SELECTED CH	BAY L, BAY R, BAY C	
	Q	CH1-288, MIX 1-72, MATRIX 1-36, STEREO AL, STEREO AR, --- STEREO BL, STEREO BR		
		SELECTED CH	BAY L, BAY R, BAY C	
	INPUT	MIX 1-72, MATRIX 1-36, STEREO AL, STEREO AR, STEREO BL, STEREO BR		---
		SELECTED CH	BAY L, BAY R, BAY C	
OUTPUT	MIX 1-72, MATRIX 1-36, STEREO AL, STEREO AR, STEREO BL, STEREO BR		---	
	SELECTED CH	BAY L, BAY R, BAY C		
RECOVERY	MIX 1-72, MATRIX 1-36, STEREO AL, STEREO AR, STEREO BL, STEREO BR		---	
	SELECTED CH	BAY L, BAY R, BAY C		
MIX BALANCE	CH1-288, MIX 1-72, MATRIX 1-36, STEREO AL, STEREO AR, --- STEREO BL, STEREO BR			
	SELECTED CH	BAY L, BAY R, BAY C		
DYNAMICS 2	THRESHOLD	SELECTED CH	BAY L, BAY R, BAY C	
		CH1-288	---	
	RANGE	SELECTED CH	BAY L, BAY R, BAY C	
		CH1-288	---	

User Setup > Functions that can be assigned to the USER DEFINED knobs

Function	PARAMETER1	PARAMETER2	PARAMETER3
DYNAMICS 2	RATIO	SELECTED CH	BAY L, BAY R, BAY C
		CH1-288	---
	FREQUENCY	SELECTED CH	BAY L, BAY R, BAY C
		CH1-288	---
	ATTACK	SELECTED CH	BAY L, BAY R, BAY C
		CH1-288	---
	HOLD	SELECTED CH	BAY L, BAY R, BAY C
		CH1-288	---
	DECAY	SELECTED CH	BAY L, BAY R, BAY C
		CH1-288	---
	RELEASE	SELECTED CH	BAY L, BAY R, BAY C
		CH1-288	---
	OUTGAIN	SELECTED CH	BAY L, BAY R, BAY C
		CH1-288	---
	KNEE	SELECTED CH	BAY L, BAY R, BAY C
		CH1-288	---
	TYPE	SELECTED CH	BAY L, BAY R, BAY C
		CH1-288	---
Q	SELECTED CH	BAY L, BAY R, BAY C	
	CH1-288	---	
INPUT	SELECTED CH	BAY L, BAY R, BAY C	
	OUTPUT	---	
OUTPUT	SELECTED CH	BAY L, BAY R, BAY C	
	CH1-288	---	
RECOVERY	SELECTED CH	BAY L, BAY R, BAY C	
	CH1-288	---	
MIX BALANCE	SELECTED CH	BAY L, BAY R, BAY C	
	CH1-288, MIX 1-72, MATRIX 1-36, STEREO AL, STEREO AR, STEREO BL, STEREO BR	---	
DELAY	SELECTED CH	BAY L, BAY R, BAY C	
	CH1-288, MIX 1-72, MATRIX 1-36, STEREO AL, STEREO AR, STEREO BL, STEREO BR	---	
EQ	BAND1-4 Q	SELECTED CH	BAY L, BAY R, BAY C
		CH1-288, MIX 1-72, MATRIX 1-36, STEREO AL, STEREO AR, STEREO BL, STEREO BR	---
	BAND5-8 Q	SELECTED CH	BAY L, BAY R, BAY C
		MIX 1-72, MATRIX 1-36, STEREO AL, STEREO AR, STEREO BL, STEREO BR	---
BAND1-4 FREQUENCY	SELECTED CH	BAY L, BAY R, BAY C	

User Setup > Functions that can be assigned to the USER DEFINED knobs

Function	PARAMETER1	PARAMETER2	PARAMETER3	
EQ	BAND1-4 FREQUENCY	CH1-288, MIX 1-72, MATRIX 1-36, STEREO AL, STEREO AR, STEREO BL, STEREO BR	---	
		SELECTED CH	BAY L, BAY R, BAY C	
	BAND5-8 FREQUENCY	MIX 1-72, MATRIX 1-36, STEREO AL, STEREO AR, STEREO BL, STEREO BR	---	---
		SELECTED CH	BAY L, BAY R, BAY C	---
	BAND1-4 GAIN	CH1-288, MIX 1-72, MATRIX 1-36, STEREO AL, STEREO AR, STEREO BL, STEREO BR	---	---
		SELECTED CH	BAY L, BAY R, BAY C	---
BAND5-8 GAIN	MIX 1-72, MATRIX 1-36, STEREO AL, STEREO AR, STEREO BL, STEREO BR	---	---	
	SELECTED CH	BAY L, BAY R, BAY C	---	
FILTER	HPF FREQ	CH1-288, MIX 1-72, MATRIX 1-36, STEREO AL, STEREO AR, STEREO BL, STEREO BR	---	
		SELECTED CH	BAY L, BAY R, BAY C	
	HPF FREQ	CH1-288, MIX 1-72, MATRIX 1-36, STEREO AL, STEREO AR, STEREO BL, STEREO BR	---	---
		SELECTED CH	BAY L, BAY R, BAY C	---
BRIGHTNESS*	LAMP		---	
	PANEL		---	
	SCREEN		---	
	CH COLOR		---	
	NAME		---	
CUE	CUE A	INPUT PFL TRIM	---	
		DCA TRIM	---	
		OUTPUT PFL TRIM	---	
		CUE LEVEL	---	
	CUE B	INPUT PFL TRIM	---	
		DCA TRIM	---	
		OUTPUT PFL TRIM	---	
		CUE LEVEL	---	
MONITOR	COMMON	DIMMER LEVEL	---	
		TALKBACK DIMMER LEVEL	---	
	MONITOR A	DELAY	---	
		FADER	---	
	MONITOR B	DELAY	---	
		FADER	---	
	SURROUND MONITOR	DIMMER LEVEL	---	
		TALKBACK DIMMER LEVEL	---	

User Setup > Functions that can be assigned to the USER DEFINED knobs

Function	PARAMETER1	PARAMETER2	PARAMETER3
OSCILLATOR	LEVEL		---
	SINE2 LEVEL		---
	SINE1 FREQUENCY		---
	SINE2 FREQUENCY		---
AUTOMIXER	WEIGHT	AUTOMIXER CH1-64	---
CH FADER	SPECIFIC CH	CH	CH 1-288
		MIX	MIX 1-72
		MATRIX	MATRIX 1-36
		STEREO	STEREO A-B
		DCA	DCA 1-24

*Cannot be assigned to the PM Editor USER DEFINED knobs.

On the CSD-R7, disabled channels are shown with strikethrough text.

Channel Strip section

■ CS-R10、CS-R10-S、CSD-R7

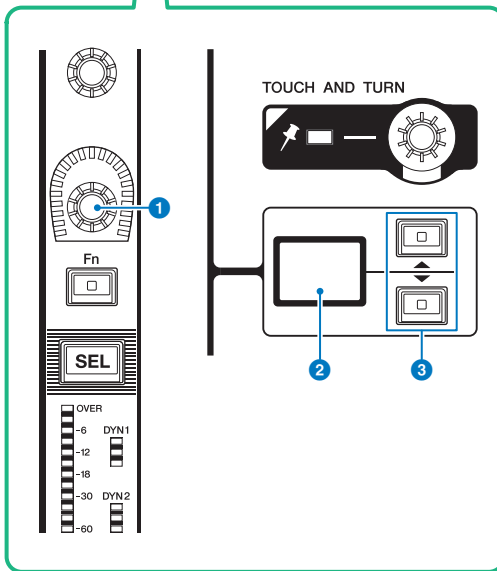
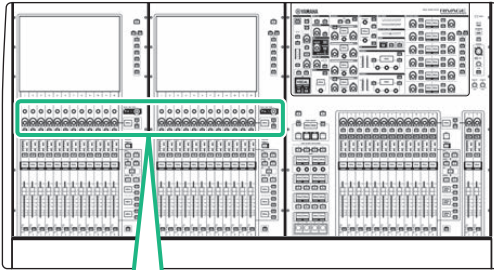

1 Channel strip encoder

Adjusts the gain, pan, and the other parameters of the channel.

2 Channel strip encoder display

Indicates the function that has been assigned to the channel strip encoder.

3 UP/DOWN keys

Enable you to select the function that you want to control using the channel strip encoder.

■ CS-R5

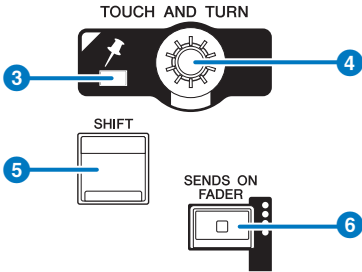
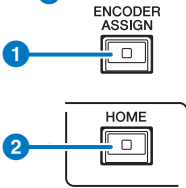
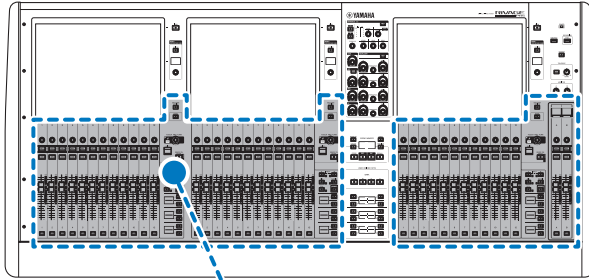

■ CS-R3

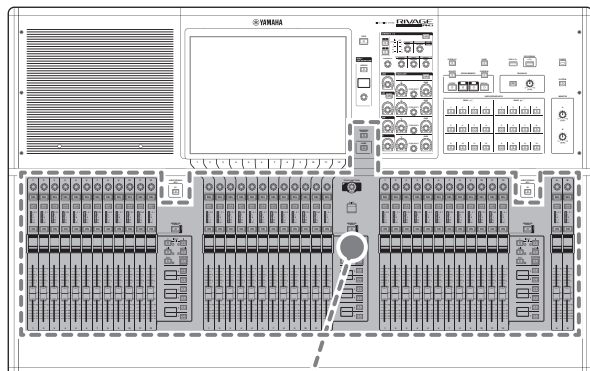

ENCODER
ASSIGN

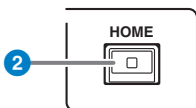

TOUCH AND TURN



SHIFT



SENDS ON
FADER



1 **[ENCODER ASSIGN] key**

Displays a screen that enables you to switch between the Screen Encoder function and the Channel Encoder function. You can use only the Channel Encoder function for channel strips A and B.

Assigning a function to a channel strip encoder

- 1 Press the **SETUP** button on the menu bar to access the **SETUP** screen.

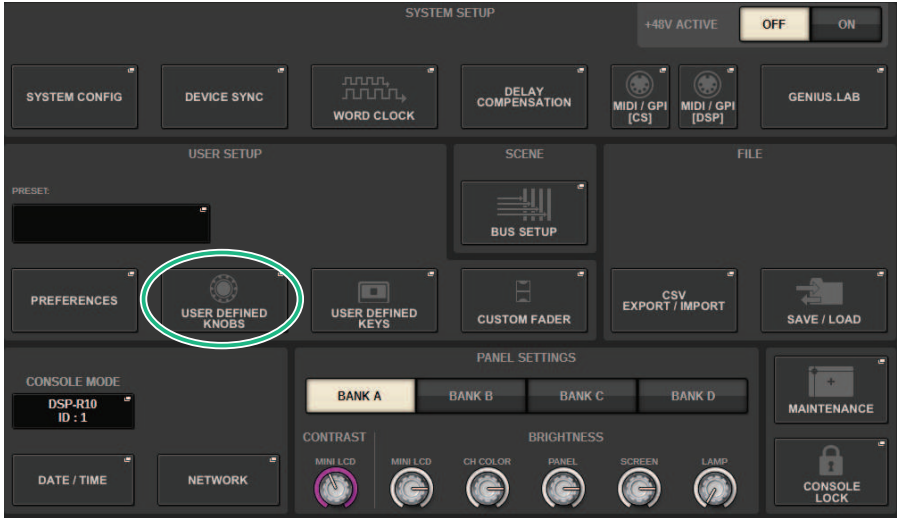

- 2 Press the **USER DEFINED KNOBS** button to access the **USER DEFINED KNOBS** popup window.

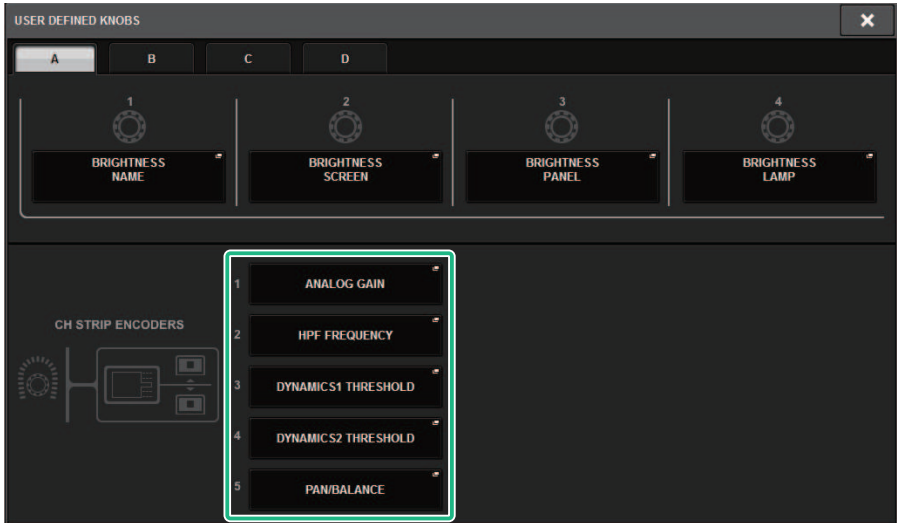

3 Press a button in the CH STRIP ENCODERS field to open the CH STRIP ENCODERS popup window.

4 Use the screen encoder to select the function that you want to assign.

You can assign the following functions:

- PAN/BALANCE
- ANALOG GAIN
- DIGITAL GAIN
- AUTO A.G./D.G.
- SELECTED SEND
- MIX 1–72 SEND
- MATRIX 1–36 SEND
- HPF FREQUENCY
- LPF FREQUENCY
- DYNAMICS1 THRESHOLD
- DYNAMICS2 THRESHOLD
- DELAY
- SILK TEXTURE
- SURROUND L-R PAN
- SURROUND F-R PAN
- SURROUND DIV
- SURROUND LFE

5 Press the OK button to close the CH STRIP ENCODERS popup window.

6 Use the UP [U@]/DOWN [D@] keys on the top panel to select the function. (CS-R10, CS-R10-S, CSD-R7)

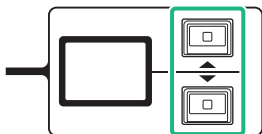

User Setup > Assigning a function to a channel strip encoder

Press the [ENCODER ASSIGN] key to access the ENCODER ASSIGN popup window and select a function. (CS-R5)

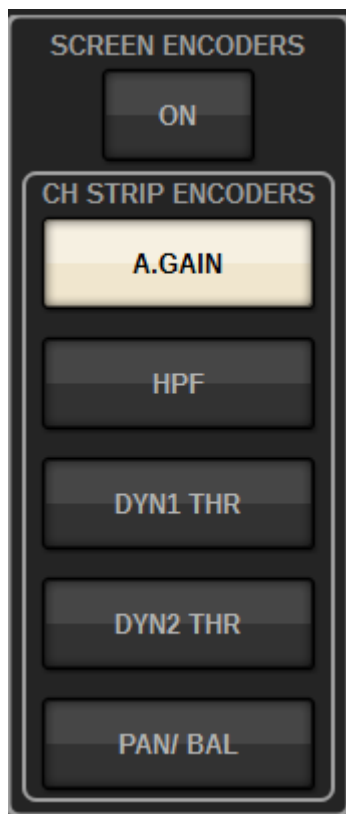

Using the USER DEFINED keys section (CS-R10, CSD-R7)

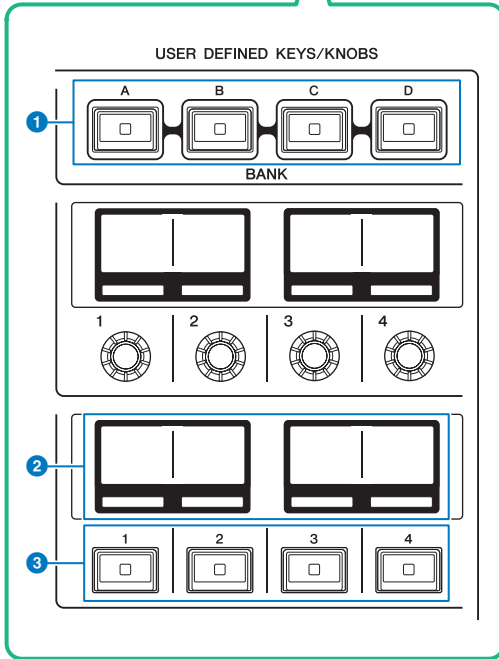
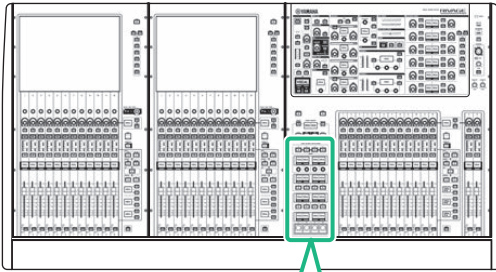

- 1 USER DEFINED KEYS BANK [A]/[B]/[C]/[D] keys**
Switches between USER DEFINED key banks ([A], [B], [C], or [D]).
- 2 USER DEFINED KEYS displays**
Indicate the functions assigned to the USER DEFINED keys.
- 3 USER DEFINED KEYS [1]-[12] keys**
Control the functions as assigned by the user.

Using the USER DEFINED keys section (CS-R5, CS-R3)

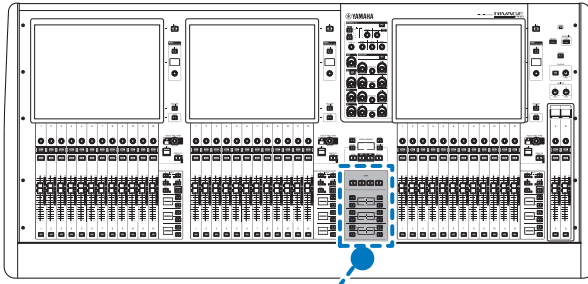

USER DEFINED KEYS

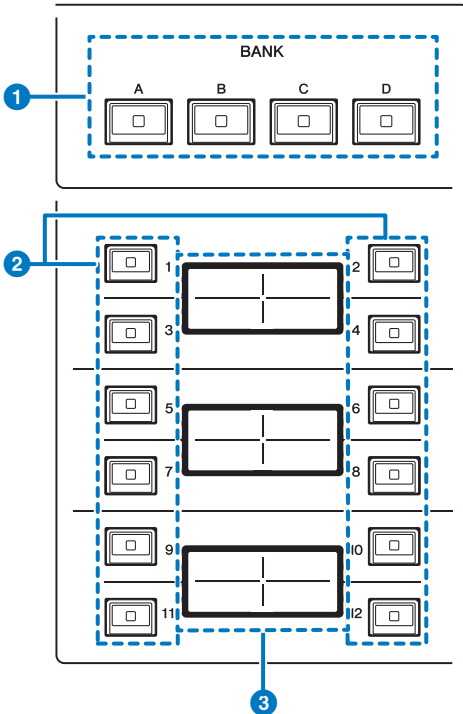

1 USER DEFINED KEYS BANK [A]/[B]/[C]/[D] keys

Switches between USER DEFINED key banks ([A], [B], [C], or [D]).

2 USER DEFINED KEYS [1]-[12] keys

Control the functions as assigned by the user.

User Setup > Using the USER DEFINED keys section (CS-R5, CS-R3)

3 USER DEFINED KEYS displays

Indicate the functions assigned to the USER DEFINED keys.

■ CS-R3

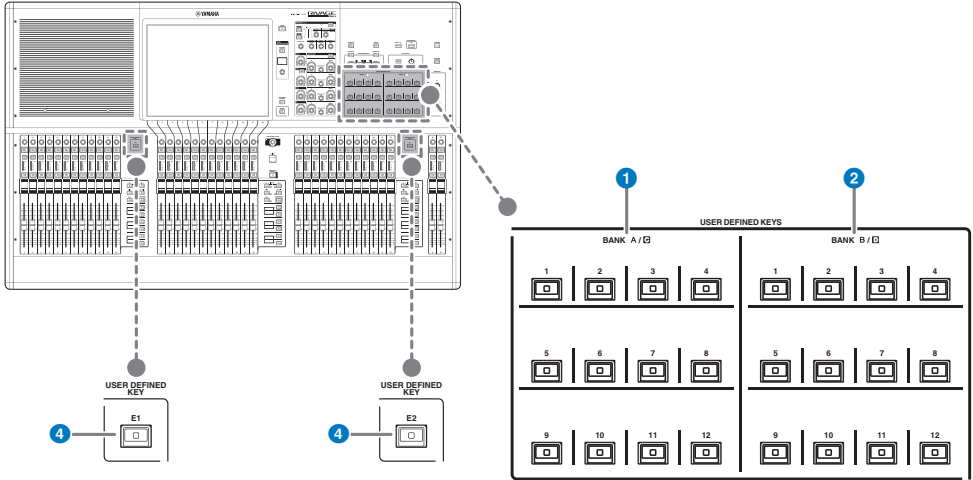

- 1 **USER DEFINED keys BANK A/C [1]-[12]**
- 2 **USER DEFINED keys BANK B/D [1]-[12]**
- 4 **USER DEFINED keys [E1]/[E2]**

Control the functions as assigned by the user.

NOTE

You can assign the function to switch between banks A-B and C-D to a USER DEFINED key.

Assigning a function to a USER DEFINED key

- 1 Press the SETUP button on the menu bar to access the SETUP screen.**



- 2 Press the USER DEFINED KEYS button.**

The “USER DEFINED KEYS popup window” (p.955) appears.

- 3 Press the button corresponding to the USER DEFINED key to which you want to assign a function.**

The system displays a popup window, in which you can assign a function to the USER DEFINED key.

- 4 Make sure that the FUNCTION field is enclosed by a frame, and then use the screen encoder on the panel to select the function you want to assign.**

For details on the assignable functions and their parameters, refer to the data list.

- 5 If the selected function features parameters, specify the type of parameter you want to assign by selecting in the following order: PARAMETER1 field -> PARAMETER2 field -> PARAMETER3 field.**

- 6 Press the OK button to close the USER DEFINED KEYS SETUP popup window.**

- 7 Assign the desired functions to other USER DEFINED keys in the same way.**

Modifying the contents displayed for the USER DEFINED keys

- 1 Press the SETUP button on the menu bar to access the SETUP screen.**

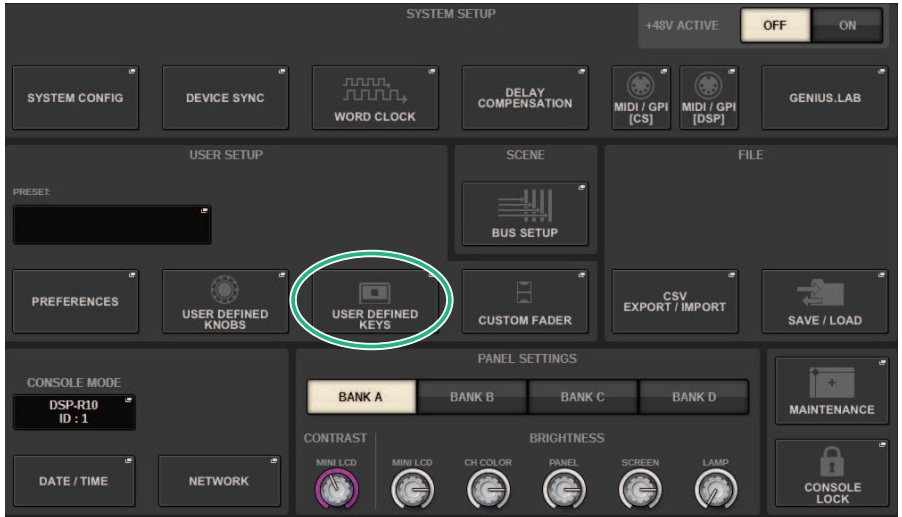

- 2 Press the USER DEFINED KEYS button.**

The “USER DEFINED KEYS popup window” (p.955) appears.
- 3 Press the LABEL tab.**
- 4 Press the button corresponding to the USER DEFINED key for which you want to change the contents displayed.**
- 5 The “USER DEFINED KEY LABEL popup window (CS-R10, CSD-R7)” (p.958) and USER DEFINED KEYS LABEL popup window (CS-R5) will be displayed.**
- 6 Edit the displayed contents as needed.**

USER DEFINED KEYS popup window

■ CS-R10、CSD-R7

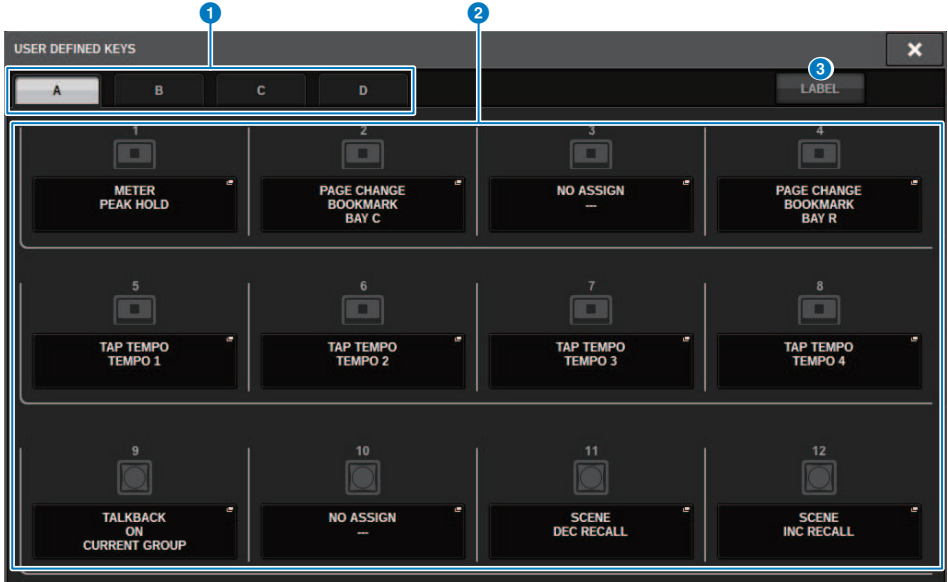

CS-R5

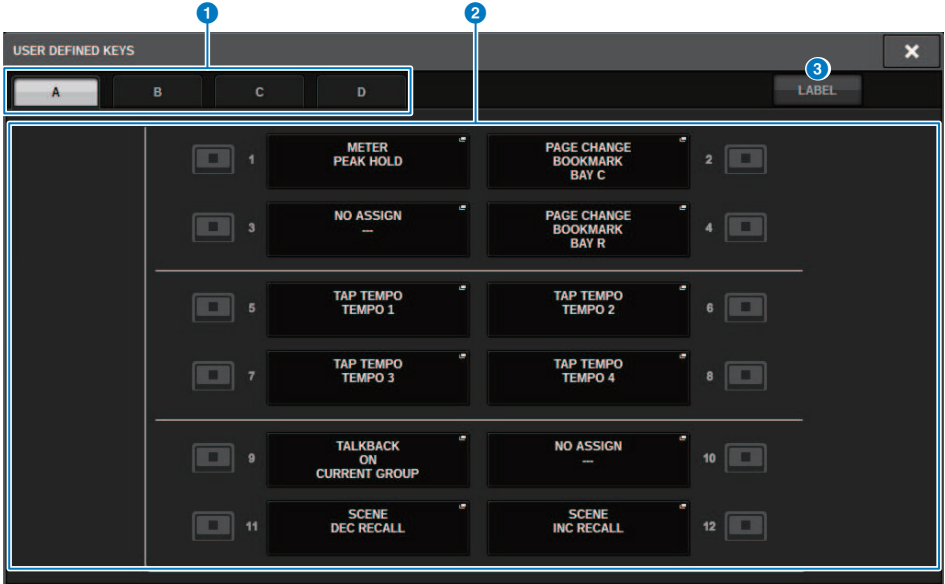

CS-R3

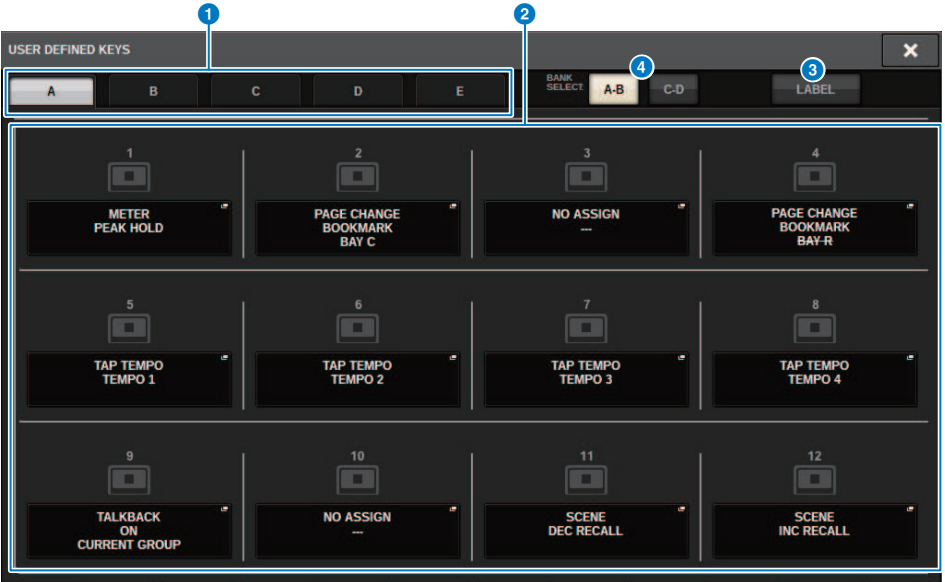

This screen contains the following items.

User Setup > USER DEFINED KEYS popup window

1 **BANK tabs**

Enable you to select the bank ([A], [B], [C], or [D]) for the USER DEFINED knobs.(Bank ([A]/[B]/[C]/[D])/[E]), CS-R3 only)

2 **USER DEFINED KEYS 1-12**

Link to USER DEFINED keys [1]–[12] on the panel. Press one of these buttons to access the popup window, in which you can assign a function to the selected button. If nothing is assigned to the button, an indication of “NO ASSIGN” is shown.

3 **LABEL tab**

Press this to toggle the screen where you can change the displayed contents.

4 **BANK switch button (CS-R3 only)**

Switches the panel USER DEFINED keys (A-B/C-D).

You can also switch using the BANK tab (1) . Press the BANK C tab, and press the panel USER DEFINED key. Bank C/D is also selected.

USER DEFINED KEY LABEL popup window (CS-R10, CSD-R7)

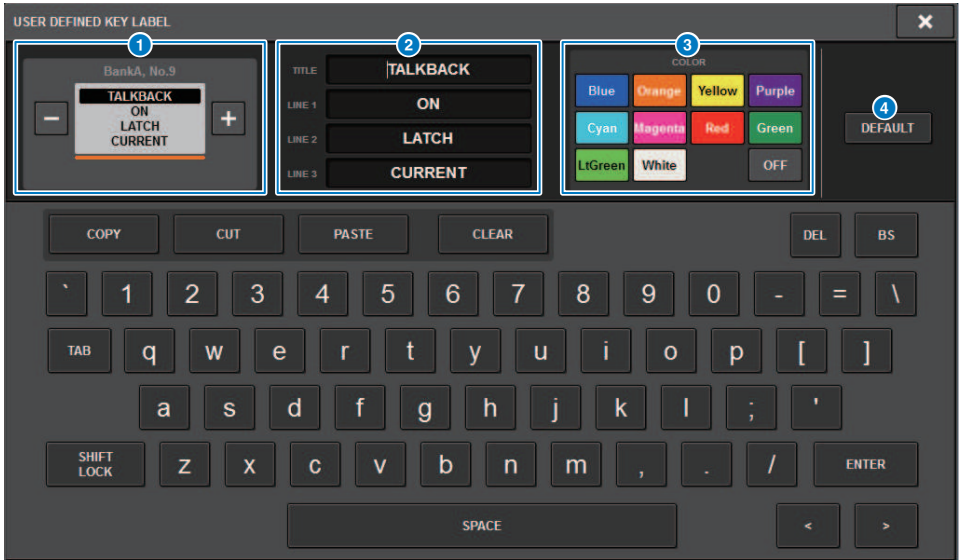

This screen contains the following items.

1 USER DEFINED KEY display

Indicate the functions assigned to the USER DEFINED keys. Press the + button to switch to the next candidate, and the – button to switch to the previous candidate.

2 USER DEFINED key display edit box

Use the keyboard to edit the functions (TITLE) and parameters (LINE1–3) assigned to the USER DEFINED keys.

In the case where text is inputted for only LINE1 or LINE2 and the text length is within five characters, this will be displayed using a large font. Some parameters (such as the BPM value of TAP TEMPO) cannot be edited.

3 LED color select buttons

Selects the LED color.

4 DEFAULT button

Initializes the settings for assigned functions, parameters and channel colors.

NOTE

This restores the defaults even if there have been changes made to the functions assigned to the USER DEFINED keys.

USER DEFINED KEY LABEL popup window (CS-R5、CS-R3)



This screen contains the following items.

1 USER DEFINED KEY display

Indicate the functions assigned to the USER DEFINED keys. Press the + button to switch to the next candidate, and the - button to switch to the previous candidate.

2 USER DEFINED key display edit box

Use the keyboard to edit the functions (TITLE) and parameters (LINE1) assigned to the USER DEFINED keys.

In the case where text is inputted for only TITLE or LINE1 and the text length is within five characters, this will be displayed using a large font. Some parameters (such as the BPM value of TAP TEMPO) cannot be edited.

3 LED color select buttons

Selects the LED color.

4 DEFAULT button

Initializes the settings for assigned functions, parameters and channel colors.

NOTE

This restores the defaults even if there have been changes made to the functions assigned to the USER DEFINED keys.

Functions that can be assigned to the USER DEFINED keys

The functions that can be assigned to the USER DEFINED keys are as follows.

Function	PARAMETER1	PARAMETER2	PARAMETER3	Description
NO ASSIGN	---	---	---	No assignment
ALTERNATE FUNCTION ¹	LATCH			This toggles the ALTERNATE FUNCTION each time it is pressed.
	UNLATCH			This switches to ALTERNATE FUNCTION only while it is pressed.
AUTOMIXER	group A,B,C,D,E OVERRIDE ON			Switches OVERRIDE on/off for each group.
	group A,B,C,D,E PRESET ON			Switches the PRESET on/off for each group.
BRIGHTNESS *1	BANK SELECT	A		Selects the BRIGHTNESS setting bank.
		B		
		C		
		D		
CH ON	SPECIFIC CH	CH	1-288	Switches the channel on/off.
		MIX	1-72	
		MATRIX	1-36	
		STEREO	A, B	
		DCA	1-24	
CH SELECT	INC			Switches the channel to be operated by the Selected Channel section to the next channel.
	DEC			Switches the channel to be operated by the Selected Channel section to the previous channel.
	SPECIFIC CH	CH	1-288	Switches the channel to be operated by the Selected Channel section to the channel specified in the list.
		MIX	1-72	
		MATRIX	1-36	
		STEREO A	L, R	
		STEREO B	L, R	

User Setup > Functions that can be assigned to the USER DEFINED keys

Function	PARAMETER1	PARAMETER2	PARAMETER3	Description	
CONSOLE SHUTDOWN *1				Shuts down the control surface. NOTE You can shut down the control surface by pressing and holding the USER DEFINED key assigned in CONSOLE SHUTDOWN.	
CUE	OUTPUT	A		Switches the CUE A on/off.	
		B		Switches the CUE B on/off.	
	CLEAR CUE	CUE A		Clears the CUE A.	
		CUE B		Clears the CUE B.	
		CUE A+B		Clears the CUE A+B.	
	SPECIFIC CH	CH	1-288		Switches Cue Out on/off.
		MIX	1-72		
		MATRIX	1-36		
		STEREO	A, B		
		DCA	1-24		
	CUE MODE	A, B		Switches the cue mode.	
	CUE INTERRUPTION	A, B		Switches the CUE INTERRUPTION function on/off.	
	INPUT CUE POINT	A, B		Switches the cue point for the input channel.	
DCA CUE POINT	A, B		Switches the DCA cue point.		
OUTPUT CUE POINT	A, B		Switches the cue point for the output channel.		
DSP MIRRORING *2	DSP SELECT A		Switches the active DSP engine between A and B.		
	DSP SELECT B				
	DSP ACTIVATE A		Forces the specified engine to switch to active. If this function is assigned to GPI IN, automatic switching and other functionality will be possible in the event that the active engine loses power.		
	DSP ACTIVATE B				
EVENT LIST	NEXT		Directly recalls the next-numbered event.		

User Setup > Functions that can be assigned to the USER DEFINED keys

Function	PARAMETER1	PARAMETER2	PARAMETER3	Description
EVENT LIST	PREV			Directly recalls the previous-numbered event.
	DIRECT RECALL	(Event list number)		Directly recalls the selected event.
	ENABLE (MANUAL)			Enables or disables the event list.
	ENABLE			
FADER BANK SNAPSHOT	BAY L, BAY R, BAY C, BAY ALL		Stores the current fader layer or position for each bay (press the key for at least two seconds). This also returns to the last stored layer or positions (press the key and release it within less than two seconds).	
GAIN KNOB FUNCTION	LATCH	BAY L, BAY R, BAY C		Enables you to select ANALOG GAIN or DIGITAL GAIN for each bay displayed on the OVERVIEW screen.
	UNLATCH	BAY L, BAY R, BAY C		Selects the GAIN displayed on the OVERVIEW screen for each bay. Press this key to display ANALOG GAIN, and release it to display DIGITAL GAIN.
GEQ FREQ BANK	INC	BAY L, BAY R, BAY C		Changes the band to operate using the channel strip section fader on the GEQ edit screen.
	DEC	BAY L, BAY R, BAY C		
GLOBAL PASTE	ALL IN ONE	GROUP 1-32, CURRENT SCENE, ALL SCENES	W/ SCREEN W/O SCREEN	Executes global paste in bulk. CURRENT SCENE selects the lowest numbered scene group to which the current scene belongs. NO SCENE clears the selected scene group.
		NO SCENE	-	
	SET BY EDIT	GROUP 1-32, CURRENT SCENE, ALL SCENES	W/ SCREEN W/O SCREEN	Switches the SET BY EDIT function on/off. Executes global paste.
		NO SCENE	-	
PASTE		-		
GPI OUT *1	1-8	LATCH		Switches the GPI OUT function on/off.

User Setup > Functions that can be assigned to the USER DEFINED keys

Function	PARAMETER1	PARAMETER2	PARAMETER3	Description
GPI OUT *1	1-8	UNLATCH		Turns the GPI OUT function on (only while pressed).
HOME	SELECTED CH VIEW	L, R, C		Displays the SELECTED CHANNEL VIEW screen for each bay.
	OVERVIEW	L, R, C		Displays the OVERVIEW screen for each bay.
	TOGGLE	L, R, C		Toggles between the SELECTED CHANNEL VIEW and OVERVIEW screens for each bay.
INPUT A/B	SPECIFIC CH	CH1-288		Switches between input patch A and B for the specified channel.
METER	PEAK HOLD			Turns the meter peak hold on/off.
MIDI[CS] *1	PROGRAM CHANGE	PGM 1-128		Transmits a program change message of the corresponding number to an external device.
	CONTROL CHANGE	CC 1-31, 33-95, 102-119		Transmits a control change of the corresponding number to an external device.
	NOTE ON	NOTE ON C-2(0)-G8(127)		Transmits a MIDI message of the corresponding number to an external device.
MONITOR	COMMON	DIMMER ON		Switches the DIMMER on/off.
	MONITOR A	OUTPUT		Switches MONITOR A on/off.

Function	PARAMETER1	PARAMETER2	PARAMETER3	Description
MONITOR	MONITOR A	SEL CH ASSIGN *1	DEFINE 1-8	Press this key to select DEFINE. While continuing to press the key, press the [SEL] key to switch the assignment on/off. During this time, the [SEL] LED will light when the assignment is on, and the LED will turn off when the assignment is off. The assignment settings will be saved while pressing this key. Press the key once more to recall the settings. You can save settings to multiple keys and switch between assignments.
	MONITOR B	OUTPUT		Switches MONITOR B on/off.
		SEL CH ASSIGN *1	DEFINE 1-8	Press this key to select DEFINE. While continuing to press the key, press the [SEL] key to switch the assignment on/off. During this time, the [SEL] LED will light when the assignment is on, and the LED will turn off when the assignment is off.
	SURROUND MONITOR	OUTPUT		Turns the surround monitor output on/off.
		SOURCE	SURROUND A, SURROUND B, DOWNMIX A, DOWNMIX B, EXT 5.1-1-4, EXT ST-1-4	Turns the surround monitor source on or off.
		DIMMER ON		Turns the Dimmer function on/off.
MUTE GROUP CONTROL	CONTROL 1-12	ON	Switches the MUTE GROUP CONTROL on/off.	
	ALL MUTE	ON	Switches all MUTE GROUP CONTROLS on/off at the same time.	
NUENDO LIVE	TRANSPORT	GO TO PROJECT START	For operating the transport functions of NUENDO Live.	
		GO TO PREV MARKER		

User Setup > Functions that can be assigned to the USER DEFINED keys

Function	PARAMETER1	PARAMETER2	PARAMETER3	Description
NUENDO LIVE	TRANSPORT	REWIND		For operating the transport functions of NUENDO Live.
		FAST FORWARD		
		GO TO NEXT MARKER		
		GO TO PROJECT END		
		CYCLE		
		STOP		
		START		
		REC		
		EASY RECORDING		
	MARKER	ADD MARKER		Executes ADD MARKER of NUENDO Live.
OSCILLATOR	ON			Switches the oscillator on/off.
	SEL CH ASSIGN *1	BAY ALL		While pressing the key, press the [SEL] key to switch the assignment on/off. *4 During this time, the [SEL] LED will light when the assignment is on, and the LED will turn off when the assignment is off. The assignment settings will be saved while pressing this key. Press the key once more to recall the settings. You can save settings to multiple keys and switch between assignments.
		BAY C *3		
DIRECT ASSIGN	CH 1-288		This assigns an oscillator to a selected channel.	
	MIX 1-72			
	MATRIX 1-36			
	STEREO AL			
	STEREO AR			
	STEREO BL			
	STEREO BR			
	MONITOR AL			
	MONITOR AR			
	MONITOR AC			
	MONITOR BL			
	MONITOR BR			
	MONITOR BC			

User Setup > Functions that can be assigned to the USER DEFINED keys

Function	PARAMETER1	PARAMETER2	PARAMETER3	Description
PAGE CHANGE	BOOKMARK	BAY L, BAY R, BAY C		Stores the current screen/window displayed for each bay (press the key for at least two seconds). This also returns to the last stored screen/window (press the key and release it within less than two seconds).
	BOOKMARK with "SEL"	BAY L, BAY R, BAY C		Stores the current screen/window displayed for each bay (press the key for at least two seconds). This also returns to the last stored screen/window (press the key and release it within less than two seconds).
PHONES	PHONES OUT(CS-R3)	USE PHONES A		Switches PHONES output (CS-R3 only) .
		USE PHONES B		
		TOGGLE		
RECORDER *1	TRANSPORT	PLAY		This is the transport function for the recorder.
		PAUSE		
		STOP		
		FF		
		NEXT		
		REW		
		PREVIOUS		
		REC		
		AUTO REC		This is the shortcut function for STOP → REC → PLAY. Recording will begin with a single action. When recording begins, the file being recorded will be closed and recording will continue in the new file.
		REC & START		With this function, recording starts right away without entering standby.

User Setup > Functions that can be assigned to the USER DEFINED keys

Function	PARAMETER1	PARAMETER2	PARAMETER3	Description
RECORDER *1	DIRECT PLAY	NO ASSIGN		The specified audio file is played back from the beginning. Audio files to be played are saved in the SONGS subfolder inside the YPE folder.
		(TITLE)		
SCENE	INC RECALL			Recalls the next-numbered scene.
	DEC RECALL			Recalls the previous-numbered scene.
	DIRECT RECALL	(SCENE)		Recalls any scene directly.
SENDS ON FADER *1	MIX 1-72	NORMAL	BAY L, BAY R, BAY C	Switches the normal function on/off (NORMAL) and the function with CUE on/off (WITH CUE). WITH CUE enables the cue when entering SENDS ON FADER mode, or when switching in SENDS ON FADER mode. When exiting the SENDS ON FADER mode using WITH CUE, the cues for all output channels will be cleared.
		WITH CUE	BAY L, BAY R, BAY C	
	MATRIX 1-36	NORMAL	BAY L, BAY R, BAY C	
		WITH CUE	BAY L, BAY R, BAY C	
	MIX ON FADER	NORMAL	BAY L, BAY R, BAY C	
		WITH CUE	BAY L, BAY R, BAY C	
	MATRIX ON FADER	NORMAL	BAY L, BAY R, BAY C	
		WITH CUE	BAY L, BAY R, BAY C	
SENDS ON FADER	NORMAL	BAY L, BAY R, BAY C		
	WITH CUE	BAY L, BAY R, BAY C		
SET BY SEL *1	SET [+48V]	BAY ALL	While pressing the key, press [SEL] to switch on/off. *4	
		BAY C *3		
	SET [PHASE]	BAY ALL		During this time, the [SEL] LED will light when the assignment is on, and the LED will turn off when the assignment is off.
		BAY C *3		
	SET [INSERT1 ON]	BAY ALL		
		BAY C *3		
	SET [INSERT2 ON]	BAY ALL		
		BAY C *3		
	SET [DIRECT OUT ON]	BAY ALL		
		BAY C *3		
	SET [PRE SEND]	BAY ALL		
		BAY C *3		
SET [TO STEREO A]	BAY ALL			
	BAY C *3			
SET [TO STEREO B]	BAY ALL			
	BAY C *3			
SET [TO LCR]	BAY ALL			
	BAY C *3			

User Setup > Functions that can be assigned to the USER DEFINED keys

Function	PARAMETER1	PARAMETER2	PARAMETER3	Description
SET BY SEL *1	SET [GAIN COMPENSATION ON]	BAY ALL BAY C *3		
SET DEFAULT VALUE *1				Pressing the SELECTED CH knob while holding down this key will revert to the default value.
SET NOMINAL VALUE *1	BAY ALL BAY C *3			Pressing the [SEL] key while holding down this key will set the fader of the channel to nominal level. *4 Also, press the parameter knob for which the nominal level is set to set that parameter to nominal level.
SURFACE SETTINGS 1	BANK SELECT	<1 - 4>		Switches the bank that stores the SURFACE SETTINGS 1 parameter settings.
SOLO	ON			Switches the Solo function on/off.
SURROUND PAN	L ON	SELECTED CH	BAY L, BAY R, BAY C	Switches the assignment to the surround bus on/off for the selected channel.
		CH1-288		
	R ON	SELECTED CH	BAY L, BAY R, BAY C	
		CH1-288		
	C ON	SELECTED CH	BAY L, BAY R, BAY C	
		CH1-288		
	LFE ON	SELECTED CH	BAY L, BAY R, BAY C	
		CH1-288		
	Ls ON	SELECTED CH	BAY L, BAY R, BAY C	
		CH1-288		
	Rs ON	SELECTED CH	BAY L, BAY R, BAY C	
		CH1-288		
	PANNING L	SELECTED CH	BAY L, BAY R, BAY C	
		CH1-288		
PANNING R	SELECTED CH	BAY L, BAY R, BAY C		
	CH1-288			
PANNING FRONT	SELECTED CH	BAY L, BAY R, BAY C		
	CH1-288			
PANNING Ls	SELECTED CH	BAY L, BAY R, BAY C		
	CH1-288			
PANNING Rs	SELECTED CH	BAY L, BAY R, BAY C		

User Setup > Functions that can be assigned to the USER DEFINED keys

Function	PARAMETER1	PARAMETER2	PARAMETER3	Description
SURROUND PAN	PANNING Rs	CH1-288		Switches the assignment to the surround bus on/off for the selected channel.
	PANNING BACK	SELECTED CH	BAY L, BAY R, BAY C	
		CH1-288		
	PANNING SIDE L	SELECTED CH	BAY L, BAY R, BAY C	
		CH1-288		
	PANNING SIDE R	SELECTED CH	BAY L, BAY R, BAY C	
		CH1-288		
PANNING CENTER	SELECTED CH	BAY L, BAY R, BAY C		
	CH1-288			
PANNING TOGGLE	SELECTED CH	BAY L, BAY R, BAY C		
	CH1-288			
TALKBACK	ON	LATCH	CURRENT GROUP, GROUP 1-8	Switches the Talkback on/off.
		UNLATCH	CURRENT GROUP, GROUP 1-8	Talkback will be switched on while this is pressed.
	TALK GROUP *1	1-8		Press this key to select the specified group. While continuing to press the key, press the [SEL] key for the output channel to switch the assignment on/off.
TAP TEMPO	TEMPO 1-4			Sets TAP TEMPO.
USER DEFINED KEYS	BANK SELECT (CS-R3)	A-B		Switches banks of the USER DEFINED key. (CS-R3 only)
		C-D		
		TOGGLE		

*1: Cannot be assigned to a USER DEFINED key in the PM Editor.

*2 Not available for the CSD-R7

*3: This also works for bays linked to bay C.

*4: The BAY ALL parameter works for all bays, and has been added as of ver. 3.

Using the Alternate function

If you assign the Alternate function (ALTERNATE FUNCTION) to a USER DEFINED key, turning that key on will toggle between parameter settings that are controlled via channel strip encoders (such as between ANALOG GAIN and DIGITAL GAIN).

For the combination with the [CUE] key, this can be used as a substitute for the ALTERNATE CUE [Fn] key.

Alternate mode is engaged when you turn on the USER DEFINED key to which the Alternate function has been assigned. You can select LATCH or UNLATCH for the Alternate function.

- **UNLATCH**.....Alternate mode is engaged only when you press and hold down the USER DEFINED key.
- **LATCH**.....Pressing the USER DEFINED key repeatedly will switch Alternate mode on and off. In this way, you do not need to press and hold down the USER DEFINED key to use the function.

If ALTERNATE FUNCTION is assigned to a USER DEFINED key, pressing the screen encoder repeatedly will turn the function on and off.

On/off switchable functions

HPF/LPF

DYNAMICS1/DYNAMICS2

DELAY

SILK TEXTURE

SENDS

For the SENDS function, rotate the screen encoder to set PRE or POST.

You can also turn the function on or off by pressing the screen encoder while holding down the [SHIFT] key.

MIDI/GPI

About MIDI

The RIVAGE PM series can use MIDI to perform the following operations.

■ Program Change transmission and reception

When you recall a specific scene on the RIVAGE PM series, a Program Change message of the corresponding number can be transmitted to an external device. Conversely, the corresponding scene can be recalled when the corresponding Program Change message is received from an external device.

■ Control Change transmission and reception

When you execute a specific fader, knob, or key operation on the RIVAGE PM series, the corresponding Control Change message can be transmitted to an external device. Conversely, the corresponding fader, knob, or key operation can be executed when Control Change messages are received from an external device. This capability can be used to record fader and key operations on a MIDI sequencer or other external device, and play back the data later.

■ Receiving MMC

An MMC (MIDI Machine Control) can be received on the system. This can be used to control the 2-track USB recorder on a control surface that is set as the receiving port.

■ Receiving MIDI clock

MIDI clock can be used to set the delay time for the plug-in.

Basic MIDI Settings

You can select the type of MIDI messages the RIVAGE PM series will transmit and receive. You can also select the MIDI port that will be used.

1 Press the **SETUP** button on the menu bar to access the **SETUP** screen.



2 Press the **MIDI/GPI [CS]** button to open the **MIDI/GPI [CS]** popup window.

NOTE

If using the DSP engine, press the MIDI/GPI [DSP] button to access the MIDI/GPI [DSP] popup window. The subsequent explanation is for when using the control surface.

This window includes several pages, which you can switch between using the tabs located at the top of the window.



3 Press the **MIDI SETUP** tab.

“MIDI/GPI window (MIDI SETUP page)” (p.974)

4 To specify the channel on which MIDI messages will be transmitted or received, press the channel select popup button.

The “MIDI SETUP popup window” (p.976) for selecting the channel appears.

5 Select a channel.

To select an item, use the [TOUCH AND TURN] knob. Press the OK button to confirm the selected channel and close the MIDI SETUP popup window.

NOTE

Alternatively, you can select the desired channel by pressing the channel entry in the field or by turning the corresponding screen encoder.

6 Turn transmission/reception on or off for each MIDI message.

NOTE

- For details on using Program Changes, refer to ““Using Program Changes to recall scenes” (p.977)” below.
- For details on using Control Changes, refer to ““Using Control Changes to control parameters” (p.983).”

MIDI/GPI window (MIDI SETUP page)



This screen contains the following items.

1 PORT/CH field

Enables you to specify the settings for the channel that transmit/receive MIDI messages.

- **Tx CH**.....Press this button to access a popup window, in which you can select a MIDI channel that will transmit MIDI messages.
- **Rx CH**.....Press this button to access a popup window, in which you can select a MIDI channel that will receive MIDI messages.

NOTE

The MIDI port setting is fixed to CONSOLE.

2 PROGRAM CHANGE field

Enables you to switch MIDI Program Change message transmission and reception on or off.

- **Tx**.....Switches Program Change transmission on or off.
- **Rx**.....Switches Program Change reception on or off.
- **ECHO**.....Switches on or off echo output of Program Change messages. (If this function is on, Program Change messages received from an external device will be retransmitted without modification.)

3 PROGRAM CHANGE MODE field

Enables you to select the Program Change transmit/receive mode.

- **SINGLE**If this button is on, Program Changes will be transmitted and received on a single MIDI channel (Single mode).
- **MULTI**If this button is on, Program Changes will be transmitted/received on multiple MIDI channels (Multi mode).
- **OMNI**If this button is on, Program Changes on all MIDI channels will be received in Single mode. Multi mode transmission/reception and Single mode transmission are disabled.
- **BANK**If this button is on, Bank Select messages can be transmitted and received in Single mode. (Bank Select messages switch the group of Program Change messages to be used.)

4 CONTROL CHANGE field

Enables you to switch MIDI Control Change message transmission and reception on or off.

- **Tx**Switches Control Change transmission on or off.
- **Rx**Switches Control Change reception on or off.
- **ECHO**Switches on or off echo output of Control Change messages. (If this function is on, Control Change messages received from an external device will be retransmitted without modification.)

5 OTHER COMMANDS (MTC/MMC) field

Switches on or off echo output of other MIDI messages. (If this function is on, other MIDI messages received from an external device will be retransmitted without modification.)

MIDI SETUP popup window

Operations in this window are the same for both transmission (Tx) and reception (Rx). This window includes the following items.

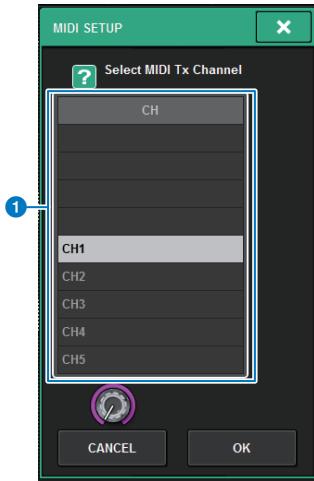

This screen contains the following items.

1 CH field

Enables you to select the channel from CH1–CH16 that will transmit or receive MIDI messages.

Using Program Changes to recall scenes

The RIVAGE PM series enables you assign a specific scene to be recalled to each Program Change number, so that when a scene is recalled on the RIVAGE PM series, a Program Change message of the corresponding number will be transmitted to an external device. Conversely, the corresponding scene can be recalled when a Program Change message is received from an external device.

1 Connect the control surface to an external device.

NOTE

If using the DSP engine, connect the DSP engine with the external devices. The subsequent explanation is for when using the control surface.

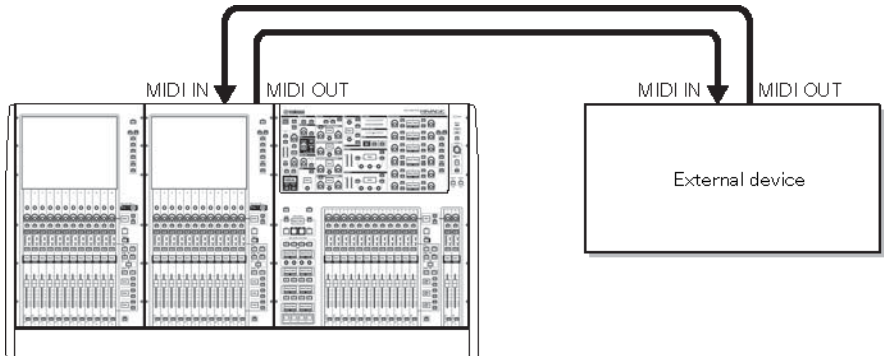

2 As described in “Basic MIDI Settings”, select the MIDI channels that will be used to transmit/receive Program Changes.

“Basic MIDI Settings”

3 Press the **PROGRAM CHANGE** tab.

The MIDI/GPI window (PROGRAM CHANGE page) appears.

4 Use the buttons in the PROGRAM CHANGE MODE field to select the Program Change transmission/reception mode.

You can select one of the following two Program Change transmission/reception modes.

- **Multi mode (when the MULTI button is on):**

Program changes of all MIDI channels will be transmitted and received. (The transmit/receive channel specified in the MIDI page will be ignored.) When a Program Change is received, the scene assigned to the corresponding MIDI channel and program number in the list will be recalled. When you recall a specified scene on the RIVAGE PM series, the Program Change of the corresponding MIDI channel and program number in the list will be transmitted.

- **Single mode (when the SINGLE button is on):**

Only Program Changes of the transmit (Tx) and receive (Rx) channels specified in the MIDI page will be transmitted and received. When a Program Change on the Rx channel is received, the scene assigned to that program number of the corresponding channel in the list will be recalled. When you recall a specified scene on the RIVAGE PM series, the Program Change of the corresponding program number will be transmitted on the Tx channel shown in the list. (If an event is assigned to more than one program number on the same channel, the lowest-numbered program number will be transmitted.) If you turn on the OMNI button or BANK button in Single mode, operation will change as follows.

- **When the OMNI button is on:**

Program changes of all MIDI channels will be received. However, regardless of the MIDI channel that is received, the scene assigned to the corresponding program number of the Rx channel will be recalled. Turning on the OMNI button will not change the operation for Program Change transmission.

- **When the BANK button is on:**

The CH indication in the list will change to BANK (bank number), and Bank Select (Control Change #0, #32) and Program Change messages can be transmitted and received. This can be convenient if you want to control more than 128 scenes on a single MIDI channel. When Bank Select and then Program Change messages (in that order) are received on the Rx channel, the scene assigned to that bank number and program number in the list will be recalled. When you recall a specific scene on the RIVAGE PM series, Bank Select and Program Change messages for the bank number and program number assigned to that scene will be transmitted on the Tx channel. (If the same scene is assigned more than once in the list, the lowest-numbered bank number and program number will be transmitted.)

NOTE

The settings of the OMNI and BANK buttons are ignored in Multi mode. If the BANK button is on and only a Program Change on an applicable MIDI channel is received, the last-selected bank number will be used. If the BANK button is on, the OMNI button can also be turned on at the same time. In this case, Bank Select and Program Change messages of all MIDI channels will be received.

5 Use the buttons in the PROGRAM CHANGE field to turn transmission and reception on or off, and make settings for echo output.

6 To assign a scene to each program number, press the desired cell in the PROGRAM CHANGE ASSIGNMENT column on the list.

The MIDI PROGRAM CHANGE popup window appears. In this window, you can specify the scene (to be recalled) that you want to assign to each program number.

7 Select SCENE in the TYPE field, and then use the LIST/DIRECT field to select a desired scene number for recall operations.

To select an item, use the [TOUCH AND TURN] knob. Press the OK button to confirm the change and close the MIDI PROGRAM CHANGE popup window.

NOTE

Alternatively, you can select a scene number by pressing the desired number in the field or by turning the corresponding screen encoder.

8 Assign scenes to other program numbers in the same way.

With these settings, recalling a specified scene on the RIVAGE PM series will cause the corresponding Program Change (or Bank Select and Program Change) messages to be transmitted to an external device. When an external device receives Program Change (or Bank Select plus Program Change) messages on the appropriate MIDI channel, the scene assigned to that program number of the corresponding MIDI channel (or bank number) will be recalled.

NOTE

- You can use the CLEAR ALL button to erase all assignments to program numbers.
- Assignments to program numbers are maintained as settings for the entire system, rather than for individual scenes.
- In Single mode, if the same scene is assigned to more than one program number on a Tx channel, only the lowest program number will be transmitted. (If the BANK button is on, only the program number of the lowest bank number will be transmitted.)
- In Multi mode, if the same scene is assigned to more than one MIDI channel and more than one program number, only the lowest program number on each MIDI channel will be transmitted.

MIDI/GPI window (PROGRAM CHANGE page)

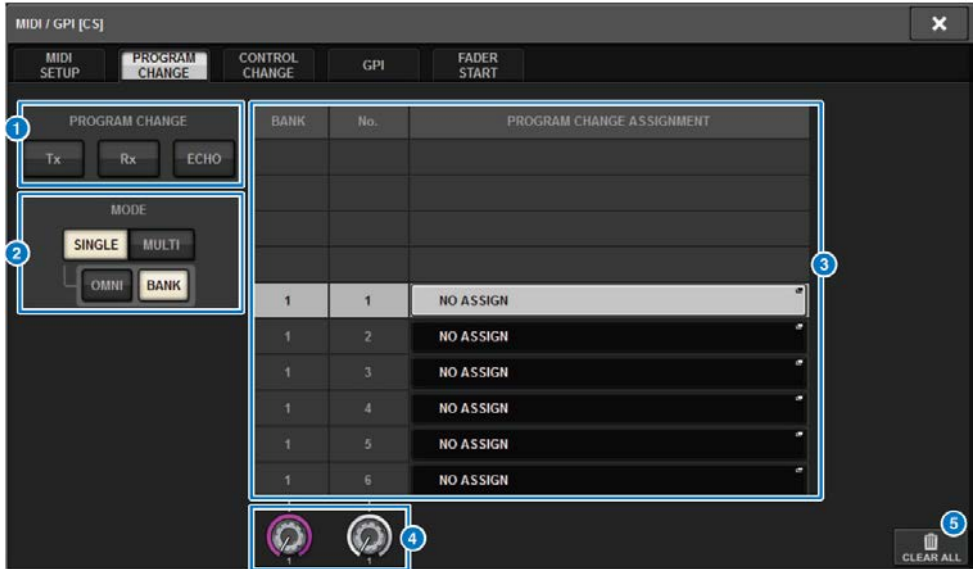

This screen contains the following items.

1 PROGRAM CHANGE field

Switches Program Change transmission and reception on or off. This setting is linked with the PROGRAM CHANGE field of the MIDI page.

- **Tx**.....Turn this button on to transmit the corresponding Program Change message when a scene is recalled.
- **Rx**.....Turn this button on to recall the corresponding scene when a Program Change message is received.
- **ECHO**.....Turn this button on to transmit Program Change messages (that are received from an external device) without modification.

2 PROGRAM CHANGE MODE field

Here you can select the Program Change transmit/receive mode. This setting is linked with the PROGRAM CHANGE MODE field of the MIDI page.

3 List

Shows the scene recall operation assigned to each MIDI channel and MIDI Program Change number. The list shows the following items.

- **CH/BANK**If “CH” appears as the column heading instead of “BANK,” the column indicates the MIDI channel (1–16) on which Program Changes are transmitted/received. If Program Change transmission and reception is in Single mode and the BANK button is on, this will be labeled “BANK,” and the numerical value in this column will correspond to the bank number.
- **NO**Indicates the program number 1–128.
- **PROGRAM CHANGE ASSIGNMENT**.....Indicates the scene number and scene name assigned to each channel (bank number) or program number. Press an individual assignment display area to open the MIDI PROGRAM CHANGE popup window, in which you can select the content that you want to assign.

4 Scroll knob

Press this knob to scroll the list upward or downward using the screen encoder.

5 CLEAR ALL button

Press this button to clear all scene recall assignments in the list.

MIDI PROGRAM CHANGE popup window



The screen contains the following items.

1 MODE field

Enables you to select an operation target that will be controlled via a Control Change message, from input channels, output channels, DCAs, and Mute Group Controls.

2 PARAMETER 1/2/3 fields

In conjunction with the MODE field, this field specifies the type of operation parameter.

NOTE

For details on the operations that can be assigned to Control Changes, refer to the data list.

Using Control Changes to control parameters

You can use MIDI Control Change messages to control specified fader/knob operations, [ON] key on/off operations, etc. on the RIVAGE PM series. This capability can be used to record fader and key operations on a MIDI sequencer or other external device, and play back the data later.

Using Control Changes

This method uses typical Control Changes (control numbers 1–31, 33–95, 102–119). You can freely assign an operation to each control number.

1 Connect the control surface to an external device.

NOTE

If using the DSP engine, connect the DSP engine with the external devices. The subsequent explanation is for when using the control surface.

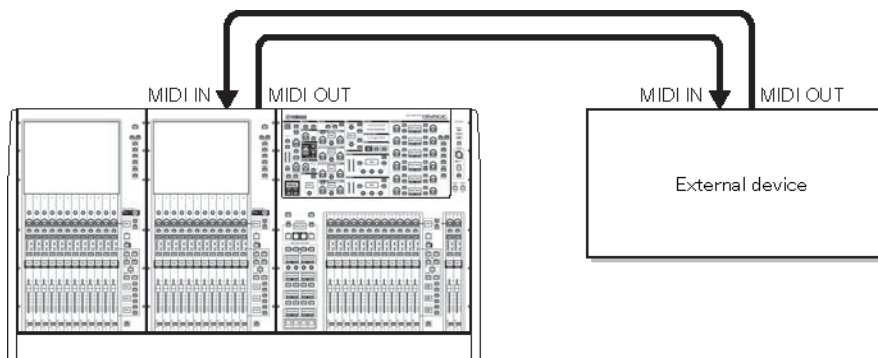

2 As described in “Basic MIDI Settings”, select the MIDI channels that will be used to transmit/receive Program Changes.

“Basic MIDI Settings”

3 Press the PROGRAM CHANGE tab.

The MIDI/GPI window (CONTROL CHANGE page) appears.

4 To change the operation assignment for each control number, press the corresponding parameter.

The “MIDI/GPI window (CONTROL CHANGE page)” (p.986) appears. In this window, you can specify the parameter assigned to each control number.

5 In the order of the MODE field -> PARAMETER1 field -> PARAMETER2 field -> PARAMETER3 field, specify the type of parameter you want to assign.

To select an item, use the [TOUCH AND TURN] knob. Press the OK button to confirm the change and close the MIDI CONTROL CHANGE popup window.

NOTE

- You can also press the desired parameter in the field to select it.
- You can press a field to highlight the item you want to select, and then turn one of the screen encoders to select a parameter.

6 Assign parameters to other control numbers in the same way.

When you operate a specified parameter on the RIVAGE PM series with these settings, the corresponding Control Change message will be transmitted to external devices. Similarly, if the corresponding Control Change messages are received from an external device on the appropriate channel, the parameters assigned to those control numbers will change.

NOTE

- You can use the CLEAR ALL button to erase all assignments to control numbers.
- Assignments to control numbers are maintained as settings for the entire system, rather than for individual scenes.

MIDI PROGRAM CHANGE popup window

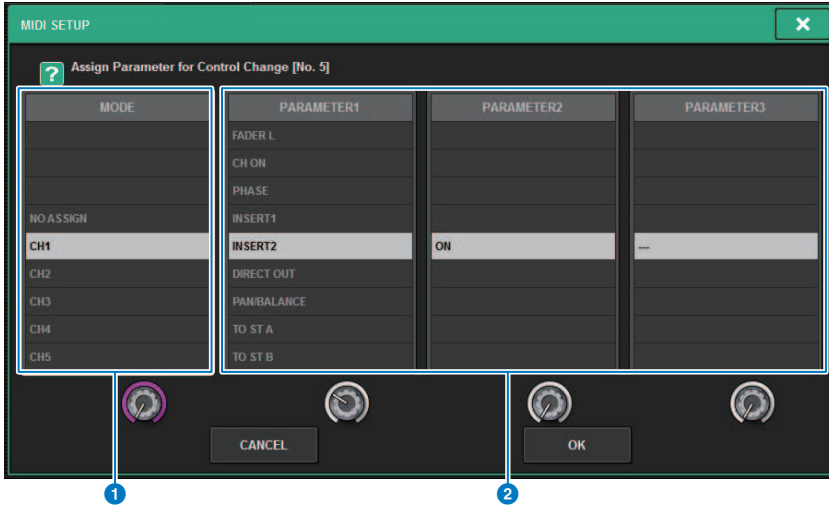

The screen contains the following items.

1 MODE field

Enables you to select an operation target that will be controlled via a Control Change message, from input channels, output channels, DCAs, and Mute Group Controls.

2 PARAMETER 1/2/3 fields

In conjunction with the MODE field, this field specifies the type of operation parameter.

NOTE

For details on the operations that can be assigned to Control Changes, refer to the data list.

MIDI/GPI window (CONTROL CHANGE page)

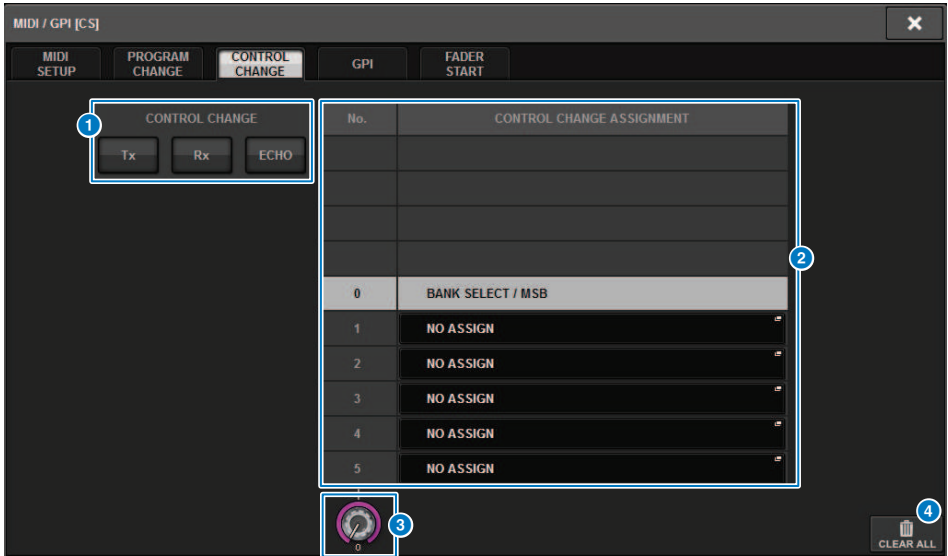

The screen contains the following items.

1 CONTROL CHANGE field

Enables you to switch Control Change transmission/reception on or off, and specify whether Control Changes will be echoed out. This setting is linked with the CONTROL CHANGE field on the MIDI page.

2 List

Shows the fader/knob operation or [ON] key on/off operation that are assigned to each control number.

- **NO**Indicates the . Control number. You can use control numbers 1–31, 33–95, and 102–119.
- **CONTROL CHANGE ASSIGNMENT**Enables you to view and select the type of parameter assigned to each control number. When you press a parameter, the MIDI CONTROL CHANGE popup window will appear, enabling you to change the control number assignment.

3 Scroll knob

Press this knob to scroll the list upward or downward using the screen encoder.

4 CLEAR ALL button

Press this button to clear all parameter assignments on the list.

About GPI

The GPI connector located on the rear panel can be used as a GPI (General Purpose Interface) input/output connector. This connector provides eight GPI IN ports and eight GPI OUT ports. For example you can use an external switch to control internal parameters of the RIVAGE PM series or to switch scenes. Conversely, operations or scene changes performed on the RIVAGE PM series can send control signals to an external device. For details on how to send control signals to an external device when you switch scenes, refer to “Outputting a control signal to an external device in tandem with “Outputting a control signal to an external device in tandem with scene recall (GPI OUT)” (p.809).

The following diagram is an example of an external circuit that can operate GPI via the GPI connector. (For details on the specifications of the GPI connector pins, refer to the data list.) [OUT]-1-7 ports are open-drain outputs, and are switched to open or ground. Applicable voltage is up to +12V for the [OUT]-1-7 ports, and acceptable current is up to 75 mA per port. [OUT]-8 port supports up to +30V voltage input.

NOTE

- Only [IN]-8 port features photo coupler input of up to +24V.
- Only [OUT]-8 port features relay output of 24V (DC) (rated) and 1A.

Using a switch connected to GPI IN1

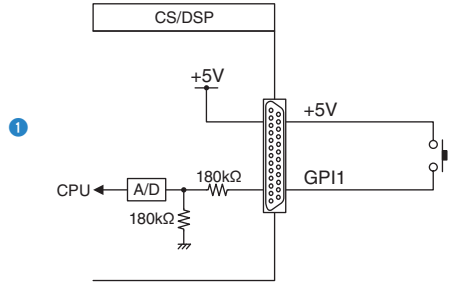

Using a switch connected to GPI IN8

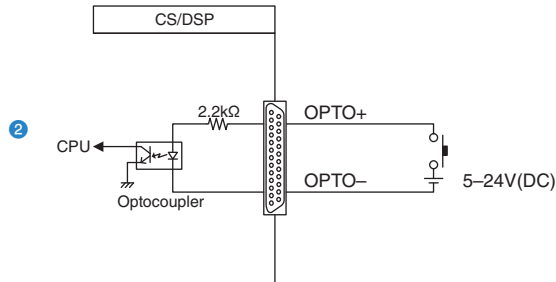

Lighting external LED indicators via GPI OUT1

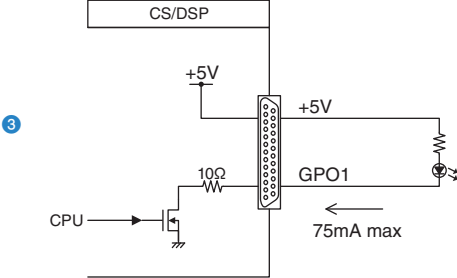

CAUTION

- Be careful not to exceed a current of 75 mA at the OUT ports.

Lighting a lamp (100V AC) by switching the relay on an external device via GPI OUT1

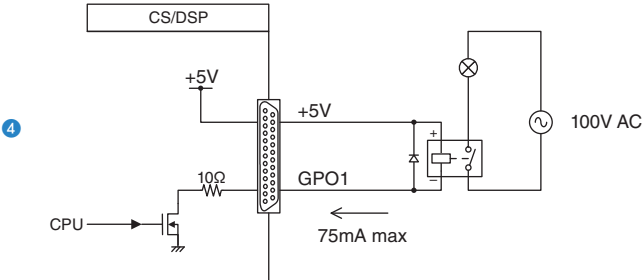

CAUTION

- Be careful not to exceed a current of 75 mA at the OUT ports.

Lighting a lamp (24V DC) by switching the relay on an external device via GPI OUT8

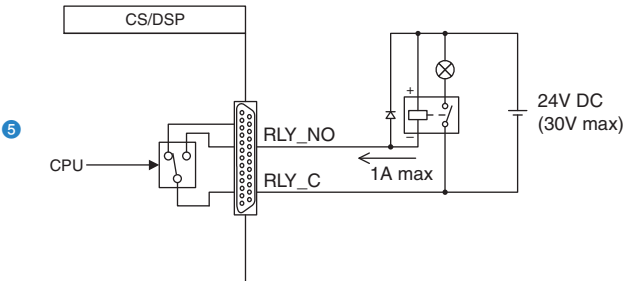

Using GPI IN

You can use the GPI IN ports of the GPI connector to control the parameters of the RIVAGE PM series from an external device. For example, you could use an external switch to turn the RIVAGE PM series's Talkback on/off, operate the Tap Tempo function, or switch scenes.

1 Connect an external device to the GPI connector of the control surface.

NOTE

If using the DSP engine, connect the DSP engine with the external devices. The subsequent explanation is for when using the control surface.

2 Press the **SETUP** button on the menu bar to access the **SETUP** screen.



3 Press the **MIDI/GPI [CS]** button to open the **MIDI/GPI [CS]** popup window.

NOTE

If using the DSP engine, press the MIDI/GPI [DSP] button to access the MIDI/GPI [DSP] popup window.

This screen includes several pages, which you can switch between using the tabs located at the top of the screen.



4 Press the **GPI** tab.

The view switches to the “GPI page” (p.991).

- 5 Specify the input type and POLARITY MODE based on the specifications of the external device you are using.**
- 6 To assign the function or parameter that you want to control, press the GPI SETUP popup button to open the GPI SETUP popup window.**

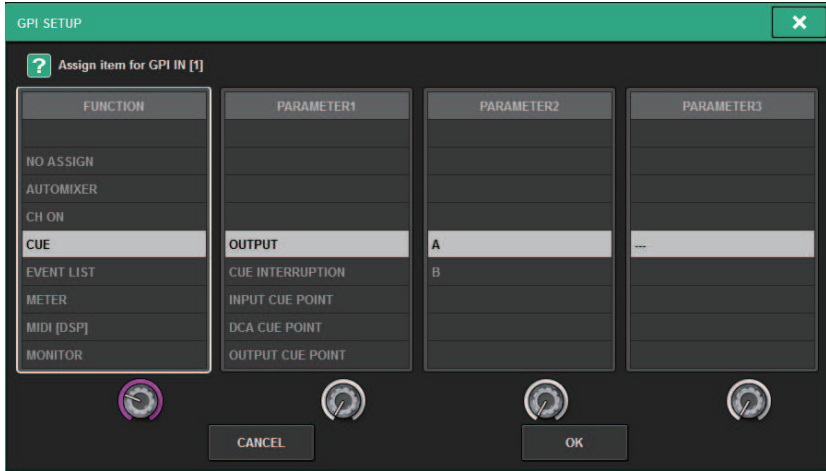

NOTE

Available options in the GPI SETUP popup window are the same as for the USER DEFINED keys. However, some functions (BRIGHTNESS, CH SELECT, CONSOLE SHUTDOWN, DSP MIRRORING, PAGE CHANGE, RECORDER, SET BY SEL, SET DEFAULT VALUE, SET NOMINAL VALUE) are available only for the control surface.

- 7 In each field, select the desired function or parameter.**
- 8 When you finish making settings, press the OK button.**

The system will return to the GPI screen.
- 9 Repeat steps 5 through 8 to specify functions and parameters for other ports.**

NOTE

Settings in the GPI screen are common to all scenes. They can be saved as SETUP data.

GPI page

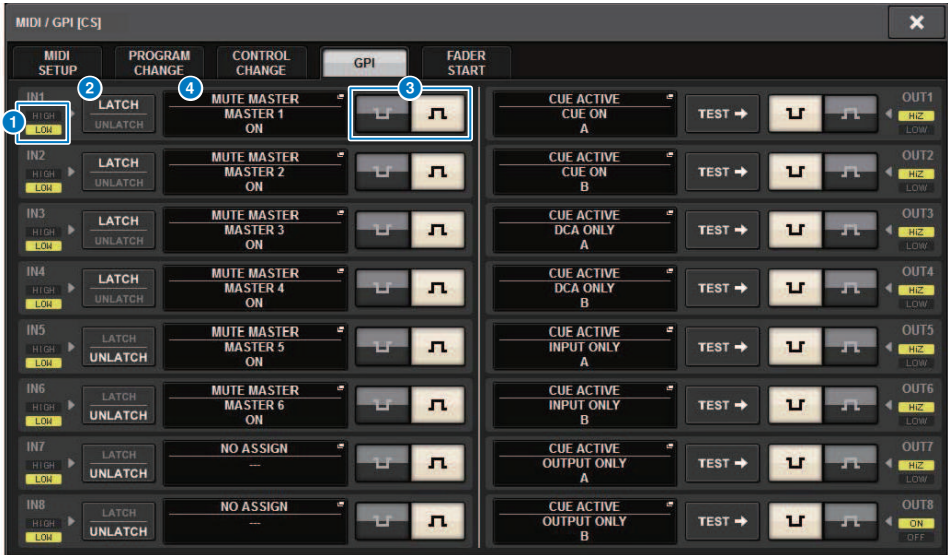

The screen contains the following items.

1 GPI IN status indicator

Indicates the status of the voltage being input to the GPI IN port.

2 Switch property select buttons

Pressing each button repeatedly will toggle between LATCH and UNLATCH indicators.



.....In general, select this mode if you connect an alternate switch (that toggles between on and off if you press the switch repeatedly).



.....This mode is useful if you connect a momentary-type switch (that is turned on only while you are pressing and holding it down, and turned off when you release it).

3 POLARITY MODE select button

This button selects the polarity of the GPI IN port.



.....(Low active) Active when the input signal is low level.



.....(High active) Active when the input signal is high level.

4 GPI SETUP popup button

Press this button to access the GPI SETUP popup window. The button shows the name of the currently-selected function or parameter.

Using GPI OUT

The GPI OUT ports of the GPI OUT connector enable you to control an external device by performing operations on the RIVAGE PM series.

1 Connect an external device to the GPI connector of the control surface.

NOTE

If using the DSP engine, connect the DSP engine with the external devices. The subsequent explanation is for when using the control surface.

2 Press the **SETUP** button on the menu bar to access the **SETUP** screen.

3 Press the **MIDI/GPI [CS]** button to open the **MIDI/GPI [CS]** popup window.

NOTE

If using the DSP engine, press the MIDI/GPI [DSP] button to access the MIDI/GPI [DSP] popup window.

This screen includes several pages, which you can switch between using the tabs located at the top of the screen.



4 Press the **GPI** tab.

The view switches to the “GPI page” (p.994).

5 Specify the **POLARITY MODE** based on the specifications of the external device you are using.

- 6 To assign the function or parameter that you want to control, press the GPI OUT SETUP popup button.**

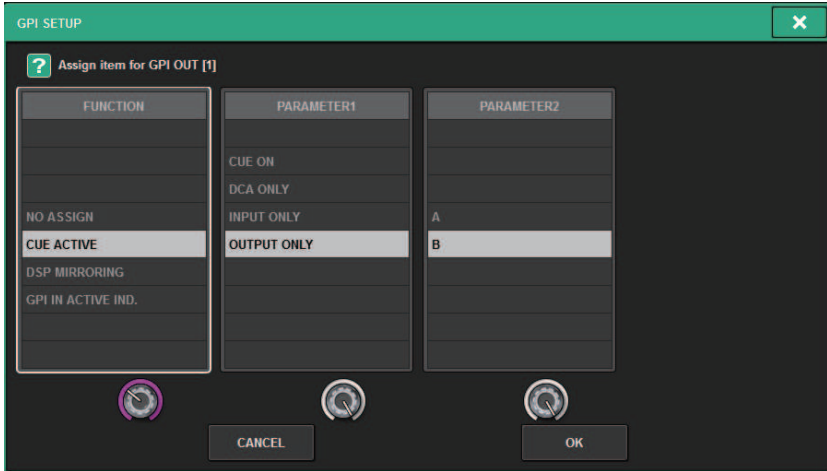

Configurable “GPI OUT functions” (p.999)

- 7 In each field, select the desired function or parameter.**
- 8 When you finish making settings, press the OK button.**
- 9 Repeat steps 5 through 8 to specify functions and parameters for other ports.**

GPI page

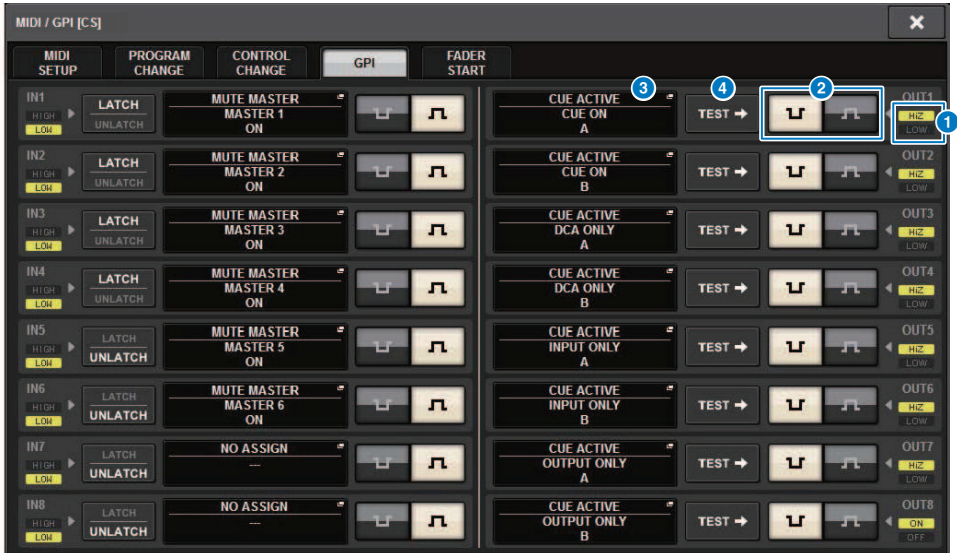

The screen contains the following items.

1 GPI OUT status indicator

Indicates the status of the voltage that is being output from each GPI OUT port.

2 POLARITY MODE select button

Enables you to select the polarity of the GPI OUT port.



.....(Low active) Grounded when the GPI OUT port is active.



.....(High active) Open when the GPI OUT port is active.

3 GPI SETUP popup button

Press this button to access the GPI SETUP popup window. The button shows the name of the currently-selected function or parameter.

4 TEST button

While this button is on, the corresponding GPI OUT port will become active and output a control signal.

Using FADER START

Make FADER START settings if you want a device connected to a GPI OUT port to operate in tandem with fader operations.

- 1 Connect an external device to the GPI connector of the control surface or the DSP engine.**

NOTE

If using the DSP engine, connect the DSP engine with the external devices. The subsequent explanation is for when using the control surface.

- 2 Press the SETUP button on the menu bar to access the SETUP screen.**

- 3 Press the MIDI/GPI [CS] button to open the MIDI/GPI [CS] popup window.**

NOTE

If using the DSP engine, press the MIDI/GPI [DSP] button to access the MIDI/GPI [DSP] popup window.

This screen includes several pages, which you can switch between using the tabs located at the top of the screen.



- 4 Press the FADER START tab.**

Switches the view to the “FADER START page” (p.996).

- 5 For each GPI OUT port, specify the channel that will cause the external device to operate, and also specify the type of operation.**

FADER START page

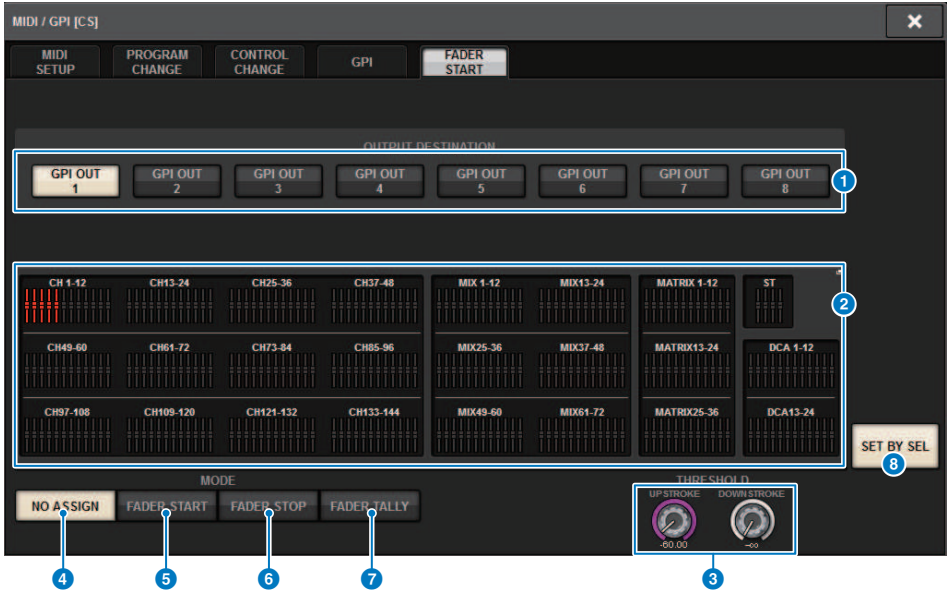

The screen contains the following items.

■ OUTPUT DESTINATION field

1 GPI OUT1 – GPI OUT8 buttons

Select the GPI OUT port for which you want to make settings.

2 Fader indicator

Indicates the selected fader. Use the [SEL] keys on the panel to select a fader.

■ THRESHOLD field

3 UPSTROKE/DOWNSTROKE knobs

These knobs specify the level that will be the threshold at which to output a trigger signal. A trigger signal will be output when the fader exceeds the UPSTROKE level, or when the fader falls below the DOWNSTROKE level. Alternatively, you can use the [TOUCH AND TURN] knob.

NOTE

The THRESHOLD values specified by the UPSTROKE/DOWNSTROKE knobs are common to all channels (faders) and GPI OUT ports. However, you can individually choose the channel (fader) for each GPI OUT port. Only the UPSTROKE value will be valid if MODE is set to FADER START, and only the DOWNSTROKE value will be valid if MODE is set to FADER STOP. If MODE is set to FADER TALLY, both the UPSTROKE and DOWNSTROKE values will be valid.

■ MODE field

Here you can select the mode of fader operation that will be the trigger for signal output from the GPI OUT port. You can choose from the following fader modes.

4 NO ASSIGN

Operating the fader of the selected channel will not cause a signal to be output.

5 FADER START

A trigger signal of 250 msec duration will be output if the fader of the selected channel is raised from below the specified UPSTROKE level (between -138.0 dB and 10.0 dB) to beyond that level.

6 FADER STOP

A trigger signal of 250 msec duration will be output when the fader of the selected channel reaches the specified DOWNSTROKE level (between $-\infty$ dB and 9.95 dB).

7 FADER TALLY

A trigger signal will be output if the fader of the selected channel is raised from below the specified UPSTROKE level (between -138.0 dB and 10.0 dB) to beyond that level. This signal will be held until the fader reaches the specified DOWNSTROKE level (between $-\infty$ and 9.95 dB), or until that GPI OUT port receives a different trigger. The following illustration shows how the output signal from the GPI OUT port will change when a fader is operated in each fader mode. In this example, the THRESHOLD field is set to -60.00 for UPSTROKE, and to $-\infty$ for DOWNSTROKE. (In this

illustration,  is selected as the POLARITY of the GPI OUT port. If  POLARITY is selected, the output signal polarity will be reversed.)

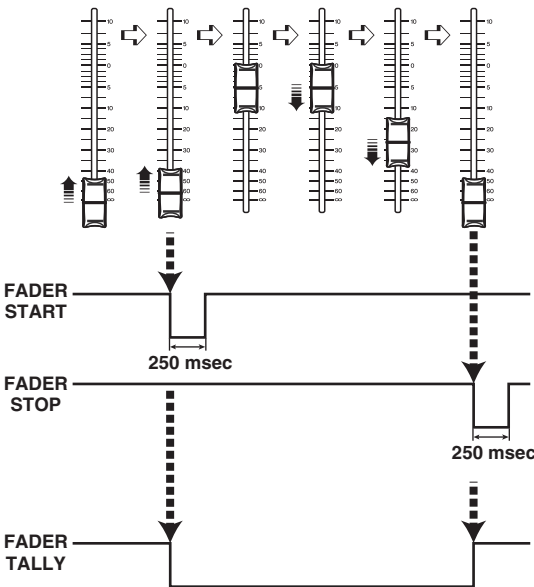

NOTE

At the high level, the output signal of the port will be open. If the receiving device requires high level, take it from the +5V power supply pin. However in this case, there is a limit on the amount of current that can be provided. For details, refer to the "Control input/output specifications" section in the data list.

8 SET BY SEL button

If this button is on, you will be able to add a channel by using the corresponding [SEL] key.

Time code

The TC IN connector located on the rear panel of the DSP engine or the CSD-R7 is an input connector for receiving time code signals from an external device. A scene or library item registered in the event list function can be recalled when time code received via the TC IN connector reaches a specified time.

GPI OUT functions

You can assign the following functions.

Function	PARAMETER 1	PARAMETER 2	Description
NO ASSIGN	---	---	No assignment
CUE ACTIVE	CUE ON	A	Turns on the [CUE] key of the selected channel for CUE A/ CUE B.
		B	
	DCA ONLY	A	Turns on the [CUE] key of the DCA for CUE A/CUE B.
		B	
	INPUT ONLY	A	Turns on the [CUE] key of the input channel for CUE A/CUE B.
		B	
	OUTPUT ONLY	A	Turns on the [CUE] key of the output channel for CUE A/ CUE B.
		B	
DSP MIRRORING *1	DSP CHANGEOVER	---	Switches the DSP engine when using DSP mirroring
	DSP A ACTIVE	---	DSP A operates as the active engine
	DSP B ACTIVE	---	DSP B operates as the active engine
GPI IN ACTIVE IND.	SPECIFIC PORT	PORT 1 – PORT 8	The function assigned to GPI IN port 1–8 becomes active.
USER DEF. KEY ACTIVE IND. *2	SPECIFIC NUMBER	USER DEFINED KEY 1 – USER DEFINED KEY 12	The function assigned to the USER DEFINED key becomes active

*1 Not available for the CSD-R7

*2 Available only for the control surface

Maintenance

Firmware version

You can view a list of the current firmware version number of each component.

NOTE

- If there is a combination of firmware that is wrong for the operation of the overall system, the applicable component is displayed in yellow.
- In this case, refer to the appropriate update guide, and perform the update.

Screen example

The screenshot shows a maintenance interface with a dark grey background. At the top, there is a 'MAINTENANCE' title bar with a close button (X). Below the title bar is a navigation menu with several tabs: 'FIRMWARE VER', 'FADER CALIB', 'TOUCH CALIB', 'UNIT MODE', 'INITIALIZATION', 'PORT TRIM', 'SYSTEM LOG', 'DSP-RX INFO', and 'LICENSE'. The 'FIRMWARE VER' tab is selected and highlighted.

The main content area is divided into two sections:

- DEVICE:** This section displays a grid of components and their firmware versions. The components are arranged in two columns. The first column includes CS1 (V4.01), DSP 1A (V4.01), DSP 1B (V4.01), M1 (V4.01), M2 (V4.01), M3 (V4.01), M4 (V4.01), M5 (V4.01), M6 (V4.01), M7 (V4.01), and M8 (V4.01). The second column includes CS1 I/O (V4.01), CS2 I/O (V4.01), S1 (V4.01), S2 (V4.01), S3 (V4.01), S4 (V4.01), S5 (V4.01), S6 (---), S7 (---), and S8 (---).
- FIRMWARE VERSION:** This section shows the firmware version for 'CS1 (CS-R10)'. It features a 'MAIN V4.01' button and a scrollable list of components and their versions:

```
OS V2.03
DIAG V1.32
SHELL V1.22
REC APP 00.00.85
REC SYS 00.65.00
REC KERNEL 00.65.00
JKL V1.02a
P-MD2(R1) 81
P-MD2(R2) 81
P-MD2(R3) 81
P-MD2(R4) 81
P-MD2(C) 81
P-I2S(R) 81
P-I2S(C) 81
P-HR1(R1) 83
P-HR1(R2) 83
P-HR1(R3) 83
P-HR1(R4) 83
P-HR1(R5) 83
P-HR1(C1) 83
P-HR1(C2) 83
P-FDC(R) 82
P-FDC(C) 82
```

Firmware updates

You can update the unit firmware to improve operations, add functions, and correct possible malfunctions. Details on updating the firmware are available on the following Yamaha Pro Audio website: <http://www.yamahaproaudio.com/> For information on updating and setting up the unit, please refer to the firmware update guide available on the website.

Adjusting the faders

Depending on the environment in which you use the system, discrepancies may occur in the motion of the motorized faders. You can use the Calibration function to correct these discrepancies. The RIVAGE PM series features two types of fader calibration.

Motor Drive Calibration	Automatically optimizes the motorized fader movement.
Positioning Calibration	Calibrates the motorized fader movement so that the fader knob positions and the level values stored in the console (parameter) will match.

NOTE

An alarm message will appear if a problem is detected in the fader settings while the RIVAGE PM series is starting up.

1 Press the SETUP button on the menu bar to access the SETUP screen.



2 Press the MAINTENANCE button to access the MAINTENANCE popup window.

This window includes several pages, which you can switch between using the tabs located at the top of the window.

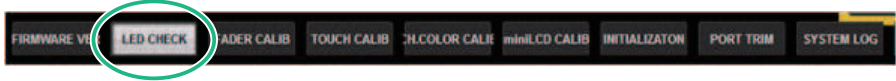

3 Press the FADER CALIB tab.

The FADER CALIBRATION screen will appear, which will enable you to adjust the faders.

4 Select the tab for the desired fader calibration operation.



If the **MOTOR DRIVE** calibration tab is selected:

For the specified faders in the Channel Strip section and Main section, the motorized fader movement will be automatically calibrated.

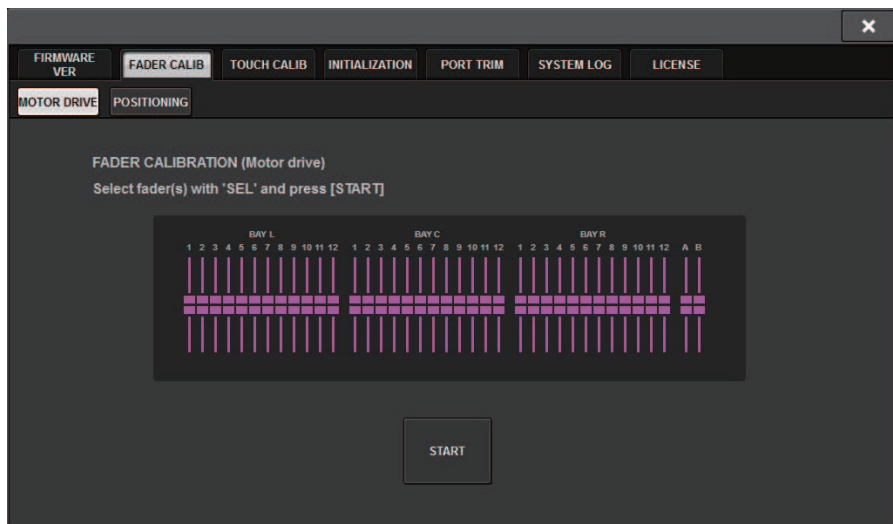

5 Press the [SEL] key for each fader that you want to calibrate.

Faders for which a problem was detected in the fader settings at start-up will already be selected.

6 Press the **START** button.

The system starts optimizing the movement of the motorized faders. The corresponding [SEL] keys will flash during calibration. To cancel in the middle of calibration, press the STOP button. When optimization of the motorized fader movement is complete, the [SEL] keys will go dark.

7 When calibration is complete, press the **FINISH** button.

The calibration values will be saved in internal memory. If the [SEL] key lights and the color bar becomes red, calibration has failed. Press the START button to perform calibration again.

Adjusting the detection point of the touch screen panels (CS-R10, CS-R10-S, CSD-R7)

Follow the steps below to correctly align the positions of the LCD display and the touch screen panels.

1 Press the SETUP button on the menu bar to access the SETUP screen.

2 Press the MAINTENANCE button to access the MAINTENANCE popup window.

This screen includes several pages, which you can switch between using the tabs located at the top of the screen.

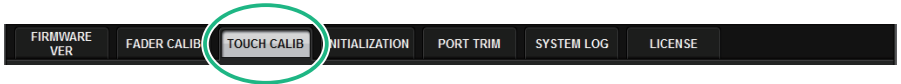

3 Press the TOUCH CALIB tab.

The TOUCH SCREEN CALIBRATION screen will appear, enabling you to calibrate the touch screen panels.

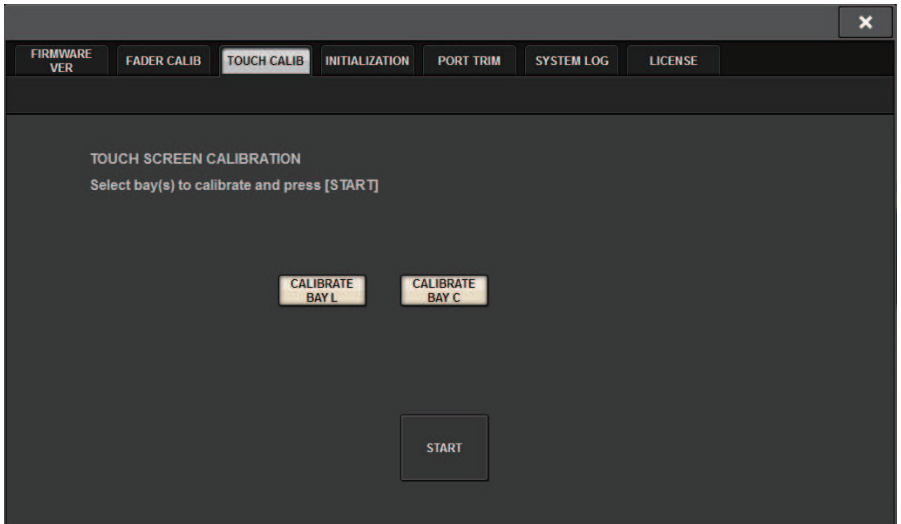

4 Press the CALIBRATE BAY L button to calibrate the left touch screen panel. Press the CALIBRATE BAY C button to calibrate the right touch screen panel.

You can also select and calibrate both CALIBRATE BAY L and CALIBRATE BAY C simultaneously.

5 Press the START button.

A cross-shaped cursor will appear in the screen a total of four times. Press each location at which it appears.

NOTE

To set the detection points accurately, press the cross-shaped cursor from the position and posture in which you normally operate the unit.

6 Press the FINISH button.

The calibration values will be saved in internal memory.

Adjusting the detection point of the touch screen panels (CS-R5 and CS-R3)

Follow the steps below to correctly align the positions of the LCD display and the touch screen panels.

- 1 Press the SETUP button on the menu bar to open the SETUP window.**
- 2 Press the MAINTENANCE button to open the MAINTENANCE popup window.**

This window includes several pages, which you can switch between using the tabs located at the top of the window.

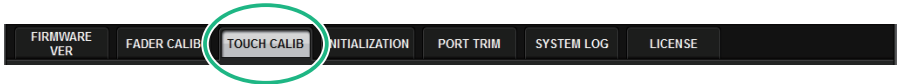

- 3 Press the TOUCH CALIB tab.**

The TOUCH SCREEN CALIBRATION window will open, allowing you to calibrate the touch screen panels.

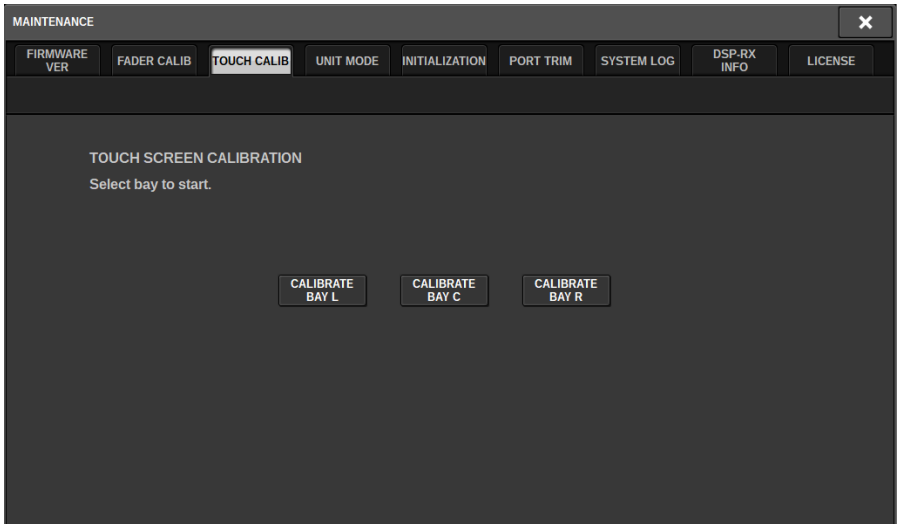

- 4 Select the BAY where you want to adjust the touch screen and press the button. (BAY C only for CS-R3)**
Calibration starts.
- 5 A cross-shaped cursor will appear on the screen. Press the screen at each location where it appears.**

NOTE

To set the detection points accurately, press the cross-shaped cursor from the position and posture in which you normally operate the unit.

- 6 The calibration values will be saved in internal memory. If a message saying "Calibration finished. Applies after power on" is displayed, the settings will be reflected after cycling the power.**

Initializing the unit to factory default settings

If an error occurs in the unit's internal memory, or if you forget the password and cannot operate the unit, you can use the following procedure to initialize the internal memory.

NOTICE

- When you initialize the internal memory, all content that had been saved in memory will be lost.

Use caution when performing the following steps.

1 Press the **SETUP** button on the menu bar to access the **SETUP** screen.



2 Press the **MAINTENANCE** button to access the **MAINTENANCE** popup window.

This window includes several pages, which you can switch between using the tabs located at the top of the window.

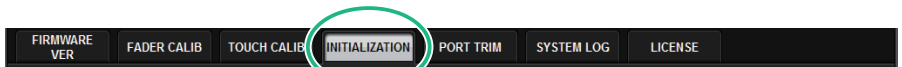

3 Press the **INITIALIZATION** tab.

The "INITIALIZATION page" (p.1010) appears, enabling you to initialize the internal memory.

4 You can select multiple items to be initialized as required by the desired initialization method.

Maintenance > Initializing the unit to factory default settings

5 Press the INITIALIZE THIS CONSOLE button.

A dialog box will ask you to confirm the Initialization operation.

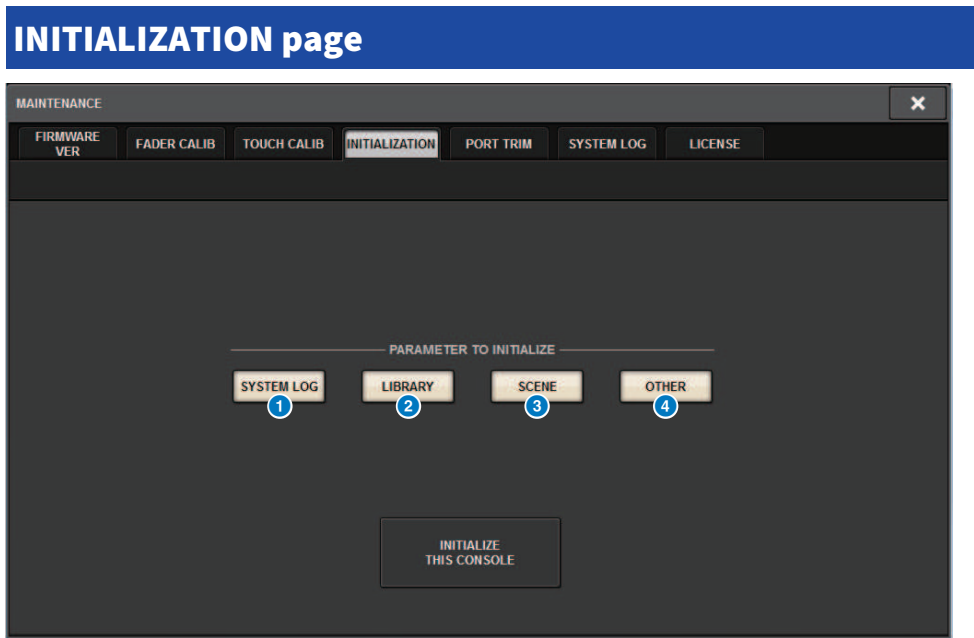

This screen contains the following items.

- 1 **SYSTEM LOG button**
Press this button to initialize the system log.
- 2 **LIBRARY button**
Press this button to initialize the libraries.
- 3 **SCENE button**
Press this button to initialize the scene memory.
- 4 **OTHER button**
Press this button to initialize settings such as the current data or setup data.

System dump (CS-R10, CS-R10, CSD-R7)

If the RIVAGE PM series experiences a software problem during operation, it will dump (store) the system status at that point in the internal memory of the control surface.

If the problem is related to software, an error message (something like the one below) will appear.

NOTICE

- If you see this error message, restart the control surface as soon as possible.

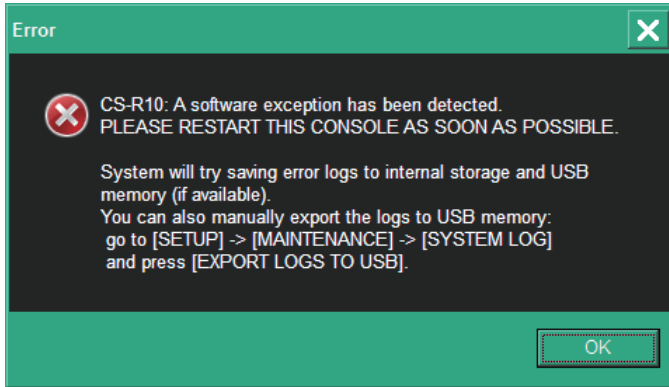

Press the OK button. The SAVE/LOAD screen will be displayed and the following files will be stored in the internal memory.

- 1 Press the SETUP button on the menu bar to access the SETUP screen.**
- 2 Press the MAINTENANCE button to access the MAINTENANCE popup window.**
- 3 Press the SYSTEM LOG tab to access the SYSTEM LOG page.**
- 4 Press the EXPORT LOS TO USB button.**

The system log file, including the system dump file will be stored.

NOTE

Stored data is useful for analysis and troubleshooting of problems and malfunctions. If you consult your Yamaha dealer, please be sure to provide the stored data along with information regarding the trouble or malfunction.

PORT TRIM page



This screen contains the following items.

1 Component select buttons

Enables you to select a component.

2 Port select buttons

Enables you to select a port.

3 PORT TRIM knobs

Adjust the gain.

• **INPUT PORT (Fine adjustment of the analog input gain)**

This makes fine adjustments in 0.1 dB steps to the gain of the specified analog input port.

• **OUTPUT PORT (Fine adjustment of the output ports)**

This makes fine adjustments in 0.01 dB steps to the output port gain of the specified slot.

System log

The system log allows you to identify and read about problems that occurred during operation of the RIVAGE PM series, and related information. You can also store system log data to a USB flash drive as text data. System log data is useful for analysis and troubleshooting of problems and malfunctions.

NOTE

You can store up to about 800 items of log data in the internal memory, including up to about 400 items related to the control surface, plus another 400 items. If you try to store more data, the system will delete the oldest data to accommodate newer data.

1 Press the **SETUP** button on the menu bar to open the **SETUP** window.



2 Press the **MAINTENANCE** button to open the **MAINTENANCE** popup window.

This window includes several pages, which you can switch between using the tabs located at the top of the window.

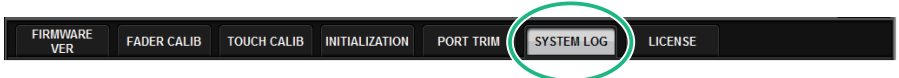

3 Press the **SYSTEM LOG** tab.

The system switches to the “SYSTEM LOG page” (p.1015).

4 If desired, select the message types you want to display.

5 To export the log file, connect your flash drive to the USB port, and then press the EXPORT LOGS TO USB button.

The following files will be stored in the root directory of the USB flash drive.

rivage_systemlog_user.txt	System log file
rivage_systemlog_dvlp.log	Support service file
rivage_systemlog_panl.txt	

* The date and time is added to all files. For a system log file, "rivage_systemlog_YYYYMMDDhhmmss_user.txt"

NOTE

If you want to store the files using RIVAGE PM Editor, they will be stored in the storage location specified on the SAVE/LOAD window. If the specified storage location is not valid, the EXPORT LOGS TO STORAGE button will be disabled. If you do not have an Administrator account for a computer running PM Editor, you will be unable to store files in the root directory on the C drive (or the boot disk). For Windows, start RIVAGE PM Editor by launching it as an administrator. For Macs, logs cannot be saved to the boot disk.

SYSTEM LOG page

MAINTENANCE

FIRMWARE VER FADER CALIB TOUCH CALIB INITIALIZATION PORT TRIM **SYSTEM LOG** LICENSE

MESSAGE TYPES: FATAL WARNING CAUTION INFO

02 / 10 / 2016 08 : 20 : 55	CS-R10	1	SYSINFO	Power State CS B : [Fine]
02 / 10 / 2016 08 : 20 : 55	CS-R10	1	SYSINFO	Cooling Fan State : [Fine]
02 / 10 / 2016 14 : 43 : 15	CS-R10	1	SYSINFO	Power State CS A : [Fine]
02 / 10 / 2016 14 : 43 : 15	CS-R10	1	SYSINFO	Power State CS B : [Fine]
02 / 10 / 2016 14 : 43 : 15	CS-R10	1	SYSINFO	Cooling Fan State : [Fine]
02 / 15 / 2016 08 : 17 : 09	CS-R10	1	SYSINFO	Power State CS A : [Fine]
02 / 15 / 2016 08 : 17 : 09	CS-R10	1	SYSINFO	Power State CS B : [Fine]
02 / 15 / 2016 08 : 17 : 09	CS-R10	1	SYSINFO	Cooling Fan State : [Fine]
02 / 16 / 2016 08 : 50 : 18	CS-R10	1	SYSINFO	Power State CS A : [Fine]
02 / 16 / 2016 08 : 50 : 18	CS-R10	1	SYSINFO	Power State CS B : [Fine]
02 / 16 / 2016 08 : 50 : 18	CS-R10	1	SYSINFO	Cooling Fan State : [Fine]
02 / 16 / 2016 09 : 11 : 02	CS-R10	1	SYSINFO	Power State CS A : [Fine]
02 / 16 / 2016 09 : 11 : 02	CS-R10	1	SYSINFO	Power State CS B : [Fine]
02 / 16 / 2016 09 : 11 : 02	CS-R10	1	SYSINFO	Cooling Fan State : [Fine]
02 / 16 / 2016 14 : 15 : 38	CS-R10	1	CAUTION	Power loss to PSU detected (CS B)
02 / 16 / 2016 14 : 15 : 49	CS-R10	1	SYSINFO	Power State CS B : [Fine]
02 / 16 / 2016 14 : 15 : 55	CS-R10	1	WARNING	Cooling fan error! Contact Yamaha service
02 / 16 / 2016 14 : 15 : 58	CS-R10	1	SYSINFO	Cooling Fan State : [Fine]

EXPORT LOGS TO USB

This screen contains the following items.

1 MESSAGE TYPE buttons

Enable you to select message types to display or hide on the SYSTEM LOG page. The following message types are included.

2 Scroll knob

You can scroll the list using the screen encoder.

FATAL: Information regarding errors, such as malfunctions

WARNING: Information regarding problems that could lead to the unit's malfunction or intermittent audio, which might interrupt operation

CAUTION: Information regarding circumstances that require attention but do not necessarily interrupt operation

INFO: Reference information (such as power-on information) that will not lead to problems

NOTICE

- Message type selection is stored after the power is turned off.

3 EXPORT LOGS TO USB button

This button becomes active when a USB flash drive is connected to the USB port. Press this button to store the current system log file to the USB flash drive.

System dump (CS-R10, CS-R10, CSD-R7)

If the RIVAGE PM series experiences a software problem during operation, it will dump (store) the system status at that point in the internal memory of the control surface.

If the problem is related to software, an error message (something like the one below) will appear.

NOTICE

- If you see this error message, restart the control surface as soon as possible.

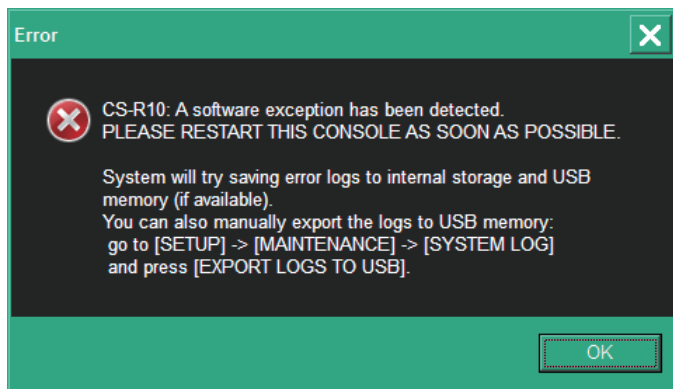

Press the OK button. The SAVE/LOAD screen will be displayed and the following files will be stored in the internal memory.

- 1 Press the SETUP button on the menu bar to access the SETUP screen.**
- 2 Press the MAINTENANCE button to access the MAINTENANCE popup window.**
- 3 Press the SYSTEM LOG tab to access the SYSTEM LOG page.**
- 4 Press the EXPORT LOG TO USB button.**

The system log file, including the system dump file will be stored.

NOTE

Stored data is useful for analysis and troubleshooting of problems and malfunctions. If you consult your Yamaha dealer, please be sure to provide the stored data along with information regarding the trouble or malfunction.

DSP-RX INFORMATION

You can upgrade the DSP-RX to a DSP-RX-EX by installing an optional DEK-DSP-RX (a DSP expansion kit) installed and following the related processes.

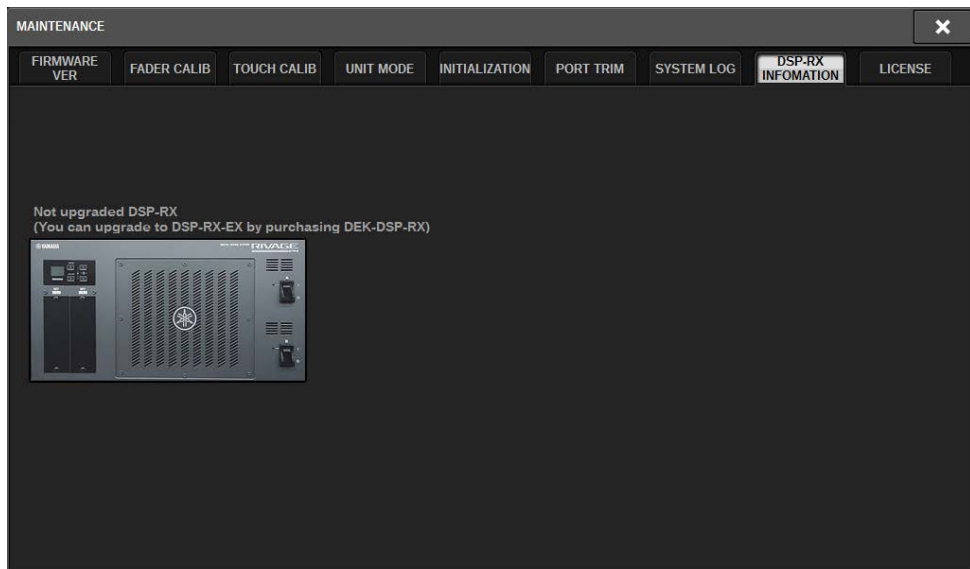

Please consult your Yamaha dealer for more information on the installation and related processes.

Adjusting the input/output gain

If necessary, you can make fine adjustments to the input and output gain.

1 Press the **SETUP** button on the menu bar to access the **SETUP** screen.



2 Press the **MAINTENANCE** button to access the **MAINTENANCE** popup window.

This window includes several pages, which you can switch between using the tabs located at the top of the window.

3 Press the **PORT TRIM** tab.

The view switches to the “PORT TRIM page” (p.1012).

4 Select a component and port for which you want to adjust the input/output gain.

5 Press an on-screen knob to select it, and then use the corresponding screen encoder to adjust the value.

6 Press the **CLOSE** button.

Console Status

Setting the date and time of the internal clock

This section explains how to set the date and time of the clock built into the CL unit, and how to select a date and time display format. The date and time you specify here will affect the time stamp used when saving or loading a scene. When connected to RIVAGE PM Editor, the internal clock automatically synchronizes to the computer's time.

1 Press the **SETUP** button on the menu bar to access the **SETUP** screen.



2 Press the **DATE/TIME** button.

The “DATE/TIME popup window” (p.1021) appears.

3 In the **FORMAT** field, press the **MODE** buttons several times to select the desired format for date and time display.

You can select from the following display formats.

• Date

MM/DD/YYYY (Month/Day/Year) DD/MM/YYYY (Day/Month/Year) YYYY/MM/DD (Year/Month/Day)

• Time

24-Hour (hours shown in the range of 0–23) 12-Hour (hours shown in the range of AM0–AM11 and PM0–PM11)

4 Use the screen encoders on the top panel to specify the current date and time.

5 When you finish making settings, press the OK button.

The date, time, and display format you specified will be finalized, and the popup window will close. If you press the CANCEL button or the “x” symbol instead of the OK button, your changes will be discarded and the popup window will close.

DATE/TIME popup window

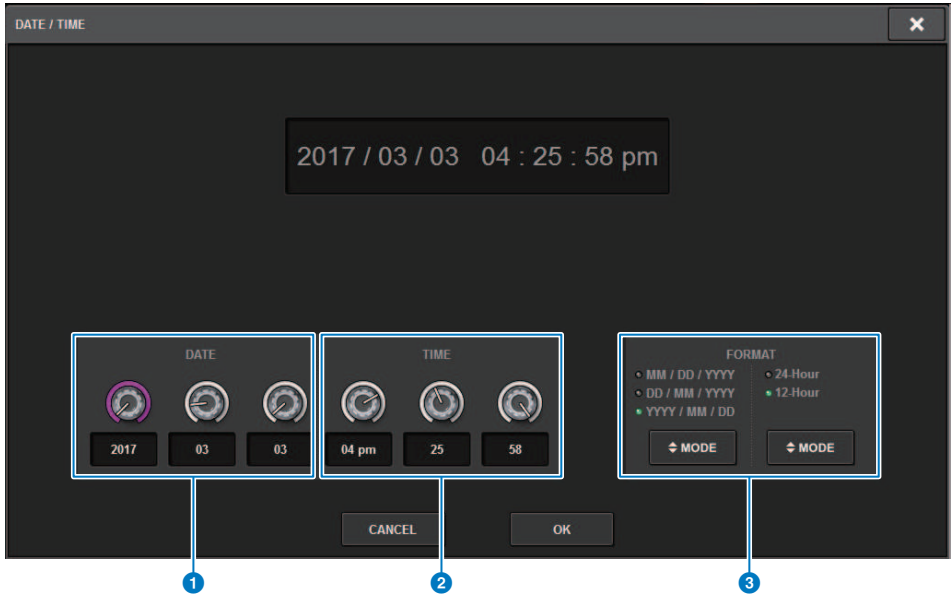

This screen contains the following items.

- 1 DATE**
Specifies the date of the internal clock.
- 2 TIME**
Specifies the time of the internal clock.
- 3 FORMAT field (display format)**
This field specifies the format in which the date and time of the internal clock are displayed.

Panel Settings

Specifying the brightness of the touch screens, LEDs, channel name displays, and lamps

This section explains how to specify the brightness and contrast of individual touch screens, top panel LEDs and channel name displays, and lamps connected to the rear panel LAMP connectors of the control surface. You can save four different settings in banks A–D, and select one of them.

- 1 Press the **SETUP** button on the menu bar to access the **SETUP** screen.**



- 2 In the field located on the bottom row of the **SETUP** screen, press one of the **BANK A–D** buttons.**

You can save four different brightness settings in banks A–D, and switch among them rapidly if desired.

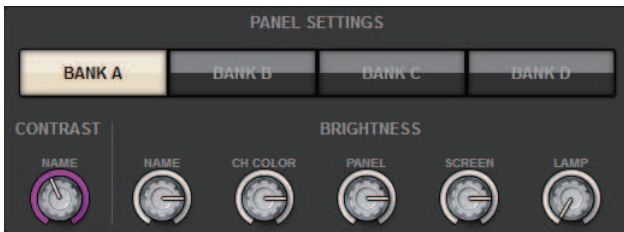

3 Use the screen encoders to set the following parameters.

- **BANK A-D**.....Enable you to select the target bank (A-D).

CONTRAST field

- **NAME**.....Adjusts the contrast of the characters in the channel name display on the top panel.

BRIGHTNESS field

- **NAME**.....Adjusts the brightness of the channel name displays on the top panel. This will also change the CH COLOR brightness. If you want to adjust the CH COLOR brightness after setting the name display brightness, use the CH COLOR knob.
- **CH COLOR**.....Adjusts the brightness of the channel colors on the top panel. This lets you apply a relative adjustment to only the channel color brightness without changing the channel name display brightness.
- **PANEL**.....Adjusts the brightness of the top panel LEDs.
- **SCREEN**.....Adjusts the brightness of the touch screens. If you have set the brightness to lower than level 2, the system will start up next time with a brightness setting of 2 so that you will be able to see the screen.
- **LAMP**.....Adjusts the brightness of the lamps connected to the rear panel LAMP jacks.

4 If desired, switch among banks A-D, and make settings for the other bank in a similar manner.

Now you can switch among the BANK A-D buttons to change the brightness of the touch screens, LCDs, channel name displays, and lamps in a single operation. You can also assign this parameter to a USER DEFINED key, and press that key to switch among banks A-D.

Console Lock

You can temporarily prohibit console operations in order to prevent unwanted operation. This setting completely disables operations of the panel and touch screen, so that controllers cannot be operated by an accidental touch or by an unauthorized third party while the operator is taking a break.

NOTE

- If you forget the password and cannot defeat Console Lock, press the [RESET] switch on the rear panel. Alternatively, turn the power to the console off and then on to unlock it.
- Even while the console is locked, control from an external device via MIDI will still operate as usual.

1 Press the **SETUP** button on the menu bar to access the **SETUP** screen.



2 Press the **CONSOLE LOCK** button.

The “PASSWORD popup window” (p.1026) appears.

3 After entering the password in the PASSWORD field, enter the same password in the RE-ENTER PASSWORD field for verification, and finally press the OK button.

The CONSOLE LOCK screen will appear, the Console Lock function will be enabled, and all controllers (excluding the MONITOR A/B knobs, TALKBACK LEVEL knob, PHONES A/B LEVEL knobs, and brightness control knob) will become inoperable.

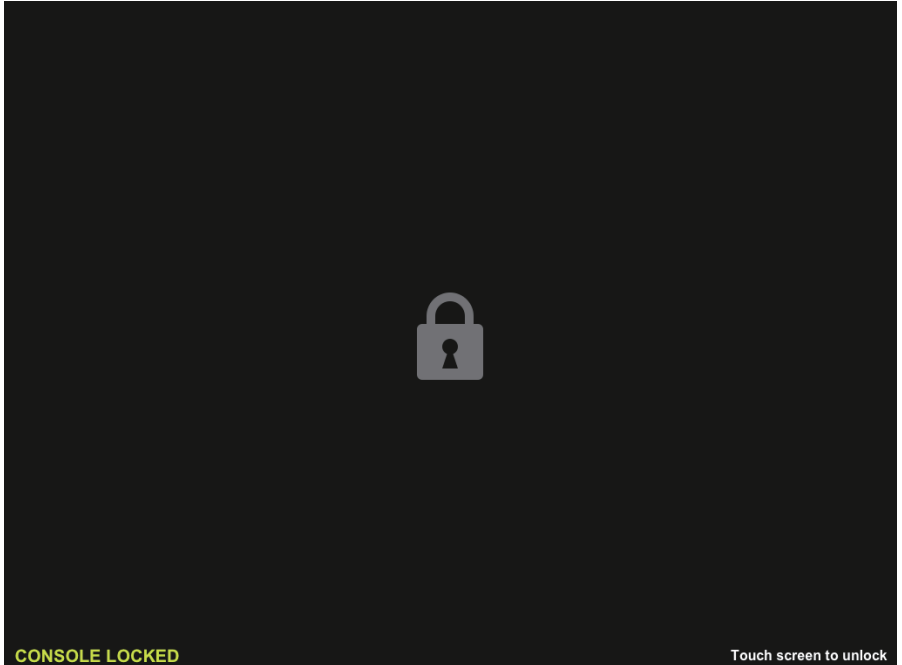

PASSWORD popup window

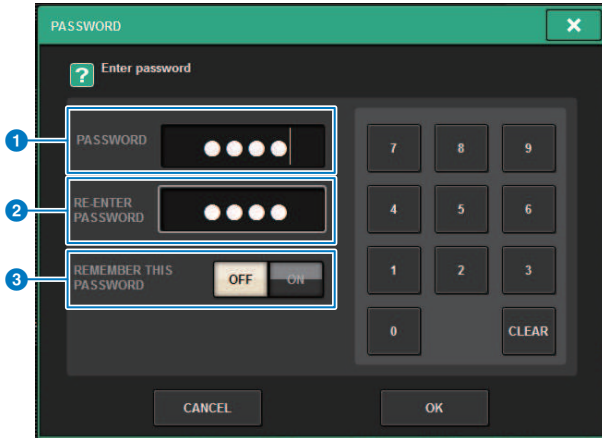

This screen contains the following items.

- 1 PASSWORD field**
- 2 RE-ENTER PASSWORD field**
Enter the password once again.
- 3 REMEMBER THIS PASSWORD button**
If this button is on, you will need to use the same password next time.

Unlocking the console

1 Press the CONSOLE LOCK screen.

If no password has been set, Console Lock will be defeated. If a password has been set, the PASSWORD popup window will appear, enabling you to enter the password.

2 Enter the password and press the OK button.

The console will be unlocked, the system will display the SETUP screen, and the controllers will be operable once again.

Specifying the CONSOLE LOCK screen image

You can display an image file on the CONSOLE LOCK screen. In the SAVE/LOAD popup window, specify the image file that you want to display, and then load it from the USB flash drive. For a procedure on loading a file from a USB flash drive, refer to “Loading a file from a USB flash drive.”

NOTE

Only BMP, JPEG, or PNG image files can be loaded.

Setting up RIVAGE PM Editor and RIVAGE PM StageMix

About RIVAGE PM Editor

RIVAGE PM Editor (called “PM Editor” in this book) is application software that enables you to use your computer to perform off-line editing by preparing the RIVAGE PM series settings in advance, and also to monitor and operate the RIVAGE PM series (on-line monitoring/operation).

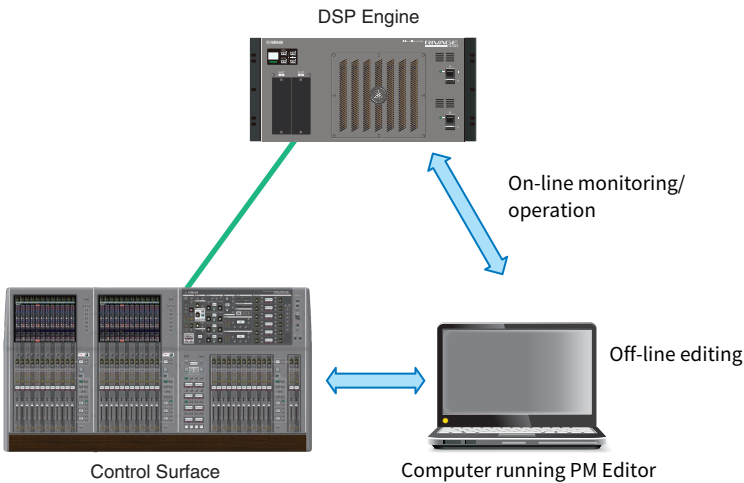

NOTE

- Operations in PM Editor and operations on the control surface are almost identical.
- Parts of this application software are based on open-source software. For information regarding software licenses, please see the LICENSE screen.

On-line monitoring/operation

1 Connect a computer (that has PM Editor installed) to the DSP engine (or to the control surface) using an Ethernet cable.

For more information on configuring the network, please refer to the “RIVAGE PM Editor Installation Guide.”

NOTE

Up to two instances of PM Editor can be connected. If you want to connect two instances of PM Editor to the DSP engine (or to the control surface), use a network hub to make connections. Alternatively, you can connect one instance of PM Editor to the DSP engine and another instance to the control surface.

2 Start PM Editor.

The following screen appears at start-up.

RIVAGE PM Editor

SELECT MIXER TYPE

RIVAGE PM10

RIVAGE PM7

RIVAGE PM5

RIVAGE PM3

SELECT DSP

DSP-R10

DSP-RX

DSP-RX-EX

NUMBER OF WINDOWS

1 2 3

NETWORK INTERFACE

Ethernet

Connect

Note:
The selected network interface requires the following settings

IP Address	192.168.53.1 - 192.168.53.32
Subnet Mask	255.255.255.0

Use Offline Quit

NOTE

- Although the screen (that is displayed in response to differently-configured panel elements, such as User Defined Keys) varies depending on the MIXER TYPE setting, the same data will be processed. In addition, on-line connection to PM Editor will be unaffected.
- If the DSP selection does not match the actual DSP engine, you will be unable to connect to the DSP engine on-line. Select the type of the DSP engine that you are actually using, because the number of available input channels varies depending on the DSP type.

3 In SELECT MIXER TYPE, select the RIVAGE PM Series unit; and in NETWORK INTERFACE, select the network that you will use.

If an IP address that can be connected to the selected network is specified, the Connect button can be pressed.

4 Click the Connect button so that the RIVAGE PM series will be linked to PM Editor.

NOTE

If you plan to link channel block selection in PM Editor with that of console bay R, press [SETUP] -> [PREFERENCES] -> MISC tab to access the LINK TO/FROM CONSOLE field, and then set FADER BANK SEL (BAY R) to “on”.

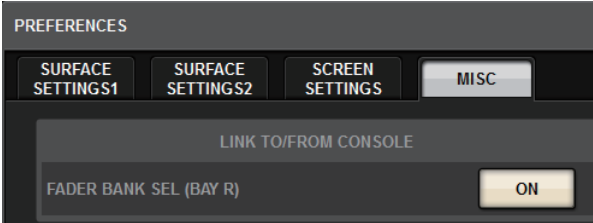

Once the DSP engine detects PM Editor on-line, the DEVICE SYNC screen appears.



When connecting PM Editor, you must specify the data sync direction for the DSP engine.

5 select “EDITOR ← DSP.”

6 Press the SYNC button.

Parameter settings on the RIVAGE PM series will be copied to PM Editor. Once data synchronization is completed, the line indicating synchronization is displayed in green.

7 Edit the mixing data.

PM Editor startup screen

RIVAGE PM Editor

SELECT MIXER TYPE

RIVAGE PM10
 RIVAGE PM7
 RIVAGE PM5
 RIVAGE PM3

SELECT DSP

DSP-R10
 DSP-RX
 DSP-RX-EX

NUMBER OF WINDOWS

1 2 3

NETWORK INTERFACE

Connect

Note:
The selected network interface requires
the following settings

IP Address	192.168.53.1 - 192.168.53.32
Subnet Mask	255.255.255.0

Use Offline Quit

1 NUMBER OF WINDOWS

Select the number of screens to display (1–3).

The screens correspond to each bay as shown below.

- 1st screen: BAY R
- 2nd screen: BAY C
- 3rd screen: BAY L

The following operations will always make the main screen (BAY R) the target.

- Full-screen display (zoom) toggle
- Toggle between the OVERVIEW and SELECTED CHANNEL VIEW screens using the Esc key (the F2 key is enabled in each window)

Off-line editing

1 Start PM Editor.

The following screen appears at start-up.

RIVAGE PM Editor

SELECT MIXER TYPE

RIVAGE PM10

RIVAGE PM7

RIVAGE PM5

RIVAGE PM3

SELECT DSP

DSP-R10

DSP-RX

DSP-RX-EX

NUMBER OF WINDOWS

1 2 3

NETWORK INTERFACE

Connect

Note:
The selected network interface requires the following settings

IP Address	192.168.53.1 - 192.168.53.32
Subnet Mask	255.255.255.0

Use Offline Quit

2 Press the Use Offline button.

3 Edit the mixing data.

- 4 When you finish editing the data, save the setting file using the SAVE/LOAD screen.**
- 5 Exit the application.**

Synchronizing the edited mixing data

1 Start PM Editor.

The following screen appears at start-up.

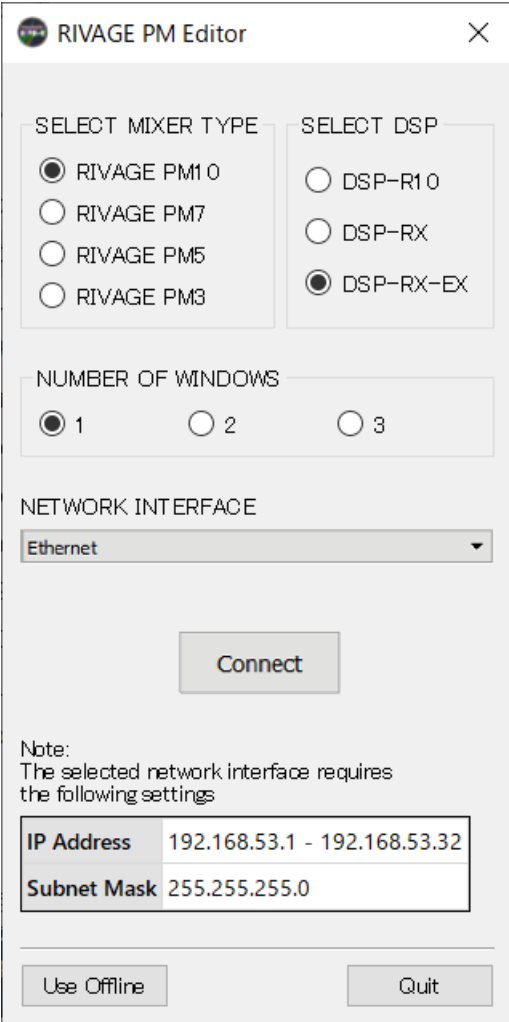

The screenshot shows the RIVAGE PM Editor start-up dialog box. It has a title bar with the RIVAGE logo and the text "RIVAGE PM Editor" and a close button (X). The dialog is divided into several sections:

- SELECT MIXER TYPE:** Four radio buttons are listed: RIVAGE PM10 (selected), RIVAGE PM7, RIVAGE PM5, and RIVAGE PM3.
- SELECT DSP:** Three radio buttons are listed: DSP-R10, DSP-RX, and DSP-RX-EX (selected).
- NUMBER OF WINDOWS:** Three radio buttons are listed: 1 (selected), 2, and 3.
- NETWORK INTERFACE:** A dropdown menu is set to "Ethernet".
- Connect:** A button to initiate the connection.
- Note:** A text block stating "Note: The selected network interface requires the following settings".
- IP Address:** A text field containing "192.168.53.1 - 192.168.53.32".
- Subnet Mask:** A text field containing "255.255.255.0".
- Use Offline:** A button at the bottom left.
- Quit:** A button at the bottom right.

2 In SELECT MIXER TYPE, select the RIVAGE PM series unit; in NETWORK INTERFACE, select the network that you will use.

If an IP address that can be connected to the selected network is specified, the Connect button can be pressed.

3 Click the Connect button.

Once the DSP engine detects PM Editor on-line, the DEVICE SYNC screen appears.

4 Select “EDITOR → DSP.”

5 Press the SYNC button.

Parameter settings in PM Editor will be copied to the RIVAGE PM series. Once data synchronization is completed, the line indicating synchronization will be displayed in green.

NOTE

- If the DSP engine is connected on-line with the control surface, the EDITOR -> DSP synchronization is disabled.
- Edited mixing data can be saved to a USB flash drive, and loaded directly to the control surface.

RIVAGE PM Editor On-screen operation

Using the mouse wheel

You can use the mouse wheel as if you were operating the [TOUCH AND TURN] knob on the unit.

Using the PC keyboard

You can use the PC keyboard to enter text as if you were operating the keyboard screen on the unit.

Menu bar

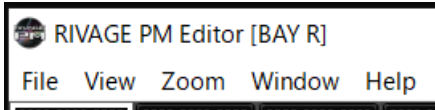

■ File menu

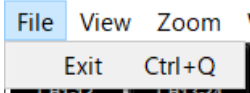

This is a menu for file operations.

Exit Exits PM Editor.

■ View menu

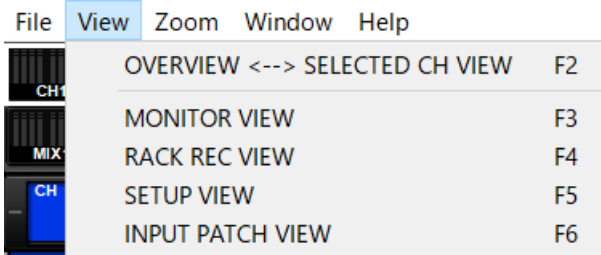

Selects a screen to view.

■ Zoom menu

Specifies a zoom percentage for the screen.

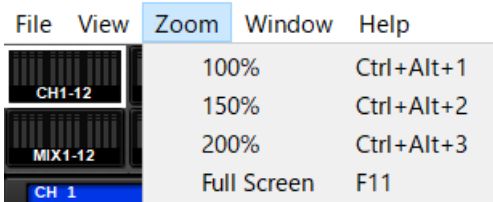

Full Screen: PM Editor is displayed full screen.

■ Window menu

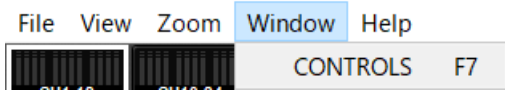

CONTROLS: Displays the screen for the panel operation of the control surface.

■ **Help menu**

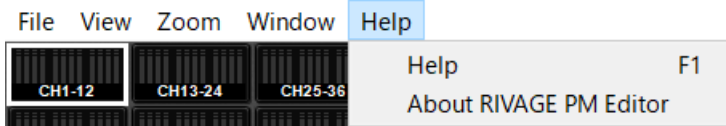

Help: Opens a Web browser to display the manual library.

About RIVAGE PM Editor: Opens the “About RIVAGE PM Editor” screen, which displays the version number of PM Editor.

NOTE

You must connect to the Internet to view the manual library.

About RIVAGE PM Editor screens

PM Editor screens are identical to those on the control surface. However, parts that you cannot control in PM Editor are hidden, as shown below.

Press the [F2] key repeatedly to toggle between the OVERVIEW screen and the SELECTED CHANNEL VIEW screen.

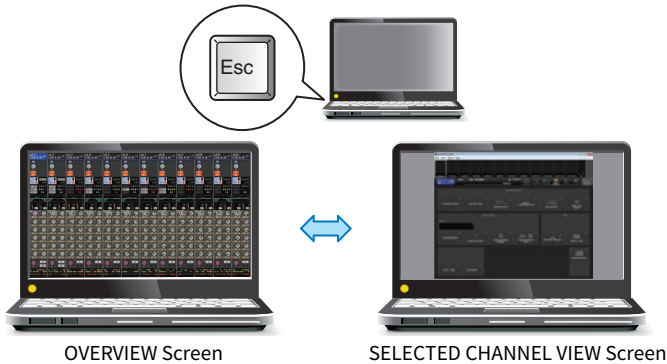

CONTROLS

You can perform panel operation of the control surface from PM Editor. Press the CONTROLS (F7) button to access the respective SETUP screen.

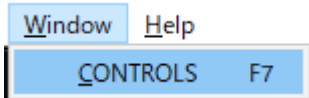

NOTE

If you have selected Full Screen (F11) from the Zoom menu, each CONTROLS screen will be displayed in the meter section.

Switching CONTROLS screens



Use the left and right arrow buttons in the upper-left corner to select the desired CONTROLS screen.

MUTE MASTER screen



You can switch MUTE MASTER on or off.

USER DEFINED KEYS screen



You can switch the functions assigned in the USER DEFINED KEYS screen on or off. Buttons for the functions that you cannot control in PM Editor will be grayed out.

USER DEFINED KNOBS screen



You can switch the function assigned in the USER DEFINED KNOBS screen on or off. Buttons for the functions that you cannot control in PM Editor will be grayed out.

Setting up RIVAGE PM Editor and RIVAGE PM StageMix > Operating the faders in the METER screen (Full Screen) (RIVAGE PM Editor)

Operating the faders in the METER screen (Full Screen) (RIVAGE PM Editor)

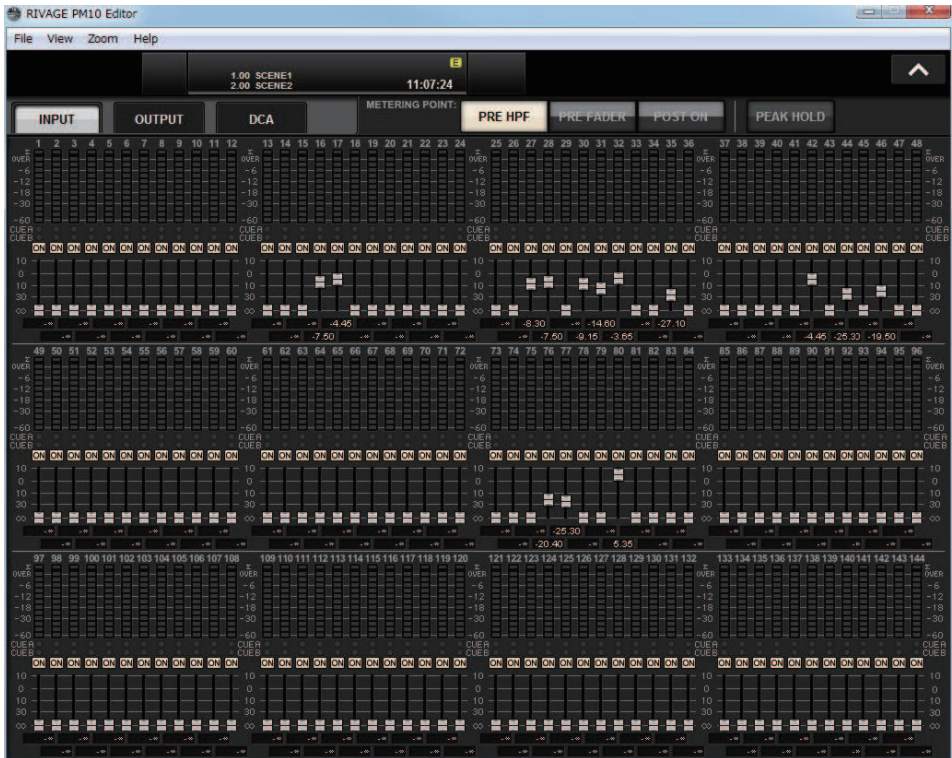

PM Editor enables you to control the faders or channel on/off using the mouse in the METER screen (Full Screen).

The fader indicators will appear thicker at the nominal and bottom positions.

Saving and loading a file (RIVAGE PM Editor)

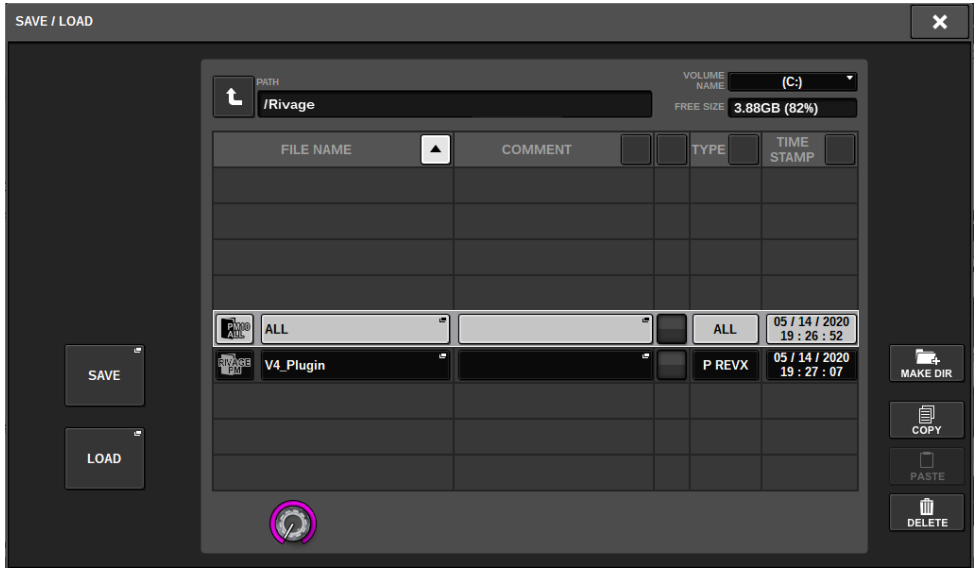

In PM Editor, you can specify a directory to/from which to save or load a file. The file format that PM Editor supports is expressed with the extension .RIVAGEPM. Internal setting files of the RIVAGE PM series will be saved.

NOTE

- You can save .RIVAGEPM files (created in PM Editor) in a USB storage device connected to the computer, and then load the files directly to the control surface via the USB port. Similarly, if you save .RIVAGEPM files from the control surface to a USB storage device, you can load them into PM Editor.
- If you do not have an Administrator account for the computer that has PM Editor installed, you will be unable to store files in the root directory on the C drive.

Initializing PM Editor

- 1 Press [SETUP] -> [MAINTENANCE] -> [INITIALIZATION] tabs to access the INITIALIZATION page.**

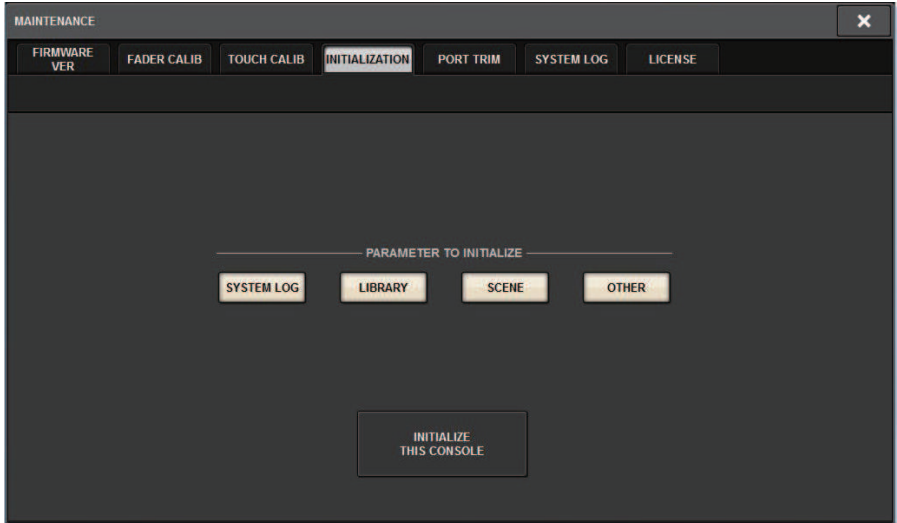

- 2 You can select multiple items to be initialized as required by the desired initialization method.**

- 3 Press the INITIALIZE THIS CONSOLE button.**

A dialog box will ask you to confirm the Initialization operation.

- 4 Press the OK button in the confirmation dialog box.**

The Initialization operation starts.

NOTE

Once PM Editor is initialized, the application will restart automatically.

About RIVAGE PM StageMix

RIVAGE PM StageMix (subsequently called PM StageMix) is software for remotely operating this unit from an iPad that is connected via Wi-Fi. This allows you to mix remotely while hearing the sound in a listening position such as the audience seating or in front of the monitor speakers. Up to two instances can be connected to one control surface unit.

Network settings for the control surface

1 Press the **SETUP** button to access the **SETUP** screen.



2 Press the **NETWORK** popup button.

The **NETWORK** popup window appears.

3 Press the **FOR MIXER CONTROL** tab to access the **IP SETTING** screen.

4 Turn the **ENABLE** button on.

5 Specify the IP address and subnet mask.

Unusable values are shown in red.

NOTE

If the IP address setting fails, such as when a device of the same IP address is connected to the network, the message “IP Address for StageMix is not available!” is displayed. Specify separate addresses.

6 Press the MISC tab to access the COMMUNICATION QUALITY screen.

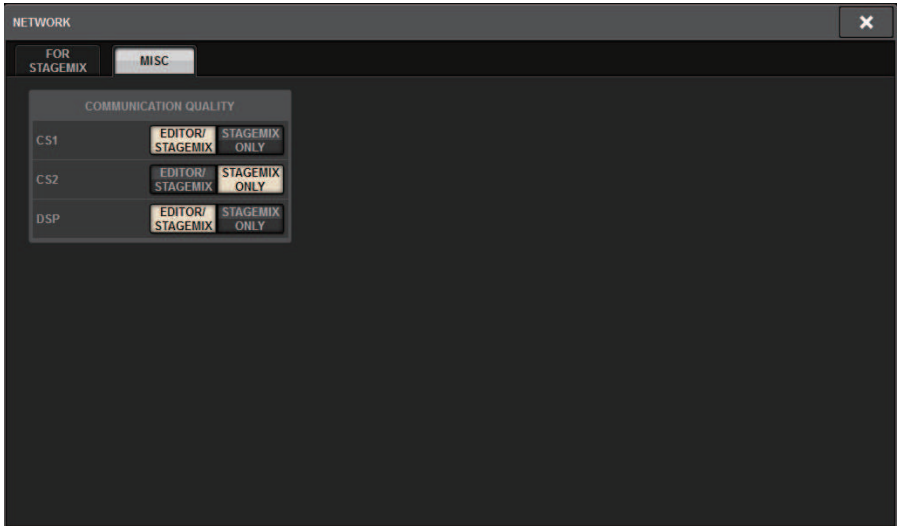

7 Specify the COMMUNICATION QUALITY setting for the NETWORK connector to which PM StageMix will be connected.

If you are using this in conjunction with PM Editor on the same NETWORK connector, select the EDITOR/STAGEMIX button. If you are using only StageMix, selecting the STAGEMIX ONLY button will lower the communication load.

Network settings on the iPad

- 1 On the iPad, tap Settings > Wi-Fi to access the Wi-Fi network screen.**
- 2 Turn Wi-Fi “on.”**
- 3 In the displayed list of networks, tap the network to which the RIVAGE PM series is connected.**

If a password is required, enter it before connecting.

Messages

Messages

The following message types may be displayed on the RIVAGE PM series.

Message	Description
[xx] connected	Device xx is connected.
[xx] disconnected!	Device xx is disconnected.
['LOCATION']: Multiple Word Clock Leaders found! Please check the connection status of each DSP Engine, the Engine ID via the LCD Display of each DSP Engine and the Word Clock Setup view.	[Location]: Multiple word clock leaders were found. Check each DSP engine's connection status, Unit ID, LCD screen, and word clock setting.
WORDCLOCKLEADER Not Found. Please Check TWINLANE WORDCLOCK Setting.	[Location]: No word clock leader was found. Assign a word clock leader.
BAY LINK released.	A Bay Link was released. This message appears if a bay link is released due to changes in the SEL LINK settings.
Bay x does not exist.	Control of a non-existent bay was attempted (only for CS-R10-S).
Cannot add event! (event list full)	The maximum number of events (2000) allowed on the list has been reached. You cannot add more events.
Cannot bookmark this popup	This popup window cannot be bookmarked.
Cannot close this page	This page cannot be closed.
Cannot create new MACRO. Insufficient Macro resources available.	The macro cannot be created because the macro resources have been completely used.
Cannot edit MACRO. Insufficient Macro resources available.	The macro cannot be edited because the macro resources have been completely used.
Cannot edit overlay!	You cannot change the Overlay offset to a value outside the specified range.
Cannot edit scene! (extracting scene data)	
Cannot load file (extracting scene data)	
Cannot recall! (extracting scene data)	
Cannot save file (extracting scene data)	One of these messages will be displayed if you attempt to perform an invalid operation during extraction of scene data, or if you try to use the Global Paste function only on the standalone control surface or only in PM Editor.
Cannot shutdown (extracting scene data)	
Cannot store! (extracting scene data)	
Cannot undo! (extracting scene data)	
Cannot update! (extracting scene data)	
Cannot load partial data now! (data in console corrupt; only ALL file can be loaded)	Partial loading of data is not possible. There is an inconsistency the data within the console. Please load all the data at once. (Up to V3.05)
Cannot mount the plug-in. No DSP resources available.	Additional plug-ins cannot be mounted due to insufficient DSP resources.
Cannot mount! (plug-in too large for selected location)	Plug-in failed to mount due to insufficient slot size.
Cannot open the bookmarked page	The bookmarked page failed to open.

Message	Description
Cannot paste!	The character string in the copy buffer is too long to be pasted.
Cannot perform this action! (scene data is now being extracted)	One of these messages will be displayed if you attempt to perform an invalid operation during extraction of scene data or during the Global Paste operation.
Cannot perform this action! (global paste in progress)	
Cannot recall from Macro Library, insufficient Macro resources available.	The macro library cannot be recalled because the macro resources have been completely used.
Cannot recall! (Internal error)	The scene cannot be recalled due to an internal error.
Cannot recall!!! (Sync Not Finished)	The scene you are trying to recall cannot be recalled because the synchronization between the console surface or PM Editor and the DSP engine has not been completed.
Cannot save now! (mixing data corrupt)	Control surface data is corrupt and cannot be saved. To recover the data, open the DEVICE SYNC window, and then re-sync data in the DSP -> CS sync direction. Alternatively, open the SAVE/LOAD window and load the control surface setting file. Otherwise, initialize the control surface. (Up to V3.05)
Cannot Select for GLOBAL PASTE! (too many scenes; max. 100)	You cannot select more than 100 scenes using the Global Paste operation.
Cannot store! (too many scenes; max. 1000)	The scene cannot be stored because the maximum number (1,000) of scenes that can be stored has already been reached.
Cannot sync in this direction! (DSP is already online)	If the control surface or PM Editor is connected with the DSP engine online, you will be unable to sync to transfer data to the DSP engine. (Up to V3.05)
Cannot sync in this direction! (mixing data corrupt)	Data is corrupt. Syncing in this direction is not available. If the control surface data is corrupt, syncing in the CS -> DSP direction is not available. If the DSP engine data is corrupt, syncing in the DSP -> CS direction is not available.
Cannot trigger event! (event not found)	
Cannot trigger event! (Event List can only be operated from main console)	You cannot trigger any events from a device other than the console, or trigger non-existing events.
Cannot trigger event! (event list disabled)	If an event list is disabled, you cannot recall events.
Cannot undo! (Internal error)	The Undo operation cannot be executed due to an internal error.
Cannot update scene!	The scene cannot be stored due to an internal error.
Channel pair made	The channels are paired.
Channel pair made. (plug-ins and GEQ's have been unmounted)	The channels are paired. Inserted plug-ins and GEQ are now unmounted.
Channel pair released	The channel pair was canceled.
Channel pair released. (plug-ins and GEQ's have been unmounted)	The channel pair was canceled. Inserted plug-ins and GEQ are now unmounted.
Channel set to default	Channel data is reset to its default value (initial value).
Console initialization [XX] completed	The console initialization is complete.

Message	Description
Console local I/O model type conflict!	An internal error occurred in the console. Connections inside the operating panel may be faulty. Please contact your Yamaha dealer listed at the end of the System Setup Guide or User's Manual (appendix) for repair.
Console local I/O not responding! Try updating console firmware.	The system cannot communicate with the console's built-in Local I/O section. Refer to the Firmware Update Guide (separate document) to use the FIRMWARE UPDATER for a recovery operation.
Console Network: ring connection open! Check cable connection.	The system detected that the ring connection of the console network is disconnected. Check for cable faults or disconnection.
Cooling fan error! (XXX) Contact Yamaha service	The system detected faulty cooling fans on the console. If you check the condition of the fan and find a problem, contact your Yamaha dealer to inspect the console.
Couldn't access the file	The specified directory or file does not exist.
Couldn't delete file	File deletion failed.
Couldn't rename file	Rename of file failed.
Couldn't write file!	The system attempted to save the file, but failed to write it to the USB storage device.
CUE turned off (Keyin)	The Keyin CUE was automatically released.
CUE turned off (Plug-in)	The plug-in CUE was automatically released.
CUE turned off (USB playback out)	The USB recorder output CUE was automatically released.
CUE turned off (USB recorder in)	The USB recorder input CUE was automatically released.
CUE turned off (USB recorder in/out)	The CUE of the USB recorder input/output was automatically turned off.
CURRENT SCENE UPDATED: SCENE #x.xx	This message is displayed when a scene is updated without displaying a confirmation message.
DANTE audio resource overflow.	There are insufficient audio resources on the audio network.
DANTE Connection Error!	In a daisy-chain connection, the primary and secondary connections are incorrect.
DANTE is not working by GIGA bit.	Gigabit is not enabled on the Dante audio network.
DANTE is working at Secondary.	The Dante audio network is operating on the secondary port.
DANTE setting mismatch.	The DIP switch settings of the Dante device differ from the actual settings.
DANTE module Error!	The Dante module has malfunctioned.
DANTE port does not have connection.	Not connected to the Dante network.
DCA ROLL-OUT: DCA members scrolling.	DCA members' fader assignment is scrolling in DCA ROLL-OUT mode.
DEVICE NOT SYNCED!	There is a device that is not SYNCED to the TWINLANE network. Open the DEVICE SYNC window and perform a SYNC.
Directory not empty!	The directory in the USB storage device cannot be deleted because the directory is not empty.
DSP Engine xx (Active): Disconnected.	Engine xx (active) was disconnected.
DSP Engine xx (Standby): Disconnected.	Engine xx (standby) was disconnected.

Message	Description
DSP Mirroring: 3 or more Engines found on the Console Network. Please remove unused Engines from the Network.	Three or more engines were found on the console network. Remove the unused engine(s) from the network.
DSP Mirroring: Active Engine Switched to xx.	The active engine has switched to xx.
DSP Mirroring: Engines are not synchronized. Please check system configuration.	Synchronization between engines is not occurring. Reconsider the configuration.
DSP Mirroring: Failed to switch Engine to xx. Error: reason.	Failed to switch to engine xx.
DSP Mirroring: No Active Engine. Select which Engine to set to Active.	There is no active engine. Select the engine that you want to make active.
DSP Mirroring: Switching can not be done now.	Switching is not currently possible.
DSP Mirroring: There are currently multiple Active Engines. Select which Engine to keep Active. The other Engine will be set to Standby.	There are multiple active engines. Select the engine that you want to keep active. The other engine will be set to standby.
DSP Mirroring: Unit ID combination of DSP Engines may be incorrect. Please ensure one Engine is set as #A and the other as #B.	The combination of unit IDs of the DSP engines might be incorrect. Check that one engine is set to #A and the other engine is set to #B.
Duplicate Console ID!	The CONSOLE ID is duplicated.
Editor initialization [XX] completed	The Editor initialization is complete.
Error occurred at Secondary Port.	While using redundant settings, the network cable of the secondary port was disconnected.
Fader bank snapshot is done.	Fader bank snapshot has been recorded.
File access busy!	The system did not complete the operation because it is currently processing internal data. Please wait and try again later.
File already exists!	A file with the same name as the one you are about to save already exists.
Finished loading file	File loading is complete.
Finished saving file	The file save operation is complete.
GENIUS.LAB is turned off due to unexpected program end.	Shutdown using a long-press of [SYSTEM] was not performed, so GENIUS.LAB is disabled.
GENIUS.LAB turned off	GENIUS.LAB is disabled.
GPI 5V output error! Disconnect GPI and check connection.	The system detected an abnormality at the GPI +5V output connector. Excessive current may exist due to a short-circuit to ground. Check the cable connection.
Home bookmarked	The status of the control panel and screens are bookmarked via the HOME key.
HY SLOTx:Primary is not working by GIGA bit.	The primary connection of HY SLOTx is active, and is not linked via Gigabit.
HY SLOTx:Secondary is not working by GIGA bit.	The secondary connection of HY SLOTx is active, and is not linked via Gigabit.
HY SLOTx:Dante switched to secondary port.	Although HY SLOTx is using a redundancy connection, only the secondary port is being used.
HY SLOTx:No Response from I/O DEVICE.	There is no response from the I/O device on HY SLOTx.
Illegal DIP Switch Setting.	The DIP switch settings of the R-series unit are invalid.
Illegal MAC Address!	Operating with an invalid MAC address.
Image file for Console Lock screen successfully loaded.	The image file for the Console Lock screen was loaded successfully.

Message	Description
Image file too large!	The system failed to load the image file for the Console Lock screen because the size is too large (exceeds 3072 x 768 pixels).
Inappropriate scene number (#XX)	An inappropriate scene number was assigned during the scene renumbering operation.
Internal DSP Error. Press SETUP and set the DSP ID.	An error occurred in the console's onboard memory. Reset the DSP ID from the SETUP window.
Internal error! (BUFFER_FULL)	An internal error occurred in the console. If this error is repeatedly displayed, please contact your Yamaha dealer listed at the end of the System Setup Guide or User's Manual (appendix) for repair.
Internal error! (PANELxx_COMMUNICATION_ERR)	An internal error occurred in the console. Possible internal operation panel communications fault. Please contact your Yamaha dealer listed at the end of the System Setup Guide or User's Manual (appendix) for repair.
Internal error! (PANELxx_DISCONNECTED)	An internal error occurred in the console. Possible connection fault inside the operating panel. Please contact your Yamaha dealer listed at the end of the System Setup Guide or User's Manual (appendix) for repair.
Internal memory corrupt! Try initializing console and restart.	Internal memory is corrupt. Initialize the console, and then restart it.
Internal memory corrupt! Try initializing editor and restart.	Internal memory is corrupt. Initialize the editor and then restart it.
Interval from Previous Event is too short!	The event execution interval in the event list is too short.
IP Address for StageMix is not available!	Failed to set the IP address for StageMix.
Loading aborted	File loading was interrupted.
Low Battery! (DSP Engine)	The capacity of the DSP engine's internal battery is low. The internal clock may not keep the correct time. Please contact your Yamaha dealer listed at the end of the System Setup Guide or User's Manual (appendix) for battery replacement.
Macro is protected.	The macro is protected, and your operation cannot be completed.
Max. HY slot channel count exceeded! (256)	In the DSP engine, the number of assignments to TWINLANE exceeds the maximum number (256) of HY SLOTS allowed. Limit the number to 256 or less.
Max. TWINLANE channel count exceeded! (400)	The number of output channels in the entire system assigned to TWINLANE exceeds the maximum number (400) of channels allowed. Limit the number to 400 or less.
MIDI: Data framing error!	MIDI data receive framing error occurred.
MIDI: Data overrun error!	MIDI data receive overrun error occurred.
MIDI: Rx buffer full!	The MIDI receive buffer is full.
MIDI: Tx buffer full!	MIDI transmit buffer is full.
Mismatch of currently installed firmware. For correct system operation, please ensure matching firmware is installed in all system elements.	A mismatch in firmware versions was detected. Update the firmware, and check again.

Message	Description
Mixing data corrupt on Control Surface! To recover:- Go to DEVICE SYNC window and re-sync data (DSP --> CS), OR - Go to SAVE/LOAD window and load a complete settings file, OR - Initialize this control surface	The internal data for the control surface is corrupt. To recover the data, access the DEVICE SYNC window, and then re-sync data in the DSP -> CS sync direction. Alternatively, access the SAVE/LOAD window and load the setting file. Otherwise, initialize the control surface. (Up to V3.05)
Mixing data corrupt on DSP Engine! To recover, go to DEVICE SYNC window and re-sync data (CS --> DSP).	The internal data of the DSP engine is corrupt. To recover the data, access the DEVICE SYNC window, and then re-sync data in the CS -> DSP sync direction. (Up to V3.05)
Mixing data corrupt on Editor! To recover:- Go to DEVICE SYNC window and re-sync data (DSP-> EDITOR), OR - Go to SAVE/LOAD window and load a complete settings file, OR - Initialize this editor	The Editor internal data is corrupt. To recover the data, access the DEVICE SYNC window, and then re-sync data in the DSP -> EDITOR sync direction. Alternatively, access the SAVE/LOAD window and load the setting file. Otherwise, initialize the control surface. (Up to V3.05)
Mixing data corrupt on Editor! To recover, go to DEVICE SYNC window and re-sync data (EDITOR --> DSP).	The Editor internal data is corrupt. To recover the data, access the DEVICE SYNC window, and then re-sync data in the EDITOR -> DSP sync direction. (Up to V3.05)
Multiple word clock leaders found!	Multiple DSP engines that are assigned as the word clock leader have been detected. Assign the word clock leader to only one unit in the system.
No Battery! (Console)	The console's internal battery is exhausted. The internal clock cannot keep the correct time. Please contact your Yamaha dealer listed at the end of the System Setup Guide or User's Manual (appendix) for battery replacement.
No Battery! (DSP Engine)	The DSP engine's internal battery is exhausted. The internal clock cannot keep the correct time. Please contact your Yamaha dealer listed at the end of the System Setup Guide or User's Manual (appendix) for battery replacement.
No scene to update. Store a scene first.	The Update function is not available because there is no scene. Store a scene first.
Offset values can be edited only when OVERLAY is ON	You can set the Overlay offset values only when Overlay is turned on.
Only one DCA can be rolled out at one time.	You cannot roll out DCA members on multiple bays simultaneously.
Operating as the word clock leader.	This unit is the Clock Leader.
Overlay turned off.	Overlay has been turned off.
Overlay turned on.	Overlay has been turned on.
Page bookmarked	The page is bookmarked.
Plug-in BPM values matched to TEMPO	The BPM parameter of effect plug-ins has been changed to match the tempo.
Power loss to PSU detected (CS X)	One of the two power supply units failed to supply power. "X" represents the power supply unit (A or B) on which a power failure was detected.
PREVIEW Mode: Cannot Use This Function.	This function cannot be used in Preview mode, and was ignored.
PREVIEW Mode: Disabled	Preview mode was disabled.
PREVIEW Mode: Enable	Preview mode was enabled.
Same page is already open	The page cannot be displayed because the same page is already open on another screen or window.

Message	Description
Saving aborted	The file save operation was interrupted.
Scene #XX already exists	The scene renumbering operation cannot be completed because a scene number that already exists was specified.
Scene #XX is empty!	A scene you tried to recall does not exist.
Scene #XX is protected!	The scene is protected, and your operation (for example, delete) cannot be completed.
Scene delete undone	The scene delete operation was undone.
Scene duplicate undone	The scene copy operation was undone.
Scene recall undone	The scene recall operation was undone.
Scene store undone	The scene store operation was undone.
Screen captured	A screen has been captured.
Software control for this card is disabled. Check the card's DIP SW setting.	This card is not working properly. Check the card's DIP switch setting.
Software exception detected! Restart this console as soon as possible.	An abnormality occurred in software. Restart this control surface immediately.
Software exception detected! Restart this editor as soon as possible.	An abnormality occurred in software. Restart Editor immediately.
Song file not found!	The song file to play cannot be found.
Switch Active Engine from xx to yy?	OK to switch the active engine from xx to yy?
Sync error! [XX]	The digital input signal at the [XX] connector is not syncing with the leader clock. Make sure that the input signal is syncing with the leader clock. Otherwise, noise may be heard.
System Config can only be viewed and edited using the Active DSP Engine.	System Config can be displayed and edited only for the active engine.
Temporary channel link released	A temporary channel link was canceled.
This device is currently online and cannot be changed.	This device is currently on-line. You cannot change the device type.
This device is not found.	This device is not found.
This feature is not available in editor software	This feature cannot be used in Editor.
This feature will be supported in a future software release.	This feature will be supported in a future software update.
This item is read only!	This item cannot be modified. This message appears if you attempt to change a Factory Preset title.
This setting can only be edited while in Capture mode.	This message appears when you try to perform an operation that can only be performed in capture mode.
Too many Monitor Sources! Max. 8 sources can be assigned.	Too many sources have been selected for monitor input. (Up to 8 sources can be assigned.)
Total MY slot power capability exceeded! Remove cards from unit XX	Normal operation is not possible because the power at the MY slots exceeds the maximum power allowed. Remove the MY cards from unit XX. For information on the maximum number of MY cards that can be used, please visit the Yamaha Pro Audio website at: http://www.yamahaproaudio.com/
TWINLANe total cable length too long (HY SLOT X)	The total length of cables on the TWINLANe network (HY slot X) is too long.

Message	Description
TWINLANE clock leader not found!	The TWINLANE clock leader cannot be found. One DSP engine in the system must be assigned as the word clock leader.
TWINLANE optical receiver input power margin low [XXX]	The power of the optical receiver for communication on the TWINLANE network is getting low. Check for cable faults or disconnection, and clean the connection.
TWINLANE: ring connection open! [XXX] Check cable connection.	The system detected disconnection of the ring connection on the TWINLANE network. Check for cable faults or disconnection.
TWINLANE: wrong cable connection!	The system detected an incorrect TWINLANE cable connection. Make sure that the ring connection is proper by connecting the cables in the order of IN-OUT.
Unassigned encoder	You operated an encoder for which no function is assigned.
Under a synchronization.	Currently synchronizing.
Unit Fan has Malfunctioned!	The fan of the R-series unit has malfunctioned.
Unit ID Duplicated!	There are duplicate UNIT IDs on the Dante audio network.
Unsupported file format!	An unsupported file format was detected and the file failed to load.
Unsupported USB storage format!	The USB storage format is incorrect or unsupported.
USB over-current error! Disconnect USB device (xxx)	An excessive current was detected on the USB port. Remove the USB device connected to the USB port, and check the port for abnormalities. ("FRONT", "RECORDER", "REAR1", "REAR2", "REAR3" are displayed for each USB port in xxx.)
USB recorder busy! Operation aborted	The two-track USB recorder is currently processing data. The new operation was aborted.
USB recorder: Cannot edit comment. No ID3 tag in the file.	The comment could not be edited because the ID3 tag is not present in the file.
USB recorder: Max. number of audio files exceeded!	The maximum number of song files allowed has been exceeded.
USB recorder: Metadata edit failed	Could not edit song file metadata.
USB recorder: Metadata successfully changed	Metadata for the song file was edited.
USB recorder: Playback stopped due to slow memory access!	Playback was interrupted due to insufficient access speed to the USB storage device.
USB recorder: Recording stopped due to slow memory access!	Recording was interrupted due to insufficient access speed to the USB storage device.
USB recorder: Recording stopped due to wrong word clock!	Recording on the USB recorder was stopped due to an inappropriate system word clock.
USB recorder: Storage full!	There is insufficient capacity in the USB storage device.
USB recorder: Storage mounted	The USB storage device is mounted.
USB recorder: Storage protected!	The USB storage device is protected.
USB recorder: This is the root folder for song files	You cannot browse the hierarchy above the root directory for the song files.
Word Clock Leader changed. ['LOCATION']: 'DSP xx'	The word clock leader was switched. [Location]: The Unit ID of the DSP engine that became the word clock leader (If a DSP engine outside the console network became the word clock leader, the DSP engine's Unit ID is displayed as OTHER DEVICE.)

Messages > Messages

Message	Description
Version mismatch.	There is an incompatibility between the versions of the R-series unit and of the Dante-enabled HY card.
Word Clock Sync Error!	The word clock setting on the Dante audio network is incorrect. Display the WORD CLOCK window and check the settings.
Wrong password!	You have entered an incorrect password to unlock the console.
Wrong word clock!	The system word clock is incorrect. Supply the correct word clock.
XX parameters set to default	XX parameters are reset to their default values. ("XX" represents the type, such as "EQ," or "Dynamics1.")

DSP Messages

An error message for caution or attention will be displayed on the front panel LCD, and will be indicated via the color indicator.

Error messages indicating caution

Repair might be required. Contact your Yamaha dealer.

LCD Message	Color Indicator Status	Description
*[ERR M0#] H/W ERROR MY SLOT#	Red (flashing)	A card inserted in the MY card slot is not accessible. A number sign (#) indicates the slot number in relation with the corresponding error.
*[ERR H0#] H/W ERROR HY SLOT#	Red (flashing)	A card inserted in the HY card slot is not accessible. A number sign (#) indicates the slot number in relation with the corresponding error.
*[ERR T11] TWINLANe T V B OP IP	Red (flashing)	The optical transceiver module on the HY256-TL/HY256-TL-SMF is faulty. T: Temperature, V: Voltage, B: Bias current, OP: Output Power, IP: Input Power This error may be resolved by the possible solution described below for [ERR T12].
*[ERR X0#] H/W ERROR	Red (flashing)	One of the internal parts is faulty. A number sign (#) indicates the internal part that has caused the corresponding error.
*[ERR X1#] H/W ERROR BOARD#	Red (flashing)	
*[ERR X16] MEMORY ERROR	Red (flashing)	
*[ERR F01] COOLING FAN ERROR	Red (flashing)	The cooling fans are faulty.

Names marked with an asterisk (*) are Unit IDs.

Error messages indicating a need for attention

LCD Message	Color Indicator Status	Description	Possible solution
*[ERR T0#] TWINLANe WRONG LOOP	Red (flashing)	Fiber optic cable is not connected properly. A number sign (#) indicates the error description. 1: Signal is looped back to the unit itself (IN-OUT). 2: Input connectors are connected to each other (IN-IN). 3: Output connectors are connected to each other (OUT-OUT).	Check the cable connection.
*[ERR T07] TWINLANe OPEN LOOP	Yellow (lit steadily)	Fiber optic cable is not connected properly. The TWINLANe network loop is not closed.	Check the cable connection.

*[ERR T12] TWINLANe T V B OP IP	Yellow (lit steadily)	An error has occurred with the optical transceiver module on the HY256-TL/HY256-TL-SMF. T: Temperature, V: Voltage, B: Bias current, OP: Output Power, IP: Input Power	<ul style="list-style-type: none"> • Make sure that the cable is securely inserted. • Use a commercially-available cleaning tool for fiber optics to clean both ends of the cable and the connectors on the card. • Change to a different cable. <p>If the solutions above do not resolve the issue, have the unit checked by an authorized technician, although the problem will not affect operation of the unit. Please contact your Yamaha dealer.</p>
*[ERR T0#] CONSOLE NETWK WRONG LOOP	Red (flashing)	Ethernet cable is not connected properly. A number sign (#) indicates the error description. 4: Signal is looped back to the unit itself (IN-OUT). 5: Input connectors are connected to each other (IN-IN). 6: Output connectors are connected to each other (OUT-OUT).	Check the cable connection.
*[ERR T08] CONSOLE NETWK OPEN LOOP	Yellow (lit steadily)	Ethernet cable is not connected properly. The Console network loop is not closed.	Check the cable connection.
*[ERR W01] BNC UNLOCK	Red (flashing)	The unit is unable to lock to the word clock that is being input from the WORD CLOCK IN connector (if the WORD CLOCK IN has been selected as the clock source).	Check the external device that is supplying the word clock.
*[ERR W02] DATA CORRUPT TRY RE-SYNC	Red (flashing)	Mix data inside the unit has been corrupted. The loading of a file or data syncing might have been interrupted due to power outage.	Try data syncing again by transmitting data from the control surface.
*[ERR P01] POWER A OFF	Yellow (lit steadily)	Power is not supplied from power supply unit A.	Make sure that the power switch on power supply unit A is turned on, and that the power cord is connected to the unit and power supply unit A.

Messages > DSP Messages

*[ERR P02] POWER B OFF	Yellow (lit steadily)	Power is not supplied from power supply unit B.	Make sure that the power switch on power supply unit B is turned on, and that the power cord is connected to the unit and power supply unit B.
*[ERR C11] LOW BATT	Yellow (lit steadily)	The backup battery voltage is down to 2.8V or lower.	Please contact your Yamaha dealer immediately and have qualified Yamaha service personnel replace the backup battery.
*[ERR C12] NO BATT	Yellow (lit steadily)	The backup battery voltage is down to 2.45V or lower.	Please contact your Yamaha dealer immediately and have qualified Yamaha service personnel replace the backup battery.

Names marked with an asterisk (*) are Unit IDs

NOTE

If multiple issues occur at the same time, press the [▲] or [▼] key to view the corresponding error messages.

Yamaha Pro Audio global website
<https://www.yamahaproaudio.com/>
Yamaha Downloads
<https://download.yamaha.com/>

© 2015 Yamaha Corporation

Published 02/2025 YJ-K0