

ProVisionaire Kiosk

V1.0 User Guide

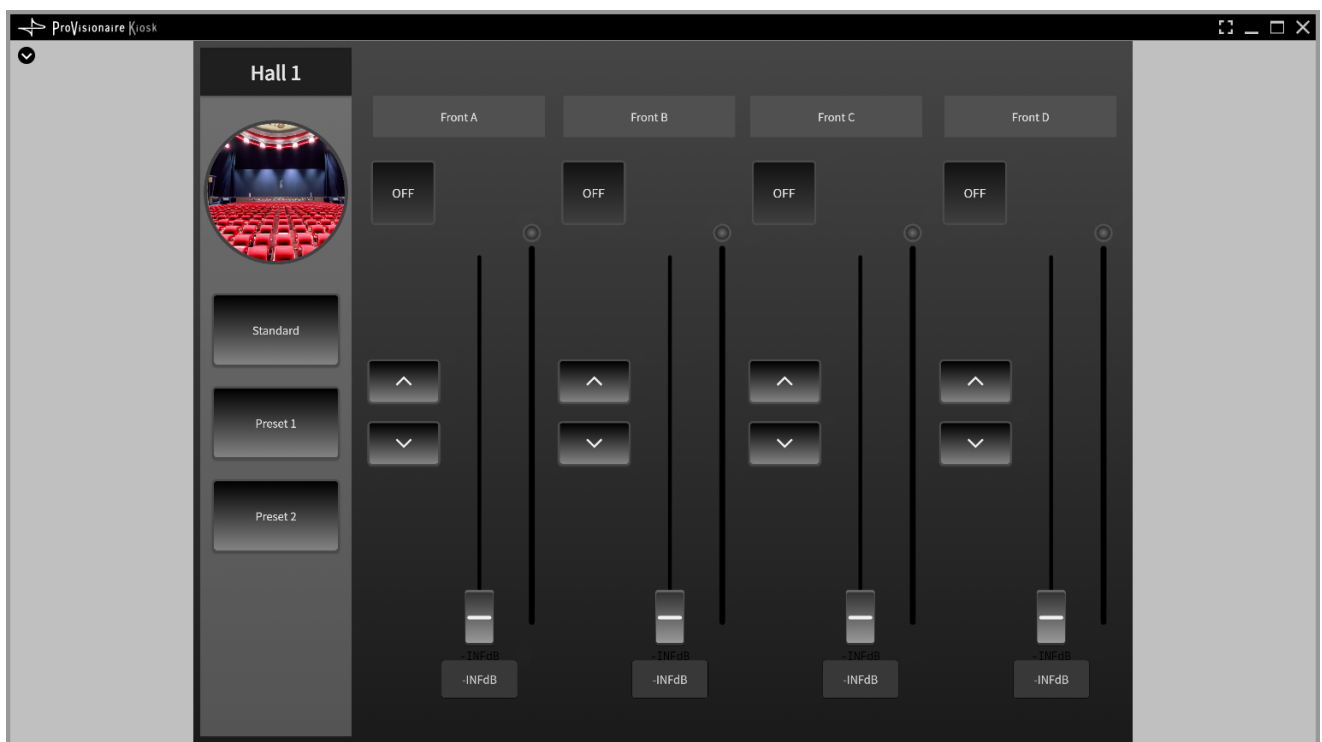

Contents

1. Introduction	2
1.1. Note	2
1.2. What you can do using ProVisionaire Kiosk	3
2. Operating requirements of the software	4
2.1. iOS/iPadOS	4
2.2. Windows	4
3. Installation procedure	5
3.1. iOS/iPadOS	5
3.2. Windows	5
4. Connection	6
4.1. iOS/iPadOS	6
4.1.1. Wi-Fi access point settings	6
4.1.2. Connecting to the target system	6
4.2. Windows	10
4.2.1. Connecting to target devices	10
5. Startup	12
5.1. iOS/iPadOS	12
5.2. Windows	12
5.2.1. Enabling Kiosk auto-start	13
6. Title bar	14
7. "Setup" dialog box	15
7.1. Network tab (Windows only)	15
7.2. Security tab	16
7.3. Log tab	19
8. Settings file management (the File Management button)	20
8.1. iOS/iPadOS	20
8.2. Windows	22
9. Troubleshooting	23

1. Introduction

Thank you for downloading Yamaha ProVisionaire Kiosk.

ProVisionaire Kiosk is an application for remotely controlling devices such as those compatible with DME7, RM-CR, RM-CG, DM7, DM3, and MusicCast.

ProVisionaire Kiosk works on a Windows computer, iPad, or iPhone.

1.1. Note

- All copyrights for this software and setup guide are the property of Yamaha Corporation.
- Unauthorized copying or modification of this software or setup guide in part or in whole is prohibited.
- Please be aware that Yamaha Corporation accepts no responsibility for any results or consequences that may follow from the use of this software and setup guide.
- All of the illustrations and screen shots in this setup guide are provided for the purpose of explaining operations. For this reason, they may differ from the actual specifications.
- iPad, iPhone, and AirDrop are registered trademarks of Apple Inc. in the United States and in other countries.
- IOS is a trademark or registered trademark of Cisco in the U.S. and other countries and is used under license.
- App Store and iTunes are registered service marks of Apple Inc., in the U.S. and other countries and regions.
- Windows is a registered trademark of Microsoft Corporation USA in the United States and in other countries.
- Please be aware of copyright when using audio sources for a commercial purpose. Infringement of copyright is prohibited by law.
- Company names and product names appearing in this document are the trademarks or registered trademarks of their respective owners.
- The application software may be updated without notice for improvement. The latest application software can be downloaded from the Yamaha Pro Audio website.
<https://www.yamahaproaudio.com/>

1.2. What you can do using ProVisionaire Kiosk

- You can control devices by loading controller files (extension: .pvksk) designed on ProVisionaire Control PLUS. Controller files can be loaded on both ProVisionaire Kiosk (Windows version) and ProVisionaire Kiosk (iOS/iPadOS version).
- A controller has multiple pages (screens consisting of multiple buttons, sliders, and other controls) that you can use for different purposes. You can place controls for multiple devices on one page.
- You can set three levels of access restrictions: Power User, Administrator, and Screen Lock. For details, refer to the “ProVisionaire Control PLUS User Guide.”
- You can switch the displayed page by recalling a preset on any device (Monitor Device). For details, refer to the “ProVisionaire Control PLUS User Guide.”

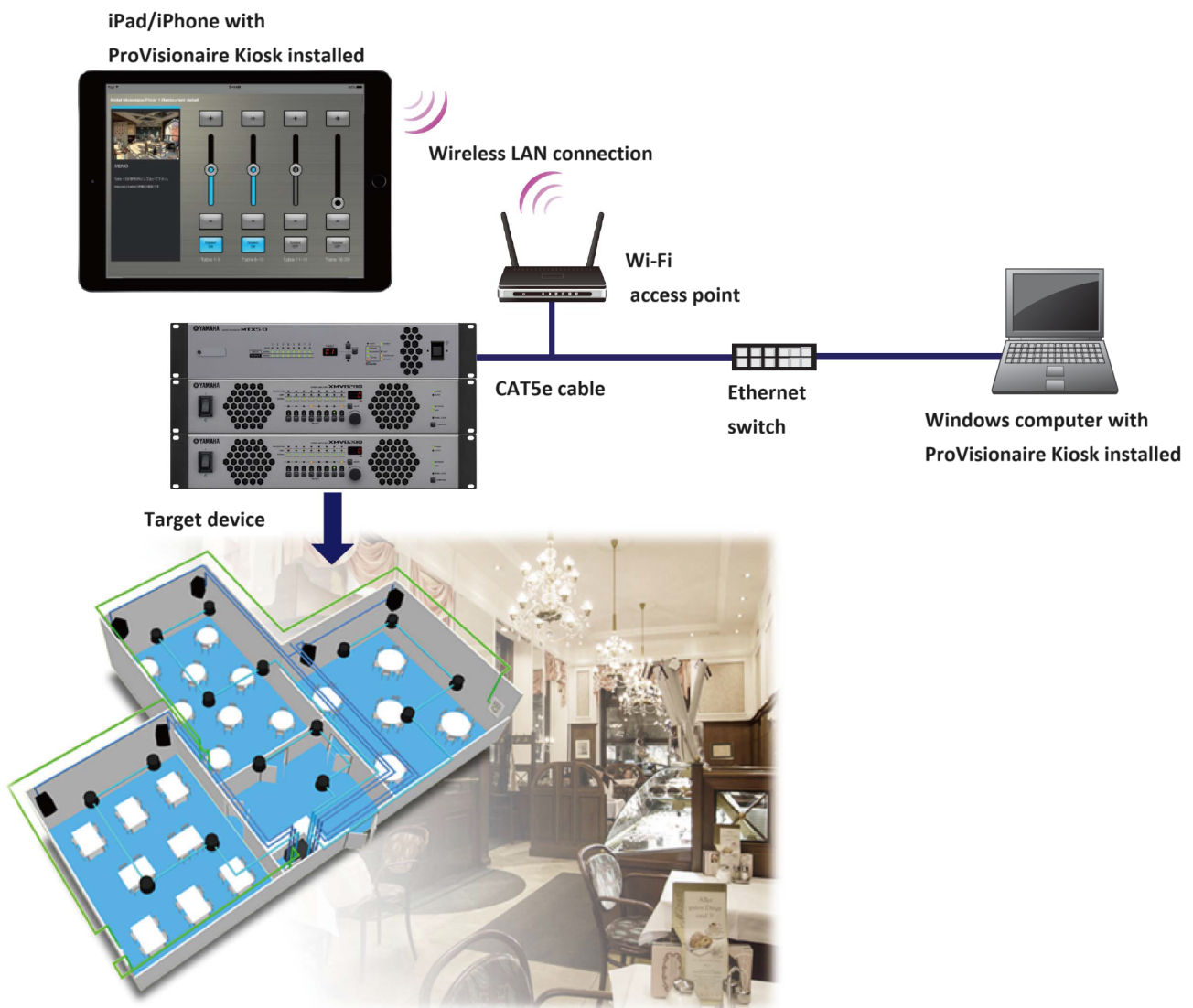

2. Operating requirements of the software

2.1. iOS/iPadOS

- Hardware: Apple iPhone/iPad running iOS/iPadOS 17.0 or later
For the latest information about devices and OS versions that are known to work, refer to the following website.
<https://www.yamahaproaudio.com/>
- Wi-Fi access point (802.11n/5 GHz is recommended)
- Cat5e cable (for connection between the target system and the Wi-Fi access point)

2.2. Windows

- OS : Windows 11/Windows 10 (64bit)
- Memory: 4 GB or more
- Hard disk: 1.1 GB or more
- Ethernet (1000BASE-T or better) or Wi-Fi capability
- To use System Monitor Widget, DirectX version 10.0 or later is required.

3. Installation procedure

3.1. iOS/iPadOS

Download “ProVisionaire Kiosk” from the App Store.

You will find a link on the ProVisionaire product page of the Yamaha Pro Audio website.

<https://www.yamahaproaudio.com/>



P.V. Kiosk

3.2. Windows

Download “ProVisionaire Kiosk”.

You will find a link on the ProVisionaire product page of the Yamaha Pro Audio website.

<https://www.yamahaproaudio.com/>

Follow the guide to install ProVisionaire Kiosk (Install_PVKiosk.exe).

NOTE

When ProVisionaire Control PLUS is installed, ProVisionaire Kiosk will also be installed at the same time.

4. Connection

4.1. iOS/iPadOS

4.1.1. Wi-Fi access point settings

Specify the Wi-Fi access point as described in the owner's manual of each device.

Although there is no need to make special settings, we recommend that you use security such as WPA in order to prevent unauthorized access to the network from outside.

Guidelines for settings are provided below.

1. **Specify the name of the Wi-Fi network.**
2. **Specify the security mode (e.g., WPA2) and password.**
3. **Select the wireless mode. (such as 802.11n or 802.11g)**
4. **If possible, enable "Auto Channel Selection."**

The wireless channel with the least interference will be selected.

For the fastest communication between the iPad/iPhone and the Wi-Fi access point, we recommend that you select an 802.11n network. If you use multiple external antennas, it will be easier to connect to the Wi-Fi access point.

In addition, we recommend that you make stealth mode and MAC address filter settings to increase security.

4.1.2. Connecting to the target system

Use CAT5e cables to connect the target system with the Wi-Fi access point.

Include an Ethernet switch in the system if necessary.

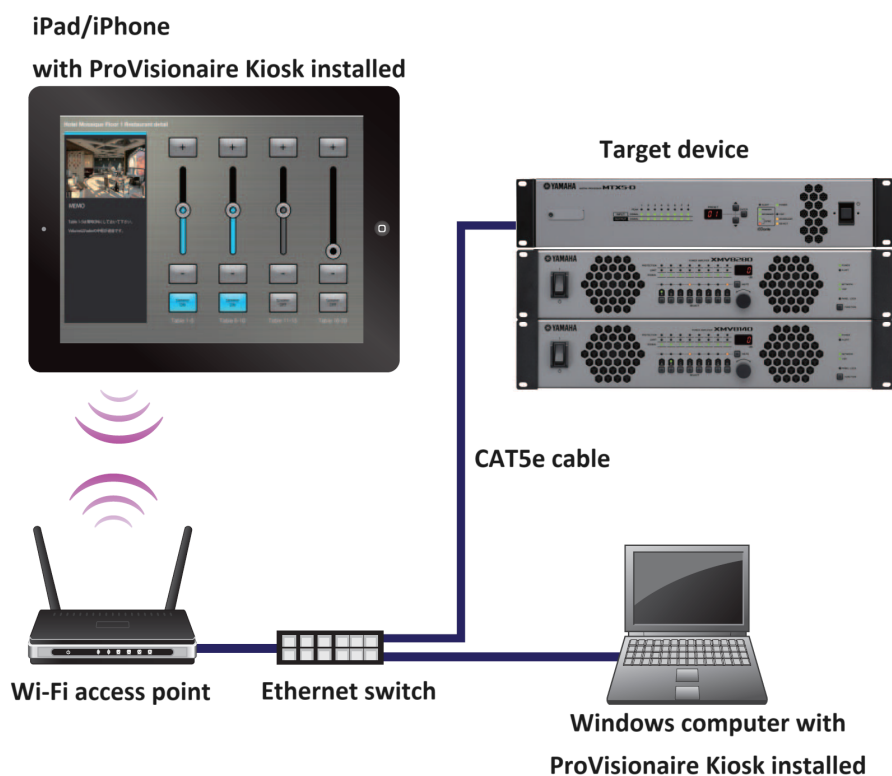

■ Example of network settings for target devices

1. Set the IP address of each device.

For setup instructions, refer to the instruction manual of each device.

In the following example, we assume that the IP address of the device is 192.168.0.1.

If there are multiple target devices, make sure that the IP addresses of the devices do not overlap.

2. Change the IP address of the Wi-Fi access point.

Set the Wi-Fi access point to the same network (subnet) as the device.

Make sure that the IP address does not overlap with the IP addresses of the target devices.

Connect your computer to the Wi-Fi access point and change the IP address from the web browser of your computer.

For details on how to change the IP address, refer to the instruction manual of the Wi-Fi access point.

The maximum number of ProVisionaire Kiosks that can be connected to a device varies depending on the device.

Refer to the instruction manual of each device.

● Example network settings for the iPad

1. In the home screen of the iPad, tap [Settings] → [Wi-Fi].

2. Turn the [Wi-Fi] switch On (🟢), and from the access point list that appears, select the access point of the target system.

3. Enter the password of the Wi-Fi access point.

4. Make network settings.

● If obtaining the IP address automatically

1. Tap ⓘ, and set [Configure IP] to [Automatic].

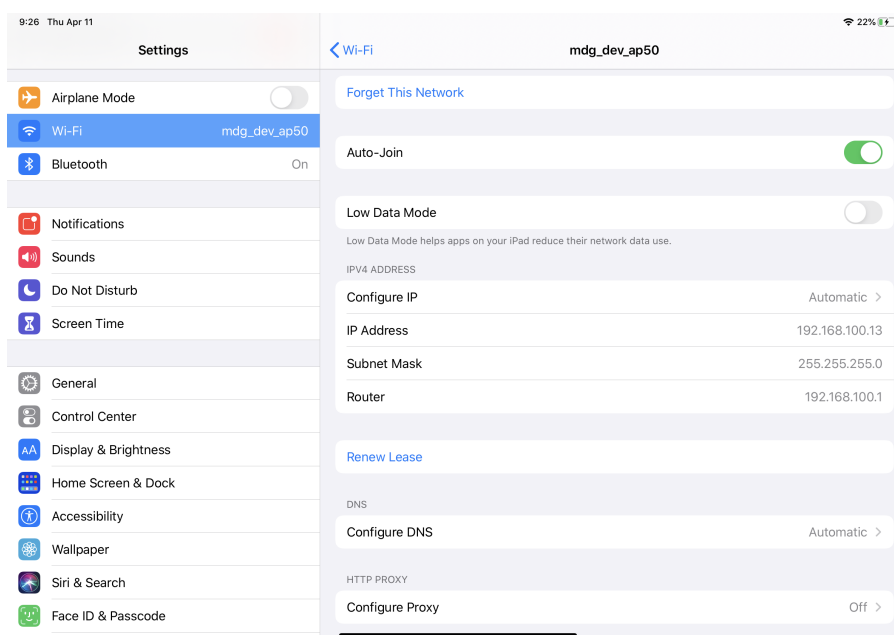

2. Verify that "IP Address," "Subnet Mask," "Router," and "DNS" are set.

3. Click the home button to complete the settings.

•If specifying the IP address manually (when it cannot be obtained automatically)

1. Tap , and set [Configure IP] to [Manual].

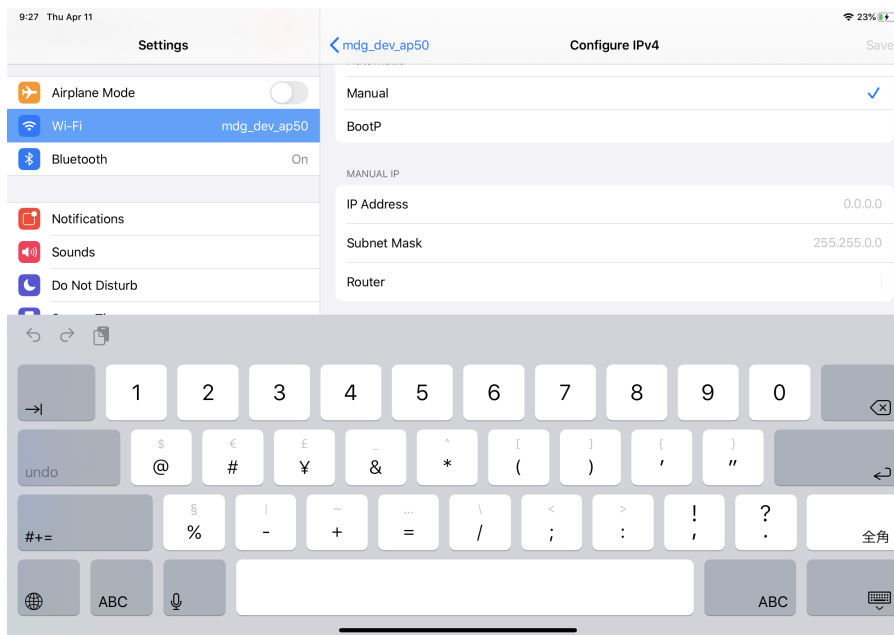

2. In "IP Address," enter the IP address of the target system, changing only the fourth octet (in the illustration above, "200").
3. In "Subnet Mask," enter "255.255.255.0."
4. In "Router," enter the IP address of the router or the IP address of the Wi-Fi access point.
5. In "DNS," enter the IP address of the DNS or the IP address of the Wi-Fi access point.
6. Click the home button to complete the settings.

● Tips for network settings

1. **The IP addresses of the devices you're connecting must be set to the same subnetwork.**

-	Example of a correct combination of settings	Example of an incorrect combination of settings
The Wi-Fi access point device's internal router and DNS *1	192.168.0.254	192.168. 11 .1
Target system	192.168.0.1	192.168.0.1
iPad	192.168.0.200	192.168. 11 .50
Computer	192.168.0.253	192.168. 11 .253

*1 If the Wi-Fi access point does not have router functionality, specify the IP address for accessing the Wi-Fi access point device.

2. **Connect the target devices to a LAN port of the Wi-Fi access point.**
If you connect it to the Ethernet port (WAN port), it will be impossible to communicate correctly between the smart device and the target devices.
3. **Start ProVisionaire Kiosk.**
ProVisionaire Touch detects the target devices and connects automatically.

When ProVisionaire Kiosk and the device are connected, the online indicator turns green.

4.2. Windows

4.2.1. Connecting to target devices

Use a Cat5e cable to connect target devices to the switch.

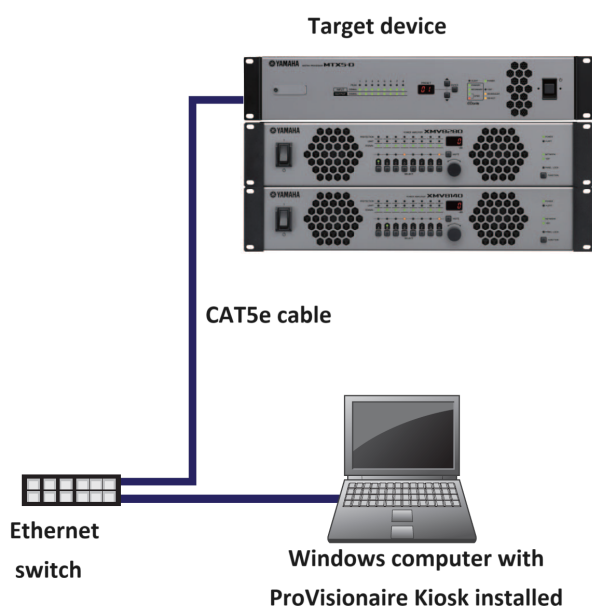

■ Example of network settings for target devices

1. **Set the IP address of each device.**
For setup instructions, refer to the instruction manual of each device.
If there are multiple target devices, make sure that the IP addresses of the devices do not overlap.
2. **Set the IP address of your computer to the same network (subnet) as the device.**
Make sure that the IP address does not overlap with the IP addresses of the target devices.
3. **Connect the computer and all the target devices to the switch.**

The maximum number of ProVisionaire Kiosks that can be connected to a device varies depending on the device.

Refer to the instruction manual of each device.

■ Network settings for ProVisionaire Kiosk

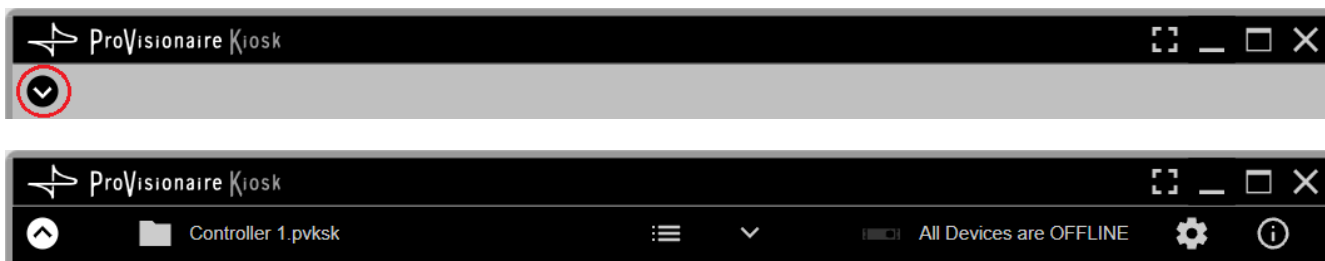

1. Click the [Setup] button  on the title bar and open the [Network tab](#).

2. **Select the network cards of the networks to which the devices are connected.**
Click the [OK] button to confirm the selection.

NOTE

You can select up to eight network cards. When multiple network cards are used, each network address must be independent.

When the connection to the devices is successful, the online indicator turns green.

5. Startup

5.1. iOS/iPadOS

1. **“Tap the “ProVisionaire Kiosk” icon.**

The Software License Agreement screen displays when you first start up the app.

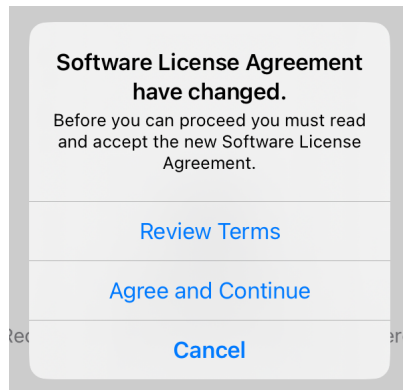

2. **To see the terms of use, tap “Review Terms.” Tap “Agree and Continue” if you agree with these terms, or “Cancel” if you do not agree.**

*You will not see this screen after the first time you open the app.

The browse screen of “ProVisionaire Kiosk opens.

3. **When the browse screen is displayed, send the controller file to Kiosk from the “Export Controller File” dialog box in ProVisionaire Control PLUS.**

For details, refer to the section for the “Export Controller File” dialog box in the “ProVisionaire Control PLUS User Guide.”

4. **Tap the file to load it.**

5.2. Windows

1. *Start ProVisionaire Kiosk from the start menu of your computer. *
The Initial screen will be displayed.

2. **Load the controller file from the [File] menu → [Open Controller File].**

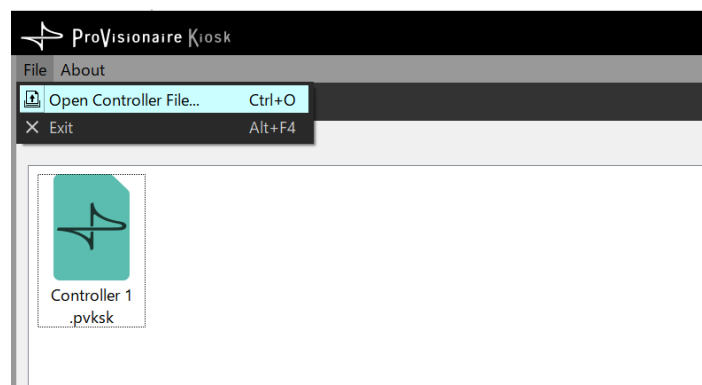

5.2.1. Enabling Kiosk auto-start

Configure the settings to make Kiosk automatically start up and open a specific controller file (extension: .pvksk) when Windows on the control device starts up.

1. **Place the controller file in the following folder.**

C:\Users\xxxx\AppData\Roaming\Microsoft\Windows\Start Menu\Programs\Startup

xxxx is the username you use to log in to your computer.

Folder names may be translated into different languages.

If the AppData folder does not appear in File Explorer, you can type the folder name directly into the address bar.

2. **Restart the computer.**

Once you log in, Kiosk will start up and open the controller file.

For the initial startup, the "Setup" dialog box will open. Select an interface to be connected to the same network as the device you want to control, and click the [OK] button.

6. Title bar



iOS/iPadOS



Windows



① View switch button

Click the  icon to display buttons for changing the settings. Click the  icon to close it.

② [Fullscreen] button

Puts the Kiosk display in full screen mode. To exit full screen mode, press the <Esc> key.

③ File Management button

Displays a list of the files.

④ File name

Displays the name of the open file.

⑤ [Page List] button

Displays the page list. You will be redirected to the selected page.

⑥ [Device Info] button

Displays information about the devices registered in the controller file.

⑦ Online indicator

Displays whether the devices registered in the controller file are online.

Green icon: All the devices registered in the controller file are online.

Yellow icon: Some of the devices registered in the controller file are online.

Red icon: The devices registered in the controller file have been found but are not online.

Grey icon: No devices are online.

⑧ [Setup] button

Opens the ["Setup" dialog box](#).

7. "Setup" dialog box

Click the [Setup] button  on the title bar to open this dialog box.

7.1. Network tab (Windows only)

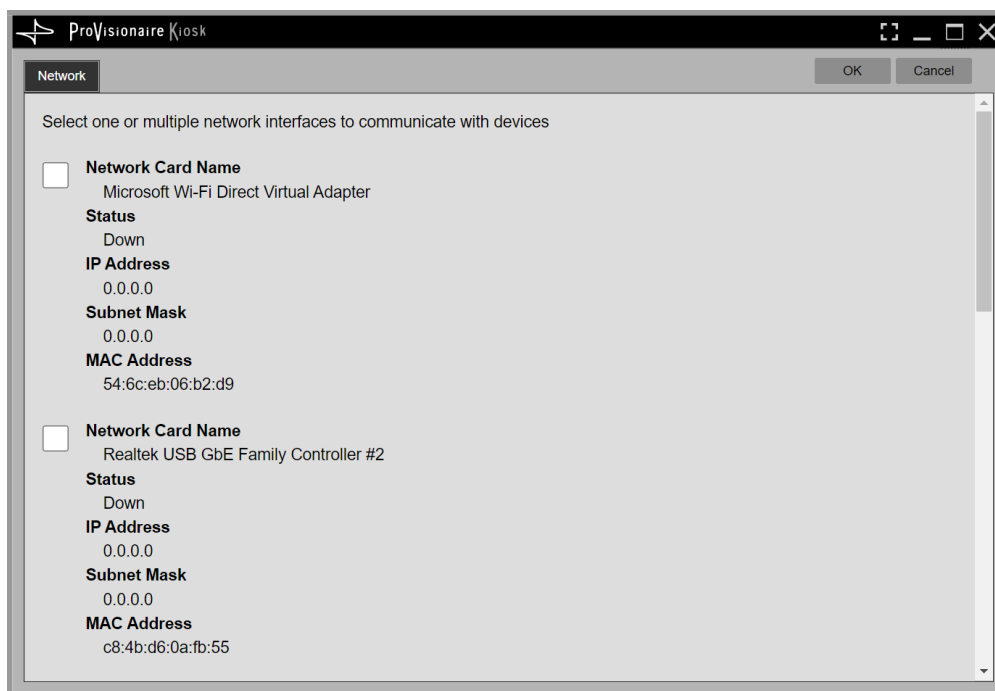

Select the network interface card to which the device is connected.
Press the [OK] button to confirm the change.

7.2. Security tab

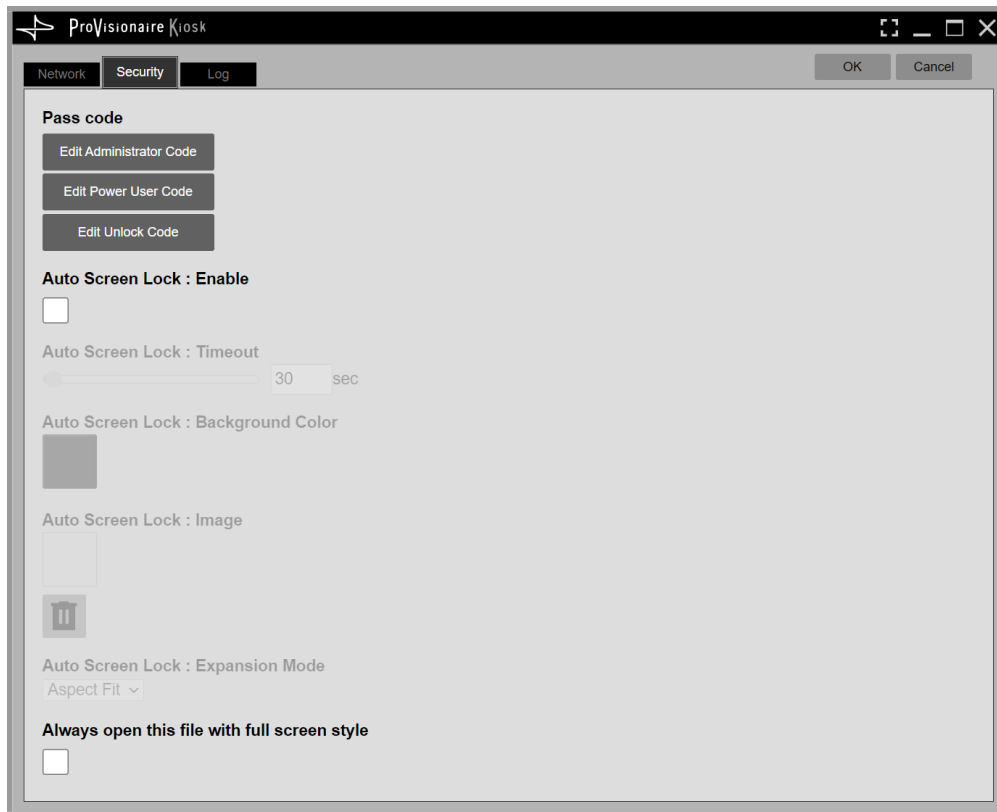

Pass Code

- **Edit Administrator Code**

Changes the Administrator Code.

If you open the controller file as a Power User, this item will not be displayed.

- **Edit Power User Code**

Changes the Power User Code.

- **Edit Unlock Code**

Changes the Unlock Code.

NOTE

ProVisionaire Kiosk uses the following roles.

- **Administrator**

The person who designs and edits the control panel. (mainly the installation contractor) This is the person who performs the setup on ProVisionaire Control PLUS. This person knows the Administrator Code (4 digits) to remove the function restrictions.

- **Power User**

Someone such as a manager of the facility. This person knows the Power User Code (4 digits) to move to access-restricted pages and to change configuration files.

- **Staff**

A person who operates the parameters. This person knows the Unlock Code (4 digits) to unlock the screen.

- **Guest**

A person who has no operating privileges.

Each role can perform the following actions.

	Administrator	Power User	Staff	Guest
Unlock the screen lock	-	-	✓	-
Operate parameters	✓	✓	✓	-
Edit controller files	✓	✓	-	-
Edit design pages	✓	-	-	-

Auto Screen Lock

- **Auto Screen Lock : Enable**

If this box is selected, the screen will be locked when the time specified in Time Out has elapsed since the last operation.

- **Auto Screen Lock : Back Color**

Specifies the color of the locked screen.

- **Auto Screen Lock : Image**

Specifies the image to be displayed on the locked screen.
Click the trash icon to delete the selected image file.

- **Auto Screen Lock : Expansion Mode**

[Image Expansion Mode] is located under [Image] in the "Properties" area, and [Expansion Mode] is located on the [Security] tab of the "Setup" dialog box. This item allows you to select how the image is positioned in the display area.

- **None**

The image is placed in the center of the area without any changes in size.

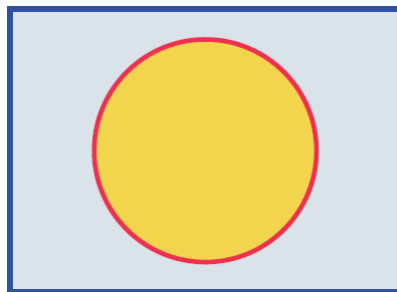

- **Full**

The displayed image is scaled to fit the entire display area in both height and width, while its aspect ratio is ignored.

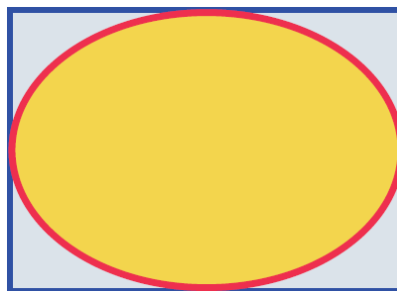

- **Aspect Fill**

The displayed image is scaled to fill as much of the display area as possible, while its aspect ratio is maintained.

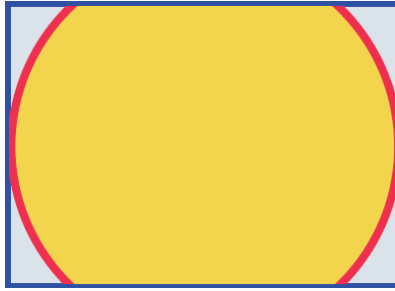

- **Aspect Fit**

The displayed image is scaled to the maximum size that fits the entire image in the display area, while its aspect ratio is maintained.

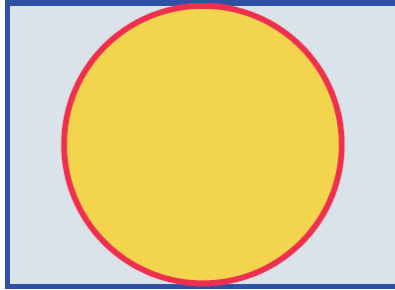

- **Scaling**

You can set the image reduction ratio in relation to the widget. When 100% is selected, the displayed image will fill the entire area.

Always open this file with full screen (Windows only)

Select this box to display the file in full screen when it is opened.

7.3. Log tab

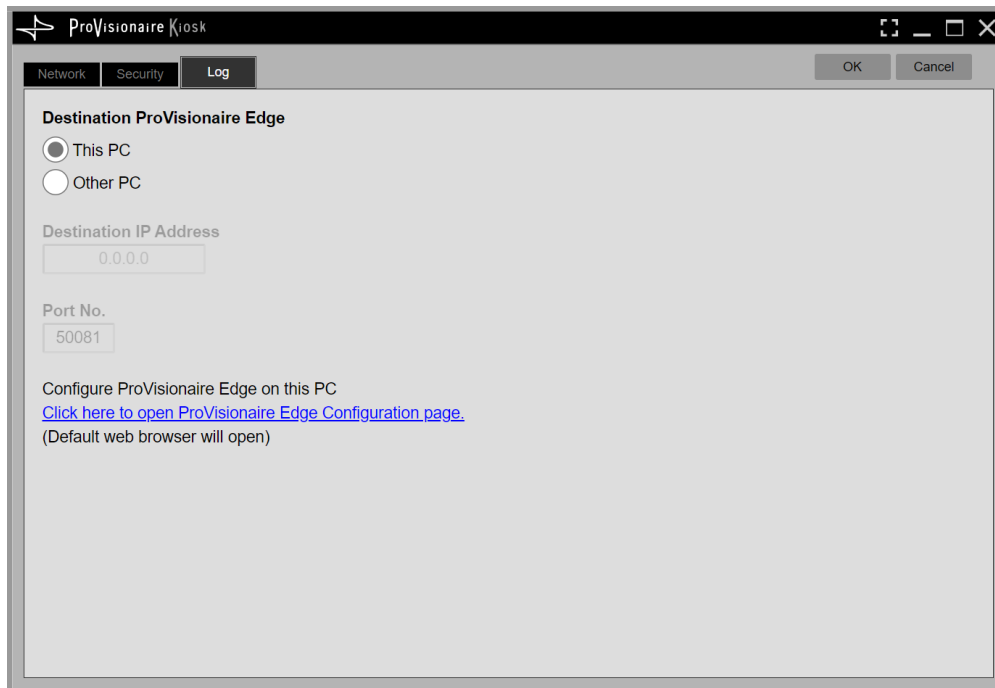

- **Destination ProVisionaire Edge**

Specifies the source of ProVisionaire Edge information to be displayed in the System Monitor widget. "This PC" is available only for Windows.

- **Click here to open ProVisionaire Edge Configuration page.**

Clicking here opens the Setting screen of ProVisionaire Edge installed on the computer running KIOSK.

8. Settings file management (the File Management button)

8.1. iOS/iPadOS

On the title bar, touch the File Management button  or tap the ProVisionaire Kiosk icon to select the settings files created by ProVisionaire Control PLUS from the list display.

Tap a file icon to open the file.

When loading, an authentication screen appears, requiring either a Power User code or an Administrator code.

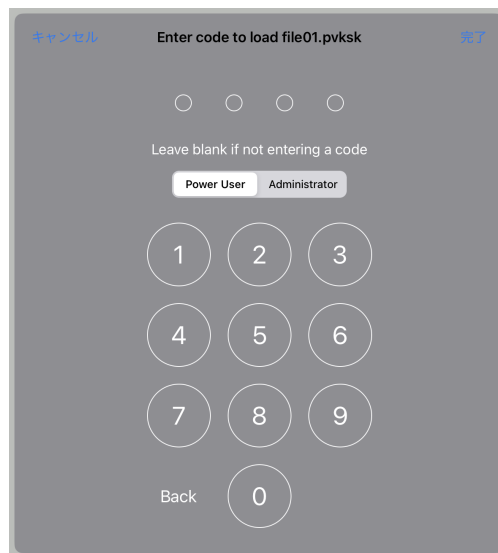

If you long-tap a file icon, the file's context menu appears. You can use the context menu to copy, duplicate, move, delete, or share the settings file.

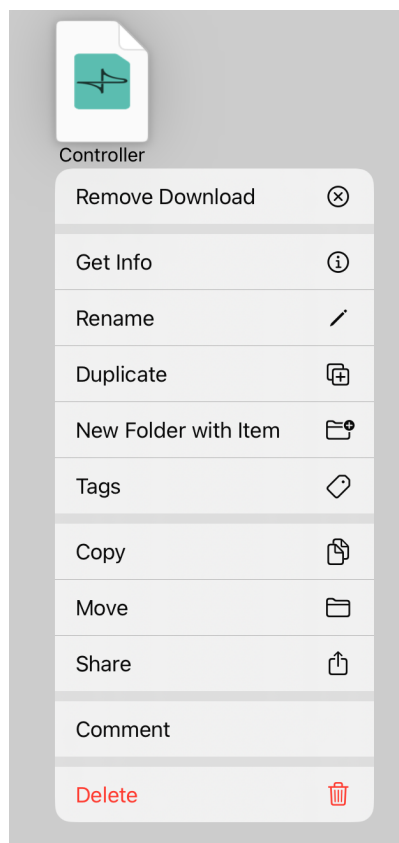

- **Info**
Opens the properties of the selected settings file.
- **Rename**
Renames the selected settings file.
- **Duplicate**
Duplicates a settings file. When you tap [Duplicate], a duplicate file is created with a “1” appended to the end of its name.
*If an identically named file already exists, the number is automatically incremented as “2” or “3” etc.
- **New Folder with 1 Item**
Creates a new folder and stores the selected file.
- **Tags**
Shows the selected tag at the left of the selected settings file name.
- **Copy**
Copies the selected settings file to the copy buffer.
To paste, long-tap a location in the browser where there is no file, and execute [Paste].
*If an identically named file already exists, the number is automatically incremented as “2” or “3” etc.
- **Move**
Moves the selected settings file. When you tap [Move], the Move dialog box appears; select the move-destination and then tap [Move] in the upper right, and the settings file moves to the selected move destination.
- **Share**
Shares the selected settings file to another computer or tablet.
 - **AirDrop :**
When you tap the [AirDrop] icon, the iOS AirDrop function shows a list of recipients. Select the desired recipient and transmit the file.
On the receiving device, specify this app as the app that will open.
The received file is saved in the Documents folder.
*iOS devices that do not support AirDrop are not shown in the list of recipients.
 - **Mail :**
When you tap the [Mail] icon, the mail app starts, and a new email with the selected file attached is created. Send the email to the desired recipient.
If the email recipient has installed this app, they can tap the received file and specify this app as the app that opens. The received file is saved in the Documents folder.
 - **File Transfer :**
When you tap the [File Transfer] icon, a list of recipients connected to the same network appears. Select the desired recipient and transmit the file.
- **Comment**
Displays a comment for the selected settings file.
- To enter or edit the comment, load the file, press the information button, and use the [About File] menu item [Comment].
- **Delete**
Deletes the selected settings file.

AirDrop

Devices that support AirDrop can share data directly between iPad units without going through an access point (P2P).

8.2. Windows

On the title bar, touch the File Management button  or tap the ProVisionaire Kiosk icon to select the settings files created by ProVisionaire Control PLUS from the list display.

Double-click a file icon to open the file.

Alternatively, select the file and click the Load button to open the file.

When loading, an authentication screen appears, requiring either a Power User code or an Administrator code.

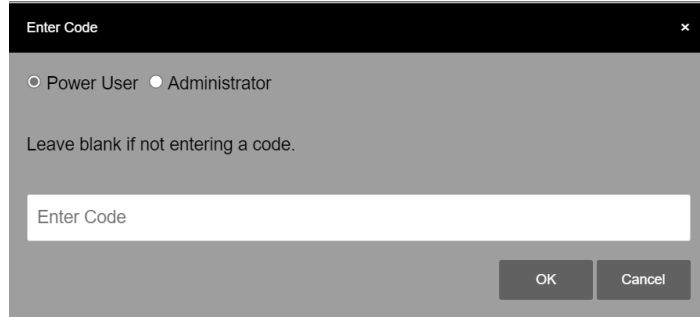

When you select a file and click [Favorite], an icon  will be displayed. Use this method when registering a file as a favorite. You can cancel the registration by clicking [Favorite] again.

You can delete a file by selecting it and clicking [Remove from History].

Files with the  icon cannot be deleted.

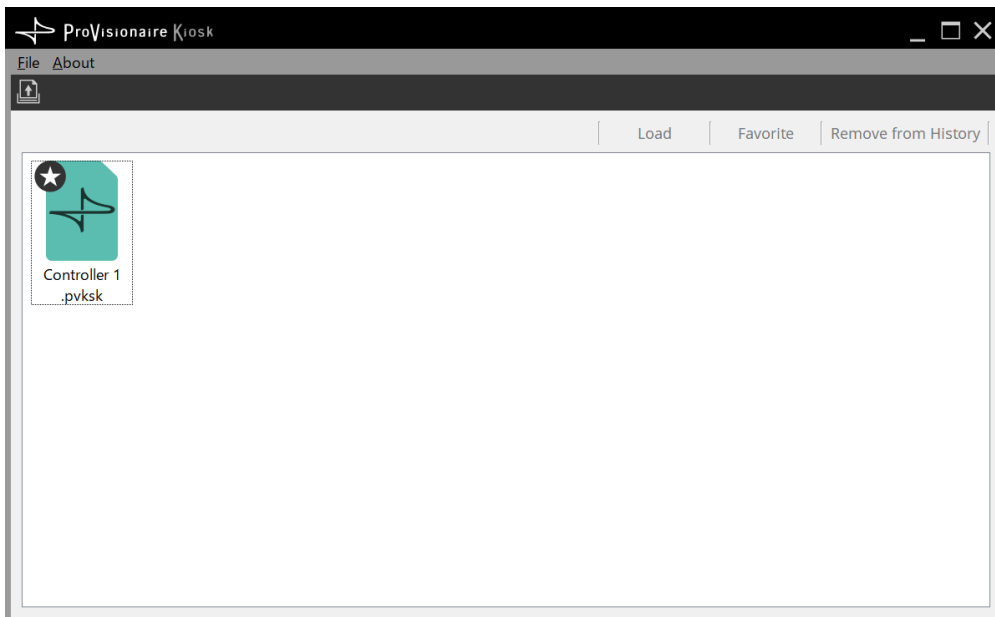

9. Troubleshooting

Problem	Cause	Action
Can't communicate with the target system.	Wi-Fi settings are incorrect.	Make settings that are appropriate for the access point that's connected to the target system.
The message "Can't connect to the Internet" appears on the iPad/iPhone screen, and ProVisionaire Kiosk can't connect to the target system.	You may be attempting to access the Internet when a Wi-Fi network is selected	You will need to make the appropriate setting on the Wi-Fi device (access point/router) so that this message does not appear. One method of changing the setting of the Wi-Fi device is to disable the "redirect function"; contact the manufacturer of the device for details.
Can't operate more than four widgets simultaneously.	Multitask gestures are turned on.	When using iPad, we recommend that you turn multitasking gestures off. 1. On the iPad, tap [Settings]. 2. Choose [General]>[Multitasking Gestures]>[Off].
Can't operate more than three widgets simultaneously.	In the accessibility functions, the zoom function is turned on.	When using iPad, we recommend that you turn the zoom function off. 1. On the iPad, tap [Settings]. 2. Choose [General]>[Accessibility]>[Zoom Function]>[Off].
A dialog says that there is insufficient memory.	The memory within the app has been overwhelmed by a PDF, photo, or other image.	To reduce the amount of memory occupied, delete an image that you're using. If you ignore this message and add a photo etc., the app may crash.
Can't connect eight iPad units to one XMV/EXi8/EXo8.	Of the eight sessions simultaneously connected to the XMV/EXi8/ EXo8, one session is used for communication between the MTX/MRX and the XMV/EXi8/EXo8. For this reason, a maximum of seven external control devices can be connected.	Use a maximum of seven iPad units to control the XMV/EXi8/EXo8.
Can't control an NXAMPmk2.	The UNIT ID of the NXAMPmk2 is set to 0.	Set the NXAMPmk2 that you want to control to a UNIT ID other than 0.
Nothing is shown for track list.	The assigned device is not connected to the network.	Connect the assigned device to the network.
Don't know how to specify the device's IP address.	—	Refer to the owner's manual of the device or the application that controls it via the network.

