

YAMAHA KX-690

Natural Sound Stereo Cassette Deck

Platine à cassette stéréo de la série "Natural Sound"

OWNER'S MANUAL MODE D'EMPLOI

IMPORTANT

Please record the serial number of your unit in the space below.

Model: KX-690

Serial No:

The serial number is located on the rear of the unit.
Retain this Owner's Manual in a safe place for future reference.

Thank you for purchasing the YAMAHA stereo cassette deck.

SAFETY INSTRUCTIONS

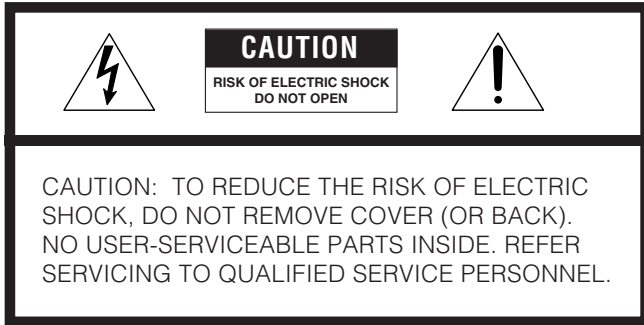

• Explanation of Graphical Symbols

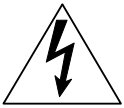

The lightning flash with arrowhead symbol, within an equilateral triangle, is intended to alert you to the presence of uninsulated "dangerous voltage" within the product's enclosure that may be of sufficient magnitude to constitute a risk of electric shock to persons.



The exclamation point within an equilateral triangle is intended to alert you to the presence of important operating and maintenance (servicing) instructions in the literature accompanying the appliance.

WARNING

TO REDUCE THE RISK OF FIRE OR ELECTRIC SHOCK, DO NOT EXPOSE THIS UNIT TO RAIN OR MOISTURE.

- 1** Read Instructions — All the safety and operating instructions should be read before the appliance is operated.
- 2** Retain Instructions — The safety and operating instructions should be retained for future reference.
- 3** Heed Warnings — All warnings on the appliance and in the operating instructions should be adhered to.
- 4** Follow Instructions — All operating and other instructions should be followed.
- 5** Water and Moisture — The appliance should not be used near water — for example, near a bathtub, washbowl, kitchen sink, laundry tub, in a wet basement, or near swimming pool, etc.
- 6** Carts and Stands — The appliance should be used only with a cart or stand that is recommended by the manufacturer.

6A An appliance and cart combination should be moved with care. Quick stops, excessive force, and uneven surfaces may cause the appliance and cart combination to overturn.



7 Wall or Ceiling Mounting — The appliance should be mounted to a wall or ceiling only as recommended by the manufacturer.

8 Ventilation — The appliance should be situated so that its location or position does not interfere with its proper ventilation. For example, the appliance should not be situated on a bed, sofa, rug or similar surfaces that may block the ventilation openings: or placed in a built-in installation, such as a bookcase or cabinet that may impede the flow of air through the ventilation openings.

9 Heat — The appliance should be situated away from heat sources such as radiators, stoves, or other appliances that produce heat.

10 Power Sources — The appliance should be connected to a power supply only of the type described in the operating instructions or as marked on the appliance.

11 Power-Cord Protection — Power-supply cords should be routed so that they are not likely to be walked on or pinched by items placed upon or against them, paying attention to receptacles, and the point where they exit from the appliance.

12 Cleaning — The appliance should be cleaned only as recommended by the manufacturer.

13 No Use Periods — The power cord of the appliance should be unplugged from the outlet when left unused for a long period of time.

14 Object and Liquid Entry — Care should be taken so that objects do not fall into and liquids not spilled into the inside of the appliance.

15 Damage Requiring Service — The appliance should be serviced by qualified service personnel when:

- The power-supply cord or the plug has been damaged; or
- Objects have fallen, or liquid has been spilled into the appliance; or
- The appliance has been exposed to rain; or
- The appliance does not appear to operate normally or exhibits a marked change in performance; or
- The appliance has been dropped, or the cabinet damaged.

16 Servicing — The user should not attempt to service the appliance beyond those means described in the operating instructions. All other servicing should be referred to qualified service personnel.

17 Grounding or Polarization — The precautions should be taken so that the grounding or polarization of an appliance is not defeated.

CAUTION

The apparatus is not disconnected from the AC power source as long as it is connected to the wall outlet, even if the apparatus itself is turned off.

FCC INFORMATION (for US customers only)**1. IMPORTANT NOTICE: DO NOT MODIFY THIS UNIT!**

This product, when installed as indicated in the instructions contained in this manual, meets FCC requirements. Modifications not expressly approved by Yamaha may void your authority, granted by the FCC, to use the product.

2. IMPORTANT: When connecting this product to accessories and/or another product use only high quality shielded cables. Cable/s supplied with this product **MUST** be used. Follow all installation instructions. Failure to follow instructions could void your FCC authorization to use this product in the USA.

3. NOTE: This product has been tested and found to comply with the requirements listed in FCC Regulations, Part 15 for Class "B" digital devices. Compliance with these requirements provides a reasonable level of assurance that your use of this product in a residential environment will not result in harmful interference with other electronic devices.

This equipment generates/uses radio frequencies and, if not installed and used according to the instructions found in the users manual, may cause interference harmful to the operation of other electronic devices. Compliance with FCC regulations does not guarantee that interference will not occur in all installations. If this product is found to be the source of interference, which can be determined by turning the unit "OFF" and "ON", please try to eliminate the problem by using one of the following measures:

Relocate either this product or the device that is being affected by the interference.

Utilize power outlets that are on different branch (circuit breaker or fuse) circuits or install AC line filter/s.

In the case of radio or TV interference, relocate/reorient the antenna. If the antenna lead-in is 300 ohm ribbon lead, change the lead-in to coaxial type cable.

If these corrective measures do not produce satisfactory results, please contact the local retailer authorized to distribute this type of product. If you cannot locate the appropriate retailer, please contact Yamaha Electronics Corp., U.S.A. 6600 Orangethorpe Ave, Buena Park, CA90620.

The above statements apply **ONLY** to those products distributed by Yamaha Corporation of America or its subsidiaries.

We Want You Listening For A Lifetime

YAMAHA and the Electronic Industries Association's Consumer Electronics Group want you to get the most out of your equipment by playing it at a safe level. One that lets the sound come through loud and clear without annoying blaring or distortion – and, most importantly, without affecting your sensitive hearing. Since hearing damage from loud sounds is often undetectable until it is too late, YAMAHA and the Electronic Industries Association's Consumer Electronics Group recommend you avoid prolonged exposure to excessive volume levels.

**CAUTION: READ THIS BEFORE OPERATING YOUR UNIT.**

1. This unit is a sophisticated stereo cassette deck. To ensure proper operation for the best possible performance, please read this manual carefully.
2. Choose the installation location of your unit carefully. Avoid placing it in direct sunlight or close to source of heat. Also avoid locations subject to vibration and excessive dust, heat, cold or moisture. Keep it away from sources of hum such as transformers or motors.
3. Do not open the cabinet as this may result in damage to the deck or electrical shock. If a foreign object should get into the deck, contact your local dealer.
4. Do not apply excessive force when operating switches and knobs.
5. When moving the deck, be sure to first pull out the power plug and remove all cords connecting the deck to other equipment.
6. Do not attempt to clean this unit with chemical solvents as this may damage the finish. Use a clean, dry cloth.
7. Never allow metallic items (e.g. screwdrivers, tools, etc.) to come near the record/playback head assembly. Doing so may not only scratch or damage the head's mirror-smooth finish, it may also change the magnetic characteristics of the heads, causing a deterioration in reproduction quality.
8. Although the record/playback head used in this unit is a high quality head with outstanding reproduction characteristics, it can become dirty through the use of old tapes or from dust accumulation over time. This can have a serious effect on reproduction quality. Clean the heads regularly with one of the commonly available head cleaners or with cleaning solutions as explained later in this manual.
9. Be sure to read the "Troubleshooting" section of this manual for advice on common operating errors before concluding that your unit is faulty.
10. Unplug the power cord from the wall outlet if the unit is not to be used for an extended period of time. To disconnect the cord, pull it out by grasping the plug. Never pull the cord itself.
11. Keep this manual in a safe place for future reference.
12. **Voltage Selector (General model only)**
The voltage selector on the rear panel of this unit must be set for your local mains voltage BEFORE plugging in the AC mains supply.

Please check the copyright laws in your country to record from records, compact discs, radio, etc. Recording of copyright material may infringe copyright laws.

CAUTION (FOR CANADA MODEL)

TO PREVENT ELECTRIC SHOCK, MATCH WIDE BLADE OF PLUG TO WIDE SLOT, FULLY INSERT.

FOR CANADIAN CUSTOMERS

THIS CLASS B DIGITAL APPARATUS MEETS ALL REQUIREMENTS OF THE CANADIAN INTERFERENCE-CAUSING EQUIPMENT REGULATIONS.

TABLE OF CONTENTS

FEATURES	4	TIMER RECORDING/PLAYBACK	16
CONNECTIONS	5	Timer recording	16
FRONT PANEL PARTS AND FUNCTIONS	6	Timer playback	16
PLAYBACK	8	CASSETTE TAPES	17
SELECTION SEARCH	10	OPENING AND CLOSING THE SUB PANEL	18
INTRO SCAN	10	OPTIONAL REMOTE CONTROL TRANSMITTER	18
MEMORY STOP operation	11	MAINTENANCE	18
REPEAT PLAYBACK	11	TROUBLESHOOTING	19
RECORDING	12	SPECIFICATIONS	20
REC MUTE operation	15		
0-STOP operation	15		
REC RETURN operation	15		

FEATURES

High Sound Quality Design

- Closed Loop Dual Capstan 3-Motor Transport Mechanism
- 3-head Tape Monitor System
- Double Dolby HX Pro Dynamic Bias Servo*
- Double Dolby B/C and S Noise Reduction
- Secure Holding Damper Cassette Stabilizer allows you to reduce unwanted vibration and modulation noise.
- Fine Adjustment of Recording Characteristics with Auto Tape Tuning and Bias Adjust Control
- 160 kHz High Recording Bias prevents cross modulation beat distortion that can occur between the recording bias and the recording signal's high frequency content.
- Play Trim Control for improved playback compatibility with other decks

Easy Operation

- Selection Search and Bi-Directional Intro Scan
- 0-M/FULL Repeat Playback
- Memory Stop
- Recording Mute function
- Rec return
- Liner Time Tape Counter with Remaining Time Display
- Remote Control compatibility (option)

* Dolby noise reduction and HX Pro headroom extension manufactured under license from Dolby Laboratories Licensing Corporation. HX Pro originated by Bang & Olufsen.

"DOLBY", the double-D symbol  and "HX PRO" are trademarks of Dolby Laboratories Licensing Corporation.

CONNECTIONS

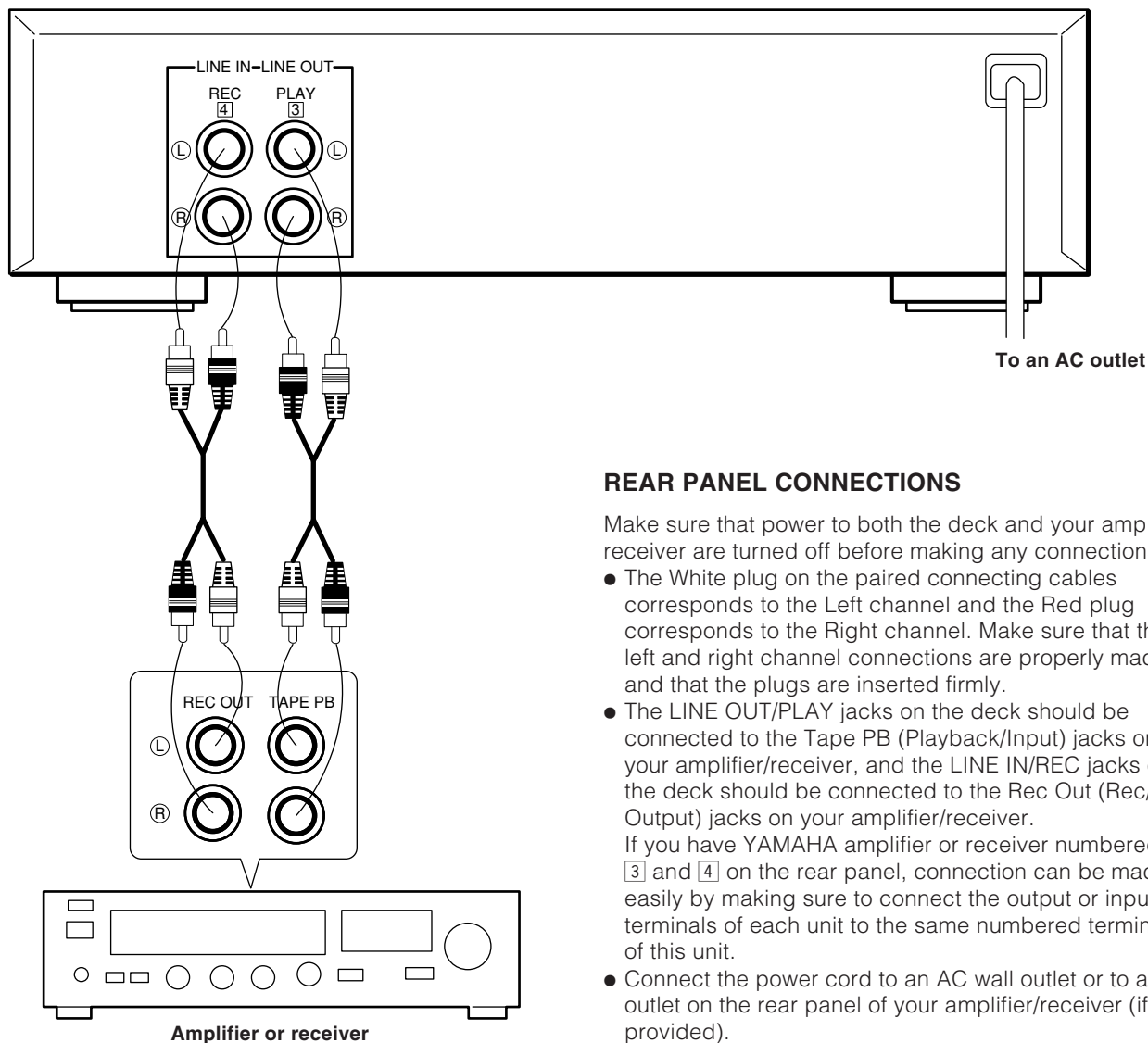

REAR PANEL CONNECTIONS

Make sure that power to both the deck and your amplifier/receiver are turned off before making any connections.

- The White plug on the paired connecting cables corresponds to the Left channel and the Red plug corresponds to the Right channel. Make sure that the left and right channel connections are properly made, and that the plugs are inserted firmly.
- The LINE OUT/PLAY jacks on the deck should be connected to the Tape PB (Playback/Input) jacks on your amplifier/receiver, and the LINE IN/REC jacks on the deck should be connected to the Rec Out (Rec/Output) jacks on your amplifier/receiver.

If you have YAMAHA amplifier or receiver numbered as 3 and 4 on the rear panel, connection can be made easily by making sure to connect the output or input terminals of each unit to the same numbered terminals of this unit.

- Connect the power cord to an AC wall outlet or to an AC outlet on the rear panel of your amplifier/receiver (if provided).

FRONT PANEL PARTS AND FUNCTIONS

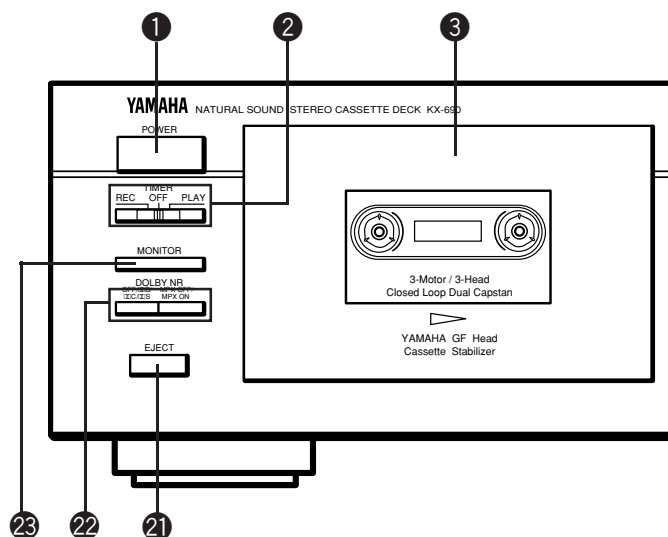

1 POWER switch

Press this switch to turn the power on and off.

2 TIMER switch

PLAY: By using a commercially available audio timer, this function permits timer activated playback.

REC: By using a commercially available audio timer, this function allows you to carry out unattended recording.

3 Cassette compartment

Insert a cassette with the exposed tape side facing down and the side to be played facing you. To close the compartment, push in the compartment door until it locks shut.

4 Remote sensor

This sensor receives signals from the remote control transmitter.

5 Display

6 COUNTER buttons

RESET: Press this button to reset the counter reading to "0:00". It can also be used to specify a new "0:00" point for 0-M repeat operation.

REMAIN: When this button is pressed during playback/recording and if the tape length is already memorized via the TAPE button, the unit will compute the remaining available play/record time and display the results in the display.

TAPE: This button is used to memorize the tape length. It is necessary to memorize the tape length for accurate calculation of remaining tape time, etc.

* The last displayed tape length will remain until the next time a new tape length entered.

7 MEMORY button

Press this button when the counter is at the desired counter reading. The reading will be memorized and the tape will be played back repeatedly between "0:00" and the memorized counter reading.

8 REPEAT button

OFF: For normal playback or recording, set to this position.

FULL REPEAT: One side of the cassette can be repeatedly played back 8 times from beginning to end.

0-M REPEAT: The section between "0:00" on the linear counter and the counter number memorized with the MEMORY button is repeatedly played 8 times.

9 AUTO TAPE TUNING button

Pressing this button during the REC/PAUSE mode will activate the Auto Tape Tuning function. It makes possible to internally determine the optimum recording characteristics (bias and recording sensitivity) according to the loaded cassette tape.

10 INTRO SCAN < and > buttons

Press one of these buttons to play back the first 15 seconds approximately of each selection in the desired direction. Once the desired selection is found, press the PLAY button to defeat the Intro Scan mode and engage the Play mode.

11 STOP button

Pressing this button at any time will stop all tape transport functions.

12 PLAY button

Press this button to begin playback or to engage the Record mode from the Rec/Pause mode. Pressing this button during recording will designate a new beginning point for the REC Return function.

13 << and >> buttons

<<: Press to rapidly rewind the tape.

By pressing this button during recording, the tape will rewind to the beginning of the recording and stop (Rec Return function). If the COUNTER RESET or the PLAY button was pressed during recording, the tape will rewind and stop at the point on the tape where the button was pressed.

>>: Press this button to rapidly advance the tape.

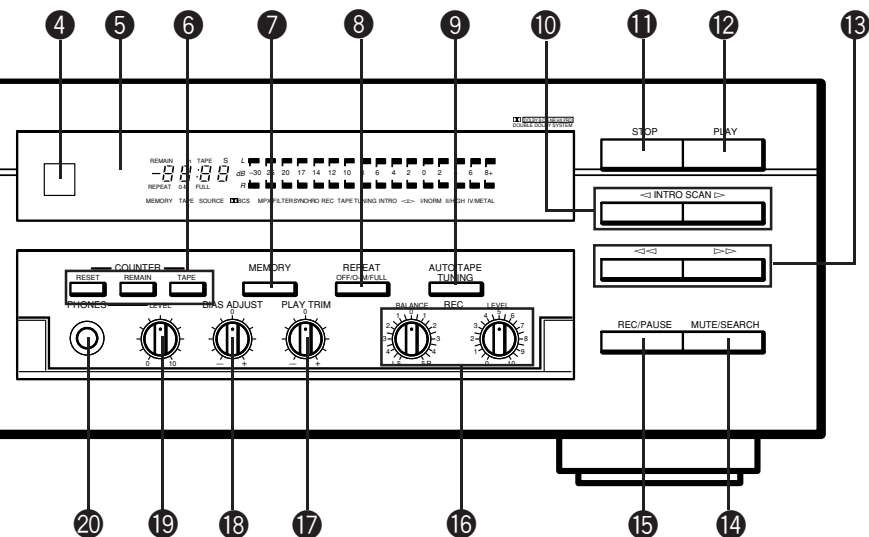

14 MUTE/SEARCH button

During Recording (MUTE):

When the MUTE/SEARCH button is pressed during recording, a 4-second blank interval is automatically recorded onto the tape (Auto Rec Mute mode).

During Playback (SEARCH):

By pressing the MUTE/SEARCH and >>> buttons simultaneously, the tape will advance to the beginning of the next selection and begin play.

By pressing the MUTE/SEARCH and <<< buttons simultaneously, the tape will rewind to the beginning of the current selection and begin play.

15 REC/PAUSE button

Pressing this button engages the Rec/Pause mode. In this mode, the PEAK level meters will function, allowing you to monitor and set the recording signal level of the deck.

16 REC BALANCE and REC LEVEL controls

Adjust the recording levels for the left and right channels with the REC BALANCE control.

Adjust the recording level so that the highest peak may not exceed the optimum levels with the REC LEVEL control.

17 PLAY TRIM control

With this control, the compatibility between this unit and tapes recorded on another deck is increased. During playback turn this control to the right to boost high frequencies or turn it to the left to attenuate them.

18 BIAS ADJUST control

This control is for fine adjustment of the recording bias. Turning the control counterclockwise decreases the bias and will result in recordings with boosted high frequencies. Too little bias can result in too much or distorted high frequencies. If less distortion is more important than high frequencies, turn the control clockwise to increase the bias signal.

19 LEVEL control

Use this control to adjust the output level at the PHONES jack. Turn the control to the clockwise to increase, or counterclockwise to decrease, the output level.

20 PHONES jack

Connect headphones to this jack for monitoring recording or playback.

21 EJECT button

Press this button to open the cassette compartment. The button will not function if the deck is in Play, Record or Record/Pause mode.

22 DOLBY NR buttons

OFF/□□B/□□C/□□S:

When playing tapes encoded with Dolby NR or making recordings to be encoded with Dolby NR, set this switch to the desired type of Dolby noise reduction.

MPX OFF/MPX ON:

Press this switch to the ON position when recording broadcasts from FM stations while using a Dolby NR system.

Set this switch to OFF when recording sources other than FM broadcasts, and during playback of any tape, even a recording of an FM broadcast.

23 MONITOR button

Set this switch to the source monitor mode to monitor the sound to be recorded. Set this switch to the tape monitor mode to monitor the recorded sound.

PLAYBACK

Preparation for playback

- Be sure to set the TIMER switch to the OFF position, then turn on the POWER switch.
- Set your amplifier or receiver to cassette deck function mode.

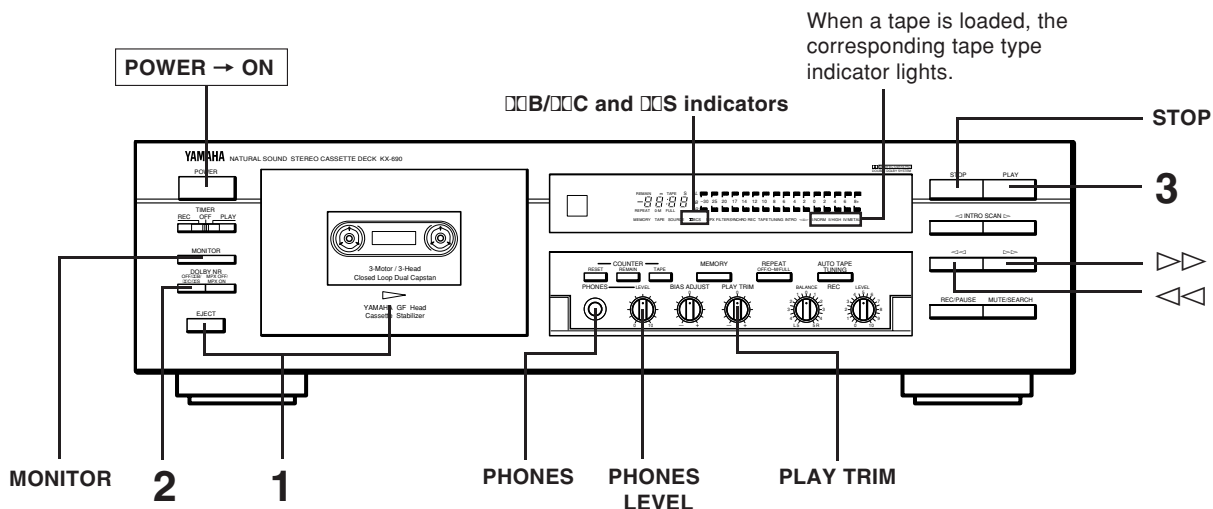

<p>1</p> <p>EJECT</p> <p>Insert the cassette with the exposed tape side facing down and the side to be played facing you. To close the compartment, push in the compartment door until it locks shut.</p>	<p>2</p> <p>DOLBY NR OFF/DB/ MPX OFF/ C/S MPX ON</p>	<p>3</p> <p>PLAY</p>
--	---	-----------------------------

To stop playback:
Press the STOP button.

To fast forward the tape:
Press the >> button.

To fast rewind the tape:
Press the << button.

To adjust the volume level:
Use the volume control of the amplifier or receiver.

To use headphones for private listening:
Insert the headphones plug into the PHONES jack.

To adjust the headphones level:
Use the PHONES LEVEL control.

DOLBY NR button setting (in step 2)

DOLBY NR (OFF/DB/DB/C/S) button
Be sure to set the DOLBY NR (OFF/DB/DB/C/S) button according to the system used for recording. Each time this button is pressed, Dolby NR switches as follows:

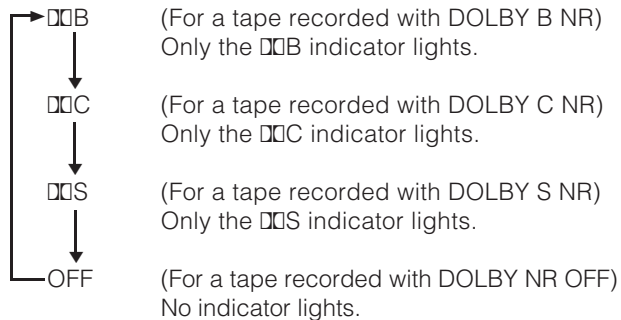

Note:
During playback, if the monitor mode is switched to the source monitor mode, no sound is heard. (The SOURCE indicator lights.)
Press the MONITOR button so that the TAPE indicator lights.

DOLBY S NR

DOLBY S NR is developed incorporating the concept of professional-use DOLBY SR system into the present DOLBY B/C NR.

It offers the noise reduction effect increased by about 40%, compared to the former DOLBY C NR, and also the noise level of the low frequency range is reduced to 1/3. Highly natural sound can be reproduced with the help of the modulation controller, which regulates 5 NR units — 2 for low level sounds and 3 for high level, one of which is for low frequency signals.

DOLBY S NR has also high interchangeability. The tapes recorded with DOLBY S NR can well be reproduced by the decks which are equipped only with DOLBY B NR, headphone stereos or car stereos for example.

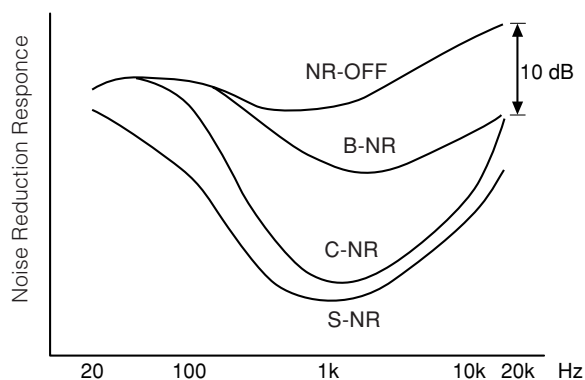

Linear time tape counter and the tape length setting

Use the linear time tape counter as an aid in locating a point on a tape (-99 min. 59 sec. to 99 min. 59 sec.). To set the counter reading to "0:00", press the COUNTER RESET button. This counter is not an actual clock. Rather, it is a counter with minutes and seconds divisions when the tape length of the tape to be used is memorized. To memorize the tape length, press the TAPE button so that the desired tape length appears on the display. The tape length can be set to C-46, C-50, C-54, C-60, C-70, C-80 or C90.

Note: Precision of counter

The tape counter is not a clock, and so there will be some errors in the time display compared to the actual playing time (this cannot be avoided, as a suitable method is adopted to provide a time display not only during recording and playback, but also during fast forward and rewind). The error depends on the type of tape being used.

To display the remaining time

Press COUNTER REMAIN button so that the REMAIN indicator lights. The remaining time appears in the display a few seconds after pressing the PLAY button to start playback. Press again to return to the elapsed time.

- It is necessary to memorize the tape length with the TAPE button beforehand.



PLAY TRIM control adjustment

When the level of high frequencies is too boosted or absent while playing a tape recorded on another cassette deck, adjust the high frequency response with the PLAY TRIM control.

When high frequencies are too boosted, attenuate the high frequencies.

When high frequencies are absent, boost the high frequencies.

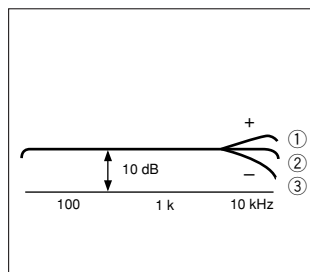
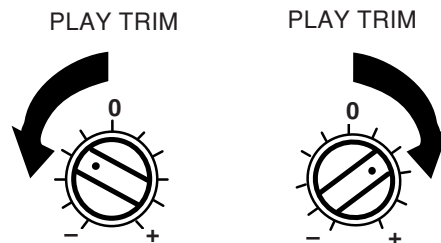

- ① High frequency sound is too boosted.
- ② Flat.
- ③ High frequency sound is absent.

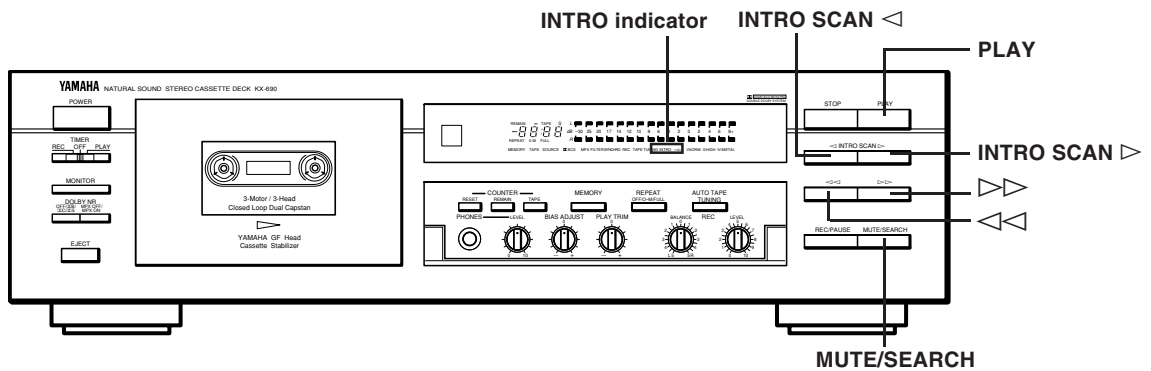

SELECTION SEARCH - To play back a desired selection by searching for the beginning of the selection

To search for the next selection

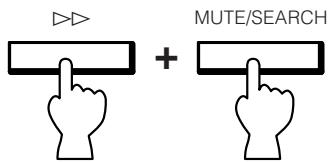

To search for the beginning of the current selection

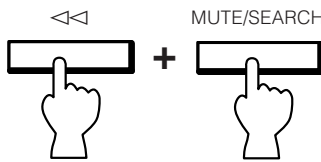

To search for the selection located before the current selection

When the beginning of the current selection is played:

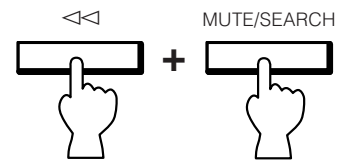

The << or >> button and the MUTE/SEARCH button should be pressed simultaneously.

INTRO SCAN - To play back the beginning of each selection automatically

To play back each selection in the reverse direction:

The INTRO < indicator lights during reverse intro scan.

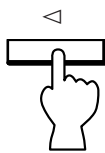

To play back each selection in the forward direction:

The INTRO > indicator lights during forward intro scan.

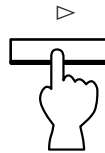

To resume normal playback when the desired selection is found:

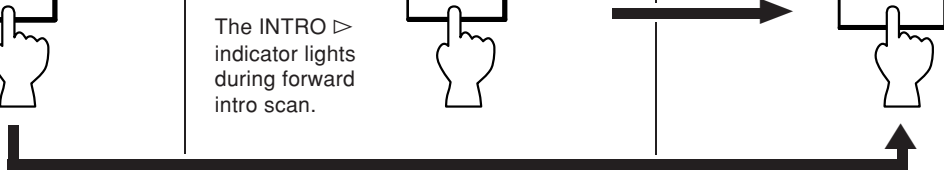
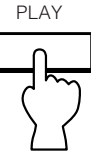

Notes on Selection search and Intro scan

- The blank interval between selections must be at least 4 seconds.
- Selection search and Intro scan may not operate properly with tapes recorded with a low record level or with excessive noise.

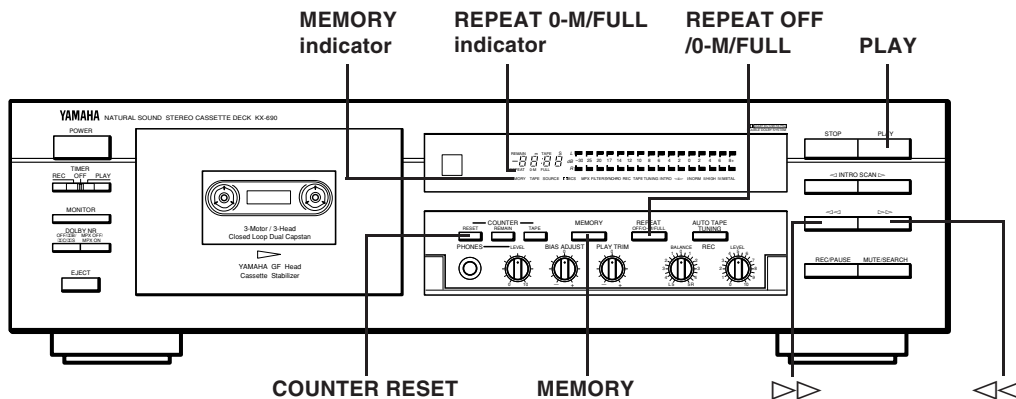

MEMORY STOP operation - To return to the desired position

Pressing the MEMORY button memorizes the desired counter reading. The MEMORY indicator lights.

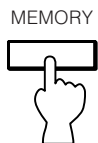

During fast forwarding or rewinding, the tape will stop at the counter reading point where the MEMORY button was pressed.

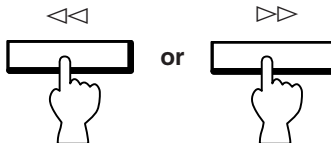

To cancel the memorized counter reading, press the MEMORY button again. The MEMORY indicator goes out.

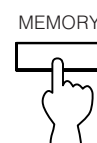

REPEAT PLAYBACK

0-M (a section) repeat

With this function, a desired section can be played repeatedly up to 8 times.

- 1 Press the REPEAT OFF/0-M/FULL button so that the REPEAT 0-M indicator lights.



- 2 Press the COUNTER RESET button at the beginning of the section you want to play repeatedly. The counter on the display is reset to "0:00".



- 3 Press the MEMORY button at the end of the section during playback. The MEMORY indicator on the display lights up, and the tape immediately begins rewinding.

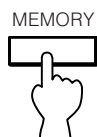

The tape is rewind until the counter has returned to the beginning of the section. The deck then enters the playback mode and the specified section is played repeatedly.

Full repeat

With this function, the cassette side being played can be repeated up to 8 times.

Press the REPEAT OFF/0-M/FULL button so that the REPEAT FULL indicator lights.

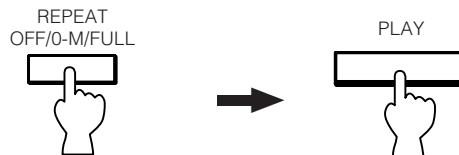

Note:

The length between the start and end points of the 0-M repeat section should be more than 4 counts.

To cancel repeat playback

To cancel the 0-M repeat or Full repeat, press the REPEAT OFF/0-M/FULL button so that both REPEAT 0-M and REPEAT FULL indicators go off. Each time this button is pressed, repeat mode switches as follows:



RECORDING

Preparation for recording

- Be sure to set the TIMER switch to the OFF position, then turn on the POWER switch.
- Set your amplifier or receiver to cassette deck function mode.

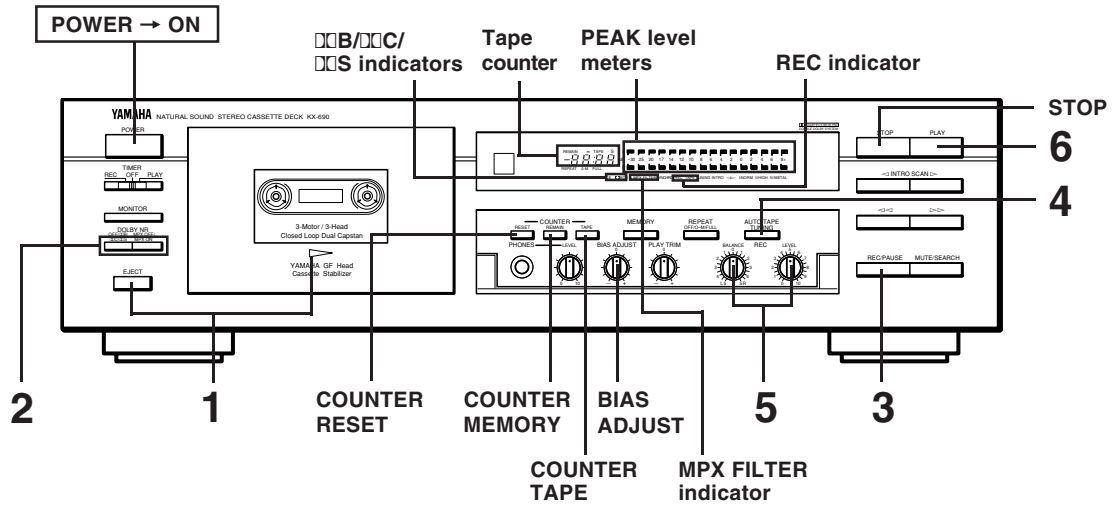

<p>1</p> <p>EJECT</p> <p>Insert the cassette with the exposed tape side facing down and the side to be recorded facing you. To close the compartment, push in the compartment door until it locks shut.</p>	<p>2</p> <p>DOLBY NR OFF/DBB/ MPX OFF/ C/C/S MPX ON</p>
<p>3</p> <p>REC/PAUSE</p> <p>Play the program source to be recorded.</p>	<p>4</p> <p>AUTO TAPE TUNING</p> <p>See "AUTO TAPE TUNING" button".</p>
<p>5</p> <p>BALANCE REC LEVEL</p> <p>See "Setting the recording level".</p>	<p>6</p> <p>STOP</p>

To stop recording:
Press the STOP button.

To stop recording temporarily:
Press the REC/PAUSE button. To resume recording, press the PLAY button.

Tape counter and COUNTER RESET button*
Before starting recording, press the COUNTER RESET button to set the counter reading to "0:00". Use this counter to aid in locating a point on a tape. It is necessary to memorize the tape length for accurate calculation of elapsed tape time and remaining tape time.

To memorize the tape length:
Press the COUNTER TAPE button. Each time the button is pressed, the display will change from "C-46", "C-50", "C-54", "C-60", "C-70", "C-80", to "C-90" and the last tape length to be displayed is memorized.

To display the remaining time*:
Press the COUNTER REMAIN button during recording. If the tape length is already memorized by the TAPE button, the unit will compute and display the remaining available recording time. Press again to return to the elapsed time counter reading. (This button is also used during playback.)

*** Note: Precision of counter**
The tape counter is not a clock, and so there will be some errors in the time display compared to the actual recording time (this cannot be avoided, as a suitable method is adopted to provide a time display not only during recording and playback, but also during fast forward and rewind). The error depends on the type of tape being used.

DOLBY NR button setting (in step 2)

DOLBY NR (OFF/□□B/□□C/□□S) button

Each time this button is pressed, Dolby NR switches as follows:

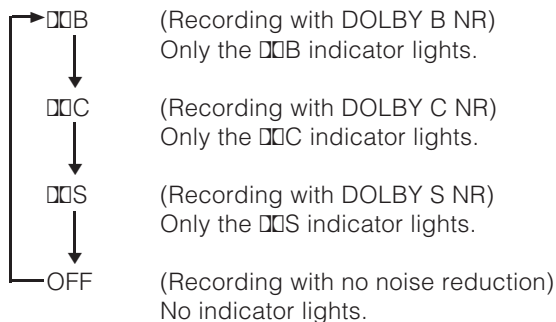

DOLBY NR (MPX OFF/MPX ON) button

Each time this button is pressed, MPX filter switches between on and off.

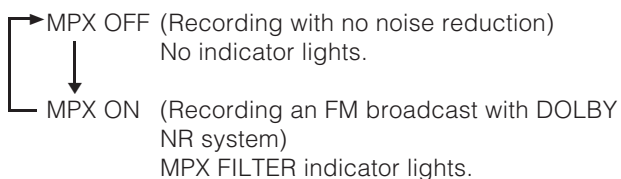

● **MPX filter:**

FM stations transmit a 19 kHz pilot signal in addition to the broadcast program. Sometimes this pilot signal may leak into the audio output depending on the tuner and broadcast conditions. This signal can cause improper operation of the Dolby NR systems. Activating the MPX filter (B TYPE/C TYPE/S TYPE MPX ON settings) will effectively remove the signal.

DOLBY HX PRO DYNAMIC BIAS SERVO SYSTEM

This unit incorporates the Dolby HX Pro system which automatically controls the effective bias to reduce distortion and noise, improving high frequency response during recording. Tapes recorded with this system retain the same high quality even when played back on any other cassette deck.

AUTO TAPE TUNING button (in step 4)

Pressing this button during the REC/PAUSE mode will activate the Auto Tape Tuning that makes it possible to internally determine the optimum recording characteristics (bias and recording sensitivity) according to the loaded cassette tape in about 15 seconds.

To perform the Auto Tape Tuning, send the tape leader part forward and set the PLAY/TRIM control and the BIAS ADJUST control to the center position before pressing the AUTO TAPE TUNING button. When the Auto Tape Tuning is completed, the TAPE TUNING indicator lights. After completion of Auto Tape Tuning, the tape automatically rewinds to the point where the Auto Tape Tuning began and the REC/PAUSE mode is engaged. The bias adjustment with the BIAS ADJUST control is possible even after this tuning.

To clear Auto Tape Tuning setting, press the AUTO TAPE TUNING button once again, or load any cassette tape of different type.

* When recording on the other side of the tape, another Auto Tape Tuning is unnecessary.

When recording on the same type cassette tape of a different brand, another Auto Tape Tuning is advisable for much more accurate setting of the recording characteristics.

AUTO TAPE TUNING

The Auto Tape Tuning function improves the quality of your recording, permitting critical adjustment of the deck's recording bias and sensitivity for best results with every tape you use.

With the Auto Tape Tuning function, the recording characteristics (recording bias and sensitivity) are automatically adjusted while recording and playback operations in about 15 seconds, to accurately match the characteristics of loaded tape.

For example, the recorded (output) level (A in the figure) may differ from recording (input) level (B in the figure), due to widely varying characteristics of cassette tapes between brands.

Using the Auto Tape Tuning function, these differences are effectively eliminated by adjusting the recording bias (for high frequencies) and sensitivity (for overall frequencies) according to the loaded cassette tape, making a significant contribution to overall recording quality (C in the figure).

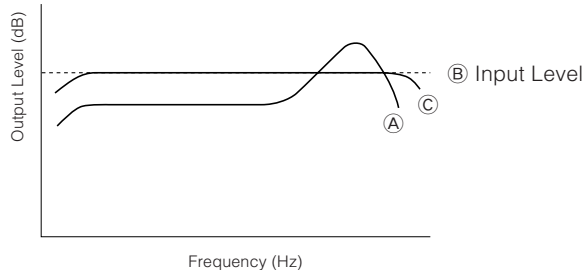

Display during recording

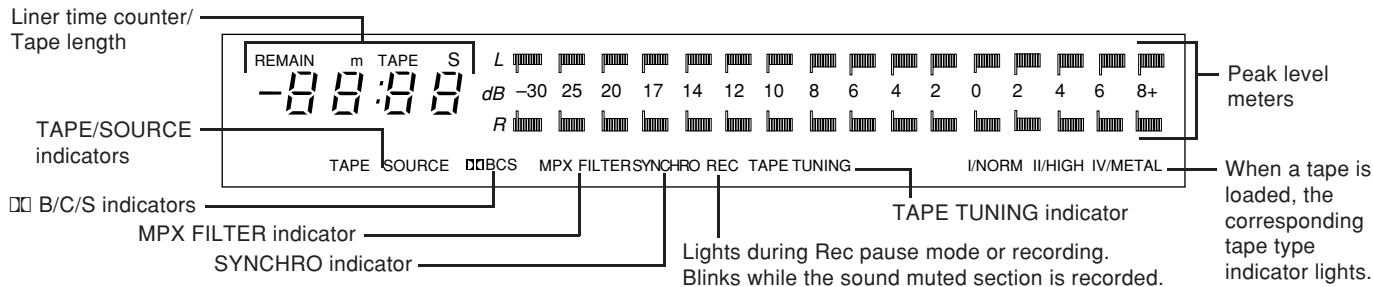

Setting the recording level (in step 5)

Play the loudest passage of the source to be recorded and watch the meter readings. Adjust the REC LEVEL control so that the highest peak may not exceed the optimum levels of each tape type. Normally, it is best to adjust the BALANCE control such that the LEFT and RIGHT meter readings are even.

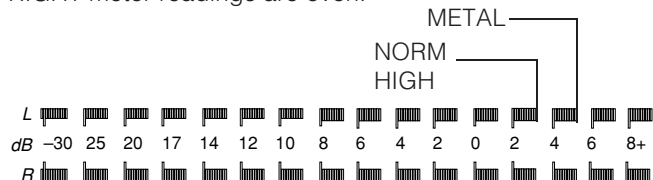

Bias adjustment

The BIAS ADJUST control is for fine adjustment of the recording bias. Normally, it is not necessary to adjust this control since the recording bias can be automatically adjusted by the built-in Auto Tape Selector and the AUTO TAPE TUNING button for different tape types. However, if you feel that your recording needs further bias adjustment (to compensate for absent or distorted high frequencies), adjust this control to your liking.

When high frequencies are distorted, increase the recording bias by turning the BIAS ADJUST control clockwise.

When high frequencies are absent, decrease the recording bias by turning the BIAS ADJUST control counterclockwise.

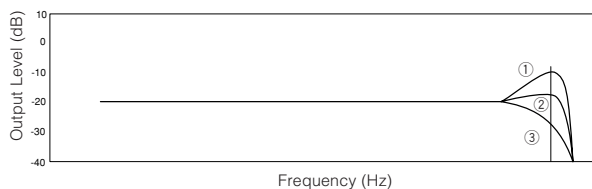
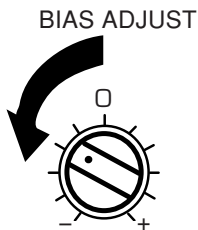
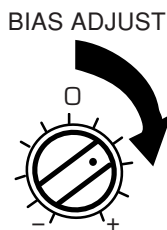

- ① Insufficient bias (High frequencies are distorted.)
- ② Optimum bias
- ③ Excessive bias (High frequencies are absent.)

Three head system

The three-head system allows the just-recorded sound to be monitored while recording. You can compare the difference between the recorded sound and the source sound by switching the monitor mode (SOURCE or TAPE) with the MONITOR button, so you can try to obtain a recording sound identical to the source sound.

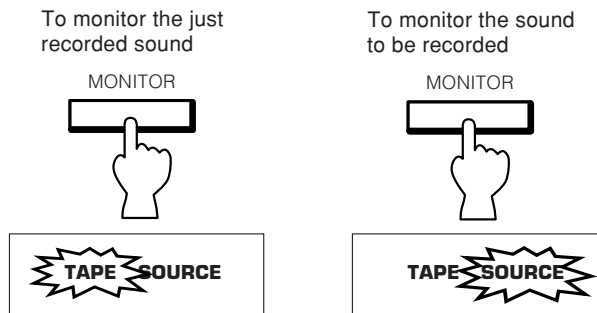

Synchronized recording function

When operating this unit in combination with the YAMAHA CD Player which has SYNCHRO button on its remote control transmitter, CD Synchronized recording function can be utilized. This function is operated with the remote control transmitter of the CD Player. (Regarding the operation, refer to the instruction manual of the CD Player.)

SYNCHRO indicator of this unit lights when the SYNCHRO button of the remote controller is pressed.



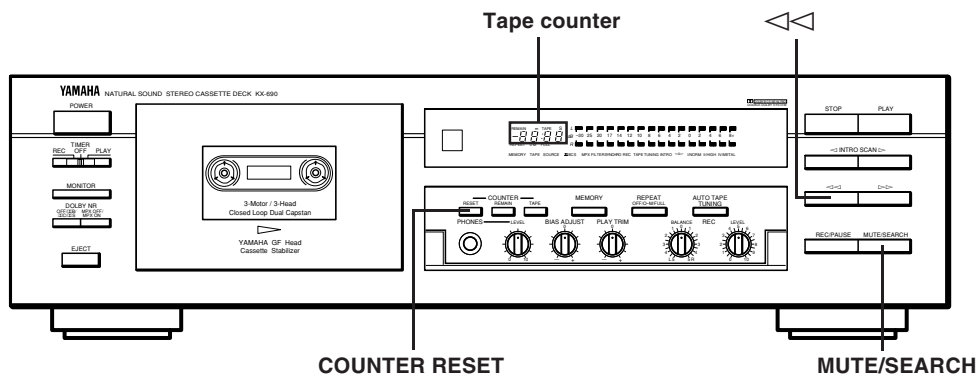

REC MUTE operation - Inserting a blank space during recording

During recording



A 4-second blank interval is automatically recorded on the tape, and then the deck enters Rec/Pause mode. If a blank interval longer than 4 seconds is desired, keep pressing the button as long as you want. When the MUTE/SEARCH button is released, the deck enters Rec/Pause mode after making a 4-second blank interval.

0-STOP operation - To return to the "0:00" point

During recording

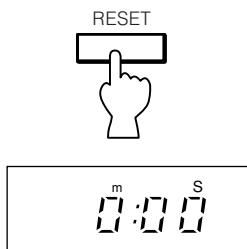

The "0:00" point is memorized.

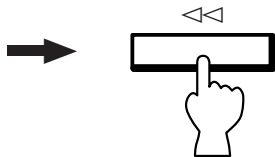

The tape will be automatically rewound to the "0:00" point.

REC RETURN operation - To return to the point at which the recording previously started

During recording

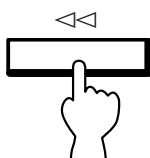

- If the <<< button is pressed during recording, Rec return operation automatically rewinds the tape to the point where the PLAY button was pressed.

TIMER RECORDING/PLAYBACK

With a commercially available audio timer it is possible to make recordings and initiate playback automatically at any time.

Make sure that all power cord connections between the timer and amplifier/receiver are properly made.

For details, refer to the instructions of your audio timer. No change in any of the other connections between the deck and amplifier/receiver, etc., is necessary.

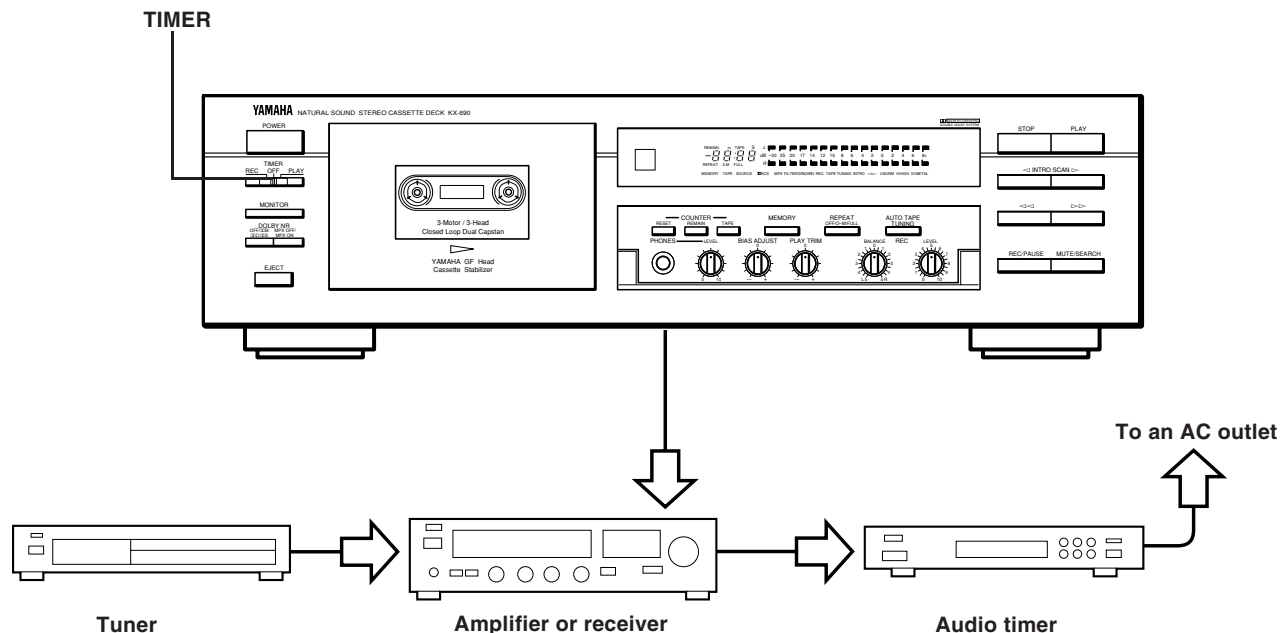

Timer recording

1. After turning on the power to each component, select the station on your tuner which you want to record and turn down the volume on your amplifier/receiver. This will have no effect on the recording signal level. Remember to set the proper recording level.
2. Set the timer to the desired recording start and stop times. It is advisable to set the timer to begin recording slightly before and end slightly after the actual broadcast receiving time to leave some room for later editing.
3. Set the TIMER switch to the REC position.

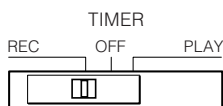

4. The timer will send power to the amplifier/receiver, tuner and deck at the preset time, turning all the components on and initiating the recording.

Timer playback

1. Turn on the amplifier/receiver and adjust the volume and tone controls.
2. Set the input mode selector of your amplifier/receiver to the cassette deck function mode.
3. Set the timer to the time you wish to start and stop playback.
4. Set the TIMER switch to the PLAY position.

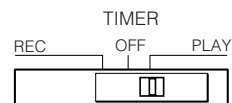

5. At the preset time, the timer will turn power on to the amplifier/receiver and cassette deck and begin playback. It will shut power off at the preset time as well ending playback.

Notes:

Whenever the timer recording/playback is not intended, make sure to set the TIMER switch to OFF position to prevent the unnecessary recording/playback.

- If the TIMER switch is set to REC position and the power is supplied (plugging in the power cord or automatically supplying the power after power failure, etc.), the deck automatically enters REC mode and the contents of the cassette tape inserted in the deck will be erased.

- If the cassette tape cannot be ejected after timer recording/playback, press the POWER button to turn on the power and then the STOP button. The EJECT button can now be operated.

CASSETTE TAPES

There are many different types of cassette tapes available. However, they all conform to standard specifications so any brand may be used with the deck.

- **Classification of Cassette Tapes by Formulation**
Cassette tapes are available in four basic types depending on their formulation, or type of magnetic material and manufacturing process. These four types are commonly known as Normal (Type I/NORM), Chrome (Type II/HIGH $\langle CrO_2 \rangle$), Ferrichrome (Type III/FeCr), and Metal (Type IV/METAL), and they each require specific tape deck adjustments for optimum performance.
- * YAMAHA does not recommend the use of 120 minute length cassettes since the extreme thinness of the tape makes them susceptible to mechanical and recording problems.

AUTO TAPE SELECTOR DETECTION SLOTS

The deck has a built-in Auto Tape Selector which automatically adjusts for the proper bias, level and equalization according to the tape formulation — all you have to do is load a cassette and the Auto Tape Selector does the rest.

The Auto Tape Selector determines which type of tape is loaded by sensing detector slots in the top of the tape shell. Each tape formulation has its own characteristic hole markings standardized by the tape industry.

- Early model Metal (Type IV/Metal) tape formulation cassette shells do not have the slots for Auto Tape Selector operation. As a result, early model Metal type tapes recorded on another deck will be played back with the deck at the Chrome (Type II/HIGH $\langle CrO_2 \rangle$) settings. YAMAHA does not recommend using this kind of tape.
- The deck does not have the required setting for Ferrichrome (Type III/FeCr) tape, since this tape formulation is not widely used. Should you use a Ferrichrome tape, it will be recorded and played back at the Normal (Type I/NORM) settings, which will result in an unnatural high frequency emphasis. This effect may be compensated for somewhat by adjusting the BIAS ADJUST to the plus (+) direction during recording, or by using the PLAY TRIM tone control and/or the tone controls of your amplifier/receiver during playback.

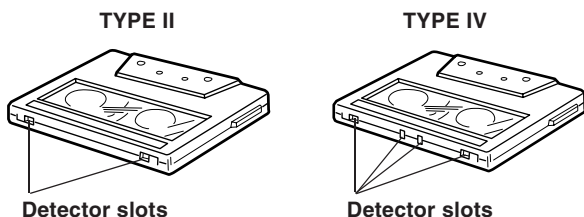

PROTECTING YOUR RECORDINGS

All cassette tapes are provided with erasure protection holes to prevent accidental erasure of recorded contents. There is a small tab covering the hole on each side of the cassette, and it should be broken off after recording the tape. Without this tab covering the hole, it is impossible to record onto that tape. Thus, you can safely protect a recording for as long as you wish without fear of accidental erasure. Should you wish to use a cassette tape protected in this way for recording, simply covering the hole with adhesive tape will permit erasure and re-recording.

- When using Chrome (Type II/HIGH $\langle CrO_2 \rangle$) or Metal (Type IV/METAL) tapes, make sure you do not cover the hole intended for the Auto Tape Selector operation.

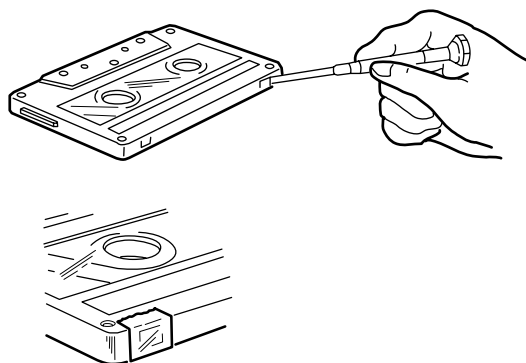

TAKING UP SLACK IN THE TAPE

As a precaution against tape entanglement and damage, remove any slack in the tape before inserting cassettes into the deck. This is accomplished by inserting a pencil, pen or similar object into one of the spools and gently winding it until all the slack is removed. You do not have to wind it too tightly.

Be careful not to touch the tape part itself. It is very delicate and touching it may damage the tape and its recorded contents.

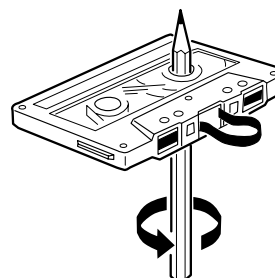

STORING CASSETTES

After putting a cassette tape back into its case, store it in a location away from exposure to direct sunlight, humidity, high temperatures, and magnetic fields (away from television sets, speakers, etc.). High temperatures and humidity will damage the tape itself, while exposure to magnetic fields may cause a loss of recorded material. Avoid touching the tape surface with your fingers, since dirt or finger oil will contaminate the deck's heads.

OPENING AND CLOSING THE SUB PANEL

To open the sub panel

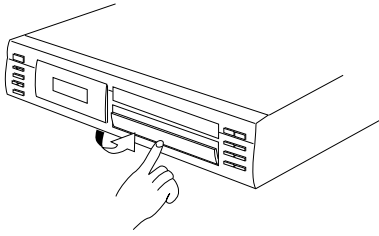

To close the sub panel

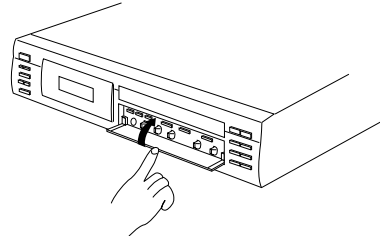

OPTIONAL REMOTE CONTROL TRANSMITTER

With the optional remote control transmitter RKX1, you can operate this unit at your listening position. For details, refer to the instruction manual supplied with the remote control transmitter.

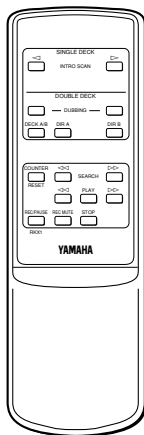

REMOTE CONTROL OPERATION RANGE

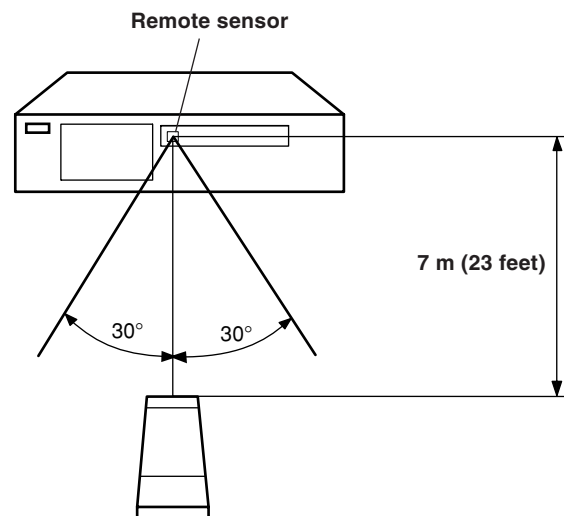

MAINTENANCE

CLEANING OF THE TAPE PATH

Continued high quality performance of your deck is dependent upon periodic cleaning of the heads, capstan, pinch roller, and all surfaces over which the tape travels. Normal use will cause an accumulation of dirt and dust on the heads, capstans, and pinch rollers. This can lead to poor sound quality, drop outs (intervals with no sound), unsteady tape speed, loss of high frequency response, etc.

Thus, clean the heads and all surfaces over which the tape travels with a commercially available cleaning cassette and fluid type cleaner.

Inside of the cassette compartment

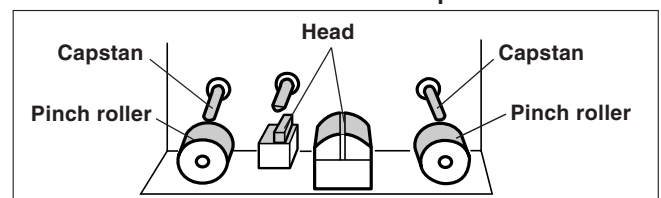

DEMAGNETIZATION

After 20-30 hours of use, enough residual magnetism will build up on the heads to cause poor high frequency reproduction. At this time you should use a commercially available head demagnetizer.

- When cleaning the tape path or demagnetizing the heads, be sure to follow carefully the instructions of the concerning materials such as cleaning fluid or head demagnetizer.

TROUBLESHOOTING

If your cassette deck fails to operate normally, check the following table. It lists common operating errors and simple measures which you can take to correct the problem. If it cannot be corrected, or the symptom is not listed, disconnect the deck's power cord and contact your authorized YAMAHA dealer or a authorized service center for help.

Fault	Cause	Cure
Tape doesn't move in recording or playback.	<ul style="list-style-type: none"> ● Power plug is not properly plugged in. ● End of tape. ● Cassette shell is warped or damaged. 	<ul style="list-style-type: none"> ● Reinsert plug properly. ● Rewind tape or flip it over. ● Do not play damaged tapes.
REC/PAUSE button fails to function.	<ul style="list-style-type: none"> ● No cassette tape loaded. ● Protective tabs are broken off. 	<ul style="list-style-type: none"> ● Load a cassette tape. ● Change tape or cover protective hole with adhesive tape.
Sounds become faint and sometimes inaudible.	<ul style="list-style-type: none"> ● Head is dirty. ● Head is magnetized. ● Tape is damaged or of poor quality. 	<ul style="list-style-type: none"> ● Clean head. ● Demagnetize head using head demagnetizer. ● Change to a different tape.
Recorded sound is distorted.	<ul style="list-style-type: none"> ● Tape is bad (stretched or deformed, etc.). ● Cassette shell is warped. ● Recording level is too high. 	<ul style="list-style-type: none"> ● Replace with a fresh tape. ● A warped cassette shell cannot be fixed. Replace with another tape and test. ● Check input level with signal level meter and use lower rec level when recording.
Tape is playing back, but no sound is heard.	<ul style="list-style-type: none"> ● Faulty connection between deck and stereo amplifier/receiver. 	<ul style="list-style-type: none"> ● Check and secure connections.
Excessive noise.	<ul style="list-style-type: none"> ● Head is dirty. ● Head is magnetized. ● Worn out or poor quality tape. ● Connection(s) improperly made. ● Affected by external electrical noise. 	<ul style="list-style-type: none"> ● Clean head. ● Demagnetize head with head demagnetizer. ● Change to better tape. ● Check input and output connections and reinsert properly. ● Move away from electrical appliances (TV, fluorescent light, electric blanket, etc.).
Excessive wow (wavering of the sound).	<ul style="list-style-type: none"> ● Dirty capstan, pinch roller, etc., or poor tape. ● Tape is wound unevenly. 	<ul style="list-style-type: none"> ● Clean capstan and pinch roller, or change to better tape. ● Rewind tape.
Tape stops in the middle of recording or playback.	<ul style="list-style-type: none"> ● Slack tape, or tape spillage wound around capstan. 	<ul style="list-style-type: none"> ● Insert pencil in hole in cassette shell and turn to take up slack.
Fails to record.	<ul style="list-style-type: none"> ● REC LEVEL control is set to too low. ● Protective tabs are broken off. 	<ul style="list-style-type: none"> ● Adjust REC LEVEL control. ● Change tape or cover protective hole with adhesive tape.
Search does not operate.	<ul style="list-style-type: none"> ● Recorded section is too short. ● Recorded section has low-level portions. ● Conversation, etc. has been recorded. 	<ul style="list-style-type: none"> ● Blank sections must be at least 4 seconds long. ● No remedy ● No remedy
High frequencies in the playback sound are emphasized and unpleasant to listen to, and noise level (hiss) is also high.	<ul style="list-style-type: none"> ● Dolby NR-recorded tape is played back in OFF position. 	<ul style="list-style-type: none"> ● Play back in appropriate Dolby NR position.

Fault	Cause	Cure
Playback sound is muffled and high frequencies are inaudible.	<ul style="list-style-type: none"> ● Normally-recorded tape is played back in Dolby NR. ● Heads are dirty. ● Heads are magnetized. 	<ul style="list-style-type: none"> ● Playback in OFF position. ● Clean heads and carry out demagnetization with head demagnetizer.
When playing back tapes recorded on other decks, meter deflections are greater (smaller) than when recorded.	<ul style="list-style-type: none"> ● Basic levels are different for different cassette decks. 	<ul style="list-style-type: none"> ● This is not a fault.
Recordings cannot be made with TIMER REC (deck only plays back).	<ul style="list-style-type: none"> ● Protective tabs on cassette have been broken off. 	<ul style="list-style-type: none"> ● Replace cassette tape, or cover tab holes with tape, etc.
The remote control transmitter cannot be operated.	<ul style="list-style-type: none"> ● The batteries are exhausted. ● The remote control transmitter is operated from an incorrect distance or angle. ● The remote control sensor is lighted strongly. 	<ul style="list-style-type: none"> ● Replace batteries. ● Operate it from less than 7 meters (about 23 ft.) and 30°. ● Place the unit away from the strong light.

SPECIFICATIONS

Track Configuration	4 track, 2 channel stereo
Motor	DC servo motor (capstan) DC motor (reel) DC motor (assist)
Head	Recording/playback: hard permalloy Erase: double-gap Ferrite head
Rapid Transport	95 sec. (C-60)
Wow and Flutter	
WRMS	0.04%
W.Peak	±0.07%
Signal-to-Noise Ratio	
Dolby NR off	60 dB
Dolby B NR on	68 dB
Dolby C NR on	76 dB
Dolby S NR on	80 dB
Frequency Response	
Normal tape (-20 dB)	20 ~ 18,000 Hz ±3 dB
CrO₂ tape (-20 dB)	20 ~ 19,000 Hz ±3 dB
Metal tape (-20 dB)	20 ~ 21,000 Hz ±3 dB
Harmonic Distortion	0.8%
Input Sensitivity/Impedance	
Line	100 mV/43 k-ohms
Output Level	
Line	570 mV/2 k-ohms
Phones	1.5 mW/8 ohms
Channel Separation (1 kHz)	45 dB
Cross Talk (125 Hz)	55 dB

GENERAL

Power Supplies

U.S.A. and Canada model	120 V, 60 Hz
Europe model	230 V, 50 Hz
U.K. model and Australia model	240 V, 50 Hz
General model	110/120/220/240 V, 50/60 Hz

Power Consumption 20 W

Dimensions (W x H x D) 435 x 126 x 279.5 mm
(17-1/8" x 4-15/16" x 11")

Weight 5.0 kg (11 lbs.)

Accessories

Output/input cord 1 pair

* Specifications subject to change without notice.

YAMAHA

YAMAHA ELECTRONICS CORPORATION, USA 6660 ORANGETHORPE AVE., BUENA PARK, CALIF. 90620, U.S.A.

YAMAHA CANADA MUSIC LTD. 135 MILNER AVE., SCARBOROUGH, ONTARIO M1S 3R1, CANADA

YAMAHA ELECTRONIK EUROPA G.m.b.H. SIEMENSSTR. 22-34, 25462 RELINGEN, BEI HAMBURG, F.R. OF GERMANY

YAMAHA ELECTRONIQUE FRANCE S.A. RUE AMBROISE CROIZAT BP70 CROISSY-BEAUBOURG 77312 MARNE-LA-VALLEE CEDEX02, FRANCE

YAMAHA ELECTRONICS (UK) LTD. YAMAHA HOUSE, 200 RICKMANSWORTH ROAD WATFORD, HERTS WD1 7JS, ENGLAND

YAMAHA SCANDINAVIA A.B. J A WETTERGRENS GATA 1, BOX 30053, 400 43 VASTRA FRÖLUNDA, SWEDEN

YAMAHA MUSIC AUSTRALIA PTY, LTD. 17-33 MARKET ST., SOUTH MELBOURNE, 3205 VIC., AUSTRALIA

YAMAHA CORPORATION

VU 38230