

YSP-1000

Digital Sound Projector

Système Acoustique Numérique

OWNER'S MANUAL
MODE D'EMPLOI
BEDIENUNGSANLEITUNG
BRUKSANVISNING
MANUALE DI ISTRUZIONI
MANUAL DE INSTRUCCIONES
GEBRUIKSAANWIJZING

CAUTION: READ THIS BEFORE OPERATING THIS UNIT.

- 1 To assure the finest performance, please read this manual carefully. Keep it in a safe place for future reference.
- 2 Install this sound system in a well ventilated, cool, dry, clean place with at least 5 cm of space above (or below) this unit – away from direct sunlight, heat sources, vibration, dust, moisture, and/or cold.
- 3 Locate this unit away from other electrical appliances, motors, or transformers to avoid humming sounds.
- 4 Do not expose this unit to sudden temperature changes from cold to hot, and do not locate this unit in an environment with high humidity (i.e. a room with a humidifier) to prevent condensation inside this unit, which may cause an electrical shock, fire, damage to this unit, and/or personal injury.
- 5 Avoid installing this unit where foreign object may fall onto this unit and/or this unit may be exposed to liquid dripping or splashing. On the top of this unit, do not place:
 - Other components, as they may cause damage and/or discoloration on the surface of this unit.
 - Burning objects (i.e. candles), as they may cause fire, damage to this unit, and/or personal injury.
 - Containers with liquid in them, as they may fall and liquid may cause electrical shock to the user and/or damage to this unit.
- 6 Do not cover this unit with a newspaper, tablecloth, curtain, etc. in order not to obstruct heat radiation. If the temperature inside this unit rises, it may cause fire, damage to this unit, and/or personal injury.
- 7 Do not plug in this unit to a wall outlet until all connections are complete.
- 8 Do not operate this unit upside-down. It may overheat, possibly causing damage.
- 9 Do not use force on switches, knobs and/or cords.
- 10 When disconnecting the power supply cable from the wall outlet, grasp the plug; do not pull the cable.
- 11 Do not clean this unit with chemical solvents; this might damage the finish. Use a clean, dry cloth.
- 12 Only voltage specified on this unit must be used. Using this unit with a higher voltage than specified is dangerous and may cause fire, damage to this unit, and/or personal injury. YAMAHA will not be held responsible for any damage resulting from use of this unit with a voltage other than specified.
- 13 Do not attempt to modify or fix this unit. Contact qualified YAMAHA service personnel when any service is needed. The cabinet should never be opened for any reasons.
- 14 When not planning to use this unit for long periods of time (i.e. vacation), disconnect the AC power plug from the wall outlet.
- 15 Be sure to read the “TROUBLESHOOTING” section on common operating errors before concluding that this unit is faulty.
- 16 Before moving this unit, press STANDBY/ON to set this unit in standby mode, and disconnect the AC power plug from the wall outlet.
- 17 Condensation will form when the surrounding temperature changes suddenly. Disconnect the power supply cable from the outlet, then leave the unit alone.
- 18 When using the unit for a long time, the unit may become warm. Turn the power off, then leave the unit alone for cooling.
- 19 Install this unit near the wall outlet and where the AC power plug can be reached easily.

WARNING

TO REDUCE THE RISK OF FIRE OR ELECTRIC SHOCK, DO NOT EXPOSE THIS UNIT TO RAIN OR MOISTURE.

WARNING

THE POWER SUPPLY CABLE OF THIS UNIT MUST BE CONNECTED TO THE MAIN SOCKET OUTLET VIA A PROTECTIVE EARTHING CONNECTION.

This unit is not disconnected from the AC power source as long as it is connected to the AC wall outlet, even if this unit itself is turned off. This state is called the standby mode. In this state, this unit is designed to consume a very small quantity of power.

FOR U.K. CUSTOMERS

If the socket outlets in the home are not suitable for the plug supplied with this appliance, it should be cut off and an appropriate 3 pin plug fitted. For details, refer to the instructions described below. Note that the plug severed from the mains lead must be destroyed, as a plug with bared flexible cord is hazardous if engaged in a live socket outlet.

IMPORTANT

THE WIRES IN MAINS LEAD ARE COLOURED IN ACCORDANCE WITH THE FOLLOWING CODE:

Blue: NEUTRAL

Brown: LIVE

As the colours of the wires in the mains lead of this apparatus may not correspond with the coloured markings identifying the terminals in your plug, proceed as follows:

The wire which is coloured BLUE must be connected to the terminal which is marked with the letter N or coloured BLACK. The wire which is coloured BROWN must be connected to the terminal which is marked with the letter L or coloured RED. Make sure that neither core is connected to the earth terminal of the three pin plug.

CAUTION

Danger of explosion if battery is incorrectly replaced. Replace only with the same or equivalent type.

CAUTION

Use of controls or adjustments or performance of procedures other than those specified herein may result in hazardous radiation exposure.

CONTENTS

INTRODUCTION

OVERVIEW	2
FEATURES	3
USING THIS MANUAL	4
SUPPLIED ACCESSORIES	5
CONTROLS AND FUNCTIONS	6
Front panel	6
Front panel display	7
Rear panel	8
Remote control	9

PREPARATION

INSTALLATION	11
Before installing this unit	11
Installing this unit	11
CONNECTIONS	15
Connecting a TV	16
Connecting a DVD player/recorder	17
Connecting a VCR	18
Connecting a digital satellite tuner or a cable TV tuner	19
Connecting a digital airwave tuner	20
Connecting other external components	21
Connecting a subwoofer	22
Affixing the optical cable	23
Connecting the power supply cable	23
About the RS-232C/REMOTE IN/ IR-OUT terminals	23

SETUP

GETTING STARTED	24
Installing batteries in the remote control	24
Operation range of the remote control	24
Using the remote control	25
Turning on the power	25
USING SET MENU	26
Displaying the OSD	26
The flow chart of SET MENU	27
AUTO SETUP	28
The flow chart of AUTO SETUP	28
Installing the optimizer microphone	29
Using AUTO SETUP	31
USING THE SYSTEM MEMORY	36
Saving settings	36
Loading settings	37

BASIC OPERATION

PLAYBACK	39
Selecting the input source	39
Playing back sources	40
Adjusting the volume	40
Muting the sound	41
BEAM MODE	42
5 beam mode	43
Stereo plus 3 beam mode	43
3 beam mode	44
Stereo mode	44
Target mode	45
ENJOYING SURROUND SOUND	46
Enjoying 2-channel sources in surround sound	47
Enjoying TV in surround sound	48
Adjusting surround mode parameters	49
USING SOUND FIELD PROGRAMS	51
What is a sound field?	51
Sound field program descriptions	52
Turning on CINEMA DSP programs	53
Turning off CINEMA DSP programs	55
Adjusting CINEMA DSP levels	55
USING THE VOLUME MODE	56
USING TruBass	58
USING THE SLEEP TIMER	60
Setting the sleep timer	60
Canceling the sleep timer	61

ADVANCED OPERATION

BASIC SETUP	62
MANUAL SETUP	68
Using MANUAL SETUP	69
BEAM MENU	70
SOUND MENU	74
INPUT MENU	77
DISPLAY MENU	79
ADJUSTING SYSTEM PARAMETERS	80
Setting the maximum volume level	80
Protecting the current settings	81
Initializing the current settings	82
Adjusting the audio balance	83
SELECTING THE INPUT MODE	86
REMOTE CONTROL FEATURES	87
Setting remote control codes	87
Controlling other components	88
Using the TV macro	90

ADDITIONAL INFORMATION

TROUBLESHOOTING	92
GLOSSARY	95
Audio formats	95
Audio information	95
INDEX	96
SPECIFICATIONS	97

OVERVIEW

It is generally accepted that in order to fully enjoy the benefits of surround sound at home, you must endure the agony of wiring and installing a great number of speakers in the hope that your listening room will give you the same kind of surround sound experience as your local movie theater.

YAMAHA YSP-1000 Digital Sound Projector challenges this preconception that complicated speaker setup and troublesome wiring go hand-in-hand with the enjoyment of multi-channel surround sound.

This slimline unit does away with the need for complicated wiring and installation worries, leaving you with a unit that is not only easy to set up, but which is also capable of reproducing the kind of powerful surround sound you have been waiting for from its built-in subwoofers (2) and individual speakers (40).

You can fine-tune the parameters of this unit to adjust the delay time for separate sound beams, resulting in highly directional sound that comes in on the listening position from all directions.

The YSP-1000 projects sound beams containing surround sound information for the front right (R), front left (L), surround right (SR) and surround left (SL) speaker positions, which are reflected off the walls of your listening room before reaching the actual listening position. With the addition of center (C) sound beams, this Digital Sound Projector creates true-to-life 5.1 channel surround sound that makes you feel as if there are actual speakers around the room. Sit back and enjoy the real sound experience of this simple, yet stylish Digital Sound Projector.

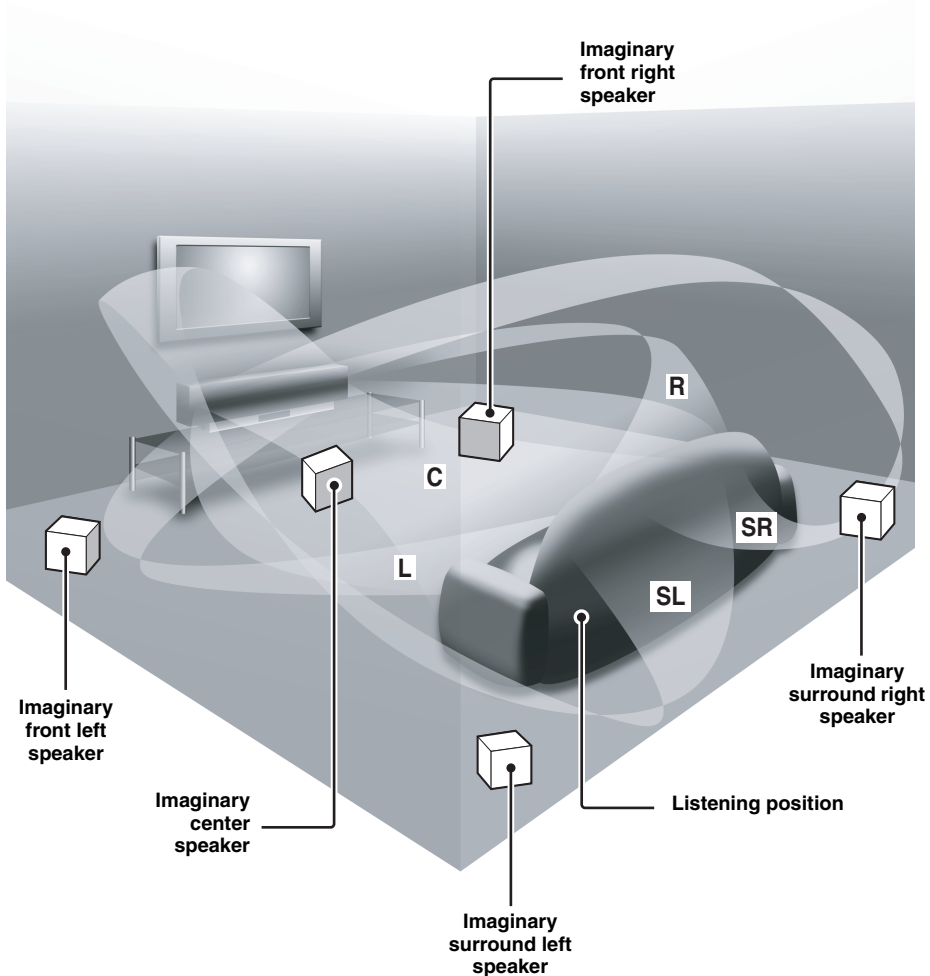

FEATURES

Digital Sound Projector

This unit employs the digital sound projector technology that allows one slim unit to control and steer multiple channels of sound to generate full, physical 5.1 channel surround sound, thus eliminating the need for satellite loudspeakers and cabling normally associated with conventional surround sound systems. This unit is also equipped with the following 5 beam modes so that you can choose the behavior of sound beams that best matches your listening environment.

- ◆ 5 beam mode
- ◆ ST(STEREO)+3 beam mode
- ◆ 3 beam mode
- ◆ Stereo mode
- ◆ Target mode

Cinema DSP Digital

This unit employs the Cinema DSP Digital technology developed by YAMAHA Electronics Corp. so that you can experience movies at home with all the dramatic sound impact that the director intended to convey.

OSD (on-screen display)

This unit employs the OSD which is basically a superimposed screen image displayed on your video monitor. The OSD is used to display the system information or adjust settings for the system parameters.

Versatile Remote Control

The supplied remote control come with preset remote control codes to be used to control the DVD player, VCR, cable TV tuner and digital satellite tuner connected to this unit. In addition, the remote control is equipped with the macro capability so that you can perform a series of operations with the press of a single button.



The “CINEMA DSP” logo and “Cinema DSP” are registered trademarks of YAMAHA Corporation.



Manufactured under license from Dolby Laboratories.

“Dolby”, “Pro Logic”, and the double-D symbol are trademarks of Dolby Laboratories.



“DTS”, and “Neo:6” are trademarks of Digital Theater Systems, Inc.

AUTO SETUP

This unit employs the automatic sound beam optimization using the YAMAHA Parametric Room Acoustic Optimizer (YPAO) technology with the aid of the supplied optimizer microphone so that you can avoid troublesome listening-based speaker setup and achieve highly accurate sound beam adjustments that best match your listening environment.

Compatibility with the Newest Technologies

This unit employs decoders compatible with Dolby Digital, DTS (Digital Theater Systems), Dolby Pro Logic, Dolby Pro Logic II and DTS Neo:6.

- ◆ Dolby Digital
This is the standard audio signal format used on DVDs and other purely digital media. This surround technology deliver high-quality digital audio for up to 5.1 discrete channels to produce a directional and more realistic effect.
- ◆ DTS (Digital Theater Systems)
This is an audio signal format used on DVDs and other purely digital media. This surround technology deliver high-quality digital audio for up to 5.1 discrete channels to produce a directional and more realistic effect.
- ◆ Dolby Pro Logic
This sophisticated, matrix decoding technology up-converts any 2 channel source audio to a surround sound playback.
- ◆ Dolby Pro Logic II
This is fundamentally a redesigned version of Dolby Pro Logic that employs 2 stereo surround channels, a subwoofer and a greatly enhanced steering logic. As a result, this improved technology provides an exceptionally stable sound field that simulates 5.1 to a much greater degree than the original Dolby Pro Logic. In addition, Dolby Pro Logic II features Movie, Music and Game modes specifically designed for movies, music and games respectively.
- ◆ DTS Neo:6
This technology decodes the conventional 2 channel sources for maximum 6 channel playback, enabling playback with the full-range channels with higher separation. This unit is equipped with the 5 channel playback mode. Music mode and Cinema mode are available to play back music and movie sources respectively.



Manufactured under license from 1 Ltd. Worldwide patents applied for.

The ‘1’ logo and ‘Digital Sound Projector™’ are trademarks of 1 Ltd.



TruBass, SRS and the “●” symbol are registered trademarks of SRS Labs, Inc. TruBass technology is incorporated under license from SRS Labs, Inc.

USING THIS MANUAL

Notes

- This manual describes how to connect and operate this unit. For details regarding the operation of external components, refer to the supplied owner's manual for the component.
- Some operations can be performed by using either the buttons on the main unit or on the remote control. In such cases, the operation is described using remote control operation.
-  indicates a tip for your operation.
- This manual is printed prior to production. Design and specifications are subject to change in part as a result of improvements, etc. In case of differences between the manual and product, the product has priority.

1 Install this unit in your listening room.

See "INSTALLATION" on page 11.



2 Connect this unit to your TV and other external components.

See "CONNECTIONS" on page 15.



3 Prepare the remote control and turn on the power of this unit.

See "GETTING STARTED" on page 24.



4 Run AUTO SETUP.

See "AUTO SETUP" on page 28.



5 Play back a source and enjoy surround sound.

See "PLAYBACK" on page 39.



If you want to make additional settings and adjustments

6 Run MANUAL SETUP and set remote control codes to fine-tune settings.

See "MANUAL SETUP" on page 68 and "REMOTE CONTROL FEATURES" on page 87.

SUPPLIED ACCESSORIES

Check that you have received all of the following parts.

Remote control (×1)

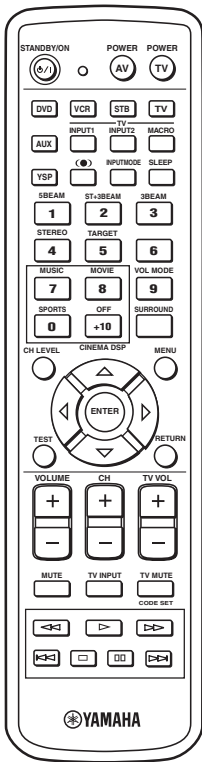

**Batteries (×2)
(AA, R6, UM-3)**

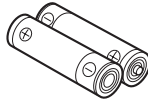

Optical cable (×1)



Video pin cable (×1)

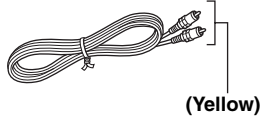

Digital audio pin cable (×1)

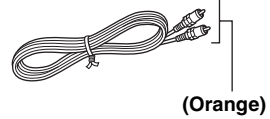

Optimizer microphone (×1)

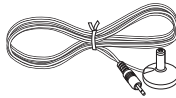

Audio pin cable (×1)

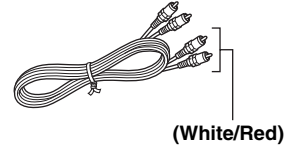

Cable clamp (×1)

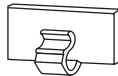

Fastener (×4)

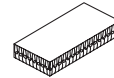

Cardboard microphone stand (×1)

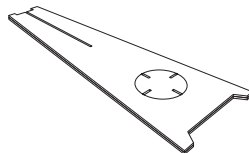

Power supply cable (×1)

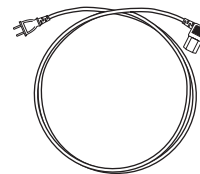

CONTROLS AND FUNCTIONS

Front panel

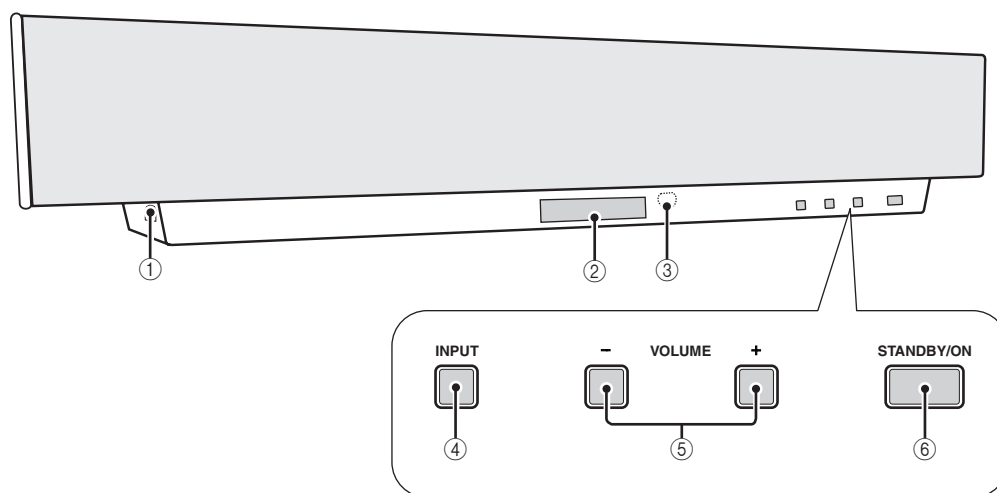

① OPTIMIZER MIC jack

Use to connect the supplied optimizer microphone to be used to run AUTO SETUP (see page 28).

② Front panel display

Shows information about the operational status of this unit.

③ Remote control sensor

Receives infrared signals from the remote control.

④ INPUT

Press repeatedly to switch between input sources (TV, STB, VCR, DVD or AUX). See page 39 for details.

⑤ VOLUME +/-

Controls the volume level of all audio channels (see page 40).

⑥ STANDBY/ON

Turns on the power of this unit or sets it to the standby mode (see page 25).

Notes

- When you turn on the power of this unit, you will hear a click and there will be a 4 to 5-second delay before it can reproduce sound.
- In the standby mode, this unit consumes a small amount of power in order to receive infrared-signals from the remote control.

Front panel display

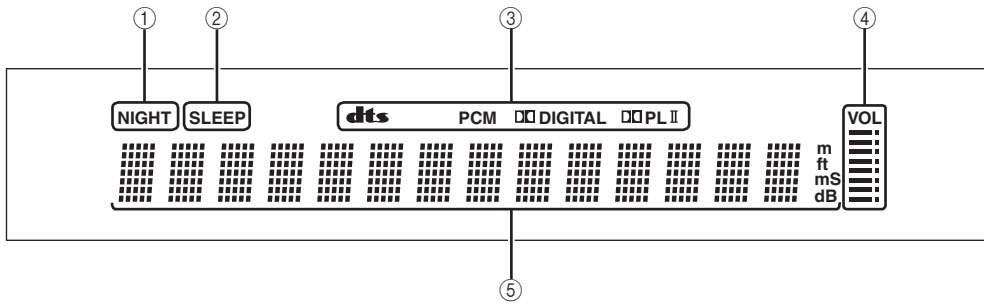

① NIGHT indicator

Lights up when you select a volume mode (see page 56).

② SLEEP indicator

Lights up when the sleep timer is turned on (see page 60).

③ Decoder indicators

Light up when the corresponding decoder of this unit is in operation (see page 46).

④ Volume level indicator

Shows the current volume level (see page 40).

⑤ Multi-information display

Shows information when you adjust the parameters of this unit.



You can adjust the brightness of the front panel display using the DISPLAY MENU parameters in MANUAL SETUP (see page 79).

Rear panel

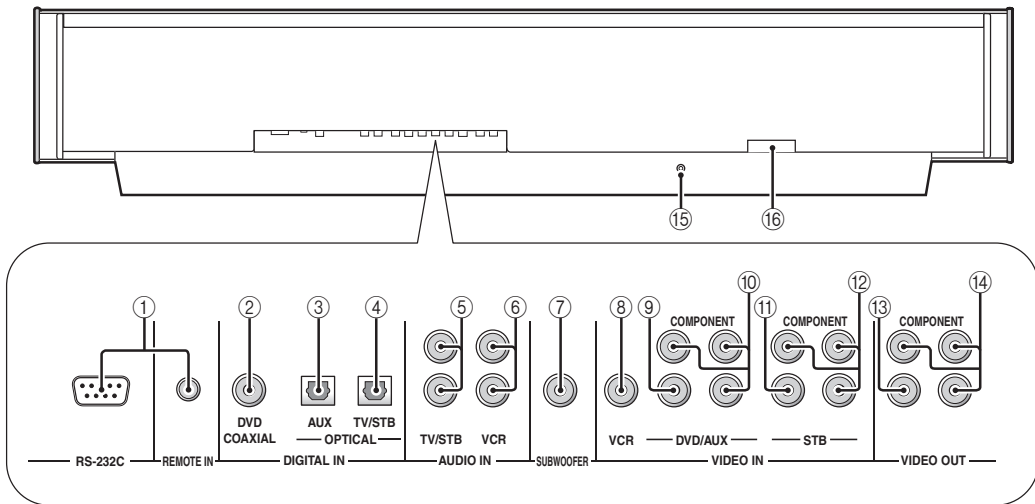

① RS-232C/REMOTE IN terminals

These are control expansion terminals for factory use only (see page 23).

② DVD COAXIAL DIGITAL IN jack

Use to connect a DVD player/recorder via a coaxial digital connection (see page 17).

③ AUX OPTICAL DIGITAL IN jack

Use to connect an external component via an optical digital connection (see page 21).

④ TV/STB OPTICAL DIGITAL IN jack

Use to connect a TV, a digital satellite tuner or a cable TV tuner via an optical digital connection (see page 16, 19 and 20).

⑤ TV/STB AUDIO IN jacks

Use to connect a TV, a digital satellite tuner or a cable TV tuner via an analog audio connection (see page 16, 19 and 20).

⑥ VCR AUDIO IN jacks

Use to connect a VCR via an analog audio connection (see pages 17 and 18).

⑦ SUBWOOFER jack

Use to connect a subwoofer (see page 22).

⑧ VCR VIDEO IN jack

Use to connect a VCR via a composite analog video connection (see page 18).

⑨ DVD/AUX VIDEO IN jack

Use to connect a DVD player/recorder or an external component via a composite analog video connection (see page 17).

⑩ DVD/AUX COMPONENT VIDEO IN jacks

Use to connect a DVD player/recorder or an external component via a component analog video connection (see page 17).

⑪ STB VIDEO IN jack

Use to connect a digital satellite tuner or a cable TV tuner via a composite analog video connection (see pages 19 and 20).

⑫ STB COMPONENT VIDEO IN jacks

Use to connect a digital satellite tuner or a cable TV tuner via a component analog video connection (see pages 19 and 20).

⑬ VIDEO OUT jack

Use to connect to the video input jack of your TV via a composite analog video connection to display the OSD of this unit (see page 16).

⑭ COMPONENT VIDEO OUT jacks

Use to connect to the video input jacks of your TV via a component analog video connection to display the OSD of this unit (see page 16).

⑮ IR-OUT terminal

This is a control expansion terminal for factory use only (see page 23).

⑯ AC IN

Use to connect the supplied power supply cable (see page 23).

Remote control

This section describes the function of each control on the remote control used to control this system.



You can also control other components using the remote control once you set the appropriate remote control codes. See “Controlling other components” on page 88 for details.

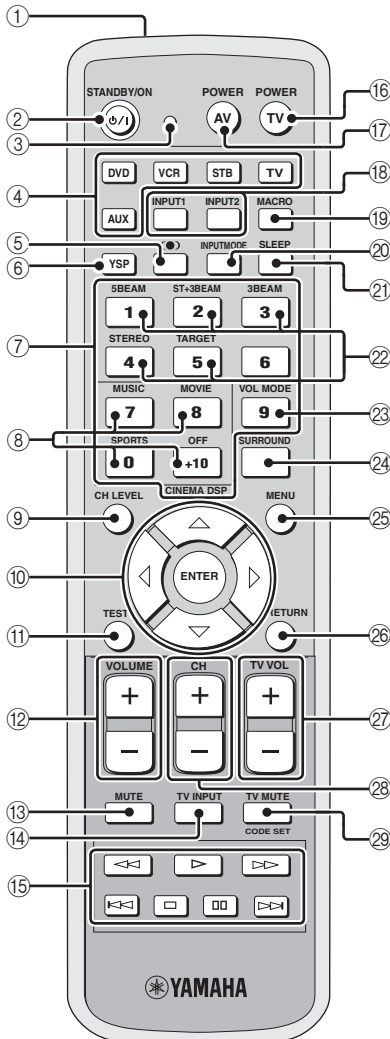

① Infrared window

Outputs infrared control signals. Aim this window at the component you want to operate.

② STANDBY/ON

Sets this system to the standby mode (see page 25).

③ Transmission indicator

Lights up when infrared control signals are being output.

④ Input selector buttons

Use to select an input source (TV, STB, VCR, DVD or AUX) and change the control area (see page 39).

⑤ ● TruBass

Use to effectively reproduce the bass sound (see page 58).

⑥ YSP

Switches to the operation mode of this unit.

⑦ Numeric buttons

Use to enter numbers.

⑧ Sound field program buttons

Use to select sound field programs (see page 51).

⑨ CH LEVEL

Adjusts the volume level of each channel (see page 84).

⑩ Cursor buttons \triangle / ∇ / \triangleleft / \triangleright , ENTER

Use to select and adjust SET MENU items.

⑪ TEST

Outputs a test tone when adjusting the output level of each speaker (see page 83).

⑫ VOLUME +/-

Increases or decreases the volume level of this unit (see page 40).

⑬ MUTE

Mutes the sound. Press again to restore the audio output to the previous volume level (see page 41).

⑭ TV INPUT

Switches the input source of the TV (see page 88).

⑮ DVD player/VCR control buttons

Use to control the DVD player of the VCR (see pages 88 and 89).

⑯ TV POWER

Turns on the power of the TV or sets it to the standby mode (see page 88).

⑰ AV POWER

Turns on the power of the selected component or sets it to the standby mode (see pages 88 and 89).

⑱ INPUT1/INPUT2

Selects the input source of the TV.

19 MACRO

Use to set the TV macro (see page 90).

20 INPUTMODE

Switches between input modes (AUTO, DTS or ANALOG). See page 39 for details.

21 SLEEP

Sets the sleep timer (see page 60).

22 Beam mode buttons

Change the beam mode settings (see page 42).

23 VOL MODE

Turns on or off the volume modes (see page 56).

24 SURROUND

Selects the surround mode for playback (see page 46).

25 MENU

Displays the setup menu on your TV monitor (see pages 31, 62 and 69).

Note

The DVD menu is displayed when DVD is selected as the input source.

26 RETURN

Use to select sleep timer settings or return to the previous SET MENU screen.

27 TV VOL +/-

Adjusts the volume level of the TV (see page 88).

28 CH +/-

Switches between channels of the TV or the VCR (see pages 88 and 89).

29 TV MUTE, CODE SET

Mutes the audio output of the TV (see page 88).

Use to set up remote control codes (see page 87).

INSTALLATION

This section describes a suitable installation location to install the unit using a metal wall bracket, a rack or a stand.

Before installing this unit

This unit creates surround sound by reflecting projected sound beams off the walls of your listening room. The surround sound effects produced by this unit may not be sufficient when the unit is installed in the following locations.

- Rooms with surfaces inadequate for reflecting sound beams
- Rooms with acoustically absorbent surfaces
- Rooms with measurements outside the following range W (3 to 7 m) x H (2 to 3.5 m) x D (3 to 7 m)
- Rooms with less than 2 m from the listening position to the speaker positions
- Rooms where objects such as furniture are likely to obstruct the path of sound beams
- Rooms where the listening position is close to the walls
- Rooms where the listening position is not in front of this unit

Make sure you leave an adequate amount of ventilation space so that heat can escape. Make at least 5 cm of space above or below this unit.

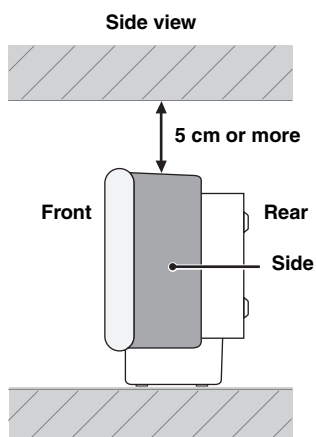

Notes

- This unit weighs 13.0 kg. Be sure to install this unit where it will not fall subject to vibrations, such as from an earthquake, and where it is out of the reach of children.
- When using a cathode-ray tube (CRT) TV, do not install this unit directly above your TV.
- This unit is shielded against magnetic rays. However, if the picture on your TV screen becomes blurred or distorted, we recommend moving the speakers away from your TV.

Installing this unit

Install this unit where there are no obstacles such as furniture obstructing the path of sound beams. Otherwise, the desired surround sound effects may not be achieved. You may install this unit in parallel with the wall or in the corner.

■ Parallel installation

Install this unit in the exact center of the wall when it is measured from the left and right corners.

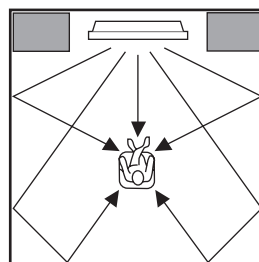

■ An object, such as furniture

■ Corner installation

Install this unit in the corner at a 40° to 50° angle from the adjacent walls.

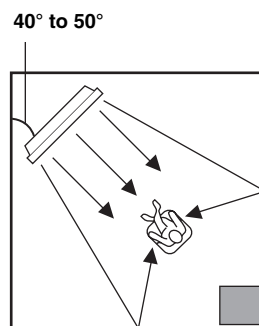

■ An object, such as furniture



The availability of the beam mode depends on the installation location of this unit (see page 42). All five beam modes are available for the parallel installation whereas the 3 beam and 5 beam modes are not available for the corner installation.

■ Installation examples

Example 1

Install this unit as close to the exact center of the wall as possible.

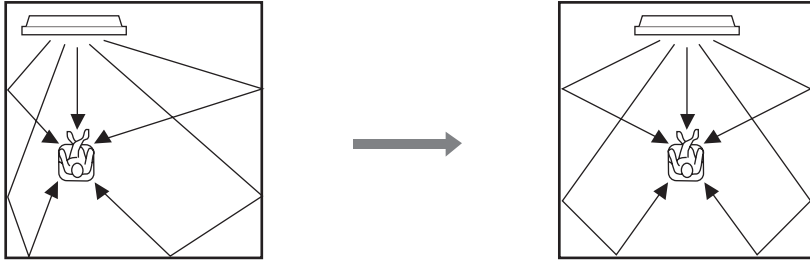

Example 2

Install this unit so that the sound beams can be reflected off the walls.

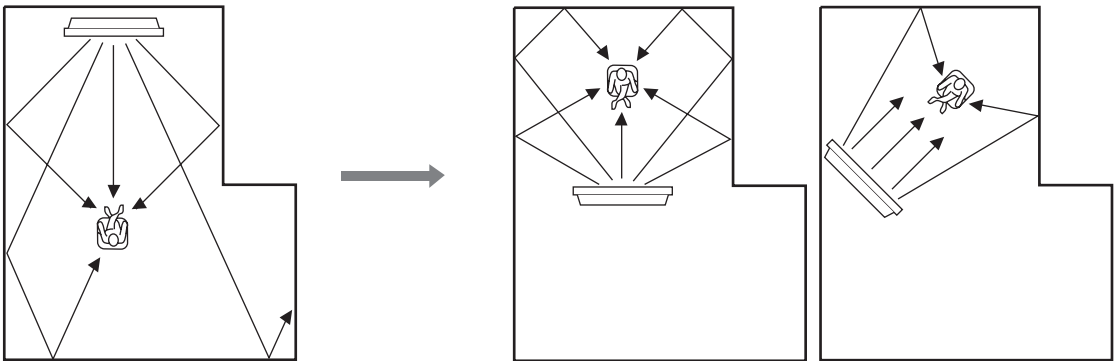

Example 3

Install this unit as close to the exact front of your normal listening position.

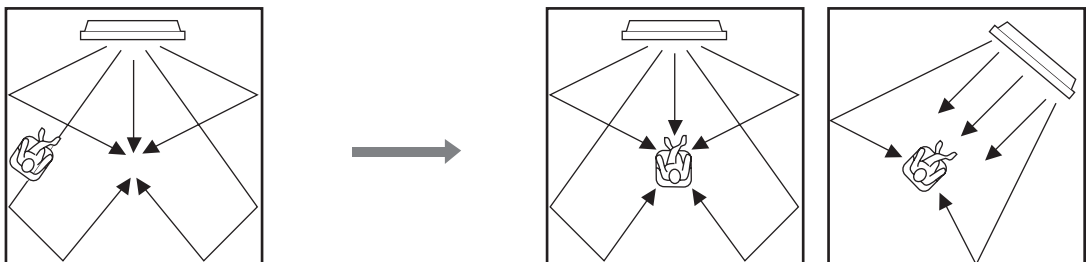

■ Using a metal wall bracket

You can use the optional metal wall bracket to mount this unit on the wall in your listening room.

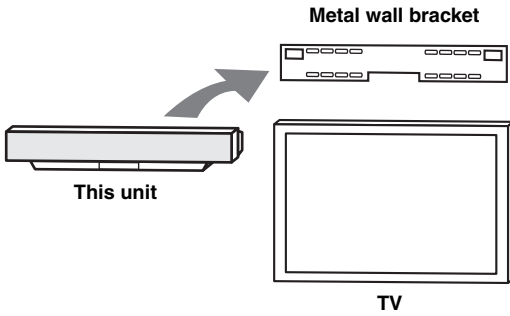

 Refer to the instructions supplied with the metal bracket for details on how to attach the metal bracket to the wall or how to attach this unit to the metal bracket.

■ Using a stand

You can mount your TV on the stand placed on a commercially available rack to install this unit under your TV.

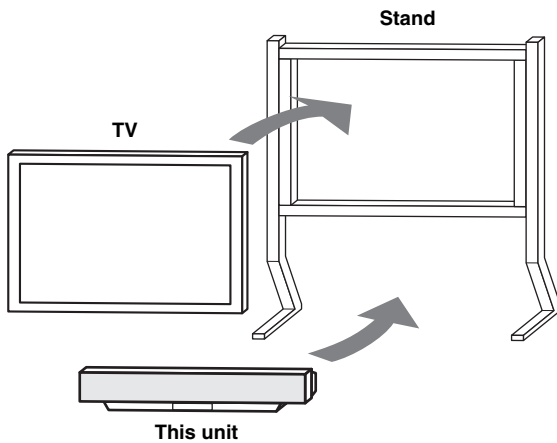

 Refer to the instructions supplied with the stand for details on how to install the stand or how to mount this unit and the TV on the stand.

■ Using a TV stand

You can use the optional TV stand to install this unit. For detailed information on installing this unit using a TV stand, refer to the installation manual supplied with the optional TV stand.

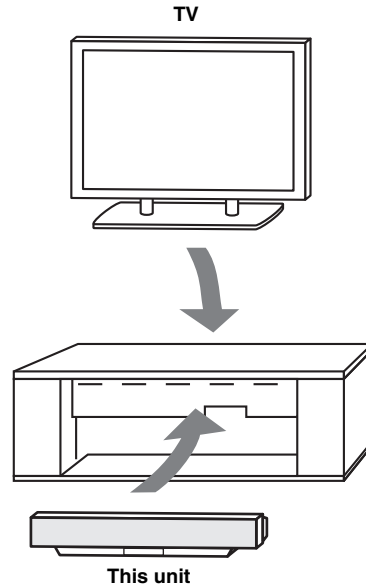

■ Using a rack

You can install this unit either above or under your TV in a commercially available rack.

When this unit is installed above your TV

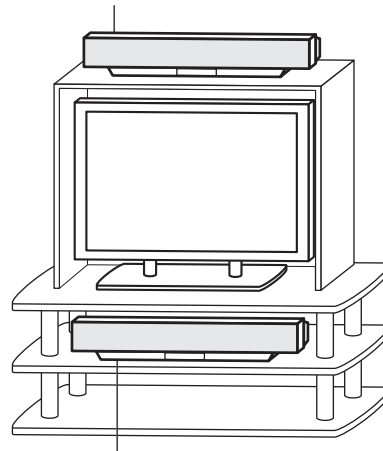

When this unit is installed under your TV

Note

Make sure that the rack is large enough to allow adequate ventilation space around this unit (see page 11) and that it is strong enough to support the weight of both this unit and your TV.

■ Affixing this unit

Peel off the film from each of the four supplied fasteners and then secure them to the bottom four corners of this unit and the top of the rack, etc.

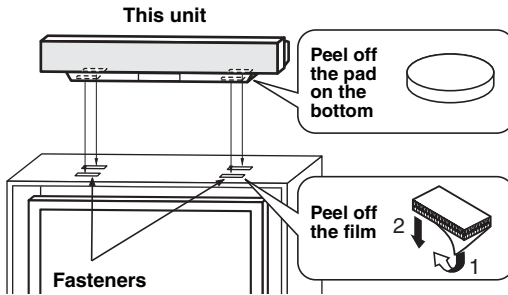
**Notes**

- Do not install this unit on top of a slanted surface. This unit may fall over and cause injury.
- Make sure you wipe the surface of the rack, etc. before securing the fasteners. Applying the tape to a dirty or wet surface will weaken the sticking power of the tape, and this unit may fall as a result.

CONNECTIONS

This unit is equipped with the following types of audio/video input/output jacks:

For audio input

- 2 optical digital input jacks
- 1 coaxial digital input jack
- 2 sets of analog input jacks

For video input

- 3 composite analog input jacks
- 2 sets of component analog input jacks

For video output

- 1 composite analog output jack
- 1 set of component analog output jacks

Use these audio/video input/output jacks to connect external components such as your TV, DVD player, VCR, digital satellite tuner, cable TV tuner and game console. Further, by connecting a subwoofer to this unit, you can enjoy reinforced low bass sounds. For details on how to connect various types of external components to this unit, see pages 16 to 22.

CAUTION

Do not connect this unit or other components to the main power until all connections between components are complete.

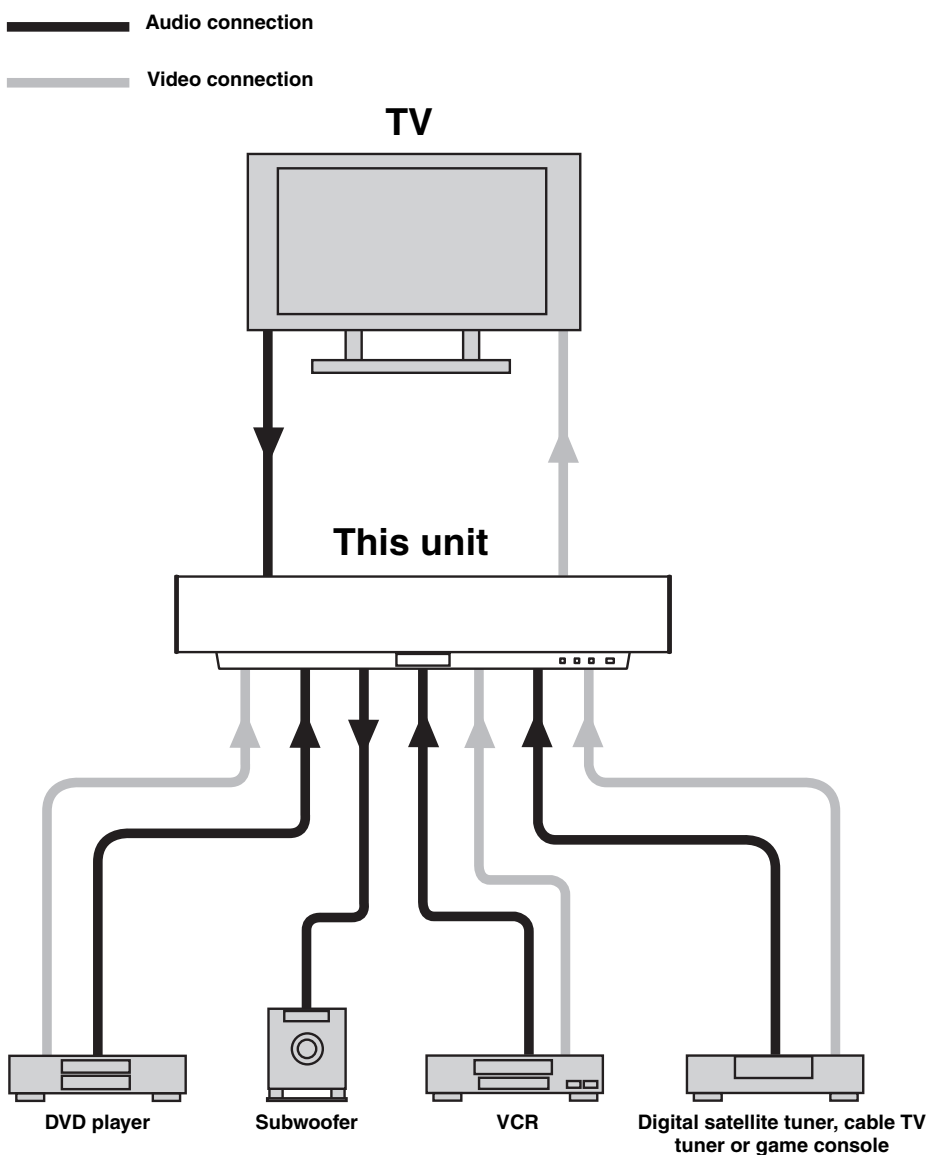

Connecting a TV

Connect a TV to this unit and display the OSD for easy viewing when you adjust the system parameters in SET MENU.

■ Audio connections

Connect the analog audio output jacks of your TV to the TV/STB AUDIO IN jacks of this unit. If your TV has an optical digital output jack, connect the optical digital output jack of your TV to the TV/STB OPTICAL DIGITAL IN jack of this unit in addition to the analog audio connection. Once the digital audio connection is made, digital audio signals can be input to this unit during digital broadcasting.



- The circuits of composite and component video signals are independent of each other.
- To prevent the optical cable from being unplugged, affix the optical cable in the supplied cable clamp (see page 23).

Note

If you connect this unit to the analog audio and optical digital audio output jacks at the same time as shown in the left illustration below, the digital audio signals output at the optical digital output jack take priority over the analog audio signals output at the analog audio output jacks.

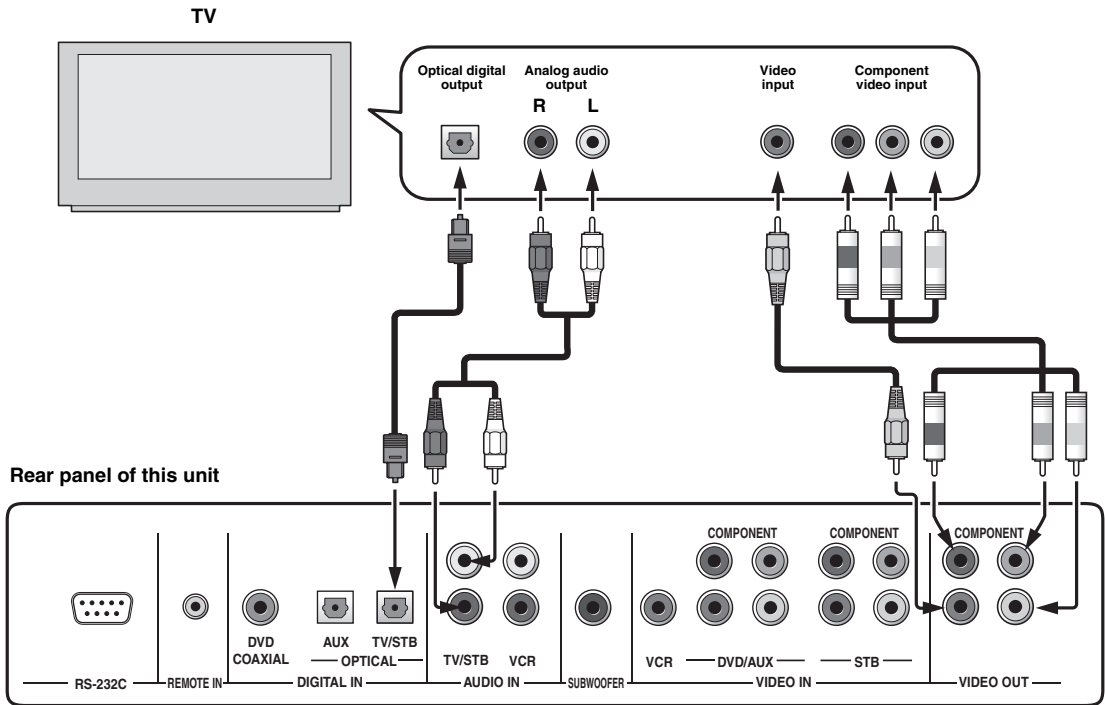

Cables used for audio connections

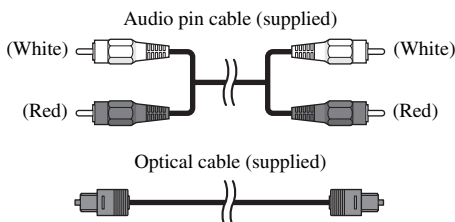

Cables used for video connections

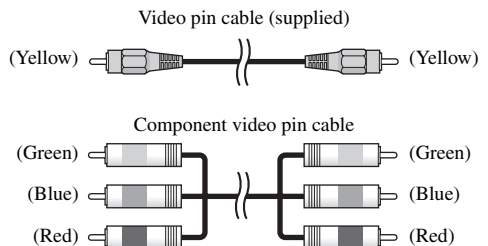

Connecting a DVD player/recorder

Connect a DVD player/recorder and enjoy DVDs.

■ Audio connections

Connect the optical digital output jack of your DVD player/recorder to the DVD COAXIAL DIGITAL IN jack of this unit. In case you connect this unit to a DVD/VCR combo player/recorder, connect the analog audio output jacks of your DVD/VCR combo player/recorder to the VCR AUDIO IN jacks of this unit in addition to the optical digital audio connection.



To prevent the optical cable from being unplugged, affix the optical cable in the supplied cable clamp (see page 23).

Notes

- Check that your DVD player/recorder is properly set to output Dolby Digital and DTS digital audio signals. If not, adjust the system settings of your DVD player/recorder. For details, refer to the operation manual supplied with your DVD player/recorder.
- If your DVD player/recorder does not have a coaxial digital output jack, make an optical digital audio connection instead (see page 21).

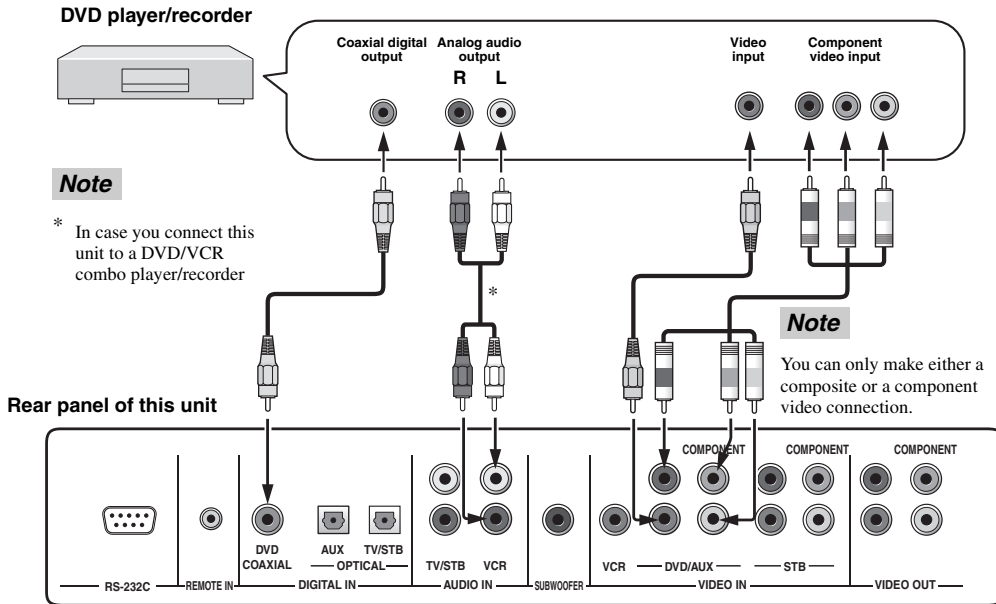

Cables used for audio connections

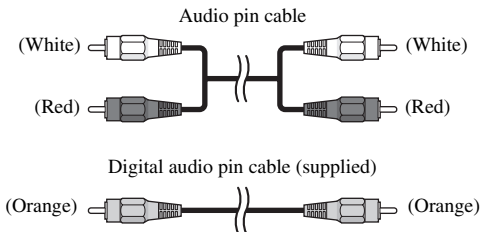

Cables used for video connections

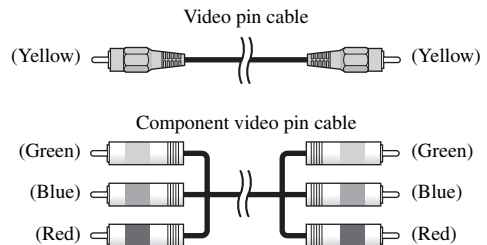

Connecting a VCR

Connect a VCR and enjoy video cassette tapes.

■ Audio connections

Connect the analog audio output jacks of your VCR to the VCR AUDIO IN jacks of this unit.

■ Video connections

Connect the video output jack of your VCR to the VCR VIDEO IN jack of this unit.

Note

Be sure to match the left and right output jacks of your VCR with the left and right input jacks of this unit.

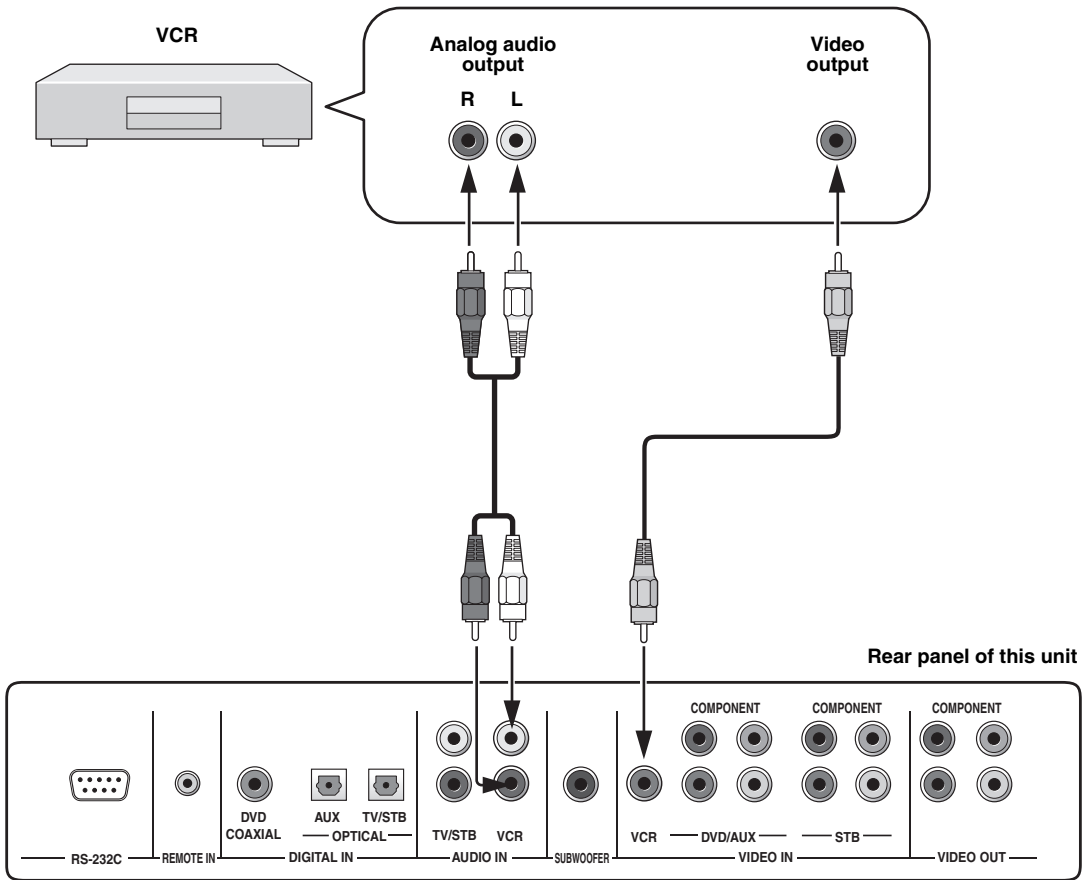

Cables used for audio connections

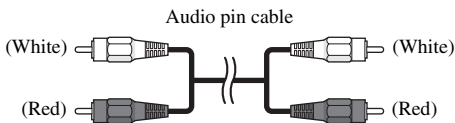

Cables used for video connections

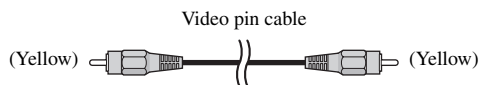

Connecting a digital satellite tuner or a cable TV tuner

Connect a digital satellite tuner or a cable TV tuner and enjoy digital satellite broadcasting or cable TV broadcasting.

Audio connections

Connect the optical digital output jack of your digital satellite tuner or cable TV tuner to the TV/STB OPTICAL DIGITAL IN jack of this unit. Connect the analog audio output jacks of your digital satellite tuner or cable TV tuner to the TV/STB AUDIO IN jacks of this unit in addition to the optical digital audio connection.

Video connections

Connect the video output jack of your digital satellite tuner or cable TV tuner to the STB VIDEO IN jack of this unit. If your digital satellite tuner or cable TV tuner has component video output jacks, connect the component video output jacks of your digital satellite tuner or cable TV tuner to the STB COMPONENT VIDEO IN jacks of this unit. Once the component video connection is made, you can enjoy images with better resolution.

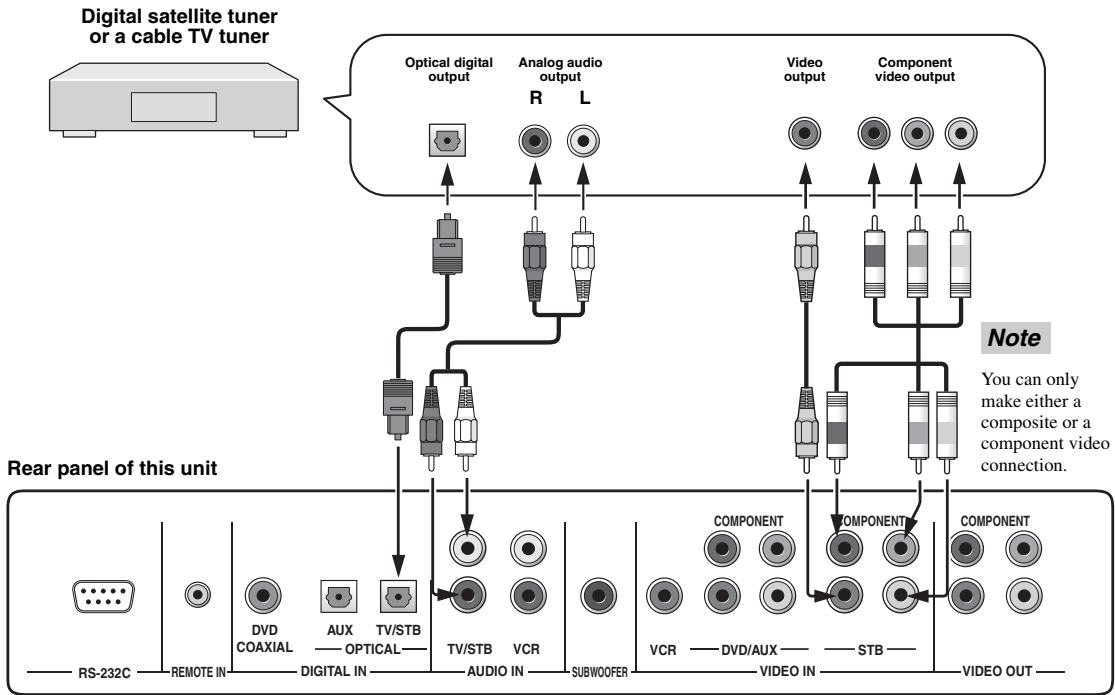

Cables used for audio connections

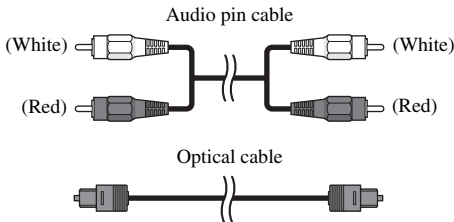

Cables used for video connections

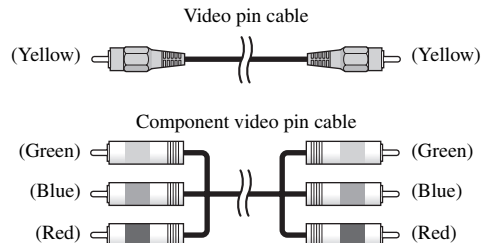

Connecting a digital airwave tuner

If your digital airwave tuner does not support analog broadcasting, make audio/video connections as shown below.

■ Audio connections

Connect the optical digital output jack of your digital airwave tuner to the TV/STB OPTICAL DIGITAL IN jack of this unit. Connect the TV/STB AUDIO IN jacks of this unit to the analog audio output jacks of your TV in addition to the optical digital audio connection between your digital airwave tuner and this unit.

■ Video connections

Connect the video output jack of your digital airwave tuner to the STB VIDEO IN jack of this unit. If your digital airwave tuner has component video output jacks, connect the component video output jacks of your digital airwave tuner to the STB COMPONENT VIDEO IN jacks of this unit. Once the component video connection is made, you can enjoy images with better resolution.

Note

If you want this unit to output audio signals of analog broadcasting, turn off the power of your digital airwave tuner.

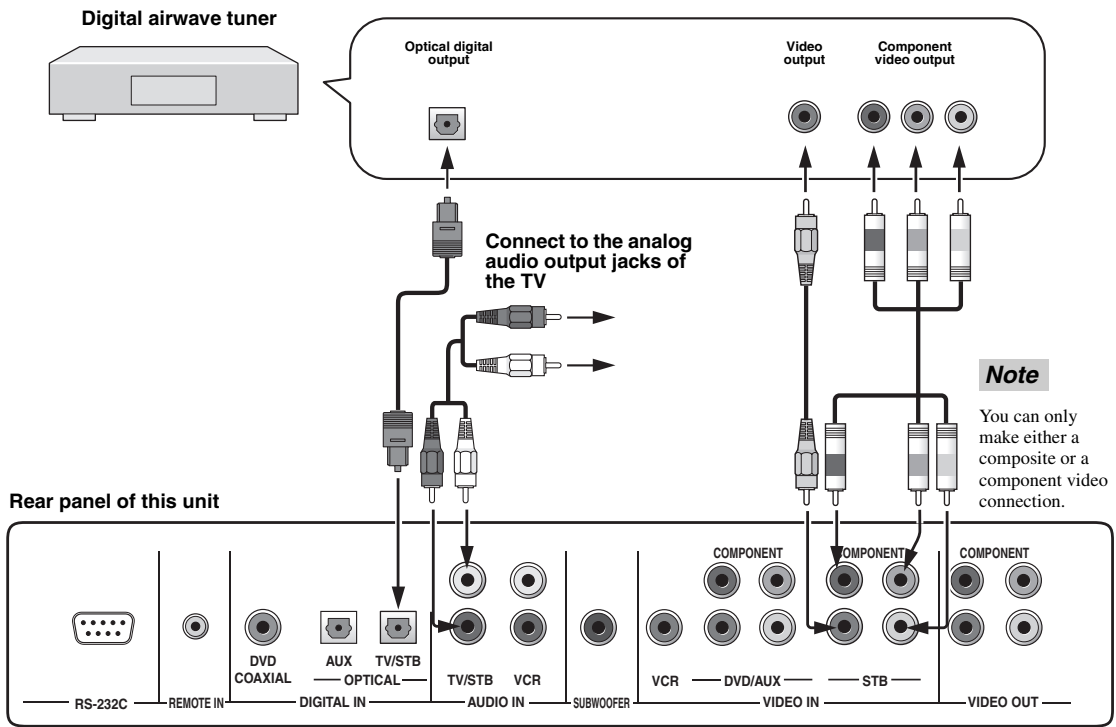

Cables used for audio connections

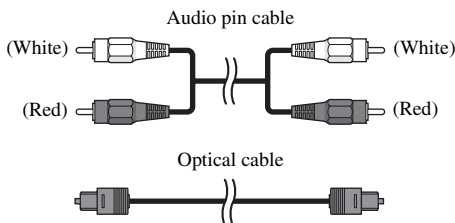

Cables used for video connections

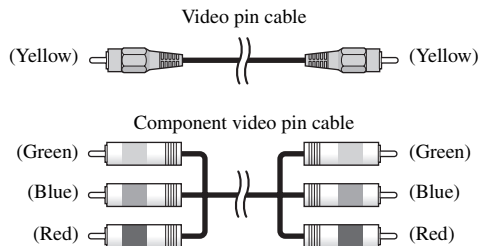

Connecting other external components

To connect other external components, connect the optical digital output jack of an external component to the AUX OPTICAL DIGITAL IN jack of this unit. Use this connection method to connect an external component that supports an optical digital connection or to connect a DVD player/recorder via an optical digital connection.

Note

If you connect a DVD player/recorder via a coaxial digital connection, adjust settings for INPUT ASSIGNMENT (see page 77).

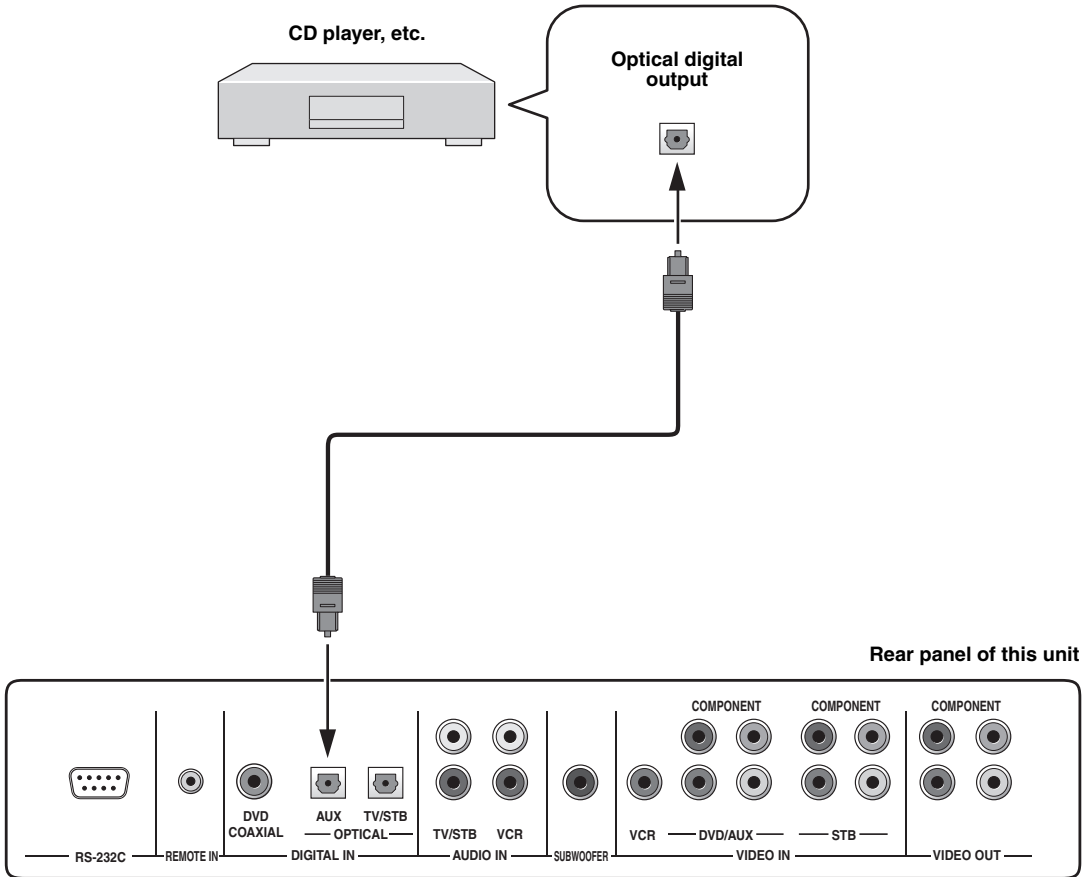

Cables used for connections

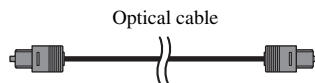

Connecting a subwoofer

To connect a subwoofer, connect the monaural input jack of your subwoofer to the SUBWOOFER jack of this unit. If a subwoofer is connected to this unit, turn on the power of your subwoofer and then run AUTO SETUP (see page 28) or select SWFR for BASS OUT in SUBWOOFER SET (see page 75).

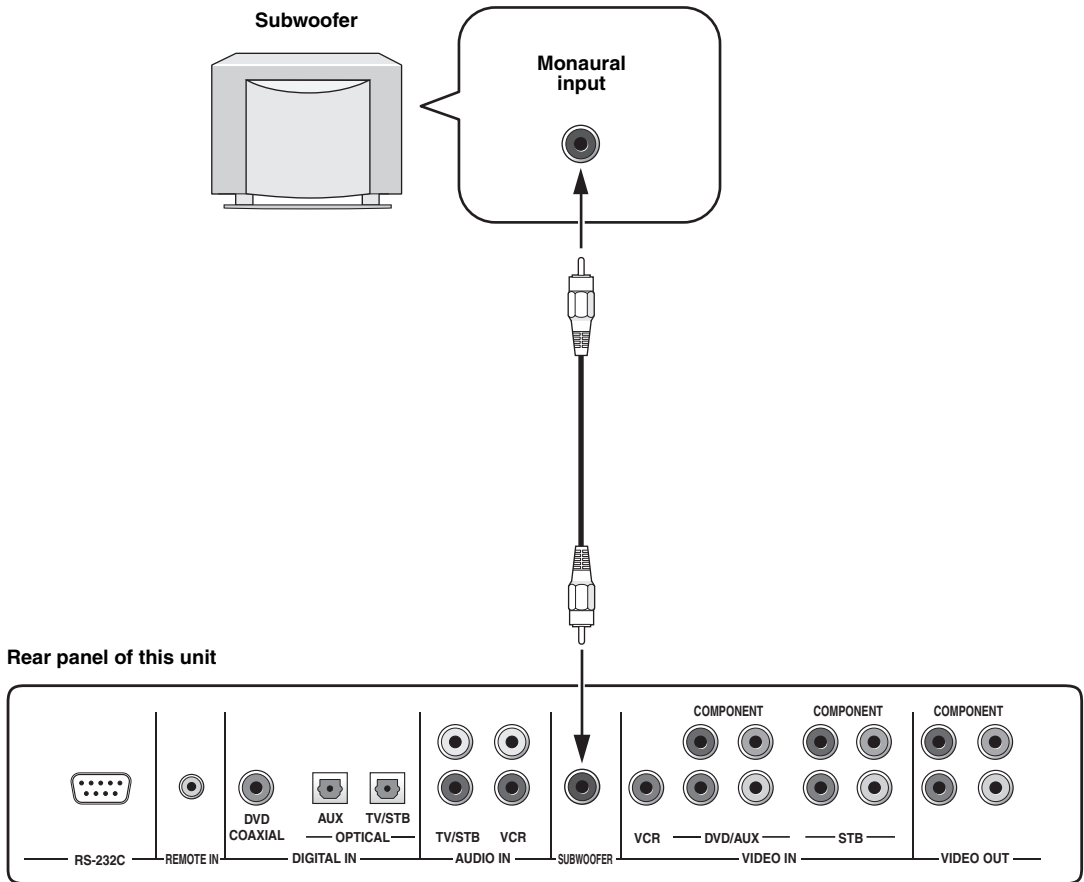

Cables used for connections

Subwoofer pin cable



Affixing the optical cable

To prevent the optical cable from being unplugged, place the supplied cable clamp with the open side facing upward, attach it to the rear panel of this unit in a suitable position and then affix the optical cable in the cable clamp.

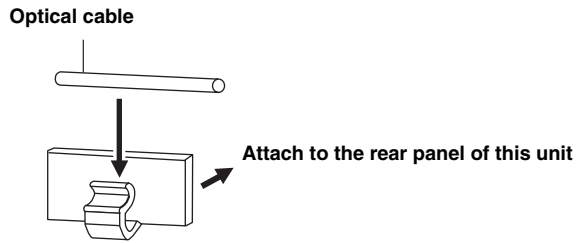

Connecting the power supply cable

Once all other connections are complete, plug one end of the power supply cable into the AC IN terminal of this unit and then plug the other end into the AC wall outlet.

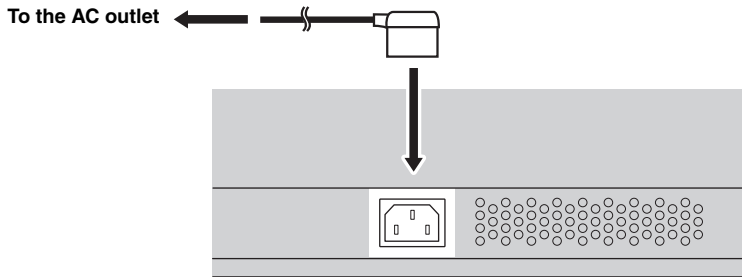

About the RS-232C/REMOTE IN/IR-OUT terminals

The RS-232C, REMOTE IN and IR-OUT terminals do not support normal external component connections. These are control expansion terminals for factory use only.

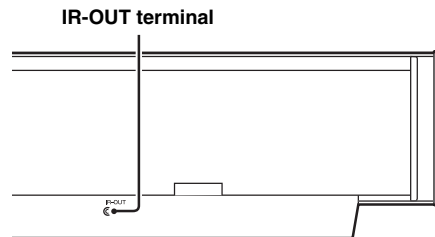
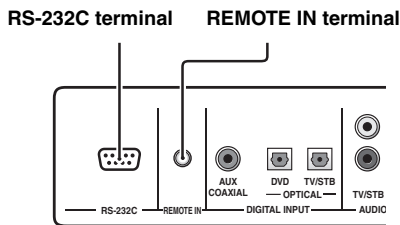

GETTING STARTED

Installing batteries in the remote control

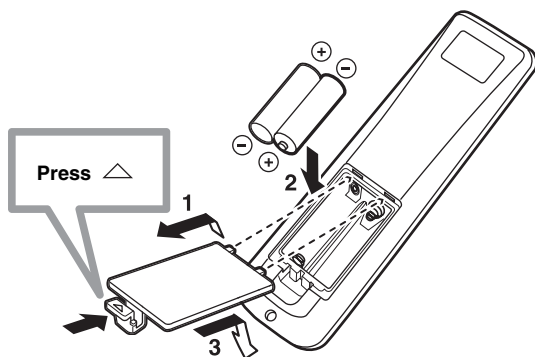

1 Press and hold the \triangle mark on the battery cover and then slide off the cover.

2 Insert the two supplied batteries (AA, R6, UM-3) into the battery compartment.

Make sure you insert the batteries according to the polarity markings (+/-).

3 Close the battery cover.

Notes

- Change all of the batteries if you notice the following conditions; the operation range of the remote control decreases, the indicator does not blink or its light becomes dim.
- Do not use old batteries together with new ones.
- Do not use different types of batteries (such as alkaline and manganese batteries) together. Read the packaging carefully as these different types of batteries may have the same shape and color.
- Exhausted batteries may leak. If the batteries have leaked, dispose of them immediately. Avoid touching the leaked material or letting it come into contact with clothing, etc. Clean the battery compartment thoroughly before installing new batteries.
- Do not throw away batteries with general house waste. Dispose of them correctly in accordance with your local regulations.
- The contents of the memory stored in the remote control may be erased in the following cases:
 - The remote control is left without batteries for more than 2 minutes.
 - Exhausted batteries remain in the remote control.
 - The buttons on the remote control are accidentally pressed when you change batteries.
- If the memory stored in the remote control is unwantedly erased, insert new batteries and reset the remote control codes again.

Operation range of the remote control

The remote control transmits a directional infrared beam. Use the remote control within 6 m of this unit and point it toward the remote control sensor on this unit during operation.

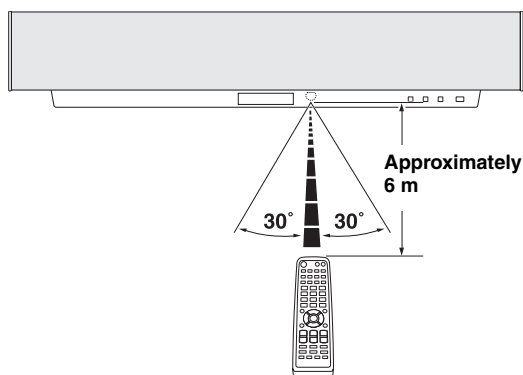

Notes

- Do not spill water or other liquids on the remote control.
- Do not drop the remote control.
- Do not leave or store the remote control in the following types of conditions:
 - places of high humidity, such as near a bath
 - places of high temperatures, such as near a heater or a stove
 - places of extremely low temperatures
 - dusty places
- Do not expose the remote control sensor on this unit to direct sunlight or lighting such as inverted fluorescent lamps.
- If the batteries grow old, the effective operation distance of the remote control decreases considerably. If this happens, replace the batteries with two new ones as soon as possible.

Using the remote control

The control area and the corresponding functions of the remote control change depending on the currently selected input source. Press the input selector buttons (TV, STB, VCR, DVD or AUX) to select an input source and switch to the operation mode of the corresponding input source. Press YSP to switch to the operation mode of this unit. The buttons on the remote control numbered ③ to ⑨ are operational only after you press YSP to switch to the operation mode of this unit.



You can control other components by setting the appropriate remote control codes (see page 87). Once the remote control code for each input source (TV, STB, VCR, DVD or AUX) is set, see “Controlling other components” on page 88 for further information on the specific functions of the available remote control buttons for each input source. Note that the buttons on the remote control numbered ③ to ⑨ have different functions depending on the currently selected input source.

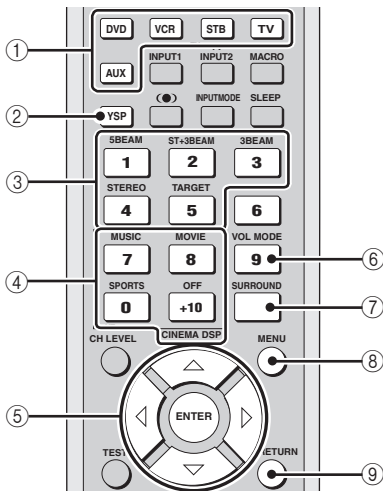

- 1 Input selector buttons
- 2 YSP
- 3 Beam mode buttons
- 4 Sound field program buttons
- 5 Cursor buttons $\triangle / \nabla / \triangleleft / \triangleright$, ENTER
- 6 VOL MODE
- 7 SURROUND
- 8 MENU
- 9 RETURN

Turning on the power

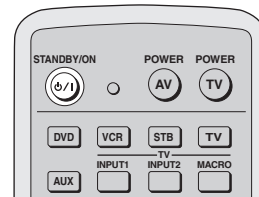
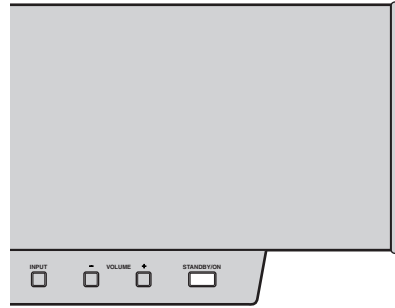

- 1 Press STANDBY/ON on the front panel or on the remote control to turn on the power of this unit.



Front panel

or



Remote control

- 2 Press STANDBY/ON on the front panel or on the remote control again to set this unit to the standby mode.

Note

When the unit is in the standby mode, only STANDBY/ON on the front panel or on the remote control is operational, and the other control buttons on the front panel or on the remote control are not operational until the power of this unit is turned on.

USING SET MENU

Displaying the OSD

This section simply describes how to display the OSD (on-screen display) of this unit on your TV screen and set the parameters for your listening room. Once this is complete, you can enjoy real surround sound while watching TV in the comfort of your own home.

Note

The OSD is not output at the COMPONENT VIDEO OUT jacks of this unit. Connect the VIDEO OUT jack of this unit to the video input jacks of your TV to display the OSD.

- 1 Check that the video input jack on your TV is connected to the VIDEO OUT jacks of this unit to display the OSD of this unit.
- 2 Press STANDBY/ON on the front panel or on the remote control to turn on the power of this unit.



Front panel

or



Remote control

- 3 Turn on the power of your TV.
- 4 Press TV on the remote control to display the OSD of this unit on your TV screen.

It may take a few seconds before this unit's OSD appears on your TV screen.

If the OSD does not appear, use the remote control provided with your TV to switch the video input until the OSD appears.

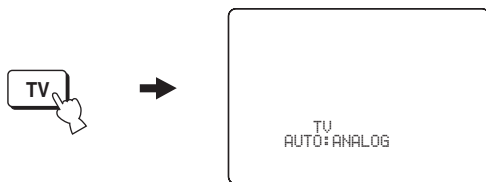

OSD screen example

Other buttons that display the OSD

Remote control buttons that display the OSD	Page
① Input selector buttons	39
② ● TruBass	58
③ Beam mode buttons	42
④ Sound field program buttons	51
⑤ CH LEVEL	84
⑥ VOLUME +/-	40
⑦ MUTE	41
⑧ INPUTMODE	86
⑨ SLEEP	60
⑩ VOL MODE	56
⑪ SURROUND	46
⑫ MENU	31, 62, 69

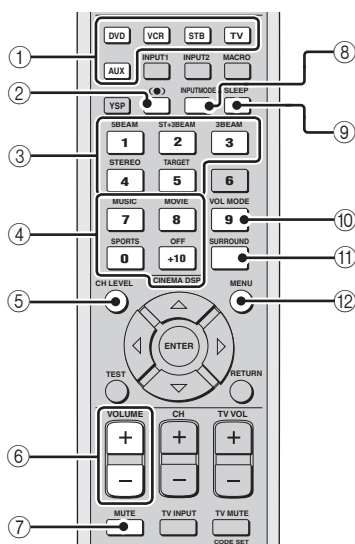

The flow chart of SET MENU

The following diagram illustrates the overall flow of the setup procedure.

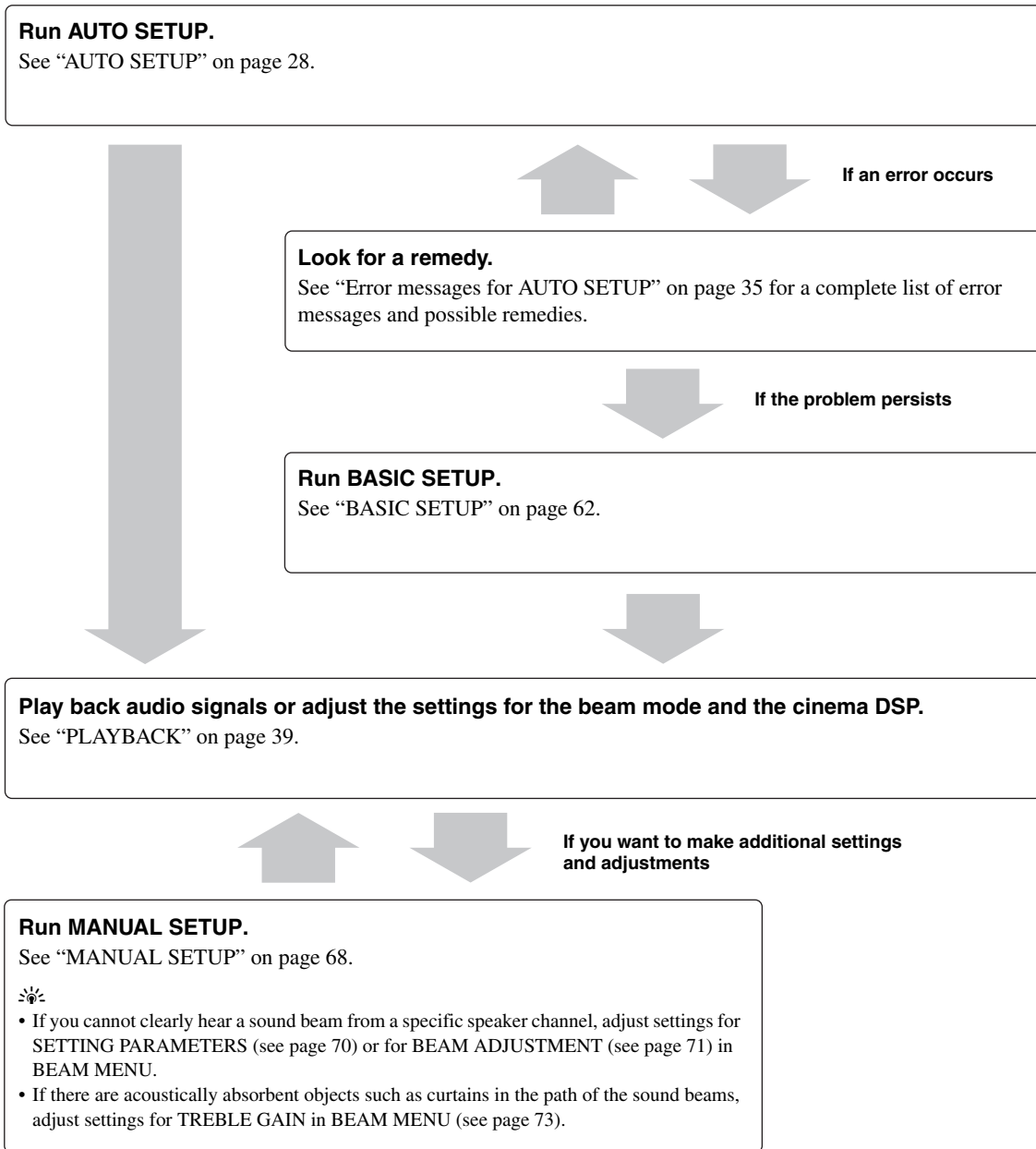

AUTO SETUP

This unit creates a sound field by reflecting sound beams on the walls of your listening room and broadening the cohesion between speaker channels. Just as you would arrange the speaker position of other audio systems, you need to set the beam angle to enjoy the best possible sound from this unit.

This unit employs the beam optimization feature and the YAMAHA Parametric Room Acoustic Optimizer (YPAO) technology with the aid of the supplied optimizer microphone, allowing you to avoid troublesome listening-based speaker setup and achieving highly accurate sound adjustments that best match your listening environment.

The beam optimization is the automated feature of BASIC SETUP, which creates the best possible surround sound field without manually setting the parameters for your listening room.

The YAMAHA Parametric Room Acoustic Optimizer (YPAO) technology performs the following checks and automatically makes appropriate sound adjustments.

DISTANCE:

Checks the phase and the distance of each beam from this unit and adjusts the delay of each channel so that each sound beam reaches the listening position at the same time.

EQUALIZING:

Adjusts frequency and levels of each channel's parametric equalizer to reduce coloration across the channels and create a cohesive sound field. YPAO equalizing calibration incorporates three parameters (frequency, level and Q factor) for each of the seven bands in its parametric equalizer to provide highly precise automatic adjustment of frequency characteristics.

LEVEL:

Checks and adjusts the sound output level of each channel.

The flow chart of AUTO SETUP

This unit performs a series of checks to optimize the beam angle, delay, volume and quality. You can choose to optimize all or part of the parameters.

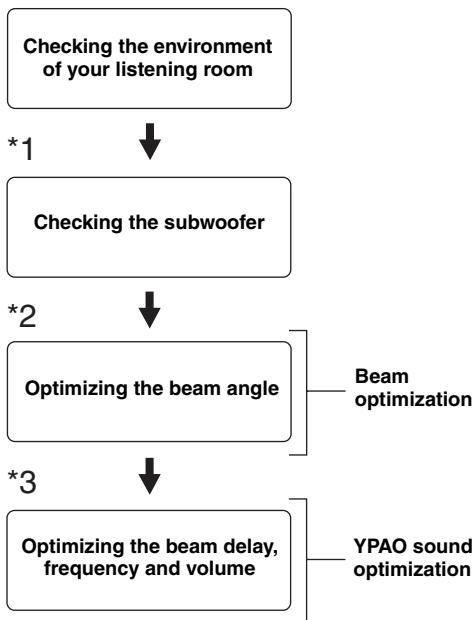

Notes

- *1 The subwoofer checking procedure is skipped if BEAM OPTIMZ only is selected.
- *2 The beam angle checking procedure is skipped if SOUND OPTIMZ only is selected.
- *3 The YPAO sound optimization procedure is skipped if BEAM OPTIMZ only is selected.

Installing the optimizer microphone

The supplied optimizer microphone collects and analyzes the sound that this unit produces in your actual listening environment. Follow the procedure below to connect the optimizer microphone to this unit and make sure that the optimizer microphone is placed in a proper location and that there are no large obstacles between the optimizer microphone and the walls in your listening room.

Notes

- After you have completed the AUTO SETUP procedure, be sure to disconnect the optimizer microphone.
- The optimizer microphone is sensitive to heat.
 - Keep it away from direct sunlight.
 - Do not place it on top of this unit.
- Do not connect the optimizer microphone to an extension cable as doing so may result in an inaccurate sound optimization.
- An error may occur during the AUTO SETUP procedure if the optimizer microphone is not properly placed in your listening room. To avoid the possibility of an error:
 - Do not place the optimizer microphone to the extreme right or left from the center of this unit.
 - Do not place the optimizer microphone within 2 m from the front of this unit.
 - Do not place the optimizer microphone more than 1 m from the center height of this unit.
- Make sure that there are no obstacles between the optimizer microphone and the walls in your listening room as these objects obstruct the path of sound beams. However, any objects that are in contact with the walls will be regarded as a protruding part of the walls.
- The best possible results are achieved if the optimizer microphone is placed at the same height as your ears would be when you are seated in your listening position. However, if this is not possible, you can manually fine-tune the sound beam angle and balance the sound beam output levels using MANUAL SETUP (see page 68) once the AUTO SETUP procedure is completed.
- If a subwoofer with adjustable volume and crossover/high cut frequency controls is connected to this unit, set the volume between 11 and 1 o'clock as viewed on a conventional clockface and set the crossover/high cut frequency to the maximum.

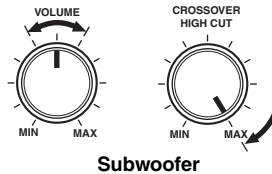

- 1 Press **STANDBY/ON** on the front panel or the remote control to turn off the power of this unit.



Front panel

or



Remote control

- 2 Connect the supplied optimizer microphone to the **OPTIMIZER MIC** jack on the side of this unit.

Side view

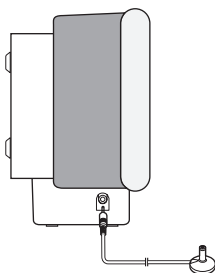

Optimizer microphone

- 3 Place the optimizer microphone on a flat level surface more than 2 m from the front of the unit and within 1 m from the center height of the unit with the optimizer microphone head upward at your normal listening position.

Note

Be sure to place the optimizer microphone on an imaginary center line drawn from this unit.



You may want to use a tripod or the supplied cardboard microphone stand to affix the optimizer microphone at the same height as your ears would be when you are seated in your listening position.

Example of using a tripod

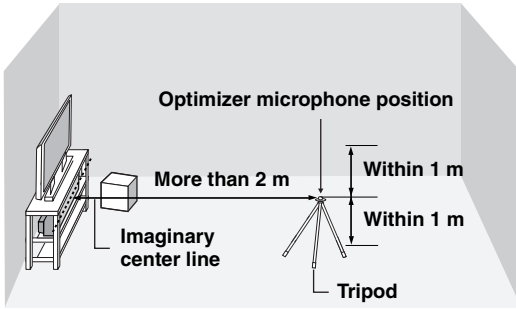

Example of using the supplied cardboard microphone stand

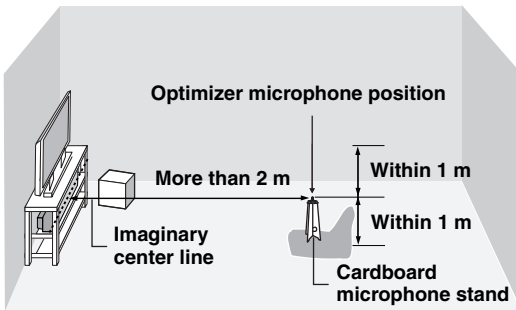

■ Assembling the supplied cardboard microphone stand

You will find three separate parts (one circular-shaped part and two longitudinal-shaped parts) of the cardboard microphone stand originally put together.

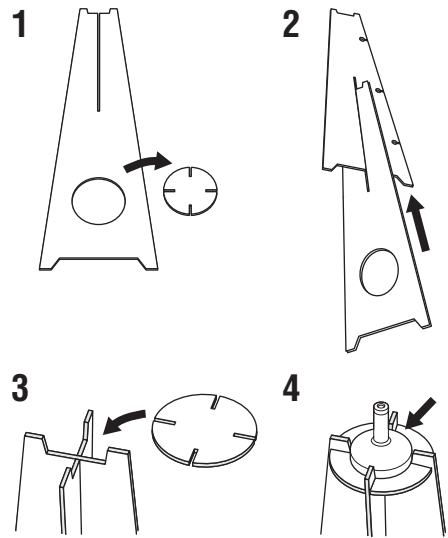

- 1** Disassemble the three parts of the cardboard microphone stand originally put together.

- 2** Insert one of the longitudinal-shaped part into the crevice of the other longitudinal-shaped part.

- 3** Place the circular-shaped part on top of the two combined longitudinal-shaped parts.

- 4** Place the supplied optimizer microphone on top of the circular-shaped part.

Using AUTO SETUP

Once the optimizer microphone is firmly connected to this unit and properly placed in your listening room, follow the procedure below to start the AUTO SETUP procedure.

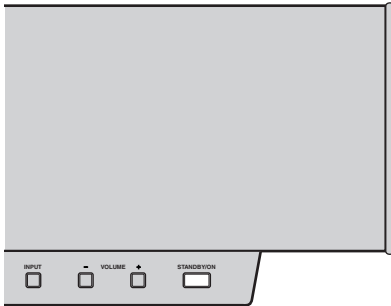

Notes

- If your listening room has curtains, open the curtains before starting the BEAM OPT+SOUND OPTIMZ or the BEAM OPTIMZ only procedure.
- Make sure that your listening room is as quiet as possible while this unit is performing the AUTO SETUP procedure.
- Once the AUTO SETUP procedure has started, position yourself beside or behind this unit so that you may not obstruct the path of sound beams. To achieve the best results possible, however, it is strongly recommended that you should evacuate yourself from your listening room until the AUTO SETUP procedure is completed.
- Be advised that it is normal for loud test tones to be output during the AUTO SETUP procedure.
- The AUTO SETUP procedure may not be run successfully if this unit is installed in one of the rooms described in “Before installing this unit” on page 11. In such cases, run BASIC SETUP (see page 62) or MANUAL SETUP (see page 68) to manually adjust the corresponding parameters.
- If the AUTO SETUP procedure stops and an error message appears on the screen, see “Error messages for AUTO SETUP” on page 35 for appropriate remedies.



You can save the settings optimized by the AUTO SETUP procedure (see page 36). A set of settings optimized according to specific conditions of your listening environment can be recalled later depending on the varying conditions of your listening environment (see page 37).

SETUP

1 Press STANDBY/ON on the front panel or on the remote control to turn on the power of this unit.

STANDBY/ON



Front panel

or



Remote control

2 Press YSP on the remote control to switch to the operation mode of this unit.



English

3 Press MENU on the remote control.

The SET MENU screen appears on your TV.

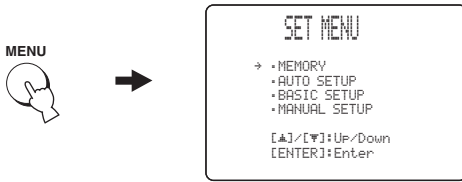

- The control buttons used for SET MENU are displayed on the bottom of the screen.
- To return to the previous screen while using SET MENU, press RETURN on the remote control.
- To resume cursor button operations after changing the control area by pressing an input selector button, press TEST on the remote control.
- To cancel the SET MENU screen, press MENU once more.
- You can also perform the following operations in the front panel display.
- If you press an input selector button during the SET MENU operations, the cursor buttons become ineffective. In this case, press TEST once.

4 Press ▲ / ▼ on the remote control to select AUTO SETUP and then press ENTER.

The following screen appears on your TV.

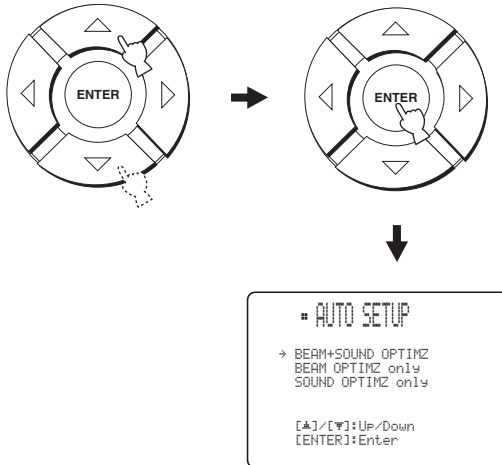

5 Press ▲ / ▼ to select BEAM OPT+ SOUND OPTIMZ, BEAM OPTIMZ only or SOUND OPTIMZ only and then press ENTER.

The following screen appears on your TV.

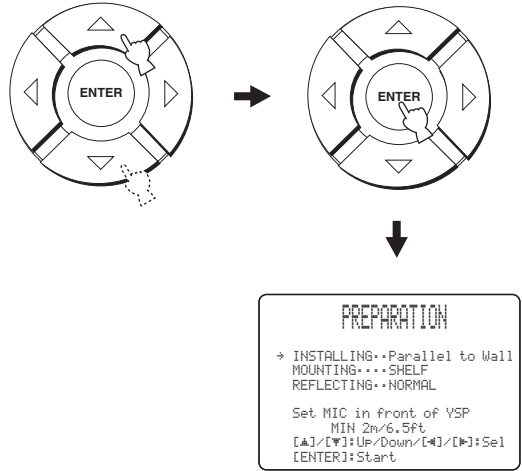

BEAM OPT+SOUND OPTIMZ (Beam optimization and YPAO sound optimization)

Use to optimize the beam angle, delay, volume and quality so that the parameters best match your listening environment. It takes about three minutes.

It is recommended that you should select this optimization feature in the following cases:

- If you make settings for the first time.
- If the unit has been relocated.
- If your listening room has been restructured.
- If the objects in your listening room (furniture, etc.) have been rearranged.

BEAM OPTIMZ only (Beam optimization only)

Use to optimize the beam angle so that the parameter best matches your listening environment. It takes about a minute.

SOUND OPTIMZ only (YPAO sound optimization only)

Use to optimize the beam delay, volume and quality so that the parameters best match your listening environment. It takes about two minutes.

It is recommended that you should select this optimization feature in the following cases:

- If you have opened or closed the curtains in your listening room before using this unit.
- If you have manually set the beam angle.

Note

You must optimize the beam angle in the BEAM OPTIMZ only procedure before starting the SOUND OPTIMZ only procedure.

6 Press $\triangle / \nabla / \leftarrow / \rightarrow$ to select and configure each parameter and then press ENTER.

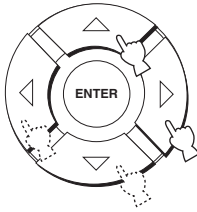

INSTALLING (Installing)

Use to select the installed position of the unit in your listening room.

Choices: **Parallel to Wall** (Parallel with wall installation),
Angle to Wall or corner (Corner installation)

Angle to Wall or corner

Parallel to Wall

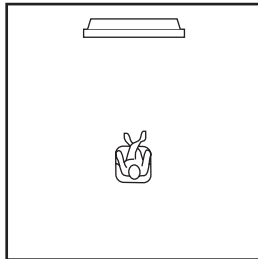
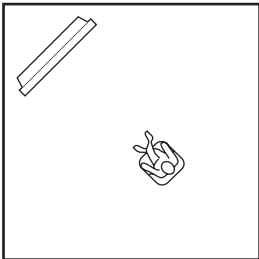

- Select Angle to Wall or corner if the unit is installed in the corner. The beam mode is set to ST+3BEAM (see page 43).
- Select Parallel to Wall if the unit is installed in parallel with the wall. The beam mode is set to 5BEAM (see page 43).

MOUNTING (Mounting)

Use to select the mounted position of the unit in your listening room.

Choices: **SHELF** (Shelf mount), **WALL** (Wall mount)

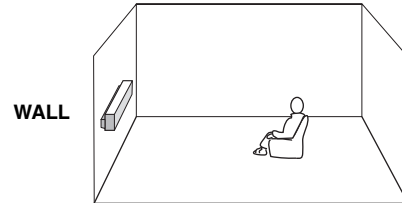
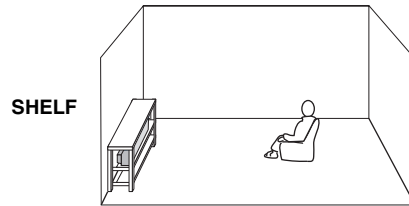

- Select WALL if the unit is mounted on the wall.
- Select SHELF if the unit is mounted on the shelf.

REFLECTING (Reflecting)

Use to select the reflectivity of your listening room.

Choices: **NORMAL** (Normal), **HI ECHO** (High echo)

- Select NORMAL if your listening room has a normal reflectivity.
- Select HI ECHO if your listening room has highly reflective surfaces such as concrete walls.

7 Check the following points once again before starting the AUTO SETUP procedure.

- Is the optimizer microphone firmly connected to this unit?
- Is the optimizer microphone placed in a proper location?
- Are there any large obstacles in between the optimizer microphone and the walls in your listening room?

8 Press ENTER to start the AUTO SETUP procedure.

The following screen appears on your TV. ENVIRONMENT CHECK (Environmental noise check), SUB WOOFER CHECK (Subwoofer check) and WILL START in 10 SEC (Will start in 10 sec) are displayed in order as the PREPARATION procedure is in progress.

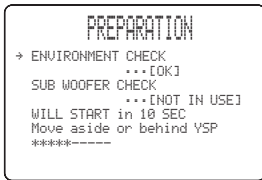
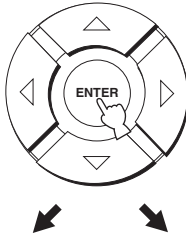

If you selected BEAM OPT+SOUND OPTIMZ or SOUND OPTIMZ only in step 5.

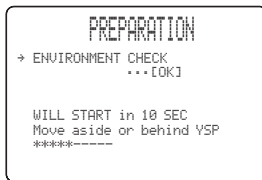

If you selected BEAM OPTIMZ only in step 5.

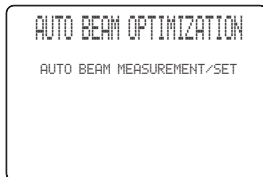

Skipped if you selected SOUND OPTIMZ only in step 5.

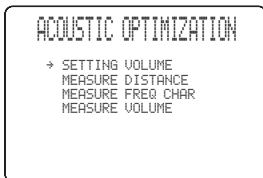

Skipped if you selected BEAM OPTIMZ only in step 5.

If an error occurs, an error message is displayed. See “Error messages for AUTO SETUP” on page 35 for a complete list of error messages and their proper remedies. Follow the instructions and press RETURN to perform the AUTO SETUP procedure again.

9 Check that the following screen is displayed on your TV.

The results of the AUTO SETUP procedure are displayed on your TV.

Example of the SHOW RESULT screen

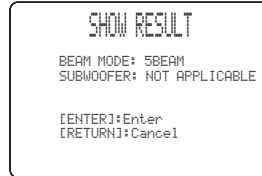

If you selected BEAM OPT+SOUND OPTIMZ or SOUND OPTIMZ only in step 5.

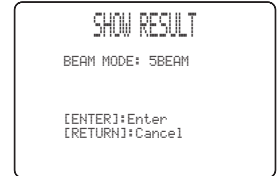

If you selected BEAM OPTIMZ only in step 5.

10 Press ENTER to confirm the results or press RETURN to cancel the results.

The following screen is displayed temporarily for a few seconds and then disappear from your TV.

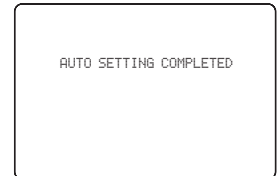
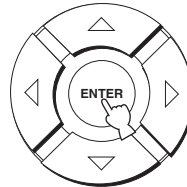

■ Error messages for AUTO SETUP

Before the AUTO SETUP procedure starts

Error message	Cause	Remedy	See page
ERROR E-2 No MIC Detected. Please check MIC connection and re-try.	The optimizer microphone is not connected to this unit.	Connect the optimizer microphone to this unit.	29

While the AUTO SETUP procedure is in progress-

Error message	Cause	Remedy	See page
ERROR E-1 Please test in more quiet environment.	There is too much unwanted noise in your listening room.	Make sure that your listening room is as quiet as possible. You may want to choose certain hours during the day when there is not much noise coming from outside.	—
ERROR E-2 No MIC detected. Please check MIC connection and re-try.	The optimizer microphone was disconnected while the AUTO SETUP procedure was in progress.	Make sure that the optimizer microphone is firmly connected to this unit.	29
ERROR E-3 Unexpected control is detected. Please re-try.	Some other operations were performed on this unit while the AUTO SETUP procedure was in progress.	Do not perform any other operations while the AUTO SETUP procedure is in progress.	—
ERROR E-4 Please check MIC position. MIC should be set in front of YSP.	The optimizer microphone is not placed in front of this unit.	Make sure that the optimizer microphone is installed in front of this unit.	29
ERROR E-5 Please check MIC position. MIC should be set above 2m/6.5ft.	The optimizer microphone is not placed in the right distance from this unit.	Make sure that the optimizer microphone is installed more than 2 m from the front of this unit and within 1 m from the center height of this unit.	29
ERROR E-6 Volume level is smaller than expected. Please check MIC position/connection and re-try.	The optimizer microphone cannot collect the sound produced by this unit because the sound output level is too low.	Make sure that the optimizer microphone is firmly connected to this unit and placed in a proper location. If the problem persists, contact the nearest YAMAHA service center for assistance.	29
ERROR E-7 Unexpected Error Happened. Please re-try.	An internal system error occurred.	Repeat the AUTO SETUP procedure.	—

USING THE SYSTEM MEMORY

Saving settings

You can save the current settings adjusted in SET MENU in the system memory of this unit. It is handy to save certain settings according to the varying conditions of your listening environment. For example, if there are curtains in the path of beams, the effectiveness of the beams will vary depending on whether the curtains are open or closed.

When the curtains are open

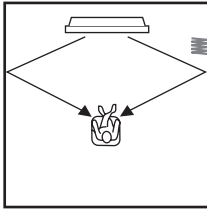

When the curtains are closed

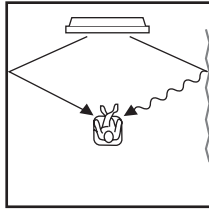

- 1 Press **YSP** on the remote control to switch to the operation mode of this unit.



- 2 Press **MENU** on the remote control.

The SET MENU screen appears on your TV.

MENU



- The control buttons used for SET MENU are displayed on the bottom of the screen.
- To return to the previous screen while using SET MENU, press RETURN on the remote control.
- To resume cursor button operations after changing the control area by pressing an input selector button, press TEST on the remote control.
- To cancel the SET MENU screen, press MENU once more.
- You can also perform the following operations in the front panel display.
- If you press an input selector button during the SET MENU operations, the cursor buttons become ineffective. In this case, press TEST once.

- 3 Press \triangle / ∇ to select **MEMORY** and then press **ENTER**.

The following screen appears on your TV.

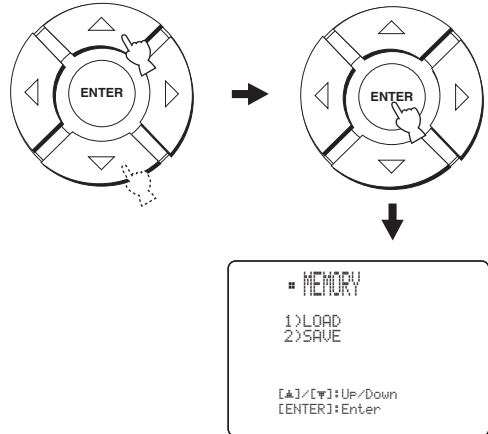

- 4 Press \triangle / ∇ to select **SAVE** and then press **ENTER**.

The following screen appears on your TV.

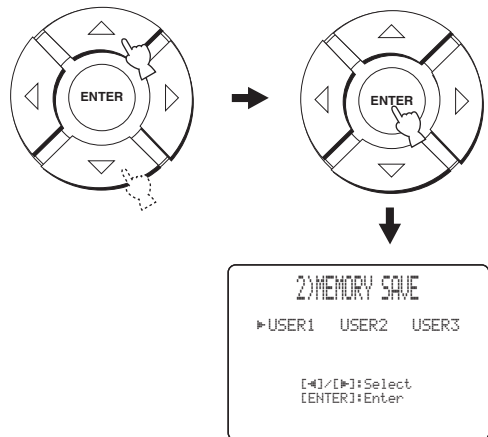

5 Press \triangleleft / \triangleright to select USER1, USER2 or USER3 and then press ENTER.

The following screen appears on your TV.

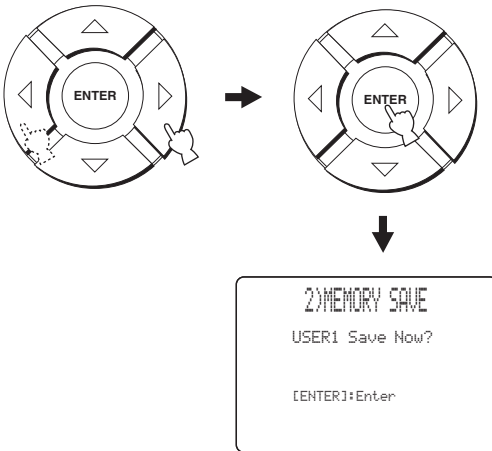

6 Press ENTER again.

The new parameters are saved as USER1, USER2 or USER3. Once the parameters are saved, the display returns to the SET MENU screen.

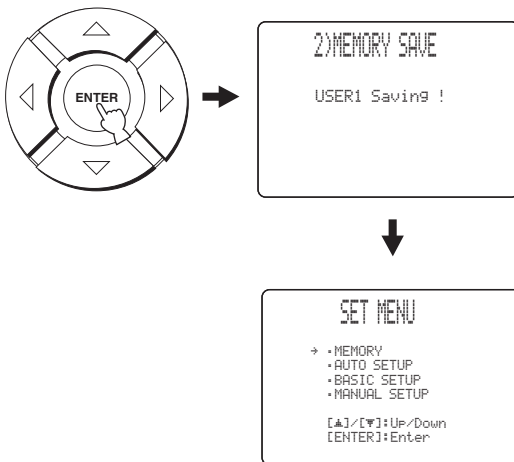

7 Press MENU to exit.

The SET MENU screen disappears from your TV.



Loading settings

You can recall the settings saved in “Saving settings” on page 36 according to the varying conditions of your listening environment.

1 Press YSP on the remote control to switch to the operation mode of this unit.



2 Press MENU on the remote control.

The SET MENU screen appears on your TV.



- The control buttons used for SET MENU are displayed on the bottom of the screen.
- To return to the previous screen while using SET MENU, press RETURN on the remote control.
- To resume cursor button operations after changing the control area by pressing an input selector button, press TEST on the remote control.
- To cancel the SET MENU screen, press MENU once more.
- You can also perform the following operations in the front panel display.
- If you press an input selector button during the SET MENU operations, the cursor buttons become ineffective. In this case, press TEST once.

- 3 Press \triangle / ∇ to select MEMORY and then press ENTER.**

The following screen appears on your TV.

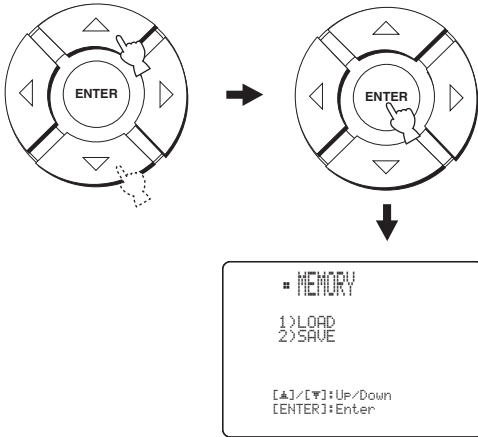

- 5 Press \leftarrow / \rightarrow to select USER1, USER2 or USER3 and then press ENTER.**

The following screen appears on your TV.

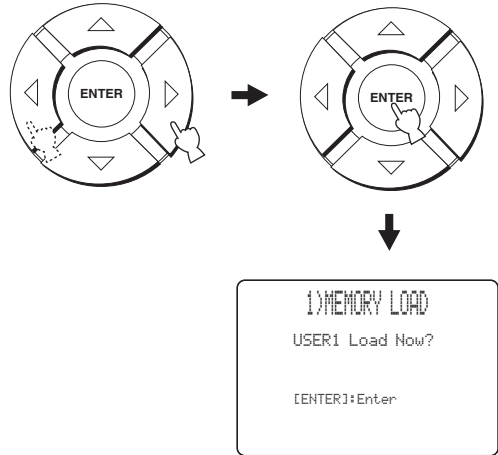

- 4 Press \triangle / ∇ to select LOAD and then press ENTER.**

The following screen appears on your TV.

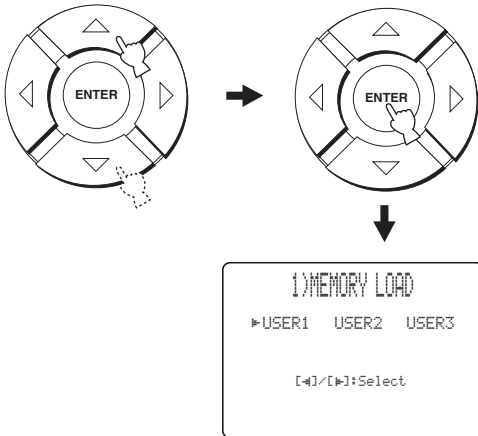

- 6 Press ENTER again.**

The new parameters are saved as USER1, USER2 or USER3. Once the parameters are saved, the display returns to the SET MENU screen.

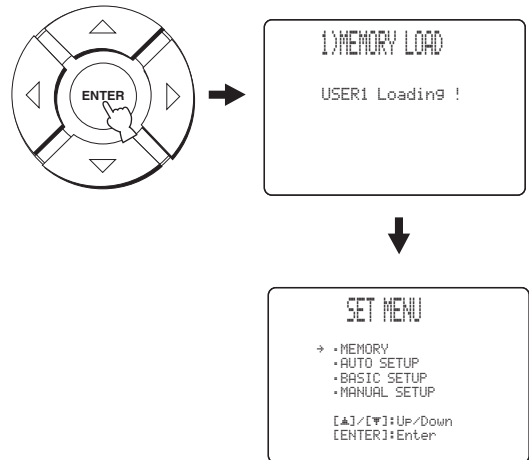

- 7 Press MENU to exit.**

The SET MENU screen disappears from your TV.



PLAYBACK

Selecting the input source

You can play back sound from the components connected to this unit simply by pressing INPUT on the front panel repeatedly or pressing one of the input selector buttons (TV, STB, VCR, DVD or AUX) on the remote control. The name of the selected input source and the type of the corresponding input mode appear in the front panel display.

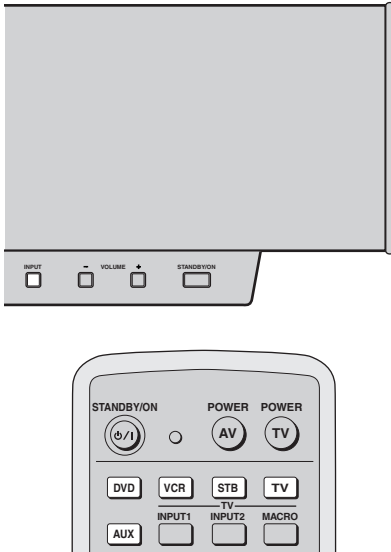

■ Front panel operations

Press **INPUT** on the front panel repeatedly to toggle between **TV, STB, DVD, VCR** and **AUX**.

The name of the corresponding input source and the type of the current input mode are shown in the front panel display.

■ Remote control operations

Press **TV** on the remote control to play back a **TV** program.

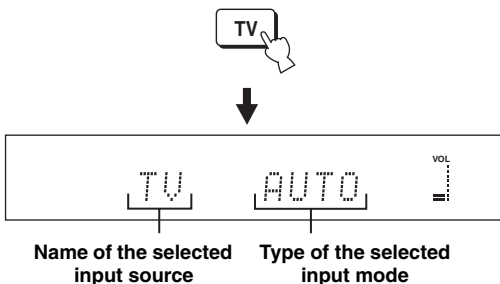

Press **STB** on the remote control to play back a satellite broadcast.

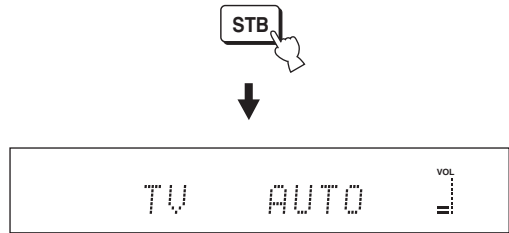

Press **DVD** on the remote control to play back a DVD.

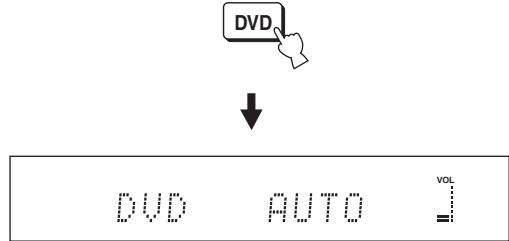

Press **VCR** on the remote control to play back a video tape.

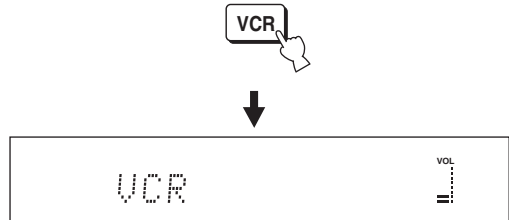

Press **AUX** on the remote control to play back a component connected to the AUX jack on the rear panel of this unit.

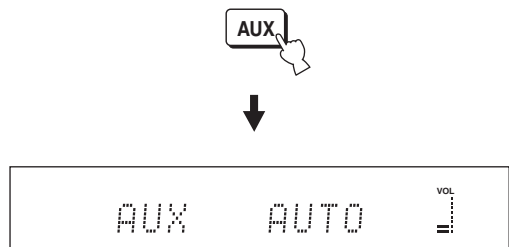

Playing back sources

Once an input source is selected (see page 39), you can play back the selected input source.

Note

This section uses a DVD player as an example of the playback source.



For details on the TV and the DVD player you are using, refer to the owner's manual supplied with the TV and the DVD player.

- 1 Turn on the power of your DVD player using the remote control supplied with the DVD player.
- 2 Switch to the video input on your TV using the remote control supplied with the TV so that the DVD menu screen is displayed.
- 3 If necessary, turn down the volume of your TV until you cannot hear any sound.
- 4 Press DVD on the remote control to select DVD as the input source.



- 5 Play back the DVD on your DVD player using the supplied remote control.

Audio signals from your DVD player are output from the speakers of this unit.



- If the output volume is too low, increase the volume on this unit to around -25 dB.
- If you have set the appropriate remote control codes for your TV and DVD player, you can use the remote control supplied with this unit to operate these components. For details on how to set remote control codes, see page 87.

Adjusting the volume

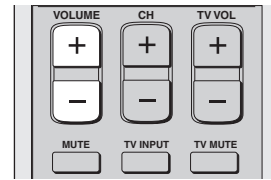
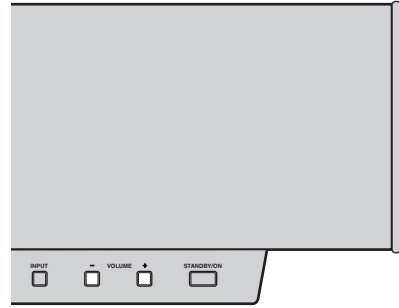

Press **VOLUME +/-** on the front panel or on the remote control to increase or decrease the volume level.

The numeric value of the volume level appears in the front panel display.

Control range: 0.0 dB to -99.5 dB, MIN (minimum)

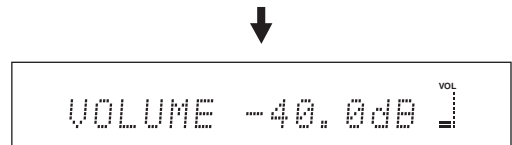
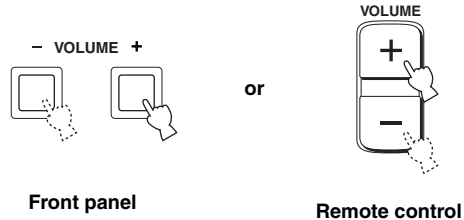

VOLUME MUTE appears at the minimum volume level.

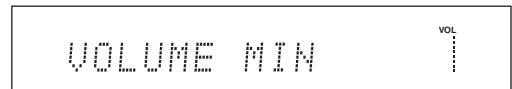

Notes

- The volume level of all input sources (including multi-channel as well as stereo sources) changes at the same time.
- 0.5 dB of the volume level increases or decreases each time you press VOLUME +/-.
- You can continuously increase or decrease the volume level if you press and hold VOLUME +/-.

Muting the sound

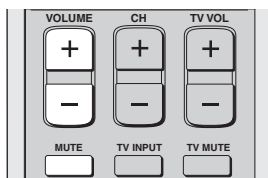

1 Press MUTE on the remote control to mute the sound.

AUDIO MUTE ON appears in the front panel display, and the volume level indicator flashes.

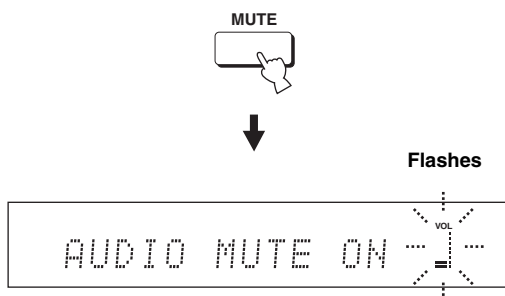

2 Press MUTE on the remote control again (or press VOLUME +/-) to resume the sound output.

AUDIO MUTE OFF appears temporarily in the front panel display (or the numeric value of the current volume level appears if you press VOLUME +/-), and the volume level indicator lights up.

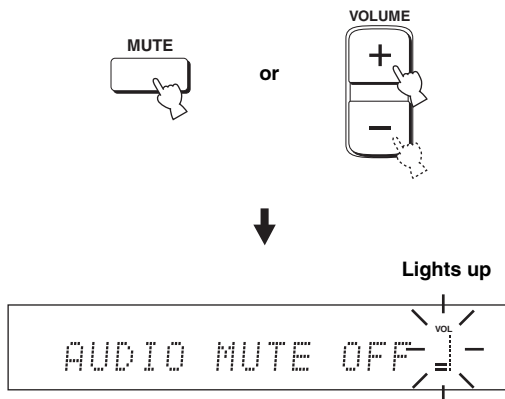

Note

The sound output of all input sources (including multi-channel as well as stereo sources) is muted at the same time.



You can select whether the sound output is to be muted completely or by 20 dB when you press MUTE (see page 76).

BEAM MODE

You can change the beam mode to suit the input source of this unit using the beam mode buttons on the remote control (STEREO, 3BEAM, 5BEAM, ST+3BEAM or TARGET). Select stereo mode for 2-channel sources, 3 beam mode, 5 beam mode and stereo plus 3 beam mode for 5.1-channel playback.

All the beam modes are available in the following cases:

- If you selected Parallel to Wall for INSTALLING in AUTO SETUP (see page 33)
- If you selected settings other than CORNER RIGHT or CORNER LEFT for INSTALLED POSITION in BASIC SETUP (see page 64)
- If you selected FLAT TO WALL for INSTALLED POSITION in MANUAL SETUP (see page 70)

Only stereo, stereo plus 3 beam and target modes are available in the following cases:

- If you selected Angle to Wall or corner for INSTALLING in AUTO SETUP (see page 33)
- If you selected CORNER RIGHT or CORNER LEFT for INSTALLED POSITION in BASIC SETUP (see page 64)
- If you selected ANGLE TO WALL OR CORNER for INSTALLED POSITION in MANUAL SETUP (see page 70)

Beam mode	AUTO SETUP		BASIC SETUP		MANUAL SETUP	
	INSTALLING (see page 33)		INSTALLED POSITION (see page 64)		INSTALLED POSITION (see page 70)	
	Parallel to Wall	Angle to Wall or corner	CORNER RIGHT or CORNER LEFT	Other settings	FLAT TO WALL	ANGLE TO WALL OR CORNER
STEREO	Yes	Yes	Yes	Yes	Yes	Yes
3BEAM	Yes	No	No	Yes	Yes	No
5BEAM	Yes	No	No	Yes	Yes	No
ST+3BEAM	Yes	Yes	Yes	Yes	Yes	Yes
TARGET	Yes	Yes	Yes	Yes	Yes	Yes

Note

Yes: the corresponding beam mode is available.

No: the corresponding beam mode is not available.



1 Press YSP on the remote control to switch to the operation mode of this unit.



2 Press one of the beam mode buttons to select the desired beam mode.

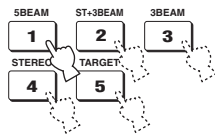

5 beam mode

Outputs sound beams from the front left and right, center, and surround left and right speakers. This mode is ideal for enjoying surround sound effects to the fullest when watching DVDs recorded in a multi-channel format or playing back 2-channel sources in a multi-channel format.

Press 5BEAM on the remote control to select the 5 beam mode.

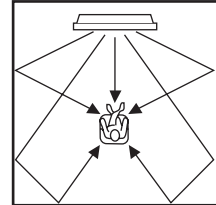

Notes

- To achieve the best surround sound effect, make sure that there are no obstacles placed in the path of sound beams in that the objects may prevent the beams from rebounding directly off the walls in your listening room.
- The front left and right sound beams are output towards the walls in your listening room.

Stereo plus 3 beam mode

Outputs sound beams from the front left and right, center, and surround left and right speakers. This mode is ideal for watching live recordings on a DVD. Vocals and instrumental sounds can be heard close to the center of the listening position while sound reflections from the venue itself can be heard on your right and left, giving you the feeling that you are sitting right in front of the stage.

Press ST+3BEAM on the remote control to select the stereo plus 3 beam mode.

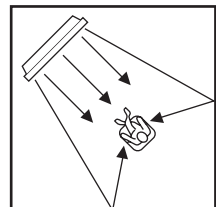
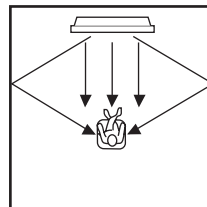

Note

The front left and right sound beams are output directly to the listening position.

3 beam mode

Outputs sound beams from the front left and right and center speakers. This mode is ideal for enjoying movies with the whole family. Because the listening position area is widened, you can enjoy excellent quality surround sound over a wider area.

Press 3BEAM on the remote control to select the 3 beam mode.

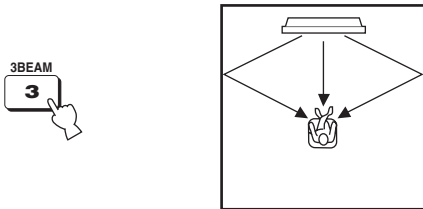

You can achieve a more realistic surround effect if you adjust settings for IMAGE LOCATION in BEAM MENU (see page 74).

Notes

- When you play back multi-channel sources, surround left and right signals are mixed down and output from the front left and right speakers.
- The front left and right sound beams are output towards the walls in your listening room.

Stereo mode

Outputs sound beams from the front left and right speakers in the 2-channel stereo mode. This mode is ideal for playing back hi-fi sources, such as CDs, and can be used to replace your TV speakers.

Press STEREO on the remote control to select the stereo mode.

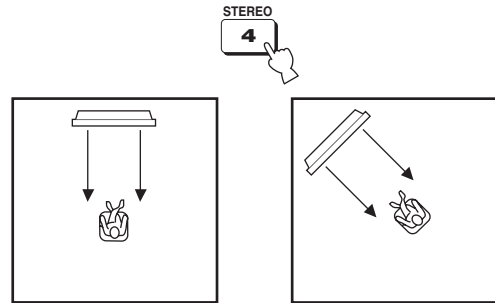

Notes

- When you play back multi-channel sources, all signals except those for the front left and right speakers are mixed down and output from the front left and right speakers. No audio is output from the center and rear channels.
- The surround mode becomes disabled when the stereo mode is selected.
- When you play back Dolby Digital audio signals in the stereo mode, the dynamic range becomes compressed. If the volume level decreases to the extreme, use other beam modes except the target mode.
- If the stereo mode is selected as the beam mode, the surround modes (see page 46) and the CINEMA DSP programs (see page 51) become ineffective.

Target mode

Outputs sound beams in a single channel. This mode is ideal if you do not want the sound beams to be reflected on the walls in your listening room or if you do not disturb others asleep while enjoying music or movies at night.

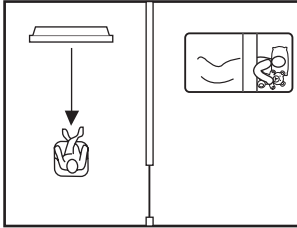

In addition, you can adjust the horizontal angle of the sound beams so that you can hear dialogues clearly even from a distant location such as the kitchen area in your listening room.

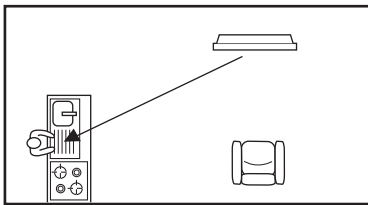

Press **TARGET** on the remote control to select the target mode and then press ◀ / ▶ to adjust the angle.

Control range: L90° to R90°

- Press ◀ repeatedly to increase the horizontal angle on the left side.
- Press ▶ repeatedly to increase the horizontal angle on the right side.

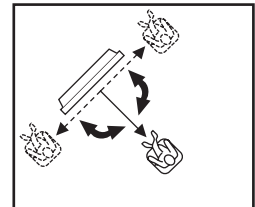
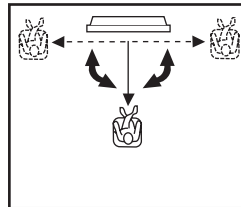
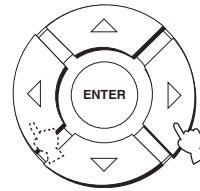

Notes

- The sound beams are not rebounded off the walls in your listening room.
- If the target mode is selected as the beam mode, the surround modes (see page 46), the CINEMA DSP programs (see page 51) and the TruBass (see page 58) become ineffective. In addition, no audio is output from the subwoofer connected to this unit.

ENJOYING SURROUND SOUND

■ Decoder indicators

Depending on the input source and the selected surround mode, the indicators in the front panel display light up as follows:

Status	Indicator
When PCM signals are being input	PCM
When DTS digital signals are being input or when DTS Neo:6 is selected	dts
When Dolby Digital signals are being input	DIGITAL
When Dolby Pro Logic is selected	PL
When Dolby Pro Logic II is selected	PL II



- You can select an input mode (AUTO, DTS or ANALOG) by pressing INPUTMODE on the remote control repeatedly (see page 86).
- Discs encoded in DTS-ES or Dolby Digital 5.1 EX will be played back in DTS or Dolby Digital.

■ Surround modes and recommended sources

Surround mode		Recommended source
Dolby Pro Logic	–	All sources
Dolby Pro Logic II	Movie Music Game	Movies Music Games
DTS Neo:6	Cinema Music	Movies Music

Notes

- Surround modes are available when the beam mode is set to a setting other than the stereo or the target mode.
- When you select an input source (see page 39), the surround mode used for the previously selected input source is selected.
- If the power of this unit is turned off and on again, the surround mode used for the previously selected input source before the power was turned off is selected.
- The surround modes are available only when the CINEMA DSP programs are turned off (see page 55) or when the movie program is selected as the CINEMA DSP program (see page 54).
- Only Dolby Pro Logic, Dolby Pro Logic II Movie and DTS Neo:6 Cinema are available when the movie program is selected as the CINEMA DSP program (see page 54).
- If the surround modes are not available, “Prohibit” appears in the front panel display when you press SURROUND on the remote control.
- The surround modes are available only when 2-channel signals are being input. If you try to switch between the surround modes when 5.1 channel signals are being input, “Prohibit” appears in the front panel display.

Enjoying 2-channel sources in surround sound

This unit can decode 2-channel sources for 5.1 channel playback so that you can enjoy a variety of surround sound effects by switching the surround mode.



The surround modes are available only when the CINEMA DSP programs are turned off (see page 55) or when the movie program is selected as the CINEMA DSP program (see page 54). In addition, the beam mode must be set to the 5 beam mode, the stereo plus 3 beam mode or the 3 beam mode (see page 42).

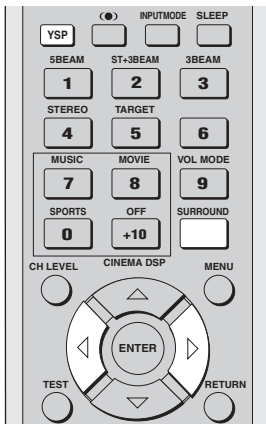

1 Press YSP on the remote control to switch to the operation mode of this unit.



2 Press SURROUND on the remote control repeatedly (or press SURROUND and then press ◀/▶) to switch between surround modes.

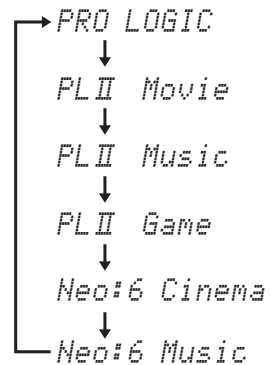
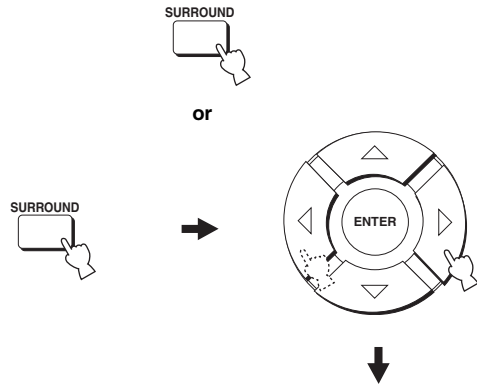

Example of the surround mode display in the front panel display when the CINEMA DSP program is turned off

Enjoying TV in surround sound

You can enjoy analog audio signals output from your TV in real surround sound.



Before performing the steps below, set the volume of this unit to -40 dB. If necessary, adjust the volume level in step 4 below.

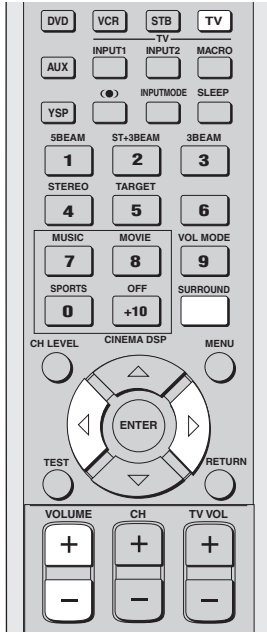

1 Select the TV channel you want to watch.

To select a TV channel, use the remote control supplied with your TV.

2 Press TV on the remote control.

This unit outputs audio signals from your TV.



3 If you hear sound from your TV speakers, reduce the volume level of your TV until you can no longer hear any audio being output.

To reduce the TV volume level, use the remote control supplied with your TV.

4 Press VOLUME +/- on the remote control to adjust the volume level.



5 Press SURROUND repeatedly (or press SURROUND and then press < / >) on the remote control to select a surround mode.

Signals input from 2-channel sources are played back on multiple channels.

For more information on surround modes, see page 46.



or

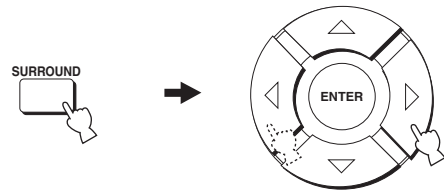

Adjusting surround mode parameters

You can configure the parameters for Dolby Pro Logic II Music and DTS Neo:6 Music to fine-tune the surround sound effect.

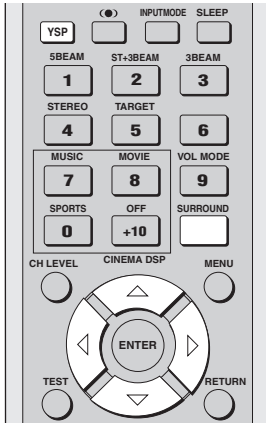

- 1 Press YSP on the remote control to switch to the operation mode of this unit.



- 2 Press SURROUND on the remote control repeatedly (or press SURROUND and then press \triangle/∇) to select PL II Music or Neo:6 Music.



or

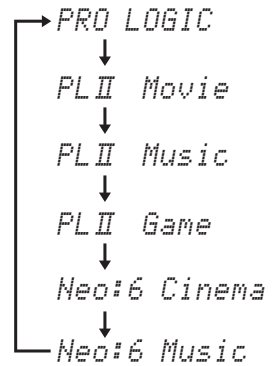
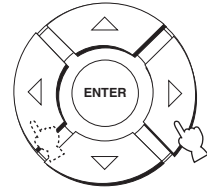

Example of the surround mode display in the front panel display when the CINEMA DSP program is turned off

- 3 Press \triangle/∇ to select the parameter.

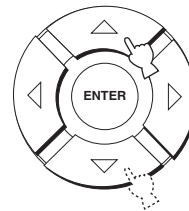

- 4 Press \triangle/∇ to configure the parameter.

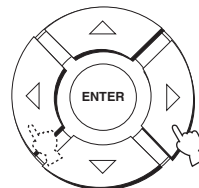

■ When Dolby Pro Logic II Music is selected

PANORAMA

Gives front left and right channel sound a wraparound effect, distributed throughout the entire surround sound field to give you an expansive feeling.

Choices: ON/OFF

Default setting: OFF

DIMENSION

Adjusts the difference in volume between front and surround channels to the volume balance you desire.

Control range: -3 (toward the surround direction) to +3 (toward the front direction)

Default setting: STD

CT WIDTH

Distributes the center channel sound to the left and right. If set to 0, center channel sounds output only from the center speaker.

Control range: 0 to 7

Default setting: 3

■ When DTS Neo:6 Music is selected

C. IMAGE

Adjusts the center image from three speakers (front and center) to varying degrees.

Control range: 0.0 (wider) to 1.0 (toward the center)

Default setting: 0.3

USING SOUND FIELD PROGRAMS

This unit is equipped with a variety of precise digital decoders that allow you to enjoy multi-channel playback from stereo or multi-channel sources. This unit is also equipped with a YAMAHA CINEMA DSP (digital sound field processing) chip containing several sound field programs which you can use to enhance your playback experience. Most of the sound field programs are precise digital recreations of actual acoustic environments found in famous concert halls, music venues and movie theaters.



The YAMAHA CINEMA DSP modes are compatible with all Dolby Digital, DTS and Dolby Surround sources.

Note

Choose a sound field program based on your listening preference and do not purely rely on the name of the sound field program itself.

What is a sound field?

A significant factor that creates the rich, full tones of a live instrument are the multiple reflections from the walls of the room. In addition to making the sound live, these reflections enable the listener to tell where the player is situated as well as the size and shape of the room in which the listening is sitting.

■ Elements of a sound field

In any environment, there are two distinct types of sound reflections that combine with the direct sound coming straight to our ears from the player's instrument to make up the sound field.

Early reflections

Reflected sounds reach our ears extremely rapidly (50 ms to 100 ms after the direct sound) after reflecting from one surface only (from the ceiling or a wall, for example). Early reflections help add clarity to the direct sound.

Reverberations

These are caused by reflections from more than one surface (i.e. wall, ceiling, the back of the room, etc.) so numerous that they merge together to form a continuous sonic afterglow. They are non-directional and lessen the clarity of the direct sound.

Direct sound, early reflections and subsequent reverberation taken together help us to determine the subjective size and shape of the room, and it is this information that the digital sound field processor reproduces in order to create sound fields.

If you could create the appropriate early reflections and subsequent reverberations in your listening room, you would be able to create your own listening environment. The acoustics in your room could be changed to those of a concert hall, a dance floor or a listening room of virtually any size at all. This ability to create sound fields at will is exactly what YAMAHA has done with the CINEMA DSP technology.

Sound field program descriptions

You can select from the following sound field programs based on your listening preference when you play music, movie or sports sources.

Notes

- There is only one sports sound field program available.
- For details on how to switch between the available sound field programs, see page 53.

Sound field program	Source	Feature
Music Video	Music	This program produces a vibrant environment and lets you feel as if you are at an actual jazz or rock concert.
Concert Hall		This program creates a rich surround effect of a large round concert hall with a great deal of presence, emphasizing the extension of sounds, and lets you feel as if you are seated close to the center of the stage.
Jazz Club		This program recreates the acoustic environment of “The Bottom Line”, a famous jazz club in New York and lets you feel as if you are seated right in front of the stage.
Sci-Fi	Movie	This program clearly reproduces dialogs and special sound effects of the latest science fiction films and lets you feel a broad and expansive cinematic space amid silence.
Spectacle		This program reproduces the wide and grand environment and lets you have added impressions on spectacular scenes with strong visual impacts.
Adventure		This program reproduces the thrilling environment of the latest action films and lets you feel the dynamic and excitement of fast-moving scenes.
SPORTS	Sports	This program reproduces the energetic environment of live sports broadcasting, converging a commentator’s voice on the center and broadening the overall atmosphere of the stadium, and lets you feel as if you are seated at an actual stadium or a ball park.

Turning on CINEMA DSP programs

You can select from three different sound field programs (MUSIC, MOVIE and SPORTS) depending on the type of sources you want to enjoy.

Notes

- The CINEMA DSP programs are not available if the stereo mode (see page 44) or the target mode (see page 45) is selected as the beam mode.
- If the CINEMA DSP programs are not available, "Prohibit" appears in the front panel display when you press one of the sound field program buttons on the remote control.

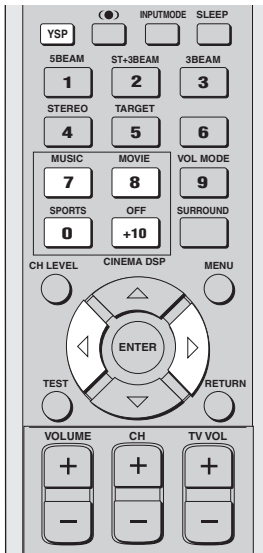

Music sound field programs

Select this sound field program when you play music sources. This program produces a vibrant atmosphere and lets you feel as if you are seated in an actual rock or jazz concert hall.

- 1 Press YSP on the remote control to switch to the operation mode of this unit.



- 2 Press MUSIC on the remote control to select the music sound field program.



- 3 Check that MUSIC is displayed in the front panel display and then press MUSIC on the remote control repeatedly (or press left/right arrows on the remote control) to switch between the music sound field programs.

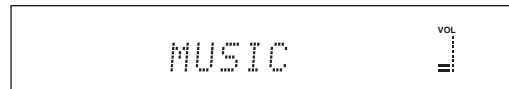

or

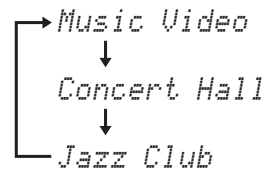
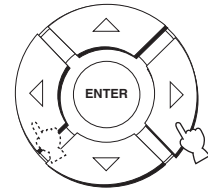

For detailed descriptions of each sound field program, see "Sound field program descriptions" on page 52.

■ **Movie sound field programs**

Select this sound field program when you play movie sources, especially the ones encoded in Dolby Digital, DTS or Dolby Surround. This program clearly reproduces dialog and sound effects, thus creating a broad and expansive cinematic space amid silence.

- 1 Press **YSP** on the remote control to switch to the operation mode of this unit.



- 2 Press **MOVIE** on the remote control to select the movie sound field program.



- 3 Check that **MOVIE** is displayed in the front panel display and then press **MOVIE** on the remote control repeatedly (or press **◀/▶** on the remote control) to switch between the music sound field programs.

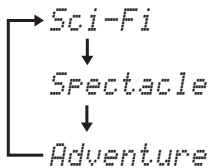
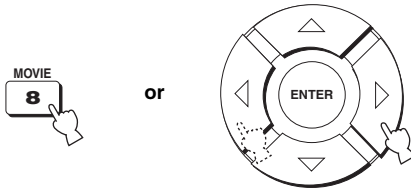
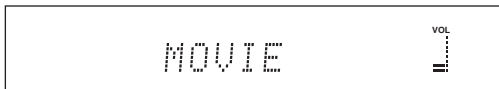

For detailed descriptions of each sound field program, see “Sound field program descriptions” on page 52.

■ **Sports sound field program**

Select this sound field program when you play sports sources. This program densely concentrates the vocal sound of the commentator in the center while broadening the sound from the audience or the environment all around your listening room.

- 1 Press **YSP** on the remote control to switch to the operation mode of this unit.



- 2 Press **SPORTS** on the remote control to select the sports sound field program. SPORTS is displayed in the front panel display.

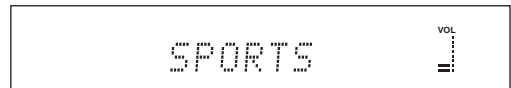

- There is only one sports sound field program available.
- For detailed descriptions of each sound field program, see “Sound field program descriptions” on page 52.

Turning off CINEMA DSP programs

Turn off the CINEMA DSP programs if you want to enjoy the original sound without the sound field program effect.

- 1 Press **YSP** on the remote control to switch to the operation mode of this unit.



- 2 Press **OFF** on the remote control to turn off the sound field programs.



Adjusting CINEMA DSP levels

You can enjoy good quality sound with the factory preset parameters. However, you can also adjust the effect level of the CINEMA DSP programs relative to the level of the direct sound so that each sound field program can reflect your listening environment and your preference even more accurately.

- 1 Press **YSP** on the remote control to switch to the operation mode of this unit.



- 2 Press **MUSIC**, **MOVIE** or **SPORTS** on the remote control to select the desired sound field program.



- 3 Press **△ / ▽** on the remote control. DSP LEVEL is shown in the front panel display.



- 4 Press **◀ / ▶** on the remote control to adjust the effect level of the CINEMA DSP programs.

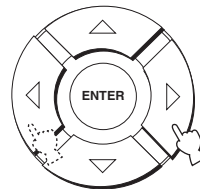

Control range: -6 dB to +3 dB

- A larger value increases the effect level.
- A smaller value decreases the effect level.

USING THE VOLUME MODE

The night listening modes are designed to improve listenability at lower volumes or at night. In addition, you can limit the volume level of the TV so that it will not vary suddenly to a great extent whenever the contents being broadcast change (i.e. due to commercials, etc.).

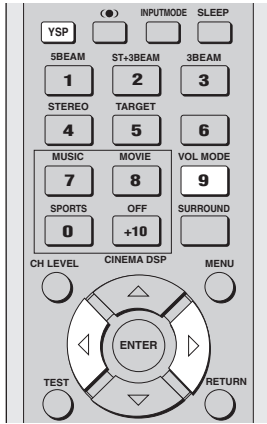

- 1 Press YSP on the remote control to switch to the operation mode of this unit.



- 2 Press VOL MODE on the remote control to switch to the volume mode.

The NIGHT indicator lights up in the front panel display.



- 3 Press VOL MODE on the remote control repeatedly to select NIGHT:CINEMA, NIGHT:MUSIC, TV EQUAL VOL or NIGHT OFF.

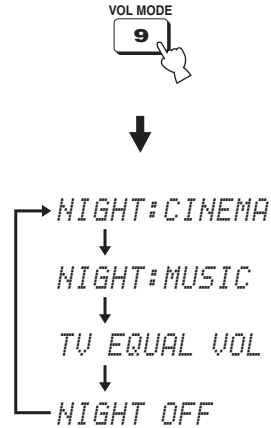

- Select NIGHT:CINEMA when watching films to reduce the dynamic range of film soundtracks and make dialog easier to hear at lower volumes.
- Select NIGHT:MUSIC when listening to music sources to preserve ease-of-listening for all sounds.
- Select TV EQUAL VOL when watching TV programs.
- Select NIGHT OFF to turn off the night listening modes.

- 4 Press $\triangleleft/\triangleright$ on the remote control to adjust the effect level of compression while NIGHT:CINEMA, NIGHT:MUSIC or TV EQUAL VOL is displayed.

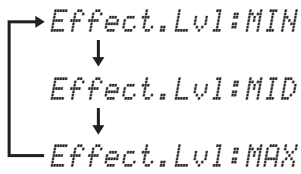
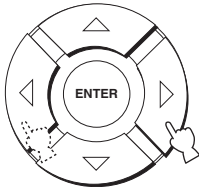

- Select Effect.Lvl:MIN for minimum compression.
- Select Effect.Lvl:MID for standard compression.
- Select Effect.Lvl:MAX for maximum compression.

Note

The volume mode settings are canceled if you press STANDBY/ON on the front panel or on the remote control or if you disconnect the power supply cable from the AC wall outlet.

USING TruBass

This unit can produce the perception of an improved low frequency performance with the aid of the SRS TruBass technology, which improves bass even without a subwoofer and provides deeper, richer bass in the presence of a subwoofer.

Note

The TruBass is not available when the target mode is selected as the beam mode (see page 45).

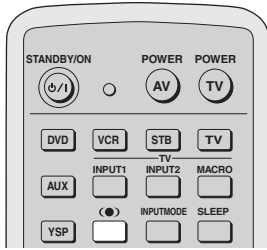

1 Press on the remote control.

The current setting (TruBass MID, TruBass DEEP, or TruBass OFF) is shown in the front panel display.

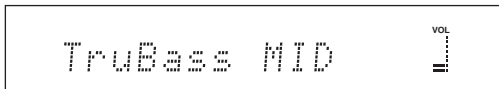

or

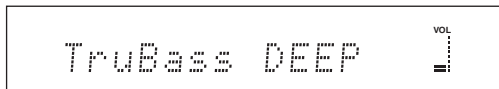

or

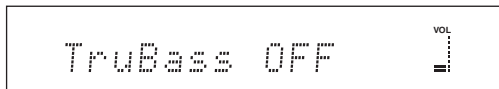

2 Press on the remote control repeatedly to turn on SRS TruBass.

TruBass MID or TruBass DEEP is shown in the front panel display.

You can select TruBass MID or TruBass DEEP depending on the type of material you are playing.

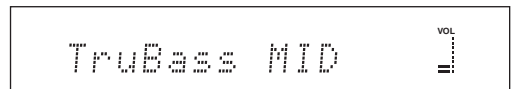
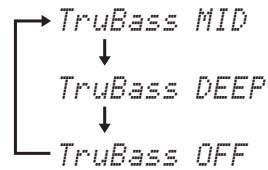

or

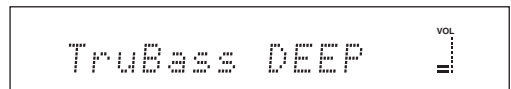

- Select TruBass MID for standard effects.
- Select TruBass DEEP for maximum effects.

3 Press (●) on the remote control repeatedly to turn off SRS TruBass.

TruBass OFF is shown in the front panel display.



TruBass MID
↓
TruBass DEEP
↓
TruBass OFF

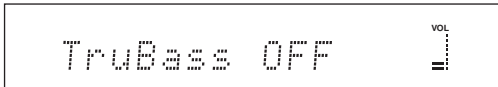

USING THE SLEEP TIMER

Use this feature to automatically set this unit to the standby mode after a specified time period. The sleep timer is useful if you are going to sleep after a certain amount of time while this unit is still playing back a source.

Setting the sleep timer



Each time you press SLEEP on the remote control, the front panel display changes as shown below.

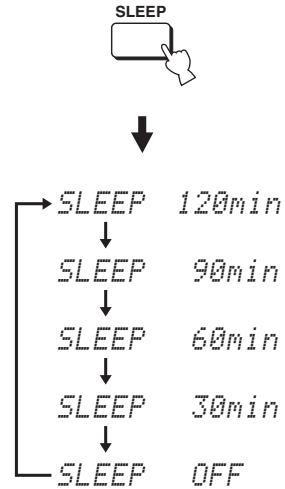

- 1 Press SLEEP on the remote control repeatedly to set the amount of time for the sleep timer.**

Choices: 120 min, 90 min, 60 min, 30 min, OFF
The SLEEP indicator in the front panel display flashes while switching the amount of time for the sleep timer.

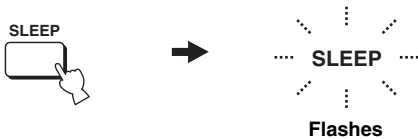

- 2 Wait for a few seconds without operating this unit to confirm the setting for the sleep timer.**

The SLEEP indicator lights up in the front panel display, indicating that the sleep timer is activated.



Canceling the sleep timer

- 1 Press **SLEEP** on the remote control repeatedly so that **SLEEP OFF** appears in the front panel display.



- 2 Wait for a few seconds without operating this unit to confirm the setting for the sleep timer. The **SLEEP** indicator disappears from the front panel display, indicating that the sleep timer is deactivated.

SLEEP
Disappears

Note

The previous setting for the sleep timer before you deactivate it is stored in the system memory and automatically restored when you make a new setting next time.



The sleep timer setting can also be deactivated if you press **STANDBY/ON** on the front panel or on the remote control to set this unit to the standby mode or unplug the power supply cable from the AC outlet.

BASIC SETUP

If you cannot run AUTO SETUP successfully or if an error occurs during the AUTO SETUP procedure, you can use BASIC SETUP to individually set the parameters of this unit in the following order:

- 1) ROOM TYPE (Room type)
- 2) INSTALLED POSITION (Installed position of this unit)
- 3) ROOM SIZE (Room size)



- You can save the settings optimized by the AUTO SETUP procedure (see page 36). A set of settings optimized according to specific conditions of your listening environment can be recalled later depending on the varying conditions of your listening environment (see page 37).
- In order to fine-tune the listening environment parameters, as well as to make advanced settings for speaker positions, sound beams, digital input and the OSD, see MANUAL SETUP (see page 68).
- Items with an asterisk (*) appearing next to them may be displayed differently on your screen depending on your individual settings.

Note

Each listening environment parameter must be set before the next parameter in order is set.



- The control buttons used for SET MENU are displayed on the bottom of the screen.
- To return to the previous screen while using SET MENU, press RETURN on the remote control.
- To resume cursor button operations after changing the control area by pressing an input selector button, press TEST on the remote control.
- To cancel the SET MENU screen, press MENU once more.
- You can also perform the following operations in the front panel display.
- If you press an input selector button during the SET MENU operations, the cursor buttons become ineffective. In this case, press TEST once.

■ Displaying the SET MENU screen

- 1 Press YSP on the remote control to switch to the operation mode of this unit.**



- 2 Press MENU on the remote control.**

The SET MENU screen appears on your TV.



- 3 Press \triangle / ∇ to select BASIC SETUP and then press ENTER.**

The following screen appears on your TV.

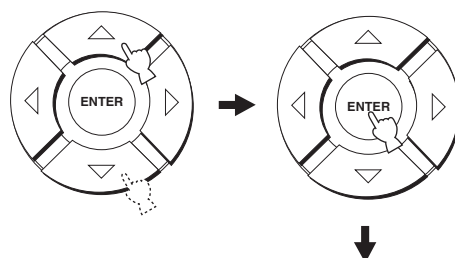

ROOM TYPE (Room type)

4 Check that the following screen is displayed on your TV.

If this screen is not displayed, repeat steps 1 to 3.



5 Press ENTER.

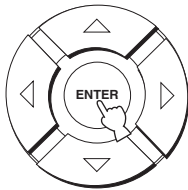

6 Press ◀/▶ to switch between the SQUARE and RECTANGLE selection screens and then press ENTER to select the desired setting.

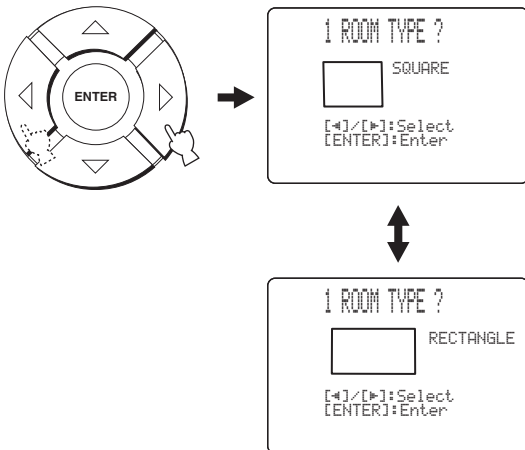

- Select SQUARE if the shape of your listening room is nearest to a square.
- Select RECTANGLE if the shape of your listening room is nearest to a rectangle.



If the shape of your listening room is irregular, select the shape that most closely resembles your room.

In Example 1, the shape that best describes the listening room is RECTANGLE. In Example 2, it is SQUARE.

Example 1:
Rectangular room

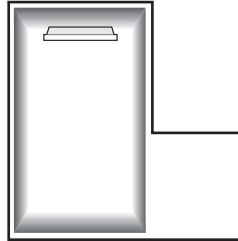

Example 2:
Square room

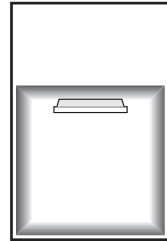

7 Press ENTER to confirm the setting for the room type.

The following screen appears in the front panel display.

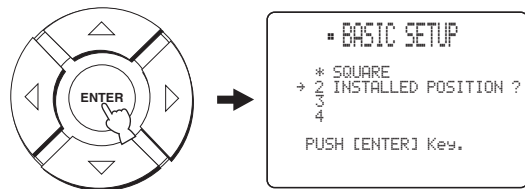

**■ INSTALLED POSITION
(Installed position of this unit)**

8 Check that the following screen is displayed on your TV.

If this screen is not displayed, make settings for ROOM TYPE.



If RECTANGLE is selected for ROOM TYPE

Select WIDE LEFT, WIDE CENTER, WIDE RIGHT, CORNER RIGHT, CORNER LEFT, NARROW LEFT, NARROW CENTER or NARROW RIGHT that best matches the installed position of this unit in your listening room.

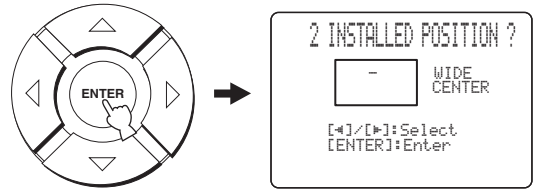

9 Press ENTER.

If you selected SQUARE for ROOM TYPE (see page 63), four different installed position types in a square room are displayed.

If you selected RECTANGLE, eight different installed position types in a rectangular room are displayed.

If SQUARE is selected for ROOM TYPE

Select LEFT, CENTER, RIGHT or CORNER that best matches the installed position of this unit in your listening room.

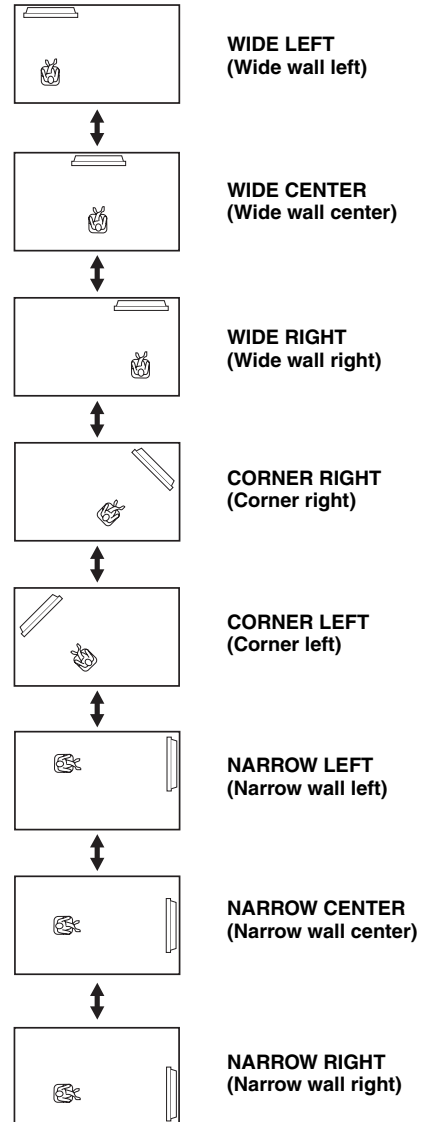
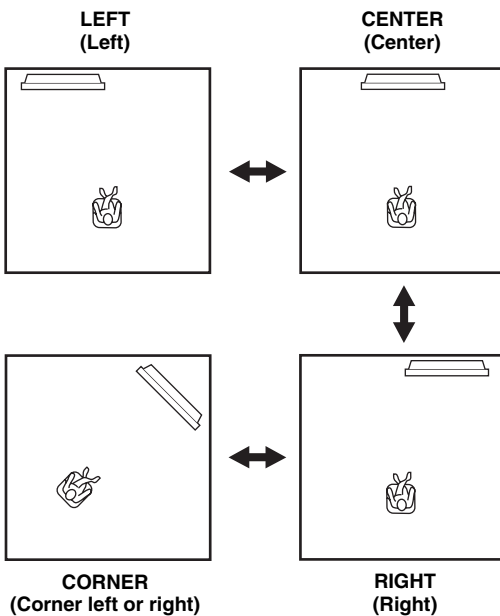
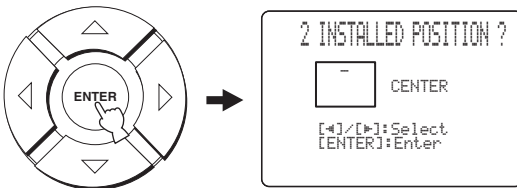

10 Press $\triangleleft/\triangleright$ to select the installed position type that best suits the installed position of this unit in your listening room and then press ENTER.

The following screen appears in the front panel display.

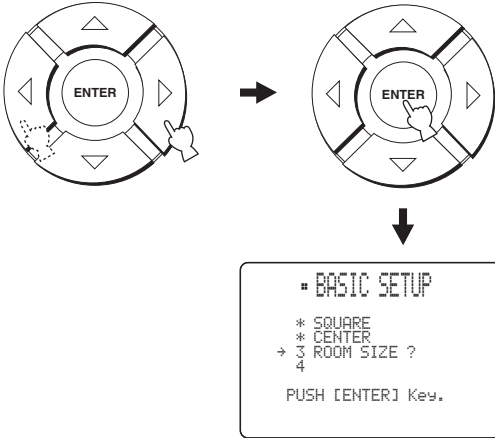

ROOM SIZE (Room size)

11 Check that the following screen is displayed on your TV.

If this screen is not displayed, make settings for INSTALLED POSITION.

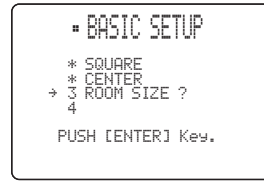

12 Press ENTER.

Three different room sizes (SMALL, MID or LARGE) are displayed for both SQUARE and RECTANGLE.

If SQUARE is selected for ROOM TYPE

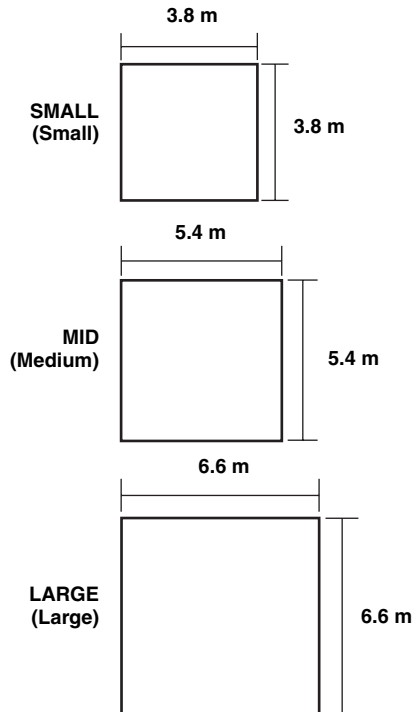
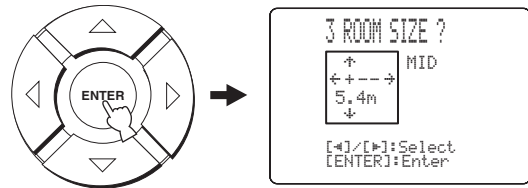

If **RECTANGLE** is selected for **ROOM TYPE**

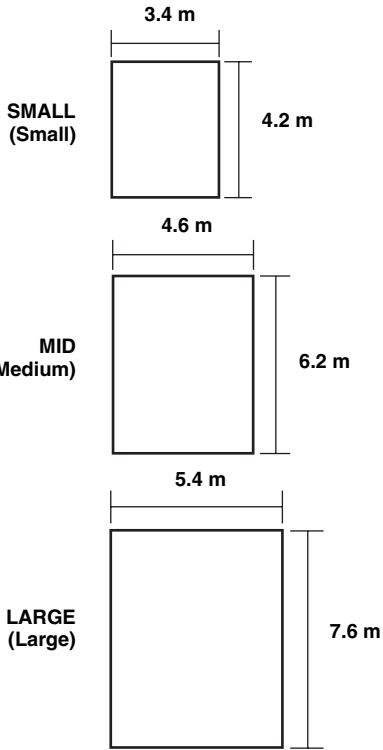
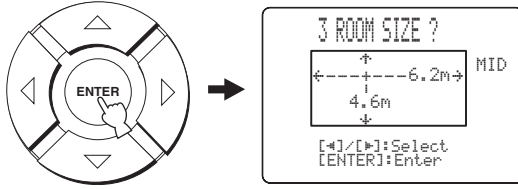

■ **SETUP OK (Confirming settings)**

14 Check that the following screen is displayed on your TV.

If this screen is not displayed, make settings for ROOM SIZE.



15 Press **ENTER**.

The following screen appears in the front panel display.

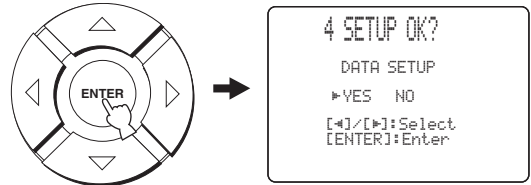

13 Press **◀/▶** to select the room size that best suits your listening room and then press **ENTER**.

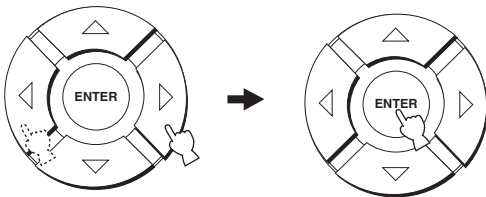

- 16** Press $\triangleleft/\triangleright$ to select YES or NO and then press ENTER.

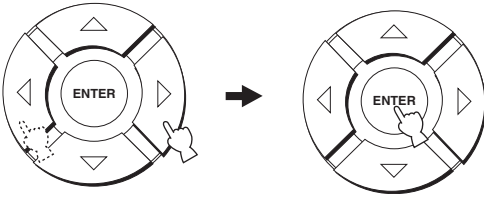

- Select YES to register the settings if they are satisfactory. The following screen appears, and your BASIC SETUP settings are registered.



- Select NO to cancel the settings and return to the initial SET MENU screen.



- 17** Press MENU to complete the BASIC SETUP procedure.

The SET MENU display disappears from your TV screen.



This completes the parameter settings for BASIC SETUP. To select a playback source and enjoy surround sound on this unit, see “PLAYBACK” on page 39.

MANUAL SETUP

To achieve the best quality surround sound, you can use MANUAL SETUP to fine-tune the listening environment parameters, as well as to make advanced settings for speaker positions, sound beams, digital input and the OSD. Change the initial settings (indicated in bold under each parameter) to reflect the needs of your own listening environment.



- You can save the settings optimized by the AUTO SETUP procedure (see page 36). A set of settings optimized according to specific conditions of your listening environment can be recalled later depending on the varying conditions of your listening environment (see page 37).
- Most of the parameters in SOUND MENU and BEAM MENU are automatically set when you run AUTO SETUP (see page 28). Use SOUND MENU and BEAM MENU to make additional adjustments.
- BEAM MENU allows you to make settings for the surround sound effects normally available in the speaker settings menu.
- Make settings for the parameters in BEAM MENU first before you make settings for the parameters in SOUND MENU, INPUT MENU and DISPLAY MENU.

SOUND MENU

Use to manually adjust various parameters related to the sound output.

Item	Features	Page
TONE CONTROL	Adjusts the output level of high-frequency or low-frequency sound.	74
BEAM LEVEL	Adjusts the output level of each beam.	75
SUBWOOFER SET	Adjusts the various subwoofer settings.	75
MUTE LEVEL	Adjusts the muting level.	76
AUDIO DELAY	Adjusts audio delay.	76
ROOM EQ	Adjusts the tonal quality of the listening room.	76
DD/DTS Dynamic Range	Adjusts the dynamic range of Dolby Digital or DTS signals.	76

BEAM MENU

Use to manually adjust various parameters related to the sound beam output.

Item	Features	Page
SETTING PARAMETERS	Adjusts listening room and listening position settings.	70
BEAM ADJUSTMENT	Adjusts various beam settings.	71
IMAGE LOCATION	Adjusts the position of the front left and right speakers.	74

INPUT MENU

Use to manually adjust various parameters related to the audio and video input.

Item	Features	Page
INPUT ASSIGNMENT	Assigns jacks according to the component to be used.	77
INPUT MODE	Selects the initial input of the source.	77
INPUT TRIM	Adjusts the input level of the source.	78
INPUT RENAME	Renames the displayed input source.	78

DISPLAY MENU

Use to manually adjust various parameters related to the display.

Item	Features	Page
DIMMER SET	Adjusts the brightness of the display.	79
OSD SET	Adjusts the display position and the background color of the OSD.	79
UNIT SET	Changes the display unit of measurement.	79

Using MANUAL SETUP

Use the remote control to access and adjust each parameter.



You can adjust the SET MENU parameters while the unit is reproducing sound.

- 1 Press **YSP** on the remote control to switch to the operation mode of this unit.



- 2 Press **MENU** on the remote control. The SET MENU screen appears on your TV.

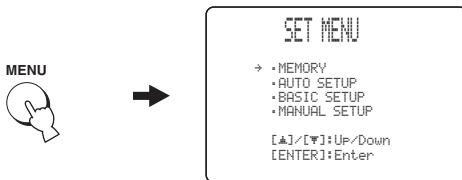

- The control buttons used for SET MENU are displayed on the bottom of the screen.
- To return to the previous screen while using SET MENU, press RETURN on the remote control.
- To resume cursor button operations after changing the control area by pressing an input selector button, press TEST on the remote control.
- To cancel the SET MENU screen, press MENU once more.
- You can also perform the following operations in the front panel display.
- If you press an input selector button during the SET MENU operations, the cursor buttons become ineffective. In this case, press TEST once.

- 3 Press \triangle / ∇ to select **MANUAL SETUP** and then press **ENTER**.

The following screen appears on your TV.

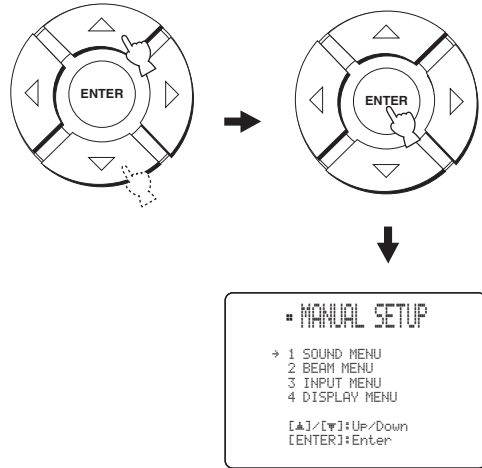

- 4 Press \triangle / ∇ to select a sub menu and then press **ENTER**.

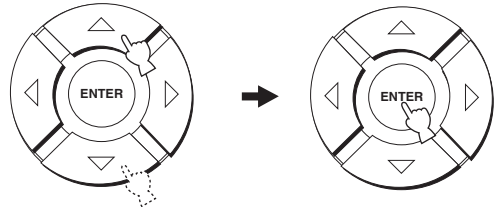

- 5 Press \triangle / ∇ / \leftarrow / \rightarrow and **ENTER** to configure each parameter.

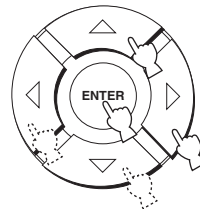

- 6 Press **MENU** to exit.

The OSD disappears from your TV screen.



BEAM MENU

Use to manually adjust various parameters related to the sound beam output.

SET MENU → MANUAL SETUP → BEAM MENU



SETTING PARAMETERS (Setting parameters)

Use to set the position of this unit in your listening room and the distance of this unit from the listening position. When you make settings for each parameter, other related parameters are automatically adjusted to best match your listening environment.

Note

If you make adjustments in SETTING PARAMETERS, the beam optimization settings made in the AUTO SETUP procedure will be lost. If you want to keep the beam optimization settings made in the AUTO SETUP and make further adjustments, adjust settings in BEAM ADJUSTMENT first (see page 71).

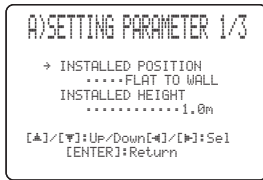

INSTALLED POSITION (Installed position of this unit)

Use to adjust the installed position of this unit.

Choices: **FLAT TO WALL** (Parallel to wall installation), **ANGLE TO WALL OR CORNER** (Corner installation)

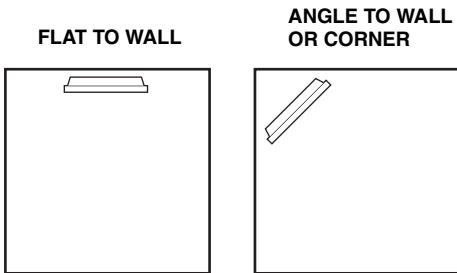

- Select **FLAT TO WALL** if this unit is installed in parallel with the wall in your listening room. Adjust the width and length of your listening room as well as the distance of the listening position from this unit and the distance of the center of this unit from the left wall.

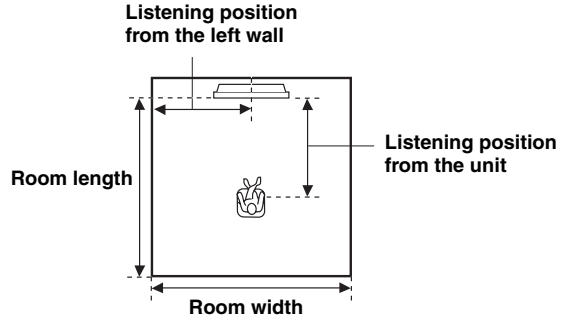

Choices for the room width and length:

2.0 m to 12.0 m

Choices for the listening position from this unit:

2.0 m to 9.0 m

Choices for the listening position from the left wall:

0.6 m to 11.4 m

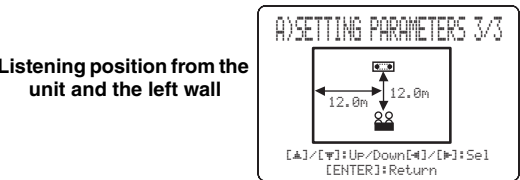
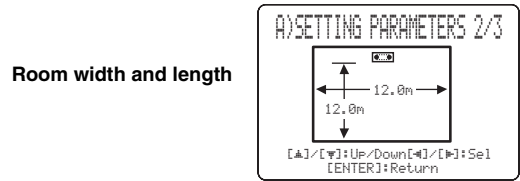

- Select ANGLE TO WALL OR CORNER if this unit is installed in the corner in your listening room. Adjust the width and length of your listening room as well as the distance of the listening position from this unit and the distance of the center of this unit from the left wall.

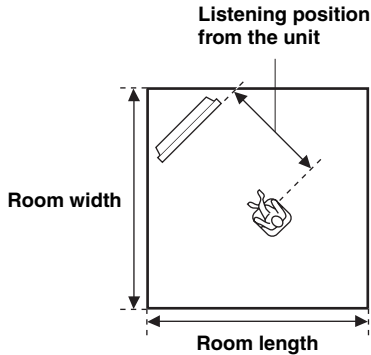

- Choices for the room width and length:
2.0 m to 12.0 m
- Choices for the listening position from this unit:
2.0 m to 9.0 m
- Choices for the listening position from the left wall:
0.6 m to 11.4 m

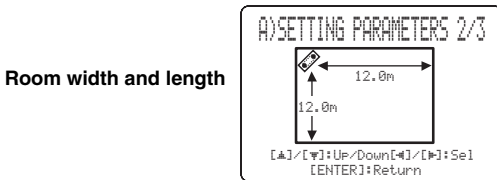

Listening position from the unit and the left wall

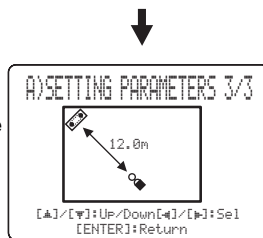

Note

When you set the INSTALLED POSITION parameter in BASIC SETUP (see page 64) or MANUAL SETUP (see page 70), the parameters newly set for the width and length of your listening room are automatically set as the factory default value.

INSTALLED HEIGHT (Installed height of this unit)

Use to adjust the installed height of this unit.
Control range: 0.0 m to 3.0 m
Initial setting: 1.0 m

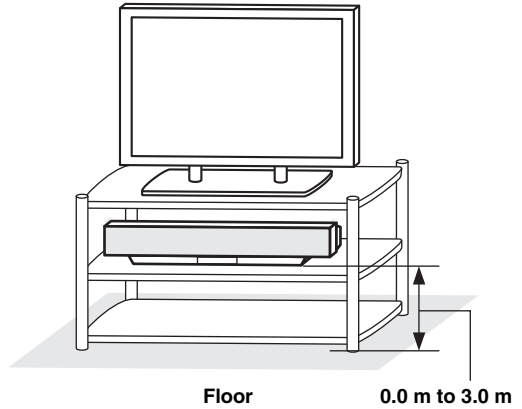

BEAM ADJUSTMENT (Beam adjustment)

Use to manually adjust the various speaker beam angles. We recommend that you select 5 beam mode before adjusting these parameters.

Notes

- When INSTALLED POSITION is adjusted in BASIC SETUP (see page 64) or MANUAL SETUP (see page 70), the factory default value is automatically set for this parameter except when FOCAL LENGTH is set to CENTER (see page 73).
- Depending on the beam mode settings (see page 42), some speaker positions may not be available for selection. In this case, “-” is displayed. When using the stereo plus 3 beam mode, set the surround left and right signals to be output from the front left and right speakers.

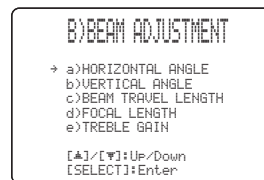

HORIZONTAL ANGLE (Horizontal angle)

Use to adjust the horizontal angle of beams for each speaker. By adjusting the horizontal angle of the beams, you can optimize the sound beam paths. A test tone is automatically output.

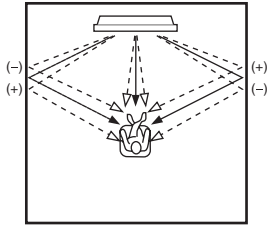

Choices: L90° to R90°

Adjust towards L (left) to move the direction of the output to the left and adjust towards R (right) to move it to the right.

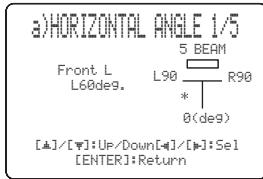

VERTICAL ANGLE (Vertical angle)

Use to adjust the vertical angle of sound beams for each speaker. By altering the beam path, you can optimize sound beam angles.

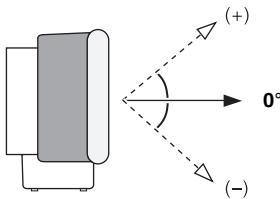

Choices: -45° to +45°

Initial setting: 0°

- Adjust towards – (minus) to move the angle downward.
- Adjust towards + (plus) to move the angle upward.

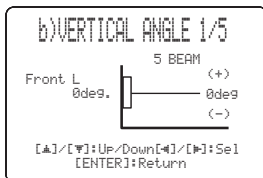

Note

A test tone is automatically output.

BEAM TRAVEL LENGTH (Beam travel length)

Use to set the distance that sound beams travel after being output and reflected off the wall until they arrive at the listening position for each speaker.

The lines in the illustration below indicate the distance.

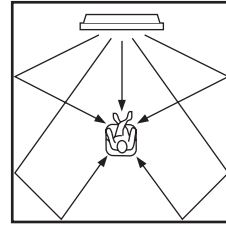

Choices: 0.3 m to 24.0 m

- **Front L** adjusts the distance the front left speaker sound beams travel.
- **Front R** adjusts the distance the front right speaker sound beams travel.
- **Center** adjusts the distance the center speaker sound beams travel.
- **Surround L** adjusts the distance the surround left speaker sound beams travel.
- **Surround R** adjusts the distance the surround right speaker sound beams travel.

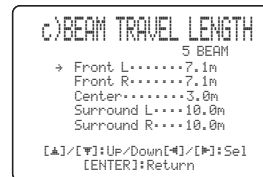

FOCAL LENGTH (Focal length)

Use to set the distance from the front of this unit to the focal point of output for each speaker.

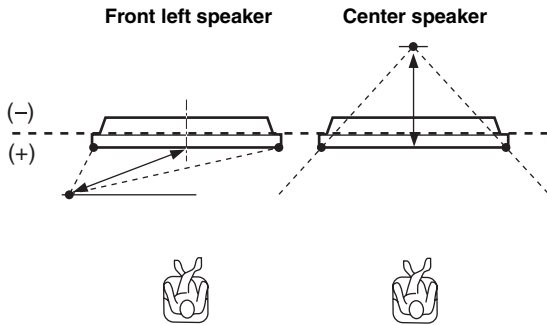

Choices: -1.0 m to +13.0 m

Adjust towards - (minus) to move the focus outward and adjust towards + (plus) to move the focus towards the normal position.

- **Front L** adjusts the focal length for the front left sound beams.
- **Front R** adjusts the focal length for the front right sound beams.
- **Center** adjusts the focal length for the center sound beams. Initial setting: -0.5 m
- **Surround L** adjusts the focal length for the surround left sound beams.
- **Surround R** adjusts the focal length for the surround right sound beams.



We recommend that you use the initial setting (-0.5 m) for the center speaker.

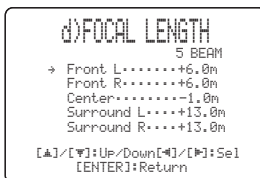

TREBLE GAIN (Treble gain)

Use to adjust the high frequency output level of each speaker.



If the reflection point of the front left and right or surround left and right sound beams is a curtain or other acoustically absorbent surface, you can achieve more effective surround sound by increasing the treble level for those sound beams.

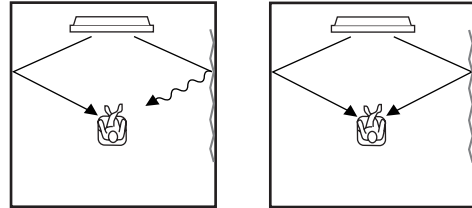

Choices: -12.0 dB to +12.0 dB

Initial setting: 0 dB

- **FL** adjusts the high frequency output level of the front left speaker.
- **FR** adjusts the high frequency output level of the front right speaker.
- **C** adjusts the high frequency output level of the center speaker.
- **SL** adjusts the high frequency output level of the surround left speaker.
- **SR** adjusts the high frequency output level of the surround right speaker.

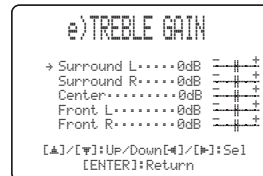

■ BEAM LEVEL (Beam level)

Use to manually balance the speaker levels between the front left or surround left speakers and each speaker selected.

When setting the front right, center or surround left speakers or the subwoofer, the test tone is output from the front left speakers and the selected speaker position.

When setting the surround right speaker, the test tone is output alternately from the surround left and right speakers.

The factory default value is automatically set for this parameter depending on the parameters set in AUTO SETUP, BASIC SETUP or ROOM EQ in MANUAL SETUP.

Depending on the beam mode settings, some channels may not be available for selection. In this case, NONE is displayed.

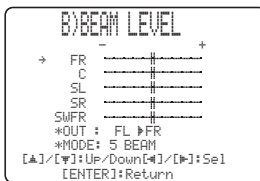

- **FR** adjusts the balance of the front left and front right speakers.
- **C** adjusts the balance of the front left and center speakers.
- **SL** adjusts the balance of the front left and surround left speakers.
- **SR** adjusts the balance of the surround left and surround right speakers.
- **SWFR** adjusts the balance of the front left speaker and subwoofer.

■ SUBWOOFER SET (Subwoofer set)

Use to manually adjust various subwoofer settings.

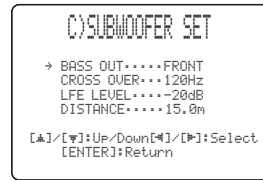

BASS OUT (Bass out)

Low-frequency (bass) signals can be directed to the subwoofer or the front left and right speaker positions.

This setting also determines the routing of LFE (low-frequency effect) signals found in Dolby Digital or DTS sources.

Choices: SWFR (subwoofer), **FRONT**

- Select SWFR if you connect a subwoofer. LFE and low-frequency signals from other channels are directed to the subwoofer according to the speaker settings.
- Select FRONT if you do not use a subwoofer. LFE and low-frequency signals from other channels are directed to the front speakers according to the speaker settings (even if you have previously set the front speakers to SMALL).

CROSS OVER (Cross over)

When BASS OUT is set to SWFR, you can use this feature to select a cross-over (cut-off) frequency for all low-frequency signals. All frequencies below the selected frequency will be sent to the subwoofer speaker position.

Choices: 80Hz, **100Hz**, 120Hz

LFE LEVEL (Low-frequency effect level)

Select to adjust the output level of the LFE (low-frequency effect) channel according to the capacity of your subwoofer. The LFE channel carries low-frequency special effects which are only added to certain scenes.

This setting is effective only when this unit decodes Dolby Digital or DTS signals.

Choices: -20 to **0** dB

DISTANCE (Distance)

Select to adjust the distance of the subwoofer from the listening position.

Choices: 0.3 to 15.0 m

Initial setting: 3.0 m

■ MUTE LEVEL (Muting level)

Use to adjust how much the mute function reduces the volume level.

Choices: **MUTE**, -20 dB

- Select MUTE to completely halt all sound output.
- Select -20 dB to reduce the current volume level by 20 dB.



■ AUDIO DELAY (Audio delay)

Use to delay the sound output and synchronize it with the video image. This may be necessary when using certain LCD monitors or projectors.

Choices: **0** to 160 msec



■ ROOM EQ (Room equalizer)

Use to change the tonal qualities of your listening room when the unit is mounted on the wall.

Choices: MOUNT (Mount),
 REFLECTING (Reflectivity type)

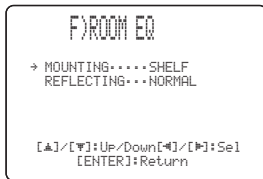

MOUNT (Mount)

Use to enhance medium to low range sounds.

Choices: WALL (Wall mount), SHELF (Shelf mount)

- Select WALL if this unit is mounted on the wall in your listening room.
- Select SHELF if this unit is mounted on the shelf in your listening room.

REFLECTING (Reflectivity type)

Use to select the reflectivity of your listening room.

Choices: NORMAL (Normal), HI ECHO (High echo)

- Select NORMAL if your listening room has a normal reflectivity.
- Select HI ECHO if your listening room has highly reflective surfaces such as concrete walls.

■ DD/DTS Dynamic Range (Dynamic range of Dolby Digital and DTS signals)

Use to select the amount of dynamic range compression to be applied to the speakers. This setting is effective only when the unit is decoding Dolby Digital and DTS signals. Dynamic range is the difference between the smallest sound that can be heard above the noise of the equipment and the biggest sound that can be heard without distortion.

Choices: MIN (minimum), STD (standard),
MAX (maximum)



Select to adjust the speaker compression.

- Select MIN for listening to sources at low volume levels.
- Select STD for general use.
- Select MAX for feature films.

INPUT MENU

Use to manually adjust various parameters related to the audio and video input.

SET MENU → MANUAL SETUP → INPUT MENU

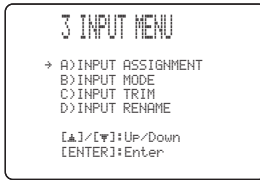

■ INPUT ASSIGNMENT (Input assignment)

Use to assign the optical and coaxial digital input jacks of this unit to other components if the initial settings of this unit do not correspond to your needs. By assigning other components to the input jacks on this unit, you can display the name of the connected component in the front panel display and OSD, and operate the component with the input selector button of the same name. If you connect a component to the input jacks of this unit and do not assign it, the default component name for that input jack is displayed in the front panel and OSD when selected.

- Select OPTICAL IN (1) to assign components to the TV/STB OPTICAL DIGITAL IN jack of this unit. Choices: **TV**, VCR
- Select OPTICAL IN (2) to assign components to the AUX OPTICAL DIGITAL IN jack of this unit. Choices: **AUX**, DVD

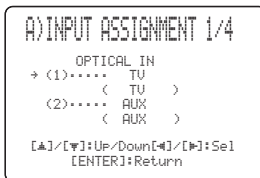

- Select COAX IN (3) to assign components to the DVD COAXIAL DIGITAL IN jack of this unit. Choices: **DVD**, AUX

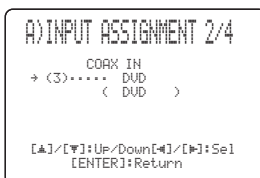

- Select COMPONENT (1) to assign components to the STB COMPONENT VIDEO IN jacks of this unit. Choices: **TV**, VCR
- Select COMPONENT (2) to assign components to the DVD/AUX COMPONENT VIDEO IN jacks of this unit. Choices: **DVD**, AUX

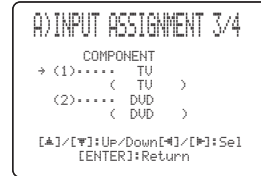

- Select COMPOSITE (3) to assign components to the DVD/AUX VIDEO IN jack of this unit. Choices: **AUX**, DVD

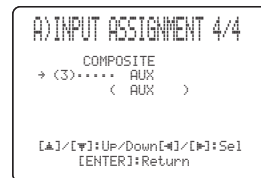

■ INPUT MODE (Input mode)

Use to designate the input mode for the input sources connected to the DIGITAL INPUT jacks when you turn on the power of this unit. For information on the types of audio signals that can be output by this unit, see “Surround modes and recommended sources” on page 46.

Choices: **AUTO**, LAST



- Select AUTO to allow this unit to automatically detect the type of input signal and select the appropriate input mode.
- Select LAST to set this unit to automatically select the last input mode used for that input source. If the type of input signal is different from the setting, no sounds will be produced.

■ INPUT TRIM (Input trim)

Use to adjust the input level of the input source.

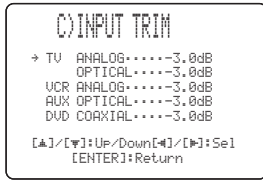

- Select TV ANALOG to adjust the level of audio and video signals input at the TV/STB analog audio input jacks of this unit.
Control range: -6.0 dB to 0.0 dB
Initial setting: -3.0 dB
- Select TV OPTICAL to adjust the level of audio and video signals input at the TV OPTICAL IN jack of this unit.
Control range: -6.0 dB to 0.0 dB
Initial setting: -3.0 dB
- Select VCR ANALOG to adjust the level of audio and video signals input at the VCR analog audio input jacks of this unit.
Control range: -6.0 dB to 0.0 dB
Initial setting: -3.0 dB
- Select AUX OPTICAL to adjust the level of audio and video signals input at the AUX OPTICAL IN jack of this unit.
Control range: -6.0 dB to 0.0 dB
Initial setting: -3.0 dB
- Select DVD COAXIAL to adjust the level of audio and video signals input at the COAXIAL IN jack of this unit.
Control range: -6.0 dB to 0.0 dB
Initial setting: -3.0 dB

■ INPUT RENAME (Input rename)

Use to change the name of the input source in the OSD and the front panel display. Press an input selector button (TV, STB, DVD, VCR, or AUX) to select the component you want to change the name for and then perform the following procedure.



1 Press TEST on the remote control.



2 Press ◀/▶ to place the _ (underbar) under the space or the character you want to edit.

The _ (underbar) flashes.

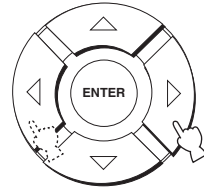

3 Press ▲ / ▼ to select the desired character.

- You can use up to 8 characters for each input.
- Press ▲ to change the character in the following order or press ▼ to go in the reverse order:
A to Z, a space, 0 to 9, a space, a to z, a space, #, *, +, etc.

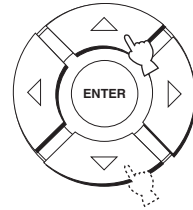

4 Repeat steps 1 to 3 to rename each input.

5 Press ENTER to exit.

The new names are registered, and the display returns to the previous screen.

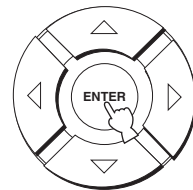

DISPLAY MENU

Use to manually adjust various parameters related to the display.

SET MENU → MANUAL SETUP → OPTION MENU



■ DIMMER SET (Dimmer settings)

Use to adjust the brightness of the front panel display.

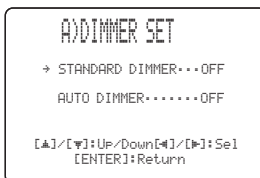

STANDARD DIMMER (Standard dimmer)

Use to adjust the brightness of the front panel display when you operate this unit by using the control buttons on the front panel or on the remote control.

Choices: **-2**, -1, OFF

AUTO DIMMER (Auto dimmer)

If no operation is performed for a specified period, the front panel display dims. Use to adjust the brightness of the front panel display in this case.

Choices: DISPLAY OFF, -3 to -1 (based on the STANDARD DIMMER setting), **OFF**

■ OSD SET (OSD settings)

Use to adjust the display position and the background color of the OSD.

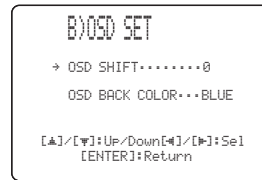

OSD SHIFT (OSD shift)

Use to adjust the vertical position of the OSD. Adjust towards the - (minus) direction to raise the position of the OSD, and adjust towards the + (plus) direction to lower it. Choices: -5 to +5

Initial setting: 0

OSD BACK COLOR (OSD background color)

Use to select the background color of the OSD.

Choices: **BLUE**, GRAY

■ UNIT SET (Unit settings) (U.S.A. and Canada models only)

Use this to change the display unit of measurement.

Choices: METERS, **FEET**



- Select METERS to input speaker distances in meters.
- Select FEET to input speaker distances in feet.

ADJUSTING SYSTEM PARAMETERS

Setting the maximum volume level

You can set the maximum volume level so that this unit will not output sound beyond the limited volume level.

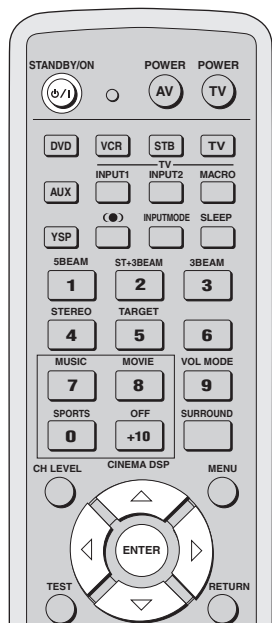
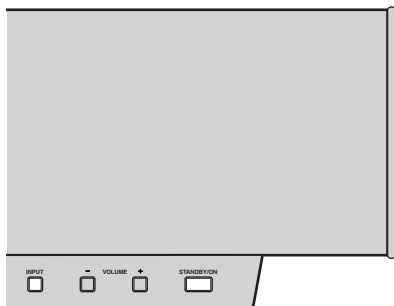

- 1 Press **STANDBY/ON** on the front panel or on the remote control to turn off the power of this unit.



Front panel

or



Remote control

- 2 Press and hold **INPUT** on the front panel and then press **STANDBY/ON** on the front panel to turn on the power of this unit.

MAX VOLUME SET is shown in the front panel display.

INPUT



STANDBY/ON

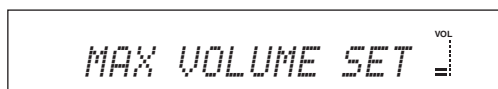

- 3 Release **INPUT** on the front panel.

INPUT

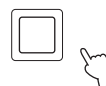

- 4 Press **ENTER** on the remote control.

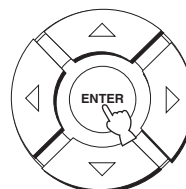

- 5** Press $\triangle / \triangleright$ to adjust the maximum volume level.

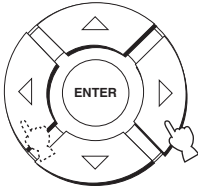

Control range: 0 dB to -99.0 dB
Control step: 1 dB

- 6** Press **STANDBY/ON** on the front panel or on the remote control to set this unit to the standby mode.



Front panel

or



Remote control

The new setting for the maximum volume level will be activated when you turn on the power of this unit next time.

Protecting the current settings

You can protect the settings currently saved in the system memory from being accidentally erased or unwantedly changed.

- 1** Repeat steps 1 to 3 in “Setting the maximum volume level” on page 80.
- 2** Press $\triangle / \triangleright$ on the remote control so that **MEMORY PROTECT** is shown in the front panel display.

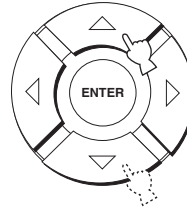

- 3** Press **ENTER**.

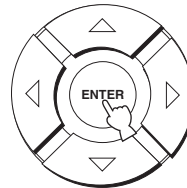

- 4 Press ◀ / ▶ to switch between PROTECT: ON and PROTECT: OFF.

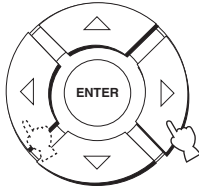

- Select PROTECT: ON to activate the protection feature.
- Select PROTECT: OFF to deactivate the protection feature.

- 5 Press STANDBY/ON on the front panel or on the remote control to set this unit to the standby mode.



Front panel

or



Remote control

The new setting will be activated when you turn on the power of this unit next time.

Initializing the current settings

You can reset all of the parameters of this unit to the factory presets. This procedure completely resets ALL the parameters in SET MENU.

Note

After performing the following procedure you must reset the ROOM TYPE, SP POSITION and ROOM SIZE parameters to match your surround sound environment.

- 1 Repeat steps 1 to 3 in “Setting the maximum volume level” on page 80.

- 2 Press ▲ / ▼ on the remote control so that FACTORY PRESET is shown in the front panel display.

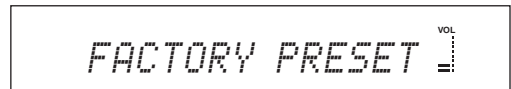
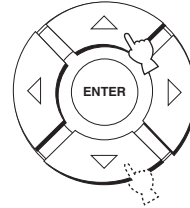

- 3 Press ENTER.

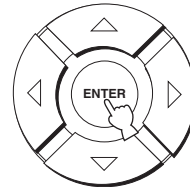

- 4 Press / to switch between PRESET: RESET and PRESET: CANCEL.

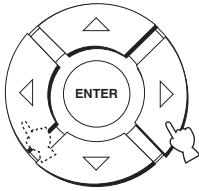

- Select PRESET: RESET to reset all of the current settings.
- Select PRESET: CANCEL to cancel the resetting procedure.

- 5 Press **STANDBY/ON** on the front panel or on the remote control to set this unit to the standby mode.



Front panel

or



Remote control

The new setting will be activated when you turn on the power of this unit next time.

Adjusting the audio balance

You can adjust the sound beam output level of each speaker by using the test tone or the audio output being played back in each beam mode to achieve a more true-to-life surround sound experience.



If the level of a particular speaker cannot be adjusted, “- dB” appears in the front panel display.

Using the test tone

You can use the test tone feature to output a test tone from each speaker to manually balance the speaker levels. Use the test tone to set speaker levels so that the volume level of each speaker is identical when heard from your listening position.

Notes

- All the speaker levels cannot be adjusted when the stereo mode or the target mode is selected as the beam mode (see page 44).
- FRONT L/R cannot be adjusted when the stereo plus 3 mode is selected as the beam mode (see page 43).

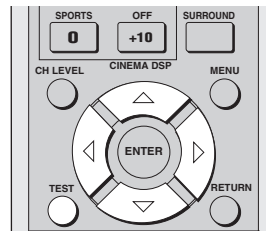

- 1 Press **TEST** on the remote control.

TEST LEFT appears in the front panel display and a test tone is output from the front left speaker.



2 Press \triangle / ∇ to select the speaker you want to adjust.

The front panel display changes as follows.

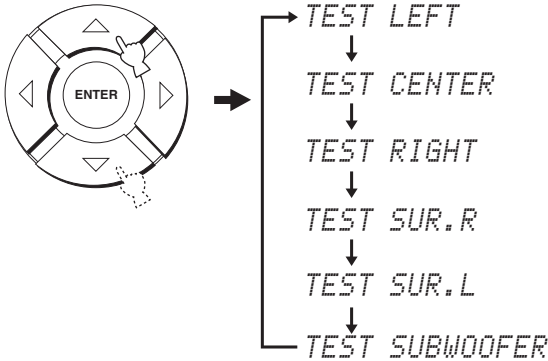

Note

TEST SUBWOOFER is only available when a subwoofer is connected to this unit and SWFR is selected for BASS OUT in SOUND MENU (see page 75).

3 Press \triangle / ∇ to adjust speaker volumes.

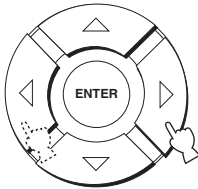

Control range: -10 dB to +10 dB

4 Press VOLUME +/- on the remote control to adjust the volume level of this unit.

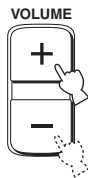

5 Press TEST when you have completed all your adjustments.



To adjust the output level of your subwoofer, set BASS OUT to BOTH or SWFR (page 75).

Using the audio output being played back

You can also manually adjust the speaker levels while playing back an input source such as a DVD.

Notes

- All the speaker levels cannot be adjusted when the stereo mode is selected as the beam mode (see page 44).
- FRONT L/R cannot be adjusted when the stereo plus 3 mode is selected as the beam mode (see page 43).
- Only CENTER can be adjusted when the target mode is selected as the beam mode (see page 45).

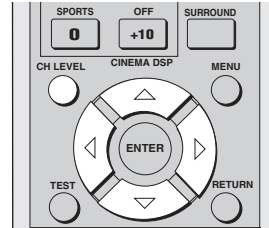

1 Press CH LEVEL repeatedly (or press CH LEVEL and then \triangle / ∇) to select the speaker you want to adjust.

The front panel display changes as follows.

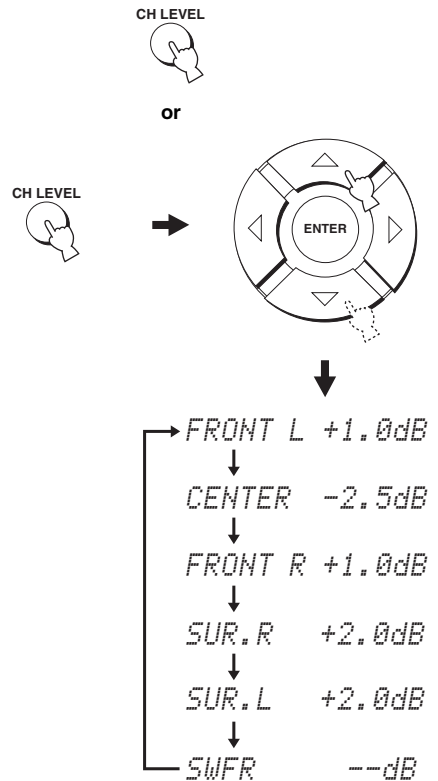

-
- 2** Press ◀/▶ to adjust speaker volumes.

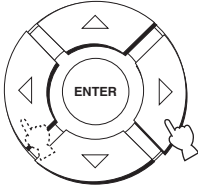

Control range: -10 dB to +10 dB

-
- 3** Press CH LEVEL (or wait for a few seconds without operating this unit) when you have completed your adjustment.



SELECTING THE INPUT MODE

You can select the type of audio input signals of the selected input source according to your preference or the conditions of the input source.



We recommend setting the input mode to AUTO in most cases.

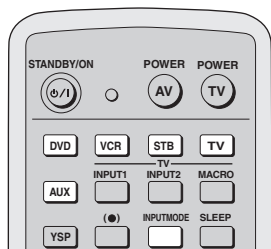

- 1 Press one of the input selector buttons on the remote control to select the desired input source.

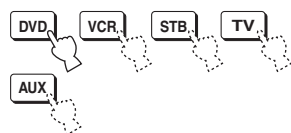

- 2 Press INPUTMODE on the remote control repeatedly to toggle between input modes.

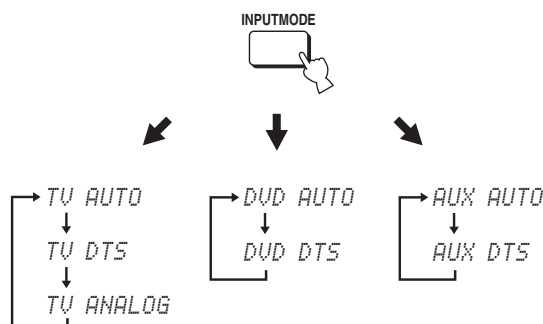

When TV or STB is selected as the input source

When DVD is selected as the input source

When AUX is selected as the input source

- **AUTO**

Automatically selects audio input signals in the following priority order:

- 1) Dolby Digital or DTS
- 2) PCM
- 3) Analog

Use this input mode in most cases.

- **DTS**

Selects only digital signals encoded in DTS.

Compared to AUTO, this input mode provides greater stability while playing back CDs or LDs encoded in DTS.

- **ANALOG**

Selects only analog signals.

Even when both digital and analog signals are input simultaneously, only analog signals are selected.

Notes

- When the input mode is set to AUTO, this unit automatically plays back multi-channel sources in the selected input mode.
- ANALOG cannot be selected as an input mode if analog signals are not being input from the selected input source.



You can adjust the default input mode to be selected when the power of this unit is turned on (see page 77).

Notes

- The input mode of VCR is fixed to ANALOG. However, if the TV OPTICAL IN jack of this unit is assigned to VCR, AUTO, DTS and ANALOG become available as the input mode of VCR (see page 77).
- ANALOG is not available as the input mode of DVD and AUX.

REMOTE CONTROL FEATURES

In addition to controlling this unit, the remote control can also operate other A/V components made by YAMAHA and other manufacturers. To control other components, you must set up the remote control with the appropriate remote control codes.

Note

Depending on the external A/V component you are using, you may not be able to operate the component with the remote control, even if a remote control code is set. In this case, operate the component using the supplied remote control.

Setting remote control codes

You can control other components by setting the appropriate remote control codes. Codes can be set up for each input area (TV, STB, DVD, VCR and AUX). For a complete list of available remote control codes, refer to “LIST OF REMOTE CONTROL CODES” at the end of this manual.

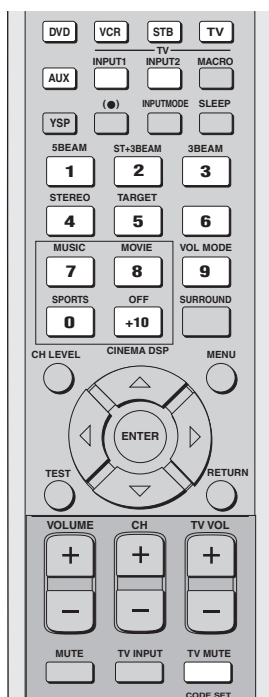

- 1 While holding down CODE SET, press the input selector button for the component you want to set up and then without releasing CODE SET, enter the remote control code using the numeric buttons.**

The following illustrations show an example of setting the remote control code for a DVD player made by YAMAHA.

Setting example: YAMAHA DVD input area

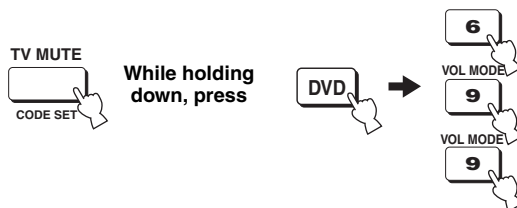

- 2 Refer to “Controlling other components” on page 88 to operate the external component using the remote control.**

If the external component functions correctly, the remote control code setup was successful. If the external component does not function correctly, the remote control code may be incorrect. Confirm that the remote control code is correct (see “LIST OF REMOTE CONTROL CODES” at the end of this manual) and start over from step 1.

Note

If the manufacturer of your component has more than one code, try each of them until you find the correct one.

If the remote control is without batteries for more than 2 minutes, or if exhausted batteries remain in the remote control, the contents of the memory may be cleared. When the memory is cleared, insert new batteries and reset the remote control codes. When changing the batteries, be careful not to press any of the buttons on the remote control. Doing so will clear the contents of the memory.

Controlling other components

■ Operating your TV

Press TV to select TV as the input source.

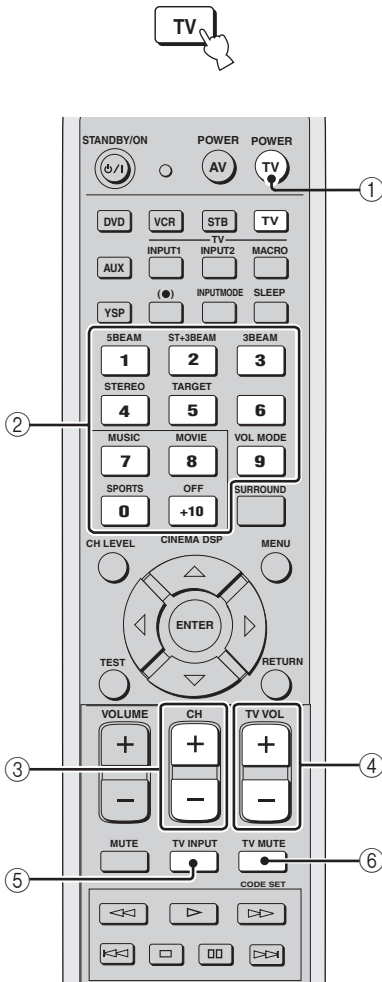

① **TV POWER**

Turns on or off the power of your TV.

② **Numeric buttons**

Selects a TV channel for playback.

③ **CH +/-**

Switches between the available TV channels.

④ **TV VOL +/-**

Adjusts the audio output level of the TV.

⑤ **TV MUTE**

Temporarily mutes audio output from the TV.

⑥ **TV INPUT**

Switches the input source for the TV.

■ Operating your DVD player

Press DVD to select DVD as the input source.

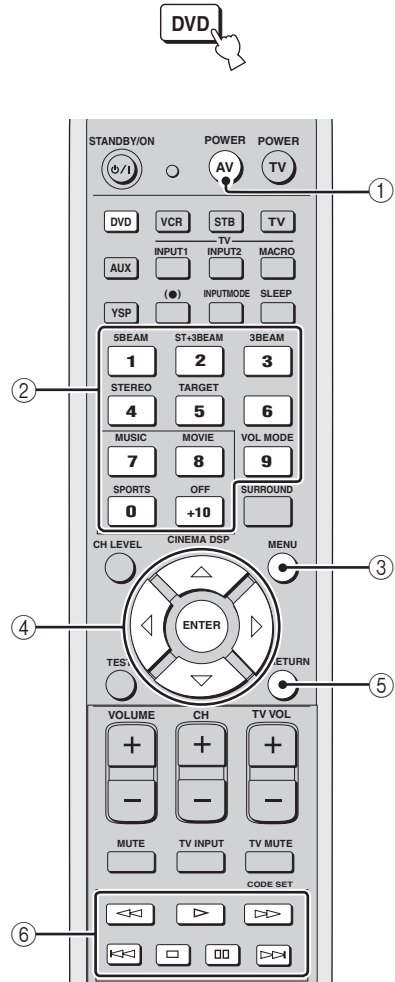

① **AV POWER**

Turns on or off the power of your DVD player.

② **Numeric buttons**

Use to enter numeric digits.

③ **Operation buttons for DVD and VCR players**

Use to perform DVD player operations, such as play and stop.

④ **MENU**

Displays the DVD menu.

⑤ **Cursor buttons**

Use to select DVD menu items.

⑥ **RETURN**

Use to return to the previous DVD menu screen or exit the DVD menu.

■ Operating your VCR player

Press VCR to select VCR as the input source.



Press YSP on the remote control to return to the operation mode of this unit.

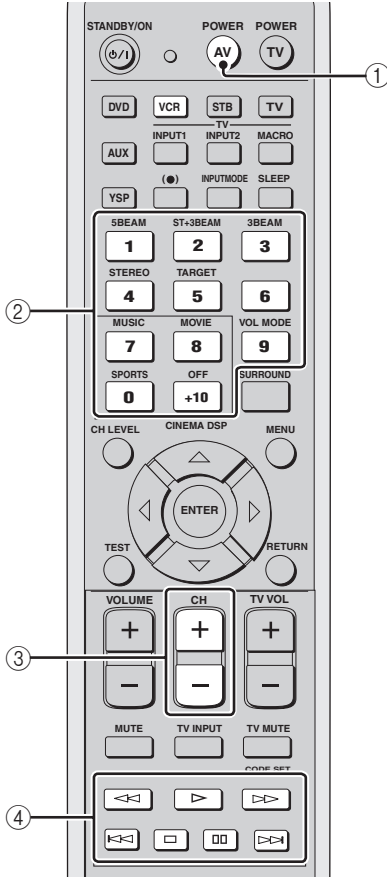

① AV POWER

Turns on or off the power of your VCR.

② Numeric buttons

Use to enter numeric digits.

③ CH +/-

Switches between the available VCR channels.

④ Operation buttons for DVD and VCR players

Use to perform VCR player operations, such as play and stop.

Using the TV macro

The TV macro feature makes it possible to perform a series of operations with the press of a single button. For example, when you want to play a DVD, you would normally turn on the component, select DVD as the input source and press the play button to start playback. The TV macro feature lets you perform all of these operations simply by pressing the DVD macro button.

Notes

- The ways to set macros differ if your TV does not have the tuning capability.
- If you press any control buttons on the remote control other than the ones used to set macros while setting macros, the setting procedure is automatically canceled.
- If it takes more than 10 seconds in steps 2 and 3, the setting procedure is automatically canceled. In this case, repeat from step 1.

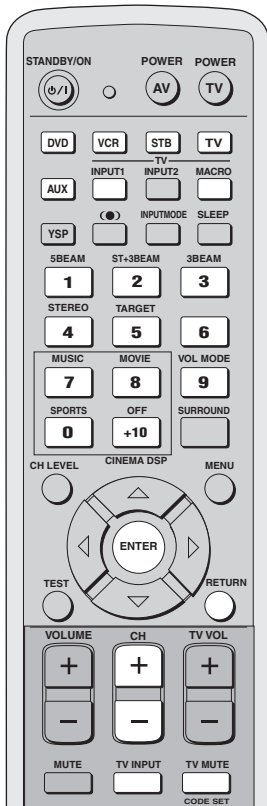

Setting macros for the TV with the tuning capability

- 1 Press and hold CODE SET on the remote control and then press one of the input selector buttons to select the input source you want to set macros for.**

Proceed to step 2 while holding down CODE SET.



- 2 Press MACRO on the remote control while holding down CODE SET.**



- 3 Press CH +/- or the numeric buttons to select the TV channel.**

Check that the TV screen changes to the tuner screen.

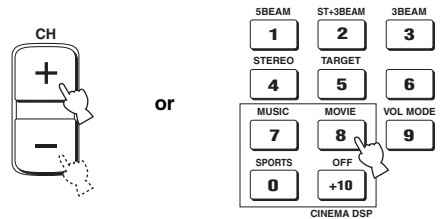

- 4 Press TV INPUT on the remote control repeatedly so that the screen changes to the display of the input source selected in step 1.**



- 5 Press ENTER on the remote control to confirm the macro setting.**

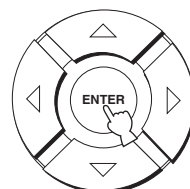

■ **Setting macros for the TV without the tuning capability**

- 1 Press and hold **CODE SET** on the remote control and then press one of the input selector buttons to select the input source you want to set macros for.

Proceed to step 2 while holding down **CODE SET**.

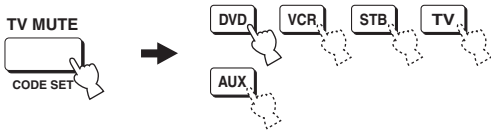

- 2 Press **MACRO** on the remote control while holding down **CODE SET**.



- 3 Press **INPUT1** on the remote control.



- 4 Press **CH +/-** or **TV INPUT** on the remote control repeatedly so that the screen changes to the display of the input source selected in step 1.

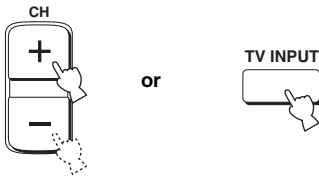

- 5 Press **ENTER** on the remote control to confirm the setting.

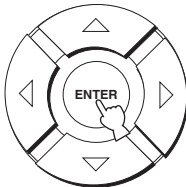

■ **Operating macros**

- 1 Press and hold one of the input selector buttons for approximately 2 seconds to select the input source you want to operate macros for.

The TV input changes at the same time the input mode changes.

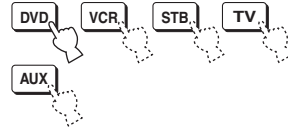

■ **Canceling the macros**

- 1 Press and hold **CODE SET** on the remote control and then press one of the input selector buttons to select the input source you want to cancel the macros for.

Proceed to step 2 while holding down **CODE SET**.

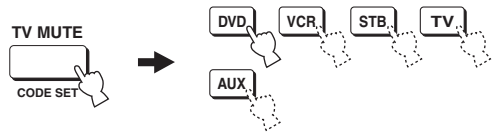

- 2 Press **MACRO** on the remote control while holding down **CODE SET**.



- 3 Press **ENTER** on the remote control to cancel the macros.

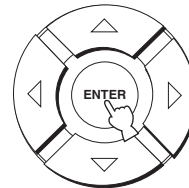

TROUBLESHOOTING

Refer to the chart below when this unit does not function properly. If the problem you are experiencing is not listed below or if the instruction below does not help, set this unit to the standby mode, disconnect the power cord and contact the nearest authorized YAMAHA dealer or service center.

■ General

Problem	Cause	Remedy	See page
This unit fails to turn on when STANDBY/ON is pressed, or enters the standby mode soon after the power has been turned on.	The power supply cable is not firmly connected to the AC wall outlet or to the AC inlet on the rear panel of this unit.	Connect the power supply cable firmly to the AC wall outlet or to the AC inlet on the rear panel of this unit.	23
	This unit has been exposed to a strong external electric shock (such as lightning and strong static electricity).	Set this unit to the standby mode, disconnect the power supply cable, plug it back in after 30 seconds, then use it normally.	—
This unit suddenly enters the standby mode.	The internal temperature becomes too high and the overheat protection circuitry has been activated.	Wait about 1 hour for this unit to cool down and then turn it back on.	—
	The sleep timer has turned the unit off.	Turn on the power, and play the source again.	—
No sound.	Incorrect input or output cable connections.	Connect the cables properly. If the problem persists, the cables may be defective.	15
	No appropriate input source has been selected.	Select an appropriate input source with INPUT or the input selector buttons.	39
	The volume is turned down.	Turn up the volume.	40
	The sound is muted.	Press MUTE or VOLUME +/- on the remote control to resume audio output and then adjust the volume level.	41
	Signals this unit cannot reproduce (such as PCM signals with more than 96 kHz of sampling frequency) are being received from source component.	Play a source whose signals can be reproduced by this unit.	—
Change the system settings of the source component.		—	
The sound suddenly goes off.	The sleep timer has turned the unit off.	Turn on the power, and play the source again.	—
	The sound is muted.	Press MUTE or VOLUME +/- on the remote control to resume audio output and then adjust the volume level.	41
No sound from the effect speakers.	You are playing back the source or program in the stereo mode.	Press one of the beam mode buttons on the remote control to select a multi-channel playback mode and then try to play back the source or program once more.	42
No sound from the center speaker.	The output level of the center speaker is set to minimum.	Raise the level of the center speaker.	83
No sound from the surround speakers.	The output level of the surround speakers is set to minimum.	Raise the output level of the surround speakers.	83
No sound from the subwoofer.	BASS OUT in SUBWOOFER SET is set to FRONT.	Select SWFR or BOTH.	75
	The source does not contain low bass signals.		

Problem	Cause	Remedy	See page
Distorted or too little bass sound	CROSS OVER in SUBWOOFER SET is set incorrectly.	Set CROSS OVER correctly.	75
	One of the night listening modes is currently selected.	Turn off the night listening modes.	56
Too much bass sound	TruBass is currently turned on.	Turn off TruBass.	58
	The volume level of the subwoofer is too high.	Turn down the volume level of the subwoofer.	—
Surround sound effects are insubstantial.	The listening room is not a regular shape.	Install this unit in a square or rectangular shaped room.	—
	There is no wall in the path of the sound beam.	Try placing a flat object, such as a board, in the path of the sound beam.	—
Dolby Digital or DTS sources cannot be played. (Dolby Digital or DTS indicator does not light up in the front panel display.)	The connected component is not set to output Dolby Digital or DTS digital signals.	Make an appropriate setting following the operating instructions for your component.	—
	The input mode is set to ANALOG.	Set the input mode to AUTO.	86
There is noise interference when a subwoofer is not connected to this unit.	The protection circuitry was in operation because a source with strong bass elements was played back.	Turn down the volume level.	40
		Select SWFR for BASS OUT.	75
		Connect a subwoofer and adjust settings for SUBWOOFER SET.	75
On-screen display does not appear.	The VIDEO OUT (composite) jack of this unit is not connected to the video input jacks of your TV.	Connect the VIDEO OUT (composite) jack of this unit to the video input jacks of your TV. The OSD is not output at the COMPONENT VIDEO OUT jacks.	16
	The video pin cable is not connected properly.	Connect the cable properly.	16
	TV is not selected as the input source.	Select TV as the input source.	39
No picture is displayed for external components, such as a DVD player.	The video cable is not connected properly.	Connect the cable properly.	16
	TV is not selected as the input source.	Select TV as the input source.	39
This unit does not operate properly.	The internal microcomputer has been frozen by an external electric shock (such as lightning or excessive static electricity) or by a power supply with low voltage.	Disconnect the AC power supply cable from the outlet and then plug it in again after about 30 seconds.	—
There is noise interference from digital or high-frequency equipment.	This unit is too close to the digital or high-frequency equipment.	Move this unit further away from such equipment.	—
This unit does not output effect sounds properly.	The original source includes surround effects.	Disable surround effect settings on this unit.	—

■ Remote control

Problem	Cause	Remedy	See page
The remote control does not work and/or function properly.	Wrong distance or angle.	The remote control will function within a maximum range of 6 m and no more than 30 degrees off-axis from the front panel.	24
	Direct sunlight or lighting (from an inverter type of fluorescent lamp, etc.) is striking the remote control sensor of this unit.	Reposition this unit.	—
	The batteries are weak.	Replace all batteries.	24
You cannot operate external components with this unit's remote control.	The external component you want to operate is not selected as the input source.	Press INPUT on the front panel or the input selector buttons on the remote control to select the external component you want to operate.	39
	The remote control code was not correctly set.	Set the remote control code correctly or try another code for the same manufacturer using the "LIST OF REMOTE CONTROL CODES" at the end of this manual.	87
	Even if the remote control code is correctly set, there are some models that do not respond to the remote control.	Use the remote control supplied with the external component.	—
The cursor buttons do not work during SET MENU operation.	You pressed an input selector button.	Press TEST once.	—

GLOSSARY

Audio formats

■ Dolby Digital

Dolby Digital is a digital surround sound system that gives you completely independent multi-channel audio. With 3 front channels (left, center, and right), and 2 surround stereo channels, Dolby Digital provides 5 full-range audio channels. With an additional channel especially for bass effects, called LFE (low frequency effect), the system has a total of 5.1-channels (LFE is counted as 0.1 channel). By using 2-channel stereo for the surround speakers, more accurate moving sound effects and surround sound environment are possible than with Dolby Surround. The wide dynamic range (from maximum to minimum volume) reproduced by the 5 full-range channels and the precise sound orientation generated using digital sound processing provide listeners with previously unheard of excitement and realism.

With this unit, any sound environment from monaural up to a 5.1-channel configuration can be freely selected for your enjoyment.

■ Dolby Pro Logic II

Dolby Pro Logic II is an improved technique used to decode vast numbers of existing Dolby Surround software. This new technology enables a discrete 5-channel playback with 2 front left and right channels, 1 center channel, and 2 surround left and right channels (instead of only 1 surround channel for conventional Pro Logic technology). Music and Game modes are also available for 2-channel sources in addition to the Movie mode.

■ Dolby Surround

Dolby Surround uses a 4 channel analog recording system to reproduce realistic and dynamic sound effects: 2 front left and right channels (stereo), a center channel for dialog (monaural), and a surround channel for special sound effects (monaural). The surround channel reproduces sound within a narrow frequency range.

Dolby Surround is widely used with nearly all video tapes and laser discs, and in many TV and cable broadcasts as well. The Dolby Pro Logic decoder built into this unit employs a digital signal processing system that automatically stabilizes the volume on each channel to enhance moving sound effects and directionality.

■ DTS (Digital Theater Systems) Digital Surround

DTS digital surround was developed to replace the analog soundtracks of movies with a 6-channel digital sound track, and is now rapidly gaining popularity in movie theaters around the world. Digital Theater Systems Inc. has developed a home theater system so that you can enjoy the depth of sound and natural spatial representation of DTS digital surround in your home. This system produces practically distortion-free 6-channel sound (technically, a left, right and center channels, 2 surround channels, plus an LFE 0.1 channel as a subwoofer, for a total of 5.1-channels). The unit incorporates a DTS-ES decoder that enables 6.1-channel reproduction by adding the surround back channel to existing 5.1-channel format.

■ Neo:6

Neo:6 decodes the conventional 2-channel sources for 6 channel playback by the specific decoder. It enables playback with the full-range channels with higher separation just like digital discrete signal playback. Two modes are available; Music mode for playing music sources and Cinema mode for movies.

■ PCM (Linear PCM)

Linear PCM is a signal format under which an analog audio signal is digitized, recorded and transmitted without using any compression. This is used as a method of recording CDs and DVD audio. The PCM system uses a technique for sampling the size of the analog signal per very small unit of time. Standing for pulse code modulation, the analog signal is encoded as pulses and then modulated for recording.

Audio information

■ LFE 0.1 channel

This channel is for the reproduction of low bass signals. The frequency range for this channel is 20 Hz to 120 Hz. This channel is counted as 0.1 because it only enforces a low frequency range compared to the full-range reproduced by the other 5/6 channels in Dolby Digital or DTS 5.1/6.1-channel systems.

INDEX

A

Audio pin cable..... 16 to 19
AUTO SETUP 28

B

BASIC SETUP 62
Beam modes 42

C

Cable clamp..... 23
Cardboard microphone stand..... 30
Coaxial digital output jack 8
Coaxial digital input jack 8

D

Digital audio pin cable..... 17
Display..... 7, 26
Dolby Digital 46
Dolby Pro Logic 46
Dolby Pro Logic II..... 46
DTS 46
DTS Neo:6..... 46
Dynamic range..... 76

F

Fastener..... 14
Front panel display 7

L

LFE 0.1 channel..... 75, 95

M

MANUAL SETUP 68
MEMORY 36, 37

N

Night listening modes..... 56

O

On-screen display (OSD)..... 26
Optical cable 16, 19, 21
Optimizer microphone 29

P

PCM..... 86
Power supply cable 23

R

Remote control..... 9, 24
Remote control code 87

S

Surround mode..... 46
Sleep timer 60
SET MENU 26
Sound field program 51

T

Test tone..... 83
TruBass 58
TV macro 90

V

Video pin cable 16
Volume mode 56

SPECIFICATIONS

AMP SECTION

- Maximum Output Power (EIAJ)
 -2 W (1 kHz, 10% THD, 4 Ω) × 40
 -20 W (100 Hz, 10% THD, 3 Ω) × 2

SPEAKER SECTION

- Small dia. speakers4 cm cone magnetic shielding type × 40
- Woofers10 cm cone magnetic shielding type × 2
- Input Jacks
 - AUDIO VCR, TV/STB (Analog) (1 V, 32 kΩ) ... 2 pairs (Analog)
 - AUDIO AUX, TV/STB (Optical) 2 (Digital)
 - AUDIO DVD (Coaxial) 1 (Digital)
 - COMPOSITE VIDEO, VCR, DVD/AUX, STB 3
 - COMPONENT VIDEO, DVD/AUX, STB 2 pairs
- Output Jacks
 - SUBWOOFER (1.5 V, less than 120 Hz) 1 (Subwoofer)
 - VIDEO (1 Vp-p, 75 Ω) 1 (Composite)
 - COMPONENT VIDEO (Y: 1 Vp-p, 75 Ω
Pb/Pr: 0.5 Vp-p, 75 Ω) 1
- System Connector Jacks
 - OPTIMIZER MIC 1 (Microphone input)
 - RS-232C 1 (System control)
 - REMOTE IN 1 (System control)
 - IR-OUT 1 (System control)

GENERAL

- Power supply
 - [U.S.A. and Canada models] AC 120 V, 60 Hz
 - [Australia model] AC 240 V, 50 Hz
 - [U.K. and Europe models] AC 230 V, 50 Hz
 - [China model] AC 220 V, 50 Hz
 - [Korea model] AC 220 V, 60 Hz
 - [General model] AC 110–120 V, 50/60 Hz
 - [Asia model] AC 220–240 V, 50/60 Hz
- Power Consumption 50 W
- Standby Power Consumption 0.1 W or less
- Dimensions (W x H x D) 1030 × 194 × 118 mm
- Weight 13.0 kg

* Specifications are subject to change without notice.

**LIST OF REMOTE CONTROL CODES
LISTE DES CODES DE COMMANDE
LISTE DER FERNBEDIENUNGSCODES
LISTA ÖVER FJÄRRSTYRNINGSKODER
LISTA DEI CODICI DI TELECOMANDO
LISTA DE CÓDIGOS DE MANDO A DISTANCIA
LIJST MET AFSTANDSBEDIENINGSCODES**

TV		NORDMENDE 265, 266	PHILIPS 699, 647, 659	MAGNAVOX 325, 326, 328
ADMIRAL 292, 293, 216		ONWA 296	PIONEER 636, 637, 638,	MARANTZ 392, 394
AIWA 294, 276, 283, 284		PANASONIC 234, 235, 236,	673, 674, 675	MARTA 396
AKAI 295, 296		253, 288, 211	RCA 639	MATSUI 396
ALBA 296		PHILCO 297, 225, 239	SAMSUNG 642	MEMOREX 328, 336, 396, 397
AOC 297		PHILIPS 298, 225, 205	SHARP 643	MINOLTA 333, 349
BELL &		PIONEER 226, 235, 254,	SONY 644, 676, 677	MITSUBISHI 399, 344, 348,
HOWELL 292		255, 268	SYLVANIA 662	359, 352, 353
BESTAR 298		PORTLAND 297, 256	SYMPHONIC 662	MTC 363, 397
BLAUPUNKT 229, 222		PROSCAN 293, 221	THOMSON 646	MULTITECH 397, 348, 354
BLUE SKY 298		PROSCAN 231, 241, 251	TOSHIBA 634, 665, 666, 667	NEC 392, 394, 344, 383
BRANDT 223		PROTON 297, 250, 260, 270	YAMAHA 699, 622, 623, 647	NOKIA 393, 395
BROC SONIC 297		QUASAR 234, 235	ZERITH 663, 664	NOKIA OCEANIC
BUSH 296		RADIO SHACK 299, 293, 297		395
BYD:SIGN 201, 202		RCA 293, 297, 234,	VCR	OKANO 323
CLATRONIC 298		256, 257, 258, 221	ADMIRAL 395	OLYMPIC 325, 328
CRAIG 224		RUNCO 220, 230, 271	AIWA 396, 397, 398, 329	ORION 327
CROSLEX 225		SABA 223, 269, 265, 266	AKAI 322, 323, 324	PANASONIC 325, 328, 339,
CURTIS MATHIS		SAMPO 281, 297, 280	AUDIO DYNAMIC	355, 378, 384,
297, 226		SAMSUNG 297, 239, 248,	392, 394	385, 386
DAEWOO 297, 298, 224,		262, 275	BELL & HOWELL	PENTAX 333, 349
227, 228		SANYO 295, 233, 279,	393	PHILCO 325, 328, 397
DAYTRON 239		272, 273, 274, 212	BLAUPUNKT 325, 326	PHILLIPS 325, 326, 328,
DUAL 298		SCHNEIDER 296	BROC SONIC 327	337, 356, 357
DWIN 293, 281		SCOTT 297	BUSH 322	PHONOLA 337
EMERSON 297, 224, 239, 232		SHARP 292, 239, 232, 213	CANON 325, 328	PILOT 396
FURGUSON 223, 265, 266		SIEMENS 229	CGM 396, 332	PIONEER 325
FIRST LINE 298		SIGNATURE 216	CITIZEN 396	QUASAR 325, 328
FISHER 295, 233		SIGNATURE 292	CRAIG 396, 363	RCA/PROSCAN
FRABA 298		SONY 263, 214	CURTHIS MATHIS	325, 326, 328,
FUJITSU 289		SYLVANIA 297, 225	397, 328, 333	333, 335, 349,
FUNAI 277, 278		SYNPHONIC 217, 218, 219	DAEWOO 328, 334, 335	358, 369, 363, 397
GE 293, 297, 234,		TELEFUNKUN 269, 264, 265, 266	DBX 392, 394	REALISTIC 393, 397, 328,
235, 236		THOMSON 223, 266	DIMENSIA 333	336, 359, 362,
GOODMANS 296, 298, 223		TOSHIBA 292, 226, 267, 215	DYNATECH 397	396, 363
GRUNDIG 229, 238, 249		VIDECH 297, 242	EMERSON 327, 334, 396, 397	SAMSUNG 354, 358, 363,
HITACHI 297, 239, 242,		WARDS 297, 239, 232, 216	FISHER 393, 336	364, 365, 366
243, 285		YAMAHA 299, 292, 242,	FUNAI 397	SANSUI 394
ICE 296		285, 287, 253	GE 328, 333, 387	SANYO 393, 336, 367
IRRADIO 296		ZENITH 216, 261, 271	GO VIDEO 321, 331, 341,	SCHNEIDER 337
ITT/NOKIA 244, 245			351, 353, 363	SCOTT 399, 335, 336,
JC PENNY 293, 297, 234, 237		DVD PLAYER	GOODMANS 334, 337	348, 359, 352,
JVC 296, 246, 247, 286		AIWA 648, 649	GRUNDIG 332, 338	354, 358
KENDO 298		APEX DIGITAL	HITACHI 325, 333, 349,	SELECO 322
KTV 297, 239		652, 653, 654	342, 343	SHARP 395, 362, 382
LG/GOLDSTAR		BYD:SIGN 678, 679	INSTANT REPLAY	SIEMENS 393
297, 298, 239, 237		DAEWOO 655	325, 328	SIGNATURE 2000
LOEWE 298, 248		DENON 623, 624	ITT/NOKIA 393	395, 397
LXI 293, 297, 225,		FUNAI 625	JC PENNY 392, 393, 394,	SONY 368, 379, 372,
226, 233		HARMAN/KARDON	328, 333, 349,	373, 374, 375
MAGNAVOX 297, 225, 239		656, 657	396, 363	SYLVANIA 397, 325, 326, 328
MARANTZ 298, 210		HITACHI 626	JVC 392, 394, 344,	SYMPHONIC 397
MATSUI 295		JVC 627	345, 346, 347	TANDBERG 334
MEDION 203, 204, 205		KENWOOD 628	KENDO 396	TANDY 397
MEMOREX 297, 216		KLH 658	KENWOOD 392, 394, 396	TASHIRO 396
MITSUBISHI 299, 297, 259, 287		LG/GOLDSTAR	LG/GOLDSTAR	TATUNG 392, 394
NAD 226, 255		645, 663, 664	396, 388	TEAC 392, 394, 397
NEC 297, 252, 282		MARANTZ 699, 659	LOEWE 396, 337	TECHNICS 325, 328
NOKIA 244, 245		MITSUBISHI 629	LUXOR 395	TEKNIKA 396
NOKIA OCEANIC		ONKYO 632, 633, 634	LXI 393, 396, 397,	TELEFUNKUN
245		PANASONIC 623, 635, 668, 672	336, 349	376, 377
				THOMAS 397

THORN 393, 396
TOSHIBA 335, 369, 389
TOTEVISION 363, 396
UNITECH 363
UNIVERSUM 396, 327, 376
VIDEOSONIC 363
W.WHOUSE 396
WARDS 395, 396, 336,
362, 397, 363
YAMAHA 399, 392, 393, 394
ZERITH 344, 361, 368,
371, 379, 396, 397

CABLE TV TUNER

ABC 739, 752, 753,
755, 758, 759, 762
GENERAL INSTRUMENT
722
HAMIN 723, 724, 725,
726, 727
HITACHI 722
JEROLD 722, 728, 729,
732, 733, 734,
735, 736, 737
MAGNAVOX 738
MOTOROLA 748
OAK 739, 742, 743
PANASONIC 744, 745, 746,
747, 783, 784
PHILLIPS 763, 764, 765,
766, 767, 768
PIONEER 748, 785
RADIO SHACK 749
SCIENTIFIC ATLANTA
752, 753, 754
SONY 756, 757
TOCOM 755
UNIVERSAL 769, 772, 773,
774, 775
VIEWSTAR 764, 766, 776,
777, 778, 779, 782

SATELLITE TUNER

ECHOSTAR 822
GE 837, 838, 839
GENERAL INSTRUMENT
823
HITACHI 824
HUGHES 843, 844, 845, 846
JVC 822
MAGNAVOX 825
PANASONIC 826, 829
PHILLIPS 825, 843, 844,
845, 846, 847,
848, 849
PRIMESTAR 827
PROSCAN 837, 838, 839, 842
RADIO SHACK
828
RCA 837, 838, 839, 842
SAMSUNG 852
SONY 832, 835
TOSHIBA 833, 836
UNIDEN 825
ZENITH 834



© 2005 YAMAHA CORPORATION All rights reserved.

YAMAHA ELECTRONICS CORPORATION, USA 6660 ORANGETHORPE AVE., BUENA PARK, CALIF. 90620, U.S.A.
YAMAHA CANADA MUSIC LTD. 135 MILNER AVE., SCARBOROUGH, ONTARIO M1S 3R1, CANADA
YAMAHA ELECTRONIK EUROPA G.m.b.H. SIEMENSSTR. 22-34, 25462 RELINGEN BEI HAMBURG, GERMANY
YAMAHA ELECTRONIQUE FRANCE S.A. RUE AMBROISE CROIZAT BP70 CROISSY-BEAUBOURG 77312 MARNE-LA-VALLEE CEDEX02, FRANCE
YAMAHA ELECTRONICS (UK) LTD. YAMAHA HOUSE, 200 RICKMANSWORTH ROAD WATFORD, HERTS WD18 7GQ, ENGLAND
YAMAHA SCANDINAVIA A.B. J A WETTERGRENS GATA 1, BOX 30053, 400 43 VÄSTRA FRÖLUNDA, SWEDEN
YAMAHA MUSIC AUSTRALIA PTY, LTD. 17-33 MARKET ST., SOUTH MELBOURNE, 3205 VIC., AUSTRALIA

YAMAHA CORPORATION
Printed in Malaysia ◀ WG11470