

YAMAHA
Clavinova®

CVP-89

Owner's Manual
Bedienungsanleitung
Mode d'emploi
Manual de instrucciones

SPECIAL MESSAGE SECTION

PRODUCT SAFETY MARKINGS: Yamaha electronic products may have either labels similar to the graphics shown below or molded/stamped facsimiles of these graphics on the enclosure. The explanation of these graphics appears on this page. Please observe all cautions indicated on this page and those indicated in the safety instruction section.

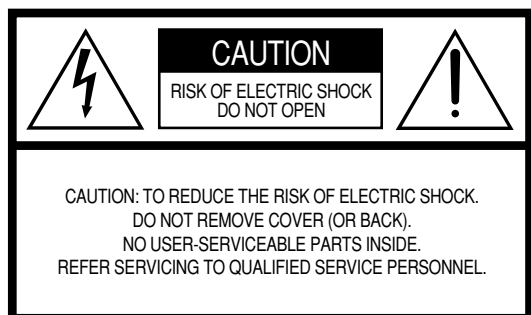

See bottom of Keyboard enclosure for graphic symbol markings



The exclamation point with the equilateral triangle is intended to alert the user to the presence of important operating and maintenance (servicing) instructions in the literature accompanying the product.

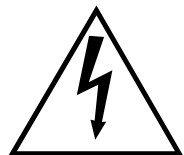

The lightning flash with arrowhead symbol within the equilateral triangle is intended to alert the user to the presence of uninsulated “dangerous voltage” within the product’s enclosure that may be of sufficient magnitude to constitute a risk of electrical shock.

IMPORTANT NOTICE: All Yamaha electronic products are tested and approved by an independent safety testing laboratory in order that you may be sure that when it is properly installed and used in its normal and customary manner, all foreseeable risks have been eliminated. DO NOT modify this unit or commission others to do so unless specifically authorized by Yamaha. Product performance and/or safety standards may be diminished. Claims filed under the expressed warranty may be denied if the unit is/has been modified. Implied warranties may also be affected.

SPECIFICATIONS SUBJECT TO CHANGE: The information contained in this manual is believed to be correct at the time of printing. However, Yamaha reserves the right to change or modify any of the specifications without notice or obligation to update existing units.

ENVIRONMENTAL ISSUES: Yamaha strives to produce products that are both user safe and environmentally friendly. We sincerely believe that our products and the production methods used to produce them, meet these goals. In keeping with both the letter and the spirit of the law, we want you to be aware of the following:

Battery Notice: This product MAY contain a small non-rechargeable battery which (if applicable) is soldered in place. The average life span of this type of battery is approximately five years. When replacement becomes necessary, contact a qualified service representative to perform the replacement.

Warning: Do not attempt to recharge, disassemble, or incinerate this type of battery. Keep all batteries away from children. Dispose of used batteries promptly and as regulated by applicable laws. Note: In some areas, the servicer is required by law to return the defective parts. However, you do have the option of having the servicer dispose of these parts for you.

Disposal Notice: Should this product become damaged beyond repair, or for some reason its useful life is considered to be at an end, please observe all local, state, and federal regulations that relate to the disposal of products that contain lead, batteries, plastics, etc.

NOTICE: Service charges incurred due to lack of knowledge relating to how a function or effect works (when the unit is operating as designed) are not covered by the manufacturer’s warranty, and are therefore the owners responsibility. Please study this manual carefully and consult your dealer before requesting service.

NAME PLATE LOCATION: The graphic below indicates the location of the name plate. The model number, serial number, power requirements, etc., are located on this plate. You should record the model number, serial number, and the date of purchase in the spaces provided below and retain this manual as a permanent record of your purchase.

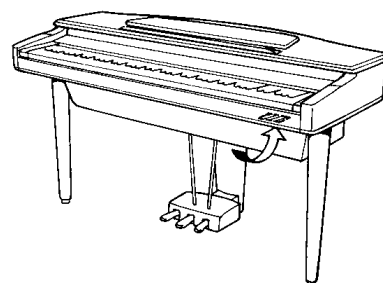

Model _____

Serial No. _____

Purchase Date _____

Clavinova **CVP-89**

Owner's Manual

English

Bedienungsanleitung

Deutsch

Mode d'emploi

Français

Manual de instrucciones

Español

Introduction

Thank you for choosing a Yamaha Clavinova. Your Clavinova is a fine musical instrument that employs advanced Yamaha music technology. With the proper care, your Clavinova will give you many years of musical pleasure.

- AWM (Advanced Wave Memory) tone generator system offers a range of 60 rich, realistic voices.
- 32-note polyphony permits use of sophisticated playing techniques.
- Piano-like touch response provides extensive expressive control and outstanding playability.
- Dual and split play modes allow 2 voices to be played simultaneously or individually with the left and right hands.
- 50 exciting accompaniment styles can be used to provide rhythm-only accompaniment or fully-orchestrated rhythm, bass, and chord accompaniment. 50 additional accompaniment styles are provided on floppy disk (Style Disk).
- Custom Rhythm lets you create original rhythm patterns that can be recalled and played in the same way as the presets.
- Full-keyboard ABC (Auto Bass Chord) provides accompaniment as you play across the entire keyboard.
- 50 Solo Styleplay variations make it simple to produce rich, complex harmonies.
- 10-track performance memory records and plays back your keyboard performances.
- Registration Memory memorizes 12 complete control-panel setups that you can recall whenever needed.
- Internal 3.5" floppy disk drive provides extended Performance Memory capacity and Disk Orchestra playback capability – one blank floppy disk for recording and one Disk Orchestra Collection disk with corresponding score are provided.
- MIDI compatibility, GM voices, and a range of MIDI functions make the Clavinova useful in a range of advanced MIDI music systems.

In order to make the most of your Clavinova's performance potential and features, we urge you to read this Owner's Manual thoroughly, and keep it in a safe place for later reference.

Contents

Taking Care of Your Clavinova	1	Accompaniment	17	■ Guided Right- and Left-hand Practice ...	32
The Panel Controls	2	■ Style Selection	17	■ Repeat Functions	33
Preparation	4	■ Tempo Control	18	■ Other Playback Controls	34
The Volume Controls	5	■ Starting the Accompaniment	18	■ DISK ORCHESTRA COLLECTION	
Demonstration Playback	6	■ Fill-ins	20	Disk Copy	34
Voice Selection	7	■ Left-pedal Rhythm Break	20	■ Playing Other Types of Music Data ...	34
■ Selecting the 60 Voices	7	■ Stopping the Accompaniment	20	Performance Memory	35
■ Keyboard Percussion	8	■ Metronome	20	Easy One-pass Recording & Playback ..	35
Dual Mode	9	Auto Bass Chord (ABC)	21	Multi-track Recording & Playback	36
■ Engaging the Dual Mode	9	■ Single-Finger & Fingered		■ Adding New Tracks	38
■ Dual-mode Voice Balance	9	Accompaniment	21	■ Punch-in Recording	39
Split Mode	10	■ Full-keyboard ABC	22	■ Playback	40
■ Engaging the Split Mode	10	■ Volume Control	23	The Chord Sequence Function	41
■ Changing the Split Voices	10	■ Changing the ABC Split Point	23	Utility Functions	42
■ Changing the Split Point	10	■ Special Modes	23	■ Selecting & Using the Utility Functions .	42
■ Split Balance	11	Custom Rhythm	24	The Utility Mode Functions	42
■ Damper Pedal Operation in the		■ Creating an Original Rhythm Pattern	24	Effect Functions	43
Split Mode	11	■ Playing Back Your Custom Rhythm		Disk Functions	44
Digital Reverb Effects	12	Pattern	25	MIDI Functions	54
■ Selecting a Reverb Effect	12	Disk Styles	26	General Utilities	60
■ Reverb Depth Control	12	■ Selecting & Loading Disk Styles	26	The Connectors	65
The Keyboard & Polyphony	13	■ Using a Loaded Disk Style	27	Factory Preset Recall	66
Pan	13	Solo Styleplay	28	Troubleshooting	66
The Pedals	14	■ Using Solo Styleplay	28	Options	66
■ Right Pedal (Damper Pedal)	14	■ Harmonization Variations	28	Index	67
■ Center Pedal (Sostenuto Pedal)	14	■ The Left Pedal & Solo Styleplay	28	Assembly	i
■ Left Pedal (Multi-function)	14	Registration Memory	29	MIDI Data Format	iii
Pitch Control	16	■ Memory Store	29	Voice List	vii
■ The Pitch Display	16	■ Recall	29	Percussion Kit List	ix
		Disk Orchestra	30	Specifications	xi
		■ Automatic Performance	30	Fingering Chart	xii
		■ Playing Back only Specific Parts	31	MIDI Implementation Chart	xvii
		■ Volume Control	32		

Your Clavinova will give you years of playing pleasure if you observe the simple rules given below:

1. Avoid Humidity & Heat

Avoid placing the Clavinova in areas that are subject to excessive humidity or heat. Do not leave the instrument near heaters or in a car exposed to direct sunlight, for example.

2. Avoid Dust & Moisture

Avoid locations in which the instrument is likely to be exposed to excessive dust or moisture.

3. Power-off Before Connecting

Connections between the Clavinova and any other device must be made with both pieces of equipment turned off.

4. Handle With Care

Never apply excessive force to the controls, connectors or other parts of your Clavinova, and avoid scratching or bumping it with hard objects. Further, always turn the POWER switch off after use, and close the key cover to protect the keyboard.

5. Clean Carefully

Clean the cabinet and keys of your Clavinova only with a clean, slightly damp cloth. A neutral cleanser may be used if desired. Never use abrasive cleansers, waxes, solvents or chemical dust cloths since these can dull or damage the finish.

6. Never Tamper With the Internal Circuitry

Never open the Clavinova cabinet and touch or tamper with the internal circuitry. Tampering with the circuitry can result in electrical shock!

7. Electric Interference

Since the Clavinova contains digital circuitry, it may cause interference if placed too close to radio or television receivers. If this occurs, move the instrument further away from the affected equipment.

8. Name Plate Location

The Clavinova name plate, including the unit's serial number, is located on the bottom panel of the main unit.

9. Handling Floppy Disks

Yamaha Disk Orchestra Collection and Style Disk are write-protected, and therefore cannot be used to save songs. To save Performance Memory songs from the Performance Memory, a blank floppy disk should be used (one blank disk is supplied with the Clavinova).

Taking Care of Your Floppy Disks

- Do NOT eject the disk during recording or playback, or at any time when the disk drive lamp is lit. Doing so may damage both the disk and the FDD.
- Do NOT turn the Clavinova on or off while the disk is in the drive.
- Always eject the disk before turning the Clavinova off.
- When ejecting a floppy disk from the disk drive:

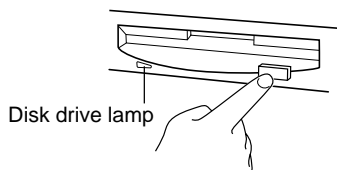

- To eject a floppy disk, press the eject button slowly as far as it will go. Then when the disk is fully ejected, remove it by hand.
- The disk may not be ejected properly if the eject button is pressed too quickly or if it is not pressed in far enough. (The eject button may become stuck halfway with the disk extending from the slot by only a few millimeters). If this is the case, do not attempt to pull out the partially ejected disk. Doing so may damage the disk drive mecha-

nism and/or the floppy disk. To remove a partially ejected disk, try pressing the eject button once again or push the disk back into the slot, then repeat the eject procedure carefully.

- Never open or close the key cover while a disk is extending from the drive (i.e. in the ejected position). The key cover may contact the disk, possibly damaging the disk or even the disk drive.
- Do not insert anything but floppy disks into the disk drive. Other objects may cause damage to the disk drive or floppy disk.
- Use only double-sided double density (2DD) 3.5-inch floppy disks with the Clavinova.

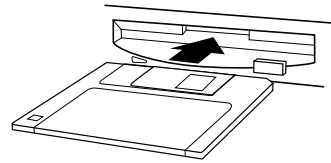

Precautions Regarding Floppy Disk Use

- Never open the disk's shutter. Dirt or dust on the Internal magnetic surface will cause data errors.
- Never leave disks near a speaker, TV, or other device that emits a strong magnetic field.
- Do not store disks in places exposed to direct sunlight or sources of high temperature.
- Do not place heavy objects such as books on top of a disk.
- Avoid getting the disks wet.
- Be sure to store the disks in environmental conditions as specified below:
 - Storage temperature: 4° to 53°C (39° to 127°F).
 - Storage humidity: 8 to 90% relative humidity.
 - Store in an area free from dust, sand, smoke, etc.
- Be sure to apply the disk label at the proper position. When changing the label never cover the old label with a new label; always remove the old label first.

Head Cleaning

The head of the disk drive unit will get dirty as you use it eventually causing data errors. If this occurs, clean the head with a 3.5 inch head cleaning disk (available from most computer supply stores).

Data Backup

It is recommended that you copy your recorded songs to another disk for backup (see page 46). If the original disk is damaged or your song is deleted, the backup disk can be used instead of the original.

Protecting Your Data (Write Protect Tab)

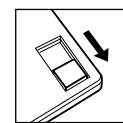
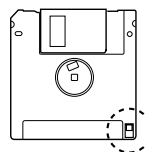

Write protect tab open (locked — write protected)

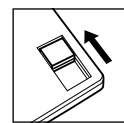

Write protect tab closed (unlocked — write enabled)



The Panel Controls

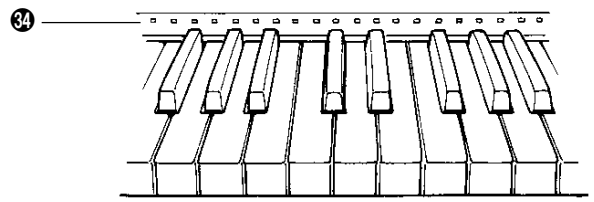
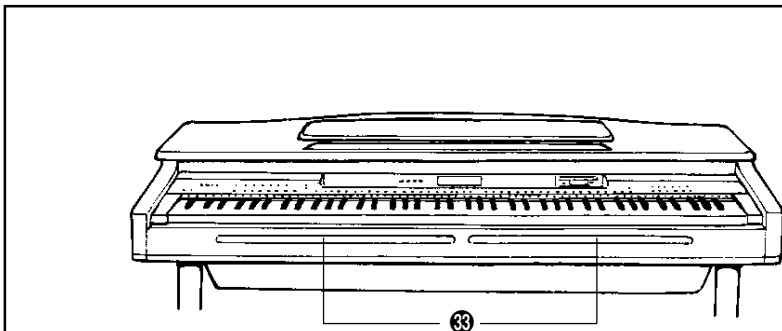
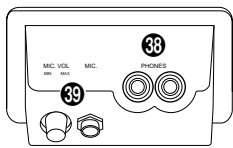
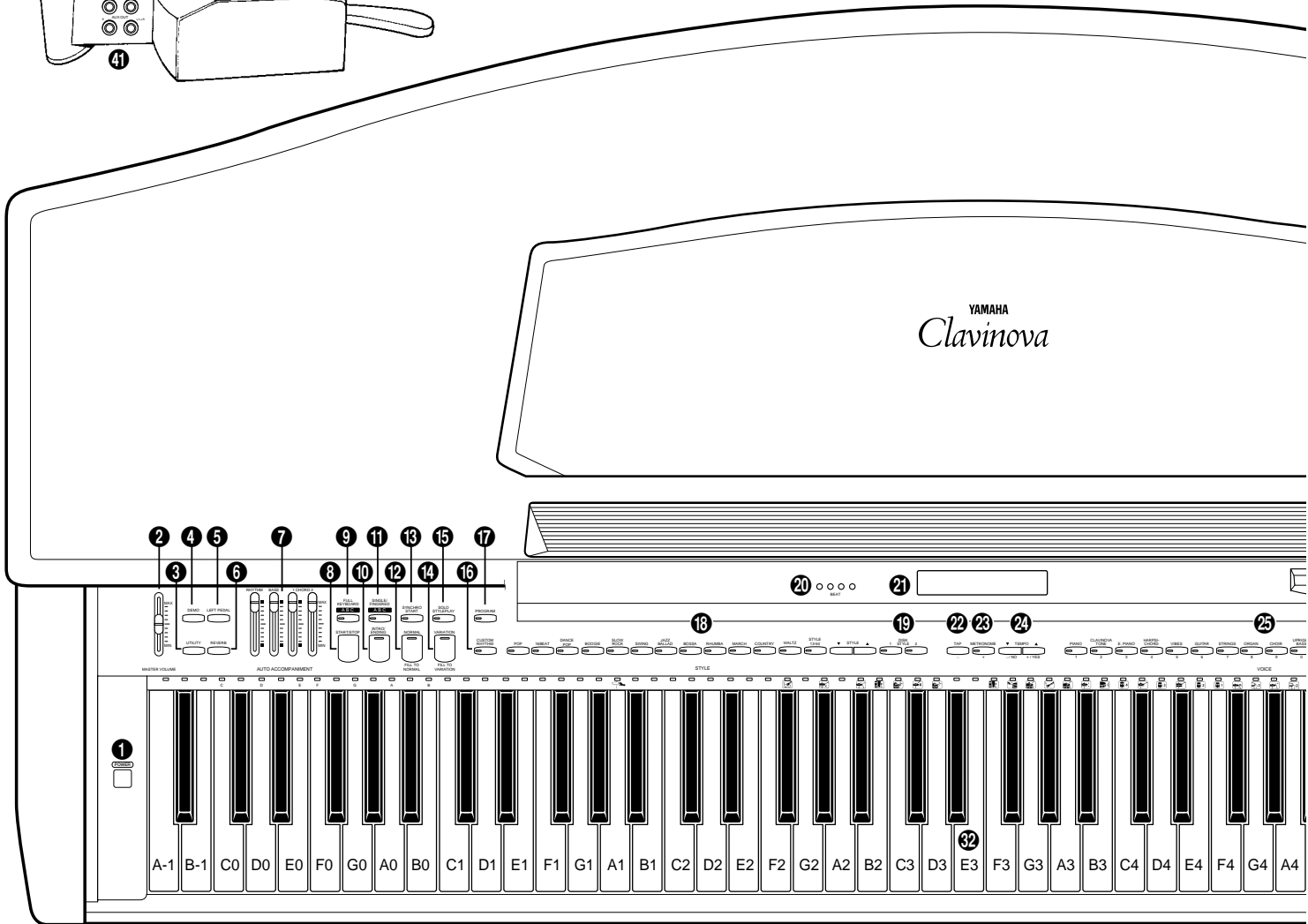
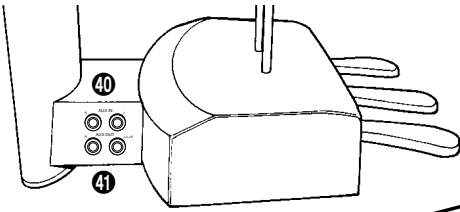

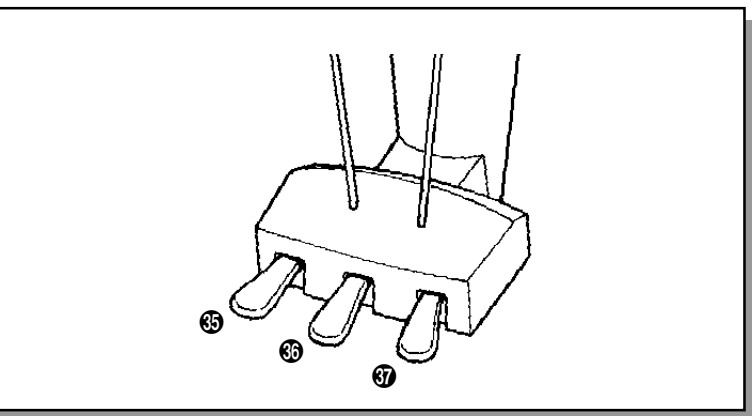
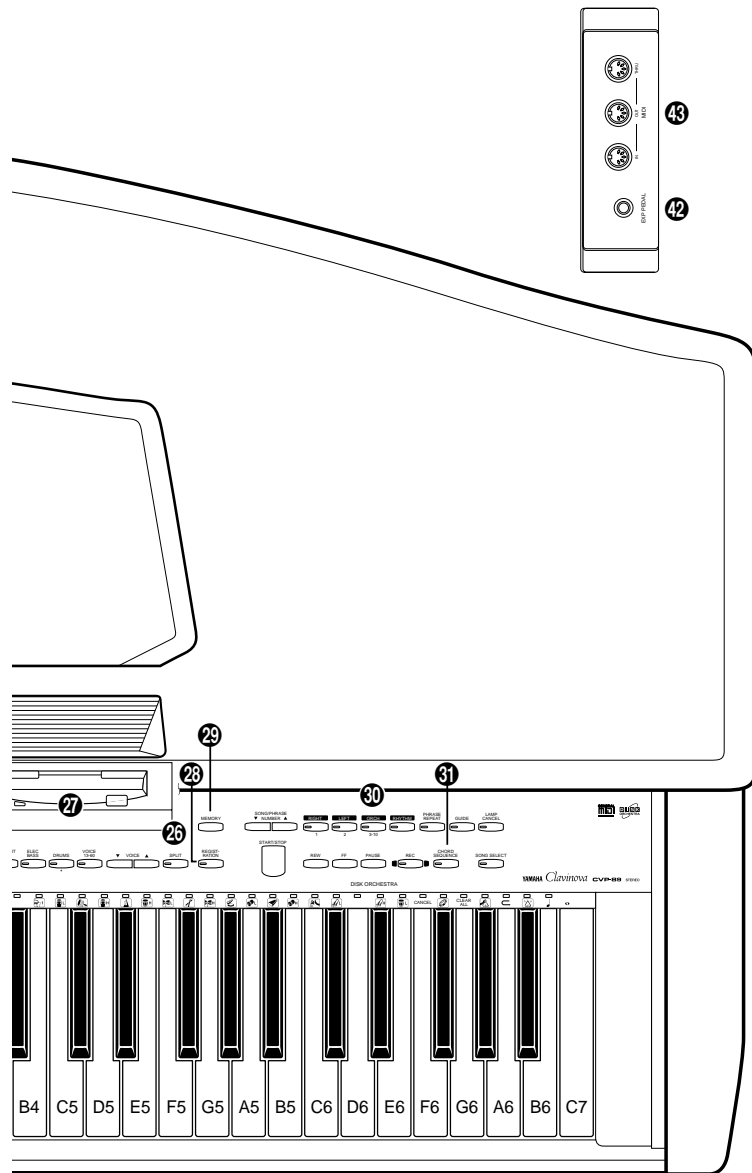

- ❶ POWER Switch page 4
- ❷ MASTER VOLUME Control page 5
- ❸ [UTILITY] Button page 5, 13, 30, 33, 38, 42—44
- ❹ [DEMO] Button page 6
- ❺ [LEFT PEDAL] Button page 14
- ❻ [REVERB] Button page 12
- ❼ AUTO ACCOMPANIMENT Volume Controls page 5, 23
- ❽ [START/STOP] Button page 18, 22
- ❾ ABC [FULL KEYBOARD] Button page 22
- ❿ [INTRO/ENDING] Button page 19, 22
- ⓫ ABC [SINGLE/FINGERED] Button page 21
- ⓬ [NORMAL/FILL TO NORMAL] Button page 18, 22
- ⓭ [SYNCHRO START] Button page 19
- ⓮ [VARIATION/FILL TO VARIATION] Button page 18, 22
- ⓯ [SOLO STYLEPLAY] Button page 28
- ⓰ [CUSTOM RHYTHM] Button page 24
- ⓱ [PROGRAM] Button page 24
- ⓲ STYLE Selectors page 17
- ⓳ [DISK STYLE] Buttons page 26
- ⓴ BEAT Display page 20
- ⓵ LCD Display page 4
- ⓶ [TAP (-)] Button page 19, 42
- ⓷ [METRONOME (+)] Button page 20, 42
- ⓸ TEMPO [▲ (+/YES)] and [▼(-/NO)] Buttons . page 18, 42
- ⓹ VOICE Selectors page 7
- ⓺ [SPLIT] Button page 10
- ⓻ 3.5" Floppy Disk Drive page 26, 30, 35, 44
- ⓼ [REGISTRATION] Button page 29
- ⓽ [MEMORY] Button page 29
- ⓾ DISK ORCHESTRA Buttons page 30, 55
- ⓿ [CHORD SEQUENCE] Button page 41
- ⓫⓪ Keyboard page 13
- ⓫⓫ FILL IN Bars page 20
- ⓫⓬ Disk Orchestra Keyboard Guide Lamps page 32
- ⓫⓭ Soft Pedal page 14
- ⓫⓮ Sostenuto Pedal page 14
- ⓫⓯ Damper Pedal page 14
- ⓫⓰ PHONES Jacks page 4
- ⓫⓱ MIC. Jack & MIC. VOL. Control page 65
- ⓫⓲ AUX IN R and L Jacks page 65
- ⓫⓳ AUX OUT R and L/L+R Jacks page 65
- ⓫⓴ EXP PEDAL Jack page 5, 65
- ⓫⓵ MIDI Connectors page 65



Preparation

■ The Music Stand

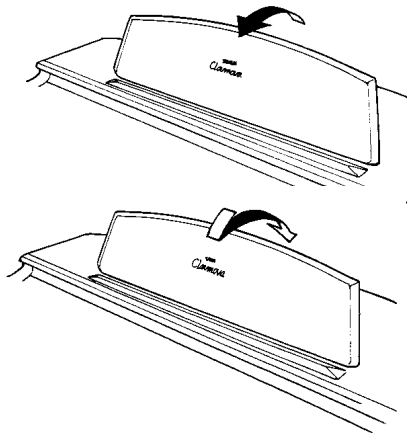

If you will be using sheet music with your Clavinova, raise the music stand built into it's top panel by lifting the rear edge of the music stand.

The music stand can be lowered by slightly lifting the stand and then lowering it gently back down to its resting position.

■ The Key Cover

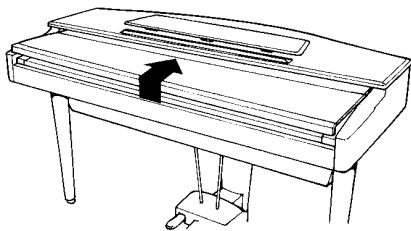

To open the CVP-89 key cover lift it just enough to clear the keys (do not lift excessively) then slide the cover back into the main unit. To close the cover slide it forward all the way and then lower it gently until it closes completely.

■ The Power Switch



∫ 001μ Piano	1
∫ = 78 Pop	1

After making sure that the Clavinova's AC plug is properly inserted into a convenient AC wall outlet, press the **[POWER]** switch located to the left of the keyboard once to turn the power on. The power indicator located below the left end of the keyboard will light. Press the **[POWER]** switch again to turn the power off.

When the power is initially turned on, the **PIANO** voice selector LED will light, the **POP** style selector LED will light, and the display will appear as shown to the left.

■ Headphones

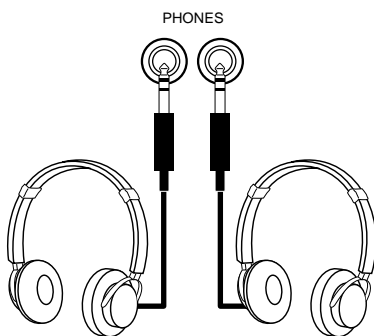

One or two standard pairs of stereo headphones can be plugged in here for private practice or late-night playing. The internal speaker system is automatically shut off when a pair of headphones is plugged into either or both of the **PHONES** jacks.

The Clavinova has several volume controls that give you extra versatility in creating the required sound.

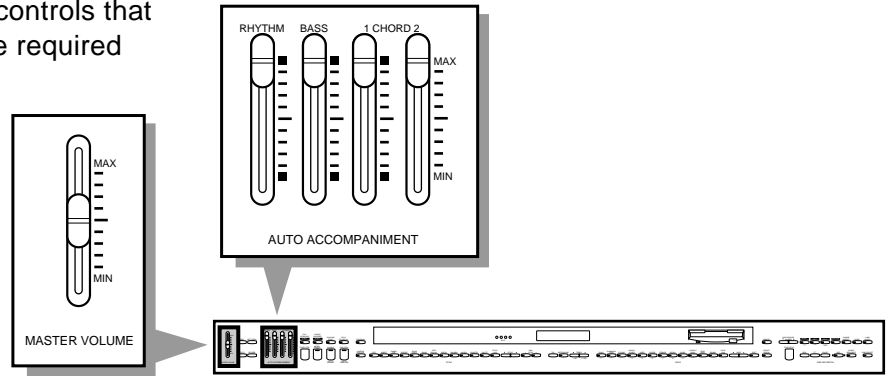

● Master Volume

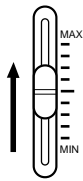

MASTER VOLUME

The **MASTER VOLUME** control adjusts the overall volume of sound produced by the Clavinova. It also adjusts headphone volume when one or two pairs of headphones are plugged into the **PHONES** jacks.

Initially set the **MASTER VOLUME** control about half way between the “MIN” and “MAX” settings. Then, when you start playing, adjust the control for the most comfortable listening level.

● Auto Accompaniment

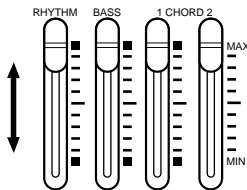

AUTO ACCOMPANIMENT

Separate volume controls are provided for the **RHYTHM**, **CHORD 1**, **CHORD 2**, and **BASS** sound. These volume controls let you set up the best balance between the various accompaniment parts when the **AUTO BASS CHORD** (ABC), Disk Orchestra Collection playback, and Performance Memory features are used, and the **RHYTHM** volume control can be used to balance the keyboard and rhythm sound when only rhythm accompaniment is used.

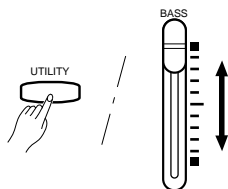

The volume of the keyboard can be independently adjusted (1 ... 127) by using the **BASS** control while holding the [UTILITY] button — this is particularly handy for adjusting the balance when recording the Clavinova sound.

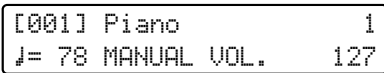

● Other Volume Control Modes

The Auto Accompaniment volume controls can be assigned to other functions via the “Accompaniment Volume Mode” utility function (page 61). They can be used to control modulation, pitch bend, and expression; or individual reverb depth for the rhythm, chord 1, chord 2, and bass parts.



- If any or all of the Auto Accompaniment volume controls are set to their minimum positions, no sound will be produced by the corresponding parts. The maximum control positions produce the normal volume levels.

● Expression Control

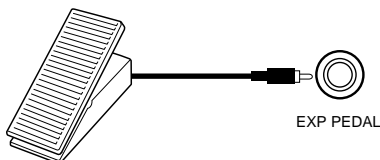

An optional Yamaha EP-1 Expression Pedal can be plugged into the **EXP PEDAL** jack for foot volume (expression) control of the keyboard sound only (i.e. expression doesn't affect the auto-accompaniment sound or disk playback). Press the pedal forward to increase volume, and backward to decrease volume.

The Internal Amplifier & Speaker System

The CVP-89 features a powerful “3D System” amplifier featuring a single 50-watt channel and stereo 25-watt channels. This high-performance amplifier and speaker system puts out exceptionally rich sound with natural response from powerful lows to shimmering highs. The CVP-89 speaker system employs a single 18-cm speaker for center-channel low-frequency reproduction, and three speakers each per stereo channel: 13-centimeter speaker units for midrange sound, 2.5-cm units for outstanding high-frequency sound, and 8-cm units for player monitoring.

Demonstration Playback

The Clavinova features 25 demonstration tunes that effectively demonstrate its sound and accompaniment capabilities. Here's how you can select and play the demo tunes.

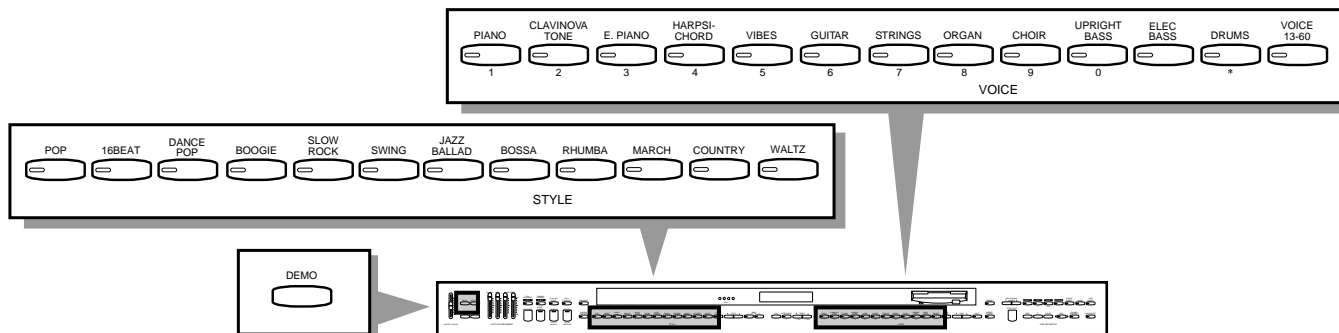

1 Press the [DEMO] button

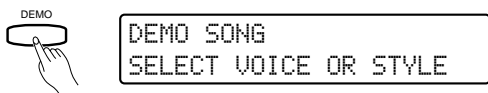

2 Select a Demo Tune

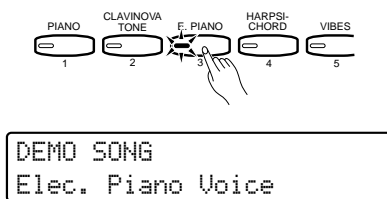

The 25 demo tunes are selected via the **STYLE** and **VOICE** selectors — the corresponding selector indicators light when the [DEMO] button is pressed. Press a selector to start playback of the corresponding tune. You can also select continuous repeat playback of all demo tunes by pressing the [START/STOP] button. The demo tunes will play back in sequential or random order, depending on the setting of the “Random All Song Repeat” utility function described on page 62. The corresponding voice name will appear on the LCD during **VOICE** demo playback. The style name will appear on the display during **STYLE** demo playback.

3 Adjust the Volume

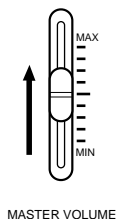

Use the **MASTER VOLUME** control to adjust the volume, and play along on the keyboard if you like.



- The tempo cannot be adjusted during demo playback.

4 Stop Playback



Demo playback can be stopped temporarily by pressing either the [START/STOP] button or **STYLE** or **VOICE** selector corresponding to the demonstration tune which is currently playing. Press the [DEMO] button when you want to stop demo playback and return to the normal mode.

The Demo Tunes

VOICE NAME	COMPOSER	SONG TITLE
PIANO	F. F. Chopin	Etude Op.25-1 “Aeolian Harp” or “The Shepherd Boy”
CLAVINOVA TONE	D. Foster	“Water Fountain” from “The Secret of My Success”
HARPSICHORD	J. S. Bach	Italienisches Konzert (Italian Concerto) BWV 971 3rd movement
GUITAR	I. Albeniz	Asturias
STRINGS	A. Vivaldi	The Four Seasons No. 3 “Autumn” 1st movement
ORGAN	J. S. Bach	Sinfonia from Kantate (Cantata) 29 BWV 29
CHOIR	W. A. Mozart	Requiem K. 626 No. 6 “Lacrimosa”

* The demonstration pieces listed above, except the PIANO piece, are short excerpts from the original compositions. All other songs are original (© 1994 by Yamaha Corporation).

The CVP-89 has a total of 60 different voices that can be selected in a number of ways. There's also a "Keyboard Percussion" mode that let's you play a range of drums and percussion instruments on the keyboard.

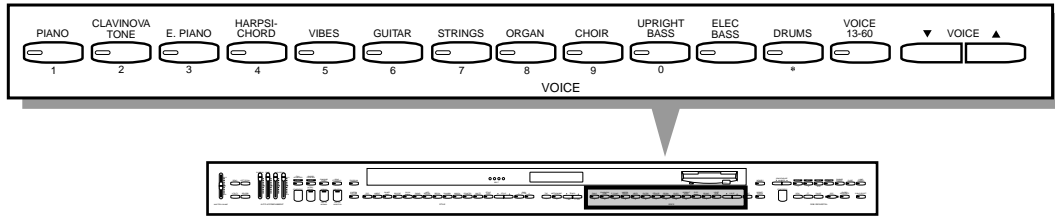

Selecting the 60 Voices

Voices 1-12: Direct Panel Selection

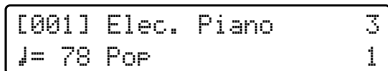
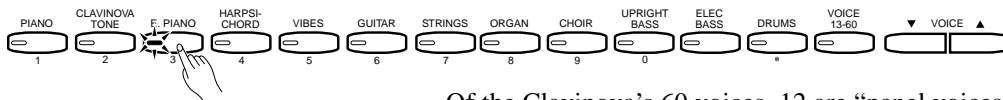

Of the Clavinova's 60 voices, 12 are "panel voices" which can be directly accessed by pressing the corresponding **VOICE** selector. When a voice selector is pressed the corresponding indicator will light and the number and name of the selected voice will appear on the display.

The PIANO voice is automatically selected when the power is initially turned on.

The VOICE 13-60 [▲] and [▼] Buttons

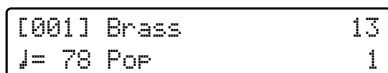
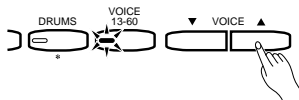

Use the **VOICE [▲]** and **[▼]** buttons immediately to the right of the **[VOICE 13-60]** button to select a voice number between 13 and 60. Press either button briefly to select the next voice number in the specified direction, or hold the button for continuous scrolling in the specified direction. The **[VOICE 13-60]** indicator will light and the voice number and name will appear on the display.

If a panel voice (1-12) is selected, the last selected voice in the 13-60 range can be instantly re-selected simply by pressing the **[VOICE 13-60]** button. The **[VOICE 13-60]** button will initially select voice number 13 (BRASS) after the power is turned on.



- Voice number 13 can be instantly selected by pressing the **VOICE [▲]** and **[▼]** buttons simultaneously.

Numeric Selection

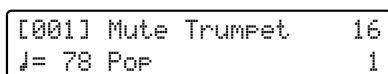

Enter the number of the desired voice via the voice selectors (note that each voice selector has a number between 1 and 0 associated with it) while pressing the **[DRUMS]** selector.

To select voice number 16, for example, press and hold **[DRUMS]**, press **[PIANO/1]**, then **[GUITAR/6]**, then release the **[DRUMS]** button. The voice number and name will appear on the display. The **[VOICE 13-60]** button indicator will light whenever a voice number between 13 and 60 is selected.



Panel Voices (1 — 12)

No.	Name	Usable Range
1	PIANO	A-1 - C7
2	CLAVINOVA TONE	C1 - C7
3	E. PIANO	C1 - C6
4	HARPSICHORD	C1 - C6
5	VIBES	F2 - F5
6	GIUITAR	E1 - F#4
7	STRINGS	C0 - C6
8	ORGAN	C0 - C6
9	CHOIR	E1 - E5
10	UPRIGHT BASS	C0 - F#3
11	ELEC BASS	E0 - F#3
12	DRUMS	—

Voices 13 — 60

No.	Name	Usable Range
13	BRASS	F0 - C6
14	POP BRASS	F0 - C6
15	TRUMPET	F0 - C6
16	MUTE TRUMPET	F#2 - A5
17	HORN	A#0 - F4
18	SAX	A#0 - F#5

No.	Name	Usable Range
19	SAX SOFT	A#0 - F#5
20	CLARINET	D2 - A#5
21	OBOE	A#2 - G5
22	FLUTE	G2 - F#6
23	ACCORDION	F2 - A5
24	HARMONICA	C3 - C6
25	STRINGS SOFT	C0 - C6
26	VIOLIN	C0 - C6
27	VIOLIN HARD	C0 - C6
28	FULL ORGAN	C0 - C6
29	JAZZ ORGAN 1	C1 - C6
30	SYNTH BRASS	C1 - C6
31	SYNTH WOOD	C2 - F#6
32	SYNTH STRINGS	C0 - C6
33	SYNTH CHOIR	E1 - E5
34	PIANO BRIGHT	A-1 - C7
35	PIANO SOFT	A-1 - C7
36	E. PIANO DX	C1 - C6
37	SYNTH CRYSTAL	C2 - C6
38	CELESTA	C2 - C6
39	MARIMBA	C2 - C6

No.	Name	Usable Range
40	FOLK GUITAR	E1 - A4
41	JAZZ GUITAR 1	E1 - A4
42	JAZZ GUITAR 2	E1 - A4
43	ROCK GUITAR 1	E1 - A4
44	ROCK GUITAR 2	E1 - A4
45	MUTE GUITAR	E1 - A4
46	BANJO	C3 - A5
47	PIZZICATO	C1 - C6
48	HARP	C1 - C6
49	U. BASS SOFT	C0 - F#3
50	E. BASS SOFT	E0 - F#3
51	E. BASS HEAVY	E0 - F#3
52	SYNTH BASS	E0 - F#3
53	TIMPANI & ORCH. HIT	E0 - C2/G2 - C6
54	BASSOON	A#0 - D4
55	CHAMBER STRINGS	C1 - C6
56	JAZZ ORGAN 2	C1 - C6
57	ROCK GUITAR 3	E1 - A4
58	COSMIC 1	G0 - C6
59	COSMIC 2	G0 - C6
60	COSMIC 3	G0 - C6



NOTES

- When the DRUMS voice is selected only the keys with drum or percussion symbols printed above them will sound.
- The PIANO voice is automatically selected when the power is initially turned on.
- The chorus effect ON/OFF and pitch bend range parameters for the voices can be accessed via the UTILITY mode — page 43, 62.

Keyboard Percussion

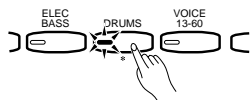

When the [DRUMS] voice selector is pressed (its indicator will light), you can play 44 different drum and percussion instruments on the keyboard. The symbols above the keys correspond to the NORMAL drum kit instruments (keys with no symbols produce no sound).



NOTES

- The CVP-89 has two drum kits — “NORMAL” and “PROCESSED”. Which of these kits will sound when Keyboard Percussion is engaged depends on the currently selected accompaniment style. Some styles which use the “NORMAL” kit, however, include instruments from the “PROCESSED” kit, and vice-versa.
- The accompaniment styles listed below use the “PROCESSED” drum kit while all others use the “NORMAL” kit.

Internal Styles

3: DANCE POP
23: TECHNO POP

Disk Styles

8: POP BALLAD
11: NEW AGE POP
12: COMPUTER GAME
16: DANCE POP 2
20: REGGAE 2
38: CLOCK

- See page ix for a list of the NORMAL and PROCESSED drum kit instrument assignments.
- The TRANSPOSE and PITCH functions described on pages 43 and 16 do not affect the DRUMS sound.
- Drum parameters individually programmable for each instrument are accessible via the UTILITY mode — page 63.

The DUAL mode makes it possible to play two voices simultaneously across the entire range of the keyboard. This makes it easy to create exceptionally rich, thick tonal textures.

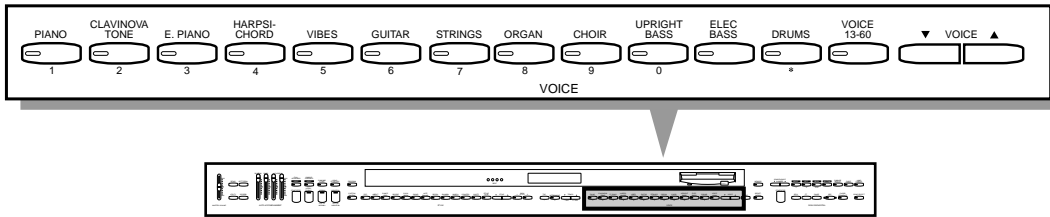

Engaging the Dual Mode

Dual mode voice combinations can be broadly divided into three categories: panel voice + panel voice, panel voice + voice number 13-60, and two voices in the 13-60 range. The dual mode for each combination is selected in a different way, as described below:

● Panel Voice + Panel Voice

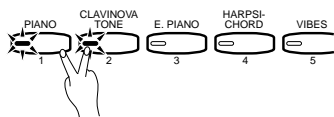

To combine two panel voices simply press two voice selectors at the same time — or press one voice selector while holding another. The names of both selected voices will appear on the display when the DUAL mode is active. To return to the normal single-voice play mode, press any single voice selector.

● Panel Voice + 13-60 Voice

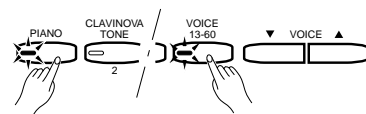

A voice in the 13...60 range can be “dualled” with the panel voices by pressing the [VOICE 13-60] button and any other voice selector at the same time. The VOICE [▲] and [▼] buttons can then be used to select the desired 13...60 voice. The names of both selected voices will appear on the display (the 13-60 voice name will appear on right side of the display). To return to the normal single-voice play mode, press any single voice selector.

● Two 13-60 Voices

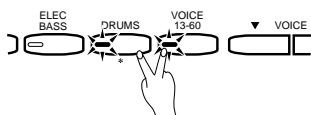

To combine two voices in the 13-60 range press the [DRUMS] button and the [VOICE 13-60] button at the same time (the default combination is POP BRASS and BRASS). The voice shown on the right of the display can then be selected by using the VOICE [▲] and [▼] button, while the left voice can be selected by using the VOICE [▲] and [▼] buttons while holding the [DRUMS] and [VOICE 13-60] buttons. To return to the normal single-voice play mode, press any single voice selector.

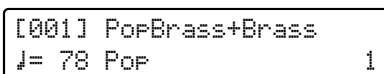

Dual-mode Voice Balance

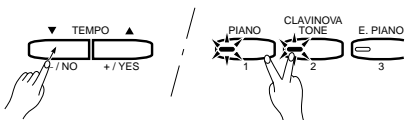

The volume balance between the two voices combined in the DUAL mode can be adjusted by using the TEMPO [▲] and [▼] buttons while pressing both of the active voice selectors. The selected balance value (1 ... 15) will be shown on the display until the voice selectors are released.

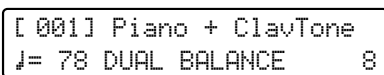

- A setting of “1” sets the volume of the left voice on the display to maximum and the right voice to minimum (no sound).
- A setting of “8” sets both voices to the same volume (this is the default balance setting, and can be recalled by pressing the TEMPO [▲] and [▼] buttons simultaneously).
- A setting of “15” sets the volume of the right voice on the display to maximum and the left voice to minimum (no sound).

NOTES

- Hold either the TEMPO [▲] or [▼] button for continuous scrolling in the specified direction.
- The dual mode cannot be used with the DRUMS voice. Also, the dual and split modes cannot be used at the same time.

Split Mode

The split mode lets you play different voices with the left and right hands — bass with the left and piano with the right, for example. You can assign any of the Clavinova's voices to the left and right-hand sections of the keyboard.

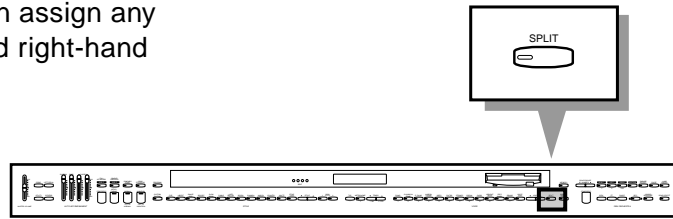

Engaging the Split Mode

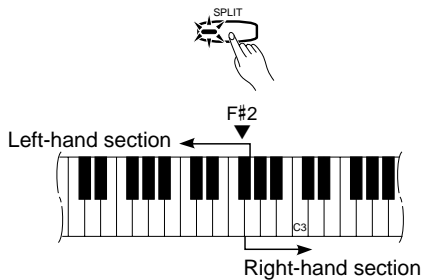

```
[001] Upr Bass /Piano
J= 78 Pop 1
```

When the [SPLIT] button is pressed and its indicator lights, the keyboard is split into left- and right-hand sections and different voices can be assigned to each. The split point is initially set at the F#2 key when the power is turned on, and the UPRIGHT BASS voice is initially assigned to the left-hand section of the keyboard (all keys up to and including F#2). The voice that was selected when the SPLIT mode was engaged is assigned to the right-hand section of the keyboard. The current settings are retained if the SPLIT mode is turned off (press the [SPLIT] button again) and on while the power remains on. The names of both the left and right-hand voices appear on the display while the SPLIT mode is active.

Changing the Split Voices

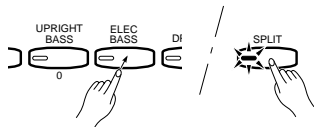

```
[001] E.Bs Slr/Piano
J= 78 SPLIT BALANCE 8
```

The right-hand voice can be changed simply by pressing the appropriate voice selector.

The left-hand voice can be changed by pressing a voice selector while holding the [SPLIT] button.



- All voices except BASS (voice numbers 10, 11, 49, 50, 51, and 52) and DRUMS (voice number 12) are shifted up one octave when assigned to the lower section of the keyboard (this function can be turned on or off via the "Split Left Octave" utility function described on page 64).

Changing the Split Point

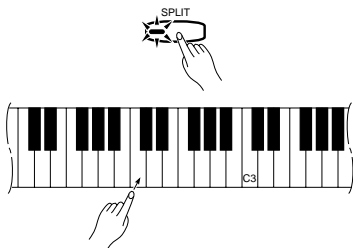

```
[001] E.Bs Slr/Piano
J= 78 SPLIT POINT C 2
```

The split point can be set at any key by pressing the desired key while holding the [SPLIT] button. The split point key name will appear on the display while the [SPLIT] button is held.

A keyboard guide lamp will indicate the selected split point. The default split point — F#2 — will always be set automatically whenever the power is initially turned on.



Split Balance

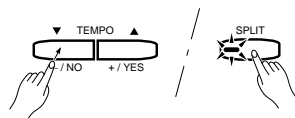

```
[001] E.Bs Slr/Piano
♩= 78 SPLIT BALANCE 8
```

The volume balance between the left-hand and right-hand voices can be adjusted by using the **TEMPO** [▲] and [▼] buttons while holding the **[SPLIT]** button. The selected balance value (1 ... 15) will be shown on the display while the **[SPLIT]** button is held.

- A setting of “1” sets the volume of the left voice to maximum and the right voice to minimum (no sound).
- A setting of “8” sets both voices to the same volume (this is the default balance setting, and can be recalled by pressing the **TEMPO** [▲] and [▼] buttons simultaneously).
- A setting of “15” sets the volume of the right voice to maximum and the left voice to minimum (no sound).



- Hold either the **TEMPO** [▲] or [▼] button for continuous scrolling in the specified direction.

Damper Pedal Operation in the Split Mode

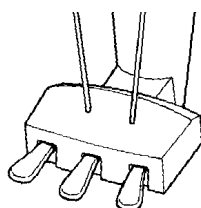

The damper pedal (the right pedal — see “The Pedals” on page 14) can be assigned to the left voice only, the right voice only, or to both voices in the split mode.

- **Right Voice Only (default):** Press the right (damper) pedal while holding the **[SPLIT]** button.
- **Left Voice Only:** Press the left (soft) pedal while holding the **[SPLIT]** button.
- **Both Voices:** Press both the right and left pedals while holding the **[SPLIT]** button.



- The dual and split modes cannot be used at the same time.
- In the split the soft and sostenuto pedal functions apply to both the left- and right-hand voices.
- When the ABC Single/Fingered mode (page 21) and the split mode are used simultaneously, the left-hand voice will be accompanied by the appropriate ABC chord voices.

12 Digital Reverb Effects

The [REVERB] button provides a number of digital effects that you can use for extra depth and expressive power.

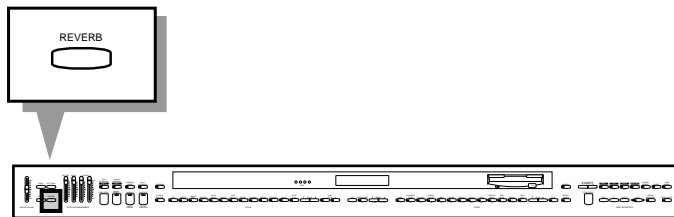

Selecting a Reverb Effect

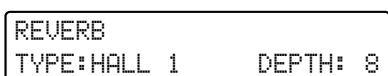
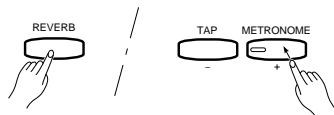

Each time the [TAP] or [METRONOME] button is pressed while the [REVERB] button is held, the next reverb effect is selected. The currently selected reverb effect and the reverb depth setting appear on the display while the [REVERB] button is held. The reverb effect can also be selected by repeatedly pressing the [REVERB] button while the reverb type remains on the display.

OFF

No effect is produced.

ROOM

This setting adds a reverb effect to the sound that is similar to the type of acoustic reverberation you would hear in a medium-size room.

HALL 1

For a more spacious reverb sound, use the HALL 1 setting. This effect simulates the natural reverberation of a medium-size concert hall.

HALL 2

HALL 2 simulates the reverb of a very large concert hall.

COSMIC

“COSMIC” is an echo effect in which the sound seems to “bounce” around in the stereo sound field.



- The ROOM effect is automatically selected when the POWER switch is turned on.

Reverb Depth Control

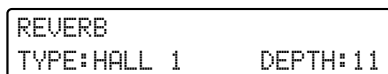
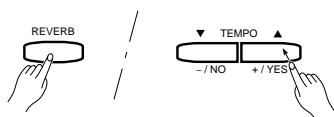

The depth of the selected reverb effect can be increased or decreased by pressing the TEMPO [▲] or [▼] button while holding the [REVERB] button. The reverb depth is shown on the display while the [REVERB] button is held. The reverb depth range is from “0” (no effect) to “15” (maximum depth).

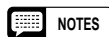

- Reverb depth is initially set to “8” when the power is turned on (this setting can be recalled during reverb depth selection by pressing the TEMPO [▲] and [▼] buttons simultaneously).
- Hold either the TEMPO [▲] or [▼] button for continuous scrolling in the specified direction.
- The depth of reverb effect applied to the manually-played part can be individually adjusted (0 ... 127, 64 by default) by using the BASS volume control while holding the [REVERB] button: This setting is shown on the display while the [REVERB] button is held.

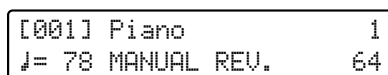
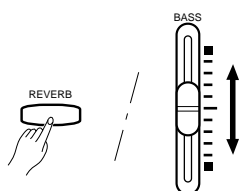

The Clavinova has “32-note polyphony” which means you can normally play up to 32 notes at once. This number varies, however, according to the functions being used, as shown in the chart below:

Keyboard only	32 notes.
Keyboard + rhythm	24 notes (rhythm uses 8).
Keyboard + ABC	12 notes (rhythm 8; ABC 12).

The following voices are STEREO:

- No.1 PIANO
- No.8 ORGAN
- No.28 FULL ORGAN
- No.34 PIANO BRIGHT
- No.35 PIANO SOFT

The following voices feature VELOCITY SWITCHING (i.e. they sound different when played soft or loud).

- No.3 E.PIANO
- No.11 ELEC BASS

- The number of available notes is further reduced if the dual mode, the performance memory, or a Disk Orchestra Collection disk is being played at the same time.

The Clavinova also offers keyboard touch response, so the volume and timbre of notes played can be controlled according to how “hard” you play the keys. The amount of variation available depends on the selected voice.

NOTES

- Some voices have greater polyphony than shown in the above chart. Further, some dual-mode and split-mode voice combinations provide 64-note total polyphony (32 notes per voice).

Pan

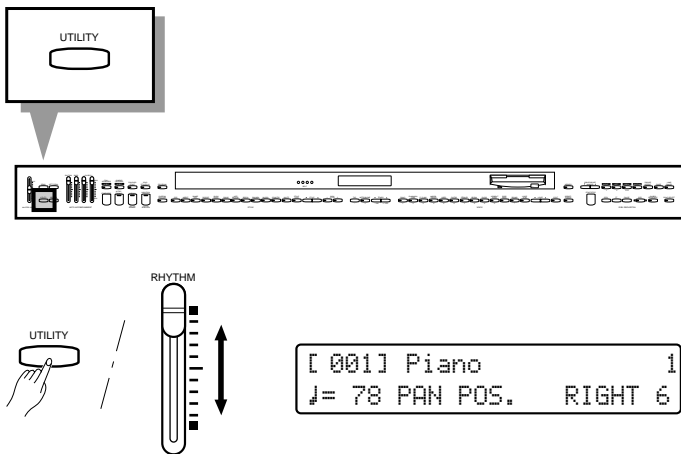

The pan settings are as follows:

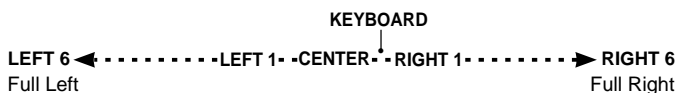

- The pan (stereo) position of the voice played on the keyboard can be adjusted by moving the **RHYTHM** volume control while holding the [UTILITY] button. The pan position is shown on the display, from “LEFT 6” for full left at the “MIN” control position, through “CENTER” for center, to “RIGHT 6” for full right at the “MAX” control position. This can be used to produce a broader ensemble sound with the Performance Memory multitrack recording feature.

Each voice has a preset pan setting (indicated by “KEYBOARD” on the display) which is automatically set when the power is first turned on.

NOTES

- The “KEYBOARD” default keyboard scale pan places the treble-register sound to the right and the bass-register sound to the left. Using a different PAN setting places the entire voice, low and high notes included, at the same position.
- The DRUMS voice has a preset PAN setting which cannot be changed.

The CVP-89 has three pedal which offer a range of advanced expressive capabilities.

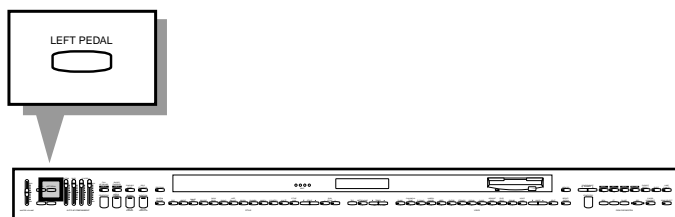
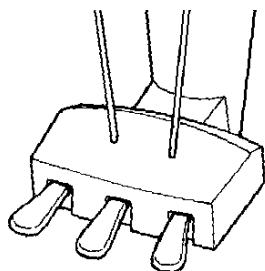

Right Pedal (Damper Pedal)

The damper pedal functions in the same way as a damper pedal on an acoustic piano. When the damper pedal is pressed notes played have a long sustain. Releasing the pedal immediately stops (damps) any sustained notes.



- The damper pedal can be set for continuous or on/off type damping control via the "Damper Pedal Mode" utility function (page 62). Continuous control is the default setting.
- The damper pedal can also be used to increase the depth of a unique "Soundboard" effect for the PIANO voice (voice number 1). The maximum depth of the Soundboard effect can be set via the "Damper Pedal Mode" utility function (page 62).

Center Pedal (Sostenuto Pedal)

If you play a note or chord on the keyboard and press the sostenuto pedal while the note(s) are held, those notes will be sustained as long as the pedal is held (as if the damper pedal had been pressed) but all subsequently played notes will not be sustained. This makes it possible to sustain a chord, for example, while other notes are played "staccato."



- The sostenuto pedal will not function while the SOLO STYLEPLAY feature (page 28) is engaged.

Left Pedal (Multi-function)

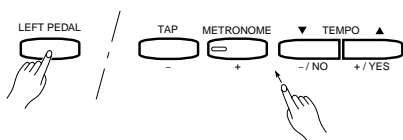

The left pedal has a number of functions which can be selected using the [LEFT PEDAL] button. Each time the [TAP] or [METRONOME] button is pressed while the [LEFT PEDAL] button is held, the next LEFT PEDAL function is selected and shown on the display. The left pedal functions can also be selected by using the TEMPO [▲] or [▼] button while holding the [LEFT PEDAL] button. It is also possible to select the left pedal function by repeatedly pressing the [LEFT PEDAL] button while the left-pedal function name remains on the display.

● Soft

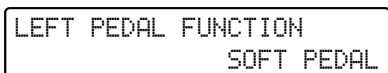

Pressing the soft pedal subtly reduces the volume and slightly changes the timbre of notes played. The amount of "softness" corresponds to how deeply the pedal is pressed. The **SOFT** function is automatically selected whenever the POWER switch is turned on.



● **Start/Stop**

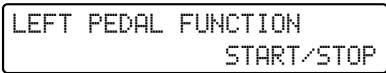

The left pedal performs the same function as the panel [START/STOP] buttons. For details on the START/STOP function, refer to the “Accompaniment” section, page 18.

● **Rhythm Break**

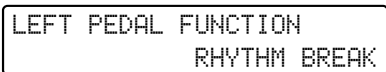

For details on the RHYTHM BREAK function, refer to the “Accompaniment” section, page 20.

● **Pitch Bend**

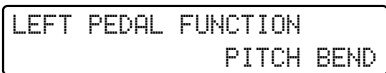

When this function is selected the center and left pedals can be used to bend the pitch of notes played on the keyboard up or down, respectively, while the center or left pedal is held. The default pitch bend range is individually set for each voice. The pitch bend range can be adjusted as required via the “Pitch Bend Range” utility function (page 62).

● **Solo Styleplay**

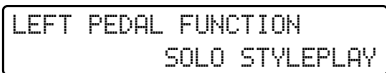

For details on the SOLO STYLEPLAY function see “SOLO STYLEPLAY” on page 28 (the SOLO STYLEPLAY pedal function can only be selected when the SOLO STYLEPLAY feature is in use).



- *The damper, soft, and sostenuto pedal functions do not affect the DRUMS voice.*



Pitch control makes it possible to tune the Clavinova over a ± 50 -cent range (approximate) in approximately 1.2-cent or 1-hertz intervals. A hundred “cents” equals one semitone, so the tuning range provided allows fine tuning of overall pitch over a range of approximately a semitone. Pitch control is useful for tuning the Clavinova to match other instruments or recorded music.

● Tuning Up

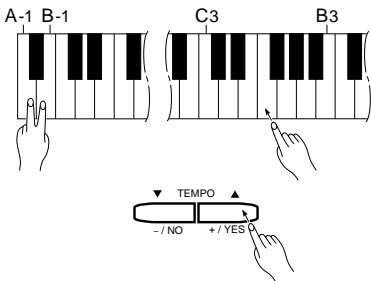

1 To tune up (raise pitch), hold the **A-1** and **B-1** keys simultaneously (A-1 and B-1 are the two lowest white keys on the keyboard) and press any key between **C3** and **B3**. Each time a key in this range is pressed the pitch is raised by approximately 1.2 cents, up to a maximum of about 50 cents above standard pitch. To raise the pitch in 1-hertz increments press the **TEMPO [▲]** button instead of the **C3-B3** keys. The **TEMPO [▼]** button can also be used to tune down while the **A-1** and **B-1** keys are held.

2 Release the **A-1** and **B-1** keys.

● Tuning Down

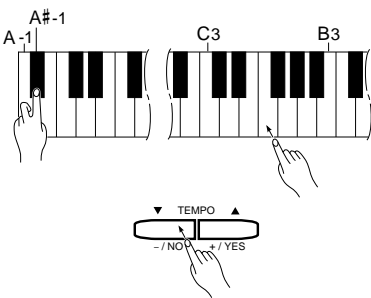

1 To tune down (lower pitch), hold the **A-1** and **A#-1** keys simultaneously and press any key between **C3** and **B3**. Each time a key in this range is pressed the pitch is lowered by approximately 1.2 cents, up to a maximum of about 50 cents below standard pitch. To lower the pitch in 1-hertz increments press the **TEMPO [▼]** button instead of the **C3-B3** keys. The **TEMPO [▲]** button can also be used to tune up while the **A-1** and **A#-1** keys are held.

2 Release the **A-1** and **A#-1** keys.

● To Restore Standard Pitch*

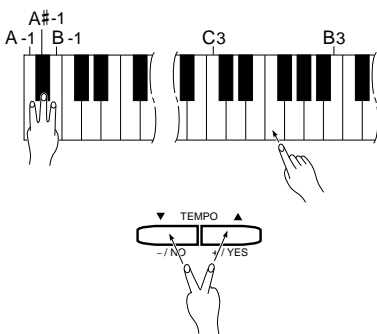

1 To restore standard pitch ($A_3 = 440$ Hz), hold the **A-1**, **A#-1**, and **B-1** keys simultaneously and press any key between **C3** and **B3**, or simultaneously press the **TEMPO [▲]** and **[▼]** buttons.

2 Release the **A-1**, **A#-1**, and **B-1** keys.

* Standard pitch ($A_3 = 440$ Hz) is automatically set whenever the **POWER** switch is initially turned on.



• The **PITCH** function does not affect the **DRUMS** sound.

• Hold either the **TEMPO [▲]** or **[▼]** button for continuous scrolling in the specified direction.

■ The Pitch Display

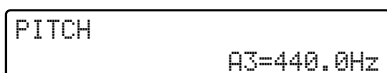

The approximate pitch of A_3 is shown on the display in Hertz while the pitch control function is in operation. The total display range is from approximately 427 hertz (-50 cents) to 453 hertz (+50 cents).

The CVP-89 has 50 “styles” that can be used as a basis for rhythm accompaniment, or fully orchestrated rhythm, bass, and chord accompaniment (see “Auto Bass Chord” on page 21).



• The Accompaniment Style data is not transmitted via the MIDI OUT connector.

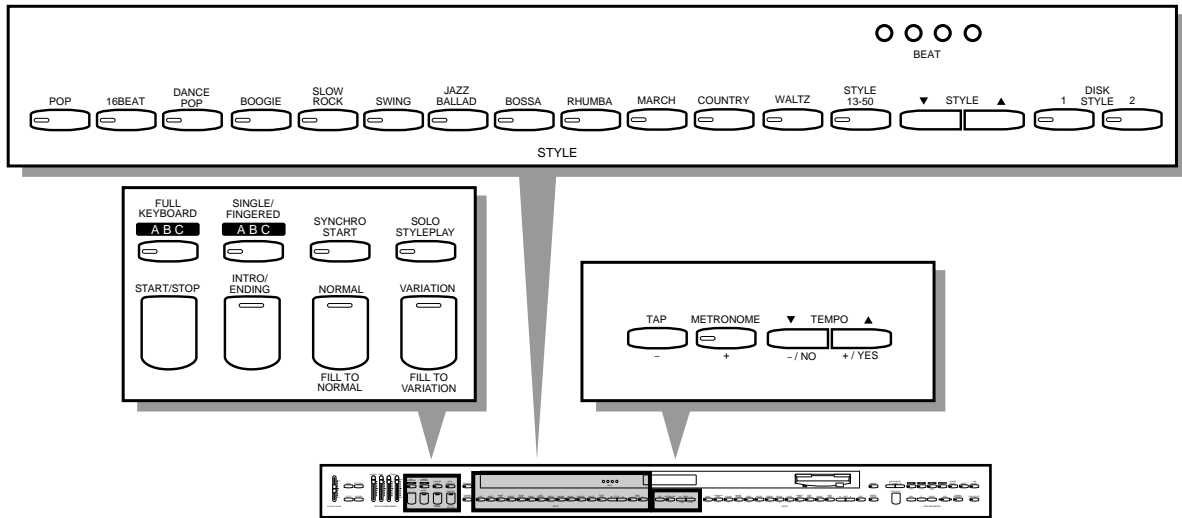

Style Selection

● Styles 1-12: Direct Panel Selection

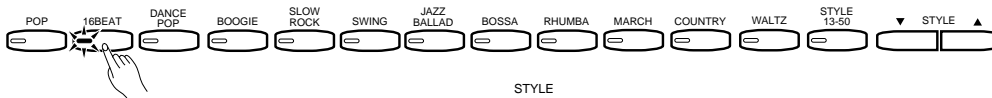

```
[ 001] Piano      1
J= 72 16Beat     2
```

Of the Clavinova’s 50 styles, 12 are “panel styles” which can be directly accessed by pressing the corresponding **STYLE** selector. When a style selector is pressed the corresponding indicator will light and the number and name of the selected style will appear on the display.

The **POP** style is automatically selected when the power is initially turned on.

● The [STYLE 13-50] Button and STYLE [▲]/[▼] Buttons

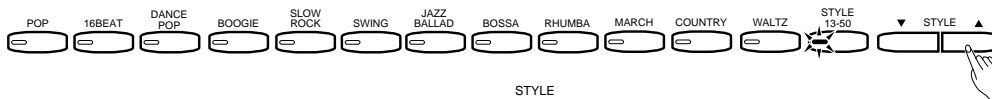

```
[ 001] Piano      1
J=100 8Beat     13
```

Pressing the [STYLE 13-50] button immediately recalls the last style selected in the 13-50 range. The **STYLE** [▲] and [▼] buttons can be used to select a style number between 13 and 50. Press either button briefly to select the next style number in the specified direction, or hold the button for continuous scrolling in the specified direction. The selected style number and name will appear on the display.

The styles 13-50 are organized into categories corresponding to the names of the panel **STYLE** selectors (POP, DANCE POP, 16 BEAT, etc. — see the **STYLE LIST**, below). You can directly jump any category by pressing the **STYLE** [▲] or [▼] button when the corresponding panel **STYLE** selector indicator is lit. To select the “SWING” styles in the 13-50 range, for example, use the **STYLE** [▲] or [▼] button when the [SWING] **STYLE** selector indicator is lit.



```
[ 001] Piano      1
J=208 Bebop     30
```



- The 8 **BEAT** style (number 13) will initially be selected by the [STYLE 13-50] button when the power is turned ON.
- There are also two [DISK STYLE] buttons that can be used to select styles loaded from floppy disk (the supplied Style Disk). See the “Disk Styles” section on page 28 for details.
- Use the **RHYTHM** volume control to adjust the volume of the rhythm sound.

Tempo Control

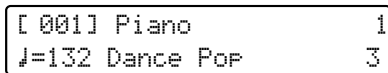
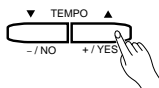

Whenever you select a different style, the preset tempo for that style is also selected, and the tempo is displayed on the display in quarter-note beats per minute (unless the accompaniment is playing, in which case the same tempo is maintained).

You can change the tempo to any value between 32 and 280 beats per minute, however, by using the **TEMPO** [▲] and [▼] buttons. This can be done either before the accompaniment is started or while it is playing. Press either button briefly to decrement or increment the tempo value by one, or hold the button for continuous decrementing or incrementing.



- The preset tempo for the selected style can be recalled at any time by pressing both the [▲] and [▼] buttons simultaneously.
- Automatic style tempo switching can be turned on or off via the "Style Tempo Switching" utility function described on page 61.

Panel Styles (1—12)

1	POP
2	16BEAT
3	DANCE POP
4	BOOGIE
5	SLOW ROCK
6	SWING
7	JAZZ BALLAD
8	BOSSA
9	RHUMBA
10	MARCH
11	COUNTRY
12	WALTZ

Styles 13—50

POP	
13	8BEAT
14	ROCK BAND
15	70'S JAZZ ROCK
16	LATIN ROCK
16BEAT	
17	16BEAT POP
18	16BEAT BALLAD
19	FUNK
20	16BEAT SHUFFLE SOFT
21	16BEAT SHUFFLE
DANCE POP	
22	DISCO
23	TECHNO POP
24	REGGAE

BOOGIE	
25	ROCK'N'ROLL SHUFFLE
26	60'S ROCK'N'ROLL
27	SPEED METAL
28	TWIST
SLOW ROCK	
29	SLOW BLUES
SWING	
30	BEBOP
31	2BEAT SWING
32	DIXIELAND
33	BIG BAND
JAZZ BALLAD	
34	BIG BAND BALLAD
BOSSA	
35	JAZZ BOSSA
36	SAMBA
37	SALSA

RHUMBA	
38	MAMBO
39	CHACHA
40	TANGO
MARCH	
41	MUSICAL
42	POLKA
43	6/8 MARCH
COUNTRY	
44	COUNTRY SHUFFLE
45	COUNTRY SWING
46	COUNTRY ROCK
WALTZ	
47	JAZZ WALTZ
48	VIENNA WALTZ
49	BOSSA WALTZ
50	COUNTRY WALTZ

Starting the Accompaniment

There are several ways to start the accompaniment:

● Straight Start



Press the [START/STOP] button.

Each of the styles also has a variation that can be selected by pressing the [VARIATION/FILL TO VARIATION] button or the right FILL IN bar (its LED will light) before pressing the [START/STOP] button. Normally the [NORMAL/FILL TO NORMAL] button LED will be lit (or you can select it if the variation is selected), indicating that the normal pattern is selected.

Normal straight start = [NORMAL/FILL TO NORMAL] / [Left FILL IN Bar] → [START/STOP]

Variation straight start = [VARIATION/FILL TO VARIATION] / [Right FILL IN Bar] → [START/STOP]



● Start With an Introduction



Press the [INTRO/ENDING] button.

If you press the [NORMAL/FILL TO NORMAL] button (or left FILL IN bar) or the [VARIATION/FILL TO VARIATION] button (or right FILL IN bar) while holding the [INTRO/ENDING] button, the rhythm will start with an appropriate fill and then go to the normal rhythm or variation rhythm, respectively.

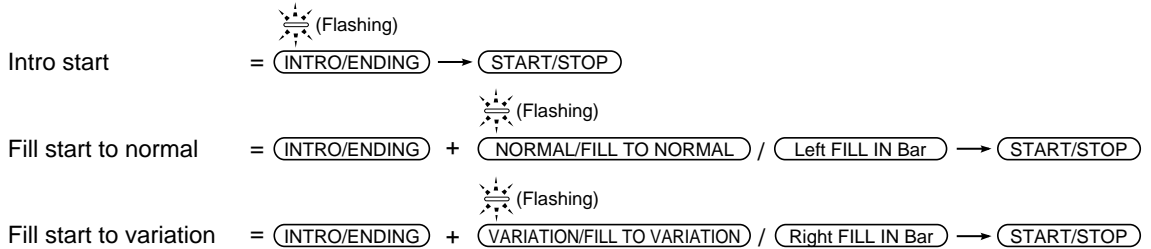

The selected start mode can be disengaged prior to starting the accompaniment by pressing the selected button (flashing indicator) a second time.

● Synchronized Start



Any of the start types described above can be synchronized to the first note or chord played on the keyboard by first pressing the [SYNCHRO START] button so that its indicator lights. When the keyboard is split or Auto Bass Chord Single/Fingered mode is used, the first note played on the left-hand section of the keyboard will start the accompaniment (i.e. keys to the left of and including the split-point key — normally F#2). Once the synchronized start mode has been selected, use the [NORMAL/FILL TO NORMAL], [VARIATION/FILL TO VARIATION] and/or [INTRO/ENDING] buttons to select the type of start you want.

The first dot of the BEAT display will flash at the current tempo when a synchronized start mode has been selected.

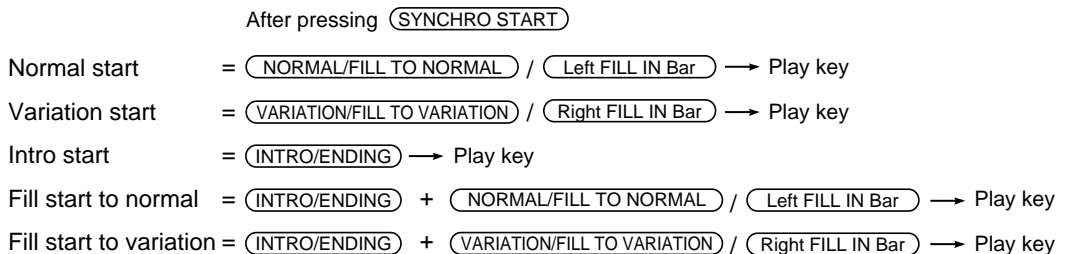

The synchronized start mode can be cancelled by pressing the [SYNCHRO START] button a second time so that its indicator goes out.



- The synchronized start mode is automatically turned on when one of the ABC modes is engaged — see page 21 for details.

● Tap start

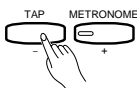

This function lets you set the tempo and start the rhythm in one operation. Simply tap the [TAP] button at the required tempo — 3 times for a 3/4 style and 4 times for a 4/4 style. The rhythm will start from the beginning of the next measure at the specified tempo.



- The [TAP] button can also be used to change the tempo during rhythm playback. In this case the “tap” click will not sound.
- If you tap the [TAP] button less than the required number of times (i.e. 3 or 4), the tap tempo function will be cancelled after a few seconds.



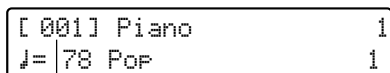

Measure number

1st. Beat	●	○	○	○
2nd. Beat	○	●	○	○
3rd. Beat	○	○	●	○
4th. Beat	○	○	○	●

BEAT

● Measure Number Display

During rhythm playback the current measure number is shown in the upper left-hand corner of the display.

● The Beat Display

The four LED dots of the **BEAT** display provide a visual indication of the selected tempo. The leftmost (red) dot flashes on the first beat of each measure, the second dot flashes on the second beat, and so on (all dots except the leftmost dot are green). When a 3/4-time rhythm is selected, only the first three dots will flash.

■ Fill-ins

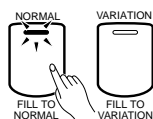

The CVP-89 provides two types of automatic “fill-ins.”

■ **Fill To Normal:** Press the [**NORMAL/FILL TO NORMAL**] button or the left **FILL IN** bar (located in front of the keyboard) during playback to produce a fill-in and go to the normal rhythm.

■ **Fill To Variation:** Press the [**VARIATION/FILL TO VARIATION**] button or the right **FILL IN** bar during playback to produce a fill-in and go to the variation pattern.

If you hold one of the **FILL** buttons or bars, the fill-in will repeat until the end of the measure in which button is released.

■ Left-pedal Rhythm Break

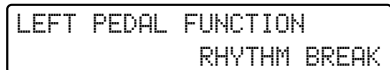

When the left-pedal function is set to “Rhythm Break” as described on page 15, the left pedal can be used to create a break in the rhythm while playing. Press and release the left pedal to stop the rhythm. Rhythm playback will resume from the top of the next measure. You can also hold the left pedal for longer breaks — the rhythm will resume from the top of the next measure after the pedal is released. The break can be cancelled before the beginning of the next measure by pressing the pedal a second time.

■ Stopping the Accompaniment

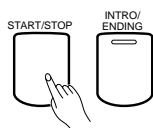

The accompaniment can be stopped at any time by pressing the [**START/STOP**] button. Press the [**INTRO/ENDING**] button if you want to go to the ending pattern and then stop.



- If you started with an intro or fill-in, or using the **SYNCHRO** mode, these selections are maintained even after the accompaniment is stopped.
- If the left pedal is switched to **START/STOP** operation, it performs the same function as the panel [**START/STOP**] buttons (press to **START**, press again to **STOP**).

■ Metronome

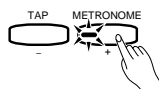

The CVP-89 also offers a metronome function that is ideal for practice.

To start the metronome, simply press the [**METRONOME**] button so that its indicator lights. The metronome will play at the currently selected tempo whether a style is playing or not. The metronome volume can be adjusted via the **RHYTHM** volume control.

Press the [**METRONOME**] button again to stop the metronome sound (the **METRONOME** indicator will go out). The metronome will also stop automatically if the [**START/STOP**] button is pressed to stop a style in progress.



- If the style is started by pressing the [**START/STOP**] button while the metronome is playing, the metronome will continue to sound along with the style.

The CVP-89 includes a sophisticated auto-accompaniment system (Auto Bass Chord — ABC) that can provide automated rhythm, bass and chord backing in a number of ways.

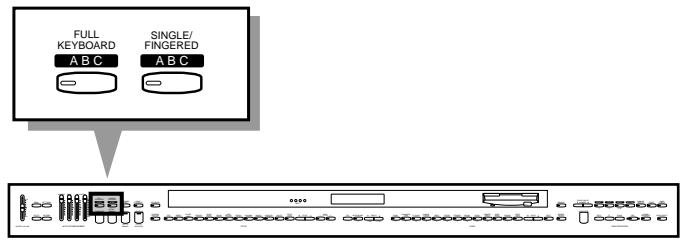

Single-Finger & Fingered Accompaniment

This mode lets you create accompaniment in two ways.

“Single Finger” accompaniment makes it simple to produce accompaniment using major, seventh, minor and minor-seventh chords by pressing a minimum number of keys in the ABC section of the keyboard. The automatic accompaniment consists of rhythm, bass and chords.

“Fingered” accompaniment is ideal if you already know how to play chords on a keyboard, since it allows you to supply your own chords for the Auto Accompaniment feature.

1 Select SINGLE/FINGERED

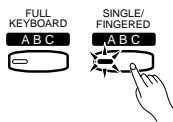

Press the [SINGLE/FINGERED] button to select the SINGLE/FINGERED mode (the SINGLE/FINGERED indicator will light).

2 Select a Style

Select an accompaniment style using the style selectors (see “Style Selection” on page 17).

3 Set the Tempo

Use the TEMPO [▲] and [▼] buttons to set the desired accompaniment tempo if necessary (see “Tempo Control” on page 18 for more details).

4 Play

● Single-finger Accompaniment

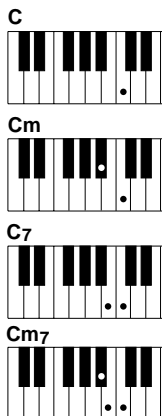

Pressing any key on the ABC section of the keyboard (up to the split point — normally the F#2 key) will cause the automatic chord and bass accompaniment to begin (synchro start is automatically selected in the ABC mode). If you press a “C” key, for example, a C-major accompaniment will be played. Press another key in the ABC section of the keyboard to select a new chord. The key you press will always determine the “root” of the chord played (i.e. “C” for a C chord). The name of the detected chord will appear on the display.

Single-finger minor, seventh, and minor-seventh chords can be played as follows:

- For a minor chord, press the root key and the black key to its left.
- For a seventh chord, press the root key and the white key to its left.
- For a minor-seventh chord, press the root key and both the white and black key to its left.

Any other two-note fingerings that do not fit the above rules will produce a chord based on the previous chord.



● **Fingered Accompaniment**

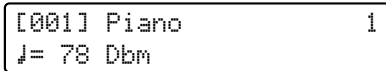

As soon as you play any chord (up to 4 notes) on the lower keyboard (up to the split point — normally the F#2 key), the Clavinova will automatically begin to play the chord along with the selected rhythm and an appropriate bass line (synchro start is automatically selected in the ABC mode*). The name of the detected chord will appear on the display. If the chord played is not recognized by the CVP-89, only the root note will be displayed followed by an asterisk (“*”).

* Automatic synchro start switching can be enabled or disabled via the “Auto Synchro Start Switching” function, described on page 62.

The Clavinova will accept the following 20 chord types in the Fingered Accompaniment mode:

- Major
- Minor [m]
- Major seventh [M7]
- Sixth [6]
- Seventh [7]
- Minor sixth [m6]
- Minor seventh [m7]
- Minor major seventh [mM7]
- Minor seventh flattened fifth [m7(♭5)]
- Minor flattened fifth [m(♭5)]
- Flatted fifth [(♭5)]
- Seventh flatted fifth [7(♭5)]
- Major seventh flatted fifth [M7(♭5)]
- Seventh suspended fourth [7sus4]
- Suspended fourth [sus4]
- Augmented [aug]
- Seventh sharp fifth [7(#5)]
- Major seventh sharp fifth [M7(#5)]
- Diminished [dim]
- Minor major seventh flatted fifth [mM7(♭5)]

“On-bass” chords can be produced by playing 5-note chords. the lowest note specifies the bass note while the upper 4 (or 3 if the 4-note chord is not recognized) specify the chord.



• The automatic accompaniment will sometimes not change when related chords are played in sequence (e.g. some minor chords followed by the minor seventh).

- The [INTRO/ENDING], [NORMAL/FILL TO NORMAL], and [VARIATION/FILL TO VARIATION] buttons can be used in the ABC mode to create pattern variations in the same way that they are used with rhythm patterns (refer to the “Accompaniment” section on page 18, 19 for details).

- Normal start = [NORMAL/FILL TO NORMAL] / [Left FILL IN Bar] → Lower key
- Variation start = [VARIATION/FILL TO VARIATION] / [Right FILL IN Bar] → Lower key
- Intro start = [INTRO/ENDING] → Lower key
- Fill start to normal = [INTRO/ENDING] + [NORMAL/FILL TO NORMAL] / [Left FILL IN Bar] → Lower key
- Fill start to variation = [INTRO/ENDING] + [VARIATION/FILL TO VARIATION] / [Right FILL IN Bar] → Lower key

5 Stop the Accompaniment

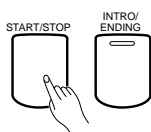

Press the [START/STOP] or [INTRO/ENDING] button to stop the accompaniment.



• Press the [SINGLE/FINGERED] button so that its indicator goes out when you want to exit from the SINGLE/FINGERED mode.

Full-keyboard ABC

● **Full-keyboard ABC**

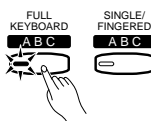

When this advanced auto-accompaniment mode is engaged (press the [FULL KEYBOARD] button so that its indicator lights) the Clavinova will automatically create appropriate accompaniment while you play just about anything, anywhere on the keyboard: chords, a bass line, arpeggiated chords, a melody line. The name of the detected chord will appear on the display. You don’t have to worry about specifying the accompaniment chords. Although Full-keyboard ABC is designed to work with many songs, some arrangements may not be suitable for use with this feature. Try playing a few simple songs in the Full-keyboard ABC mode to get a feel for its capabilities.



• Chord detection occurs at approximately 8th-note intervals. Extremely short chords — less than an 8th note in length — may therefore not be detected.



● **Conventional Full-keyboard ABC**

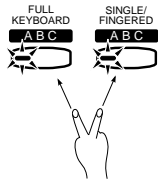

The Conventional Full-keyboard ABC mode can be engaged by pressing the [FULL KEYBOARD] and [SINGLE/FINGERED] buttons simultaneously (both indicators will light). In this mode the split point is de-activated and notes played anywhere on the keyboard are detected and used to determine the harmonization of the accompaniment. In the Conventional Full-keyboard ABC mode, chord detection is possible when at least three notes are played anywhere on the keyboard. The name of the detected chord will appear on the display.



- 2-note fingerings are not recognized in the Conventional Full-keyboard ABC mode.
- If more than 5 notes are played in the Conventional Full-keyboard ABC mode, the lowest 4 notes are used to specify the chord.
- The (b5), 7(b5), M7(b5), and mM7(b5) chord types included in the list on the previous page are not recognized in the Conventional Full-keyboard ABC mode.
- The Dual or SPLIT mode can be used with Full-keyboard ABC.
- The Full-keyboard and Conventional Full-keyboard ABC modes will be disengaged and the Single/Fingered mode will be engaged if Solo Styleplay is turned on.
- Solo Styleplay will automatically be turned off whenever the Full-keyboard or Conventional Full-keyboard ABC mode is engaged.
- Press the [FULL KEYBOARD] button so that its indicator goes out when you want to exit from the Full-keyboard ABC mode. To exit from the Conventional Full-keyboard ABC mode press the [FULL KEYBOARD] or [SINGLE/FINGERED] button twice.

■ **Volume Control**

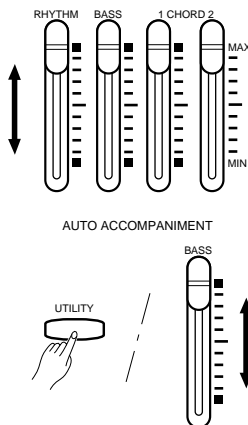

The **RHYTHM**, **CHORD 1**, **CHORD 2**, and **BASS** volume controls can be used to adjust the volume of the corresponding accompaniment parts when using ABC. In general, **CHORD 1** controls rhythmic chords while **CHORD 2** controls more decorative chords (arpeggios, etc.). The volume of the keyboard can be independently controlled by using the **BASS** volume control while holding the [UTILITY] button.



- Some styles may not use all four parts: RHYTHM, CHORD 1, CHORD 2, and BASS.

■ **Changing the ABC Split Point**

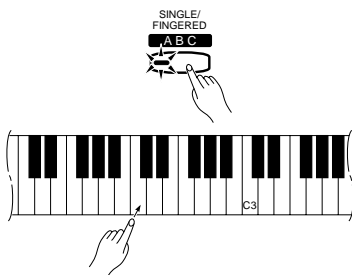

The ABC split point can be set at any key by pressing the desired key while holding the [SINGLE/FINGERED] button. The specified split point will appear on the display.

The default split point — F#2 — will always be set automatically whenever the power is initially turned on.



- The split point is indicated by the keyboard guide lamp above the split point key.

■ **Special Modes**

● **Mute**

Some accompaniment notes may be automatically muted if they interfere musically with what is being played by the right hand. This mute function can be enabled or disabled via the “ABC Auto Mute” function described on page 64. The mute function is normally enabled (default).

● **Minor Harmonization**

When playing a 7th chord in a minor key, the ABC system will automatically shift a 9th note down to the octave, and a 6th note to the 5th when the “Minor Harmonization” function described on page 64 is turned on. The default setting for this function is off.

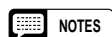

- Minor Harmonization will not function in the Full Keyboard ABC mode.



Custom Rhythm

The CVP-89 CUSTOM RHYTHM feature allows you to create 12 original rhythm patterns that can be later recalled and played at any time, just like the presets. Each custom rhythm pattern can be “stored” in any of the CVP-89’s 12 panel style memory locations.

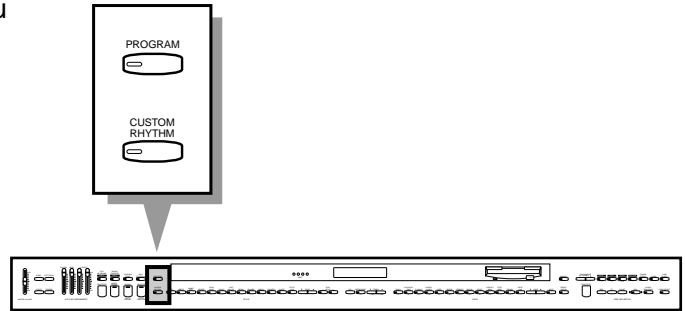

Creating an Original Rhythm Pattern

1 Select a Rhythm

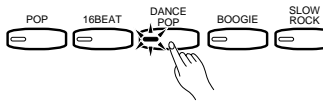

Begin by selecting one of the preset rhythms (NORMAL or VARIATION), a previously-recorded custom rhythm, or a loaded disk style rhythm (NORMAL or VARIATION) that is close to the rhythm you want to create. For example, select a WALTZ rhythm if you want to program a rhythm pattern in 3/4 time. You cannot program a 3/4 rhythm when a 4/4 rhythm is selected, and vice versa.

2 Press [PROGRAM]

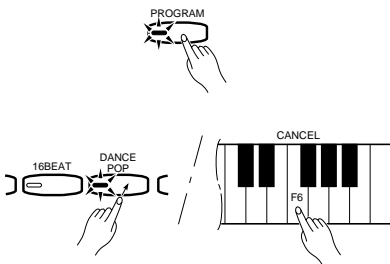

Press the [PROGRAM] button so that its LED indicator lights. The selected rhythm will begin playing.

- When the PROGRAM mode is engaged, the LED indicators for all rhythm selectors that currently contain custom rhythm data will glow green. Any previously programmed and stored custom rhythm pattern can be erased from memory by pressing the corresponding rhythm button while holding the [CANCEL] (F6) key.

3 Set the Required Resolution

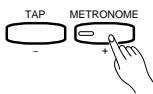

The initial resolution for custom rhythm programming is 16th (for doublet-type beats) or 12th notes (for triplet-type beats): “QUANTIZE ON” will appear on the display when the PROGRAM mode is engaged. This means that all entered notes will be adjusted to fall on the nearest 16th or 12th beat. If you need greater resolution for free-tempo passages, switch to 96th-note resolution by pressing the [TAP] key (“QUANTIZE OFF” will appear on the display). You can return to 16th (12th) note resolution at any time by pressing the [METRONOME] button.

4 Enter the Rhythm

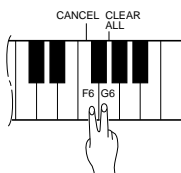

- If you want to create a totally new rhythm from scratch, press the [CLEAR ALL] (G6) key and the [CANCEL] key simultaneously before beginning to program. This cancels all the instruments in the original accompaniment, leaving only a metronome sound (the metronome sound is not recorded).



5 Cancel Instruments & Correct Mistakes as Required

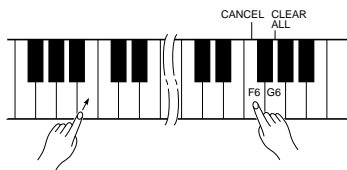

Although you can cancel all instruments in a pattern by pressing the [CLEAR ALL] and [CANCEL] keys, it is also possible to cancel a single instrument to erase a mistake or simply eliminate an unwanted instrument. While holding the [CANCEL] key, press the key corresponding to the instrument you want to cancel. The selected instrument should now be cleared from the pattern.

6 Save the Custom Rhythm

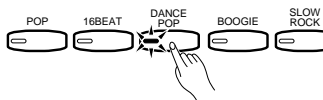

When your custom rhythm is complete, press the **STYLE** selector with which you want the new rhythm to be associated. The **STYLE** selector indicator will glow green. This saves the custom rhythm in the selected style button. Then press the [PROGRAM] button to exit the custom rhythm programming mode (the PROGRAM indicator will go out). If you want to stop programming without saving the rhythm pattern, simply press the [PROGRAM] button so that its LED indicator goes out.

NOTES

- The following patterns can be individually programmed for each Custom Rhythm:
 Basic pattern x 1 (NORMAL)
 Fill-in x 2 (FILL IN 1/2)
 Intro x 1 (INTRO)
 Ending x 1 (ENDING)
- If a FILL IN button or bar is pressed prior to programming, it is possible to program a one-measure custom fill-in (2 types). Custom INTRO/ENDING patterns can also be programmed: press the [INTRO/ENDING] button while the rhythm is running to program a custom ending, or while the rhythm is stopped to program a custom intro. The intro or ending pattern will be the same length as the original (8 measures maximum).
- Up to 8 notes can be played simultaneously.
- The drum kit, reverb, and pan settings for the custom rhythm can be changed as required via the "Edit Drum Instrument" function described on page 63.

Playing Back Your Custom Rhythm Pattern



Once created, your original rhythm pattern can be played back by pressing the [CUSTOM RHYTHM] button (its LED will light), the style selector button into which it was stored, and then the [START/STOP] button. Press the [START/STOP] button to stop playback. Your CUSTOM RHYTHM can also be used as the basis for ABC accompaniment.

NOTES

- If ABC is used with a Custom Rhythm pattern, the ABC program of the original style will be used. If the original style is a disk style, however, no ABC sound will be produced unless that disk style is loaded.
- No sound will be produced if the selected Custom Rhythm style contains no data.
- Custom Rhythm data will be backed up for approximately one week.
- A set of 12 custom rhythms can be saved to and loaded from disk as described on page 45, 46.



A "Style Disk" is supplied with the Clavinova, providing an extra 50 ABC accompaniment styles. Any two of these patterns can be loaded into the Clavinova's memory at a time. The [DISK STYLE 1] and [DISK STYLE 2] buttons select the loaded disk styles in the same way as the STYLE selectors select the internal styles.

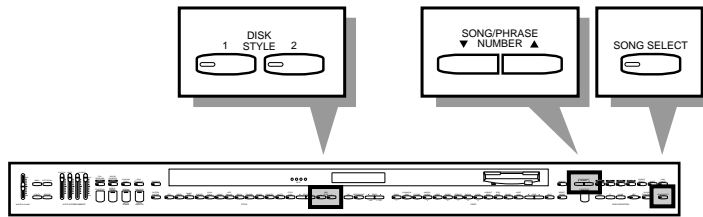

NOTES

- If no disk styles are loaded as described below, the [DISK STYLE 1] and [DISK STYLE 2] buttons select pre-programmed disk styles contained in internal ROM memory.
- Loaded disk styles will be retained in memory for about one week if the CVP-89 power is not turned on during that time. To keep the loaded disk styles for longer periods, turn the power ON briefly at least once a week.
- Style disk data can be copied to a different disk — see page 47.

Selecting & Loading Disk Styles

1 Insert the Style Disk

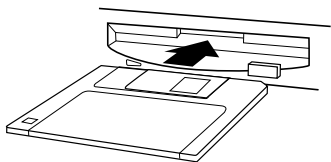

Insert the Style Disk into the disk drive with the sliding door on the disk facing the drive slot and the label side facing upward. The disk should click into place and the disk lamp will light briefly while the Clavinova reads and identifies the disk.

2 Make Sure the [SONG SELECT] Indicator Is Lit



The [SONG SELECT] indicator will light automatically when the disk is ready. If a disk is already loaded and the [SONG SELECT] indicator is not lit, press the [SONG SELECT] button so that it lights. When this is done the [DISK STYLE 1] and [DISK STYLE 2] button indicators will flash alternately, and the SINGLE/FINGERED ABC mode and synchronized start mode will be engaged (any other ABC mode will remain active if it was selected before the disk was loaded).

3 Select a Style

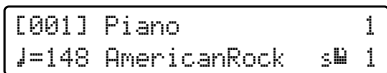

Use the SONG/PHRASE NUMBER [▲] and [▼] buttons to select the desired style number. The selected style number, style name, and the current tempo will appear on the display. Also, an "s" will appear in front of the disk symbol on the display to indicate that a disk style is selected. You can "preview" the selected style by playing on the left-hand section of the keyboard (single-finger or fingered). Pattern playback will stop if a different pattern number is selected.

NOTES

- If a tempo is set prior to loading the style, that tempo becomes the default for the loaded style.

4 Load the Style

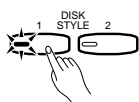

Press the [DISK STYLE 1] or [DISK STYLE 2] button to load the selected pattern into that button. The [DISK STYLE 1] or [DISK STYLE 2] indicator will light, and the [SONG SELECT] indicator will go out.



5 Repeat

Repeat steps **2** through **4** to select and load a second pattern into the other [DISK STYLE] button if you like.

6 Eject the Disk When Done

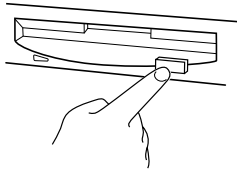

When you've finished with the Style Disk, press the disk drive **EJECT** button to remove it.

Disk Style List

Group	No.	Name
ROCK	1	AMERICAN ROCK
	2	ROCK'N'ROLL
	3	ROCK CLASSIC
	4	ROCKABILLY
	5	FIGHTING ROCK
	6	60'S ROCK SHUFFLE
POP	7	8BEAT 2
	8	POP BALLAD
	9	FOLK
	10	MUSIC BOX
	11	NEW AGE POP
	12	COMPUTER GAME
	13	16 BEAT POP BALLAD
	14	16 BEAT SHUFFLE 2
DANCE POP	15	DANCE 8BEAT
	16	DANCE POP 2
	17	HOUSE POP
	18	POWER HOUSE
	19	FUNK 2
	20	REGGAE 2
JAZZ	21	BIG BAND 2
	22	BIG BAND 3
	23	CONTEMPORARY JAZZ
	24	CHARLESTON
	25	AFRO-CUBAN
	26	SWING WALTZ

Group	No.	Name
LATIN	27	CALYPSO
	28	BOSSA SOFT
	29	SAMBA 2
	30	SALSA 2
	31	BIG BAND CHACHA
MUSICAL & NOVELTY	32	BROADWAY
	33	SHOW TIME
	34	PIT ORCHESTRA 1 (VAUDEVILLE)
	35	PIT ORCHESTRA 2 (SWING)
	36	PIT ORCHESTRA 3 (POPULAR)
	37	SNARE ROLL & PRIZE WINNER
	38	CLOCK
	CLASSIC	39
40		POP BAROQUE 1
41		POP BAROQUE 2
42		QUASI BAROQUE
43		OVERTURE 1
44		OVERTURE 2
WORLD	45	URBAN WALTZ
	46	CHANSON
	47	BOLERO
	48	CHINESE POP
	49	ARABIAN POP
	50	AFRICAN POP

Using a Loaded Disk Style

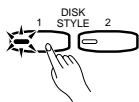

```
[ 001] Piano           1
J=148 AmericanRock   51
```

After you've loaded the desired Disk Styles, the [DISK STYLE 1] and [DISK STYLE 2] buttons can be used in exactly the same way as the other STYLE buttons to select the loaded patterns for ABC accompaniment (see "Auto Bass Chord (ABC)" beginning on page 21).

The name of the Disk Style selected by the [DISK STYLE 1] or [DISK STYLE 2] button will be shown on the display. Also, the numbers "51" and "52" will appear when DISK STYLE 1 and DISK STYLE 2 are selected, respectively.



Solo Styleplay

This sophisticated feature not only provides automatic rhythm, bass and chord accompaniment, but it also adds appropriate harmony notes (two or three harmonized notes) to a melody you play on the upper keyboard.

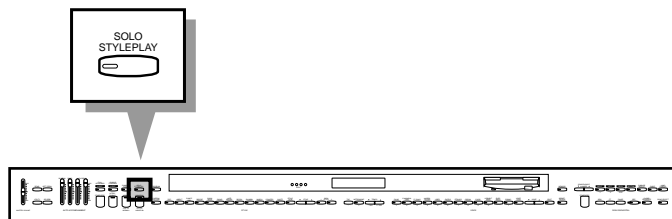

Using Solo Styleplay

1 Turn Solo Styleplay ON



Press the [SOLO STYLEPLAY] button to turn the **SOLO STYLEPLAY** mode on. The **SINGLE/FINGERED** mode is automatically selected when **SOLO STYLEPLAY** is turned on. If a **FULL KEYBOARD** mode is selected, the **SINGLE/FINGERED** mode will automatically be selected since Solo Styleplay cannot be used with the **FULL KEYBOARD** modes.

2 Select a Style

Select an accompaniment style using the style selectors (see “Style Selection” on page 17). An appropriate voice for the selected style will automatically be selected, but you can also select any other voice after selecting the style.

3 Set the Tempo

Set the desired tempo if necessary using the **TEMPO** [▲] and [▼] buttons (see “Tempo Control” on page 18).

4 Play

Play the required chords (single-finger or fingered) on the ABC section of the keyboard while playing a melody line on the upper keyboard (for some styles, only one note can be played at a time on the right-hand section of the keyboard in the Solo Styleplay mode).

5 Stop the Accompaniment

Press [START/STOP] or [INTRO/ENDING] to stop the accompaniment.

6 Turn Solo Styleplay OFF

Press the [SOLO STYLEPLAY] button again to turn the function off.

Harmonization Variations

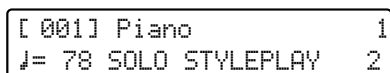
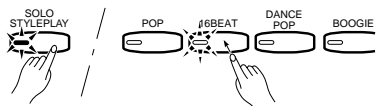

It is possible to apply the harmonization type and voice from a different style to the selected style by pressing the style selector corresponding to the harmonization type you want to use (except for the [DISK STYLE 1/2] selector) while holding the [SOLO STYLEPLAY] button — the selected **STYLE** button indicator will flash and the selected style number will appear on the display while the [SOLO STYLEPLAY] button is held. This makes it possible, for example, to use the solo styleplay harmonization type and voice from the 16 BEAT style when actually playing in the POP style.

The Left Pedal & Solo Styleplay

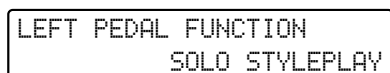

If the **LEFT PEDAL** function is set to **SOLO STYLEPLAY** after the **SOLO STYLEPLAY** mode is selected, harmonization of notes played on the right-hand section of the keyboard only occurs while the left pedal is pressed. This allows you to combine normal ABC type performance with **SOLO STYLEPLAY** as required.



• The **SOLO STYLEPLAY** mode will be disengaged if the ABC **SINGLE/FINGERED** mode is turned off or the **FULL KEYBOARD ABC** mode is turned on.



The CVP-89 Registration Memory feature can be used to memorize 12 complete control-panel setups that you can recall whenever needed.

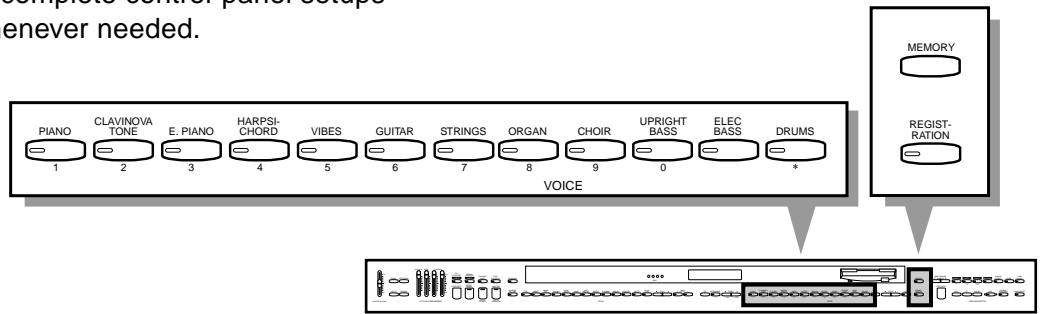

Memory Store

1 Make the Desired Control Settings

Set the CVP-89 panel controls to the state you want to memorize. The settings that are memorized by the Registration Memory are listed below.

Settings Stored By the Registration Memory

- ABC On/Off
- Solo Styleplay On/Off
- Solo Styleplay Variation
- Voice Number
- Manual Volume
- Style Number
- Style Variation
- Tempo
- Rhythm Volume
- Chord 1 Volume
- Chord 2 Volume
- Bass Volume
- Split Point
- Dual/Split Mode
- Dual/Split Voice
- Dual/Split Balance
- Reverb Type
- Reverb Depth
- Left Pedal Function
- Intro
- Touch Sensitivity
- Pitch Bend Range (for the selected voice only)
- Chorus On/Off (for the selected voice only)
- Soundboard Effect Depth

2 Memorize the Settings

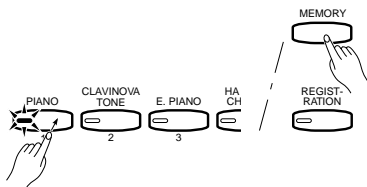

Press one of the **VOICE** selectors while holding the **[MEMORY]** button. The indicator of the pressed voice selector will glow green indicating that the panel data has been memorized in that location.

Recall

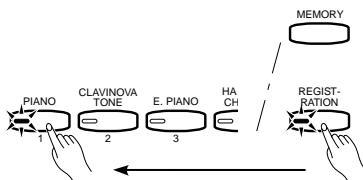

Simply press the appropriate **VOICE** selector after pressing the **[REGISTRATION]** button (the **[REGISTRATION]** button indicator should be lit) to recall the memorized settings (the indicator of the selected **VOICE** selector will glow green). The recalled voice, style, and tempo will appear on the display. Once recalled, press the **[REGISTRATION]** button again so that its indicator goes out to return to the normal play mode.

NOTES

- If **DISK STYLE 1** or **DISK STYLE 2** is stored in the registration memory, the same disk style must be assigned to the same button (**[DISK STYLE 1]** or **[DISK STYLE 2]**) when the memory is recalled otherwise the currently assigned disk style will sound.
- The contents of all 12 Registration Memory locations can be saved to and loaded from disk using the **Save Registration** and **Load Registration** utilities described on page 44.
- The **Registration Tempo** utility function described on page 64 determines whether the tempo setting included in the registration memory data will be used when a registration memory is recalled.
- Registration data is retained in the Clavinova memory for about one week even if the **POWER** is not turned on. To keep the data in memory for longer periods, turn the **POWER** switch on briefly at least once a week.
- 12 "preset" sets of registration data are stored in the 12 memory locations when the CVP-89 is initially shipped.

Using Yamaha Disk Orchestra disks (one is supplied with the CVP-89, others are available from Yamaha), the Clavinova will let you enjoy listening to automated performances, or function as your “private music tutor,” allowing you to practice various parts of a piece while the others are played automatically. The CVP-89 also shows you which keys to play with keyboard guide lamps that light up above each key. You can also play “in ensemble” with the complete Disk Orchestra arrangement.



- The Disk Orchestra Collection playback data is not transmitted via the MIDI OUT connector.

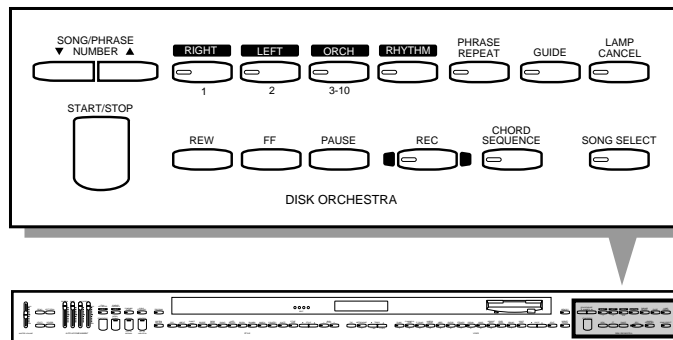

Automatic Performance

1 Insert a Disk Orchestra Disk

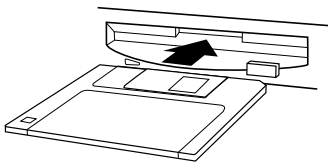

Insert the **DISK ORCHESTRA** disk into the disk drive with the sliding door facing the drive slot and the label side facing upward. The disk should click into place and the disk lamp will light briefly while the Clavinova reads and identifies the disk.



- If a disk is already loaded and the [SONG SELECT] indicator is out, press the [SONG SELECT] button so that the indicator lights before proceeding.

2 Select a Song Number

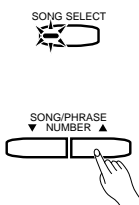

```
[001] Piano      1
J=144 MINUET(BACH)  ALL
```



When the disk is inserted the [SONG SELECT], [RIGHT/1], [LEFT/2], [ORCH/3-10], and [RHYTHM] indicators will light if the corresponding tracks contain performance data, and the selected song number and name will be shown on the display along with the current tempo. Use the **SONG/PHRASE NUMBER** [▲] and [▼] buttons to select the desired song number. Select “ALL” if you want all songs on the disk to be played and repeated until playback is stopped.

- You can also start sequential repeat playback by using the [▲] and [▼] buttons to select the song number from which playback is to begin, and then pressing the [START/STOP] button while holding the [UTILITY] button.
- The songs can be made to play back and repeat either in sequence or in random order when “ALL” is selected or when starting playback by pressing the [START/STOP] button while holding the [UTILITY] button, and playback is started, depending on the setting of the “Random All Song Repeat” function (page 62).

3 Start Playback

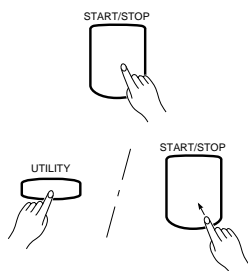

Start playback of the selected song by pressing either the **DISK ORCHESTRA** [START/STOP] button or the **ABC** [START/STOP] button. Unless “ALL” is selected, the selected song will play through to the end and playback will stop automatically. It is also possible to automatically play all songs from the currently selected song repeatedly by pressing the [START/STOP] button while holding the [UTILITY] button. The current measure number will be shown on the display during playback, and the voice indicator used for the RIGHT/1TR and LEFT/2TR parts will light. The voice can be changed as required via the **VOICE** selectors.

Playback can be stopped at any time by pressing the **DISK ORCHESTRA** or **ABC** [START/STOP] button.

NOTES

- Please note that playback cannot be started while the Clavinova is searching the disk for a selected song (a flashing dot following the song name on the display indicates that the Clavinova is searching).
- With some songs the displayed measure numbers may not match those marked on the score.
- Some songs start after a click count-in.
- The playback tempo can be changed freely as required. The preset tempo for the selected song can be recalled at any time by pressing the TEMPO [▲] and [▼] buttons simultaneously.
- Some Disk Orchestra software does not produce a tempo display (e.g. free-tempo phrases, etc.). In this case, three dashes appear in place of the tempo on the display, and the measure numbers shown on the display will not match the actual measure numbers of the song.
- The keyboard guide lamps corresponding to the keys being played will light in real time. The keyboard guide lamps can be turned off by pressing the [LAMP CANCEL] button.

4 Eject the Disk When Done

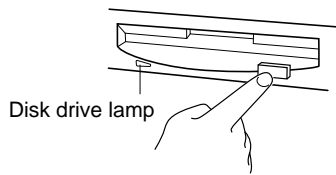

When you've finished with the currently loaded disk, simply press the disk drive EJECT button to remove it.

CAUTION

- NEVER eject a disk or turn the power off while:
1. The disk drive lamp is on.
 2. The DISK ORCHESTRA function is playing.

Playing Back only Specific Parts

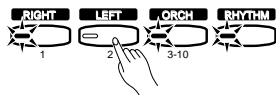

The [RIGHT/1], [LEFT/2], [ORCH/3-10], and [RHYTHM] buttons can be used to select playback of specific parts. The [LEFT/2] button turns the left-hand part on or off, the [RIGHT/1] button turns the right-hand part on or off, the [ORCH/3-10] button turns the ORCHESTRA parts on or off, and the [RHYTHM] button turns the rhythm part on or off. When a part is on, the corresponding LED indicator lights. You can, for example, turn off the right and/or left-hand parts so you can practice them on the keyboard.

Turning Individual Orchestra Parts On or Off

Normally the [ORCH/3-10] button turns all the orchestra parts (tracks 3 through 10)* on or off at once. You can, however, turn these parts on or off individually. There are two ways to do this:

* Some software may actually have 15 or 16 tracks, indicated by numbers "1" through "9" and letters "A" through "E" and "R" or "A" through "G" on the display, depending on the type of data.

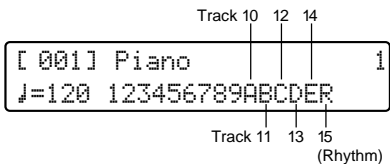

Via the Keyboard

Turn the desired tracks on or off by pressing the keys shown in the illustration to the left while holding the [ORCH/3-10] button (the current status of the tracks is shown on the display while the [ORCH/3-10] button is held):

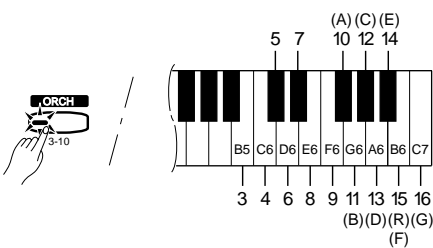

Press the key once to move the cursor to the tracks on the display, and a second to turn the track on or off. The status of the track is indicated by the track number (or letter):

No number	No data
Flashing number	Playback off
Lit number	Playback on

Via the Panel Controls

Use the [TAP] and [METRONOME] buttons while holding the [ORCH/3-10] button to move the cursor on the display to the number of the track you want to turn on or off, then, still holding the [ORCH/3-10] button, use the TEMPO [▲] and [▼] buttons to turn the track on or off.

NOTES

- With DOC, Performance Memory, and Disklavier data, only the numbers of tracks containing data appear on the display. With most other types of data all tracks are displayed whether they contain data or not.

In addition to the main display, the status of tracks 3 through 16 is indicated by the corresponding keyboard guide lamps while the [ORCH/3-10] button is held. If a lamp is out, the corresponding track contains no data. A flashing lamp indicates that playback is off, and a lit lamp indicates that playback is on.

Volume Control

- RHYTHM** Drum and Percussion parts (track 15).
- BASS** Bass part (track 3).
- CHORD 1** Other backing parts except Bass (track 4-10).
- CHORD 2** Main left- and right-hand parts (tracks 1 & 2).

During **DISK ORCHESTRA** playback use the **RHYTHM** volume control to adjust the volume of the drum and percussion parts, the **CHORD 2** volume control adjusts the volume of the main left- and right-hand parts, the **CHORD 1** volume control adjusts the volume of all other parts except the bass, and the **BASS** control adjusts the volume of the bass part.



- When a different song is selected the volume settings will correspond to those in the song data, regardless of the positions of the volume controls.

Guided Right- and Left-hand Practice

After turning on...

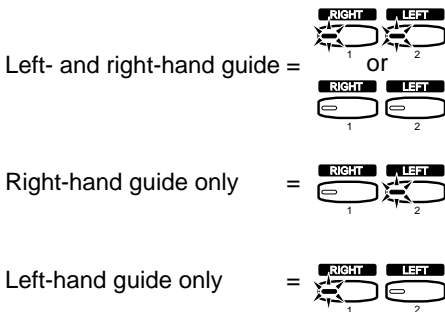

With this feature, the Clavinova waits for you to play the appropriate keys before playing ahead, so you can learn to play the piece at your own pace.

Press the **[GUIDE]** button so that its indicator lights to turn the guide mode on. The settings of the **[RIGHT/1]** and **[LEFT/2]** buttons will then determine whether the guide function operates for the left-hand part only, the right-hand part only, or both the right- and left-hand parts, as shown to the left.

When you press the **[START/STOP]** button to begin playback, the introduction will play automatically but then the Clavinova will stop and wait for you to play the next key(s). The CVP-89 indicates the next key(s) to be played via the guide lamps above the keyboard. As you play the appropriate keys, the piece will continue, pausing until you play the right keys each time.

As with automated performance, the song will stop automatically when the end is reached, or it can be stopped at any time by pressing the **[START/STOP]** button.



- Disk Orchestra playback tempo can be set to any desired value after a song has been selected by using the **TEMPO** [**▲**] and [**▼**] buttons.
- The positions of the guide lamps do not change if the transpose function is used to transpose the pitch of the keyboard.
- If the guide lamps flashing above the keyboard distract you, or you want to try playing along without them, simply press the **[LAMP CANCEL]** button so that its indicator lights. Repeat to turn the guide lamps back on.
- The **[PAUSE]**, **[REW]** and **[FF]** buttons will not operate when the guide function is in use.

● Guide Modes

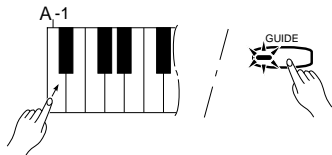

```
[ 001] Piano 1
♩=120 GUIDE
```

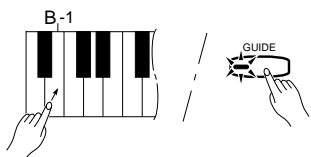

```
[ 001] Piano 1
♩=120 GUIDE 2bar
```

The Clavinova has two guide modes which can be selected as follows:

● Normal Wait:

This mode is automatically selected when the power is turned on. It can also be selected by pressing the **A-1** key (the lowest key) while holding the **[GUIDE]** button. The **A-1** guide lamp will light while the **[GUIDE]** button is pressed.

In the normal wait mode the Clavinova will wait until the appropriate key or chord, as indicated by the keyboard guide lamps, is played before proceeding to the next note.

● Delayed Wait:

This mode can be selected by pressing the **B-1** key (the second-to-lowest white key) while holding the **[GUIDE]** button. The **B-1** guide lamp will light while the **[GUIDE]** button is pressed.

In the delayed wait mode the Clavinova will play ahead for 8 quarter-note beats (two measures in 4/4 time) and then wait until the appropriate key or chord, as indicated by the keyboard guide lamps, is played.



Repeat Functions

● Phrase Repeat

Use this function if you want to practice a specific phrase within a song, as indicated by the phrase marks on the Disk Orchestra Collection score.

1 Select a Song

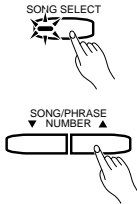

Press the [SONG SELECT] button so that its indicator lights and select the desired song by using the SONG/PHRASE NUMBER [▲] and [▼] buttons.

2 Turn Phrase Repeat ON and Select a Phrase Number

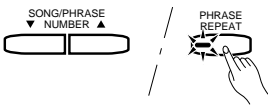

Press the [PHRASE REPEAT] button (its LED indicator will light). When this is done the phrase number will appear on the display. Use the SONG/PHRASE NUMBER [▲] and [▼] buttons to select the desired phrase number (refer to the DISK ORCHESTRA COLLECTION book that comes with the DISK ORCHESTRA COLLECTION disk).



3 Select a Part to Practice



Use the [RIGHT/1], [LEFT/2], [ORCH/3-10], and [RHYTHM] buttons to turn playback of the various parts on or off, as required.

4 Start Playback



Press the [START/STOP] button to begin playback of the selected phrase after a one-measure count-in. Phrase playback will repeat until the [START/STOP] button is pressed a second time.



- The count-in may not sound with some songs — e.g. those that do not include a rhythm track.

● A-B Repeat

This function allows you to specify any section of a DISK ORCHESTRA song for continuous repeat playback.

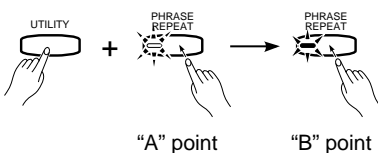

While the song is playing, hold the [UTILITY] and press the [PHRASE REPEAT] button once at the beginning of the section to be repeated (the “A” point) and again at the end of the section to be repeated (the “B” point). Repeat playback will begin automatically from the A point as soon as the B point has been specified. The programmed A and B points are retained until a different song number or mode is selected, and the A-B phrase can be selected again for repeat playback after playback has been stopped by following the Phrase Repeat procedure described above and selecting “<A-B>” instead of a phrase number in step 2.

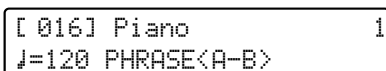
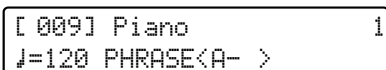

- The specified A-B repeat points will be erased when a new song number is selected.



Other Playback Controls

● Pause



Press the [PAUSE] button to temporarily stop DISK ORCHESTRA playback. Press the [PAUSE] button again (or the [START/STOP] button) to resume playback from the same point.

● Rewind and Fast Forward



During DISK ORCHESTRA operation the [REW] and [FF] buttons function as follows:

- While playback is stopped or paused the [REW] and [FF] buttons can be used to step backward or forward through the song a measure at a time. Either button can also be held for continuous stepping in the specified direction.
- During playback the [REW] and [FF] buttons allow you to move rapidly in the specified direction for as long as the button is held. No sound is produced during [REW] operation.



- Using the [REW] button may cause the voice, tempo, and/or volume to change.
- The [PAUSE], [REW] and [FF] buttons do not function while a guide mode is engaged.

● Pedal Pause/Next Phrase

LEFT PEDAL FUNCTION
START/STOP

If the left pedal is set for **START/STOP** operation using the [LEFT PEDAL] button, it functions as a pause/next phrase control during DISK ORCHESTRA playback: press once to pause, and again to continue from the beginning of the next phrase (refer to the DISK ORCHESTRA COLLECTION book that comes with the DISK ORCHESTRA COLLECTION disk for phrase locations).



- The pedal pause/next phrase function will not operate if the guide, phrase repeat, or all songs repeat modes are active.

DISK ORCHESTRA COLLECTION Disk Copy

The [ORCH/3-10] and [RHYTHM] parts of songs from DISK ORCHESTRA COLLECTION disks — the disk supplied with the Clavinova and others available from Yamaha — can be copied to separate disks by following the “Copying Disk Orchestra Disks” instructions given on page 47. Data copied in this way can be played back and manipulated via the Performance Memory (page 35) — you can, for example, record your own [RIGHT/1] and [LEFT/2] parts.



- Disk Orchestra Collection phrase marks are not copied.

Playing Other Types of Music Data

In addition to Disk Orchestra Collection disks, the Clavinova can also play back Yamaha Disklavier PianoSoft™ disks, disks containing Yamaha ESEQ format sequence data, and disks containing songs recorded in Standard MIDI File format (formats 0 and 1 — the [REW] and [FF] buttons do not function with format 1 data).

It is possible to change the track 1/2 voice by using the panel voice selectors during playback of Disk Orchestra Collection and Disklavier PianoSoft disks. In this case the playback voice will become the same as the voice played via the keyboard. The playback voice cannot be changed when playing back other type of disks (the keyboard voice can be changed).

The phrase repeat function described above can only be used with Disk Orchestra Collection disks. A-B repeat can be used with any type of data. The guide function can only be used with ESEQ files.

The [ORCH/3-10TR] part select button can also be used with all types of data: with files other than General MIDI files it turns tracks 3 through 14 on or off, and with General MIDI Files it turns tracks 3 through 9 and 11 through 16 on or off. The [RHYTHM] button can be used to turn track 15 on and off with file types other than General MIDI (with General MIDI files the [RHYTHM] button turns track 10 on and off). With any type of file the individual tracks (1 through 16) can be turned on and off as described on page 31.

When playing files other than General MIDI files the Auto Accompaniment volume controls affect the following tracks (the volume of General MIDI format tracks cannot be controlled):

BASS	Track 3
CHORD 2	Tracks 1 & 2
CHORD 1	Tracks 4 ... 14
RHYTHM	Track 15

When playing General MIDI Files the Clavinova's internal tone generator is automatically switched to the GM System Level 1 voice allocation.

The CVP-89 features a built-in “sequencer” which can be used to independently record up to ten separate parts of a single musical composition, plus a rhythm track. Each part is recorded on one of the Performance Memory “tracks” accessed via the [RIGHT/1], [LEFT/2], [ORCH/3-10], and [RHYTHM] buttons. The music data that you record is stored on a 3.5" floppy disk loaded into the Clavinova’s disk drive unit. Up to approximately 60 songs can be recorded on a single disk, depending on the amount of data contained in each song. Before you can record, however, you must “format” a new disk, as described on page 48.

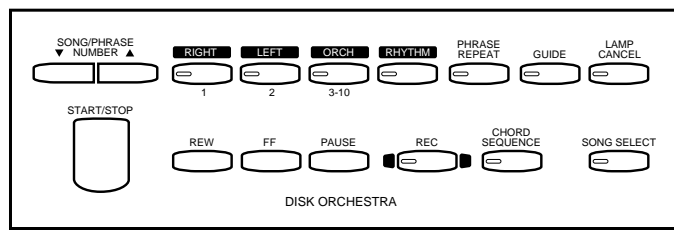

The Performance Memory playback data is not transmitted via the MIDI OUT connector.

Easy One-pass Recording & Playback

1 Insert a Formatted Disk

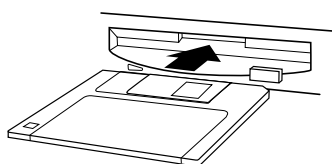

If you haven't already done so, make sure that a properly formatted disk is loaded into the Clavinova disk drive (see page 48), and that the disk's write protect tab is set to the “write” position (tab closed).



- If you insert an unformatted disk, “UNFORMATTED DISK!” will appear on the display. Please format the disk before proceeding.
- DOC disks, Disklavier PianoSoft disks, and disks formatted by the Disklavier cannot be formatted.
- If a disk is already loaded and the [SONG SELECT] indicator is out, press the [SONG SELECT] button so that the indicator lights before proceeding.

2 Select a Song Number



Select a **SONG NUMBER** between 1 and 60 for the piece you are about to record (up to 60 different songs, each with a different song number, can be recorded on a single disk). Make sure the song number you select has not already been used for a song previously recorded on the disk you are using.

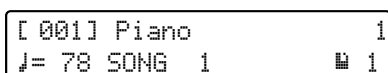

- If the [RIGHT/1], [LEFT/2], [ORCH/3-10], or [RHYTHM] button indicator glows green when a song number is selected, the corresponding track of the selected song already contains recorded data. Before recording over a song that contains previous data, we recommend that you delete the entire song as described in “Song Delete” on page 47.

3 Select a Voice

Use the **VOICE** selectors to select the voice you want to record with. You can try out the selected voice on the keyboard before proceeding.

4 Engage the Record Ready Mode

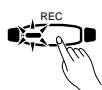

Press the [REC] button so that its indicator lights. The [RIGHT/1] indicator should also glow red at this point, indicating that you are ready to record on track 1. The number of the current record track and the status of tracks 1 through 16 will appear on the display (if a track number appears that track has been recorded and contains data).

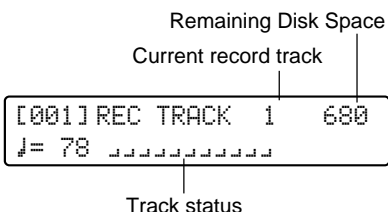

● Remaining Disk Space Display

When you press the [REC] button the amount of disk space available for recording will appear on the display (in approximate kilobytes). With an empty disk you should have about 707 kilobytes of space for recording (room enough for about 57,000 notes if no other Clavinova functions are used). If no space is available for recording, “DISK FULL!” will appear on the display.

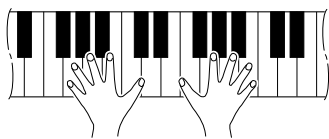
5 Start Recording

Play on the keyboard. Recording will begin automatically as soon as you start playing.



- You can turn the metronome on before or during recording (the metronome sound will not be recorded).
- The “~|” symbol will appear during recording.

6 Stop Recording

Stop recording by pressing the [START/STOP] button or the [REC] button. When recording has finished the indicator of the recorded track will glow green, indicating that the track is ready for playback.



- The Clavinova may continue to write data to the disk for a short time after you stop recording. “WRITING” will appear on the display while this occurs. DO NOT eject the disk while this display is showing.
- You can enter a name for the recorded song, as described on page 51.

7 Play Back the Recording

Press the [START/STOP] button to play back your recording. Play along on the keyboard if you like. During playback you can use the [PAUSE], [REW], and [FF] buttons, as described on page 34. You can also change the playback tempo via the TEMPO [▲] and [▼] buttons.

8 Stop Playback

Playback will stop automatically when the end of the recording is reached, or you can press the [START/STOP] button to stop it at anytime.

Multi-track Recording & Playback

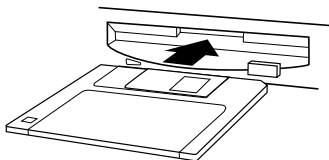
1 Insert a Formatted Disk

If you haven't already done so, make sure that a properly formatted disk is loaded into the Clavinova disk drive (see page 48), and that the disk's write protect tab is set to the “write” position (tab closed).



- If a disk is already loaded and the [SONG SELECT] indicator is out, press the [SONG SELECT] button so that the indicator lights before proceeding.

2 Select a Song Number

Select a **SONG NUMBER** between 1 and 60 for the piece you are about to record (up to 60 different songs, each with a different song number, can be recorded on a single disk). Make sure the song number you select has not already been used for a song previously recorded on the disk you are using.

3 Set All Performance Features As Required

Set up all necessary performance features as required: voice, voice mode (normal, dual, or split), style, tempo, etc. Try out the features as you select them to check that you have the right overall sound.

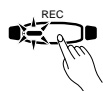
4 Engage the Record Ready Mode

Press the [REC] button so that its indicator lights. The [RIGHT/1] indicator should also glow red at this point, indicating that you are ready to record on track 1. As soon as you release the [REC] button the first dot of the beat indicator will begin to flash at the currently set tempo.



- Be careful not to start recording prematurely by either playing the keyboard or pressing the [START/STOP] button before you've completed the following steps.

5 Select the Track(s) to Record

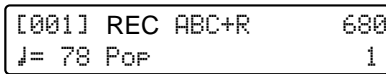
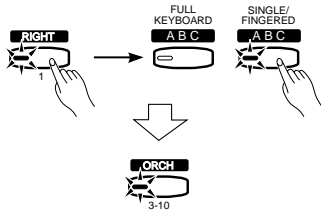
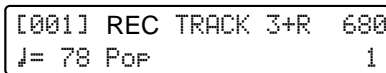
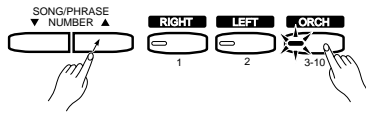

Only one track can be recorded at a time. If you press [RIGHT/1] you will record on track number 1. If you press [LEFT/2] you will record on track number 2. If you press [ORCH/3-10], you can choose to record on track 3, 4, 5, 6, 7, 8, 9, or 10 by selecting the desired track number using the SONG/PHRASE NUMBER [▲] and [▼] buttons while holding the [ORCH/3-10] button (the selected track number will appear on the display). When a record track has been selected the corresponding indicator will light.

● **Recording with Rhythm**

To record a rhythm in addition to the part you play on the keyboard, select the desired style via the STYLE selectors and press the [RHYTHM] button so that its indicator glows red. “+R” and the style name will appear on the display. The rhythm data will be recorded on track 15.

If you only want to record the rhythm track, de-select all other selected tracks by pressing their buttons so that their indicators go out.

If you select the rhythm track for recording, or the rhythm track already contains data, the metronome will sound at the current tempo.

● **Recording with ABC**

When recording with ABC auto-accompaniment the keyboard part can only be recorded to track 1 or 2. To record with ABC press the [RIGHT/1] or [LEFT/2] button and then engage an ABC mode. The [ORCH/3-10] and [RHYTHM] indicators will light automatically in addition to the [RIGHT/1] or [LEFT/2] indicator, and the ABC sound will be recorded on tracks 3 through 10 while what you play on the keyboard will be recorded on track 1 or 2.

If you only want to record the ABC sound, de-select track 1 or 2 by pressing the appropriate button so that the indicator goes out. In the same way, de-select the [RHYTHM] track if you don't want to record the rhythm sound.

● **Recording with Solo Styleplay**

If you also select solo styleplay, the solo styleplay sound will be recorded on tracks 11 through 14. Solo Styleplay can be recorded at the same time as SINGLE/FINGERED ABC, but not at the same time as FULL KEYBOARD mode ABC.

6 Start Recording

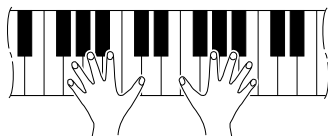

The synchronized start mode is automatically selected when the record ready mode is engaged, so recording will begin automatically as soon as any key on the keyboard is pressed or the [START/STOP] button is pressed (see page 18 for the various synchro start modes). The current measure number is shown on the display as you record.

The following parameters will be recorded in addition to notes you play:

Parameters recorded for Each Track

- Voice*
- Dual Voice*
- Split Voice*
- Volume* (Initial MIDI value = 127. Not changeable during recording)
- Expression (Not recorded as an initial setting)
- Pan*
- Damper Pedal*
- Soft Pedal*
- Sostenuto Pedal (Not recorded as an initial setting)
- Modulation*
- Pitch Bend*
- Reverb Depth*
- Dual Balance*
- Split Balance*
- Chorus*
- Pitch Bend Range

Parameters Recorded for the Entire Song

- Style
- Rhythm Volume*
- Reverb Type*
- Reverb Depth*
- Tempo*
- Intro Mode (Not changeable during recording)
- Ending Mode (Not recorded as an initial setting)
- Fill-in
- ABC Mode (Not changeable during recording)
- ABC Volume*
- Solo Styleplay Mode (Not changeable during recording)
- Solo Styleplay Variation (Not changeable during recording)

Parameters Recorded for Each Track via MIDI Only

- Coarse Tune (Not recorded as an initial setting)
- Fine Tune (Not recorded as an initial setting)

7 Stop Recording



Press the [REC] button a second time, or the [START/STOP] button to stop recording.



■ Adding New Tracks

When you've finished recording the first track, you can simply play it back as described in the previous section or add a new track to your song. To record a new track:

1 Select a Voice

Select a voice and other parameters for the new track. Try out the voice and selected parameters before proceeding.

2 Engage the Record Ready Mode

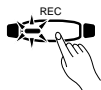

Press the [REC] button to engage the record ready mode.

● Monitoring Previously Recorded Tracks

All previously recorded tracks are automatically selected for playback when the record mode is engaged. You can turn these tracks on or off as required by pressing the corresponding track button(s) before pressing the [REC] button.

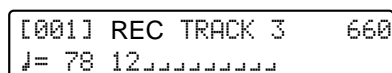

3 Select a Track

Select a track other than the one you used to record the previous track. The indicator of the track selected for recording should glow red.



NOTES

- Remember that if you record on a track that has already been recorded, the previous material will be erased and the new material will be recorded in its place.

4 Start Recording

Play on the keyboard or press the [START/STOP] button to start recording.

5 Stop Recording

Press the [START/STOP] button or the [REC] button to stop recording.

● Changing the Initial Parameter Values

The initial values of parameters marked with asterisks (*) in the lists given in step 6 on page 37 can be changed for each track or the entire song by engaging the record mode for the desired track, changing the parameters as required, and then disengaging the record mode (press the [REC] button again) without actually recording. To cancel any initial parameter values you've made, select a different track and then press the [REC] button to disengage the record mode.

To change individual ABC part volume settings engage any ABC mode after turning [REC] on, set the **RHYTHM**, **CHORD 1**, **CHORD 2**, and/or **BASS** volume control as required, then disengage the record mode.

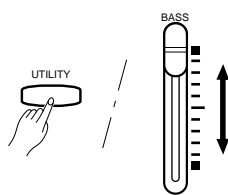

Volume of each track

The **BASS** volume control can be used while holding the [UTILITY] button to independently adjust the volume of each track (except the rhythm track). The volume of the rhythm track is adjusted via the **RHYTHM** volume control. Please note that volume settings can only be decreased.

Individual track reverb depth can be adjusted by using the **BASS** volume while holding the [REVERB] button, and the overall reverb depth can be adjusted by using the **TEMPO** [▲] and [▼] buttons while holding the [REVERB] button.

Also note that the tempo, reverb type, style, style variation, fill-in, and intro/ending settings are common to all tracks and cannot be set independently for different tracks.



NOTES

- Only initial parameter data created by the CVP-89 can be changed. Data converted by the Convert to SMF function (page 53) cannot be changed. If the data cannot be changed, "DATA NOT EDITABLE!" will appear on the display.
- Only the individual track volume can be changed for data converted by the Convert to DOC function (page 52).

● Erasing the Tracks

Individual tracks — except the rhythm track — can be completely erased by starting and stopping recording without actually playing or changing any parameters (i.e. press the [START/STOP] button twice). The same procedure can be used to erase the rhythm track if the **RHYTHM** volume control is set to its minimum position.



NOTES

- Tracks 3-10 can be erased by engaging the record mode, turning ABC on, and then pressing the [START/STOP] button twice.

● **Recording Without a Disk**

The Clavinova has enough internal RAM memory to allow recording for a while even if a disk is not loaded (up to approximately 2,200 notes — 28 kilobytes — if no other data is recorded). If you accidentally record without loading a disk, make sure you use the COPY function (described on page 46) to copy the recorded data to disk if you want to keep the recorded data (the internal RAM memory is not backed up). This is necessary because the internal RAM memory is cleared automatically when a Disk Orchestra Collection, Disklavier PianoSoft, or Style Disk is loaded, or a performance disk is loaded and the [SONG SELECT] button is pressed.

● **Recording Using General MIDI Voice Assignments**

It is also possible to use the General MIDI voice assignments when recording with the Performance Memory. See “The Multi-Timbre Mode” on page 57 for details.

■ **Punch-in Recording**

“Punch-in recording” allows you to start recording from any “punch-in” point within a previously-recorded track and stop recording at any “punch-out” point, leaving all recorded material up to the punch-in point and following the punch-out point intact.

1 Play the Song



Play back the song in order to locate the point you want to punch-in from. You can also use the [FF] and [REW] buttons to locate the punch-in point.

2 Pause Before the Punch-in Point



Press the [PAUSE] button to pause playback a bit before the point at which you want to start recording. Leave a measure or more before the punch-in point so you'll be able to grasp the timing for the punch in.

3 Engage the Record Ready Mode



Press the [REC] button to engage the record ready mode. The last track selected for recording will automatically be reselected.

4 Select a Track

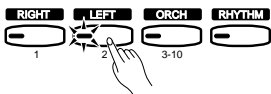

If you want to record on a different track than the one that is currently selected for recording (red indicator), use the normal track selection procedure.

5 Start Playback & Recording

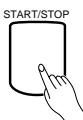

Press the [START/STOP] button to start playback from the current pause location, then begin playing at the point you want to record from. Recording will begin as soon as you begin playing on the keyboard.

6 Stop Recording



Press the [START/STOP] button or the [REC] button to stop recording at the point at which you want to “punch out”.

● **Erasing All Material From the Punch-in Point**

If at step **5**, above, you press the [START/STOP] button while holding the track button corresponding to the track on which you want to record, recording will begin immediately. If you then stop recording without actually playing anything, all recorded material from the punch-in point to the end of the track will be erased.

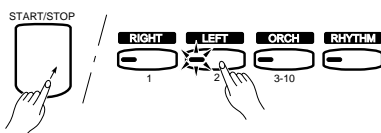

• *Punch-in recording cannot be used with ABC, SOLO STYLEPLAY, or RHYTHM tracks.*



■ Playback

Original Performance Memory recordings can be played back and controlled in the same way as described in the Disk Orchestra section, beginning on page 30. You can individually select tracks to play back (page 31), use the guide function and keyboard guide lamps with the data recorded on tracks 1 and 2 (page 32), and use the A-B repeat function (page 33).

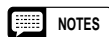

- *The playback voice cannot be changed when playing back Performance Memory data (the voice played via the keyboard can be changed).*

● Volume Control

The **RHYTHM**, **CHORD 1**, **CHORD 2**, and **BASS** volume controls can be used to adjust the volume of the corresponding accompaniment parts when playing back data that was recorded with ABC.

When playing back data that was recorded without ABC, however, these volume controls have the following track assignments.

RHYTHM RHYTHM track
BASS 3 track
CHORD 1 4 - 10 tracks
CHORD 2 1 & 2 tracks

● Multi-timbre Recording via MIDI

Data from an external MIDI device such as a sequencer or music computer can also be recorded to the Performance Memory as follows:

1 Make the Required MIDI Connections

Connect the **MIDI OUT** terminal of the transmitting device to the Clavinova's **MIDI IN** terminal using a standard MIDI cable.

2 Select the External Clock Mode

To select the external clock mode press the **[ORGAN] VOICE** button while holding the **[UTILITY]** button. When selected, the **[ORGAN]** indicator will light while the **[UTILITY]** button is pressed. In this mode the Clavinova is controlled by an external MIDI clock signal.

3 Select a Song Number

Select the song number to which you want to record the data by using the **SONG/PHRASE NUMBER** **[▲]** and **[▼]** buttons (of course, a properly formatted floppy disk must already be loaded in the disk drive).

4 Engage the MIDI Record Ready Mode

Press the **[REC]** button while holding the **[UTILITY]** button to engage the MIDI record ready mode. In this mode all tracks (1 through 15) can be recorded at the same time via the correspondingly numbered MIDI channels. That is, MIDI data received on channel 1 will be recorded on track 1, data received via channel 2 will be recorded on track 2, etc.

```
[001] REC TRACK ALL 680
↓= 78 Pop 1
```

5 Match the Time Signature & Tempo

Select a style having a time signature that matches that of the data you are going to record (e.g. 4/4, 3/4), and match the Clavinova tempo setting to that of the data to be recorded.

6 Record the MIDI Data

Play back the MIDI data on the sequencer, music computer, or other device. Recording will start and stop automatically.

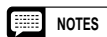

- *Please note that the Clavinova's internal styles cannot be played during multi-timbre recording.*
- *Any notes played on the keyboard and other setting changes will be recorded on track 1 during multi-timbre recording.*
- *Initial panel settings will not be recorded unless the settings are changed in the record ready mode.*
- *Previous data on all tracks will be erased when new data is recorded in the multi-timbre mode.*
- *If multi-timbre recording is carried out while the GM Multi-Timbre mode is turned on (page 57), or a "GM on" message is received during recording, GM voice recording is possible on tracks 1 through 14.*
- *Be sure to turn the multi-timbre and external clock modes off when you're finished multi-timbre recording (see pages 57 and 58).*

The Chord Sequence Function

The **CHORD SEQUENCE** function provides a convenient way to enter chord sequences and style changes one at a time.

1 Engage the Chord Sequence Function



Press the [**CHORD SEQUENCE**] button. The [**ORCH/3-10**] and [**RHYTHM**] track button indicators will glow red, and the **ABC SINGLE/FINGERED** mode will be automatically selected.

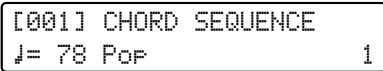

- The chord sequence data will replace any previous ABC data.

2 Enter the Chords and/or Style Changes

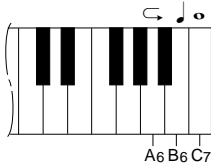

Make the required style changes (style number, normal/variation, fill-in, intro/ending, and tempo, as necessary), play and hold a chord on the left-hand section of the keyboard, and press the [**♩**] key (look for the “♩” symbol above the B6 key) or the [**♩**] key (C7) to enter the chord for a quarter note or whole note, respectively. You can move one beat backward by pressing the [**↶**] key (A6).



- The number of the measure to be entered is shown on the display, while the beat to be entered is shown on the BEAT display.
- If no chords are entered, the result will be a rhythm-only sequence.

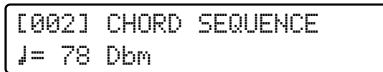

3 Stop Recording



When all the required chords and style changes have been entered, press the [**CHORD SEQUENCE**] button to stop recording.



- The chord sequence data now resides in Performance Memory tracks 3 through 10 and 15, and can be played back in the normal way. Add melody tracks 1 and 2 as required. You can also record over individual tracks of the sequence and replace them with original material if you like by using the standard Performance Memory track selection and record procedure.

● Punch-in Chord Sequence Recording

You can begin chord sequence recording from any point within a previously-recorded song by pausing playback at the point you want to begin chord sequence recording, engaging the Chord Sequence function at that point, and entering the chords up to the end of the sequence as described above.



- If you attempt punch-in chord sequence recording on a song in which no chord sequence data has been entered, “DATA NOT EDITABLE!” will appear on the display and the recording will not be possible.
- If you record chord sequences to all songs on a disk, the maximum number of songs available on that disk will be 55.



The 44 “utility functions” described in this chapter include effect, disk, MIDI, and general functions that significantly enhance the versatility and flexibility of the CVP-89.

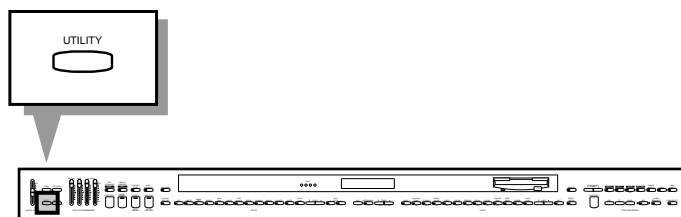

Selecting & Using the Utility Functions

Most of the CVP-89 utility functions are selected and set in the same way for consistent, easy operation. The general selection and setting procedure is as follows:

1 Select a Utility Function

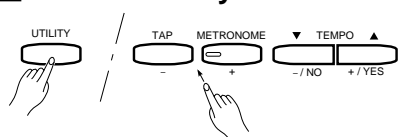

While holding the [UTILITY] button use the [TAP] and/or [METRONOME] buttons to select the desired utility function display. It is also possible to step through the utility functions by repeatedly pressing the [UTILITY] button (the utility display will remain for about one second after the [UTILITY] button is released).

The [UTILITY] button must be held until after you've set the function, below.

- You can jump directly to the first utility function in each group by pressing the corresponding STYLE selector while holding the [UTILITY] button:

[POP] → 02: Chorus ON/OFF
 [16BEAT] → 05: Save Registration
 [DANCE POP] → 15: Quantize Song Data
 [BOOGIE] → 21: Send Channel Select
 [SLOW ROCK] → 32: Individual Key Tuning



- You can cancel the selected function at this point and exit from the utility mode simply by releasing the [UTILITY] button.
- The last utility function selected is automatically re-selected when the [UTILITY] button is pressed (“01: Transpose” is always the first utility function selected after the power has been turned on).
- When some functions are selected “NO/YES” will flash on the display. In such cases press the TEMPO [▲] (YES) button to actually engage the selected function or the TEMPO [▼] (NO) button to cancel. You can release the [UTILITY] button once you've pressed the TEMPO [▲] button.

2 Set as Required

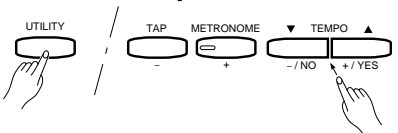

Use the TEMPO [▲] and [▼] buttons while still holding the [UTILITY] button to select the required setting, or follow the procedure given below for the selected function.

3 Exit



Release the [UTILITY] button to exit from the utility mode when you've finished making the required settings.

If you've used a function which is engaged by pressing the TEMPO [▲] button in response to the “NO/YES” prompt on the display (i.e. the [UTILITY] button has already been released), press the [UTILITY] button again to exit from the utility mode.

The Utility Mode Functions

01	Transpose	12	Song Delete	23	Local Control ON/OFF	34	Accompaniment Volume Mode
02	Chorus ON/OFF	13	Disk Format	24	Program Change ON/CANCEL	35	Style Tempo Switching
03	Soundboard Depth	14	Standard MIDI File Playback Mode	25	Control Change ON/CANCEL	36	Auto Synchro Start Switching
04	Mic Reverb Depth	15	Quantize Song Data	26	The Multi-Timbre Mode	37	Random All Song Repeat
05	Save Registration	16	Track Mix	27	The Split Send Mode	38	Damper Pedal Mode
06	Load Registration	17	Volume Control	28	MIDI Clock Select	39	Pitch Bend Range
07	Save Individual Key Tuning	18	Song Name	29	Panel Data Send	40	Edit Drum Instrument
08	Load Individual Key Tuning	19	Convert to DOC	30	MIDI Transpose Transmit	41	Split Left Octave
09	Save Custom Rhythm	20	Convert to SMF	31	GM Drum Kit	42	Registration Tempo
10	Load Custom Rhythm	21	Send Channel Select	32	Individual Key Tuning	43	ABC Auto Mute
11	Song Copy	22	Receive Channel Select	33	Touch Sensitivity	44	Minor Harmonization

Effect Functions

01: Transpose

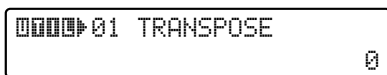

Display	Transposition
-6	-6 semitones
-5	-5 semitones
-4	-4 semitones
-3	-3 semitones
-2	-2 semitones
-1	-1 semitone
0	Normal
+1	+1 semitone
+2	+2 semitones
+3	+3 semitones
+4	+4 semitones
+5	+5 semitones
+6	+6 semitones

The Transpose function makes it possible to shift the pitch of the entire keyboard up or down in semitone intervals up to a maximum of six semitones. “Transposing” the pitch of the Clavinova keyboard makes it easier to play in difficult key signatures, and you can simply match the pitch of the keyboard to the range of a singer or other instrumentalist.

Once the Transpose function has been selected, use the **TEMPO** [▲] and [▼] buttons to select the desired degree of transposition, then release the [UTILITY] button.

The amount of transposition selected is shown on the display as shown to the left.

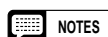

- Press the **TEMPO** [▲] and [▼] buttons simultaneously while holding the [UTILITY] button (while the Transpose function is selected) to restore normal keyboard pitch.
- Transpose is always set to Normal when the power is turned on.
- The transpose function does not affect the drums sound.
- Notes below and above the original 88-key range of the Clavinova sound one octave higher and lower, respectively.

02: Chorus ON/OFF



A preset chorus effect is provided with each of the CVP-89 voices (this may be ON or OFF, depending on the voice). This function allows the chorus effect to be turned ON or OFF for the currently selected voice.

Once the Chorus ON/OFF function has been selected, use the **TEMPO** [▲] and [▼] buttons to turn the chorus effect ON or OFF, then release the [UTILITY] button.



- The chorus ON/OFF setting is retained in memory for approximately one week even when the power is turned off.
- See page vii for a list of the chorus settings for each voice.
- In the Dual mode the setting of the voice shown to the left of the display takes priority, while in the Split mode the right-hand voice setting takes priority.

03: Soundboard Depth

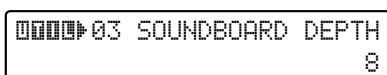

The CVP-89 PIANO voice (voice number 1) features a “Soundboard” effect which can be enhanced via the damper pedal. Extra soundboard and string resonance is added when the damper pedal is pressed. This function sets the maximum depth of the Soundboard effect.

Once the Soundboard Depth function has been selected, use the **TEMPO** [▲] and [▼] buttons to set the depth of the effect as required, then release the [UTILITY] button. The Soundboard Depth can be set from “0” (no effect) to “15” (maximum effect depth). The default setting is “8”.



- The Soundboard Depth setting is retained in memory for approximately one week even when the power is turned off.

04: Mic Reverb Depth

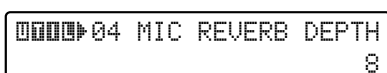

This function sets the amount of reverb effect applied to the signal from a microphone plugged into the CVP-89 MIC. jack (page 65).

Once the Mic Reverb function has been selected, use the **TEMPO** [▲] and [▼] buttons to set the depth of the reverb effect, then release the [UTILITY] button. The microphone reverb depth can be set from “0” (no reverb) to “15” (maximum reverb). The default setting is “8”.

Disk Functions

This group of utility functions covers a range of disk-related jobs: formatting new disks, copying songs, deleting songs, saving and loading various types of data, and more.



- Disk-related functions (05 through 20) can only be accessed when a disk is present in the Clavinova disk drive.

05: Save Registration

This function saves the contents of all 12 registration memory locations (page 29) to disk. The data can then be reloaded at any time by using the Load Registration function, described next.

1 Insert a Disk & Select the Save Registration Function

```

0000▶05 REGIST -> DISK
SONG 01   PRESS [START]
  
```

Insert a properly formatted disk into the Clavinova disk drive, then select the Save Registration function — see “Selecting & Using the Utility Functions”, page 42.

2 Select a Song Number & Execute the Function

Registration memory data can be saved to a blank song number or one that already contains performance memory data.

Use the **TEMPO** [▲] and [▼] buttons to select the song number to which you want to save the registration memory data, then press the [START/STOP] button to actually begin saving the data. Simply release the [UTILITY] button before pressing the [START/STOP] button if you want to cancel the function.

The contents of all 12 registration memory locations is saved to one song file on the disk. The Save Registration function will automatically be exited when the data has been saved.

06: Load Registration

This function reloads the panel settings saved to disk by the Save Registration function, described above.

1 Insert a Disk & Select the Load Registration Function

```

0000▶06 DISK -> REGIST
SONG 01   PRESS [START]
  
```

Insert the disk containing the registration memory data you want to load into the Clavinova disk drive, then select the Load Registration function — see “Selecting & Using the Utility Functions”, page 42.

2 Select a Song Number and Execute the Function

Use the **TEMPO** [▲] and [▼] buttons to select the song number from which you want to load the registration memory data, then press the [START/STOP] button to actually begin loading the data. “NO DATA!” will appear on the display if you select a song that contains no data. Simply release the [UTILITY] button before pressing the [START/STOP] button if you want to cancel the function.

The Load Registration function will automatically be exited when the data has been loaded.

07: Save Individual Key Tuning

This function saves the current individual key tuning data set up via the “Individual Key Tuning” function (page 60) to disk. The data can then be reloaded at any time by using the Load Individual Key Tuning function, described next.

1 Insert a Disk & Select the Save Individual Key Tuning Function

```

0000 07 IND. KEY -> DISK
SONG 01 PRESS [START]
  
```

Insert a properly formatted disk into the Clavinova disk drive, then select the Save Individual Key Tuning function — see “Selecting & Using the Utility Functions”, page 42.

2 Select a Song Number & Execute the Function

Individual key tuning data can be saved to a blank song number or one that already contains performance memory data.

Use the **TEMPO** [▲] and [▼] buttons to select the song number to which you want to save the individual key tuning data, then press the [START/STOP] button to actually begin saving the data. Simply release the [UTILITY] button before pressing the [START/STOP] button if you want to cancel the function.

The tuning settings are saved to one song file on the disk. The Save Individual Key Tuning function will automatically be exited when the data has been saved.

08: Load Individual Key Tuning

This function reloads the individual key tuning data saved to disk by the Save Individual Key Tuning function, described above.

1 Insert a Disk & Select the Load Individual Key Tuning Function

```

0000 08 DISK -> IND. KEY
SONG 01 PRESS [START]
  
```

Insert the disk containing the individual key tuning data you want to load into the Clavinova disk drive, then select the Load Individual Key Tuning function — see “Selecting & Using the Utility Functions”, page 42.

2 Select a Song Number and Execute the Function

Use the **TEMPO** [▲] and [▼] buttons to select the song number from which you want to load the individual key tuning data, then press the [START/STOP] button to actually begin loading the data. “NO DATA!” will appear on the display if you select a song that contains no data. Simply release the [UTILITY] button before pressing the [START/STOP] button if you want to cancel the function.

The Load Individual Key Tuning function will automatically be exited when the data has been loaded. The Individual Key Tuning function (UTIL 32) will then be automatically engaged with the loaded tuning, unless the loaded data is the same as that currently in the CVP-89.

09: Save Custom Rhythm

This function saves all the 12 current Custom Rhythm data created via the CVP-89’s Custom Rhythm programmer (page 24) to disk. The data can then be reloaded at any time by using the Load Custom Rhythm function, described next.

1 Insert a Disk & Select the Save Custom Rhythm Function

```

0000 09 C.RHYTHM -> DISK
SONG 01 PRESS [START]
  
```

Insert a properly formatted disk into the Clavinova disk drive, then select the Save Custom Rhythm function — see “Selecting & Using the Utility Functions”, page 42.

2 Select a Song Number & Execute the Function

Custom rhythm data can be saved to a blank song number or one that already contains performance memory data.

Use the **TEMPO** [▲] and [▼] buttons to select the song number to which you want to save the custom rhythm data, then press the [START/STOP] button to actually begin saving the data. Simply release the [UTILITY] button before pressing the [START/STOP] button if you want to cancel the function.

The custom rhythm data is saved to one song file on the disk. The Save Custom Rhythm function will automatically be exited when the data has been saved.



10: Load Custom Rhythm

This function reloads the custom rhythm data saved to disk by the Save Custom Rhythm function, described above.

1 Insert a Disk & Select the Load Custom Rhythm Function

```

██████▶ 10 DISK -> C.RHYTHM
SONG 01   PRESS [START]
  
```

Insert the disk containing the custom rhythm data you want to load into the Clavinova disk drive, then select the Load Custom Rhythm function — see “Selecting & Using the Utility Functions”, page 42.

2 Select a Song Number and Execute the Function

Use the **TEMPO** [▲] and [▼] buttons to select the song number from which you want to load the custom rhythm data, then press the [START/STOP] button to actually begin loading the data. “NO DATA!” will appear on the display if you select a song that contains no data. Simply release the [UTILITY] button before pressing the [START/STOP] button if you want to cancel the function.

The Load Custom Rhythm function will automatically be exited when the data has been loaded.

11: Song Copy

Performance Memory song data — including any existing registration, individual key tuning, and custom rhythm data — can be “backed up” by copying to a new song number or a different disk, as follows:



- The Song Copy function cannot be executed if the selected song contains only registration, individual key tuning, and/or custom rhythm data.

1 Insert a Disk & Select the Source Song

Insert the disk containing the song you want to copy, and use the **SONG/PHRASE NUMBER** [▲] and [▼] buttons to select the number of the song you wish to copy.

2 Select the Song Copy Function

Select the Song Copy function — see “Selecting & Using the Utility Functions”, page 42. “NO DATA!” will appear on the display if you select a song that contains no data.



- The utility mode can be exited by releasing the [UTILITY] button.

3 Select the Destination Song

```

██████▶ 11 SONG COPY
SONG 01->02 PRESS [START]
  
```

Copy to same disk

```

██████▶ 11 COPY -> DISK2
SONG 01->01 PRESS [START]
  
```

Copy to different disk

While holding the [UTILITY] button use the **TEMPO** [▲] and [▼] buttons to select the song number you wish to copy to (i.e. the destination song number), then release the [UTILITY] button. If you select a song number that already contains data, that data will be overwritten by the new song data. If you select a song number greater than 60 (“DISK 2” will appear on the display), the copy will be made to a different disk.

4 Start Copying

```

██████▶ 11 COPY -> DISK2
0 / 3   INSERT DISK2
  
```

Insert destination disk.

```

██████▶ 11 COPY -> DISK2
1 / 3   INSERT DISK1
  
```

Insert source disk.

Press the [START/STOP] button to begin the actual copy operation.

If you chose to copy to a different disk, you may have to exchange the source and destination disks a few times if the song being copied is long and complex. In this case, the Clavinova will prompt you to insert the source and destination disks with the displays shown to the left.

“END” will appear on the display briefly when the copy operation has been successfully completed.

- While the data is being copied the number of times the disks will have to be exchanged to complete the copy operation will be shown on the display.



- If you copy to a song number that already contains data, “ARE YOU SURE?” will appear on the display. Use the **TEMPO** [▲] (YES) and [▼] (NO) buttons to select either (YES) or (NO). (YES) if you intend to execute the copy operation or (NO) if you wish to cancel the operation. The copy operation will begin automatically if you select (YES).

- The copy operation can be aborted at any time prior to actually starting the copy operation (i.e. prior to pressing the [START/STOP] button or the TEMPO [▲] button) or during the disk exchange display by pressing the [UTILITY] button.

● Copying Disk Orchestra Disks ([ORCH/3-10] and [RHYTHM] parts only)

All Disk Orchestra data except the right-hand and left-hand parts can be copied to a separate disk by following the standard copy procedure outlined above. The copied data cannot, however, be copied a second time to another disk.



- When a Disk Orchestra disk is copied, any parts using the JAZZ ORGAN 2 voice will be shifted down one octave.

● Copying the Style Disk Data

All Style Disk data can be copied to a separate disk by following the standard copy procedure outlined above. A single disk can hold up to 50 styles. Style Disk data can only be copied to a newly formatted disk (i.e. no other data can be previously recorded on the disk) or a disk which already contains copied style data.



- Data from the Style Disk cannot be copied to a disk that contains Performance Memory or Disk Orchestra Collection data. The reverse is also true: Performance Memory and Disk Orchestra Collection data cannot be copied to a disk that contains data copied from the Style Disk.

● Copying Data Recorded Without a Disk

```

0000▶11 SONG COPY
CUP -> 01  PRESS [START]

```

If you've used the performance memory to record data without first loading a disk: insert a formatted disk, select the Song Copy function, then select the destination song number and copy as described above.



- Data cannot be copied from Disklavier disks, or Standard MIDI File disks. Data cannot be copied to any write protected disk. It is also not possible to copy from one song number to another within the same Disk Orchestra disk.

■ 12: Song Delete

You can delete any Performance Memory song data — not including any existing registration, individual key tuning, and custom rhythm data — from a loaded disk as follows:

1 Insert a Disk & Select the Delete Function

```

0000▶12 SONG DELETE
SONG 01  PRESS [START]

```

Insert the disk containing the song you want to delete, then select the Delete function — see “Selecting & Using the Utility Functions”, page 42.

2 Select the Song to Delete

While holding the [UTILITY] button use the TEMPO [▲] and [▼] buttons to select the song number you wish to delete, then release the [UTILITY] button.

3 Confirm & Execute the Delete Operation

Press the [START/STOP] button — “ARE YOU SURE?” will appear on the display. Use the TEMPO [▲] (YES) and [▼] (NO) buttons to select either (YES) or (NO). (YES) to immediately delete the selected song, or (NO) if you wish to cancel the operation. If the selected song contains no data the “ARE YOU SURE?” prompt will not appear and the utility mode will be automatically exited.

“END” will appear on the display briefly when the delete operation has been successfully completed.



- The delete operation can be aborted at any time prior to actually starting the delete operation (i.e. prior to pressing the TEMPO [▲] button) by pressing the [UTILITY] button.
- Data recorded to memory without loading a disk can be deleted simply by selecting the Song Delete function and use the TEMPO [▲] (YES) and [▼] (NO) buttons to select either (YES) or (NO).
- Data cannot be deleted from any write protected disk, the supplied Style Disk, Disk Orchestra Collection disks, or Disklavier disks.

13: Disk Format

The Clavinova uses only 3.5" 2DD floppy disks. We recommend that you use Yamaha 2DD disks. Before you can use a new disk for recording, the disk must be "formatted" so that the Clavinova can recognize it and correctly write the music data onto it.

1 Insert the Disk To Be Formatted

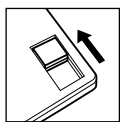
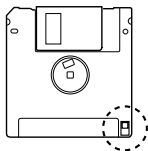

Write protect tab closed (unlocked — write enabled)



NOTES

Insert a new blank disk. Make sure that the disk's write protect tab is set to the "write" position (tab closed), and insert the new disk into the disk drive unit with the sliding door facing the drive slot and the label side of the disk facing upward. The disk should click securely into place, and the disk drive lamp should light briefly.

- "UNFORMATTED DISK!" will appear on the display to indicate that a blank (unformatted) disk or one with a format not recognizable by the CVP-89 is loaded in the drive. If you press the [UTILITY] button at this point utility function 13: Disk Format will automatically be selected.
- "DISK PROTECTED" will appear if a protected disk that cannot be formatted is loaded in the drive: a write-protected disk, a Disk Orchestra Collection disk, a Disklavier disk, or a disk formatted by the Disklavier.

2 Select the Disk Format Function

```

0000▶ 13 DISK FORMAT
          PRESS [START]
  
```

Select the Disk Format function — see "Selecting & Using the Utility Functions", page 42.

When the Disk Format function is selected, "PRESS [START]" will appear on the display. Press the [STOP/START] button to begin the disk format procedure.

3 Confirm & Start the Format Operation

```

0000▶ 13 DISK FORMAT
          ARE YOU SURE?
  
```

When the [START/STOP] button has been pressed, "ARE YOU SURE?" will appear on the display. Use the **TEMPO** [▲] (YES) and [▼] (NO) buttons to confirm and continue or cancel the operation. "YES" if you intend to execute the format operation or "NO" if you wish to cancel the operation. This step is necessary because formatting completely erases any data that is already on the disk — make sure that the disk you're about to format does not contain any important data!

Formatting will begin the instant you select "YES". The number of each "track" on the disk will be shown on the display as the format process continues ("F80" through "END"). When formatting is complete (the display will show "END"), you can go ahead and record using the performance memory, or use the Song Copy function to copy songs or Disk Style data to the disk.



NOTES

- The format operation can be aborted at any time prior to actually starting the format operation (i.e. prior to pressing the **TEMPO** [▲] button) by pressing the [UTILITY] or [START/STOP] button. In this case, the disk will have to be properly formatted again before use.

14: Standard MIDI File Playback Mode (SMF Data Format)

```

0000▶ 14 SMF VOICE MODE
          GM
  
```

This function determines whether standard MIDI files on floppy disk are played back using the General MIDI voice assignments or the standard Clavinova voice assignments.

Once the Standard MIDI File Playback Mode function has been selected, use the **TEMPO** [▲] and [▼] buttons to select "NORMAL" or "GM", then release the [UTILITY] button.

NORMAL Standard SMF Mode. Standard Clavinova voice assignments (unless a “GM ON” message is included in the data). Track 10 not necessarily drums.

GM GM SMF Mode. General MIDI voice assignments. Track 10 is always drums.



- The Standard SMF mode is useful when playing back a disk containing Standard MIDI Files created on an external sequencer using the Clavinova panel voice assignments.
- The GM SMF mode is automatically selected (GM) whenever the POWER switch is turned on.

15: Quantize Song Data

This function “quantizes” song memory data that has already been recorded to disk. This means that all notes are aligned to the nearest specified beat, thereby “tightening up” the overall timing.

1 Insert the Disk and Select a Song

Make sure that the disk containing the song you want to quantize is loaded in the Clavinova disk drive, and that the song to be quantized is selected.

2 Select the Quantize Song Data Function

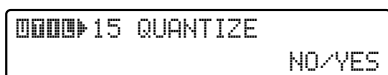

Select the Quantize Song Data function — see “Selecting & Using the Utility Functions”, page 42. “NO/YES” will flash on the display. Press the **TEMPO** [▲] button (YES) to engage the Quantize function or the [▼] button (NO) to cancel. Once you’ve pressed the **TEMPO** [▲] button to engage the function you can release the [UTILITY] button.

3 Select the Quantize Value

Use the **TEMPO** [▲] and [▼] buttons to select the desired quantize value, as shown on the display:

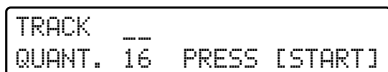

OFF: “Free”. No quantization.

32: All notes aligned to the nearest 32nd note.

16: All notes aligned to the nearest 16th note.

8: All notes aligned to the nearest 8th note.

24: All notes aligned to the nearest 16th note triplet.

12: All notes aligned to the nearest 8th note triplet.

6: All notes aligned to the nearest quarter note triplet.



4 Select a Track

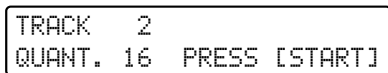

Use the [TAP] and [METRONOME] buttons to select the track you want to quantize.



- Up until this point you can exit from the Quantize Song Data function at any time by pressing the [UTILITY] button.

5 Quantize the Data

Press the [START/STOP] button to begin quantization. During quantization the number of the measure being quantized will appear in the lower right corner of the display. The Quantize Song Data function will automatically be exited when the data has been quantized.



- Once quantized, song data cannot be returned to its original “free” form. It is therefore a good idea to make a backup copy of the data before using this function.
- Only song data created by the CVP-89, CVP-87A, CVP-85A or CVP-83S can be quantized. Data converted by the Convert to DOC function (page 52) or Convert to SMF function (page 53) cannot be quantized.
- Only note and voice data is quantized.

16: Track Mix

Extra Performance Memory track space can be created by using this function to mix the data from two tracks to a single track. The data from the “source” and “destination” tracks is mixed and the result placed in the destination track. You can also use this function to copy data from one track to another by specifying a blank destination track (i.e. the source track data is copied to the destination track).

1 Insert the Disk and Select a Song

Make sure that the disk containing the song with the tracks you want to mix is loaded in the Clavinova disk drive, and that the song to be affected is selected.

2 Select the Track Mix Function

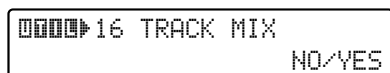

Select the Track Mix function — see “Selecting & Using the Utility Functions”, page 42. “NO/YES” will flash on the display. Press the **TEMPO** [▲] button (YES) to engage the Track Mix function or the [▼] button (NO) to cancel. Once you’ve pressed the **TEMPO** [▲] button to engage the function you can release the [UTILITY] button.

3 Select the Source Track

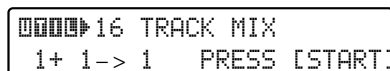

Use the [TAP] and [METRONOME] buttons to select the source track.

4 Select the Destination Track

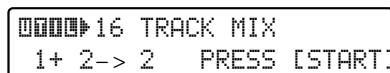

Use the **TEMPO** [▲] and [▼] buttons to select the destination track.

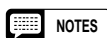

- Up until this point you can exit from the Track Mix function without affecting the data on disk by pressing the [UTILITY] button.

5 Start the Mix Operation

Press the [START/STOP] button to start the actual track mix operation. The number of the measure being processed will appear in the lower right corner of the display. The Track Mix function will automatically be exited when the data has been mixed.



- The initial data values of the destination track take priority.
- The initial data values of the source track are copied if the destination track is empty.
- The destination track cannot be returned to its pre-mix condition after the Track Mix function has been executed. It is therefore a good idea to make a backup copy of the data before using this function.
- Only song data created by the CVP-89, CVP-87A, CVP-85A or CVP-83S can be mixed. Data converted by the Convert to DOC function (page 52) or Convert to SMF function (page 53) cannot be mixed.

17: Volume Control

This function allows you to individually adjust the playback volume of each of the Performance Memory tracks.

1 Insert the Disk and Select a Song

Make sure that the disk containing the song you want to set volume levels for is loaded in the Clavinova disk drive, that the [SONG SELECT] indicator is lit, and that the song to be affected is selected.

2 Select the Volume Control Function

Select the Volume Control function — see “Selecting & Using the Utility Functions”, page 42. Use the **TEMPO** [▲] and [▼] buttons to turn Volume Control ON or OFF. Once you’ve turned ON to engage the function you can release the [UTILITY] button.

3 Select a Track

Use the [TAP] and [METRONOME] buttons to select the track for which you want to change the volume level.

4 Set the Volume

Use the **TEMPO** [▲] and [▼] buttons to set the volume of the selected track. The volume range is from “0” (no sound) to “127” (maximum volume).



To re-record the initial volume value press the [REC] button then, in response to the “ARE YOU SURE?” prompt, use the **TEMPO** [▲] and [▼] buttons to select “YES” or “NO” as required.



NOTES

- The initially recorded volume value is always “127”.
- Only data originally recorded on the CVP-89 can be re-recorded. Data converted by the Convert to SMF function (page 53) cannot be re-recorded.

5 Exit

To exit from this function first press the [UTILITY] button to return to the VOLUME CONTROL ON/OFF display, press the **TEMPO** [▲] or [▼] button while holding the [UTILITY] button to turn volume control off.



NOTES

- If the [SONG/PHRASE NUMBER] button is used to select a different song number while the Volume Control mode is engaged, the Volume Control mode will be automatically turned OFF and the utility mode will be exited.

18: Song Name

Use this function to enter original titles (up to 12 characters) for your Performance Memory songs.

1 Insert a Disk

Insert the disk containing the song for which you want to enter a title.

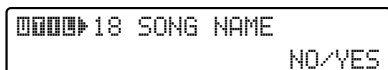
2 Select the Song Name Function

Select the Song Name function — see “Selecting & Using the Utility Functions”, page 42. “NO/YES” will flash on the display. Press the **TEMPO** [▲] button (YES) to engage the Song Name function or the [▼] button (NO) to cancel. Once you’ve pressed the **TEMPO** [▲] button to engage the function you can release the [UTILITY] button.

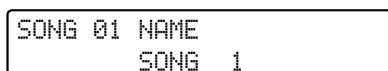
3 Select a Song

Use the [TAP] and [METRONOME] buttons to select the song for which you want to enter a name. The existing song name will appear on the display, or “NO SONG DATA” will appear if the selected song contains no data. “SONG 1”, “SONG 2”, etc. will appear if the song has not already been given a name.

4 Move the Cursor to the Appropriate Character

Use the **TEMPO** [▲] and [▼] buttons to move the cursor to the character location at which you want to enter a character.

5 Enter a Character

The following keys on the CVP-89 keyboard enter the corresponding characters when pressed:

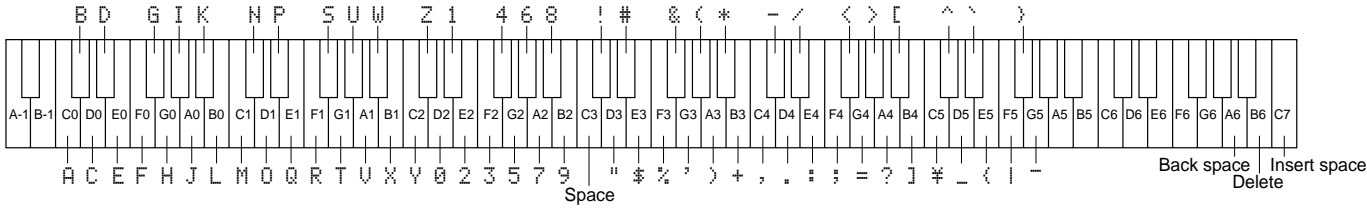

- Small capital characters can be entered by pressing the corresponding keys while holding the A-1 key.
- If you press the damper pedal while entering a character, the cursor will not move ahead to the next character. This can make it easier to select a character for a given character location.

6 Repeat Until Done

Repeat steps **4** and **5** until your name is complete.

7 Register the Name & Exit

Press the [START/STOP] button to register the entered name and exit from the utility mode. Press [UTILITY] if you want to exit without registering the name.



- Names can only be entered for songs recorded on the CVP-89, CVP-87A, CVP-85A, or CVP-83S.

19: Convert to DOC

This function can be used to convert the performance memory voice assignments used by the CVP-89 to DOC Voice Assignments so songs recorded on CVP-89 can be played back on other Clavinovas.

1 Insert a Disk & Select the Convert to DOC Function



Insert the disk containing the data to be converted into the Clavinova disk drive, then select the Convert to DOC function — see “Selecting & Using the Utility Functions”, page 42. This function cannot be executed if an appropriate disk is not loaded — see “Notes” below.

2 Select a Song Number & Execute the Conversion Function

Use the TEMPO [▲] and [▼] buttons to select the song number you want to convert, then press the [START/STOP] button to actually begin the conversion process.

Simply release the [UTILITY] button before pressing the [START/STOP] button if you want to cancel the function. You can release the [UTILITY] button once the conversion has started, and the conversion will continue to completion. The number of the measure being processed will appear on the display.

The Convert to DOC function will automatically be exited when the conversion is complete.



- The JAZZ ORGAN 2 voice will be shifted up one octave after conversion.
- This function cannot be used to convert the voice data on Disk Orchestra Collection, Disklavier, Style, Standard MIDI File, write-protected, or already-converted disks. Also, Performance Memory data recorded using the GM voice assignments cannot be converted.
- Once converted, the data cannot be returned to its original form. It is therefore a good idea to make a backup copy of the data before using this function.
- The Quantize (UTIL 15) and Track Mix (UTIL 16) functions cannot be applied to data converted by the Convert to DOC function.
- Some Clavinova models may not have the required voices or different voices will be used so the sound may not be exactly the same as the original.



20: Convert to SMF

This function can be used to convert the performance memory data used by the CVP-89 to Standard MIDI File (SMF) format so songs recorded on the CVP-89 can be played back on SMF-compatible devices.

1 Insert a Disk & Select the Convert To SMF Function

```

■■■■▶20 CONVERT TO SMF
SONG 01  PRESS [START]
  
```

Insert the disk containing the data to be converted into the Clavinova disk drive, then select the Convert to SMF function — see “Selecting & Using the Utility Functions”, page 42.

2 Select a Song Number & Execute the Conversion Function

Use the **TEMPO** [▲] and [▼] buttons to select the song number you want to convert, then press the [START/STOP] button to actually begin the conversion process.

Simply release the [UTILITY] button before pressing the [START/STOP] button if you want to cancel the function. You can release the [UTILITY] button once the conversion has started, and the conversion will continue to completion. The number of the measure being processed will appear on the display.

The Convert To SMF function will automatically be exited when the conversion is complete.



- This function cannot be used to convert the voice data on Disk Orchestra Collection, Disklavier, Style, write-protected, or already-converted disks.
- Once converted, the data cannot be returned to its original form. It is therefore a good idea to make a backup copy of the data before using this function.
- Further recording cannot be carried out with songs converted by the Convert to SMF function. Also, the Quantize (UTIL 15) and Track Mix (UTIL 16) functions cannot be applied to data converted by the Convert to SMF function.

Disk Error Messages

If an error related to the disk occurs, one of the following messages may appear. If this happens, check the possible causes and solutions listed below. If all else fails, try a different disk. If this doesn't clear up the problem, contact your Yamaha dealer.

DISK ERROR !

An error occurred while writing to or reading from the disk.

Try the operation again; if the error occurs a second time the disk or drive may be faulty. If the drive has been in use for some time the heads may be dirty. Clean the heads with a commercially-available floppy disk head cleaner. If the error still occurs with one disk and not others the disk should be considered faulty and should be discarded. If the error occurs with all disks the drive may be faulty. Refer the problem to your Yamaha dealer.

DISK PROTECTED !

You have attempted to format, write to, copy to/from, or delete data from a write-protected disk. Use a disk that is not write protected (set the disk's write-protect tab to the write-enable position).

UNFORMATTED DISK !

The loaded disk is not formatted for use with the Clavinova. After making sure that the disk does not contain any important data (for another device, for example), format the disk as described on page 48.

DISK FULL !

The currently loaded disk is full and cannot hold any more data.

Either delete unnecessary data or replace the disk with one that has more available disk space.

NO DISK !

A disk read or write operation was attempted but no disk is present in the disk drive.

Make sure an appropriate disk is inserted in the disk drive before performing any operation that involves disk access.

INCOMPATIBLE DATA!

You have attempted to perform a Convert to DOC or SMF function on data that cannot be converted.

DATA NOT EDITABLE!

You have attempted to record or edit data that is not recognized by the CVP-89. Refer to the notes on pages 38, 41, 57, and 63.



MIDI Functions

MIDI, the Musical Instrument Digital Interface, is a world-standard communication interface that allows MIDI-compatible musical instruments and equipment to share musical information and control one another. This makes it possible to create “systems” of MIDI instruments and equipment that offer far greater versatility and control than is available with isolated instruments.

The Clavinova has 11 MIDI functions that can be accessed via the normal function selection procedure (page 42), or by pressing the appropriate **VOICE** selector while holding the [UTILITY] button. The MIDI functions accessed by the various **VOICE** selectors are shown in the following chart:

Function	Selector
21. Send Channel Select	PIANO
22. Receive Channel Select	CLAVINOVA TONE
23. Local ON/OFF	E. PIANO
24. Program Change ON/CANCEL	HARPSICHORD
25. Control Change ON/CANCEL	VIBES
26. Multi-Timbre Mode ON/OFF	GUITAR
27. Split Send Mode	STRINGS
28. MIDI Clock Select	ORGAN
29. Panel Data Transmit	CHOIR
30. MIDI Transpose Transmit	UPRIGHT BASS
31. GM Drum Kit	—



- Always use a high-quality MIDI cable to connect MIDI OUT to MIDI IN terminals. Never use MIDI cables longer than about 15 meters, since cables longer than this can pick up noise which can cause data errors.
- When using the Clavinova with other MIDI equipment, always refer to the MIDI specifications (implementation chart and MIDI data format) of the equipment used to ensure compatibility.

21: Send Channel Select

In any MIDI control setup, the MIDI channels of the transmitting and receiving equipment must be matched for proper data transfer (there are 16 MIDI channels). This function sets the MIDI send (transmit) channel of the CVP-89.

1 Select the Send Channel Function

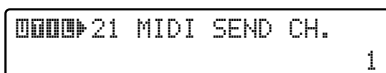

Select the Send Channel function as described in “Selecting & Using the Utility Functions” (page 42), or press [PIANO] while holding [UTILITY]. The [PIANO] indicator will light while the [UTILITY] button is pressed.

2 Set the MIDI Send Channel

Use the **TEMPO** [▲] and [▼] buttons to select the desired channel — the selected channel number is shown on the display.



- When the power is initially turned ON, the MIDI send channel is set to 1.
- “1” can be instantly selected by pressing the **TEMPO** [▲] and [▼] buttons simultaneously.

22: Receive Channel Select

In addition to the 16 MIDI channels, an “OMNI” receive mode is also available which allows reception on all 16 MIDI channels. In the OMNI mode it is not necessary to match the receive channel of the receiving device to the transmit channel of the transmitting device.

1 Select the Receive Channel Function

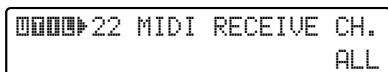

Select the Receive Channel function as described in “Selecting & Using the Utility Functions” (page 42), or press [CLAVINOVA TONE] while holding [UTILITY]. The [CLAVINOVA TONE] indicator will light while the [UTILITY] button is pressed.

2 Set the MIDI Receive Channel

Use the TEMPO [▲] and [▼] buttons to select the desired channel — the selected channel number is shown on the display, or “ALL” if the OMNI receive mode is selected.



- When the power is initially turned ON, MIDI receive is set to the OMNI ON mode and the basic receive channel is set to 1.
- “ALL” (OMNI) and basic receive channel 1 can be instantly selected by pressing the TEMPO [▲] and [▼] buttons simultaneously.

23: Local Control ON/OFF

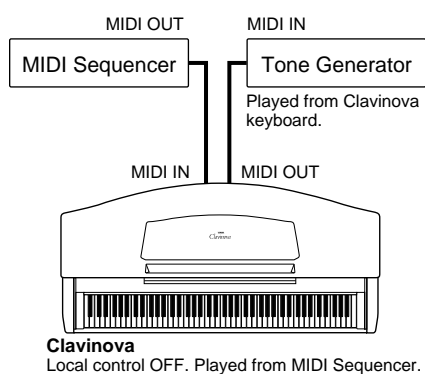

“Local Control” refers to the fact that, normally, the Clavinova keyboard controls its internal tone generator, allowing the internal voices to be played directly from the keyboard. This situation is “Local Control ON” since the internal tone generator is controlled locally by its own keyboard.

Local control can be turned off, however, so that the Clavinova keyboard does not play the internal voices, but the appropriate MIDI information is still transmitted via the MIDI OUT connector when notes are played on the keyboard. At the same time, the internal tone generator responds to MIDI information received via the MIDI IN connector. This means that while an external MIDI sequencer, for example, plays the Clavinova’s internal voices, an external tone generator can be played from the Clavinova keyboard. Local Control is automatically turned ON when the power is initially turned on.

1 Select the Local Control ON/OFF Function

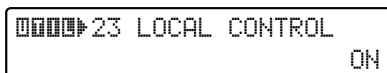

Select the Local Control ON/OFF function as described in “Selecting & Using the Utility Functions” (page 42), or press [E. PIANO] while holding [UTILITY].

2 Turn Local Control ON or OFF



= local control OFF.



= local control ON.

Use the TEMPO [▲] and [▼] buttons or the [E. PIANO] button to turn local control ON or OFF as required.

24: Program Change ON/CANCEL

Normally the Clavinova will respond to MIDI program change numbers received from an external keyboard or other MIDI device, causing the correspondingly numbered Clavinova voice to be selected. The Clavinova will normally also send a MIDI program change number whenever one of its voices is selected, causing the correspondingly numbered voice or program to be selected on the external MIDI device if the device is set up to receive and respond to MIDI program change numbers.

This function makes it possible to cancel program change number reception and transmission so that voices can be selected on the Clavinova without affecting the external MIDI device, and vice versa. Program Change is automatically turned ON when the power is initially turned on.

1 Select the Program Change ON/CANCEL Function



Select the Program Change ON/CANCEL function as described in “Selecting & Using the Utility Functions” (page 42), or press **[HARPSICHORD]** while holding **[UTILITY]**.

2 Turn Program Change ON or CANCEL



= program change reception/
transmission CANCEL.



= program change reception/
transmission ON.

Use the **TEMPO** [**▲**] and [**▼**] buttons or the **[HARPSICHORD]** button to turn program change reception and transmission ON or OFF as required.

25: Control Change ON/CANCEL

Normally the Clavinova will respond to MIDI control change data received from an external MIDI device or keyboard, causing the selected Clavinova voice to be affected by pedal and other “control” settings received from the controlling device. The Clavinova also transmits MIDI control change information when either of its pedals are operated.

This function makes it possible to cancel control change data reception and transmission if you do not want the Clavinova voices to be affected by control change data received from an external device or vice versa. Control Change is automatically turned ON when the power is initially turned on.

1 Select the Control Change ON/CANCEL Function

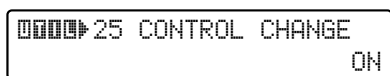

Select the Control Change ON/CANCEL function as described in “Selecting & Using the Utility Functions” (page 42), or press **[VIBES]** while holding **[UTILITY]**.

2 Turn Control Change ON or CANCEL



= control change reception/
transmission CANCEL.



= control change reception/
transmission ON.

Use the **TEMPO** [**▲**] and [**▼**] buttons or the **[VIBES]** button to turn local control reception and transmission ON or OFF as required.



26: The Multi-Timbre Mode

The Multi-Timbre mode is a special mode in which the Clavinova voices can be independently controlled on different MIDI channel numbers (1—15 in the CVP mode; 1—10,15, 16 in the DOC mode; 1—16 in the GM mode) by an external MIDI device. The Multi-Timbre mode is off (SINGLE) when the power is initially turned on.

1 Select the Multi-Timbre Mode Function

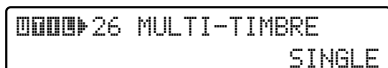

Select the Multi-Timbre Mode function as described in “Selecting & Using the Utility Functions” (page 42), or press [GUITAR] while holding [UTILITY].

2 Select a Multi-Timbre Mode

Use the TEMPO [▲] and [▼] buttons or the [GUITAR] button to select the desired Multi-Timbre mode, described in the chart below.



= Multi-Timbre mode ON.
(CVP, DOC or GM)



= Multi-Timbre mode OFF.
(SINGLE)

SINGLE Multi-Timbre mode OFF.

CVP Multi-track MIDI data received by the CVP-89 is played using the panel voice assignments — i.e. the same voices selected by the panel controls.

DOC Multi-track MIDI data received by the CVP-89 is played using the Yamaha DOC voice assignments. The panel voice assignments are not changed but the transmitted data is converted to DOC voice assignments.

GM Multi-track MIDI data received by the CVP-89 is played using General MIDI voice assignments. Transmitted data is also converted to GM voice assignments. When this mode is selected the panel voices also conform to the GM assignments (voices 1—128, drum kits 129—136).



NOTES

- See page vii, viii for listings of the voice assignments in each mode.
- The Dual, Split, internal Style, ABC, and Solo Style Play functions will not operate in the DOC or GM mode.
- Either “DOC MODE” or “GM MODE” will appear on the display when you return to the play mode.

● Recording with the GM Voices

If you press the Performance Memory [REC] button while the GM mode is engaged, the [REC] indicator and the indicator of the last selected track will light (red), and that track will be in the record ready mode. The remaining recording procedure is the same as described on page 35.



NOTES

- If the selected song number already contains data that was not recorded in the GM mode, “DATA NOT EDITABLE!” will appear on the display and recording will not be possible. The reverse is also true: i.e. panel-voice data cannot be recorded to a song that already contains GM-voice data.
- Internal styles cannot be recorded in the GM mode.
- Select a voice number between 129 and 136 to record a drum voice. When the [RHYTHM] button is pressed voice number 129 will automatically be selected if another drum voice is not already selected. Track number 10 is automatically selected for recording.
- Only tracks 3 through 9 can be selected using the [ORCH/3-10] and SONG/PHRASE NUMBER [▲] and [▼] buttons (track 10 is selected by pressing the [RHYTHM] button). It is possible, however, to record voices 129 through 136 to tracks 3 through 9.

27: The Split Send Mode

In the split send mode notes played on the left-hand section of the keyboard (to the left of and including the split point key — see “Changing the Split Point” on page 10) are transmitted on MIDI channel 2, while the upper keyboard section transmits on the MIDI channel set using the Send Channel Select function described earlier. In this mode the left- and right-hand sections of the keyboard can be used to play separate external keyboards or tone generators set to receive on the appropriate channels. The Split Send Mode is automatically turned OFF when the power is initially turned on.

1 Select the Split Send Mode Function

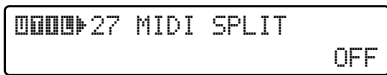

Select the Split Send Mode function as described in “Selecting & Using the Utility Functions” (page 42), or press [STRINGS] while holding [UTILITY].

2 Turn Split Send ON or OFF

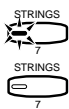

= Split Send Mode ON.

Use the **TEMPO** [▲] and [▼] buttons or the [STRINGS] button to turn split send ON or OFF as required.



= Split Send Mode OFF.

28: MIDI Clock Select

This function determines whether the Clavinova’s rhythm and ABC timing is controlled by the Clavinova’s own internal clock or an external MIDI clock signal received from external equipment connected to the MIDI IN connector. The Clock Mode is automatically set to INTERNAL when the power is initially turned on.

1 Select the MIDI Clock Select Function

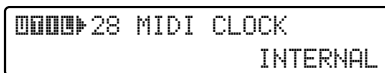

Select the MIDI Clock Select function as described in “Selecting & Using the Utility Functions” (page 42), or press [ORGAN] while holding [UTILITY].

2 Set the MIDI Clock to INTERNAL or MIDI IN



= MIDI IN.

Use the **TEMPO** [▲] and [▼] buttons or the [ORGAN] button to set the MIDI clock to INTERNAL or MIDI IN as required.



= INTERNAL.



- If the Clock Mode is set to MIDI IN and a MIDI clock signal is not being received from an external source, the rhythm, ABC and other clock-dependent features will not operate.

29: Panel Data Send

This function causes all the current Clavinova panel settings (selected voice, etc.) to be transmitted via the MIDI OUT connector. This is particularly useful if you will be recording performances to a MIDI sequence recorder which will be used to control the Clavinova on playback. By transmitting the Clavinova panel settings and recording them on the MIDI sequence recorder prior to the actual performance data, the Clavinova will be automatically restored to the same settings when the performance is played back.

1 Select the Panel Data Send Function

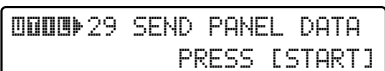

Select the Panel Data Send function as described in “Selecting & Using the Utility Functions” (page 42), or press [CHOIR] while holding [UTILITY] to send the data immediately (in the latter case the next step is not required).

2 Send the Panel Data

Press the [START/STOP] button to begin transmission of the panel data.

30: MIDI Transpose Transmit

This function transposes the pitch of transmitted MIDI note data up or down in semitone intervals up to a maximum of six semitones. The pitch of notes played on the keyboard is not affected.

1 Select the MIDI Transpose Transmit Function

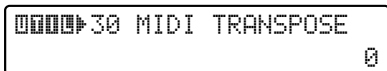

Select the MIDI Transpose Transmit function as described in “Selecting & Using the Utility Functions” (page 42), or press [UPRIGHT BASS] while holding [UTILITY]. The [UPRIGHT BASS] indicator will light while the [UTILITY] button is pressed.

2 Set the Transpose Value As Required

Display	Transposition
-6	-6 semitones
-5	-5 semitones
-4	-4 semitones
-3	-3 semitones
-2	-2 semitones
-1	-1 semitone
0	Normal
+1	+1 semitone
+2	+2 semitones
+3	+3 semitones
+4	+4 semitones
+5	+5 semitones
+6	+6 semitones

Use the TEMPO [▲] and [▼] buttons to set the MIDI Transpose Transmit value as required.



- Press the TEMPO [▲] and [▼] buttons simultaneously while holding the [UTILITY] button to restore normal transmitted pitch.
- Transpose is always set to Normal when the power is turned on.

31: GM Drum Kit

The CVP-89 includes two different GM drum kits that can be selected via this function. There’s also an “AUTO” setting that allows automatic GM drum kit selection.

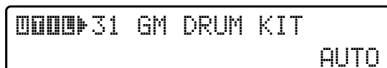

- NORMAL** The default Yamaha-standard GM drum kit. Can be used with most General MIDI software.
- TG100** This kit has the same instrument assignments as the Yamaha TG100 tone generator. When a GM drum kit is selected via the panel (129 through 136 in the GM mode), the normal drum kit name will remain on the display but the TG100 kit will be played via the keyboard.
- AUTO** This is the default setting. The TG100 kit is automatically selected when appropriate disk is inserted. The NORMAL kit is selected at other times. When “AUTO” is selected and a GM drum kit is selected via the panel (129 through 136 in the GM mode), the normal drum kit will be played via the keyboard.

General Utilities

The functions in this group apply to a wide range of functions and features.

32: Individual Key Tuning

The Individual Key Tuning Feature makes it possible to individually tune each key on the CVP-89 keyboard in order to match different tuning standards. The pitch of each key can be raised or lowered by a maximum of 50 cents (approximately) from the standard pitch.

1 Select the Individual Key Tuning Function

```

0000 32 IND. KEY TUNING
                NO/YES
  
```

Select the Individual Key Tuning function — see “Selecting & Using the Utility Functions”, page 42. “NO/YES” will flash on the display. Press the **TEMPO [▲]** button (YES) to engage the Individual Key Tuning function, or the **[▼]** button (NO) to cancel. Once you’ve pressed the **TEMPO [▲]** button to engage the function you can release the **[UTILITY]** button.

2 Select Up or Down Tuning

```

INDIVIDUAL KEY TUNE
ON(UP)          ----=+ 0
  
```

First, use the **[TAP]** and **[METRONOME]** buttons to select either “ON (UP)” if you want to raise the pitch of a key or “ON (DOWN)” if you want to lower the pitch of a key.

OFF Individual key tuning OFF.
ON (UP) Raise pitch.
ON (DOWN) Lower pitch.

3 Press the Key To Be Tuned Once

```

INDIVIDUAL KEY TUNE
ON(UP)          C 3=+ 0
  
```

Press the key to be tuned once to display the current tuning value on the display. “0” indicates normal pitch, positive values indicate that pitch has been increased by the corresponding number of steps (about 1.2 cents per step), and negative (“-”) values indicate that pitch has been lowered by the corresponding number of steps.

4 Press the Key To Tune

Subsequent presses on the key selected in the previous step tune the key in the specified “(UP)” or “(DOWN)” direction — one 1.2-cent step per press. The highest and lowest possible values are “+44” and “-44”, respectively. The **TEMPO [▲]** and **[▼]** keys can also be used to tune as required: **[▲]** to tune up and **[▼]** to tune down.



- “0” can be instantly selected by pressing the **TEMPO [▲]** and **[▼]** buttons simultaneously.

5 Select a New Key Or Exit

To tune a different key, repeat steps **2** through **4**, above. To exit from the Individual Key Tuning function, press the **[UTILITY]** button.



- Individual key tuning is automatically turned OFF whenever the **POWER** switch is turned on.
- The Individual Key Tuning data will be erased when the power is turned off, but can be saved to and loaded from disk by using the “Save Individual Key Tuning” and “Load Individual Key Tuning” functions (page 45).

33: Touch Sensitivity

The Clavinova can be set to one of three different types of keyboard touch sensitivity to match different playing styles and preferences.

33 TOUCH SENS
MEDIUM

- SOFT** Allows maximum loudness to be produced with relatively light key pressure.
- MEDIUM** Produces a fairly “standard” keyboard response.
- HARD** Requires the keys to be played quite hard to produce maximum loudness.



- The **MEDIUM** setting is automatically selected whenever the **POWER** switch is turned on.

34: Accompaniment Volume Mode

Normally the Auto Accompaniment volume controls are used to adjust the volume of the Rhythm, Chord 1, Chord 2, and Bass accompaniment parts, as labelled on the Clavinova panel. This function can be used to assign these volume controls to other operations.

34 ACCOMP. VOLUME
1

- 1 Rhythm, Chord 1, Chord 2, and Bass volume control.
- 2 Modulation, Pitch Bend +, Pitch Bend -, and Expression. In this mode the **RHYTHM** slider controls modulation depth, the **CHORD 1** slider controls upward pitch bend, the **CHORD 2** slider controls downward pitch bend, and the **BASS** slider controls expression (overall volume).
- 3 Reverb depth for the Rhythm, Chord 1, Chord 2, and Bass tracks. This applies when playing with ABC and when playing back performance memory data that was recorded with ABC. When playing back performance memory data that was recorded without ABC, and when playing back Disk Orchestra Collection data, the **CHORD 1**, **CHORD 2** and **BASS** controls correspond to tracks 4-10, 1-2, and 3, respectively.



- The **Rhythm, Chord 1, Chord 2, and Bass volume setting (1)** is automatically selected whenever the **POWER** switch is turned on.
- **1 and 2** can be recorded and their initial values can be changed as described on page 38. **3** applies only to playback.

35: Style Tempo Switching

This function determines whether the preset tempo for each style will be automatically selected whenever a style is selected (while style playback is stopped) or whether the currently selected tempo will be maintained regardless of the selected style (refer to page 17).

35 STYLE TEMPO
SET TEMPO

- KEEP TEMPO** Style tempo switching OFF — the current tempo is maintained.
- SET TEMPO** Style tempo switching ON — the preset tempo for each style is automatically selected.



- **Style tempo switching** is automatically set to “**SET TEMPO**” whenever the **POWER** switch is turned on.

36: Auto Synchro Start Switching

This function determines whether the “Synchro Start” mode will automatically be turned ON and OFF when an ABC mode is turned ON and OFF (refer to page 19, 22).

0000 36 ABC SYNC. START
ON

- OFF** Auto synchro start switching OFF — synchro start is not turned on and off with ABC.
- ON** Auto synchro start switching ON — synchro start is automatically turned on and off with ABC.



NOTES

- When this function is OFF the SYNCHRO START mode will not be retained after stopping an accompaniment that was started using the SYNCHRO START mode.
- Auto synchro start switching is automatically turned ON whenever the POWER switch is turned on.

37: Random All Song Repeat

This function determines whether the songs are played back and repeated in sequential or random order when “ALL” is selected when playing back a disk (refer to page 30). This function also affects demo song playback (page 6).

0000 37 RANDOM PLAY
OFF

- OFF** Random all song repeat OFF — the songs are played in sequence.
- ON** Random all song repeat ON — the songs are played in random order.



NOTES

- Random all song repeat is automatically turned OFF whenever the POWER switch is turned on.

38: Damper Pedal Mode

Sets the damper pedal for on/off or continuous operation (refer to page 14).

0000 38 DAMPER PEDAL
CONTINUOUS

- CONTINUOUS** Continuous damper pedal operation.
- SW** On/off damper pedal operation.



NOTES

- Continuous damper pedal operation (CONTINUOUS) is automatically selected whenever the POWER switch is turned on.

39: Pitch Bend Range

0000 39 PITCH BEND RANGE
100Cent

This function allows the maximum pitch bend range to be set from 100 cents to 1200 cents in 100-cent increments for each individual voice (100 cents = 1 semitone). First select the voice you want to set the pitch bend range for, then select and set the Pitch Bend Range function.



NOTES

- A complete list of the preset pitch bend ranges for each voice is given on page vii.
- The pitch bend range of the voice shown to the left of the display takes priority in the DUAL mode. In the Split mode the right-hand voice setting takes priority.
- The pitch bend range settings are retained in memory for approximately one week even when the power is turned off.
- Unexpected sound may be produced if the pitch of a note is bent beyond the range of the voice. See page 8 for a list of the usable ranges for each voice.

40: Edit Drum Instrument

The CVP-89 has two drum kits — NORMAL and PROCESSED — and this function allows either kit to be selected for each individual drum instrument. Individual reverb depth and pan settings are also possible.

1 Select the Edit Drum Instrument Function

```

██████▶40 EDIT DRUM INST.
                               NO/YES
  
```

Select the Edit Drum Instrument function — see “Selecting & Using the Utility Functions”, page 42. Then press the **TEMPO** [▲] button if you actually want to engage the Edit Drum Instrument function. Once the **TEMPO** [▲] button has been pressed you can release the [UTILITY] button. The DRUMS voice will automatically be selected and the kit (NORMAL or PROCESSED) for the currently selected style will be recalled.

2 Select an Instrument

```

██████▶40 EDIT DRUM INST.
                               PRESS [DRUM KEY]
  
```

Press the key on the CVP-89 keyboard corresponding to the drum instrument you want to edit. The name of the selected instrument and the drum kit currently selected for that instrument will appear on the display.

3 Select a Parameter

```

EDIT DRUM INSTRUMENT
Rim Lite  KIT:  NORMAL
  
```

Use the [TAP] and [METRONOME] buttons to select the parameter you want to edit: KIT, REV DEPTH, or PAN.

4 Edit the Parameter as Required

```

EDIT DRUM INSTRUMENT
Rim Lite  REV DEPTH:  8
  
```



- If you press the C7 key while the KIT parameter is selected, “ALL” will appear in place of the instrument name and the NORMAL or PROCESSED kit can be selected for all instruments. The REV DEPTH and PAN parameters for all instruments return to their default values and cannot be edited when “ALL” is selected.
- Up to 16 individual reverb depth settings, 8 pan settings, and 8 kit settings can be made — e.g. after setting KIT to “ALL” and selecting “NORMAL” or “PROCESSED”. If you attempt to make more reverb depth, pan, or kit settings the “TOO MANY!” error message will appear. The reverb depth and pan settings of an already-edited instrument can be restored to their default values by simultaneously pressing the TEMPO [▲] and [▼] buttons. Since some instruments are already edited for some accompaniment styles, the maximum number of editable instruments will be less when those styles are selected.
- The Edit Drum Instrument function cannot be used in the GM mode — “DATA NOT EDITABLE!” will appear on the display.
- See page ix for a list of the NORMAL or PROCESSED kit.

```

EDIT DRUM INSTRUMENT
ALL       KIT:PROCESSED
  
```

5 Select a New Instrument Or Exit

To edit a different instrument, repeat steps 2 through 4, above. To exit from the Edit Drum Instrument function, press the [UTILITY] button.

41: Split Left Octave

This function determines whether the left-hand voice in a split keyboard setup will be automatically shifted up one octave (refer to page 10).

```

0000 41 SPLIT-L OCTAVE
                + 1
  
```

- 0** Octave shift OFF — no octave shift will occur.
- +1** Octave shift ON — all voices except BASS (voice numbers 10, 11, 49, 50, 51, and 52) and DRUMS (voice numbers 12) will be shifted.



NOTES

- Octave shift is automatically turned ON (+1) whenever the POWER switch is turned on.

42: Registration Tempo

Determines whether the tempo setting in a recalled registration memory will be used or not (refer to page 29).

```

0000 42 REGIST. TEMPO
                SET TEMPO
  
```

- KEEP TEMPO** The recalled tempo setting is not used — the tempo will not change when a registration memory is recalled.
- SET TEMPO** The recalled tempo setting is used — the tempo will change when a registration memory is recalled.



NOTES

- The registration Tempo function is automatically turned SET TEMPO whenever the POWER switch is turned on.

43: ABC Auto Mute

Turns the Auto Accompaniment mute function on or off (refer to page 23).

```

0000 43 ABC AUTO MUTE
                ON
  
```

- OFF** Mute OFF.
- ON** Mute ON.



NOTES

- The mute function is automatically turned ON whenever the POWER switch is turned on.

44: Minor Harmonization

Turns the Auto Accompaniment minor harmonization function on or off (refer to page 23).

```

0000 44 7th CHORD IN min
                CHORD TONE
  
```

- NORMAL** Minor harmonization OFF.
- CHORD TONE** Minor harmonization ON.



NOTES

- The Minor harmonization function is automatically turned OFF (NORMAL) whenever the POWER switch is turned on.

Although the Clavinova is a self-contained musical instrument that simply be plugged into the AC mains outlet and played, it also features a number of connectors for system expansion.

● AUX IN L and R Jacks

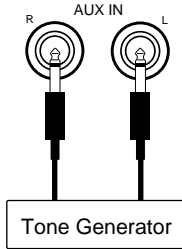

These jacks are intended primarily for use with external synthesizers or tone generator modules.

For example, the outputs of the synthesizer/tone generator can be to the Clavinova **AUX IN** jacks, allowing the sound of the synthesizer/tone generator to be reproduced via the Clavinova's internal amplifier and speaker system.



- The input signal from the **AUX IN** jacks is delivered to the **AUX OUT** jacks, but is not affected by the Clavinova's volume control or reverb effect.

● AUX OUT L/L+R and R Jacks

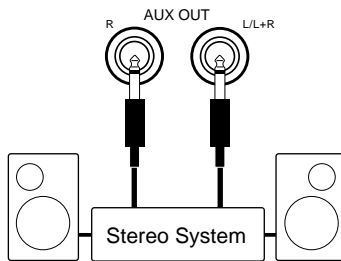

The **AUX OUT L/L+R** and **R** jacks deliver the output of the Clavinova for connection to an instrument amplifier, mixing console, PA system, or recording equipment. If you will be connecting the Clavinova to a monaural sound system, use only the **L/L+R** jack. When a plug is inserted into the **L/L+R** jack only, the left- and right-channel signals are combined and delivered via the **L/L+R** jack so you don't lose any of the Clavinova's sound.



- The **AUX OUT** jack signal must never be returned to the **AUX IN** jacks, either directly or through external equipment.

● MIDI IN, THRU and OUT Connectors

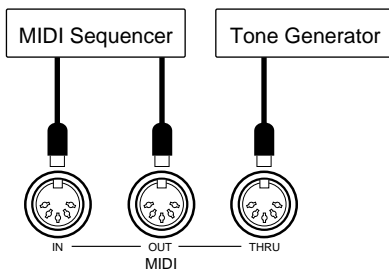

The **MIDI IN** connector receives MIDI data from an external MIDI device (such as a synthesizer, sequencer, music computer, etc.) which can be used to control the Clavinova. The **MIDI THRU** connector re-transmits any data received at the **MIDI IN** connector, allowing "chaining" of several MIDI instruments or other devices. The **MIDI OUT** connector transmits MIDI data generated by the Clavinova (e.g. note and velocity data produced by playing the Clavinova keyboard).

More details on MIDI are given in "MIDI Functions" on page 54.

● EXP PEDAL Jack

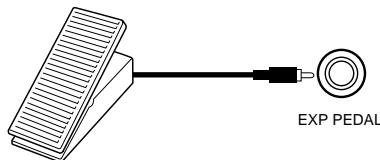

An optional Yamaha EP-1 Expression Pedal can be plugged into this jack for foot volume (expression) control of the keyboard sound only (i.e. expression doesn't affect the auto-accompaniment sound or disk playback). Press the pedal forward to increase volume, and backward to decrease volume.

● MIC. Jack and VOL. Control

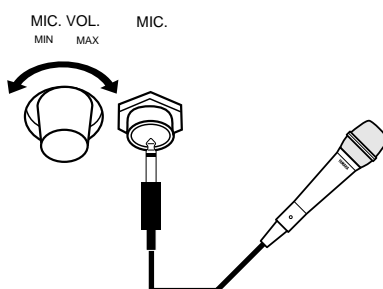

- The depth of the digital reverb effect applied to the microphone sound can be adjusted via the "Mic Reverb Depth" utility function described on page 43.

Factory Preset Recall

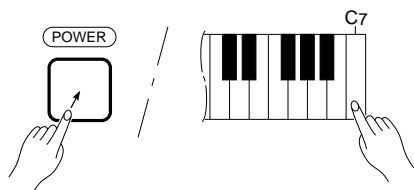

The factory preset settings for the data listed below can be restored by holding the C7 key while turning the power on.

- Registration memory data.
- Style disk load data.
- Custom rhythm data. (no data)
- Pitch bend range data.
- Chorus ON/OFF data.
- Soundboard depth data.



NOTES

- *Custom Rhythm initially contains no data, so any Custom Rhythm data you have created will be erased when the Factory Preset Recall function is executed.*

Troubleshooting

If you encounter what appears to be a malfunction, please check the following points before assuming that your Clavinova is faulty.

1. No Sound When the Power is Turned On

Is the AC plug properly connected to an AC wall outlet? Check the AC connection carefully. Is the **MASTER VOLUME** control turned up to a reasonable listening level?

2. No Rhythm, ABC, or Performance Memory Sound

Check the Auto Accompaniment volume control settings. No sound is produced if these are set to their minimum positions.

3. The Clavinova Reproduces Radio or TV Sound

This can occur if there is a high-power transmitter in your vicinity. Contact your Yamaha dealer.

4. Intermittent Static Noise

This is usually due to turning on or off a household appliance or other electronic equipment which is fed by the same AC mains line as your Clavinova.

5. Interference Appears On Radio or TV Sets Located Near the Clavinova

The Clavinova contains digital circuitry which can generate radio-frequency noise. The solution is to move the Clavinova further away from the affected equipment, or vice versa.

6. Distorted Sound When the Clavinova is Connected to An External Amplifier/Speaker System

If the Clavinova is connected to a stereo system or instrument amplifier and the sound is distorted, reduce the setting of the Clavinova volume control to a level at which the distortion ceases.

Options

● BC-10 Bench

A stable, comfortable bench styled to match your Yamaha Clavinova.

● HPE-160 Stereo Headphones

High-performance lightweight dynamic headphones with extra-soft ear pads.



NOTES

- *Some items may not be available in certain areas.*

A		K		Repeat functions, disk orchestra 33	
A-B repeat, disk orchestra 33		Key cover 4		Reverb depth control 12	
ABC auto mute 64		Keyboard percussion 8		Reverb effects 12	
Accompaniment 17				Rewind & fast forward, disk orchestra 34	
Accompaniment volume mode 61		L		Rhythm break, left pedal 15, 20	
Assembly i		Left pedal 14		Right pedal 14	
Auto bass chord (ABC) 21		Load custom rhythm 46			
Auto synchro start switching 62		Load individual key tuning 45		S	
Automatic performance, disk orchestra 30		Load registration 44		Save custom rhythm 45	
Aux jacks 65		Local control on/off 55		Save individual key tuning 45	
				Save registration 44	
B		M		Send channel select 54	
Balance, split mode 11		Metronome 20		Single-finger accompaniment 21	
		Mic jack & volume control 65		Soft, left pedal 14	
C		Mic reverb depth 43		Solo styleplay, left pedal 15, 28	
Chord sequence function 41		MIDI clock select 58		Solo styleplay, using 28	
Chorus on/off 43		MIDI connectors 65		Song copy 46	
Connectors 65		MIDI data format iii		Song delete 47	
Control change on/cancel 56		MIDI transpose transmit 59		Song name 51	
Controls, panel 2		Minor harmonization 23, 64		Sostenuto pedal 14	
Convert to DOC 52		Multi-timbre mode 57		Soundboard depth 43	
Convert to SMF 53		Multi-timbre recording via MIDI 40		Specifications xi	
Custom rhythm 24		Music data, playing other types 34		Split left octave 64	
		Music stand 4		Split mode 10	
D		Mute mode 23		Split point, ABC 23	
Damper pedal mode 62				Split point, changing 10	
Damper pedal, split mode 11		N		Split send mode 58	
Demonstration playback 6		Next phrase, disk orchestra 34		Standard MIDI file playback mode 48	
Disk copy, disk orchestra 34				Start/stop, left pedal 15	
Disk error messages 53		O		Starting accompaniment 18	
Disk format 48		Options 66		Stopping accompaniment 20	
Disk orchestra 30				Store, registration memory 29	
Disk styles, loading 26		P		Style selection, accompaniment 17	
Disk styles, using 27		Pan 13		Style tempo switching 61	
Dual mode 9		Panel send data 58		Synchronized start 19	
		Pause, disk orchestra 34			
E		Pedal pause, disk orchestra 34		T	
Edit drum instrument 63		Pedals 14		Tap start 19	
Exp pedal jack 65		Percussion kit list ix		Tempo control 18	
Expression control 5		Performance memory 35		Touch sensitivity 61	
		Pitch bend range 62		Track mix 50	
F		Pitch bend, left pedal 15		Transpose 43	
Factory preset recall 66		Pitch control 16		Troubleshooting 66	
Fill-ins 20		Pitch display 16			
Fingered accompaniment 21		Playing specific parts, disk orchestra 31		U	
Fingering chart xii		Polyphony 13		Utility functions, list 42	
Floppy disk handling 1		Power switch 4		Utility functions, selecting 42	
Full-keyboard ABC 22		Program change on/cancel 56			
		Punch-in recording 39		V	
G				Voice balance, dual mode 9	
GM drum kit 59		Q		Voice list 8	
Guided practice, disk orchestra 32		Quantize song data 49		Voice list vii	
				Voice selection 7	
H		R		Volume control, utility 50	
Harmonization variations, solo styleplay 28		Random all song repeat 62		Volume controls 5, 23, 32	
Headphones 4		Recall, registration memory 29			
		Receive channel select 55			
I		Recording & playback, multitrack 36			
Individual key tuning 60		Recording & playback, one-pass 35			
Introduction 19		Registration memory 29			
		Registration tempo 64			



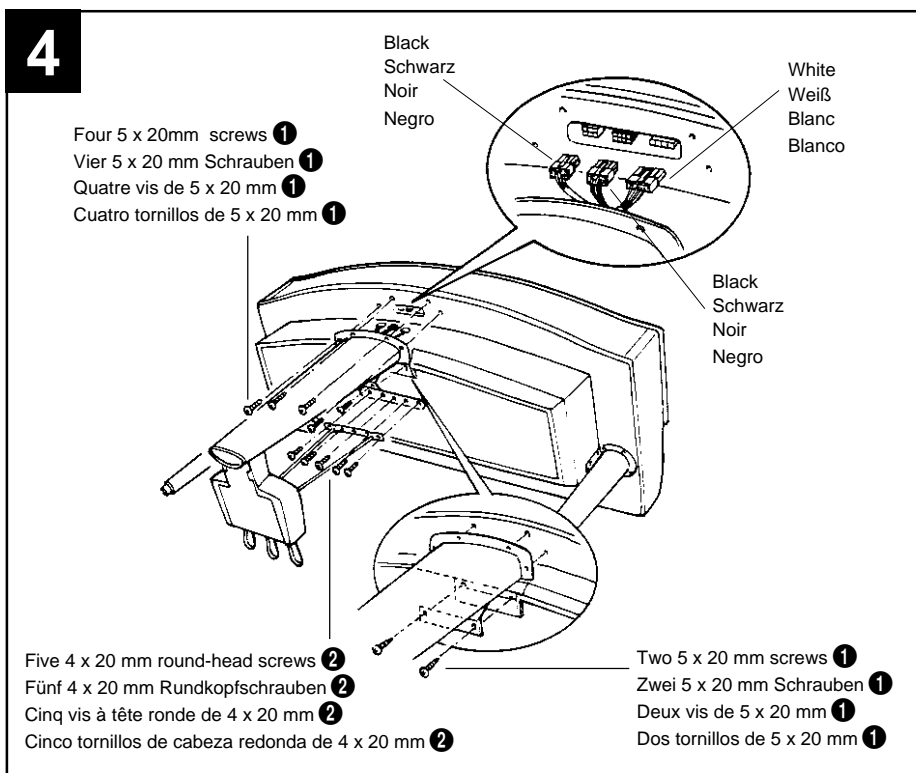
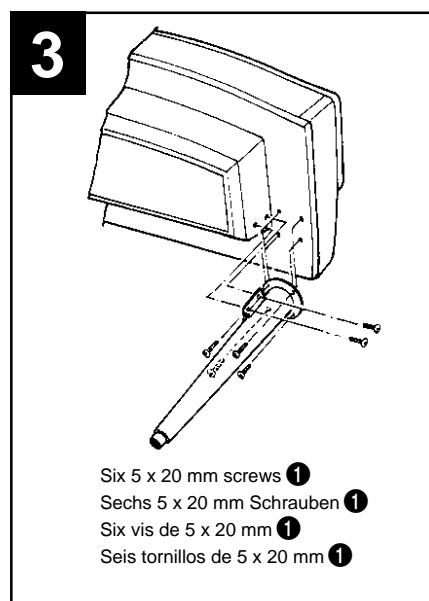
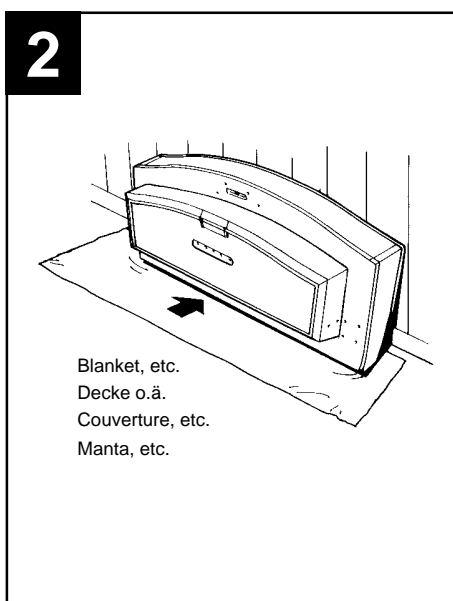
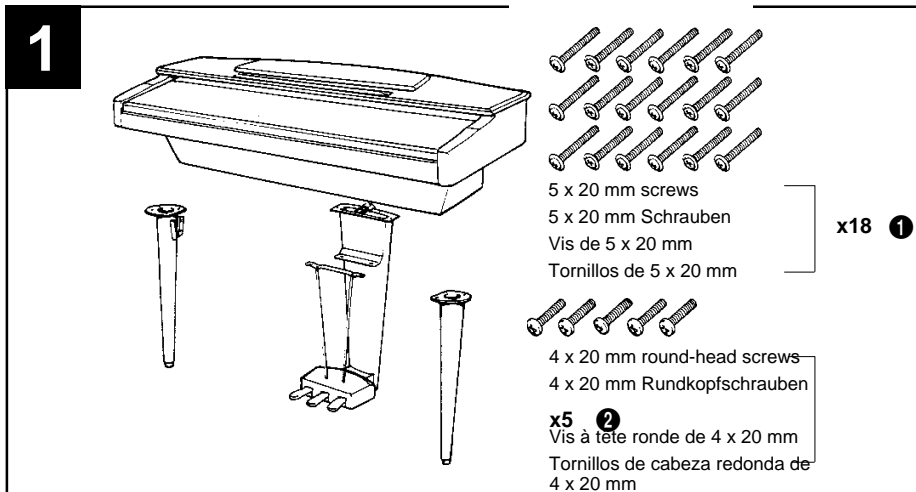

Assembly

NOTES

- We do not recommend attempting to assemble the Clavinova alone. The job can be easily accomplished, however, with only two people.
- Use only the screws provided or replacements of exactly the specified size. Using screws of the wrong size can result in damage to the instrument.

1 Open the box and remove all the parts.

On opening the box you should find the parts shown in the illustration above. Check to make sure that all the required parts are provided.

2 Carefully lean the main unit against a wall.

To make it easier to install the legs, place a soft blanket or similar material on the floor near a wall, close the Clavinova keyboard cover, place the front panel of the Clavinova (the side with the keyboard) on the blanket and gently lean the unit against the wall — **MAKING SURE THAT IT CAN NOT FALL** — as shown in the illustration.

3 Attach the front legs.

Securely attach the two front legs using six 5 x 20 mm screws ① each (use a Philips “+” screwdriver), as shown in the illustration. Make sure the screws are securely tightened.

4 Attach the rear leg and pedal box assembly.

Before attaching the rear leg and pedal box assembly, insert the 3 plugs extending from the rear leg into the corresponding sockets in the main unit, making sure that the connectors must be inserted with the protruding clip facing the rear of the main unit. Then securely attach the rear leg with the six 5 x 20 mm screws ①, and the pedal bracket with the five 4 x 20 mm round-head screws ②.

IMPORTANT

- After assembling the Clavinova, check once more to make sure that all screws have been securely fastened.
- If the stand leans to the side, makes unusual noises, or otherwise seems unstable during use, check and tighten all screws while following the assembly instructions given above.

Zusammenbau

HINWEISE

- Wir raten davon ab, das Clavinova alleine zusammenzubauen und aufzustellen. Zwei Personen können diese Arbeit jedoch problemlos ausführen.
- Verwenden Sie ausschließlich die mitgelieferten Schrauben oder Ersatzschrauben identischer Größe. Die Verwendung von Schrauben mit abweichenden Maßen kann eine Beschädigung des Instruments zur Folge haben.

1 Den Versandkarton öffnen und alle Teile auspacken.

Der Karton sollte alle in der Abbildung gezeigten Teile enthalten. Vergewissern Sie sich, daß alle Teile vollständig vorhanden sind.

2 Die Haupteinheit vorsichtig an eine Wand lehnen.

Um das Anschrauben der Beine zu erleichtern, breiten Sie eine Decke oder ein weiches Tuch neben der Wand auf dem Boden aus, schließen den Tastaturdeckel des Clavinova, stellen das Instrument mit der Vorderkante (Seite mit der Tastatur) vorsichtig auf die Decke und lehnen es an die Wand, wie in der Abbildung gezeigt. **VERGEWISSERN SIE SICH, DASS DAS INSTRUMENT NICHT KIPPEN ODER WEGRUTSCHEN KANN!**

3 Die vorderen Beine montieren.

Beine mit jeweils sechs 5 x 20 mm Schrauben ❶ (Kreuzschlitzschraubendreher verwenden!) gut am Clavinova fest, wie in der Abbildung gezeigt. Ziehen Sie die Schrauben fest an.

4 Das hintere Bein mit dem Pedalkasten montieren.

Bevor Sie das hintere Bein mit dem Pedalkasten anbringen, schließen Sie die 3 aus dem hinteren Bein ragenden Stecker an die entsprechenden Buchsen der Haupteinheit an. Die Stecker müssen mit dem hervorstehenden Clip zur Rückseite der Haupteinheitweisend in die Buchsen gesteckt werden. Schrauben Sie das hintere Bein danach mit sechs 5 x 20 mm Schrauben ❶ und die Pedalstrebe mit den fünf 4 x 20 mm Rundkopfschrauben ❷ gut fest.

WICHTIG

- Vergewissern Sie sich nach Zusammenbau und Aufstellung des Clavinova noch einmal davon, daß alle Schrauben fest angezogen sind.
- Wenn der Ständer schief steht, komische Geräusche erzeugt oder sich beim Spielen wackelig anfühlt, prüfen Sie gemäß den unter "Zusammenbau und Aufstellung" gegebenen Anweisungen, ob der Ständer richtig zusammengebaut wurde, und ziehen dabei die einzelnen Schrauben noch einmal nach.

Montage

REMARQUES

- Nous ne vous conseillons pas d'essayer d'assembler le Clavinova seul. Toutefois, ce travail peut être facilement exécuté par deux personnes.
- N'utilisez que les vis fournies ou des vis ayant exactement les mêmes dimensions. L'utilisation de vis de dimensions incorrectes pourrait endommager l'instrument.

1 Ouvrir le carton et retirer toutes les pièces

Les pièces indiquées sur l'illustration devraient toutes se trouver dans le carton. Vérifier qu'il n'en manque aucune.

2 Appuyez le clavier contre un mur en faisant très attention

Pour faciliter la pose des pieds, placez une couverture épaisse, ou un matériau similaire, sur le plancher à proximité d'un mur. Fermez le cache-clavier et placez le bord avant (bord côté clavier) du Clavinova sur la couverture et appuyez ensuite le Clavinova contre le mur de la manière illustrée. **ASSUREZ-VOUS QU'IL NE PEUT PAS TOMBER.**

3 Posez les pieds avant

Fixez chacun des deux pieds avant à l'aide de six vis de 5 x 20 mm ❶ (utilisez un tournevis cruciforme "+") comme illustré. Vérifiez que les vis sont serrées à fond.

4 Fixez le pied arrière et le pédalier

Avant de fixer le pied arrière et le pédalier, branchez les 3 connecteurs sortant du pied arrière aux prises correspondantes du clavier, en veillant à ce que les connecteurs soient branchés avec la languette dirigée vers l'arrière du clavier. Fixez ensuite le pied arrière à l'aide de six vis de 5 x 20 mm ❶ et la ferrure du pédalier à l'aide de cinq vis à tête ronde de 4 x 20 mm ❷.

IMPORTANT

- Après avoir assemblé le Clavinova, vérifiez une fois de plus que toutes les vis sont bien serrées.
- Si le support du clavier penche d'un côté, fait du bruit ou semble instable lorsque vous utilisez l'instrument, vérifiez de nouveau et resserrez toutes les vis en suivant les instructions d'assemblage données ci-dessus.

Montaje

NOTAS

- No le recomendamos que intente montar la Clavinova usted solo. El trabajo puede ser realizado fácilmente entre dos personas.
- Utilice sólo los tornillos suministrados o reemplazos del exacto tamaño específico. El empleo de tornillos de un tamaño erróneo puede dañar el instrumento.

1 Abra la caja y extraiga todas las partes.

Al abrir la caja, encontrará las partes que se muestran en la ilustración de arriba. Asegúrese de que no falta ninguna de las partes requeridas.

2 Incline con cuidado la unidad principal contra una pared.

Para facilitar la instalación de las patas, coloque una manta blanda o un material semejante sobre el piso cerca de una pared, cierre la cubierta del teclado de la Clavinova, coloque el panel frontal de la Clavinova (el lado con el teclado) sobre la manta e incline con cuidado la unidad contra la pared, **ASEGURÁNDOSE DE QUE NO PUEDA CAERSE**, como se muestra en la ilustración.

3 Instale las patas delanteras.

Instale con seguridad las dos patas delanteras usando seis tornillos de 5 x 20 mm ❶ en cada una (emplee un destornillador de cabeza en cruz), como se muestra en la ilustración. Asegúrese de que los tornillos se aprietan bien.

4 Instale la pata trasera y el conjunto de la caja de pedales.

Antes de instalar la pata trasera y el conjunto de la caja de pedales, inserte las 3 clavijas que salen de la pata trasera en los enchufes correspondientes de la unidad principal, asegurándose de que los conectores quedan insertados con el retenedor que sobresale encarado a la parte posterior de la unidad principal. Entonces, instale con seguridad la pata trasera con los seis tornillos de 5 x 20 mm ❶, y la ménsula de pedales con los cinco tornillos de cabeza redonda de 4 x 20 mm ❷.

IMPORTANTE

- Después de montar la Clavinova, compruebe otra vez para asegurarse de que todos los tornillos se han apretado bien.
- Si el soporte se inclina hacia un lado, hace ruidos anormales, o parece inestable durante la utilización, compruebe y apriete todos los tornillos mientras sigue las instrucciones de montaje de arriba.

If you're already very familiar with MIDI, or are using a computer to control your music hardware with computer-generated MIDI messages, the data provided in this section can help you to control the Clavinova.

Falls Sie bereits mit MIDI vertraut sind oder einen Computer zur Hardware-Steuerung einsetzen, werden Ihnen die nachfolgend aufgeführten Daten bei der Steuerung des Clavinovas wahrscheinlich hilfreich sein.

Si vous vous êtes déjà familiarisés avec l'interface MIDI, ou si vous utilisez un ordinateur pour commander votre matériel de musique au moyen de messages MIDI générés par ordinateur, les données suivantes vous aideront à commander le Clavinova.

Si ya está muy familiarizado con MIDI o si está usando una computadora para controlar su música con mensajes MIDI generados por computadora, los datos proporcionados en esta sección le ayudarán a controlar la Clavinova.

1. NOTE ON/OFF

[9nH] [kkH] [vvH]

9nH= Note on/off event
(n= MIDI channel number)

kkH= Note number
(Transmission: 0FH~72H= D#-1~F#7,
Reception= 15H~6CH: A-1~C7)

vvH= Velocity
(Note on= 01H~7FH, Note off= 00H)

[8nH] [kkH] [vvH]

8nH= Note off event
(n= MIDI channel number)

kkH= Note number
(Transmission: 0FH~72H= D#-1~F#7,
Reception= 15H~6CH: A-1~C7)

vvH= Velocity (Note off= 00H~7FH)

* 8nH (note off) is receive only.
9nH (vvH=00H) used for transmission.

2. CONTROL CHANGE

[BnH] [ccH] [vvH]

BnH= Control event
(n= MIDI channel number)

ccH= Control number
vvH= Control value

• Modulation (Vibrato)

[BnH] [01H] [vvH]

n= MIDI channel number
vvH= Modulation

00H~0FH: Off : AM also off.
10H~1FH: 1 : Voice default AM
when greater than 10H

20H~2FH: 2
30H~3FH: 3
40H~4FH: 4
50H~5FH: 5
60H~6FH: 6
70H~7FH: 7

* LFO speed fixed for each voice

• Volume

[BnH] [07H] [vvH]

n= MIDI channel number
vvH= Volume (00H~7FH)

00H: $-\infty$
6FH: -3dB
7FH: ± 0 dB

• Pan

[BnH] [0AH] [vvH]

n= MIDI channel number
vvH= Pan (00H~7FH)

00H~17H: Left 6
18H~1FH: Left 5
20H~27H: Left 4
28H~2FH: Left 3
30H~37H: Left 2
38H~3FH: Left 1
40H~47H: Center
48H: Voice default Pan
49H: Scaling Pan (Standard) (receive only)
4AH: Scaling Pan (Wide) (receive only)
4BH: Scaling Pan (Narrow L) (receive only)
4CH: Scaling Pan (Narrow C) (receive only)
4DH: Scaling Pan (Narrow R) (receive only)
4EH: Scaling Pan (Half L) (receive only)
4FH: Scaling Pan (Half R) (receive only)
50H~57H: Right 1
58H~5FH: Right 2
60H~67H: Right 3
68H~6FH: Right 4
70H~77H: Right 5
78H~7FH: Right 6

• Expression

[BnH] [0BH] [vvH]

n= MIDI channel number
vvH= Expression (00H~7FH)

00H: $-\infty$
6FH: -3dB
7FH: ± 0 dB

• Damper pedal

[BnH] [40H] [vvH]

n= MIDI channel number
vvH= Control value (00H~7FH)
8 levels max.

• Sostenuto pedal

[BnH] [42H] [vvH]

n= MIDI channel number
vvH= Control value (00H~7FH)
00H~3FH: Off
40H~7FH: On

• Soft pedal

[BnH] [43H] [vvH]

n= MIDI channel number
vvH= Control value (00H~7FH)
8 levels max.

• Portamento control

[BnH] [54H] [vvH]

n= MIDI channel number
vvH= Control value (00H~7FH)
15H~6CH: Key Number

• Reverb depth

[BnH] [5BH] [vvH]

n= MIDI channel number
vvH= Reverb Depth (00H~7FH)
Individually adjustable for each channel.

• Chorus depth

[BnH] [5DH] [vvH]

n= MIDI channel number
vvH= Reverb Depth (00H~7FH)
Individually adjustable for each channel.

3. MODE MESSAGES (receive only)

[BnH] [ccH] [vvH]

BnH= Control event
(n= MIDI channel number)

ccH= Mode message number
vvH= Mode message value

• All sound off

[BnH] [78H] [00H]
n= MIDI channel number

• Reset all controllers

[BnH] [79H] [00H]
n= MIDI channel number

• Local Control ON/OFF

[BnH] [7AH] [vvH]
n= MIDI channel number
vvH= 00H: Off
7FH: On

• All notes OFF

[BnH] [7BH] [00H]
n= MIDI channel number

• OMNI OFF/All notes OFF

[BnH] [7CH] [00H]
n= MIDI channel number

• OMNI ON/All notes OFF

[BnH] [7DH] [00H]
n= MIDI channel number



4. REGISTERED/NON-REGISTERED PARAMETER NUMBER

- Data entry
[BnH] [06H] [mmH]
[BnH] [26H] [IIH]
n= MIDI channel number
mm/II=RPN
- Data inc
[BnH] [60H] [xxH]
n= MIDI channel number
xx= Dummy, RPN
- Data dec
[BnH] [61H] [xxH]
n= MIDI channel number
xx= Dummy, RPN
- Non-registered parameter number
[BnH] [62H] [IIH]
[BnH] [63H] [mmH]
n= MIDI channel number
* No parameter is received, but the data is recognized because of RPN reception.
- Registered parameter number
[BnH] [64H] [IIH]
[BnH] [65H] [mmH]
n= MIDI channel number
IIH= 00H, mmH= 00H: Pitch bend range
IIH= 01H, mmH= 00H: Fine tune
IIH= 02H, mmH= 00H: Coarse tune
IIH= 7FH, mmH= 7FH: RPN Reset

5. PROGRAM CHANGE

[CnH] [ppH]
CnH= Program change event
(n= MIDI channel number)
ppH= Program number

Panel Voices

- dd VOICE
- 00H PIANO
- 01H CLAVINOVA TONE
- 02H E. PIANO
- 03H HARPSICHORD
- 04H VIBES
- 05H GUITAR
- 06H STRINGS
- 07H ORGAN
- 08H CHOIR
- 09H UPRIGHT BASS
- 0AH ELEC BASS
- 0BH DRUMS

Voices 13 — 60

- dd VOICE
- 0CH BRASS
- 0DH POP BRASS
- 0EH TRUMPET
- 0FH MUTE TRUMPET
- 10H HORN
- 11H SAX

- 12H SAX SOFT
- 13H CLARINET
- 14H OBOE
- 15H FLUTE
- 16H ACCORDION
- 17H HARMONICA
- 18H STRINGS SOFT
- 19H VIOLIN
- 1AH VIOLIN HARD
- 1BH FULL ORGAN
- 1CH JAZZ ORGAN 1
- 1DH SYNTH BRASS
- 1EH SYNTH WOOD
- 1FH SYNTH STRINGS
- 20H SYNTH CHOIR
- 21H PIANO BRIGHT
- 22H PIANO SOFT
- 23H E. PIANO DX
- 24H SYNTH CRYSTAL
- 25H CELESTA
- 26H MARIMBA
- 27H FOLK GUITAR
- 28H JAZZ GUITAR 1
- 29H JAZZ GUITAR 2
- 2AH ROCK GUITAR 1
- 2BH ROCK GUITAR 2
- 2CH MUTE GUITAR
- 2DH BANJO
- 2EH PIZZICATO
- 2FH HARP
- 30H U. BASS SOFT
- 31H E. BASS SOFT
- 32H E. BASS HEAVY
- 33H SYNTH BASS
- 34H TIMPANI & ORCH. HIT
- 35H BASSOON
- 36H CHAMBER STRINGS
- 37H JAZZ ORGAN 2
- 38H ROCK GUITAR 3
- 39H COSMIC 1
- 3AH COSMIC 2
- 3BH COSMIC 3

6. PITCH BENDER

[EnH] [IIH] [mmH]
EnH= Bender event
(n= MIDI channel number)

IIH= Least significant byte
mmH= Most significant byte

* **Caution:** Each voice is set to its own bend range when the power is turned on. The bend range is set to 300 cents when the CVP/DOC Multi-Timbre mode is engaged, and to 200 cents when the GM Multi-Timbre mode is engaged. RPN data can be used to set the range in 100-cent (semitone) increments.

7. SYSTEM REALTIME MESSAGES

- [rrH]
- F8H: Timing clock
- FAH: Start
- FCH: Stop
- FEH: Active sensing

Data	Transmission	Reception
F8H	Transmitted every 96 clocks	Received as 96-clock tempo timing when MIDI clock is set to External
FAH	Rhythm start	Rhythm start
FCH	Rhythm stop	Rhythm stop
FEH	Transmitted every 200 milliseconds	All notes are turned off if no data is received for more than 400 milliseconds

* **Caution:** If an overrun framing error occurs the Damper, Sostenuto, and Soft effects for all channels are turned off and an All Note Off occurs.

8. SYSTEM EXCLUSIVE MESSAGES

- YAMAHA MIDI format
[F0H] [43H] [xnH] [ffH] [F7H]
43H= YAMAHA ID
xnH= Substatus + MIDI channel number
ffH= Format number
* n specifies the receive channel regardless of whether omni is on or off.
x ff Information
0 7CH Panel data receive
2 7CH Panel data bulk dump request
2 7DH Model ID data bulk dump request

Panel Data Send Format

F0H, 43H, 0xH, 7CH, 00H, 22H
(x: channel number,
data length= Panel data+0cH)
53H, 4BH, 20 H, 20H (SK)
43H, 56H, 50H, 27H, 39H, 34H (CVP'94)
3xH, 3yH (Version x, y)
[Panel Data]
[Check Sum (1byte)]= 0(53H+4BH+20H+...
...+Data end)

F7H

[Panel Data Contents]

- (1) ABC ON/OFF
- (2) SSP ON/OFF
- (3) SSP NO.
- (4) MANUAL VOICE
- (5) MANUAL VOLUME
- (6) RHYTHM NO.
- (7) RHYTHM VARIATION
- (8) TEMPO (Absolute value LSB)
- (9) TEMPO (Absolute value MSB)
- (10) RHYTHM VOLUME
- (11) CHORD 1 VOLUME
- (12) CHORD 2 VOLUME
- (13) BASS VOLUME



- (14) SPLIT POINT
- (15) DUAL/SPLIT MODE
- (16) DUAL/SPLIT VOICE
- (17) DUAL/SPLIT BALANCE
- (18) REVERB
- (19) REVERB DEPTH
- (20) LEFT PEDAL FUNCTION
- (21) Reserved
- (22) INTRO
- (23) TOUCH SENSITIVITY
- (24) PITCH BEND RANGE
- (25) CHORUS
- (26) SOUNDBOARD EFFECT DEPTH
- (27) DRUMS VOICE in the GM Multi-Timbre Mode

Individual Key Tuning Data Bulk Dump Format

F0H, 43H, 73H
 36H (Product ID: CVP-89)
 06H (Bulk ID)
 00H (Bulk No.)
 00H, 00H, 0bH, 00H (Data Length= wxyH 88*2 bytes)
 [BULK DATA] (low (A-1), high (A-1) ...low (C7), high (C7))
 [CHECK SUM (1byte)]= 0-sum (BULK DATA)

Name Data Send Format

F0H, 43H, 0xH, 7DH, 00H, 10H (Data Length= 10H byte)
 53H, 4BH, 20H, 20H (SK)
 43H, 56H, 50H, 27H, 39H, 34H (CVP'94)
 3xH, 3yH, 20H, 20H, 20H, 20H (Version x,y)
 [CHECK SUM (1byte)]= 0-(53H+4BH+20H+...+20H)
 F7H

• **Clavinova MIDI Format**

[F0H] [43H] [73H] [yyH] [xxH] [F7H]
 43H= YAMAHA ID
 73H= CLAVINOVA ID
 yyH= Product ID (CVP-89= 36H)
 xxH= Substatus
 xxH Information
 02H Internal MIDI clock
 03H External MIDI clock
 06H Receive bulk data below
 13H Multi-timbre mode off
 14H DOC voice multi-timbre mode on
 15H CVP Multi-timbre mode on
 18H DOC voice multi-timbre mode individual track reverb depth on
 61H MIDI FA Cancel On
 62H MIDI FA Cancel Off
 7nH All Note Off, Receive Channel = n+1, Omni off

* When nn = 2, 3, 13, 14, 15, 18, or 7C, Clavinova common ID (01H) is recognized as well as 34H.

* All Control Change values are reset when [13H], [14H] or [15H] is received. All voices and other parameters are also reset when [14H] or [15H] is received in order to ensure the same initial settings.

• **Special Messages**

[F0H] [43H] [73H] [yyH] [11H] [0nH] [ccH] [vvH] [F7H]
 43H= YAMAHA ID
 73H= CLAVINOVA ID
 yyH= Product ID (CVP-89= 36H)
 11H= Clavinova Special Control Code
 0nH= Control MIDI Change (n= special control change number)
 ccH= Control number
 ddH= Control value

cc	Control	Value [dd]
08H	DUAL/SPLIT Balance	00H= lower MAX 7FH= upper MAX
10H	ABC Mode	00H= Off 02H= ABC Single/Fingered 03H= Conventional Full-Keyboard ABC 04H= Full-Keyboard ABC
11H	Rhythm Variation	00H= Off 01H= Variation number
12H	Fill In Switch Event	00H= Fill to normal Off event 01H= Fill to normal On event 02H= Fill to variation On event 03H= Fill to variation Off event
13H	Intro/Ending Switch Event	00H= Intro mode Off 01H= Intro mode On 02H= Ending mode On 03H= Fill to normal mode On 04H= Fill to variation mode On
14H	Split	[ddH]= Split key number (the highest note in the left-hand keyboard range)
15H	Rhythm Number	[ddH]= Rhythm number
19H	Volume	[ddH]= Volume value n= 2 (BASS) 4 (CHORD 1) 5 (CHORD 2)
1AH	Rhythm Volume	[ddH]= Volume value
1BH	Metronome mode (receive only)	00H: Off 01H: On
21H	Solo Styleplay Number	00~17H= Style number
22H	Solo Styleplay	00H~3FH= Off 40H~7FH= On
30H	Drums Parameter Change	See Drum Parameter Expanded Format, below
3DH	Soundboard Effect Depth	[ddH]= Volume value
59H	Reverb	00H= Off 01H= Room 02H= Hall 1 03H= Hall 2

04H= Cosmic
 5AH Dual/Split mode 00H= Off
 01H= Dual
 02H= Split (upper damper)
 03H= Split (lower damper)
 04H= Split (upper/lower damper)
 05H= Split & Lower Voice Oct Up (upper damper)
 06H= Split & Lower Voice Oct Up (lower damper)
 07H= SPLIT & Lower Voice Oct Up (upper/lower damper)
 5CH Dual/Split Voice [ddH]= Dual/Split voice number
 5DH Pedal Function [ddH]= Function number
 * When cc = 59 (Reverb), SK common ID (01H) is recognized in addition to xxH.

Drum Parameter Expanded Format

[F0H] [43H] [73H] [xxH] [11H] [0nH] [30H] [xxH][F7H]
 xxH: Product ID (CVP-89= 36H)
 Common product ID also recognized (pattern editor transmits both).
 0x30: /* Drum Parameter /* *2 Expanded Format
 * This resets all parameters when a different drum kit is selected.
 Expands Special Message 30.

• **Effect Level**

[F0H] [43H] [73H] [xxH] [11H] [0nH] [30H] [43H] [knH] [enH] [sIH] [F7H]
 11H: Clavinova special control code
 0nH: MIDI Channel Number
 * Received only on channel 15 (0EH) in the CVP'94, affecting all tracks.
 Received only on channel 10 (09H) in the GM mode, affecting all tracks.
 30H: Drums Parameter Change
 43H: Effect Send Level
 knH: Key Number
 * Also included in the panel key code in the Clavinova DOC Voice mode (because conversion is not possible). Included in the GM key code in the GM mode.
 * When kn = 01 the en for all keys is set to the default.
 When kn = 02 the en for all keys is set to s1.
 enH: Effect Number
 en= 5B: Reverb Depth
 sIH: Send Level
 * This data applies a ± 40H offset to the CH depth parameter of each channel of



each instrument.

Example

[F0H] [43H] [73H] [xxH] [11H] [0eH]
 [30H] [43H] [knH] [enH] [slH] [F7H]
 [knH] [enH] [slH]
 [36H] [5bH] [10H]:
 F#0 Brush Roll reverb depth set to -30H.
 [36H] [5bH] [20H] [5dH] [60H]:
 F#0 Brush Roll reverb depth set to -20H
 [01H] [5bH] [xxH]:
 Reverb depth for all keys set to default (± 0).
 [02H] [5bH] [20H]:
 Reverb depth for all keys set to -20H.

• Pan Set Switching

[F0H] [43H] [73H] [xxH] [11H] [0nH]
 [30H] [47H] [knH] [pnH] [F7H]
 11H: Clavinova special control code
 0nH: MIDI Channel Number
 * Received only on channel 15 (0EH) in
 the CVP'94, affecting all tracks.
 Received only on channel 10 (09H) in
 the GM mode, affecting all tracks.
 30H: Drums Parameter Change
 47H: Panpot
 knH: Key Number
 * Also included in the panel key code in
 the Common Voice mode (because
 conversion is not possible). Included in
 the GM key code in the GM mode.
 * When kn = 01 pan is set to the value
 specified in pn.
 When kn = 02 the pan for all keys is set
 to the pin point specified in pn.
 pnH: Pan
 * When kn = 01 pan is set to the value
 specified in pn.
 pn= 00: Normal DOC Setting
 = 01: Narrow DOC left
 = 02: Narrow DOC center
 = 03: Narrow DOC right
 = 04: Normal GM Setting
 = 05: Narrow GM left
 = 06: Narrow GM center
 = 07: Narrow GM right
 * Normal pan value used when kn is other
 than 01.
 However, values 48...4F are also set to
 pin-point center.

• Drum Kit Assign

[F0H] [43H] [73H] [xxH] [11H] [0nH]
 [30H] [40H] [knH] [skH] [F7H]
 11H: Clavinova special control code
 0nH: MIDI Channel Number
 * Received only on channel 15 (0EH) in
 the CVP'94, affecting channel 15 (0EH)
 only.
 Received only on channel 10 (09H) in
 the GM mode, affecting channel 10
 (09H) only.
 30H: Drums Parameter Change
 40H: Instrument Assign
 knH: Key Number
 * Also included in the panel key code in
 the DOC Voice mode (because conver-
 sion is not possible). Included in the GM
 key code in the GM mode.
 skH: Source Kit Number

• Absolute Tempo

[F0H] [43H] [73H] [yyH] [11H] [1nH]
 [ccH] [ddH] [F7H]
 43H= YAMAHA ID
 73H= CLAVINOVA ID
 yyH= Product ID (CVP-89= 36H)
 11H= Clavinova special control code
 1nH= Control MIDI Change
 (Transmit: n = Control Change number)
 (Receive: any channel OK)
 cc= Absolute tempo low byte
 dd= Absolute tempo high byte
 Tempo= dd*128+ccH

• Beat, Tempo LED ON/OFF

[F0H] [43H] [73H] [yyH] [11H] [4FH]
 [ccH] [ddH] [F7H]
 43H= YAMAHA ID
 73H= CLAVINOVA ID
 yyH= Product ID
 (CVP-89= 36H, or common 01H)
 11H= Clavinova special control code
 4FH= Control MIDI Change
 ccH= 00H: Beat lamp on/off
 01H: Tempo lamp on/off
 ddH= 00H: On
 7FH: Off

9. OTHER SYSTEM EXCLUSIVE MESSAGES

• General MIDI Mode On

[F0H] [7EH] [7FH] [09H] [xxH] [F7H]
 7EH= Universal Non-Real Time
 7FH= ID of target device
 09H= Sub-ID #1 General MIDI Message
 xxH= Substatus
 xxH Information
 01H General MIDI On
 02H General MIDI Off

* All sound off and all parameters are reset
 to their default values when [01H] is re-
 ceived.

• Master Tuning

[F0H] [43H] [1nH] [27H] [30H] [00H]
 [00H] [mmH] [llH] [ccH] [F7H]
 43H= YAMAHA ID
 1nH= Ignored
 27H
 30H
 00H
 00H
 mmH= (mm<<4)+ll; 1step=1 cent
 llH= mm=08H, ll=00H; ± 0 cent
 ccH= Ignored

• Master Volume

7FH= Universal Real Time
 7FH= ID of target device
 04H
 01H
 llH= Ignored
 mmH= Volume data

• All MIDI data available for general use are
 given above.

Panel Voices (1—12)/Voices 13—60

Voice No.	MIDI Program No.	DOC mode MIDI Program No.	Name	Pitch Bend Range (Cent)	Chorus On/Off
1	00	12	Piano	100	OFF
2	01	68	Clavinova Tone	100	ON
3	02	50	E. Piano	100	OFF
4	03	14	Harpsichord	100	OFF
5	04	16	Vibes	100	OFF
6	05	24	Guitar	200	OFF
7	06	08	Strings	100	OFF
8	07	76	Organ	100	OFF
9	08	42	Choir	100	OFF
10	09	28	Upright Bass	200	OFF
11	10	30	Elec Bass	200	OFF
12	11	126	Drums	300	OFF
13	12	00	Brass	200	OFF
14	13	73	Pop Brass	200	OFF
15	14	01	Trumpet	200	OFF
16	15	40	Mute Trumpet	200	OFF
17	16	02	Horn	200	OFF
18	17	03	Sax	200	OFF
19	18	77	Sax Soft	200	OFF
20	19	04	Clarinet	200	OFF
21	20	05	Oboe	200	OFF
22	21	06	Flute	200	OFF
23	22	07	Accordion	100	OFF
24	23	41	Harmonica	100	OFF
25	24	74	Strings Soft	100	OFF
26	25	09	Violin	100	OFF
27	26	75	Violin Hard	100	OFF
28	27	10	Full Organ	100	OFF
29	28	11	Jazz Organ 1	100	ON
30	29	20	Synth Brass	200	ON
31	30	44	Synth Wood	200	ON
32	31	45	Synth Strings	100	ON
33	32	46	Synth Choir	100	ON
34	33	51	Piano Bright	100	OFF
35	34	48	Piano Soft	100	OFF
36	35	13	E. Piano DX	100	ON
37	36	22	Synth Crystal	200	ON
38	37	15	Celesta	100	OFF
39	38	17	Marimba	100	OFF
40	39	53	Folk Guitar	200	OFF
41	40	25	Jazz Guitar 1	200	OFF
42	41	72	Jazz Guitar 2	200	OFF
43	42	26	Rock Guitar 1	200	ON
44	43	69	Rock Guitar 2	200	OFF
45	44	70	Mute Guitar	200	ON
46	45	55	Banjo	200	OFF
47	46	56	Pizzicato	200	OFF
48	47	57	Harp	200	OFF
49	48	71	U. Bass Soft	200	OFF
50	49	29	E. Bass Soft	200	OFF
51	50	78	E. Bass Heavy	200	OFF
52	51	31	Synth Bass	200	OFF
53	52	23	Timpani & Orch. Hit	300	OFF
54	53	80	Bassoon	200	OFF
55	54	81	Chamber Strings	100	OFF
56	55	82	Jazz Organ 2	100	OFF
57	56	88	Rock Guitar 3	200	ON
58	57	89	Cosmic 1	200	ON
59	58	90	Cosmic 2	200	ON
60	59	91	Cosmic 3	200	OFF

* Available only in DOC mode MIDI reception

Flute 2: program number 79

Orch. Hit: program number 92



GM Mode

Voice No.	MIDI Program No.	Name
Piano		
1	00	Acoustic Grand Piano
2	01	Bright Acoustic Piano
3	02	Electric Grand Piano
4	03	Honky-tonk Piano
5	04	Electric Piano 1
6	05	Electric Piano 2
7	06	Harpsichord
8	07	Clavi
Chromatic Percussion		
9	08	Celesta
10	09	Glockenspiel
11	10	Music Box
12	11	Vibraphone
13	12	Marimba
14	13	Xylophone
15	14	Tubular Bells
16	15	Dulcimer
Organ		
17	16	Drawbar Organ
18	17	Percussive Organ
19	18	Rock Organ
20	19	Church Organ
21	20	Reed Organ
22	21	Accordion
23	22	Harmonica
24	23	Tango Accordion
Guitar		
25	24	Acoustic Guitar (nylon)
26	25	Acoustic Guitar (steel)
27	26	Electric Guitar (jazz)
28	27	Electric Guitar (clean)
29	28	Electric Guitar (muted)
30	29	Overdriven Guitar
31	30	Distortion Guitar
32	31	Guitar Harmonics
Bass		
33	32	Acoustic Bass
34	33	Electric Bass (finger)
35	34	Electric Bass (pick)
36	35	Fretless Bass
37	36	Slap Bass 1
38	37	Slap Bass 2
39	38	Synth Bass 1
40	39	Synth Bass 2
Strings		
41	40	Violin
42	41	Viola
43	42	Cello
44	43	Contrabass
45	44	Tremolo Strings
46	45	Pizzicato Strings
47	46	Orchestral Harp
48	47	Timpani

Voice No.	MIDI Program No.	Name
Ensemble		
49	48	Strings Ensemble 1
50	49	Strings Ensemble 2
51	50	Synth Strings 1
52	51	Synth Strings 2
53	52	Choir Aahs
54	53	Voice Oohs
55	54	Synth Voice
56	55	Orchestra Hit
Brass		
57	56	Trumpet
58	57	Trombone
59	58	Tuba
60	59	Muted Trumpet
61	60	French Horn
62	61	Brass Section
63	62	Synth Brass 1
64	63	Synth Brass 2
Reed		
65	64	Soprano Sax
66	65	Alto Sax
67	66	Tenor Sax
68	67	Baritone Sax
69	68	Oboe
70	69	English Horn
71	70	Bassoon
72	71	Clarinet
Pipe		
73	72	Piccolo
74	73	Flute
75	74	Recorder
76	75	Pan Flute
77	76	Blown Bottle
78	77	Shakuhachi
79	78	Whistle
80	79	Ocarina
Synth Lead		
81	80	Lead 1 (square)
82	81	Lead 2 (sawtooth)
83	82	Lead 3 (calliope)
84	83	Lead 4 (chiff)
85	84	Lead 5 (charang)
86	85	Lead 6 (voice)
87	86	Lead 7 (fifth)
88	87	Lead 8 (bass+Lead)

Voice No.	MIDI Program No.	Name
Synth Pad		
89	88	Pad 1 (new age)
90	89	Pad 2 (warm)
91	90	Pad 3 (polysynth)
92	91	Pad 4 (choir)
93	92	Pad 5 (bowed)
94	93	Pad 6 (metallic)
95	94	Pad 7 (halo)
96	95	Pad 8 (sweep)
Synth Effects		
97	96	FX 1 (rain)
98	97	FX 2 (soundtrack)
99	98	FX 3 (crystal)
100	99	FX 4 (atmosphere)
101	100	FX 5 (brightness)
102	101	FX 6 (goblins)2
103	102	FX 7 (echoes)
104	103	FX 8 (sci-fi)
Ethnic		
105	104	Sitar
106	105	Banjo
107	106	Shamisen
108	107	Koto
109	108	Kalimba
110	109	Bagpipe
111	110	Fiddle
112	111	Shanai
Percussive		
113	112	Tinkle Bell
114	113	Agogo
115	114	Steel Drums
116	115	Woodblock
117	116	Taiko Drum
118	117	Melodic Tom
119	118	Synth Drum
120	119	Reverse Cymbal
Sound Effects		
121	120	Guitar Fret Noise
122	121	Breath Noise
123	122	Seashore
124	123	Bird Tweet
125	124	Telephone Ring
126	125	Helicopter
127	126	Applause
128	127	Gunshot



Percussion Kit List/Verzeichnis der Schlagzeug- und Percussion-

Keyboard Percussion (Voice No. 12: Drums)

No.	Key	Normal Kit	Processed Kit
45	A1	Cymbal Mute	Cymbal Mute
46	A#1	—	Bell Tree
47	B1	—	Storm/Thunder
48	C2	—	Applause
49	C#2	—	Hand Cymbal
50	D2	—	Scratch
51	D#2	—	Space Hit
52	E2	—	Down Zap
53	F2	—	Up Zap
54	F#2	Brush Roll	Noise Roll
55	G2	—	Hi-Q
56	G#2	Hi-Hat Closed Heavy	Analog Hi-Hat
57	A2	—	Voice Huh
58	A#2	Crash Cymbal Light	Chinese Cymbal
59	B2	Bass Drum Light	Bass Drum Analog Deep
60	C3	Snare Drum+Rim Heavy	Snare Drum Low Rim Shot
61	C#3	Ride Cymbal Cup	Ride Cymbal Cup
62	D3	Snare Drum + Rim Light	Snare Drum High Rim Shot
63	D#3	—	Voice Ha!
64	E3	—	Voice Ao!
65	F3	Bass Drum Normal	Bass Drum Analog Tight
66	F#3	Rim Shot	Rim Shot
67	G3	Snare Drum Heavy	Processed Snare Drum Mix
68	G#3	Brush Shot	Noise Shot
69	A3	Snare Drum Light	Snare Drum Analog
70	A#3	Hi-Hat Pedal	Hi-Hat Pedal
71	B3	Snare Drum Echo	Snare Drum Techno
72	C4	Tom 4	Fix Pitch Electric Tom 4
73	C#4	Hi-Hat Closed Normal	Hi-Hat Closed
74	D4	Tom 3	Fix Pitch Electric Tom 3
75	D#4	Hi-Hat Open	Hi-Hat Open
76	E4	Tom 2	Fix Pitch Electric Tom 2
77	F4	Tom 1	Fix Pitch Electric Tom 1
78	F#4	Ride Cymbal Normal	Ride Cymbal
79	G4	Electric Tom 3	Sweep Electric Tom 3
80	G#4	Crash Cymbal Normal	Crash Cymbal
81	A4	Electric Tom 2	Sweep Electric Tom 2
82	A#4	—	Crash Cymbal Reverse
83	B4	Electric Tom 1	Sweep Electric Tom 1
84	C5	Conga Low	Synth Conga Low
85	C#5	Cabasa	Synth Cabasa
86	D5	Conga High	Synth Conga High
87	D#5	Metronome	Metronome
88	E5	Bongo High	Synth Bongo High
89	F5	Timbale Low	Timbale Low
90	F#5	Claves	Synth Claves
91	G5	Timbale High	Timbale High
92	G#5	Castanets	Castanets
93	A5	Cuica Low	Synth Cuica Low
94	A#5	Cowbell	Cowbell
95	B5	Cuica High	Synth Cuica High
96	C6	Hand Clap	Analog Hand Clap
97	C#6	Agogo Low	Synth Agogo Low
98	D6	—	Finger Snap
99	D#6	Agogo High	Synth Agogo High
100	E6	Bongo Low	Synth Bongo Low
101	F6	—	—
102	F#6	Tambourine	Synth Tambourine
103	G6	—	—
104	G#6	Triangle Closed	Triangle Closed
105	A6	—	—
106	A#6	Triangle Open	Triangle Open

- Cymbals can be muted by pressing the A1 key.
- Hi-Hat Open (D#4) is muted by Hi-Hat Closed Heavy (G#2), Hi-Hat Closed Normal (C#4) and Hi-Hat Pedal (A#3).
- Brush Roll (F#2) is muted by Brush Shot (G#3).
- Triangle Open (A#6) is muted by Triangle Closed (G#6).

- Beckenklänge können durch Drücken der Taste A1 gedämpft werden.
- HI-HAT OPEN (D#4) wird durch HI-HAT CLOSED HEAVY (G#2), HI-HAT CLOSED NORMAL (C#4) und HI-HAT PEDAL (A#3) gedämpft.
- BRUSH ROLL (F#2) wird durch BRUSH SHOT (G#3) gedämpft.
- TRIANGLE OPEN (A#6) wird durch TRIANGLE CLOSED (G#6) gedämpft.

- Les cymbales peuvent être assourdis en appuyant sur la touche A1.
- HI-HAT OPEN (D#4) est assourdi par HI-HAT CLOSED HEAVY (G#2), HI-HAT CLOSED NORMAL (C#4) et HI-HAT PEDAL (A#3).
- BRUSH ROLL (F#2) est assourdi par BRUSH SHOT (G#3).
- TRIANGLE OPEN (A#6) est assourdi par TRIANGLE CLOSED (G#6).

- Los platillos podrán silenciarse presionando la tecla A1.
- HI-HAT OPEN (D#4) se silencian con HI-HAT CLOSED HEAVY (G#2), HI-HAT CLOSED NORMAL (C#4) y HI-HAT PEDAL (A#3).
- BRUSH ROLL (F#2) se silencia con BRUSH SHOT (G#3).
- TRIANGLE OPEN (A#6) se silencia con TRIANGLE CLOSED (G#6).

DOC/GM Mode

No.	Key	DOC Kit	GM Kit 129: Standard Kit
21	A-1	Cymbal Mute	—
22	A#-1	—	—
23	B-1	—	—
24	C0	—	Square Click
25	C#0	—	Brush Tap
26	D0	—	Brush Swirl Lo
27	D#0	—	Brush Slap
28	E0	—	Brush Swirl Hi
29	F0	—	SD Roll
30	F#0	Brush Roll	Castanets
31	G0	—	SD Lo
32	G#0	HI-HAT Closed Heavey	Sticks
33	A0	—	BD Lo
34	A#0	Crash Cymbal Light	Open Rim Shot
35	B0	BD Light	BD Mid
36	C1	SD Rim Heavey	BD Hi
37	C#1	Ride Cymbal Cup	Closed Rim Shot
38	D1	SD Rim Light	SD Mid
39	D#1	—	Hand Clap
40	E1	—	SD Hi
41	F1	BD Normal	Floor Tom Lo
42	F#1	Rim Shot	Hi-Hat Closed
43	G1	SD Heavy	Floor Tom Hi
44	G#1	Brush Shot	Hi-Hat Pedal
45	A1	SD Light	Tom Lo
46	A#1	HI-HAT Pedal	Hi-Hat Open
47	B1	SD Echo	Tom Lo Mid
48	C2	Tom 4	Tom Hi Mid
49	C#2	HI-HAT Closed Normal	Crash Cymbal
50	D2	Tom 3	Tom Hi
51	D#2	HI-HAT Open	Ride Cymbal 1
52	E2	Tom 2	Chinese Cymbal
53	F2	Tom 1	Ride Cymbal Cup
54	F#2	Ride Cymbal Normal	Tambourine
55	G2	E. Tom 3	Splash Cymbal
56	G#2	Crash Cymbal Normal	Cowbell
57	A2	E. Tom 2	Crash Cymbal 2
58	A#2	—	Vibraslap
59	B2	E. Tom 1	Ride Cymbal 2
60	C3	Conga Lo	Bongo Hi
61	C#3	Cabasa	Bongo Lo
62	D3	Conga Hi	Conga Hi Mute
63	D#3	Metronome	Conga Hi Open
64	E3	Bongo Hi	Conga Lo
65	F3	Timbale Lo	Timbale Hi
66	F#3	Claves	Timbale Lo
67	G3	Timbale Hi	Agogo Hi
68	G#3	Castanets	Agogo Lo
69	A3	Cuica Lo	Cabasa
70	A#3	Cowbell	Maracas
71	B3	Cuica Hi	Samba Whistle Hi
72	C4	Hand Clap	Samba Whistle Lo
73	C#4	Agogo Lo	Guiro Short
74	D4	—	Guiro Long
75	D#4	Agogo Hi	Claves
76	E4	Bongo Lo	Wood Block Hi
77	F4	—	Wood Block Lo
78	F#4	Tambourine	Cuica Hi (Mute)
79	G4	—	Cuica Lo (Open)
80	G#4	Triangle Closed	Triangle Mute
81	A4	—	Triangle Open
82	A#4	Triangle Open	Shaker
83	B4	—	Jingle Bell
84	C5	—	Bell Tree
85	C#5	—	One
86	D5	—	Two
87	D#5	—	Three
88	E5	—	Four

Sets/Liste des kits de percussion/Lista de juegos de percusión

130: Room Kit	131: Rock Kit	132: Electronic Kit	133: Analog Kit	134: Jazz Kit	135: Brush Kit	136: Classic Kit
—	—	—	—	—	—	—
←	←	←	←	←	←	←
←	←	←	←	←	←	←
←	←	←	←	←	←	←
←	←	←	←	←	←	←
←	←	←	←	←	←	←
←	←	Reverse Cymbal	Reverse Cymbal	←	←	←
←	←	←	←	←	←	←
←	←	Hi-Q	Hi-Q	←	←	←
Room SD Lo	Rock SD Lo	Gated SD Lo	A. SD Lo	Jazz SD Lo	Brush Slap Lo	Marching SD Lo
←	←	←	←	←	←	←
Room BD Lo	Rock BD Lo	Gated BD Lo	A. BD Lo	Jazz BD Lo	Jazz BD Lo	Gran Cassa Lo
←	←	←	←	←	←	←
Room BD Mid	Rock BD Mid	Gated BD Mid	A. BD Mid	Jazz BD Mid	Jazz BD Mid	Gran Cassa Mid
Room BD Hi	Rock BD Hi	Gated BD Hi	A. BD Hi	Jazz BD Hi	Jazz BD Hi	Gran Cassa Hi
←	←	←	A. Closed Rim	←	←	←
Room SD Mid	Rock SD Mid	Gated SD Mid	A. SD Mid	Jazz SD Mid	Brush Slap Hi	Marching SD Mid
←	←	←	←	←	←	←
Room SD Hi	Rock SD Hi	Gated SD Hi	A. SD Hi	Jazz SD Hi	Brush Tap	Marching SD Hi
Room Tom 1 (Lo)	Rock Tom 1 (Lo)	E. Tom 1 (Lo)	A. Tom 1 (Lo)	Jazz Tom 1 (Lo)	Brush Tom 1 (Lo)	Jazz Tom 1 (Lo)
←	←	←	A. Hi-Hat Closed Hi	Dark Hi-Hat Closed Hi	Dark Hi-Hat Closed Hi	Dark Hi-Hat Closed Hi
Room Tom 2	Rock Tom 2	E. Tom 2	A. Tom 2	Jazz Tom 2	Brush Tom 2	Jazz Tom 2
←	←	←	A. Hi-Hat Closed Lo	Dark Hi-Hat Closed Lo	Dark Hi-Hat Closed Lo	Dark Hi-Hat Closed Lo
Room Tom 3	Rock Tom 3	E. Tom 3	A. Tom 3	Jazz Tom 3	Brush Tom 3	Jazz Tom 3
←	←	←	A. Hi-Hat Open	Dark Hi-Hat Open	Dark Hi-Hat Open	Dark Hi-Hat Open
Room Tom 4	Rock Tom 4	E. Tom 4	A. Tom 4	Jazz Tom 4	Brush Tom 4	Jazz Tom 4
Room Tom 5	Rock Tom 5	E. Tom 5	A. Tom 5	Jazz Tom 5	Brush Tom 5	Jazz Tom 5
←	←	←	A. Cymbal	←	Brush Ride Cymbal 1	Hand Cymbal Long Lo
Room Tom 6 (Hi)	Rock Tom 6 (Hi)	E. Tom 6 (Hi)	A. Tom 6 (Hi)	Jazz Tom 6 (Hi)	Brush Tom 6 (Hi)	Jazz Tom 6 (Hi)
←	←	←	←	←	Brush Ride Cymbal 2	Hand Cymbal Short Lo
←	←	←	←	←	←	←
←	←	←	←	←	←	←
←	←	←	←	←	←	←
←	←	←	A. Cowbell	←	←	←
←	←	←	←	←	←	Hand Cymbal Long Hi
←	←	←	←	←	←	←
←	←	←	←	←	←	Hand Cymbal Short Hi
←	←	←	←	←	←	←
←	←	←	←	←	←	←
←	←	←	←	←	←	←
←	←	←	←	←	←	←
←	←	←	←	←	←	←
←	←	←	←	←	←	←
←	←	←	←	←	←	←
←	←	←	A. Maracas	←	←	←
←	←	←	←	←	←	←
←	←	←	←	←	←	←
←	←	←	←	←	←	←
←	←	←	←	←	←	←
←	←	←	←	←	←	←
←	←	←	←	←	←	←
←	←	←	←	←	←	←
←	←	←	←	←	←	←
←	←	←	A. Claves	←	←	←
←	←	←	←	←	←	←
←	←	←	←	←	←	←
←	←	←	←	←	←	←
←	←	←	←	←	←	←
←	←	Scratch Hi	Scratch Hi	←	←	←
←	←	Scratch Lo	Scratch Lo	←	←	←
←	←	←	←	←	←	←
←	←	←	←	←	←	←
←	←	←	←	←	←	←
←	←	←	←	←	←	←
←	←	←	←	←	←	←
←	←	←	←	←	←	←
←	←	←	←	←	←	←
←	←	←	←	←	←	←
←	←	←	←	←	←	←
←	←	←	←	←	←	←
←	←	←	←	←	←	←
←	←	←	←	←	←	←
←	←	←	←	←	←	←
←	←	←	←	←	←	←

* "←" indicates the content is the same as that of Standard kit.
 * "←" zeigt an, daß der Inhalt identisch mit dem Standardset ist.
 * "←" indique que le contenu est le même que celui du kit standard.
 * "←" indica que el contenido es el mismo que el del juego estándar.



		CVP-89
KEYBOARD		88 KEYS (A-1 — C7)
tone generator		AWM (Advanced Wave Memory)
VOICE SELECTORS & CONTROLS		PIANO, CLAVINOVA TONE, E. PIANO, HARPSICHORD, VIBES, GUITAR, STRINGS, ORGAN, CHOIR, UPRIGHT BASS, ELEC BASS, DRUMS, VOICE 13 - 60, VOICE ▲/▼, SPLIT (GM 128 voices also available)
AUTO BASS CHORD & CONTROLS		FULL KEYBOARD, SINGLE/FINGERED, SOLO STYLEPLAY, RHYTHM VOLUME, CHORD 1 VOLUME, CHORD 2 VOLUME, BASS VOLUME
STYLE SELECTORS & CONTROLS		POP, 16 BEAT, DANCE POP, BOOGIE, SLOW ROCK, SWING, JAZZ BALLAD, BOSSA, RHUMBA, MARCH, COUNTRY, WALTZ, STYLE 13-50, STYLE ▲/▼, DISK STYLE 1/2 START/STOP, SYNCHRO START, INTRO/ENDING, NORMAL/FILL TO NORMAL, VARIATION/ FILL TO VARIATION, TEMPO ▲/▼, TAP, METRONOME, LCD Display, BEAT LED, FILL IN Bar (right/left)
DISK STYLE		50 styles (refer to page 26)
KEYBOARD PERCUSSION		Normal Kit: 44 instruments, Processed Kit: 58 instruments (refer to page 8, ix), GM Drum Kit x 8
REVERB		ROOM, HALL 1, HALL 2, COSMIC
CUSTOM RHYTHM		CUSTOM RHYTHM, PROGRAM
REGISTRATION		REGISTRATION, MEMORY
DISK ORCHESTRA		SONG/PHRASE NUMBER, RIGHT/1, LEFT/2, ORCH/3-10, RHYTHM, PHRASE REPEAT, GUIDE, LAMP CANCEL, START/STOP, REW, FF, PAUSE, REC, CHORD SEQUENCE, SONG SELECT
DISK DRIVE & CONTROLS		3.5" 2DD Micro Floppy Disk Drive.
PEDAL CONTROLS	RIGHT	DAMPER
	CENTER	SOSTENUTO
	LEFT	SOFT (START/STOP, RHYTHM BREAK, PITCH BEND, SOLO STYLEPLAY)
OTHER CONTROLS		MASTER VOLUME, UTILITY, DEMO, POWER
JACKS & CONNECTORS		PHONES x 2, AUX OUT R and L/L + R, AUX IN R and L, MIDI IN/OUT/THRU, EXP PEDAL, MIC., MIC. VOL.
INPUT & OUTPUT LEVEL/IMPEDANCE		AUX OUT: Output Impedance 600 Ω AUX IN: Input Impedance 10 kΩ /Input Sensitivity -10dBm
MAIN AMPLIFIERS		100 W (50W x 1) + (25W x 2)
SPEAKERS		18 cm (7") x 1, 13 cm (5-1/8") x 2, 2.5 cm (1") x 2, 8 cm (3-1/8") x 2
DIMENSIONS (W x D x H)	Music stand down	1434 mm x 665.6 mm x 844.8 mm (56-1/2" x 26-1/4" x 33-1/4")
	Music stand up	1434 mm x 665.6 mm x 1014.8 mm (56-1/2" x 26-1/4" x 40")
WEIGHT		83 kg (183 lbs.)

* Specifications subject to change without notice.

* Änderungen ohne Vorankündigung vorbehalten.

* Sous toute réserve de modification des caractéristiques sans préavis.

* Especificaciones sujetas a cambios sin previo aviso.



* All fingerings shown are simple root-position types.
 * Die hier gezeigten Akkorde sind jeweils die Grundakkorde.
 * Tous les doigtés indiqués sont du type à position fondamentale simple.
 * Todos los digitados se muestran como tipos de posición de raíz sencilla.

	Major Dur Majeur Mayor	Minor Moll Mineur Menor	Seventh Dur-Septakkord Septième Séptima	Minor seventh Moll-Septakkord Mineure septième Menor de séptima
C		Cm	C7	Cm7
D \flat (C \sharp)		D \flat m (C \sharp m)	D \flat 7 (C \sharp 7)	D \flat m7 (C \sharp m7)
D		Dm	D7	Dm7
E \flat (D \sharp)		E \flat m (D \sharp m)	E \flat 7 (D \sharp 7)	E \flat m7 (D \sharp m7)
E		Em	E7	Em7
F		Fm	F7	Fm7
F \sharp (G \flat)		F \sharp m (G \flat m)	F \sharp 7 (G \flat 7)	F \sharp m7 (G \flat m7)
G		Gm	G7	Gm7
A \flat (G \sharp)		A \flat m (G \sharp m)	A \flat 7 (G \sharp 7)	A \flat m7 (G \sharp m7)
A		Am	A7	Am7
B \flat (A \sharp)		B \flat m (A \sharp m)	B \flat 7 (A \sharp 7)	B \flat m7 (A \sharp m7)
B		Bm	B7	Bm7



Major seventh
Dur-Akkord mit großer
Septime
Majeure septième
Mayor de séptima

Minor major seventh
Moll-Akkord mit großer
Septime
Septième majeure sur
mineur
Menor de séptima mayor

Augmented
Übermäßig
Augmenté
Aumentado

Diminished
Vermindert
Diminué
Disminuida

















































CM ₇		CmM ₇		Caug		Cdim	
D ^b M ₇ (C [#] M ₇)		D ^b mM ₇ (C [#] mM ₇)		D ^b aug (C [#] aug)		D ^b dim (C [#] dim)	
DM ₇		DmM ₇		Daug		Ddim	
E ^b M ₇ (D [#] M ₇)		E ^b mM ₇ (D [#] mM ₇)		E ^b aug (D [#] aug)		E ^b dim (D [#] dim)	
EM ₇		EmM ₇		Eaug		Edim	
FM ₇		FmM ₇		Faug		Fdim	
F [#] M ₇ (G ^b M ₇)		F [#] mM ₇ (G ^b mM ₇)		F [#] aug (G ^b aug)		F [#] dim (G ^b dim)	
GM ₇		GmM ₇		Gaug		Gdim	
A ^b M ₇ (G [#] M ₇)		A ^b mM ₇ (G [#] mM ₇)		A ^b aug (G [#] aug)		A ^b dim (G [#] dim)	
AM ₇		AmM ₇		Aaug		Adim	
B ^b M ₇ (A [#] M ₇)		B ^b mM ₇ (A [#] mM ₇)		B ^b aug (A [#] aug)		B ^b dim (A [#] dim)	
BM ₇		BmM ₇		Baug		Bdim	

Sixth
Dur-Akkord mit
hinzugefügter Sexte
Sixte
Sexta

Suspended fourth
Vorgehaltene
Quarte
Quarte sur sensible
Cuarta suspendida

Minor seventh flatted fifth
Moll-Septakkord mit
verminderter Quinte
Quinte diminuée sur
mineure septième
Menor de séptima y quinta
bemol

Major seventh flatted fifth
Dur-Akkord mit großer
Septime und verminderter
Quinte
Quinte diminuée sur
majeure septième
Mayor de séptima y quinta
bemol

C6		Csus4		Cm7(♭5)		CM7(♭5)	
D♭6 (C♯6)		D♭sus4 (C♯sus4)		D♭m7(♭5) (C♯m7(♭5))		D♭M7(♭5) (C♯M7(♭5))	
D6		Dsus4		Dm7(♭5)		DM7(♭5)	
E♭6 (D♯6)		E♭sus4 (D♯sus4)		E♭m7(♭5) (D♯m7(♭5))		E♭M7(♭5) (D♯M7(♭5))	
E6		Esus4		Em7(♭5)		EM7(♭5)	
F6		Fsus4		Fm7(♭5)		FM7(♭5)	
F♯6 (G♭6)		F♯sus4 (G♭sus4)		F♯m7(♭5) (G♭m7(♭5))		F♯M7(♭5) (G♭M7(♭5))	
G6		Gsus4		Gm7(♭5)		GM7(♭5)	
A♭6 (G♯6)		A♭sus4 (G♯sus4)		A♭m7(♭5) (G♯m7(♭5))		A♭M7(♭5) (G♯M7(♭5))	
A6		Asus4		Am7(♭5)		AM7(♭5)	
B♭6 (A♯6)		B♭sus4 (A♯sus4)		B♭m7(♭5) (A♯m7(♭5))		B♭M7(♭5) (A♯M7(♭5))	
B6		Bsus4		Bm7(♭5)		BM7(♭5)	



Minor major seventh flatted fifth
Moll-Akkord mit großer Septime und verminderter Quinte
Septième majeure sur mineur quinte diminué
Menor mayor de séptima y quinta bemol

Minor sixth
Moll-Akkord mit hinzugefügter Sexte
Mineure sixte
Menor de sexta

Seventh suspended fourth
Dur-Septakkord mit vorgehaltener Quarte
Quarte sur septième sensible
Séptima y cuarta suspendida

Flatted fifth
Verminderter Quinte
Quinte diminuée
Quinta bemol

CmM7(♭5)		Cm6		C7sus4		C(♭5)	
D♭mM7(♭5) (C♯mM7(♭5))		D♭m6 (C♯m6)		D♭7sus4 (C♯7sus4)		D(♭5) (C♯(♭5))	
DmM7(♭5)		Dm6		D7sus4		D(♭5)	
E♭mM7(♭5) (D♯mM7(♭5))		E♭m6 (D♯m6)		E♭7sus4 (D♯7sus4)		E(♭5) (D♯(♭5))	
EmM7(♭5)		Em6		E7sus4		E(♭5)	
FmM7(♭5)		Fm6		F7sus4		F(♭5)	
F♯mM7(♭5) (G♭mM7(♭5))		F♯m6 (G♭m6)		F♯7sus4 (G♭7sus4)		F♯(♭5) (G♭(♭5))	
GmM7(♭5)		Gm6		G7sus4		G(♭5)	
A♭mM7(♭5) (G♯mM7(♭5))		A♭m6 (G♯m6)		A♭7sus4 (G♯7sus4)		A(♭5) (G♯(♭5))	
AmM7(♭5)		Am6		A7sus4		A(♭5)	
B♭mM7(♭5) (A♯mM7(♭5))		B♭m6 (A♯m6)		B♭7sus4 (A♯7sus4)		B(♭5) (A♯(♭5))	
BmM7(♭5)		Bm6		B7sus4		B(♭5)	



Minor flatted fifth
Moll-Akkord mit
verminderter Quinte
Mineure quinte diminuée
Menor de quinta bemol

Seventh flatted fifth
Dur-Septakkord mit
verminderter Quinte
Quinte diminuée en
septième
Séptima y quinta bemol

Seventh sharp fifth
Dur-Septakkord mit
erhöhter Quinte
Septième ajoutée sur
quinte
Séptima y quinta
sostenida

Major seventh sharp fifth
Dur-Akkord mit großer
Septime und erhöhter Quinte
Majeure septième ajoutée
sur quinte
Mayor de séptima y quinta
sostenida

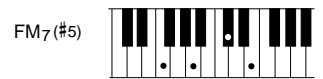
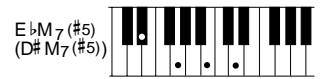
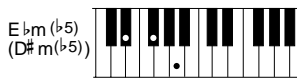
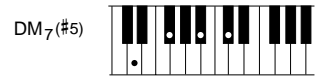
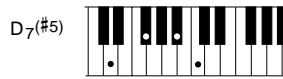
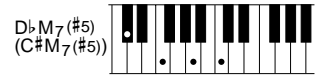
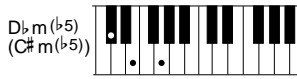
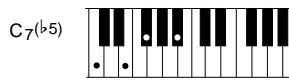
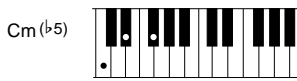

MIDI Implementation Chart

Not Available

FCC INFORMATION (U.S.A.)

1. IMPORTANT NOTICE: DO NOT MODIFY THIS UNIT!

This product, when installed as indicated in the instructions contained in this manual, meets FCC requirements. Modifications not expressly approved by Yamaha may void your authority, granted by the FCC, to use the product.

2. IMPORTANT: When connecting this product to accessories and/or another product use only high quality shielded cables. Cable/s supplied with this product MUST be used. Follow all installation instructions. Failure to follow instructions could void your FCC authorization to use this product in the USA.

3. NOTE: This product has been tested and found to comply with the requirements listed in FCC Regulations, Part 15 for Class "B" digital devices. Compliance with these requirements provides a reasonable level of assurance that your use of this product in a residential environment will not result in harmful interference with other electronic devices. This equipment generates/uses radio frequencies and, if not installed and used according to the instructions found in the users manual, may cause interference harmful to the operation of other

electronic devices. Compliance with FCC regulations does not guarantee that interference will not occur in all installations. If this product is found to be the source of interference, which can be determined by turning the unit "OFF" and "ON", please try to eliminate the problem by using one of the following measures:

Relocate either this product or the device that is being affected by the interference.

Utilize power outlets that are on different branch (circuit breaker or fuse) circuits or install AC line filter/s.

In the case of radio or TV interference, relocate/reorient the antenna. If the antenna lead-in is 300 ohm ribbon lead, change the lead-in to co-axial type cable.

If these corrective measures do not produce satisfactory results, please contact the local retailer authorized to distribute this type of product. If you can not locate the appropriate retailer, please contact Yamaha Corporation of America, Electronic Service Division, 6600 Orangethorpe Ave, Buena Park, CA90620

The above statements apply ONLY to those products distributed by Yamaha Corporation of America or its subsidiaries.

* This applies only to products distributed by YAMAHA CORPORATION OF AMERICA.

IMPORTANT NOTICE FOR THE UNITED KINGDOM

Connecting the Plug and Cord

IMPORTANT. The wires in this mains lead are coloured in accordance with the following code:

BLUE : NEUTRAL
BROWN : LIVE

As the colours of the wires in the mains lead of this apparatus may not correspond with the coloured markings identifying the terminals in your plug proceed as follows:

The wire which is coloured BLUE must be connected to the terminal which is marked with the letter N or coloured BLACK.

The wire which is coloured BROWN must be connected to the terminal which is marked with the letter L or coloured RED.

Making sure that neither core is connected to the earth terminal of the three pin plug.

• This applies only to products distributed by Yamaha-Kemble Music (U.K.) Ltd.

CANADA

THIS DIGITAL APPARATUS DOES NOT EXCEED THE "CLASS B" LIMITS FOR RADIO NOISE EMISSIONS FROM DIGITAL APPARATUS SET OUT IN THE RADIO INTERFERENCE REGULATION OF THE CANADIAN DEPARTMENT OF COMMUNICATIONS.

LE PRESENT APPAREIL NUMERIQUE N'EMET PAS DE BRUITS RADIOELECTRIQUES DEPASSANT LES LIMITES APPLICABLES AUX APPAREILS NUMERIQUES DE LA "CLASSE B" PRESCRITES DANS LE REGLEMENT SUR LE BROUILLAGE RADIOELECTRIQUE EDICTE PAR LE MINISTERE DES COMMUNICATIONS DU CANADA.

CAUTION: TO PREVENT ELECTRIC SHOCK, MATCH WIDE BLADE OF PLUG TO WIDE SLOT, FULLY INSERT.

ATTENTION: POUR ÉVITER LES CHOCs ÉLECTRIQUES, INTRODUIRE LA LAME LA PLUS LARGE DE LA FICHE DANS LA BORNE CORRESPONDANTE DE LA PRISE ET POUSSER JUSQU'AU FOND.

• This applies only to products distributed by Yamaha Canada Music Ltd.
• Ceci ne s'applique qu'aux produits distribués par Yamaha Canada Musique Ltée.

IMPORTANT SAFETY INSTRUCTIONS

INFORMATION RELATING TO PERSONAL INJURY, ELECTRICAL SHOCK, AND FIRE HAZARD POSSIBILITIES HAS BEEN INCLUDED IN THIS LIST.

WARNING- When using any electrical or electronic product, basic precautions should always be followed. These precautions include, but are not limited to, the following:

- 1.** Read all Safety Instructions, Installation Instructions, Special Message Section items, and any Assembly Instructions found in this manual **BEFORE** making any connections, including connection to the main supply.
- 2.** Main Power Supply Verification: Yamaha products are manufactured specifically for the supply voltage in the area where they are to be sold. If you should move, or if any doubt exists about the supply voltage in your area, please contact your dealer for supply voltage verification and (if applicable) instructions. The required supply voltage is printed on the name plate. For name plate location, please refer to the graphic found in the Special Message Section of this manual.
- 3.** This product may be equipped with a polarized plug (one blade wider than the other). If you are unable to insert the plug into the outlet, turn the plug over and try again. If the problem persists, contact an electrician to have the obsolete outlet replaced. Do **NOT** defeat the safety purpose of the plug.
- 4.** Some electronic products utilize external power supplies or adapters. Do **NOT** connect this type of product to any power supply or adapter other than one described in the owners manual, on the name plate, or specifically recommended by Yamaha.
- 5.** **WARNING:** Do not place this product or any other objects on the power cord or place it in a position where anyone could walk on, trip over, or roll anything over power or connecting cords of any kind. The use of an extension cord is not recommended! If you must use an extension cord, the minimum wire size for a 25' cord (or less) is 18 AWG. **NOTE:** The smaller the AWG number, the larger the current handling capacity. For longer extension cords, consult a local electrician.
- 6.** Ventilation: Electronic products, unless specifically designed for enclosed installations, should be placed in locations that do not interfere with proper ventilation. If instructions for enclosed installations are not provided, it must be assumed that unobstructed ventilation is required.
- 7.** Temperature considerations: Electronic products should be installed in locations that do not significantly contribute to their operating temperature. Placement of this product close to heat sources such as; radiators, heat registers and other devices that produce heat should be avoided.
- 8.** This product was **NOT** designed for use in wet/damp locations and should not be used near water or exposed to rain. Examples of wet/damp locations are; near a swimming pool, spa, tub, sink, or wet basement.
- 9.** This product should be used only with the components supplied or; a cart, rack, or stand that is recommended by the manufacturer. If a cart, rack, or stand is used, please observe all safety markings and instructions that accompany the accessory product.
- 10.** The power supply cord (plug) should be disconnected from the outlet when electronic products are to be left unused for extended periods of time. Cords should also be disconnected when there is a high probability of lightening and/or electrical storm activity.
- 11.** Care should be taken that objects do not fall and liquids are not spilled into the enclosure through any openings that may exist.
- 12.** Electrical/electronic products should be serviced by a qualified service person when:
 - a. The power supply cord has been damaged; or
 - b. Objects have fallen, been inserted, or liquids have been spilled into the enclosure through openings; or
 - c. The product has been exposed to rain; or
 - d. The product does not operate, exhibits a marked change in performance; or
 - e. The product has been dropped, or the enclosure of the product has been damaged.
- 13.** Do not attempt to service this product beyond that described in the user-maintenance instructions. All other servicing should be referred to qualified service personnel.
- 14.** This product, either alone or in combination with an amplifier and headphones or speaker/s, may be capable of producing sound levels that could cause permanent hearing loss. **DO NOT** operate for a long period of time at a high volume level or at a level that is uncomfortable. If you experience any hearing loss or ringing in the ears, you should consult an audiologist. **IMPORTANT:** The louder the sound, the shorter the time period before damage occurs.
- 15.** Some Yamaha products may have benches and/or accessory mounting fixtures that are either supplied as a part of the product or as optional accessories. Some of these items are designed to be dealer assembled or installed. Please make sure that benches are stable and any optional fixtures (where applicable) are well secured **BEFORE** using. Benches supplied by Yamaha are designed for seating only. No other uses are recommended.

PLEASE KEEP THIS MANUAL

