

*Clavinova*<sup>®</sup>  
**CVP-209/207**  
**OWNER'S MANUAL**

# SPECIAL MESSAGE SECTION

**PRODUCT SAFETY MARKINGS:** Yamaha electronic products may have either labels similar to the graphics shown below or molded/stamped facsimiles of these graphics on the enclosure. The explanation of these graphics appears on this page. Please observe all cautions indicated on this page and those indicated in the safety instruction section.

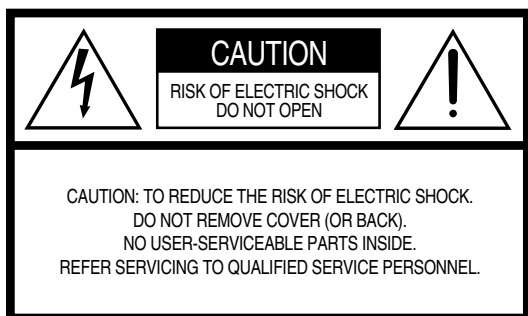

See bottom of Keyboard enclosure for graphic symbol markings.



The exclamation point within the equilateral triangle is intended to alert the user to the presence of important operating and maintenance (servicing) instructions in the literature accompanying the product.

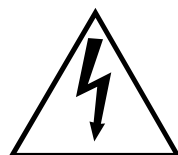

The lightning flash with arrowhead symbol, within the equilateral triangle, is intended to alert the user to the presence of uninsulated “dangerous voltage” within the product’s enclosure that may be of sufficient magnitude to constitute a risk of electrical shock.

**IMPORTANT NOTICE:** All Yamaha electronic products are tested and approved by an independent safety testing laboratory in order that you may be sure that when it is properly installed and used in its normal and customary manner, all foreseeable risks have been eliminated. DO NOT modify this unit or commission others to do so unless specifically authorized by Yamaha. Product performance and/or safety standards may be diminished. Claims filed under the expressed warranty may be denied if the unit is/has been modified. Implied warranties may also be affected.

**SPECIFICATIONS SUBJECT TO CHANGE:** The information contained in this manual is believed to be correct at the time of printing. However, Yamaha reserves the right to change or modify any of the specifications without notice or obligation to update existing units.

**ENVIRONMENTAL ISSUES:** Yamaha strives to produce products that are both user safe and environmentally friendly. We sincerely believe that our products and the production methods used to produce them, meet these goals. In keeping with both the letter and the spirit of the law, we want you to be aware of the following:

**Battery Notice:** This product MAY contain a small non-rechargeable battery which (if applicable) is soldered in place. The average life span of this type of battery is approximately five years. When replacement becomes necessary, contact a qualified service representative to perform the replacement.

**Warning:** Do not attempt to recharge, disassemble, or incinerate this type of battery. Keep all batteries away from children. Dispose of used batteries promptly and as regulated by applicable laws. Note: In some areas, the servicer is required by law to return the defective parts. However, you do have the option of having the servicer dispose of these parts for you.

**Disposal Notice:** Should this product become damaged beyond repair, or for some reason its useful life is considered to be at an end, please observe all local, state, and federal regulations that relate to the disposal of products that contain lead, batteries, plastics, etc.

**NOTICE:** Service charges incurred due to lack of knowledge relating to how a function or effect works (when the unit is operating as designed) are not covered by the manufacturer’s warranty, and are therefore the owners responsibility. Please study this manual carefully and consult your dealer before requesting service.

**NAME PLATE LOCATION:** The graphic below indicates the location of the name plate. The model number, serial number, power requirements, etc., are located on this plate. You should record the model number, serial number, and the date of purchase in the spaces provided below and retain this manual as a permanent record of your purchase.

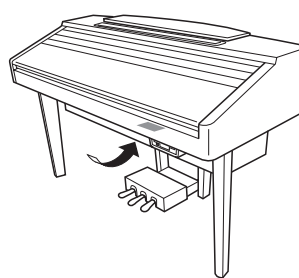

CVP-209

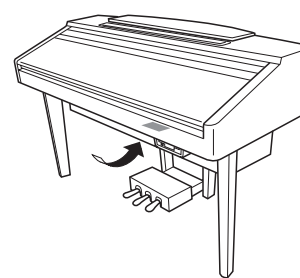

CVP-207

Model \_\_\_\_\_

Serial No. \_\_\_\_\_

Purchase Date \_\_\_\_\_

# PRECAUTIONS

## PLEASE READ CAREFULLY BEFORE PROCEEDING

\* Please keep this manual in a safe place for future reference.



## WARNING

Always follow the basic precautions listed below to avoid the possibility of serious injury or even death from electrical shock, short-circuiting, damages, fire or other hazards. These precautions include, but are not limited to, the following:

### Power supply/Power cord

- Only use the voltage specified as correct for the instrument. The required voltage is printed on the name plate of the instrument.
- Check the electric plug periodically and remove any dirt or dust which may have accumulated on it.
- Use only the supplied power cord/plug.
- Do not place the power cord near heat sources such as heaters or radiators, and do not excessively bend or otherwise damage the cord, place heavy objects on it, or place it in a position where anyone could walk on, trip over, or roll anything over it.

### Do not open

- Do not open the instrument or attempt to disassemble the internal parts or modify them in any way. The instrument contains no user-serviceable parts. If it should appear to be malfunctioning, discontinue use immediately and have it inspected by qualified Yamaha service personnel.

### Water warning

- Do not expose the instrument to rain, use it near water or in damp or wet conditions, or place containers on it containing liquids which might spill into any openings.
- Never insert or remove an electric plug with wet hands.

### Fire warning

- Do not put burning items, such as candles, on the unit. A burning item may fall over and cause a fire.

### If you notice any abnormality

- If the power cord or plug becomes frayed or damaged, or if there is a sudden loss of sound during use of the instrument, or if any unusual smells or smoke should appear to be caused by it, immediately turn off the power switch, disconnect the electric plug from the outlet, and have the instrument inspected by qualified Yamaha service personnel.



## CAUTION

Always follow the basic precautions listed below to avoid the possibility of physical injury to you or others, or damage to the instrument or other property. These precautions include, but are not limited to, the following:

### Power supply/Power cord

- When removing the electric plug from the instrument or an outlet, always hold the plug itself and not the cord. Pulling by the cord can damage it.
- Remove the electric plug from the outlet when the instrument is not to be used for extended periods of time, or during electrical storms.
- Do not connect the instrument to an electrical outlet using a multiple-connector.  
Doing so can result in lower sound quality, or possibly cause overheating in the outlet.

### Assembly

- Read carefully the attached documentation explaining the assembly process.  
Failure to assemble the instrument in the proper sequence might result in damage to the instrument or even injury.

### Location

- Do not expose the instrument to excessive dust or vibrations, or extreme cold or heat (such as in direct sunlight, near a heater, or in a car during the day) to prevent the possibility of panel disfiguration or damage to the internal components.
- Do not use the instrument in the vicinity of a TV, radio, stereo equipment, mobile phone, or other electric devices. Otherwise, the instrument, TV, or radio may generate noise.
- Do not place the instrument in an unstable position where it might accidentally fall over.
- Before moving the instrument, remove all connected cables. Also check that all screws are tight and have not been loosened by moving the instrument.
- Do not place the instrument against a wall (allow at least 3 cm/ one-inch from the wall), since this can cause inadequate air circulation, and possibly result in the instrument overheating.

## Connections

- Before connecting the instrument to other electronic components, turn off the power for all components. Before turning the power on or off for all components, set all volume levels to minimum. Also, be sure to set the volumes of all components at their minimum levels and gradually raise the volume controls while playing the instrument to set the desired listening level.

## Maintenance

- On the CVP-209, gently remove dust and dirt with a soft cloth. Do not wipe too hard since small particles of dirt can scratch the instrument's finish.
- When cleaning the instrument, use a soft, dry or slightly damp cloth. Do not use paint thinners, solvents, cleaning fluids, or chemical-impregnated wiping cloths.

## Handling caution

- Take care that the key cover does not pinch your fingers, and do not insert a finger or hand in any gaps on the key cover or instrument.
- Never insert or drop paper, metallic, or other objects into the gaps on the key cover, panel or keyboard. If this happens, turn off the power immediately and unplug the power cord from the AC outlet. Then have the instrument inspected by qualified Yamaha service personnel.
- Do not place vinyl, plastic or rubber objects on the instrument, since this might discolor the panel or keyboard.
- On the CVP-209, bumping the surface of the instrument with metal, porcelain, or other hard objects can cause the finish to crack or peel. Use caution.
- Do not rest your weight on, or place heavy objects on the instrument, and do not use excessive force on the buttons, switches or connectors.
- Do not operate the instrument for a long period of time at a high or uncomfortable volume level, since this can cause permanent hearing loss. If you experience any hearing loss or ringing in the ears, consult a physician.

## Using the bench (If included)

- Do not place the bench in an unstable position where it might accidentally fall over.
- Do not play carelessly with or stand on the bench. Using it as a tool or step-ladder or for any other purpose might result in accident or injury.
- Only one person should sit on the bench at a time, in order to prevent the possibility of accident or injury.
- On the CVP-209 bench, do not attempt to adjust the bench height while sitting on the bench, since this can cause excessive force to be imposed on the adjustment mechanism, possibly resulting in damage to the mechanism or even injury.
- If the bench screws become loose due to extensive long-term use, tighten them periodically using the included tool.

## Saving data

### Saving and backing up your data

- Current memory data (see page 40) is lost when you turn off the power to the instrument. Save the data to a floppy disk/the User Drive (see page 40). Saved data may be lost due to malfunction or incorrect operation. Save important data to a floppy disk.

When you change settings in a display page and then exit from that page, System Setup data (listed in the Parameter Chart of the separate Data List booklet) is automatically stored. However, this edited data is lost if you turn off the power without properly exiting from the relevant display.

### Backing up the floppy disk

- To protect against data loss through media damage, we recommend that you save your important data onto two floppy disks.

Yamaha cannot be held responsible for damage caused by improper use or modifications to the instrument, or data that is lost or destroyed.

Always turn the power off when the instrument is not in use.

# Clavinova<sup>®</sup>



Thank you for purchasing the Yamaha Clavinova!  
We recommend that you read this manual carefully  
so that you can fully take advantage of the advanced  
and convenient functions of the Clavinova.  
We also recommend that you keep this manual  
in a safe and handy place for future reference.

## ***About this Owner's Manual and Data List***

This manual consists of four main sections: Introduction, Quick Guide, Basic Operation, and Reference. Also, a separate Data List is provided.

**Introduction (page 2):** Please read this section first.

**Quick Guide (page 20):** This section explains how to use the basic functions.

**Basic Operation (page 39):** This section explains how to use the basic operations including display-based controls.

**Reference (page 53):** This section explains how to make detailed settings for the Clavinova's various functions.

**Data List :** Voice List, MIDI Data Format, etc.

- \* The models CVP-209/207 will be referred to as the CVP/Clavinova in this Owner's Manual.
- \* The illustrations and LCD screens as shown in this owner's manual are for instructional purposes only, and may appear somewhat different from those on your instrument.
- \* The example Operation Guide displays shown in this Manual are taken from the CVP-209, and in English.
- \* Copying of the commercially available software is strictly prohibited except for your personal use.

This product incorporates and bundles computer programs and contents in which Yamaha owns copyrights or with respect to which it has license to use others' copyrights. Such copyrighted materials include, without limitation, all computer software, styles files, MIDI files, WAVE data and sound recordings. Any unauthorized use of such programs and contents outside of personal use is not permitted under relevant laws. Any violation of copyright has legal consequences. **DON'T MAKE, DISTRIBUTE OR USE ILLEGAL COPIES.**

Trademarks:

- Apple and Macintosh are trademarks of Apple Computer, Inc.
- IBM-PC/AT is a trademark of International Business Machines Corporation.
- Windows is the registered trademark of Microsoft® Corporation.
- All other trademarks are the property of their respective holders.
  
- \* The photos of the harpsichord, bandoneon, hackbrett, music box, dulcimer and cimbalom, shown in the displays of the CVP-209/207, are courtesy of the Gakkigaku Shiriyokan (Collection for Organology), Kunitachi College of Music.
- \* The following instruments, shown in the displays of the CVP-209/207, are on display at the Hamamatsu Museum of Musical Instruments: balafon, gender, kalimba, kanoon, santur, gamelan gong, harp, hand bell, bagpipe, banjo, carillon, mandolin, oud, pan flute, pungi, rabab, shanai, sitar, steel drum, tambra.
- \* This product is manufactured under license of U.S. Patents No.5231671, No.5301259, No.5428708, and No.5567901 from IVL Technologies Ltd.
- \* The bitmap fonts used in this instrument have been provided by and are the property of Ricoh Co., Ltd.

# Accessories

## ■ "50 greats for the Piano" Disk (and Music Book)

### ■ Recording disk

Use this blank disk to save your performance.

### ■ Owner's Manual

This manual contains complete instructions for operating your Clavinova.

### ■ Data List

This manual contains lists of voices, styles and parameters, etc.

### ■ Bench

A bench may be included or optional, depending on your locale.

## Handling the Floppy Disk Drive (FDD) and Floppy Disk

### Precautions

Be sure to handle floppy disks and treat the disk drive with care. Follow the important precautions below.

### Compatible Disk Type

- 3.5" 2DD and 2HD type floppy disks can be used.

### Inserting/Ejecting Floppy Disks

#### To insert a floppy disk into the disk drive:

- Hold the disk so that the label of the disk is facing upward and the sliding shutter is facing forward, towards the disk slot. Carefully insert the disk into the slot, slowly pushing it all the way in until it clicks into place and the eject button pops out.

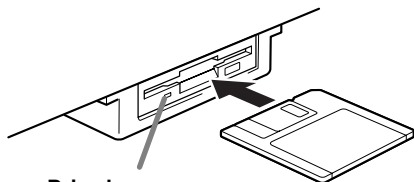

#### Drive lamp

When the power is turned on, the drive lamp (at the bottom left of the drive) lights to indicate the drive can be used.

#### To eject a floppy disk:

Before ejecting the disk, be sure to confirm that data is not being written to the floppy disk.

If data is currently being written to the floppy disk in the following operations, the messages "Now executing," "Now copying," and "Now formatting" appears in the display.

- Moving, copying, pasting, saving, or deleting data (page 43 - 45).
- Naming files and folders (page 42); creating a new folder (page 45).
- Copying a disk to an another disk (page 150); formatting the disk (page 150).

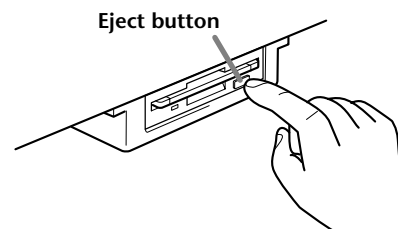

- Never attempt to remove the disk or turn the power off when the data is being written to the floppy disk. Doing so can damage the disk and possibly the disk drive. Press the eject button slowly as far as it will go; the disk will automatically pop out. When the disk is fully ejected, carefully remove it by hand.
- If the eject button is pressed too quickly, or if it is not pressed in as far as it will go, the disk may not eject properly. The eject button may become stuck in a half-pressed position with the disk extending from the drive slot by only a few millimeters. If this happens, do not attempt to pull out the partially ejected disk, since using force in this situation can damage the disk drive mechanism or the floppy disk. To remove a partially ejected disk, try pressing the eject button once again, or push the disk back into the slot and then repeat the eject procedure.
- Be sure to remove the floppy disk from the disk drive before turning off the power. A floppy disk left in the drive for extended periods can easily pick up dust and dirt that can cause data read and write errors.

- Never use a floppy disk with a deformed shutter or housing.
- Do not attach anything other than the provided labels to a floppy disk. Also make sure that labels are attached in the proper location.

#### To protect your data (Write-protect Tab):

- To prevent accidental erasure of important data, slide the disk's write-protect tab to the "protect" position (tab open).

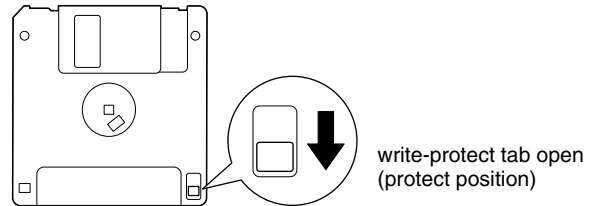

### Cleaning the Disk Drive Read/Write Head

- Clean the read/write head regularly. This instrument employs a precision magnetic read/write head which, after an extended period of use, will pick up a layer of magnetic particles from the disks used that will eventually cause read and write errors.
- To maintain the disk drive in optimum working order Yamaha recommends that you use a commercially-available dry-type head cleaning disk to clean the head about once a month. Ask your Yamaha dealer about the availability of proper head-cleaning disks.
- Never insert anything but floppy disks into the disk drive. Other objects may cause damage to the disk drive or floppy disks.

#### Data backup

- For maximum data security Yamaha recommends that you keep two copies of important data on separate floppy disks. This gives you a backup if one disk is lost or damaged. To make a backup disk use the Disk to Disk function on page 150.

### About the Floppy Disks

#### To handle floppy disks with care:

- Do not place heavy objects on a disk or bend or apply pressure to the disk in any way. Always keep floppy disks in their protective cases when they are not in use.
- Do not expose the disk to direct sunlight, extremely high or low temperatures, or excessive humidity, dust or liquids.
- Do not open the sliding shutter and touch the exposed surface of the floppy disk inside.
- Do not expose the disk to magnetic fields, such as those produced by televisions, speakers, motors, etc., since magnetic fields can partially or completely erase data on the disk, rendering it unreadable.

# About the Display Messages

A message (information or confirmation dialog) sometimes appears on the screen to facilitate operation.

When such messages appear, simply follow the instructions as shown by pressing the corresponding button.

## NOTE

You can select the desired language from the Help display (page 50).

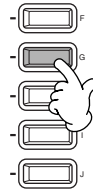

For this example, press the **[G] (YES)** button to execute formatting.

“The Clavinova-Computer Connection” is a supplementary guidebook that describes, for beginners, what you can do with your Clavinova and a personal computer and how to set up a Clavinova-Computer system (the manual is not written for any specific models). The document is available as a PDF file (in English) at the following Internet address:

Clavinova Home Page..... <http://www.yamahaclavinova.com/>

Yamaha Manual Library

(Electronic Musical Instruments) ..... <http://www2.yamaha.co.jp/manual/english/>

## Maintenance

Clean the instrument using a dry, soft cloth or slightly damp, soft cloth (wring well).



### CAUTION

Do not use benzine, thinner, detergent, or chemical cloth for cleaning. Do not place vinyl, plastic, or rubber products on the instrument.

Otherwise, the panel or keys may be discolored or degraded.



### CAUTION

Before using the Clavinova, be sure to read “Precautions” on pages 3 - 4.

### ■ Tuning

Unlike an acoustic piano, the Clavinova does not need to be tuned. It always stays perfectly in tune.

### ■ Transporting

If you move to another location, you can transport the Clavinova along with other belongings. You can move the unit as it is (assembled) or you can disassemble the unit down to the condition it was in when you first took it out of the box.

Transport the keyboard horizontally. Do not lean it up against a wall or stand it up on its side.

Do not subject the instrument to excessive vibration or shock.

When transporting the assembled Clavinova, make sure all screws are properly tightened and have not been loosened by moving the instrument.



# Table of Contents

## Introduction

SPECIAL MESSAGE SECTION .....	2
PRECAUTIONS .....	3
About this Owner's Manual and Data List .....	5
Accessories .....	6
Handling the Floppy Disk Drive (FDD) and Floppy Disk.....	6
About the Display Messages.....	8
Maintenance .....	8
Application Index.....	12
What can you do with the Clavinova?.....	14
Setting Up the Clavinova.....	16
Panel Controls and Terminals.....	18

## Quick Guide ..... 20

Playing the Demos.....	20
Song Playback.....	21
Playback of Songs.....	21
Playing Voices .....	25
Playing a Voice .....	25
Playing Two Voices Simultaneously.....	26
Playing Different Voices with the Left and Right Hands .....	27
Playing Styles .....	28
Playing a style.....	28
Style Sections.....	30
One Touch Setting.....	32
Music Finder.....	33
Using the Music Finder .....	33
Searching the Music Finder Records.....	34
Playing and Practicing with the Songs.....	36
Playing Along with the Clavinova.....	36
Recording .....	37
Mastering Your Favorite Songs.....	38

## Basic Operations

### — Organizing Your Data ..... 39

Selecting Files and Folders.....	41
File/Folder-related Operations .....	42
Naming Files/Folders .....	42
Moving Files/Folders.....	43
Copying Files/Folders.....	44
Deleting Files/Folders.....	44
Saving Files.....	45
Organizing Files by Creating a New Folder .....	45
Displaying Upper Level pages .....	45
Entering Characters and Changing Icons .....	45
Using the [DATA ENTRY] Dial.....	47
Direct Access — Instant Selection of Displays.....	48
Help Messages .....	50
Using the Metronome.....	51
Adjusting the Tempo .....	51
Tap Tempo.....	52

## Reference

### Playing the Demos.....53

### Voices.....55

Selecting a Voice .....	55
One-touch Piano Play.....	56
Layer/Left — Playing Several Sounds	
Simultaneously .....	57
Layer — Layering Two Different Voices .....	57
Left — Setting Separate Voices for the Left and Right Sections of the Keyboard .....	58
Applying Voice Effects .....	58
Using the Pedals.....	59

### Styles.....60

Playing a style .....	60
Adjusting the Volume Balance/Channel Muting .....	62
Chord Fingerings.....	63
Arranging the Style Pattern (SECTIONS:	
MAIN A/B/C/D, INTRO, ENDING, BREAK) .....	65
Stopping the Style Playback While Releasing Keys (SYNC. STOP).....	66
Selecting Intro and Ending Types (INTRO/ENDING) .....	67
Playing Fill-in patterns automatically when changing accompaniment sections — Auto Fill In.....	67
Appropriate Panel Setting for the Selected Style (ONE TOUCH SETTING).....	68
Automatically Changing One Touch Settings with the Sections — OTS Link .....	69
Registering the Panel Controls in One Touch Setting (ONE TOUCH SETTING).....	69
Calling Up Ideal Setups for Your Music	
— Music Finder.....	70
Searching the Ideal Setups — Music Finder Search....	71
Editing Records — Music Finder Record Edit .....	72

### Song Playback.....74

Compatible Song Types.....	74
Song Playback .....	75
Playing the Internal Songs.....	75
Playing Back Songs on Disk.....	77
Other Playback-related Operations.....	77
Muting Specific Parts	
— Track1/Track2/Extra Tracks.....	78
Repeat Playback of a Specific Range .....	78
Using the Practice Functions —Guide .....	79
Practice Functions .....	79
Practicing Music with the Guide Functions.....	80
Displaying Music Notation — Score .....	81
Displaying the Lyrics .....	84

## **Saving and Recalling Custom Panel Setups**

### **— Registration Memory ..... 85**

Registering Panel Setups	
— Registration Memory.....	85
Saving Your Registration Memory Setups.....	86
Recalling a Registration Memory Setup.....	87

## **Editing Voices**

### **— Sound Creator ..... 88**

Operation.....	88
SOUND CREATOR Parameters	
(Natural/Regular Voices).....	89
Organ Flutes.....	93
Operation.....	93

## **Recording Your Performances and Creating Songs**

### **— Song Creator ..... 94**

About Song Recording.....	94
Quick Recording.....	95
Multi Recording.....	96
Recording Individual Notes — Step Record.....	98
Operation.....	98
Recording Melodies — Step Record (Note).....	100
Recording Chord Changes for the Auto	
Accompaniment — Step Record (Chord).....	101
Select the Recording Options: Starting,	
Stopping, Punching In/Out — Rec Mode.....	103
Editing a Recorded Song.....	104
Editing Channel-related Parameters — Channel.....	104
Editing Note Events — 1 - 16.....	107
Editing Chord Events — CHD.....	108
Editing System Events — SYS/EX.	
(System Exclusive).....	108
Inputting and Editing Lyrics.....	109
Customizing the Event List — Filter.....	109

## **Creating Accompaniment Styles**

### **— Style Creator ..... 110**

About Creating Accompaniment Styles.....	110
Style File Format.....	111
Operation.....	111
Realtime Recording — Basic.....	112
Step Recording.....	113
Assembling an Accompaniment Style	
—Assemble.....	114
Edit the Created Accompaniment Style.....	115
Change the Rhythmic Feel	
— Groove and Dynamics.....	115
Editing the Channel Data.....	117
Making Style File Format Settings —Parameter.....	118

## **Adjust the Volume Balance and Changing Voices**

### **— Mixing Console ..... 120**

Operation.....	120
Setting the Level Balance and Voice	
— Volume/Voice.....	121
Changing the Tone of the Voice — Filter.....	122
Changing Pitch-related Settings — Tune.....	122
Adjusting the Effects.....	123
Adjusting the Sound to Match the Performance	
Environment — EQ.....	125
Effect Structure.....	126

## **Using a Microphone — MIC. 128**

Selecting a Vocal Harmony Type.....	128
Adjusting the Vocal Harmony Settings and Microphone	
Effects — OVERALL SETTING.....	130
Making Settings for the Vocal Harmony and	
Microphone — MICROPHONE SETTING.....	130
Setting the Microphone Volume and Related Effects	
— TALK SETTING.....	132

## **Making Global and Other Important Settings**

### **— Function ..... 133**

Operation.....	133
Fine Tuning the Pitch/Selecting a Scale	
— Master Tune/Scale Tune.....	135
Tuning the Overall Pitch — Master Tune.....	135
Selecting a Scale — Scale Tune.....	135
Setting Song-related Parameters	
— Song Settings.....	137
Setting Auto Accompaniment-related Parameters	
— Style Setting, Split Point,	
and Chord Fingering.....	138
Setting Auto Accompaniment-related Parameters —	
Style Setting and Split Point.....	138
Setting the Fingering Method	
— Chord Fingering.....	139
Making Settings for the Pedals and Keyboard	
— Controller.....	139
Making Settings for the Pedals.....	139
Changing the Touch Sensitivity and Transpose	
— Keyboard/Panel.....	141
Setting the Registration Sequence, Freeze, and	
Voice Set.....	142
Specifying the Order for Calling Up Registration	
Memory Presets — Registration Sequence.....	142
Maintaining Panel Settings — Freeze.....	142
Changing the Automatically Selected Voice Settings	
— Voice Set.....	143
Setting Harmony and Echo.....	143

<b>Showing the Clavinova Display on a TV</b>	
— <b>Video Out</b> .....	144
<b>Setting the MIDI Parameters</b> .....	145
Making Overall System Settings	
(Local Control, Clock, etc.) — System.....	145
Transmitting MIDI Data — Transmit .....	146
Receiving MIDI Data — Receive .....	147
Setting Root Note Channels — Root.....	147
Setting Chord Channels — Chord Detect .....	147
<b>Other Settings — Utility</b> .....	148
Making Settings for Fade In/Out, Metronome,	
Parameter Lock, and Tap — CONFIG 1 .....	148
Making Settings for the Display, Speaker System,	
and Voice Number Indication — CONFIG 2.....	149
Copying and Formatting Disks — Disk.....	150
Entering Your Name and Language Preference	
— Owner.....	151
Restoring the Factory-programmed Settings of the	
CVP-209/207 — System Reset .....	151

## **Using Your Clavinova with Other Devices..... 152**

Using the Headphones (PHONES jacks).....	152
Connecting the Microphone or Guitar	
(MIC./LINE IN jack).....	152
Connecting Audio & Video Devices .....	153
Using the Pedal (footswitch) or Foot Controller	
(AUX PEDAL jack) .....	154
Connecting external MIDI devices	
(MIDI terminals) .....	154
Connecting to a Computer	
(MIDI terminals/TO HOST terminal).....	154
What's MIDI? .....	156
What You Can Do With MIDI.....	158
<b>Data Compatibility</b> .....	159
Disk format.....	159
Sequence Format.....	159
Voice Allocation Format .....	160

## **CVP-209/207: Keyboard Stand Assembly ..... 161**

## **Troubleshooting..... 163**

## **Specifications ..... 165**

## **Index ..... 167**

---

Introduction

---



---

Quick Guide

---



---

Basic Operations - Organizing Your Data

---



---

Playing the Demos

---



---

Voices

---



---

Styles

---



---

Song Playback

---



---

Saving and Recalling Custom Panel Setups - Registration Memory

---



---

Editing Voices - Sound Creator

---



---

Recording Your Performances and Creating Songs - Song Creator

---



---

Creating Accompaniment Styles - Style Creator

---



---

Adjust the Volume Balance and Changing Voices - Mixing Console

---



---

Using a Microphone - MIC.

---



---

Making Global and Other Important Settings - Function

---



---

Using Your Clavinova with Other Devices

---



---

Appendix

---

# Application Index

Use this index to find reference pages that may be helpful for your particular application and situation.

---

## Listening

---

- Listening to the internal songs ..... page 75
- Listening to disk songs ..... “Playing Back Songs on Disk” on page 77
- Listening to demo songs ..... page 53
- Listening to the demo of the selected voices ..... page 55
- Listening to songs with the special voices of the Clavinova ..... page 121

---

## Playing

---

- Calling up the piano setting ..... page 56
- Using the three performance control pedals ..... page 59
- Playing an accompaniment that matches pitch ..... “Transpose ” on page 141
- Combining two voices ..... “Layer — Layering Two Different Voices” on page 57
- Playing separate voices with the right and left hands  
..... “Left — Setting Separate Voices for the Left and Right Sections of the Keyboard” on page 58

---

## Changing the sound

---

- Enhancing the sound with reverb and other effects ..... “Applying Voice Effects” on page 58  
..... “Adjusting the Effects” on page 123
- Adjusting the Level Balance ..... page 121
- Combining two voices ..... “Layer — Layering Two Different Voices” on page 57
- Playing separate voices with the right and left hands  
..... “Left — Setting Separate Voices for the Left and Right Sections of the Keyboard” on page 58
- Creating voices ..... page 88

---

## Playing the auto accompaniment

---

- Playing the accompaniment automatically ..... page 60
- Calling up ideal panel settings for your music ..... page 70

---

## Practicing

---

- Muting the right- or left-hand part ..... page 80
- Practicing with an accurate and steady tempo ..... “Using the Metronome” on page 51

---

## Recording

---

- Recording your performance ..... pages 95, 96
- Creating a song by entering notes ..... page 98

---

## Creating your original settings

---

- Creating voices ..... page 88
- Creating accompaniment styles ..... page 110

---

## ***Using a microphone***

---

- Connecting the microphone..... "Connecting the Microphone or Guitar (MIC./LINE IN jack)" on page 152
- Adding automatic harmonies to your singing ..... page 128

---

## ***Settings***

---

- Registering Panel Setups..... page 85
- Tuning the pitch/Selecting a scale ..... page 135
- Making detailed settings for playing back songs ..... page 137
- Making detailed settings for the auto accompaniment..... page 138
- Making settings for the pedals ..... "Making Settings for the Pedals" on page 139
- Making detailed settings for the keyboard voices ..... page 141
- Showing the display on a TV ..... "Showing the Clavinova Display on a TV — Video Out" on page 144
- Making detailed settings for MIDI ..... page 145

---

## ***Connecting the Clavinova to other devices***

---

- Basic information on MIDI..... "What's MIDI?" on page 156
- Recording your performance..... "Playing the sounds of the Clavinova through an external audio system, and recording the sounds to an external recorder (AUX OUT jacks)" on page 153
- Raising the volume ..... "Playing the sounds of the Clavinova through an external audio system, and recording the sounds to an external recorder (AUX OUT jacks)" on page 153
- Outputting another instrument's sound from the Clavinova ..... "Outputting the sound of an external device through the built in speakers of the Clavinova (AUX IN jacks)" on page 153
- Connecting a computer..... "Connecting to a Computer (MIDI terminals/TO HOST terminals)" on page 154

---

## ***Assembling***

---

- Assembling and disassembling the Clavinova..... "CVP-209/207: Keyboard Stand Assembly" on page 161

---

## ***Quick solution***

---

- Basic functions of the Clavinova and how you can best use it .....pages 12, 14
- Resetting the Clavinova to the default setting  
..... "Restoring the Factory-programmed Settings of the CVP-209/207 — System Reset" on page 151
- Displaying the Messages ..... "About the Display Messages" on page 8
- Adjusting the contrast/brightness..... "Making Settings for the Display, Speaker System, and Voice Number Indication – CONFIG 2" on page 149
- Troubleshooting..... page 163

# What can you do with the Clavinova?

## SONG

### Playback previously recorded songs (page 21, 36, 74)

Enjoy a wide variety of preset songs as well as songs on commercially available disks.

## VOCAL HARMONY

### Automatic backup singing (page 128)

This sophisticated function automatically adds appropriate vocal harmonies to your singing.

## DEMO

### Explore the Demos (page 20, 53)

These not only showcase the stunning voices and styles of the instrument, they introduce you to the various functions and features — and give you hands-on experience using the Clavinova!

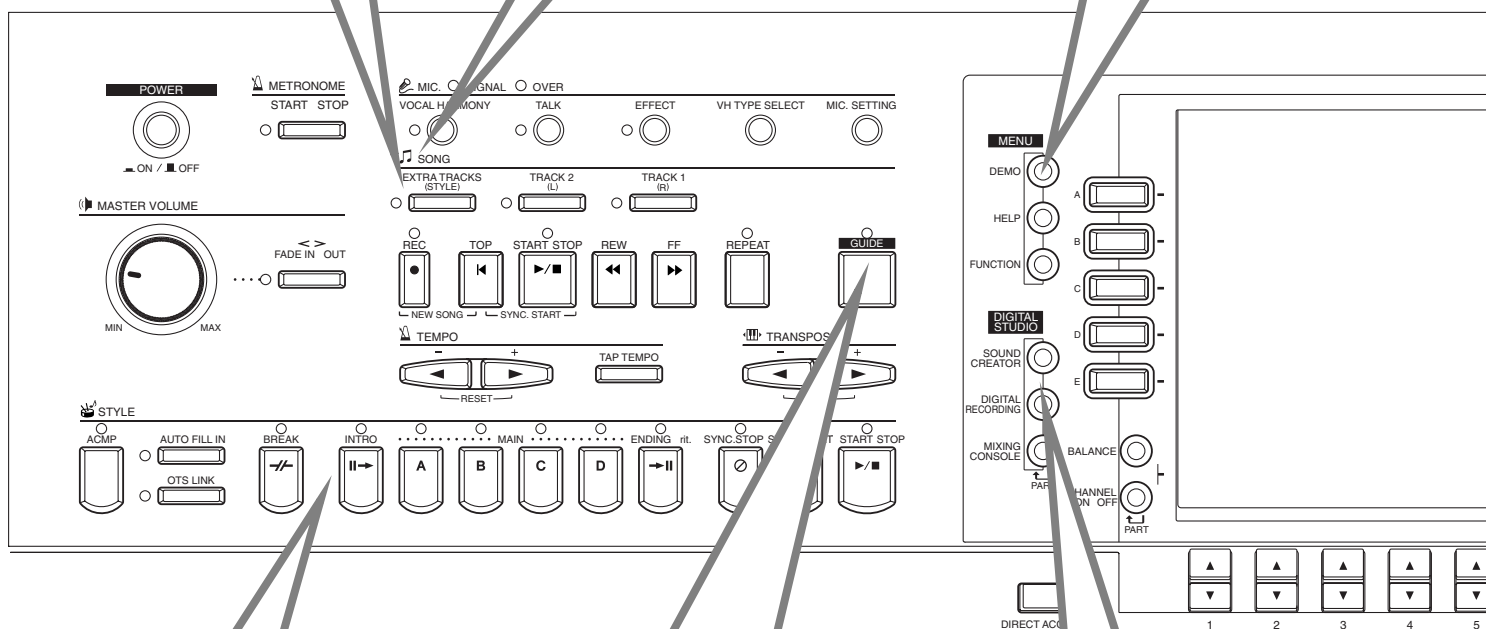

## STYLE

### Back up your performance with Auto Accompaniment (page 28, 60)

Playing a chord with your left hand automatically plays the auto accompaniment backing. Select an accompaniment style — such as pop, jazz, Latin, etc. — and let the Clavinova be your backing band!

## GUIDE

### Learn and practice with the Guide functions (page 38, 79)

Play back the preset songs or the appropriate disk software, and let the display and guide lamps show you when and where to play the proper notes. It's never been easier or more fun to learn new music!

## DIGITAL RECORDING

### Record your performances (page 94, 110)

With the powerful and easy-to-use song recording features, you can record your own keyboard performances, and create your own complete, fully orchestrated compositions — which you can then save to the USER drive or a floppy disk for future recall.

## LCD

The large LCD (together with the various panel buttons) provides comprehensive and easy-to-understand control of the Clavinova's operations.

## MUSIC FINDER

### Call up the perfect accompaniment style (page 33, 70)

If you know what song you want to play, but you don't know which style or voice would be right for it, let the Music Finder help you. Just select the song title, and the Clavinova automatically calls up the most appropriate style and voice.

## VOICE

### Enjoy a huge variety of realistic voices (page 25, 55)

The Clavinova features a wealth of exceptionally authentic and dynamic voices (more than 800) — including piano, strings, woodwinds, and more!

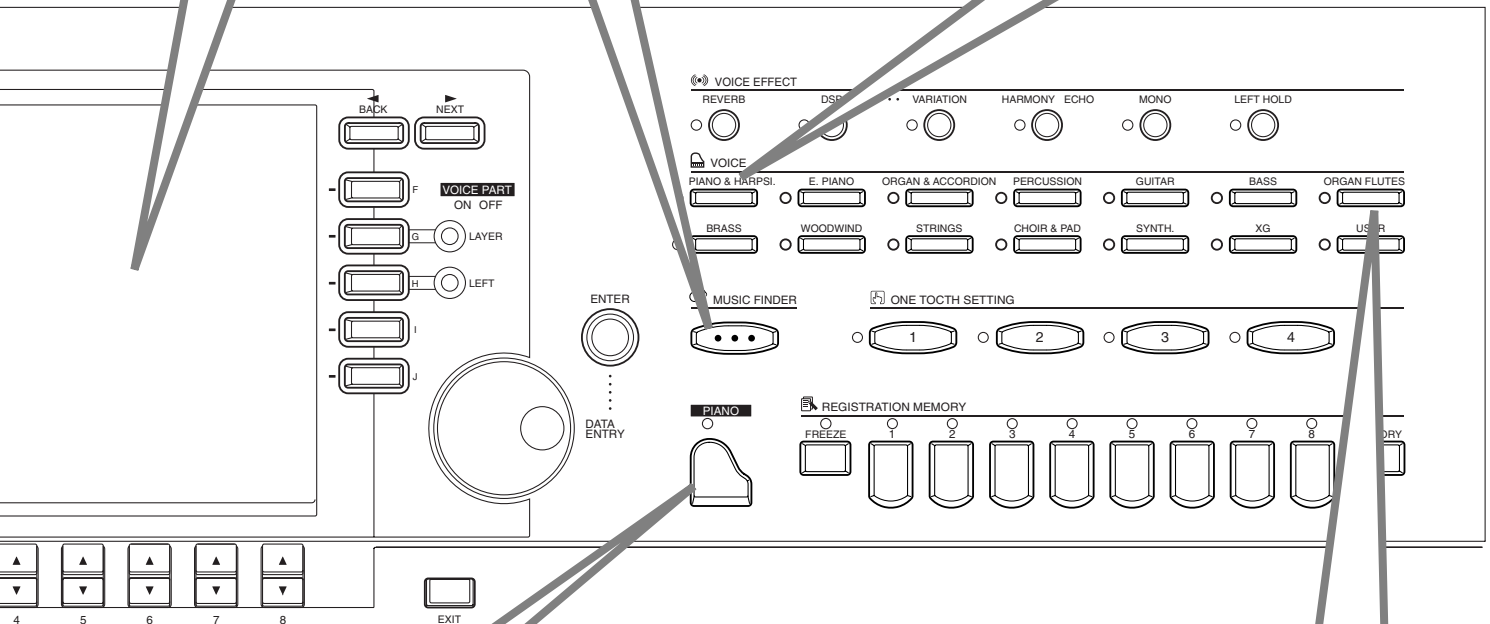

## PIANO

### Set up the piano — instantly (page 56)

You can call up all the optimum piano settings for the Clavinova with just a single button press — then play the extraordinarily realistic grand piano voice.

## TO HOST terminal

### Make music with a computer — quickly and easily (page 154)

Dive in and take advantage of the wide world of computer music software. Connections and setup are exceptionally easy, and you can play back your computer recorded parts with different instrument sounds — all from a single Clavinova!

## Organ Flutes

### Craft your own organ voices (page 93)

This special function not only gives you a full set of rich and luscious organ sounds, it also lets you create your own original organ voices, just as on a traditional organ, by increasing and decreasing the flute footages, and adding percussive sounds.

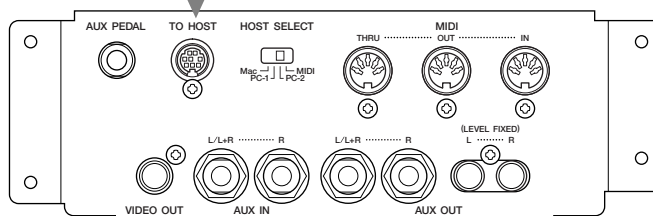

# Setting Up the Clavinova

## Key cover

### ■ To open the key cover:

Lift the cover slightly, then push and slide it open.

### ■ To close the key cover:

Slide the cover toward you and gently lower the cover over the keys.

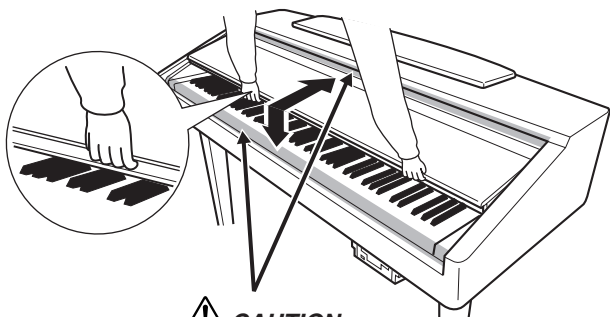

#### ⚠ CAUTION

Be careful to avoid catching your fingers when opening or closing the cover.

#### ⚠ CAUTION

Hold the cover with both hands when opening or closing it. Do not release it until it is fully opened or closed. Be careful to avoid catching fingers (yours or others, especially children's) between the cover and the unit.

#### ⚠ CAUTION

Do not place objects such as a piece of metal or paper on top of the key cover. Small objects placed on the key cover may fall inside the unit when the cover is opened and may be nearly impossible to remove. This could cause electric shock, short circuit, fire or other serious damage to the instrument.

## Music Stand

### ■ To raise the music stand:

1 Pull the music stand toward yourself as far as it will go.

2 Lower the music stand until it locks in place.

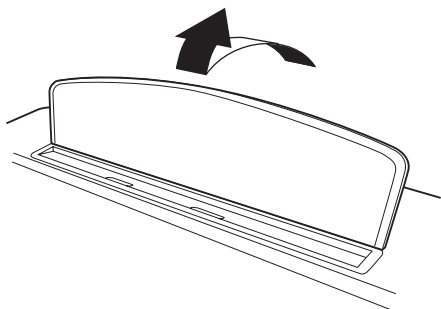

### ■ To lower the music stand:

1 Pull the music stand toward yourself as far as it will go.

2 Gently lower the music stand backward until it is all the way down.

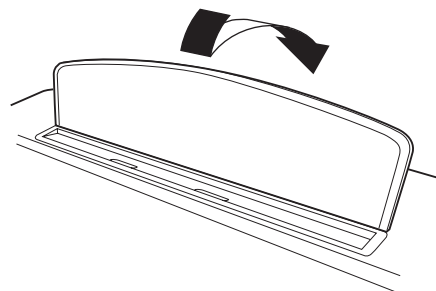

#### ⚠ CAUTION

Do not try to use the music stand in a half-raised position. Also, when lowering the stand, let the stand all the way down before releasing it.

## Sheet Music Braces

These braces are for holding the pages of music books in place.

### ■ To open

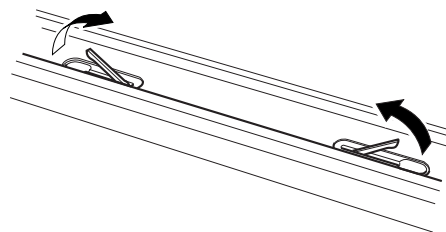

### ■ To close

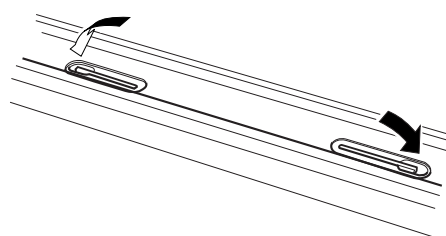



# Turning the Power On and Off

## Connect the power cord.

**1** Insert the plugs at the ends of the cord, one into the AC INLET on the Clavinova, and the other into a standard AC outlet.

In some areas, a plug adapter may be provided to match the pin configuration of the AC wall outlets in your area.

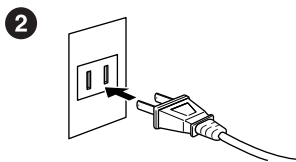
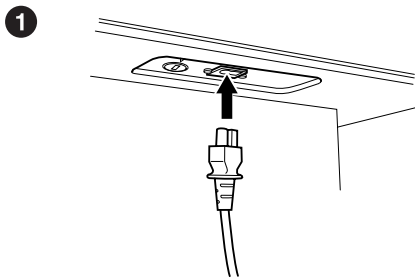

(The shape of plug differs depending on locale.)

**2** Press the **[POWER]** switch.  
→ The main display appears in the LCD display. The drive lamp below the lower right end of the keyboard also lights.

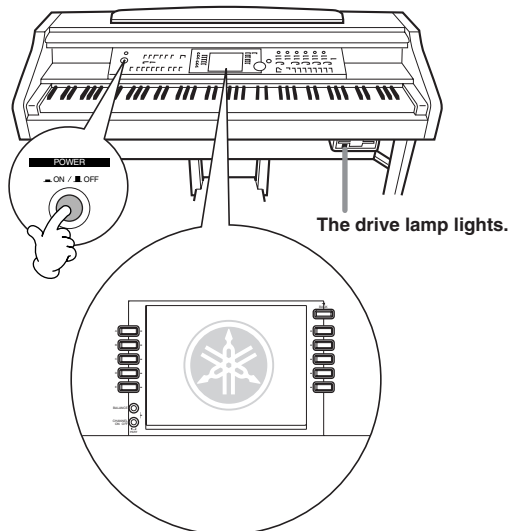

When you're ready to turn off the power, press the **[POWER]** switch again.

→ Both the display and the drive lamp below the right end of the keyboard will turn off.

## Setting the volume

Use the **[MASTER VOLUME]** dial to adjust the volume to an appropriate level.

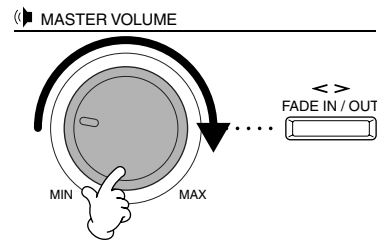

### CAUTION

Do not use the Clavinova at a high volume level for a long period of time, or your hearing may be damaged.

## Using headphones

Connect a pair of headphones to one of the **[PHONES]** jacks.

Two **[PHONES]** jacks are provided.

Two sets of standard stereo headphones can be plugged in. (If you are using only one pair of headphones, you can plug them into either of these jacks.)

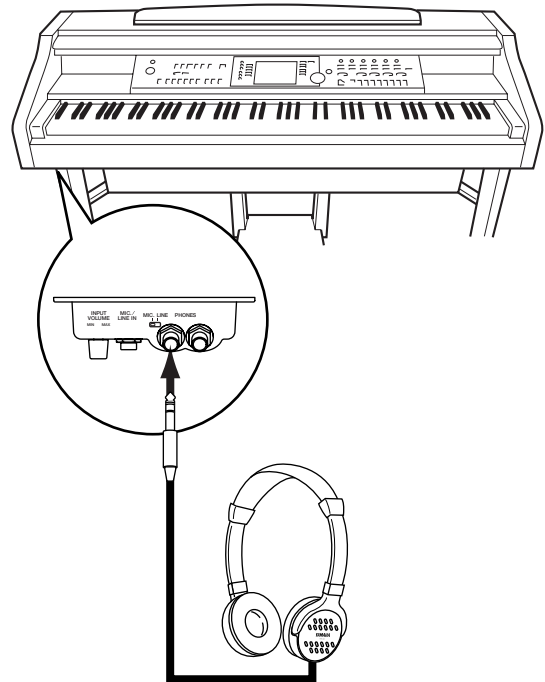

# Panel Controls and Terminals

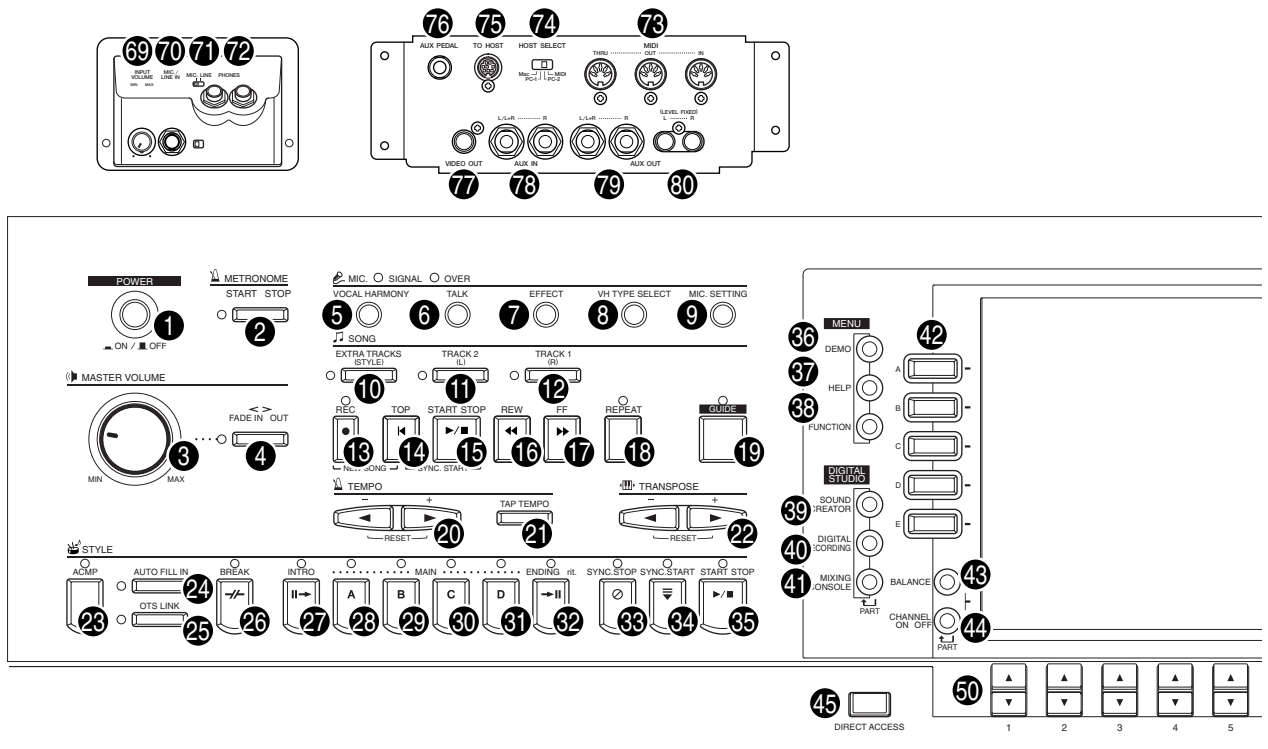

## POWER

- 1 [ON / OFF] button (POWER)..... P. 17

## METRONOME

- 2 [START / STOP] button (METRONOME) ..... P. 51

## MASTER VOLUME

- 3 [MASTER VOLUME] dial..... P. 17
- 4 [FADE IN / OUT] button..... P. 66

## MIC.

- 5 [VOCAL HARMONY] button..... P. 128
- 6 [TALK] button ..... P. 128
- 7 [EFFECT] button ..... P. 128
- 8 [VH TYPE SELECT] button..... P. 128
- 9 [MIC. SETTING] button ..... P. 128

## SONG

- 10 [EXTRA TRACKS (STYLE)] button ..... P. 78
- 11 [TRACK 2 (L)] button..... P. 78
- 12 [TRACK 1 (R)] button ..... P. 78
- 13 [REC] button ..... P. 94
- 14 [TOP] button..... P. 77
- 15 [START / STOP] button (SONG) ..... P. 75
- 16 [REW] button..... P. 77
- 17 [FF] button..... P. 77
- 18 [REPEAT] button ..... P. 78
- 19 [GUIDE] button..... P. 79

## TEMPO

- 20 [◀] [▶] buttons (TEMPO)..... P. 51
- 21 [TAP TEMPO] button..... P. 52

## TRANSPOSE

- 22 [◀] [▶] buttons (TRANSPOSE) ..... P. 141

## STYLE

- 23 [ACMP] button..... P. 61
- 24 [AUTO FILLIN] button..... P. 67
- 25 [OTS LINK] button ..... P. 69
- 26 [BREAK] button..... P. 65

- 27 [INTRO] button..... P. 31, 67
- 28 MAIN [A] button..... P. 65
- 29 MAIN [B] button..... P. 65
- 30 MAIN [C] button ..... P. 65
- 31 MAIN [D] button ..... P. 65
- 32 [ENDING / rit.] button ..... P. 31, 67
- 33 [SYNC.STOP] button ..... P. 66
- 34 [SYNC.START] button..... P. 61
- 35 [START / STOP] button (STYLE) ..... P. 61

## MENU

- 36 [DEMO] button ..... P. 53
- 37 [HELP] button ..... P. 50
- 38 [FUNCTION] button ..... P. 133

## DIGITAL STUDIO

- 39 [SOUND CREATOR] button ..... P. 88
- 40 [DIGITAL RECORDING] button ..... P. 94, 110
- 41 [MIXING CONSOLE] button..... P. 120

## DISPLAY CONTROL

- 42 [A] - [J] buttons..... P. 41
- 43 [BALANCE] button ..... P. 62
- 44 [CHANNEL ON / OFF] button ..... P. 62, 77
- 45 [DIRECT ACCESS] button..... P. 48
- 46 [BACK] button ..... P. 41, 47
- 47 [NEXT] button ..... P. 41, 47
- 48 VOICE PART ON / OFF [LAYER] button..... P. 57
- 49 VOICE PART ON / OFF [LEFT] button ..... P. 57
- 50 [1▲▼] - [8▲▼] buttons ..... P. 39 - 46
- 51 [ENTER] button..... P. 47
- 52 [DATA ENTRY] dial..... P. 47
- 53 [EXIT] button..... P. 41

## VOICE EFFECT

- 54 [REVERB] button ..... P. 58
- 55 [DSP] button..... P. 58
- 56 [VARIATION] button ..... P. 58
- 57 [HARMONY / ECHO] button ..... P. 59
- 58 [MONO] button..... P. 59
- 59 [LEFT HOLD] button ..... P. 59

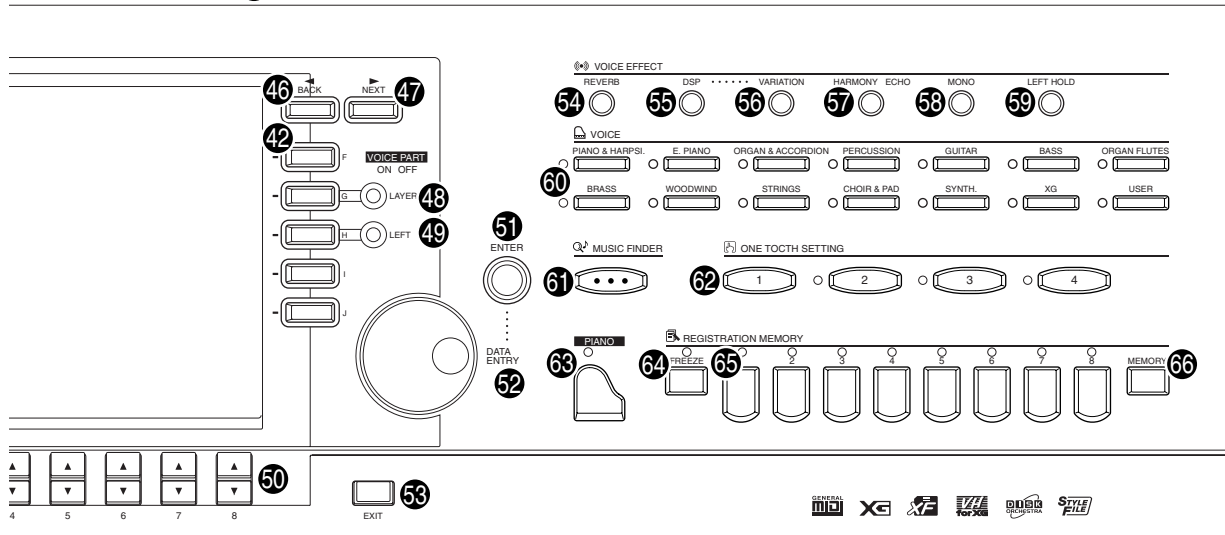
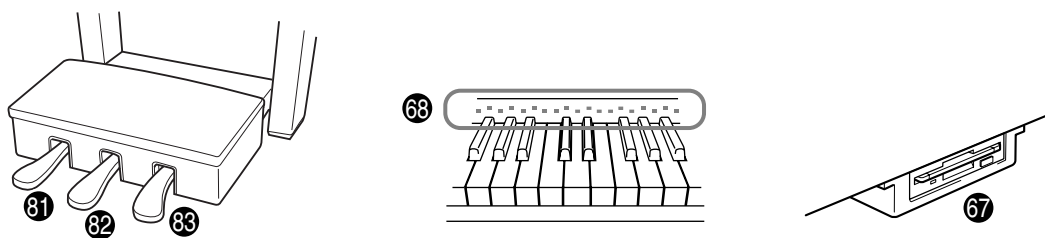

## VOICE

- 60 VOICE buttons ..... P. 55

## MUSIC FINDER

- 61 [MUSIC FINDER] button ..... P. 70

## ONE TOUCH SETTING

- 62 [1] - [4] buttons (ONE TOUCH SETTING) ..... P. 68

## PIANO Setting

- 63 [PIANO] button ..... P. 56

## REGISTRATION MEMORY

- 64 [FREEZE] button ..... P. 87
- 65 [1] - [8] buttons (REGISTRATION MEMORY) ..... P. 85
- 66 [MEMORY] button ..... P. 85

- 67 Floppy disk drive (3.5") ..... P. 6
- 68 Keyboard guide lamps ..... P. 79

## Microphone and Headphone Connectors

- 69 [INPUT VOLUME] knob ..... P. 152
- 70 [MIC. LINE IN] jack ..... P. 152
- 71 [MIC. LINE] switch ..... P. 152
- 72 [PHONES] jacks ..... P. 152

## Connectors

- 73 MIDI [THRU] [OUT] [IN] terminals ..... P. 154
- 74 [HOST SELECT] switch ..... P. 154
- 75 [TO HOST] terminal ..... P. 155
- 76 [AUX PEDAL] jack ..... P. 154
- 77 [VIDEO OUT] jack ..... P. 153
- 78 AUX IN [L / L+R] [R] jacks ..... P. 153
- 79 AUX OUT [L / L+R] [R] jacks ..... P. 153
- 80 AUX OUT (LEVEL FIXED) [L] [R] jacks ..... P. 153

## Pedals

- 81 Left pedal ..... P. 59
- 82 Sostenuto pedal ..... P. 59
- 83 Damper pedal ..... P. 59

## The Panel Logos

The logos printed on the Clavinova panel indicate standards/formats it supports and special features it includes.

### GM System Level 1

"GM System Level 1" is an addition to the MIDI standard which guarantees that any data conforming to the standard will play accurately on any GM-compatible tone generator or synthesizer from any manufacturer.

### XG Format

XG is a new Yamaha MIDI specification which significantly expands and improves on the "GM System Level 1" standard with greater voice handling capacity, expressive control, and effect capability while retaining full compatibility with GM. By using the Clavinova's XG voices, it is possible to record XG-compatible song files.

### XF Format

The Yamaha XF format enhances the SMF (Standard MIDI File) standard with greater functionality and open-ended expandability for the future. The Clavinova is capable of displaying lyrics when an XF file containing lyric data is played. (SMF is the most common format used for MIDI sequence files. The Clavinova is compatible with SMF Formats 0 and 1, and records "song" data using SMF Format 0.)

### Vocal Harmony

Vocal Harmony employs state-of-the-art digital signal processing technology to automatically add appropriate vocal harmony to a lead vocal line sung by the user. Vocal Harmony can even change the character and gender of the lead voice as well as the added voices to produce a wide range of vocal harmony effects.

### Disk Orchestra Collection

The DOC voice allocation format provides data playback compatibility with a wide range of Yamaha instruments and MIDI devices.

### Style File Format

The Style File Format (SFF) is Yamaha's original style file format, which uses a unique conversion system to provide high-quality automatic accompaniment based on a wide range of chord types. The Clavinova uses the SFF internally, reads optional SFF style disks, and creates SFF styles using the Style Creator feature.

# Quick Guide . . . . .

## Playing the Demos

Reference  
on page 53

The Clavinova features an extensive variety of Demo songs, that showcase its rich, authentic voices and its dynamic rhythms and styles.

What's more, there's a special selection of Demo functions. These take you through a hands-on journey of all the important features and functions of the instrument — letting you see firsthand how to effectively use the Clavinova in your own music.

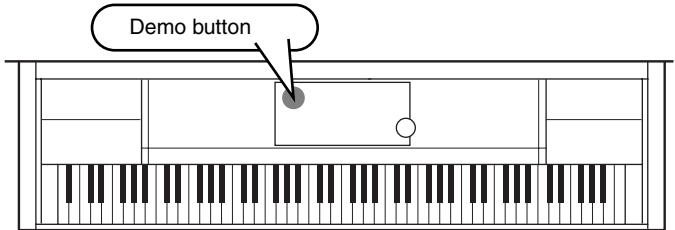

▶ **1** Pressing the [DEMO] button automatically plays back the Demo songs at random.

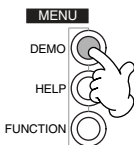

For this example, FUNCTION is selected. Function Demos demonstrate many of the different functions on the CVP-209/207.

▶ **2** Press the [BACK]/[NEXT] button to select the Demo categories.

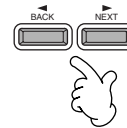
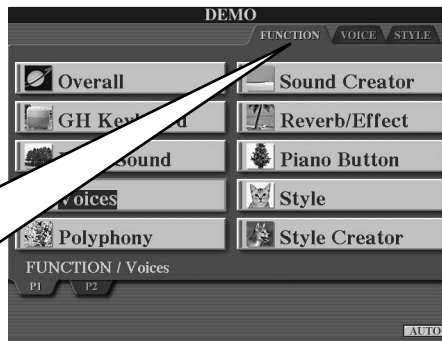

**NOTE**  
Voice Demos showcase the voices of the CVP-209/207. Style Demos introduce you to the rhythms and accompaniment styles of the CVP-209/207 (page 53).

▶ **3** Press any of the [A] to [J] buttons or [8▼] (AUTO) button (FUNCTION page only) to select the Demo songs. For this example, press the [8▼] (AUTO) button. All of the function demos are played back in sequence.

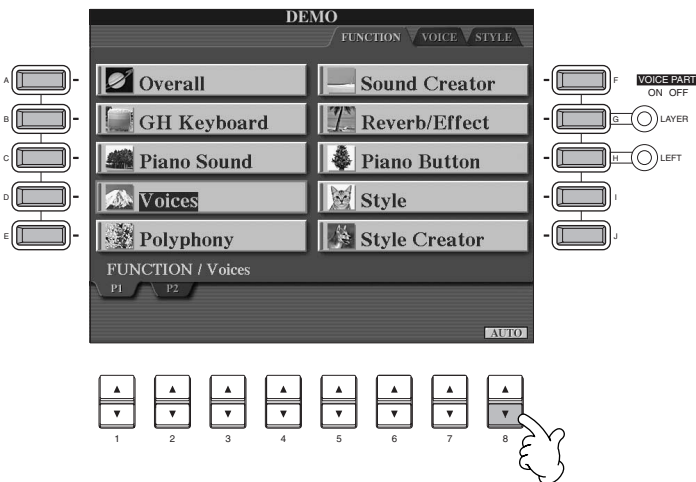

**NOTE**  
For details about the Demos, refer to page 53.

Press the [EXIT] button to exit from the demo mode and return to the MAIN display when you've finished playing the demo songs.

**When you're done with the Demos, you can get to know your Clavinova even better with these functions:**

- Preset Song (Song Book) playback (page 21)
- Disk Song Playback (page 21)
- Short demo playback of the selected voice (in the Voice Open display; page 26).

# Song Playback

Reference on page 74

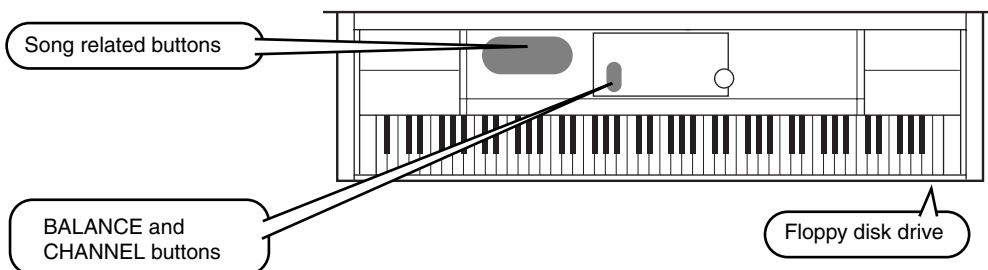

Here's where all of the amazing voices, effects, rhythms, styles and other sophisticated features of the Clavinova come together — in songs!

As you heard in the Demos, the Clavinova contains many built-in recordings. But there's more. Call up the Song Open (PRESET) display. And there's an even greater wealth of song material you can enjoy with your Clavinova — in commercially available software.



**NOTE**  
Make sure that the Language setting for the instrument (page 151) is the same as that of the file name of the song that you are playing back.

The following songs are compatible for playback on the CVP-209/207. Refer to pages 74, 159 for more details on the logos.

-  Disks bearing this logo contain song data for voices defined in the GM standard.
-  Disks bearing this logo contain song data using the XG format, an extension of the GM standard that provides a wider variety of voices and more comprehensive sonic control.
-  Disks bearing this logo contain song data for voices defined in Yamaha's DOC format.

**NOTE**  
Songs containing a large amount of data may not be able to be read properly by the instrument, and as such you may not be able to select them. The maximum capacity is about 200–300KB, however this may differ depending on the data contents of each song.

## Playback of Songs

► **1** If you want to play back a disk song, insert an appropriate disk containing song data into the disk drive.

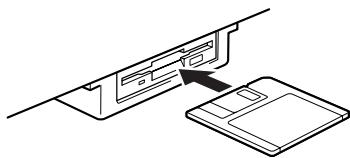

**CAUTION**  
• Make sure to read the section "Using the Floppy Disk Drive (FDD) and Floppy Disks" on page 6.

## Song Playback

- ▶ **2** Press the [A] button to call up the Song Open display.  
 If the MAIN screen is not displayed, press the [DIRECT ACCESS] button followed by the [EXIT] button.

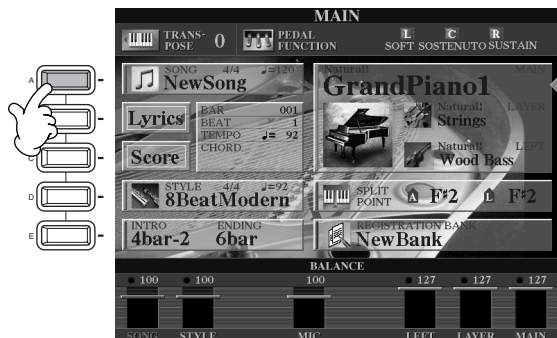

**NOTE**  
 From the MAIN display (the display shown when the power is turned on), you can select songs, voices, accompaniment styles, etc.

### PRESET



### FLOPPY DISK



Press the [BACK]/[NEXT] button to select the drive.

- ▶ **3** Press the [A] button to select the preset songs (Song Book) folder.



▶ **4** Press one of the [A] to [J] buttons to select a song file.

▶ **5** Press the SONG [START/STOP] button to start playback.

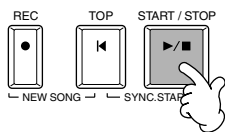

**NOTE**

- To rewind or fast forward to the playback point of the song, press the [REW] or [FF] button.
- With song data software (Standard MIDI format 0) that includes lyrics, you can view the lyrics on the display during playback. You can also view the score. See pages 81 and 84 for details.

▶ **6** While the song is playing, try using the Mute function to turn certain instrument channels off or on — letting you craft dynamic arrangements on the fly!

- 1) Press the [CHANNEL ON/OFF] button.
- 2) Press the [1 - 8▲▼] button corresponding to the channel you wish to turn on or off.

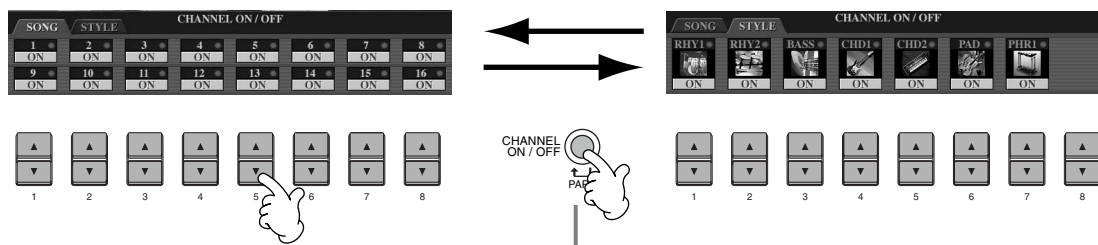

If the STYLE tab is selected, press this button again.

## Song Playback

- ▶ **7** Finally, take the producer's seat and try your hand at mixing. These Balance controls let you adjust the levels of the individual parts — the song, the style, your singing, and your playing.

- 1) Press the [BALANCE] button.
- 2) Press the [1 - 8▲▼] button corresponding to the part of which the volume you wish to adjust.

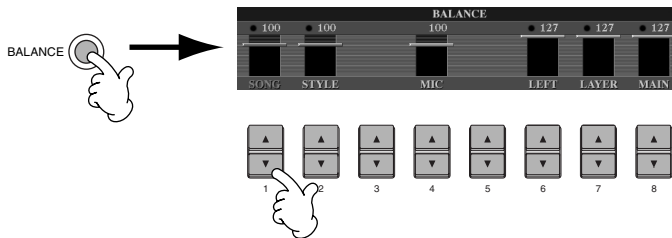

### NOTE

You can call up a full set of mixing controls by pressing the [MIXING CONSOLE] button (page 120).

- ▶ **8** Press the SONG [START/STOP] button to stop playback.

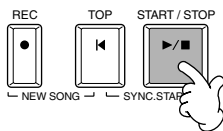

### NOTE

- The [FADE IN/OUT] button (page 66) can be used to produce smooth fade-ins and fade-outs when starting and stopping the song, as well as the accompaniment.



# Playing Voices

Reference on page 55

The Clavinova features a stunning variety of over 800 dynamic, rich and realistic voices. Try playing some of these voices now and hear what they can do for your music. Here, you'll learn how to select individual voices, combine two voices in a layer, and split two voices between your left and right hands.

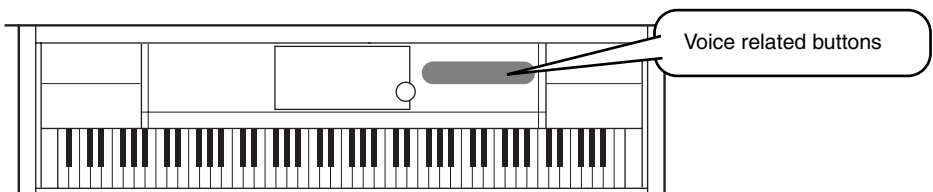

## Playing a Voice

- ▶ **1** Press the [F] button to call up the menu for selecting the MAIN voice. If the MAIN screen is not displayed, press the [DIRECT ACCESS] button followed by the [EXIT] button.

**NOTE**  
The voice you're selecting here belongs to the MAIN part, and is called the MAIN voice. (See page 57 for more information.)

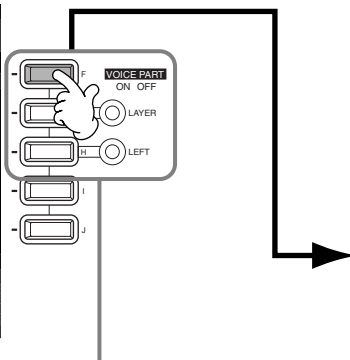
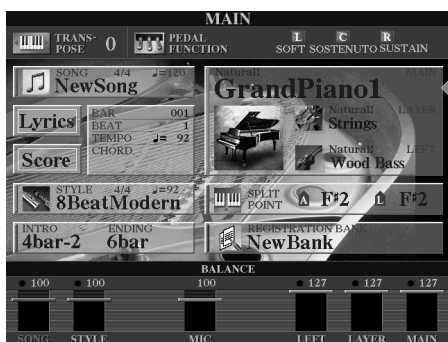

You'll want to hear the MAIN voice all by itself — so make sure that the LAYER and LEFT parts are turned off.

- ▶ **2** Select a voice group.

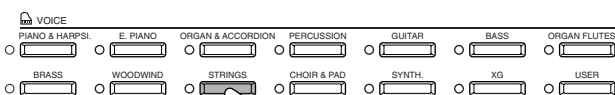

For this example, STRINGS is selected.



Press the [BACK]/[NEXT] button to select the memory location of the voice. For this example, PRESET is selected.

## Playing Voices

- ▶ **3** Select a voice.

For this example, "Orchestra" is selected.

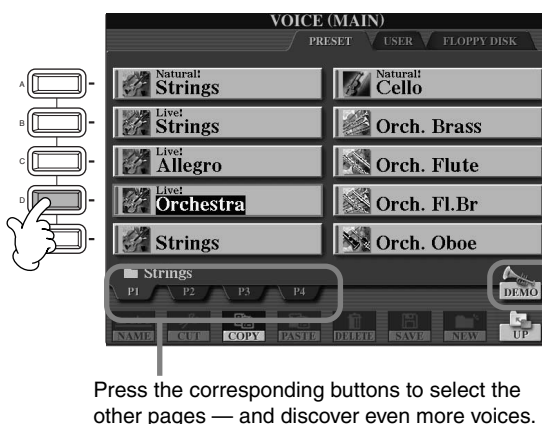

**NOTE**  
You can instantly jump back to the Main display by "double-clicking" on one of the [A] - [J] buttons.

Press the [8▲] button to start the Demo for the selected voice. To stop the Demo, press this button again. There's more to the Demo features than just voices, though—for more information, see page 53.

Press the corresponding buttons to select the other pages — and discover even more voices.

- ▶ **4** Play the voices.

Naturally, you can play the voice yourself from the keyboard, but you can also have the Clavinova demonstrate the voice for you. Simply press the [8▲] button from the display above, and a Demo of the voice plays automatically.

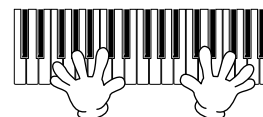

## Playing Two Voices Simultaneously

- ▶ **1** Press the VOICE PART ON/OFF [LAYER] button to turn the LAYER part on.
- ▶ **2** Press the [G] button to select the LAYER part.

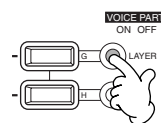

- ▶ **3** Select a voice group. Here, we'll select a lush pad to fill out the sound. Call up the "CHOIR & PAD" group.

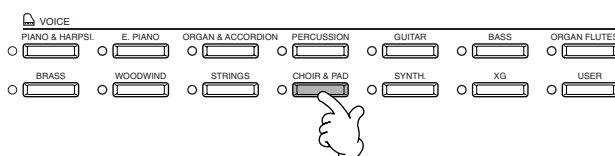

- ▶ **4** Select a voice. For example, select "Hah Choir."

- ▶ **5** Play the voices. Now, you can play two different voices together in a rich sounding layer — the MAIN voice you selected in the previous section, plus the new LAYER voice you've selected here.



**And that's just the beginning. Check out these other voice-related features:**

- Instant setup of the Clavinova for piano play — with the press of a single button (page 56).
- Create your own original voices — quickly and easily — by changing the settings of existing voices (page 88).
- Set up your favorite panel settings — including voices, styles, and more — and call them up whenever you need them (page 85).

# Playing Different Voices with the Left and Right Hands

- ▶ **1** Press the VOICE PART ON/OFF [LEFT] button to turn the LEFT part on.
- ▶ **2** Press the [H] button to select the LEFT part.
- ▶ **3** Select a voice group.  
Here, we'll select the "STRINGS" group — so that you can play rich, orchestral chords with your left hand.

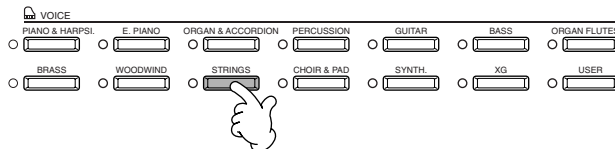
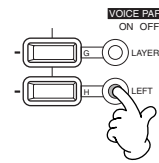

- ▶ **4** Select a voice, then press the [EXIT] button to return to the MAIN display.  
For example, select "Symphon. Str."
- ▶ **5** Press the [I] button to call up the SPLIT POINT display. From here, you can set the particular key on the keyboard that separates the two voices — called the Split Point. To do this, simultaneously hold down the [F] or [G] button and press the desired key on the keyboard. (For more information, see page 138.)

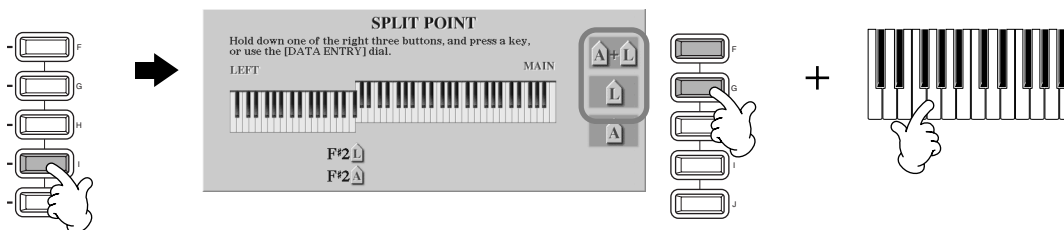

- ▶ **6** Play the voices.  
The notes you play with your left hand sound one voice, while the notes you play with your right sound a different voice (or voices).

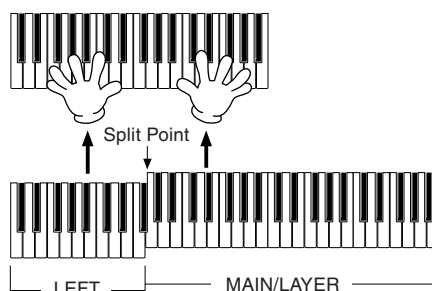

MAIN and LAYER voices are meant to be played with the right hand. The LEFT voice is played with the left hand.

- ▶ **7** Press the [EXIT] button to return to the MAIN display.

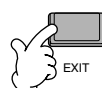

# Playing Styles

Reference on page 60

The Clavinova has a huge variety of musical “styles” that you can call upon to back up your own performance. They give you anything from a simple, yet effective piano backing or percussion accompaniment to a full band or orchestra.

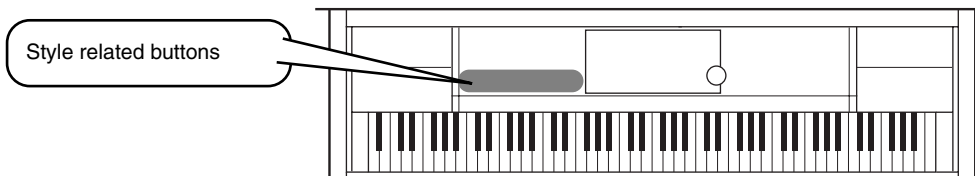

## Playing a style

- ▶ **1** Press the [D] button to call up the style group.  
If the MAIN screen is not displayed, press the [DIRECT ACCESS] button followed by the [EXIT] button.

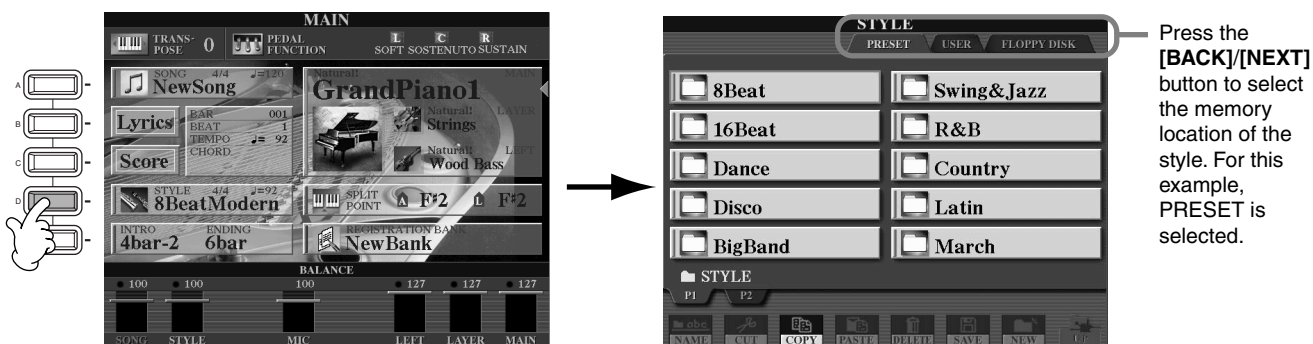

- ▶ **2** Select a style group and a style.

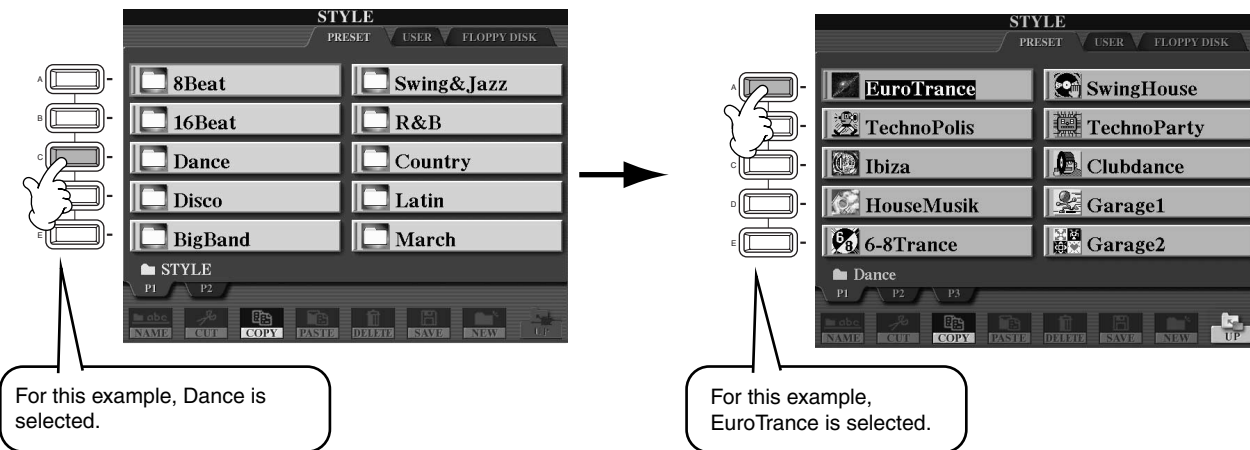

▶ **3 Turn ACMP on.**

The specified left-hand section of the keyboard becomes the “Auto Accompaniment” section, and chords played in this section are automatically detected and used as a basis for fully automatic accompaniment with the selected style.

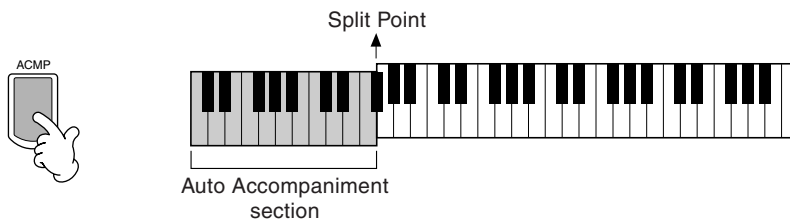

**NOTE**

- The point on the keyboard that separates the auto accompaniment section and the right-hand section of the keyboard is called the “split point.” Refer to page 138 for instructions on setting the split point.

▶ **4 Turn SYNC.START on.**



▶ **5 As soon as you play a chord with your left hand, the style starts.**  
For this example, play a C major chord (as shown below).

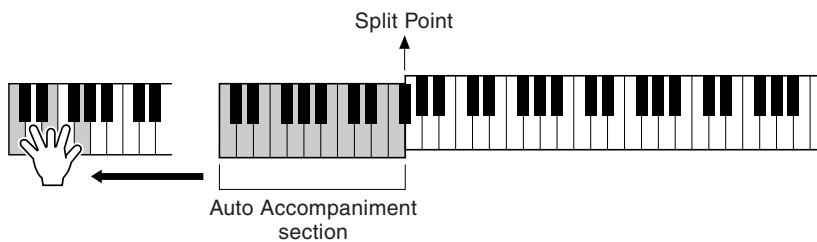

▶ **6 Change the tempo by using the TEMPO[◀] [▶] buttons if necessary.**

Simultaneously press the TEMPO [◀] [▶] buttons to return the tempo to its original setting. Press the [EXIT] button to leave the TEMPO display.

**NOTE**

The Tempo can also be adjusted by using the [TAP TEMPO] button (page 52).

▶ **7 Try playing other chords with your left hand.**

For information on how to enter chords, see “Chord Fingerings” on page 62.

▶ **8 Press the STYLE [START/STOP] button to stop the style.**

**And there’s much more. Check out these other style-related features:**

- Easily create your own original styles (page 110).
- Set up your favorite panel settings — including styles, voices, and more — and call them up whenever you need them (page 85).

## Embellish and enhance your melodies — with the automatic Harmony and Echo effects

This powerful performance feature lets you automatically add harmony notes to the melodies you play with your right hand — based on the chords you play with your left. Tremolo, Echo, and other effects are available, too.

**1 Turn HARMONY/ECHO on.**



**2 Turn ACMP on (page 28).**

**3 Play a chord with your left hand and play some notes in the right-hand range of the keyboard.**

The CVP-209/207 has various Harmony/Echo types (page 143).

The Harmony/Echo type may change according to the selected MAIN voice.

**NOTE**

For details about Harmony/Echo types, refer to the separate Data List.

- Harmony/Echo is just one of the many Voice Effects you can use. Try out some of the other effects and see how they can enhance your performance (page 58).

## Style Sections

Each style in the auto accompaniment is made up of “sections.” Since each section is a rhythmic variation of the basic style, you can use them to add spice to your performance and mix up the beats — while you’re playing. Intros, Endings, Main patterns, and Breaks — they’re all here, giving you the dynamic elements you need to create professional-sounding arrangements.

INTRO	This is used for the beginning of the song. When the intro finishes playing, accompaniment shifts to the main section.
MAIN	This is used for playing the main part of the song. It plays an accompaniment pattern of several measures, and repeats indefinitely until another section’s button is pressed.
BREAK	This lets you add dynamic variations and breaks in the rhythm of the accompaniment, to make your performance sound even more professional.
ENDING	This is used for the ending of the song. When the ending is finished, the auto accompaniment stops automatically.

▶ **1-4** Use the same operations as in “Playing a style” on pages 28 and 29.

▶ **5** Press the [INTRO] button.

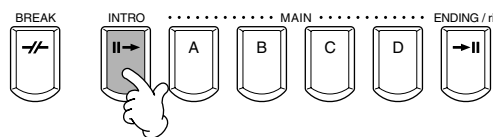

▶ **6** As soon as you play a chord with your left hand, the Intro starts.  
For this example, play a C major chord (as shown below).

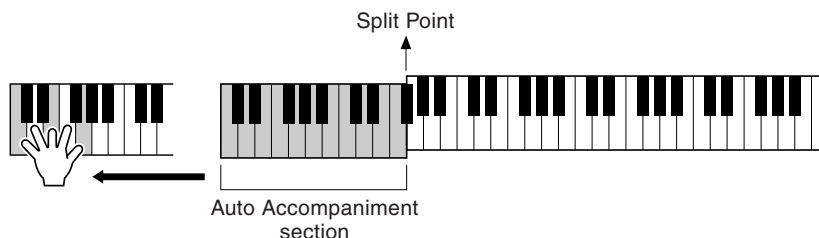

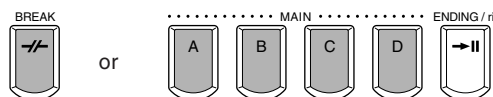

When the playback of the intro is finished, it automatically leads into main section.

▶ **7** Press any of the MAIN [A] to [D] buttons or [BREAK] button as desired. (See the Accompaniment Structure on the next page.)





## Other Controls

<p>FADE IN/OUT</p> 	<p>The [FADE IN/OUT] button can be used to produce smooth fade-ins and fade-outs (page 66) when starting and stopping the style.</p>
<p>TAP TEMPO</p> 	<p>The style can be started at any tempo you desire by “tapping” out the tempo with the [TAP/TEMPO] button. For details, see page 52.</p>
<p>SYNC.STOP</p> 	<p>When Synchro Stop is on, you can stop and start the style anytime you want by simply releasing or playing the keys (in the Auto Accompaniment section of the keyboard). This is a great way to add dramatic breaks and accents to your performance. For details, see page 66.</p>

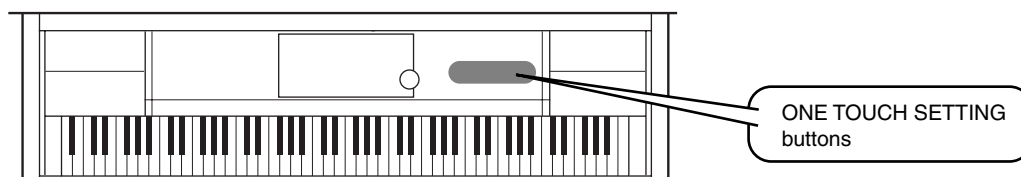

## One Touch Setting

One Touch Setting is a powerful and convenient feature that automatically calls up the most appropriate panel settings (voice number, etc.) for the currently selected style, with the touch of a single button. This is a wonderful way to instantly reconfigure all the settings on the Clavinova to match the style you want to play.

- ▶ **1** Select a style (page 28).
- ▶ **2** Press one of the [ONE TOUCH SETTING] buttons.  
Not only does this instantly call up all the settings (voices, effects, etc.) that match the current style (see page 68) — it also automatically turns on ACMP and SYNC. START, so that you can immediately start playing the style.

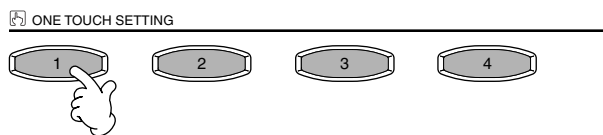

- ▶ **3** As soon as you play a chord with your left hand, the auto accompaniment starts.

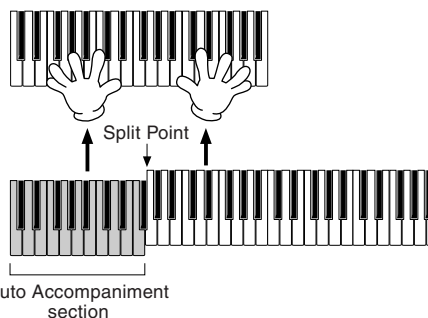

- ▶ **4** Play melodies with your right hand and play various chords with your left hand.

- ▶ **5** Try out other One Touch Setting setups.  
You can also create your own One Touch Setting setups. For details, refer to page 69.

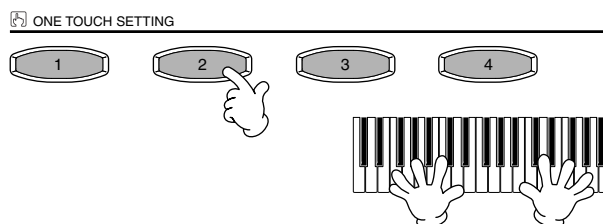

- Here's another way to further automate musical changes and spice up your performance: Use the convenient OTS (One Touch Setting) Link function to automatically change One Touch Settings when you select a different Main section (page 69).



# Music Finder

Reference on page 70

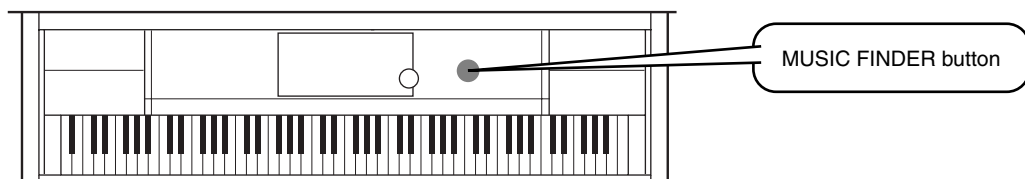

If you want to play in a certain song but don't know which style and voice settings would be appropriate, the convenient Music Finder can help you out. Simply select the song name from the Music Finder and the CVP-209/207 automatically makes all appropriate panel settings to let you play in that music style!

## Using the Music Finder

- ▶ **1** Press the [MUSIC FINDER] button.



- ▶ **2** Select a record.

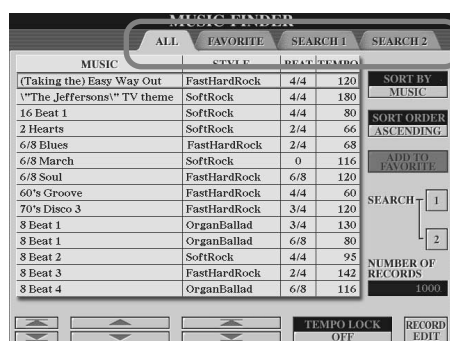

Press the [BACK]/[NEXT] button to select the desired page of records. For this example, ALL is selected.

Select the desired record.

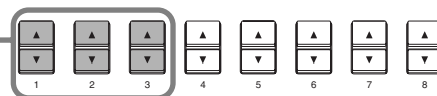

For this example, press the [1 - 3▲▼] button to select a record by song title.

- ▶ **3** Play along with the style playback.

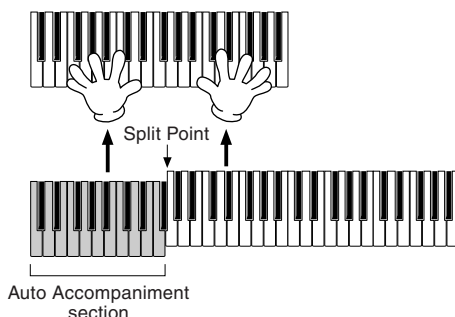

Press the [EXIT] button to return to the MAIN display.

**NOTE**  
You can also have the voice and other important settings change automatically with the style changes. To do this, turn on OTS LINK (page 69) and set the OTS LINK TIMING (page 138) to "REAL."

# Searching the Music Finder Records

The Music Finder is also equipped with a convenient search function that lets you enter a song title or keyword — and instantly call up all the records that match your search criteria.

- **1** Press the [MUSIC FINDER] button.



- **2** Press the [I] button to call up the MUSIC FINDER SEARCH 1 display.

**NOTE**  
The results of Search 1 and 2 appear in the correspondingly numbered SEARCH 1/2 displays.

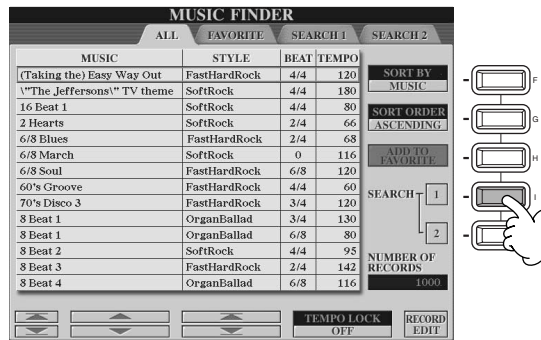

**4** For this example, press the [A] button to call up the display for inputting the song title.

For this example, ANY is selected.

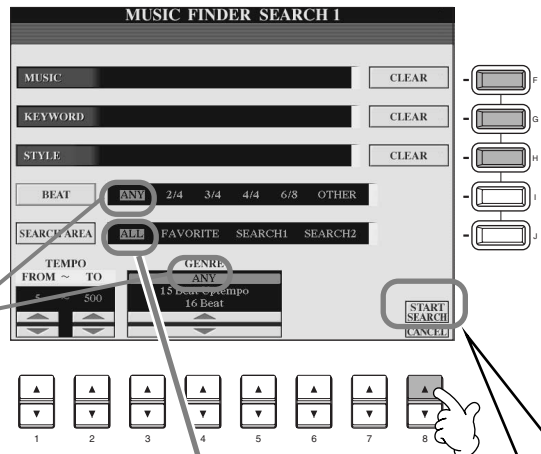

**NOTE**  
Refer to page 46 for instructions on entering characters.

**3** Press the [F], [G] and [H] to clear the previous conditions, if necessary.

**5** Enter the song title, then press the [8▲] (OK) button.

For this example, ALL is selected.

**6** Press the [8▲] (START SEARCH) button. The search function calls up all records that contain the entered word or words.



- ▶ **7** Select a record (see step #2 on page 33) and play along with the style playback.

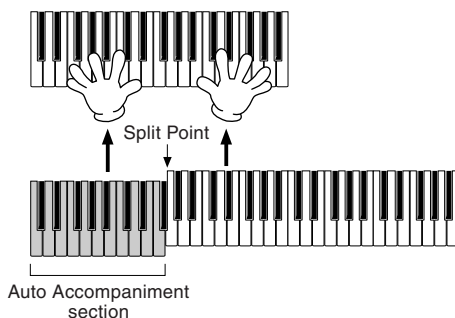

Press the [EXIT] button to return to the MAIN display.

You can also create your own Music Finder setups and save them to floppy disk (pages 39 and 45). In this way, you can expand your Music Finder collection by exchanging them with other Clavinova users.

**Saving and Recalling Music Finder Data**

To save your Music Finder data, call up the MUSIC FINDER Open/Save window from the SYSTEM RESET page (page 151) of the UTILITY display, and follow the same procedure as that in the Open/Save window for Voice (page 39, 45). To recall the saved data, execute the appropriate operation from the MUSIC FINDER's Open/Save window. Records can be replaced or added (page 72).

**NOTE**  
Music Finder data is compatible for both the CVP-209 and the CVP-207.

In the instructions above, all Music Finder data is handled together. Besides this, when you save or load style files, the Music Finder data that uses the relevant style file(s) is stored or added automatically. When you copy or move a style file on a floppy disk to the USER drive (page 43, 44), the record which was recorded when storing the relevant style is automatically added to the CVP-209/207.

- In the example above, you specified a song title, but you can also look for relevant records by keyword or music genre — for example, Latin, 8-beat, etc. (page 71).

# Playing and Practicing with the Songs

Reference on page 74

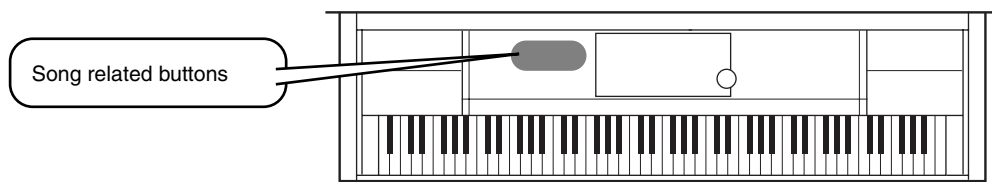

## Playing Along with the Clavinova

In this section, try using the Clavinova's song playback features to cancel or mute the right-hand melody while you play the part yourself. It's like having a very talented and versatile playing partner accompany you while you perform. If you haven't yet mastered the melody part, take a look at the section "Mastering Your Favorite Songs" on page 38, and practice it a while.

▶ **1-4** Use the same operations as in "Song Playback" on pages 21 - 23.

▶ **5** Press the [TRACK 1] button to cancel the right hand melody part.

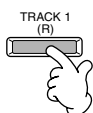

**NOTE**  
To cancel the left hand part, press the [TRACK 2] button.

▶ **6** If you want to have the notation displayed as you play, press the [C] button. If you want to see the lyrics, press the [B] button.

If the MAIN screen is not displayed, press the [DIRECT ACCESS] button followed by the [EXIT] button.

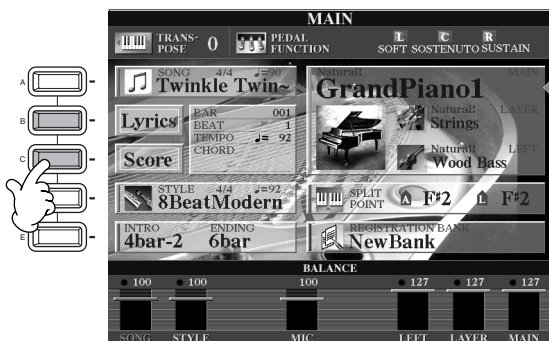

**NOTE**  
If the selected song does not contain lyric data, lyrics are not displayed.

▶ **7** Press the SONG [START/STOP] button and play the part.

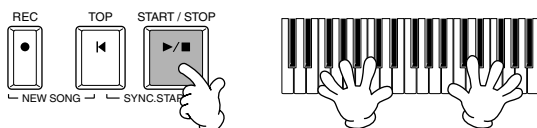

▶ **8** Press the SONG [START/STOP] button to stop playback.

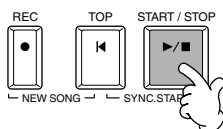

**NOTE**

- If you want to start the song right away without an intro, use the Sync Start function. To set Sync Start to standby, simultaneously hold down the [TOP] button and press the SONG [START/STOP] button. Song playback starts automatically the moment you start playing the melody.
- If you can hear the Clavinova playing the melody part as well, check the channel setting for the melody part in the song data, and change the channel assigned to Track 1 (page 137). You can also change the song channel itself permanently (page 105).

## Recording

The Clavinova lets you record, too — quickly and easily. Try out the Quick Recording feature now and capture your keyboard performance.

- ▶ **1-3** Select a voice for recording. Use the same operations as in “Playing a Voice” on pages 25, 26.
- ▶ **4** Press the [REC] and [TOP] buttons simultaneously to select “New Song” for recording.

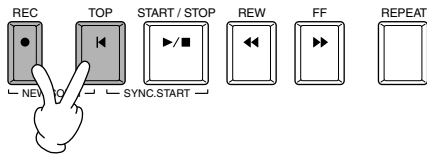

- ▶ **5** Simultaneously hold down the [REC] button and press the [TRACK1] button.

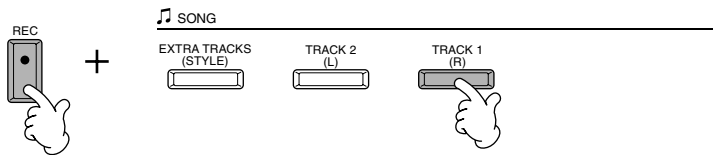

- ▶ **6** Recording starts as soon as you start playing the keyboard.

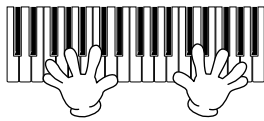

- ▶ **7** When you’ve finished recording, press the [REC] button.



- ▶ **8** To hear your newly recorded performance, return the song to the beginning by using the [TOP] button and press the SONG [START/STOP] button.

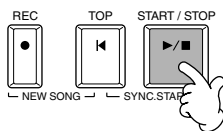

- ▶ **9** Save the recorded data as required (pages 39, 45).

**CAUTION**  
 The recorded data will be lost if you turn off the power. To keep your important recordings, you’ll need to save them to the User drive or floppy disk.

# Mastering Your Favorite Songs

The Clavinova has several very useful practice features that help learn and master recorded songs. Here, you'll try out the Follow Lights function, and use the special guide lamps to help you play the right notes.

- ▶ **1-6** Use the same operations as in "Playing Along with the Clavinova" on page 36.

For this example, you practice the right hand part of "Playing Along with the Clavinova."

- ▶ **7** Press the [GUIDE] button.



- ▶ **8** Press the SONG [START/STOP] button and practice the missing (muted) part, according to the key guide lamps.

If you want, you can adjust the tempo by pressing the TEMPO[◀] [▶] buttons.

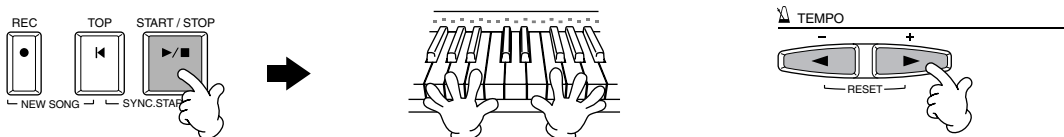

- ▶ **9** You can use the powerful Repeat function to practice and master difficult parts. Simply specify a short phrase you want to work on and repeat it until you've got it down.

- 1) While the song is playing back, press the [GUIDE] button once to turn the GUIDE function off.
- 2) Just before the desired phrase comes around, press the [REPEAT] button to designate the beginning point for Repeat.
- 3) Just after the phrase finishes, press the [REPEAT] button again to designate the end point.
- 4) Turn the GUIDE function on again.

- ▶ **10** Press the SONG [START/STOP] button to stop playback.

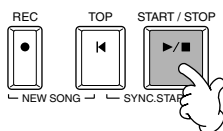

### NOTE

#### Before Practicing

Before starting a practice session, play back the entire song (without canceling any parts) and listen to it carefully. This will give you a clear idea of how the song should be played, and will make your practice sessions progress more smoothly. If you want to hear only the melody part, turn the [TRACK 2] and [EXTRA TRACKS] buttons off.

### NOTE

See pages 79 and 137 for more information on the Guide function.

# Basic Operations — Organizing Your Data

The CVP-209/207 utilizes a variety of data types — including voices, accompaniment styles, songs and registration memory settings. Much of this data is already programmed and contained in the CVP-209/207; you can also create and edit your own data with some of the functions on the instrument.

All this data is stored in separate files — just as is done on a computer.

Here, we'll show you how to use the basic operations of the display controls in handling and organizing the data of the CVP-209/207 in files and folders.

Files can be opened, saved, named, moved, or deleted in their respective Open/Save displays. You can select these displays according to their respective file types, as well: Song, Voice, Style, etc. Moreover, you can organize your data efficiently by putting various files of the same type into a single folder.

The Open/Save displays for Song, Voice, Style, and Registration Bank can be called up from the MAIN display (the display shown when the power is turned on) by pressing the appropriate [A] - [J] button.

## Open/Save display for Song (page 75)

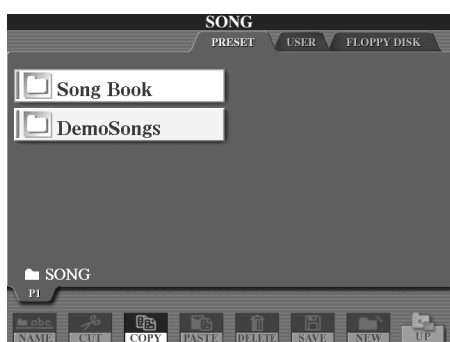

handles the Song files.

## Open/Save display for Voice (page 55)



handles the Voice files.



### NOTE

The following Open/Save display types are also available; however, these are selected from displays other than the MAIN display (page 151).

- SYSTEM SETUP
- MIDI SETUP
- USER EFFECT
- MUSIC FINDER
- MAIN PICTURE
- LYRICS BACKGROUND PICTURE (page 84)

### NOTE

If the MAIN screen is not displayed, press the [DIRECT ACCESS] button followed by the [EXIT] button.

## Open/Save display for Style (page 60)



handles the Style files.

## Open/Save display for Registration Bank (page 86)



handles the Registration Bank files.

## Example — Open/Save display for Voice

Each Open/Save display consists of PRESET, USER, and FLOPPY DISK drive pages.

### PRESET drive

The files that are pre-programmed and installed internally to the CVP-209/207 are kept here. Preset files can be loaded but cannot be re-written. However, you can use a preset file as a basis for creating your own original file (which can be saved in the USER or FLOPPY DISK drive).

### USER drive

Files kept here are those containing your own original data, created or edited using the various functions of the CVP-209/207. They are stored internally to the CVP-209/207.

### FLOPPY DISK drive

You can also store your original data to floppy disk. Commercially available disk software can also be called up here. Naturally, these files are available only when the appropriate disk is inserted in the floppy disk drive.

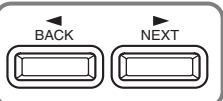
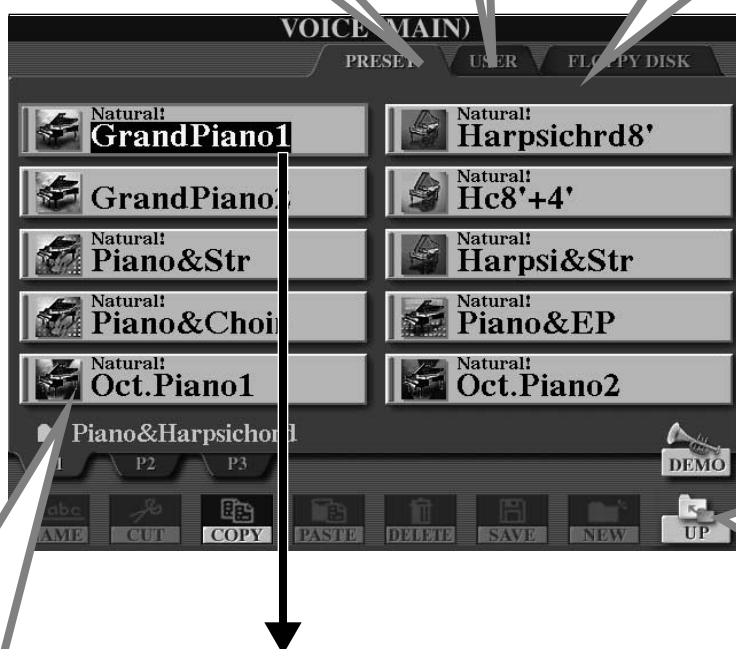

Changes drives among **PRESET, USER** and **FLOPPY DISK**.

Calls up the upper level directory page. In this example, the voice folder selection page can be called up.

### File

All data, both pre-programmed and your own original, are stored as "files."

### Current Memory

"Current Memory" is the area where the voice is called up when you select a voice. Also it is the area where you edit your voice using the SOUND CREATOR function. Your edited voice should then be saved as a file in the USER or FLOPPY DISK drive. Recording songs (page 94) and creating accompaniment styles (page 110) are done within the current memory. Please make sure to properly save this data to the USER/FLOPPY DISK drive as a file or files. The data will be lost if you turn off the power without saving.



# Selecting Files and Folders

Select a file shown in the display. In this example, we'll select a voice file.

First, press the VOICE [PIANO & HARPSI] button to call up the display containing the files.

This display ("Open/Save" display) is typical of those used to call up and store files (voice files).

The CVP-209/207 already contains a variety of voices in the PRESET section. You can store your own original voices created with the **Sound Creator** function to the **USER** or **FLOPPY DISK** section.

**1** Select "PRESET," "USER," or "FLOPPY DISK" by using the [BACK][NEXT] button.

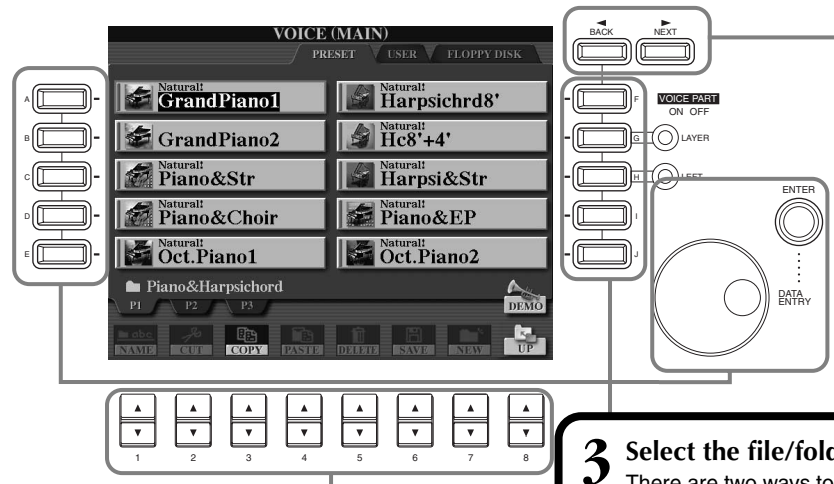

**NOTE**  
When "JAPANESE" is selected for the Language parameter (pages 50, 151), and you change this to one of the western languages, the kanji and kana characters of the file name stored in the disk drive are changed to western characters. In the opposite case, special Latin characters and marks are changed into normal characters. Also, in the case of floppy disk data, text in the files are changed to characters that cannot be read by the instrument. Keep in mind that similar problems may occur when trying to access files originating or edited by a computer having a different language operating system. In general, be careful when switching languages — you risk not being able to access the data properly.

**NOTE**  
Double-clicking the appropriate [A] -[J] button calls up the corresponding file and returns to the MAIN display.

**NOTE**  
Highlighting the desired file and double-clicking the [ENTER] button calls up the corresponding file and returns to the MAIN display.

**2** Use the [1▲] ~ [7▲] buttons to turn the pages.  
When the amount of available files or folders exceeds ten, the bottom of the display changes as shown below.

Press Prev.(previous)      Press Next

**3** Select the file/folder.  
There are two ways to select the file/folder:

- **Press the [A] - [J] button.**  
Press the letter button corresponding to the file/folder you wish to call up. (In the example display shown above, the voice files are shown.)
- **Use the [DATA ENTRY] dial and the [ENTER] button.**  
When you turn the [DATA ENTRY] dial, the highlight moves among the available file/folders. Highlight the desired file or folder (voice files are shown in the example above) and press the [ENTER] button to call up the selected item.

**END** Press the [EXIT] button to go back to the MAIN display.  
You can go back to the previous display by pressing the [EXIT] button.

**Exiting from small pop-up windows**  
You can also exit from small pop-up windows (such as in the illustration below) by pressing the [EXIT] button.

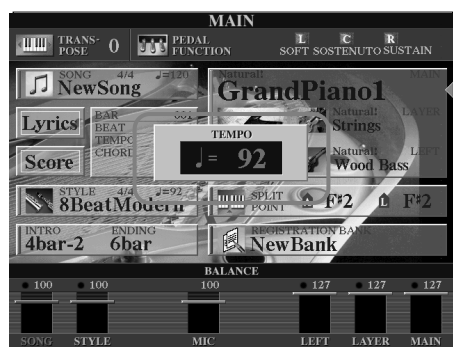

# File/Folder-related Operations

## Naming Files/Folders

You can assign names to files and folders. Any file/folder in the **USER** and **FLOPPY DISK** sections can be named or renamed. Execute the following steps when there is data in the User drive. If there are Preset files/folders you wish to rename, copy them beforehand (page 44) and use them as User files/folders.

**1 Press the [1▼] (NAME) button (page 39).**  
The **NAME** display appears.



**NOTE**  
A file/folder name can contain up to 50 half size letters (or 25 Hiragana and kanji letters), including the Icon ID (see the note below) and the extension.

**2 Select the appropriate file/folder and press the [7▼] (OK) button.**  
The currently selected file/folder is highlighted. To select another file/folder, press one of the [A] - [J] buttons.

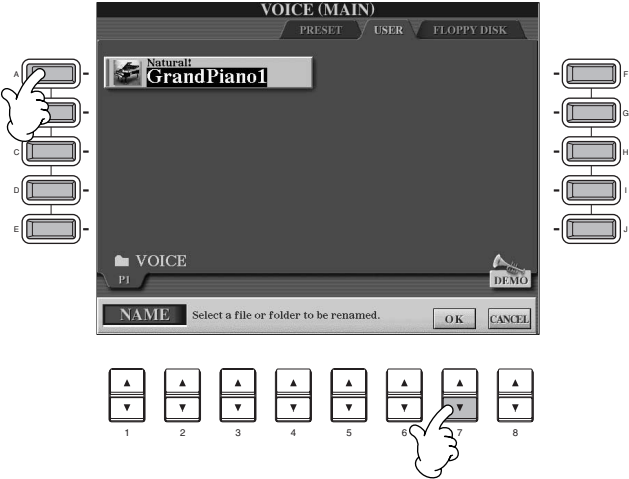

**NOTE**  
The file name will appear on your computer as follows. If you change the Icon ID or the extension, the icon may not be properly recognized.

**ABCDE.S002.MID**

ABCDE	S002	MID
File ID	Icon ID	Extension

**END**

**Input the new name (page 46).**



**Press the [8▲] (OK) button. To cancel, press the [8▼] (CANCEL) button.**

## Moving Files/Folders

You can move files and folders as desired, for organizing your data. Any file/folder in the **USER** and **FLOPPY DISK** sections can be moved, using the cut-and-paste operation described below.

- 1 Press the [2▼] (CUT) button (page 39).  
The CUT display appears.

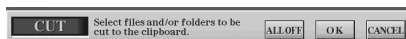

- 2 Select the desired file/folder for moving.

Select the appropriate file/folder and press the [7▼](OK) button. The currently selected file/folder is highlighted. To select another file/folder, press one of the [A] - [J] buttons.  
Several files/folders can be selected together, even those from other pages. To release or cancel the selection, press the button of the selected file/folder again.  
Press the [6▼] (ALL) button to select all the files/folders in the displayed page (USER/FLOPPY DISK). When the [6▼] (ALL) button is pressed the [6▼] button changes to "ALL OFF" button to release or cancel the selection.

- 3 Press the [7▼] (OK) button.

To stop the operation, press the [8▼] (CANCEL) button.

- 4 Call up the destination display.

Only the USER and FLOPPY DISK pages can be selected as the destination.



- Press the [4▼] (PASTE) button.

The file/folder you cut is now pasted at the destination.

### NOTE

This operation cannot be used to directly move a file/folder from one floppy disk to another. If you want to do this, cut and paste the file or folder from the first floppy disk to the USER page, then change disks and paste it to the FLOPPY DISK page.

### NOTE

All files/folders in a floppy disk can be copied to another disk in one batch (page 150).

### NOTE

After being pasted, the files are automatically re-ordered in alphabetical order and displayed.

### NOTE

#### About files/folders in a floppy disk

In the FLOPPY DISK page of the Open/Save display, only the files which can be handled in that Open/Save display will appear — even though a folder in a floppy disk can contain different kinds of files.

In the case of a folder cut-and-paste operation (for floppy disk), an entire folder can be cut; however, only the specific files which can be handled in the current Open/Save display will be pasted.

## Copying Files/Folders

You can also copy files and folders as desired, for organizing your data. Any file/folder in the **PRESET**, **USER** and **FLOPPY DISK** sections can be copied, using the copy-and-paste operation described below.

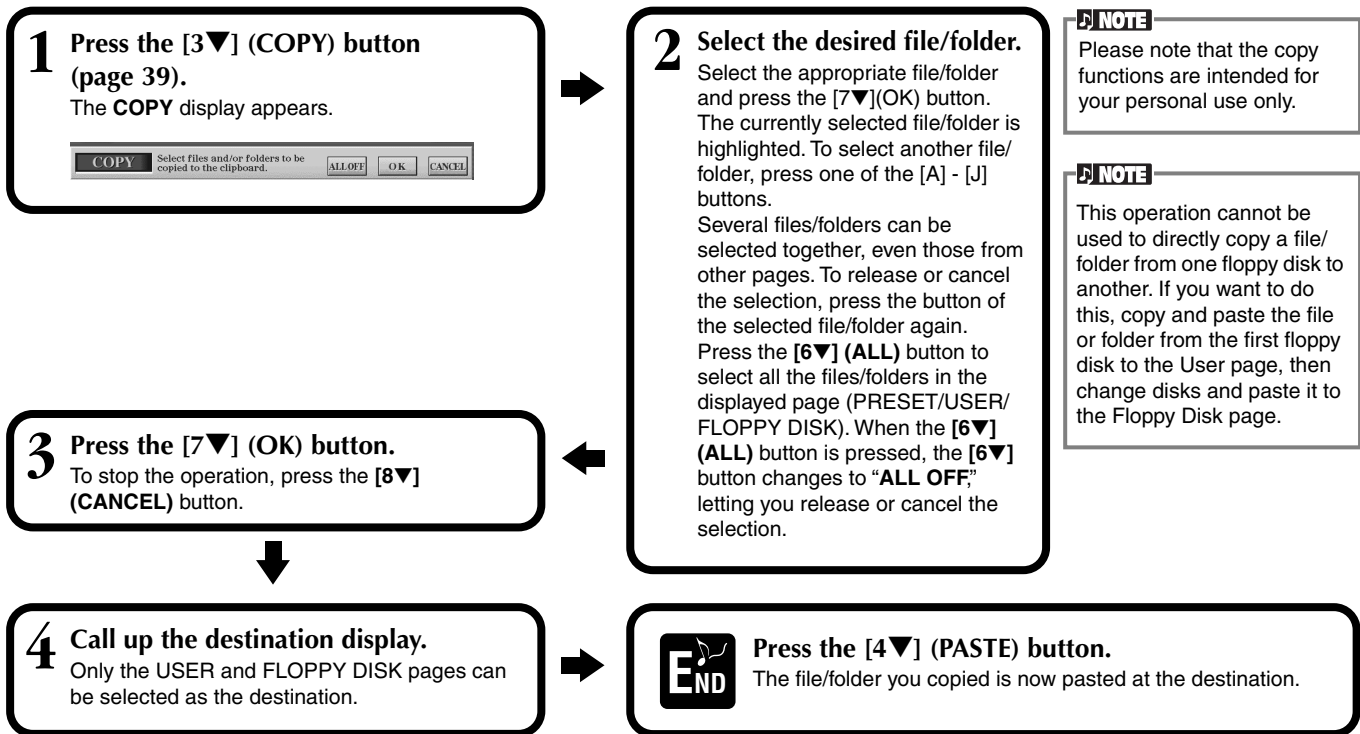

## Deleting Files/Folders

You can also delete files and folders as desired, for organizing your data. Any file/folder in the **USER** and **FLOPPY DISK** sections can be deleted, using the operation described below.

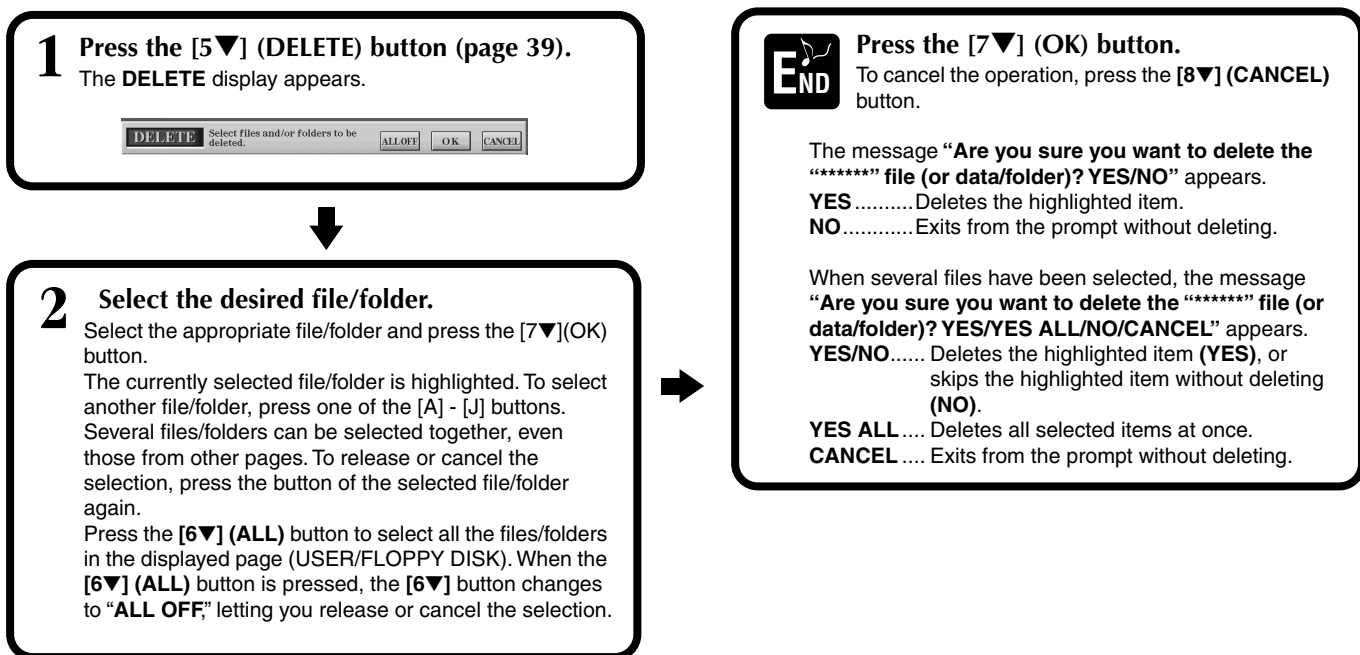

## Saving Files

This operation lets you save the data (such as song and voice) you created in current memory (page 40) to files. The files can be saved only to the **USER** and **FLOPPY DISK** drives.

If the Open/Save display for the type of data you wish to save is not shown, first return to the MAIN display by pressing the **[DIRECT ACCESS]** button followed by the **[EXIT]** button. Then, press the appropriate button **[A]–[J]** from the MAIN display to call up the respective Open/Save display. Finally, call up the **USER** or **FLOPPY DISK** page (pages 39, 40).

1 Press the **[6▼]** (SAVE) button.

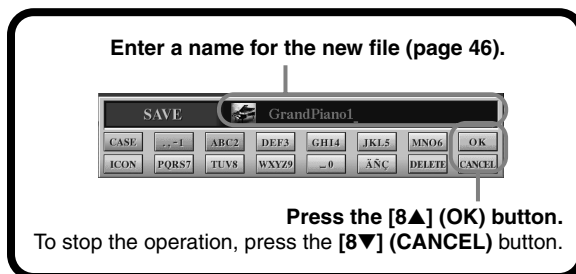

### NOTE

The internal memory capacity of the Clavinova is about 3.3MB. Memory capacity for 2DD and 2HD floppy disks is about 720KB and 1.44MB, respectively. When you store data to these locations, all file types of the Clavinova (Voice, Style, Song, Registration, etc.) are stored together.

### NOTE

The files of commercially available DOC software and Yamaha Disklavier software, and their edited files on the CVP-209/207, can be stored in the USER page, but cannot be copied to another floppy disk.

## Organizing Files by Creating a New Folder

This operation lets you easily organize your various files into categories by creating a new folder for each category. Folders can only be created in the **USER** and **FLOPPY DISK** sections.

1 Call up the page to which you wish to create a new folder and press the **[7▼]** (NEW) button (page 39).

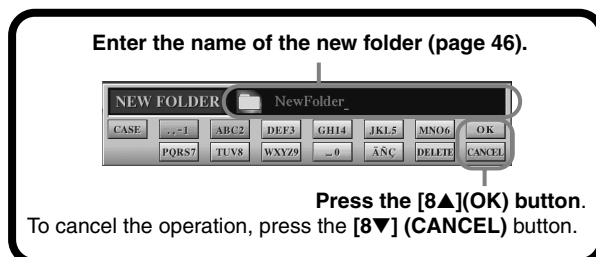

### NOTE

Folder directories can contain up to four levels. The maximum total number of files and folders which can be stored is 3,200, but this may differ depending on the length of the file names. The maximum number of files which can be stored in a folder will be 250.

## Displaying Upper Level pages

Press the **[8▼]** (UP) button to call up the upper level pages. For example, you can call up the folder level pages from the file level pages.

## Entering Characters and Changing Icons

1 Press the **[1▼]** (NAME), **[6▼]** (SAVE), or **[7▼]** (NEW) button (page 39).



### Change the type of character by using the **[1▲]** button.

If you select Japanese as the Language in the **FUNCTION** display (page 151), the following different types of characters and sizes can be entered:

かな漢 (kana-kan)  
Hiragana and kanji, marks (full size)  
カナ (kana)  
Katakana (normal size), marks (full size)  
か (kana)  
Katakana (half size), marks (half size)

**A B C** — Alphabet (capital and small letters, full size), numbers (full size), marks (full size)  
**ABC** — Alphabet (capital and small letters, half size), numbers (half size), marks (half size)

If you've selected a language other than Japanese in the **FUNCTION** display (page 151), the following types of characters are available:

**CASE** — Alphabet (capital letters, half size), numbers (half size), marks (half size)  
**case** — Alphabet (lowercase letters, half size), numbers (half size), marks (half size)



Call up the **ICON SELECT** display by pressing the **[1▼]** button. This lets you change the icon at the left of the file name.

## Entering Characters

The instructions that follow show you how to enter characters in naming your files and folders. The method is much the same as inputting names and numbers to your cell phone.

- 1** Move the cursor to the desired position by using the [DATA ENTRY] dial.
- 2** Press the appropriate button, [2▲] - [7▲] and [2▼]- [6▼], corresponding to the character you wish to enter. Several different characters are assigned to each button, and the characters change each time you press the button. To actually enter the selected character, move the cursor or press another letter-input button. If you've entered a character by mistake, move the cursor to the character letter you wish to erase and press the [7▼] (DELETE) button. If you want to delete all of the characters on the line at once, press and hold down the [7▼] (DELETE) button for a while, or press the [8▼] (CANCEL) button. When the cursor appears in reverse display (highlight), only the reversed area is deleted.
- 3** To actually enter the new name, press the [8▲] (OK) button. To cancel the operation, press the [8▼] (CANCEL) button.

### NOTE

The following half-size marks cannot be used in naming files and folders:  
¥ \ / : \* ? " < > |

### ■ Converting into Kanji (Japanese language)

This applies only if you are using the “かな漢 (kana-kan)” button (in Japanese). When the input “hiragana” characters are shown in reverse display (highlighted), press the [ENTER] button one or several times to convert the characters into the appropriate kanji. The reversed area can be changed by the [DATA ENTRY] dial. The converted area can be changed back to “hiragana” by the [7▼] (DELETE) button. The reversed area can be cleared at once by the [8▼] (CANCEL) button. To actually enter the change, press the [8▲] (OK) button or enter the next character. To enter the “hiragana” itself (without converting it), press the [8▲] (OK) button.

### ■ Entering special character marks (umlaut, accent, Japanese “ゝ” and “ゝ”)

Select a character to which a character mark is to be added and press the [6▼] button (before actual entry of the character.)

### ■ Entering miscellaneous characters (marks)

You can call up the mark list by pressing the [6▼] button, after actually entering a character by moving the cursor.



Move the cursor to the desired mark by using the [DATA ENTRY] dial, then press the [8▲] (OK) or [ENTER] button.

### NOTE

In the case of characters which are not accompanied by special character marks (with the exception of kana-kan and half-size katakana), you can call up the mark list by pressing the [6▼] button after selecting a character (before actual entry of a character).

### ■ Entering numbers

First, select one of the following: “A B C” (full-size alphabet), “ABC” “CASE” (half-size capital alphabet) and “case” (half-size lowercase alphabet). Then, press and hold down the appropriate button, [2▲] - [7▲] and [2▼] - [5▼], for a while, or press it repeatedly until the desired number is selected.

## Changing the Icon

You can also change the icon that appears at the left of the file name. Call up the **ICON SELECT** display by pressing the [1▼] (**ICON**) button from the character input display (page 46).

Select the desired icon by using the [A] - [J] buttons, or by using the [3▲▼] - [5▲▼] buttons, then enter the selected icon by pressing the [8▲] (**OK**) button.

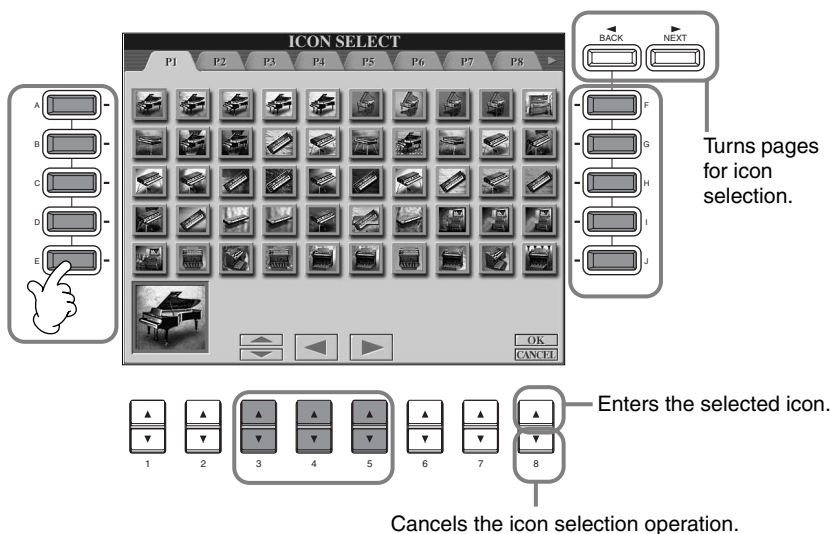

## Using the [DATA ENTRY] Dial

This convenient control lets you easily select items in the display or quickly change parameter values. The actual function of the [DATA ENTRY] dial differs depending on the selected display.

### ■ Adjusting values

You can change parameter values by rotating the [DATA ENTRY] dial. In the example [BALANCE] display, turning the dial adjusts the volume of the part in reverse display (highlight). To adjust the volume of another part, first select the part by pressing the [▲▼] button corresponding to the part, then rotate the [DATA ENTRY] dial.

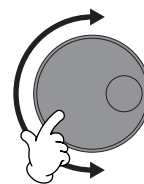
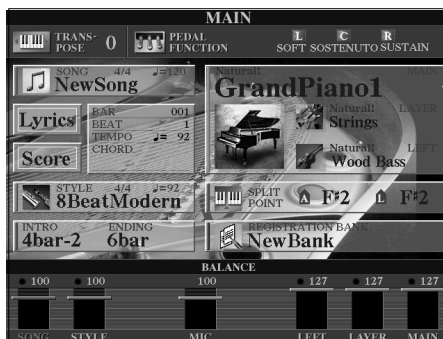

### ■ Selecting items

You can select the desired item or function in the display by rotating the [DATA ENTRY] dial. The selected item can then be called up or executed by using the [ENTER] button.

In the example **VOICE** display, you can select the desired voice file with the [DATA ENTRY] dial, and call up the selected item by pressing the [ENTER] button on the panel.

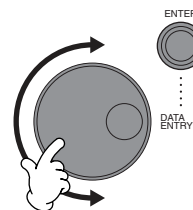

# Direct Access — Instant Selection of Displays

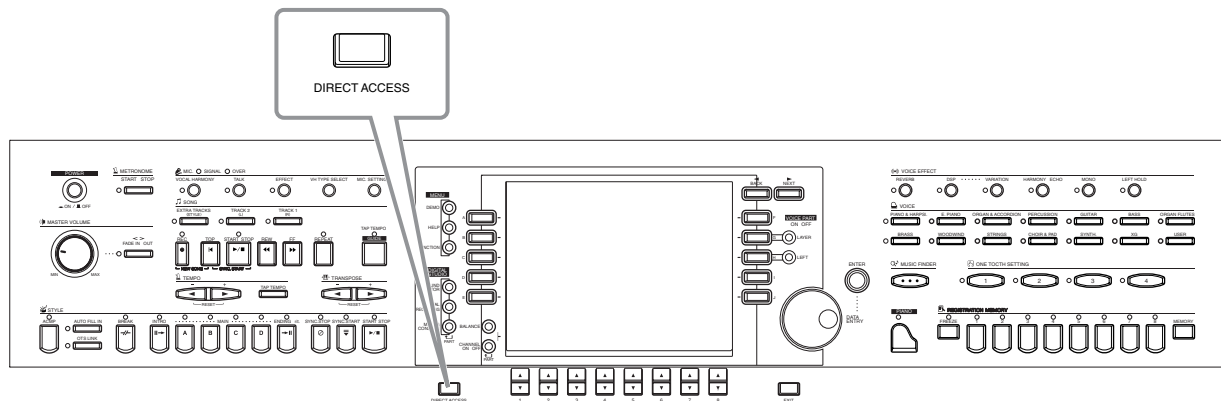

With the convenient Direct Access function, you can instantly call up the desired display — with just a single additional button press. Press the **[DIRECT ACCESS]** button and a message appears in the display prompting you to press the appropriate button. Then, simply press the button corresponding to the desired setting display to instantly call up that display. In the example below, Direct Access is used to call up the display for selecting the **Chord Fingering** (page 139).

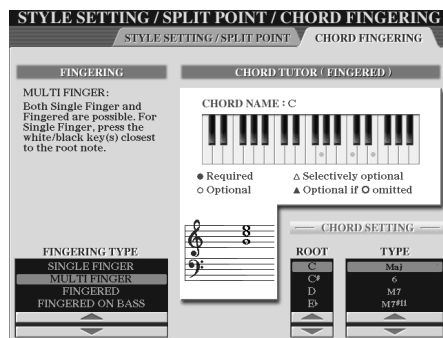
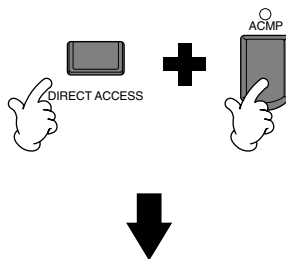

Refer to the Direct Access Chart (page 49) for a list of the displays that can be called up with the Direct Access function.

**NOTE**  
Here's a convenient way to return to the **MAIN** display from any other display: Simply press the **[DIRECT ACCESS]** button, then the **[EXIT]** button.



Direct Access Chart

Operation: [DIRECT ACCESS] button + button listed below		Corresponding LCD display and function			See pages	
STYLE	[ACMP]	FUNCTION	CHORD FINGERING	FINGERING TYPE selection	139	
	[BREAK]	MIXING CONSOLE (STYLE PART)	VOLUME/VOICE	VOICE settings	121	
	[INTRO]			PANPOT settings		
	MAIN [A]			VOLUME settings		
	MAIN [B]		FILTER	HARMONIC CONTENT settings	122	
	MAIN [C]			BRIGHTNESS settings		
	MAIN [D]	FUNCTION	EFFECT	REVERB settings	123	
	[ENDING]			CHORUS settings		
	[AUTO FILL IN]			DSP settings		
	[OTS LINK]	FUNCTION	STYLE SETTING/SPLIT POINT	SYNC. STOP WINDOW setting	138	
[SYNC. STOP]						
[SYNC. START]						
[START/STOP]						
SONG	[TRACK1]	FUNCTION	SONG SETTING	TRACK1 CHANNEL selection	137	
	[TRACK2]			TRACK2 CHANNEL selection		
	[EXTRA TRACKS]					
	[REPEAT]					
	[GUIDE]			GUIDE MODE selection		
	[REC]					
	[TOP]					
	[START/STOP]					
	[REW]					
	[FF]					
METRONOME	[START/STOP]	FUNCTION	UTILITY	METRONOME settings	148	
[FADE IN/OUT]				FADE IN/OUT settings		
TEMPO	[TAP TEMPO]			TAP settings		
	[◀]		MIDI	MIDI CLOCK setting	146	
	[▶]		CONTROLLER	TRANSPOSE assignment	141	
TRANSPOSE	[◀]	MIXING CONSOLE	TUNE	TRANSPOSE settings	122	
	[▶]					
MENU	[DEMO]	FUNCTION	UTILITY	LANGUAGE selection	151	
	[HELP]			LCD BRIGHTNESS settings	149	
	[FUNCTION]		MIDI	MIDI settings	145	
DIGITAL STUDIO	[SOUND CREATOR]	MIXING CONSOLE	MASTER TUNE/SCALE TUNE	MASTER TUNING setting	135	
	[DIGITAL RECORDING]			SCALE TUNING setting		
	[MIXING CONSOLE]		EQ settings	125		
[BALANCE]		MIXING CONSOLE (SONG PART)	VOLUME/VOICE	VOLUME settings	121	
[CHANNEL ON/OFF]				VOICE settings		
[DIRECT ACCESS]		Exit from the Direct Access mode				
[NEXT]						
[BACK]						
[ENTER]						
[EXIT]		Return to the MAIN display				
VOICE PART	[LAYER]	MIXING CONSOLE	TUNE	OCTAVE settings	122	
	[LEFT]					
VOICE EFFECT	[REVERB]		EFFECT		REVERB settings	123
	[DSP]				DSP settings	
	[VARIATION]			EFFECT TYPE selection		
	[HARMONY/ECHO]	FUNCTION	HARMONY/ECHO		143	
	[MONO]	MIXING CONSOLE	TUNE	PORTAMENTO TIME settings	122	
	[LEFT HOLD]		STYLE SETTING/SPLIT POINT	SPLIT POINT (LEFT) setting	138	
VOICE	[PIANO & HARPSI]	FUNCTION	VOICE SET		143	
	[E.PIANO]					
	[ORGAN & ACCORDION]					
	[PERCUSSION]					
	[GUITAR]					
	[BASS]					
	[BRASS]					
	[WOODWIND]					
	[STRINGS]					
	[CHOIR & PAD]					
	[SYNTH.]					
	[XG]					
	[USER]					
	ORGAN FLUTES	MIXING CONSOLE	EQ settings	125		
[MUSIC FINDER]		MUSIC FINDER	MUSIC FINDER SEARCH1 (Searching the records)	71		
ONE TOUCH SETTING	[1]					
	[2]					
	[3]					
	[4]					
MIC.	[VOCAL HARMONY]	MIXING CONSOLE	EFFECT	MIC. REVERB setting	123	
	[TALK]	MIC. SETTING	TALK SETTING		132	
	[EFFECT]	MIXING CONSOLE	EFFECT	MIC. DSP setting	123	
	[VH TYPE SELECT]	VOCAL HARMONY	VOCAL HARMONY EDIT (Editing the VOCAL HARMONY parameters)		128	
		MIXING CONSOLE	EFFECT	MIC. EFFECT TYPE selection	123	
[PIANO]						
REGISTRATION MEMORY	[FREEZE]	FUNCTION	CONTROLLER	KEYBOARD TOUCH selection	141	
			FREEZE		142	
	[1]	REGISTRATION BANK	REGISTRATION EDIT (Editing the REGISTRATION)		86	
	[2]					
	[3]					
	[4]					
	[5]					
	[6]					
	[7]					
	[8]					
	[MEMORY]		REGISTRATION SEQUENCE (Creating the REGISTRATION SEQUENCE)		142	
PEDAL	RIGHT	FUNCTION	CONTROLLER	RIGHT PEDAL function assignment	139	
	CENTER			CENTER PEDAL function assignment		
	LEFT			LEFT PEDAL function assignment		
	AUX			AUX PEDAL function assignment		

# Help Messages

The Help messages give you explanations and descriptions of all the main functions and features of the CVP-209/207.

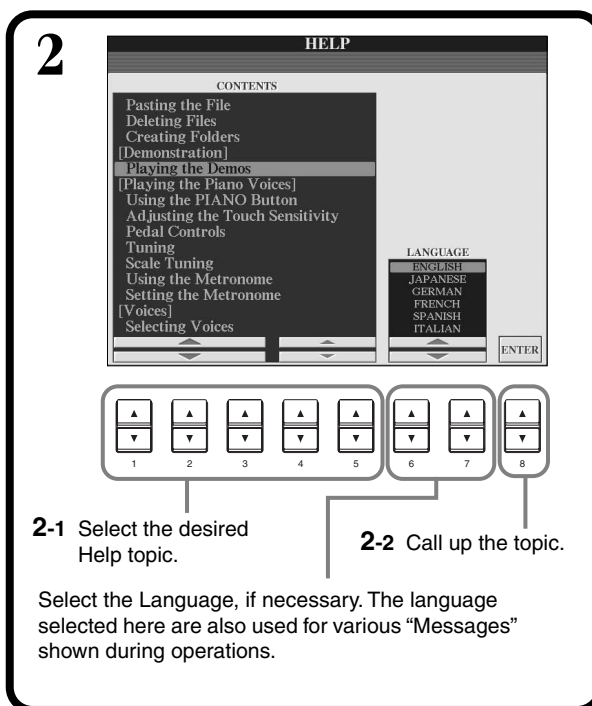
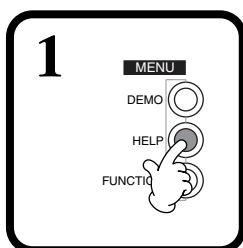
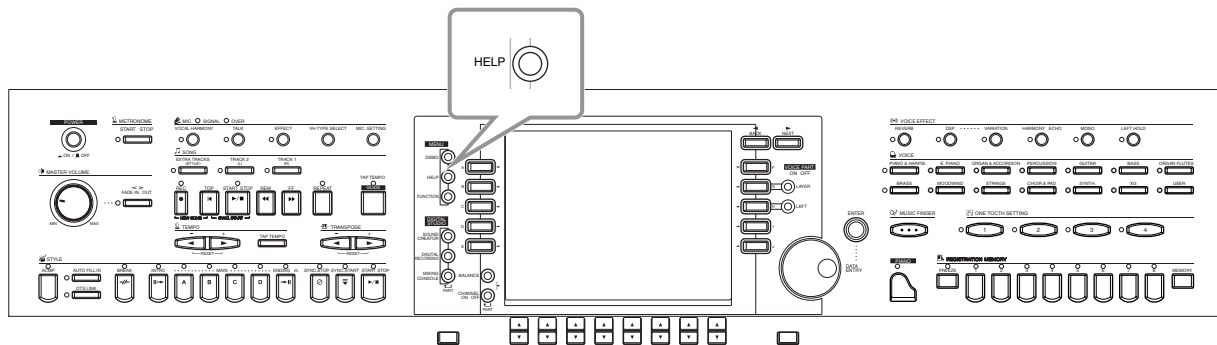

**NOTE**

Help messages can be displayed in any one of the following languages:

ENGLISH  
JAPANESE  
GERMAN  
FRENCH  
SPANISH  
ITALIAN

**NOTE**

The language can also be selected in the FUNCTION "LANGUAGE" (page 151) display.

**NOTE**

When "JAPANESE" is selected for the Language parameter, and you change this to one of the western languages, the kanji and kana characters of the file name stored in the disk drive are changed to western characters. In the opposite case, special Latin characters and marks are changed into normal characters. Also, in the case of floppy disk data, text in the files are changed to characters that cannot be read by the instrument.

Keep in mind that similar problems may occur when trying to access files originating or edited by a computer having a different language operating system. In general, be careful when switching languages — you risk not being able to access the data properly.

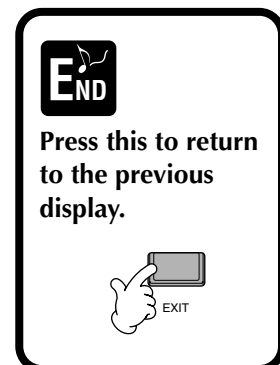
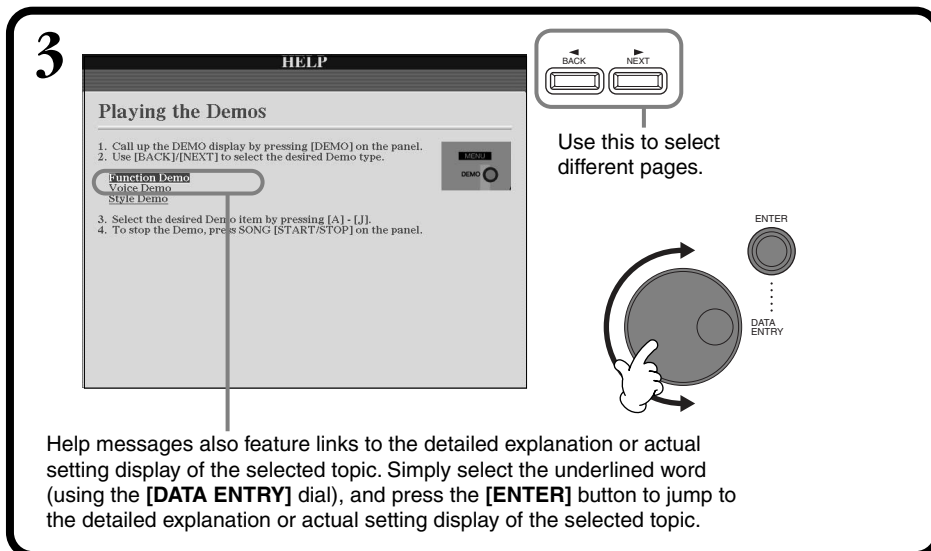

## Using the Metronome

The **metronome** provides a click sound, giving you an accurate tempo guide when you practice, or letting you hear and check how a specific tempo sounds.

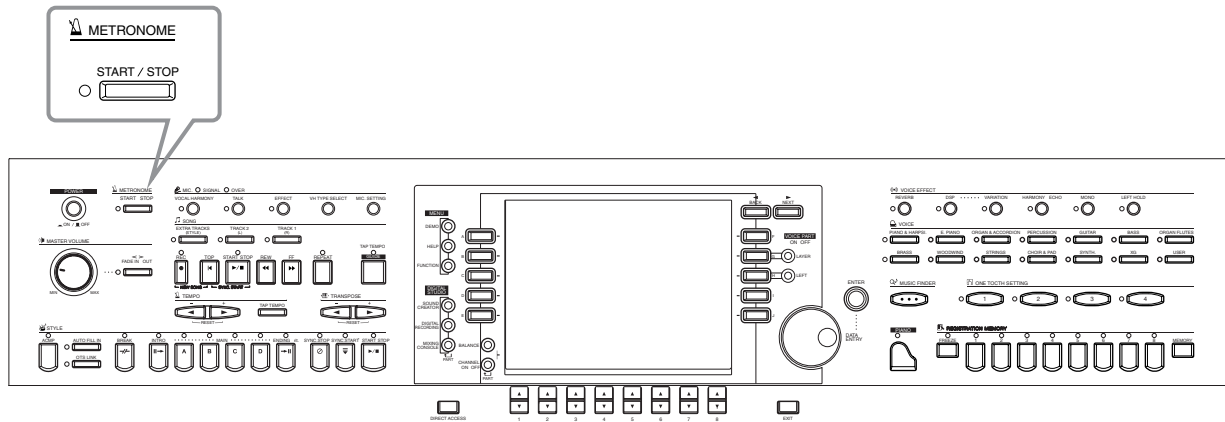

The **metronome** starts by pressing the METRONOME [START/STOP] button. Adjust the tempo by using the TEMPO [◀] [▶] buttons (see below). To stop the **metronome**, press the [START/STOP] button again.

### NOTE

The sound, volume level, and the beat (time signature) of the metronome can all be changed (page 148).

## Adjusting the Tempo

This section shows you to adjust the playback tempo — which not only affects the metronome, but also the playback of a song or an accompaniment style.

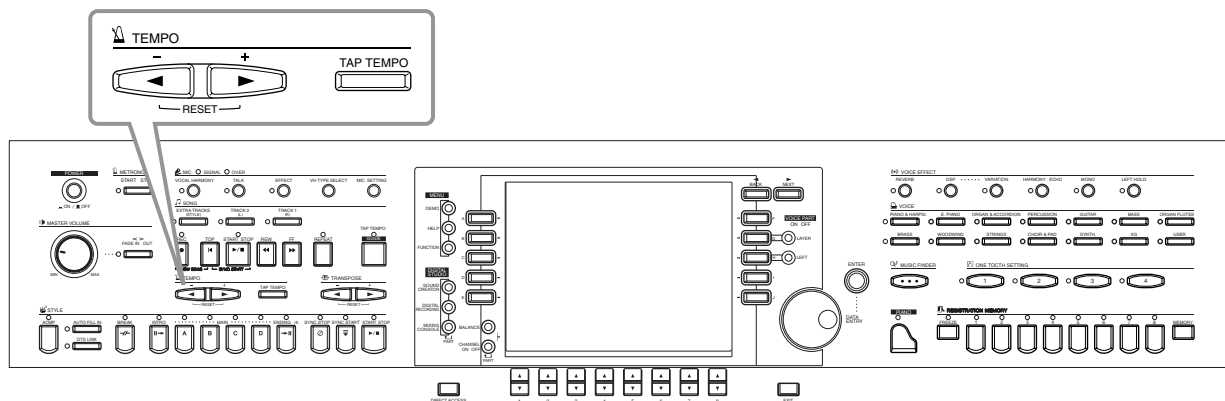

### NOTE

Songs and accompaniment styles have been given default (initial) tempo settings, designed to best suit the song/style.

**1**

Press either the TEMPO [◀] button or the [▶] button.

**END** Press this to close the TEMPO display. **EXIT**

**2**

Adjust the tempo by using either the TEMPO [◀] [▶] buttons or the [DATA ENTRY] dial. The number in the display indicates how many quarter-note beats there are in one minute. The range is between 5 and 500. The higher the value, the faster the tempo.

When you change the tempo, both tempos of the current song and style will be changed to the same tempo. To restore their respective default (initial) tempo settings, press both the TEMPO [◀] [▶] buttons simultaneously. Also refer to the “Tempo Indications — MAIN display” (page 52) for more about tempo.

## Tap Tempo

This useful feature lets you tap out the tempo for a song or an accompaniment style. Simply tap the **[TAP TEMPO]** button at the desired speed, and the tempo of the song or the accompaniment style changes to match your tapping.

**1** Playback the song or the accompaniment style (page 60, 75).

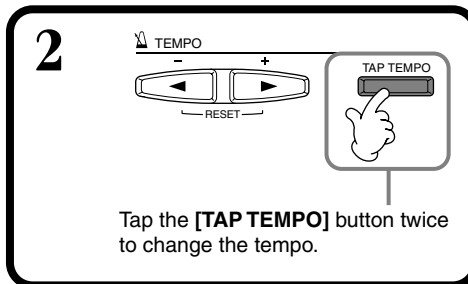

**NOTE**  
Hitting the **[TAP TEMPO]** button produces a tapping sound. You can change this sound, if desired (page 149).

**NOTE**  
You can also use Tap Tempo to automatically start the song or accompaniment style at the desired tempo. While both the song and accompaniment style are stopped, tap the **[TAP TEMPO]** button several times, and the selected accompaniment style starts automatically at the tempo you tapped. While a song is set to Sync. Start stand-by (page 61, 75), tapping the **[TAP TEMPO]** button starts the song playback in the same manner. For songs and styles in 2/4 and 4/4 time, tap four times; for 3/4 time, tap three times; for 5/4 time, tap five times.

### Tempo Indications — MAIN Display

There are three different tempo indications in the Main display, as shown below.

Indicates the default (initial) tempo setting for the currently selected song (unless the tempo has been changed manually).

Indicates the current tempo for the selected song, accompaniment style or the metronome which is now playing back. When nothing is playing back (stopped), this indicates the tempo for the selected style. When the song and style are played back simultaneously, the tempo of the style is automatically changed to match the tempo of the song, and is displayed here. This tempo is used for recording when recording a song or accompaniment style.

Indicates the default (initial) tempo setting for the currently selected accompaniment style (unless the tempo has been changed manually).

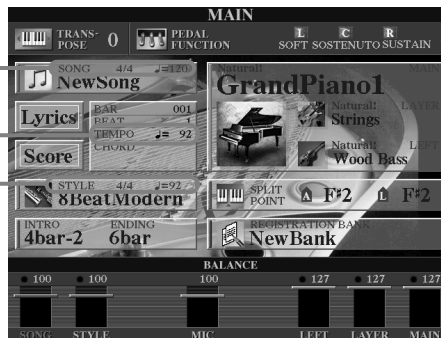

# Playing the Demos

The CVP-209/207 is an extraordinarily versatile and sophisticated instrument, featuring a wide variety of dynamic voices and rhythms, plus a wealth of advanced functions. Three different types of Demo songs have been specially prepared showcasing the stunning sound and features of the CVP-209/207.

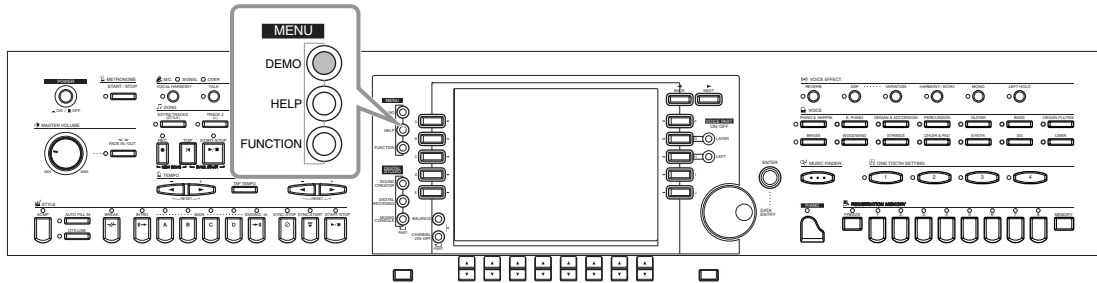

**1** Pressing the [DEMO] button automatically plays back the Demo songs at random.



**2**

**2-1 Use the [BACK][NEXT] buttons to select the desired Demo category.**  
**Function Demos** ..... These demonstrate each of the different functions on the CVP-209/207.  
**Voice Demos** ..... These showcase the voices of the CVP-209/207.  
**Style Demos** ..... These introduce you to the rhythms and accompaniment styles of the CVP-209/207.

**2-2 Use these to select different display pages.**

**2-3 Press one of these buttons twice — once to select the desired demo, and once again to start it.**

**Press this to play back all Demo songs/items continuously, starting from the first item at the top left of the display. This is available only from the FUNCTION page.**  
 All of the available demos are played back in sequence, starting from the one at top left. The **VOICE** and **STYLE** pages do not have the [AUTO] button; however, all demo songs are played back in sequence.  
 Pressing this button cancels the interactive features of the Function Demos (otherwise available in step 3 below).



**3** For the Function demos, an introduction screen appears in the display and the Demo starts playing.

This example shows the Voices in the FUNCTION demo.

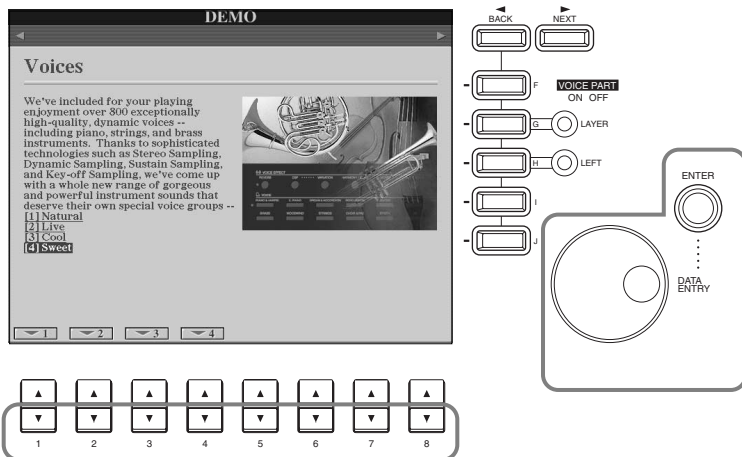

Select the desired word or item by using the [DATA ENTRY] dial, then press the [ENTER] button or number buttons ([1▼],[2▼],etc.) to call it up.

**NOTE**  
Use the [BACK][NEXT] buttons in the introduction screen to call up the previous or next page.

**NOTE**  
Press the SONG [START/STOP] button to stop the Demo song. To start the Demo again from the point at which it was stopped, press the SONG [START/STOP] button again. Rewind and fast-forward can also be used with the Demo songs (page 77).



**4** Relevant explanations are shown in the display.

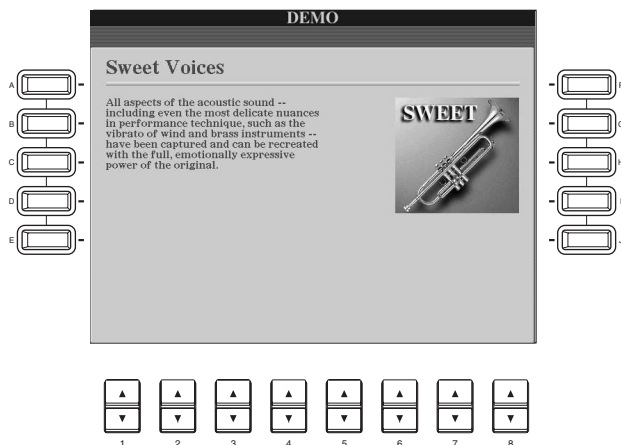



**Return to the MAIN screen.**

# Voices

The CVP-209/207 gives you an enormous selection of authentic voices, including various keyboard instruments, strings and brass — and many, many more.

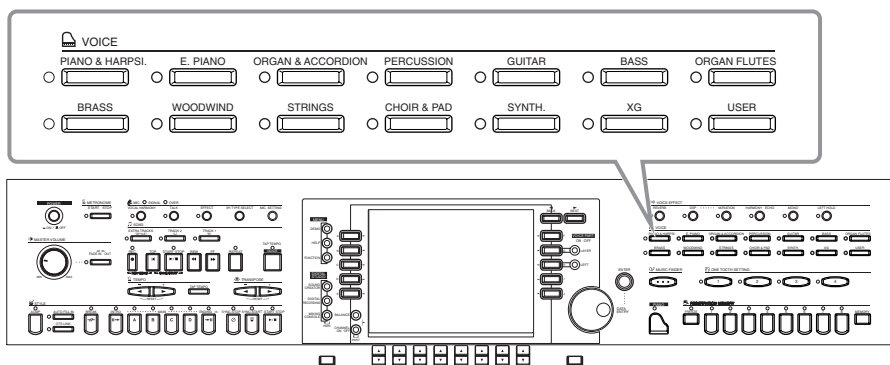

## Selecting a Voice

**1** Select the desired voice group.

**NOTE**  
When you select a voice group, the last selected voice will automatically be selected.

**NOTE**  
Selecting a voice automatically selects the best-suited effect and other settings for that particular voice. You can disable this so that settings are not automatically selected (page 143).

**NOTE**  
You can set how much the volume of the voice changes according to your playing strength (page 141).

**NOTE**  
For a list of the available voices, refer to the separate Data List.

**NOTE**  
You can set whether the voice bank and program change numbers ("MSB-LSB-Program Change number" at the right above the voice name) are displayed or not (page 149).

**NOTE**  
**XG** is a major enhancement of the GM System level 1 format, and was developed by Yamaha specially to provide more voices and variations, as well as greater expressive control over voices and effects, and to ensure compatibility of data well into the future.

**2** Indicates that the display is for selecting the MAIN voice (page 25).

**2-1** Select the memory location of the voice (PRESET/USER/FLOPPY DISK).

**2-2** Select the various pages in the current voice group.

**2-3** Select the voice.

Press this to call up the display for selecting the voice group.

Press this to start the demo of the selected voice. To stop the demo at any time, press this button again.

**3** Play the keyboard to hear the selected voice.

Press this to return to the MAIN display.

**Voice Characteristics**

The voice type and its defining characteristics are indicated above the voice name.

**Natural!**

These rich and luscious voices are comprised mostly of keyboard instrument sounds and are especially intended for playing piano and other keyboard parts. Since they use a completely independent sound source, you can play full, sustained chords — even along with the accompaniment style — and not have to worry about notes cutting off. They also take full advantage of Yamaha's advanced sampling technology such as Stereo Sampling, Dynamic Sampling, Sustain Sampling, and Key-off Sampling.

**Live!**

These acoustic instrument sounds were sampled in stereo, to produce a truly authentic, rich sound — full of atmosphere and ambience.

**Cool!**

These voices capture the dynamic textures and subtle nuances of electric instruments — thanks to a huge amount of memory and some very sophisticated programming.

**Sweet!**

These acoustic instrument sounds also benefit from Yamaha's sophisticated technology — and feature a sound so finely detailed and natural, you'll swear you're playing the real thing!

**Drum**

Various drum and percussion sounds are assigned to individual keys, letting you play the sounds from the keyboard.

**SFX**

Various special effect sounds are assigned to individual keys, letting you play the sounds from the keyboard.

**Live!Drums**

These are high-quality drum sounds taking full advantage of Stereo Sampling and Dynamic Sampling.

**Organ Flutes!**

This authentic organ voice lets you use the Sound Creator to adjust the various footages and craft your own original organ sounds.

**Live! SFX**

These are high-quality Latin percussion sounds taking full advantage of Stereo Sampling and Dynamic sampling. They give you a broader and more versatile range of Latin percussion than the normal drum voices.

**Keyboard Percussion**

When one of the drum or SFX kits is selected in the PERCUSSION voice group, various drum, percussion, and special effect sounds are assigned to individual keys, letting you play the sounds from the keyboard. The various drums and percussion instruments of the Standard Kit are indicated by symbols above the assigned keys. Keep in mind that even though different kits feature different sounds, some same-named sounds in different kits are identical.

Refer to the separate Data List (Drum/key Assignment List) for a listing of the sounds in each drum/SFX kit.

## One-touch Piano Play

This convenient, easy-to-use feature completely and automatically reconfigures the entire CVP-209/207 for optimum piano performance. No matter what settings you've made from the panel, you can instantly call up the piano settings by a single button press.

**PIANO button**

This reconfigures all of the panel settings for playing the CVP-209/207 as a piano.

**NOTE**

You can also use the metronome with this function (page 51).

**Piano Lock function**

The convenient Piano Lock function lets you "lock" the piano so that you don't inadvertently change the settings by pressing another button on the panel. Once locked, the CVP-209/207 stays in the piano mode, even if other buttons are pressed — preventing you from accidentally starting a song or accompaniment style during a piano concert.

**Hold down the [PIANO] button for a short time, until a message appears prompting you to enable Piano Lock.**

**To enable Piano Lock, select "OK."**

**To turn Piano Lock off, hold down the [PIANO] button again for a short time.**

**NOTE**

Even if you turn Piano Lock off, the piano settings are still active.



# Layer/Left — Playing Several Sounds Simultaneously

The CVP-209/207 lets you set three voices for simultaneous play: MAIN, LAYER, and LEFT. By effectively combining these three, you can create richly textured, multi-instrument setups for your performance.

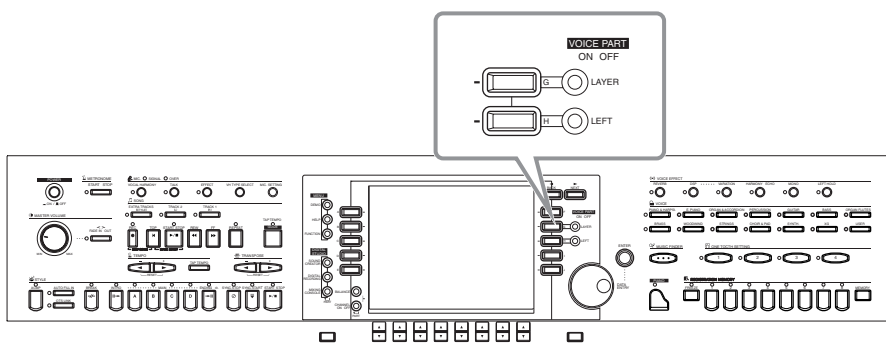

Playing a layer of two voices



Playing two voices separately — on the left and right sections of the keyboard

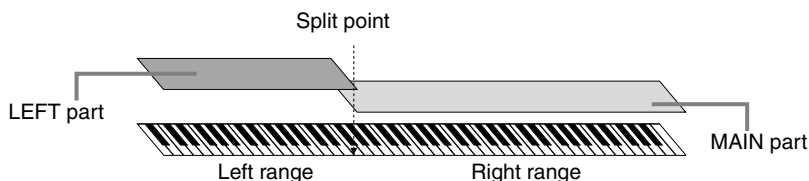

Playing three different voices — one on the left section of the keyboard, plus a layer of two on the right

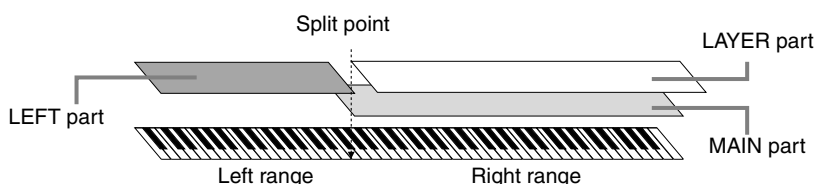

## Layer — Layering Two Different Voices

**1** Press this to turn the LAYER function on. To turn it off, press the button again.

**2** Select LAYER with the [G] button. Press the same button to call up the VOICE display, from which you can select the specific voice you want to play in a layer with the Main voice.

The method of selecting a voice here is the same as that in VOICE (MAIN) display (page 55).

**END** Press this to return to the MAIN display.

**NOTE**  
There is an alternate way for quickly selecting both the MAIN and LAYER voices from the panel: While holding down one panel voice button, press a second voice button. The first selected voice becomes the MAIN voice, and the second becomes the LAYER.

## Left — Setting Separate Voices for the Left and Right Sections of the Keyboard

**1** Set the **LEFT** to **ON**. Press this button again to set it to **OFF**.

**END**

Press this to return to the **MAIN** display.

**2** Select **LEFT** with the **[H]** button. Press the same button to call up the **VOICE** display, from which you can select the specific voice you want to play in a left. How to select the voice is the same as the way of **VOICE (MAIN)** screen (page 55).

**NOTE**  
The split point can be freely set to any key on the keyboard. To set it, call up the **SPLIT POINT** display by pressing the **[I]** (**SPLIT POINT**) button in the **MAIN** display. The operation steps are the same as in the **STYLE SETTING/SPLIT POINT** display of the **FUNCTION** page (page 138).

**NOTE**  
Each part (**MAIN**, **LAYER**, and **LEFT**) can have its own volume setting (page 62).

**NOTE**  
You can also use the **LAYER** and **LEFT** functions together, to create a combination layer/split. To do this, set separate voices for the left and right sections of the keyboard (as indicated), and set up a layer of two different voices on the right.

## Applying Voice Effects

This section of the panel lets you add a variety of effects to the voices you play on the keyboard.

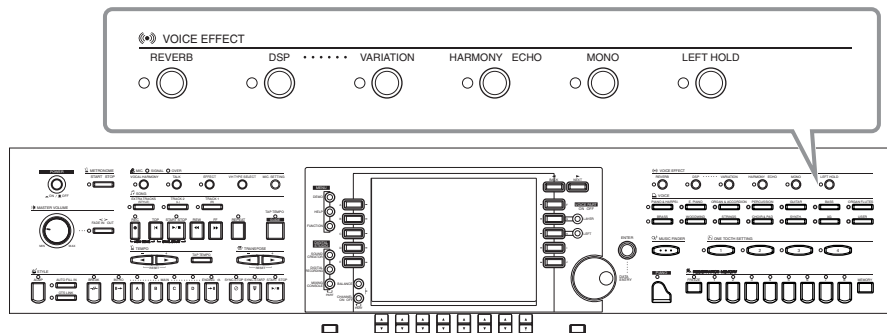

Press one of the effect buttons to turn the corresponding effects on. Press it again to turn the effect off. For explanations on each of the effects, see below.

### ■ REVERB

Reverb is an effect that recreates the acoustic ambience of a performance space — anything from a small jazz club to a concert hall.

### ■ DSP

The CVP-209/207 features a variety of dynamic built-in digital effects, letting you process the sound in various ways. You can use DSP to enhance the voices in subtle ways — such as by applying chorus to add animation and depth, or using a symphonic effect to give the sound warmth and richness. DSP also has effects such as distortion that can completely change the character of the sound. DSP is set for the currently selected part (**MAIN/LAYER/LEFT**).

**NOTE**  
The **DSP** and **VARIATION** effect types and their depth can be selected and adjusted in the **MIXING CONSOLE** display (page 123).

### ■ VARIATION (Not available for the Natural voices; page 89)

This control changes the Variation effect settings, letting you alter some aspect of the effect, depending on the selected type. For example, when the Rotary Speaker effect is selected (page 123), this lets you switch the rotor speed between slow and fast.

## ■ HARMONY/ECHO

This control adds Harmony or Echo effects to the voices played on the right hand section of the keyboard (page 143).

## ■ MONO

This control determines whether the voice is played monophonically (only one note at a time) or polyphonically for each part (MAIN/LAYER/LEFT). This is set to MONO when the lamp is lit, and set to polyphonic when the lamp is off. When set to MONO, only the last note played will sound. This lets you play wind instrument voices more realistically. Depending on the selected voice, the MONO setting also lets you effectively use the Portamento effect, when playing in legato.

## ■ LEFT HOLD

This function causes the left part voice to be held even when the keys are released — the same effect as when the damper (sustain) pedal is pressed. This function is especially effective when used with the auto accompaniment. For example, if you play and release a chord in the auto accompaniment section of the keyboard (with the left part on and the Left voice set to Strings), the strings part sustains, adding a natural richness to the overall accompaniment sound.

### NOTE

The Portamento effect creates a smooth pitch glide between successively played notes.

### HINT

You can add special emphasis to melody lines you play over chords by using the Layer function with a monophonic voice. Set the Main voice to play polyphonically and set the Layer voice to play monophonically (MONO). In this case, the melody you play — including the top notes of any chords — sounds monophonically. Try this using the following voices.

**MAIN voice:** Brass Section (polyphonic) + **LAYER voice:** Sweet Trump (monophonic)

## Using the Pedals

The CVP-209/207 features three pedals.

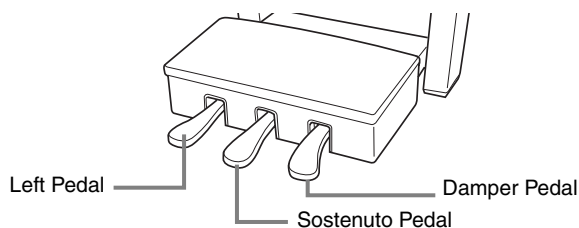

### NOTE

You can also assign one of many other functions to these pedals (as well as the optional foot controller or footswitch). For example, you can use it to start/stop the accompaniment style, or use it to play Fill-ins (page 139).

## ■ Damper Pedal (Right)

The damper pedal performs the same function as the damper pedal on an actual acoustic piano, letting you sustain the sound of the voices even after releasing the keys.

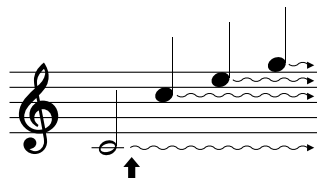

When you press the damper pedal here, the notes you play before you release the pedal have a longer sustain.

### NOTE

- Some voices may sound continuously or have a long decay after the notes have been released while the damper pedal is held.
- Certain voices in the [PERCUSSION] and [XG] groups may not be affected by use of the damper pedal.

## ■ Sostenuto Pedal (Center)

If you play a note or chord on the keyboard and press the sostenuto pedal while the note(s) are held, those notes will be sustained as long as the pedal is held, but all subsequently played notes will not be sustained.

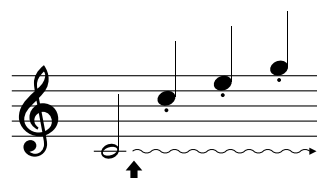

When you press the sostenuto pedal here while holding the note, the note will sustain as long as you hold the pedal.

### NOTE

- Certain voices, such as [STRINGS] or [BRASS], sustain continuously when the sostenuto pedal is pressed.
- Certain voices in the [PERCUSSION] and [XG] groups may not be affected by use of the sostenuto pedal.

## ■ Left Pedal

When the Piano voice is selected, pressing this pedal reduces the volume and slightly changes the timbre of the notes you play. The settings assigned to this pedal may differ depending on the selected voice.

### NOTE

The depth of the left pedal effect can be adjusted (page 139).

## ■ Foot Controller/Footswitch

An optional Yamaha foot controller (FC7) or footswitch (FC4 or FC5) can be connected to the AUX PEDAL jack and used to control various functions assigned in the FUNCTION page (page 139).

# Styles

The CVP-209/207 features styles (accompaniment patterns) in a variety of different musical genres including pops, jazz, Latin and dance. To use it, all you have to do is play the chords with your left hand as you perform and the selected Accompaniment Style (style) matching your music will automatically play along, instantly following the chords you play. Try selecting some of the different styles (refer to separate Data List (Style List) ) and play them.

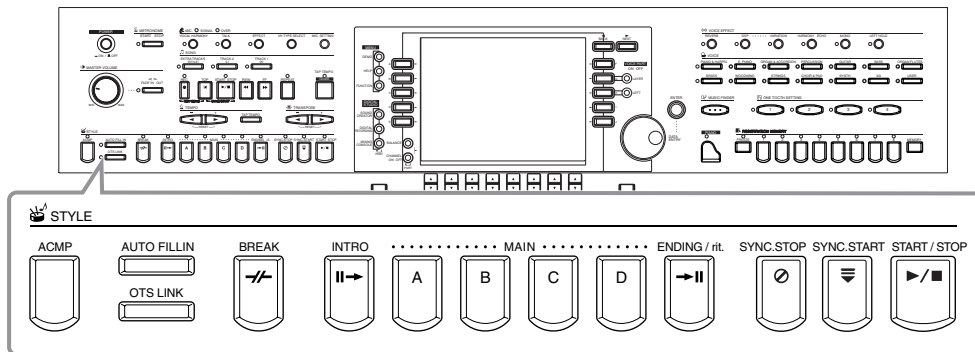

## Playing a style

**1**

**NOTE**  
To call up the [MAIN] display, first press the [DIRECT ACCESS] button, then press the [EXIT] button.

**2**

**NOTE**  
For a list of the available accompaniment styles, refer to the separate Data List (Style List).

**2-1** Select a location (Preset, User, Floppy Disk) for saving the style.

**2-2** Select a Style.

When you've opened a lower directory's display, this button (UP) lets you call up the next higher directory, from which you can select Style groups.

**3** When the [ACMP] button is set to on, you can play/indicate chords from the auto accompaniment section of the keyboard. (Depending on the settings, this may be the range of the Left voice, or the entire keyboard.)

**NOTE**  
You can set the key range for auto accompaniment (page 138).

**4** Turn SYNC. (SYNCHRONIZED) START on.

**NOTE**  
**Sync. Start**  
Enabling this lets you start the style simply by playing the keyboard.

**5** As soon as you play a chord with the auto accompaniment section, the style starts.  
For details about chord fingerings, refer to page 62.

The Tempo can be adjusted using the TEMPO [◀][▶] or [TAP TEMPO] button. If you tap the [TAP TEMPO] button, the tempo will adjust to the same speed that you tapped.

**NOTE**

- You can begin the rhythm channels (tracks) of the Style by pressing the [START/STOP] button.
- The rhythm channels of the style can also be started by tapping the [TAP TEMPO] button. With the style stopped, tap the [TAP TEMPO] button three, four or five times (three for 3/4 time, four for 2/4 or 4/4 time, five for 5/4 time).

**6** Stop the style.

Turn ACMP off.

**NOTE**  
When you simultaneously play back accompaniment styles with a song, the accompaniment parts recorded to the song (channels 9 - 16) are temporarily replaced by the selected accompaniment style — letting you try out and use different accompaniment with the song (page 76).

**Accompaniment Style Characteristics**

The defining characteristics of some of the accompaniment styles are indicated above the relevant style names in the Open/Save display.

**Session!**

These styles provide even greater realism and authentic backing by mixing in original chord types and changes, as well as special riffs with chord changes, with the Main sections. These have been programmed to add “spice” and a professional touch to your performances of certain songs and in certain genres. As a result, the styles may not necessarily be appropriate — or even harmonically correct — for all songs and for all chord playing. In some cases for example, playing a simple major triad may result in a seventh chord, or playing an on-bass chord may result in incorrect or unexpected accompaniment.

**Piano Combo!**

These accompaniment styles feature a basic piano trio (piano, bass, and drums), augmented in some cases with other instruments. Since this is a small combo sound, the accompaniment backing is appropriately sparse, making it useful and effective for a wide variety of songs.

**Pianist!**

These special styles provide piano-only accompaniment — effectively recreating the left-hand performance of an accomplished pianist. Just by playing the proper chords with your left hand, you can automatically add complicated arpeggios and bass/chord patterns — such as difficult-to-play stride piano parts.

**1** Select a style (page 60).

**NOTE**  
The Rhythm channels are part of the styles. Each style has different rhythm patterns.

**2**

**NOTE**  
You can also start the rhythm simply by playing a key on the keyboard, if Sync Start is enabled (turn on the [SYNC.START] button).

**3** Play along with the rhythm playback.  
The Tempo can be adjusted using the TEMPO [◀][▶] or [TAP TEMPO] buttons. If you tap the [TAP TEMPO] button, the tempo will adjust to the same speed that you tapped.

**NOTE**  
When selecting the style group "PIANIST," the rhythm doesn't sound. When you want to use any of the styles, always make sure that ACMP is turned on.

**END** Press the STYLE [START/STOP] button again to stop the rhythm playback.

## Adjusting the Volume Balance/Channel Muting

**BALANCE display**

Call up the **BALANCE** display.

**CHANNEL ON/OFF display**

Call up the **Channel ON/OFF** display.

Adjust the output level of the Part.

Call up the STYLE display by pressing the [CHANNEL ON/OFF] button, then turn the instrument you want to cancel off. To listen to only one instrument by itself, hold down the appropriate button for the channel to set the channel to SOLO. To cancel SOLO, simply press the appropriate channel button again.

**NOTE**  
**Channel**  
Refers to the MIDI channel in the song data (page 158). The channels are assigned as shown below.  
**Song**  
1 - 16  
**Accompaniment Style**  
9 - 16

## Chord Fingerings

The style playback can be controlled by the chords you play in the keys to the left of the split point. There are 7 types of fingerings as described below. Go to the CHORD FINGERING page (page 139), and select the Chord Fingerings. The page shows how to play chords with your left hand.

### SINGLE FINGER

Single Finger accompaniment makes it simple to produce beautifully orchestrated accompaniment using major, seventh, minor and minor-seventh chords by pressing a minimum number of keys on the auto accompaniment section of the keyboard. The abbreviated chord fingerings described below are used.

**For a major chord**, press the root key only.

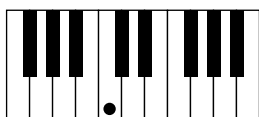

**For a minor chord**, simultaneously press the root key and a black key to its left.

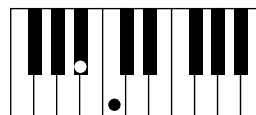

**For a seventh chord**, simultaneously press the root key and a white key to its left.

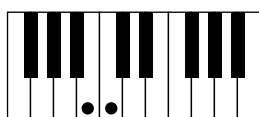

**For a minor-seventh chord**, simultaneously press the root key and both a white and black key to its left.

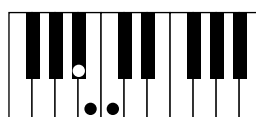

### MULTI FINGER

The Multi Finger mode automatically detects Single Finger or Fingered chord fingerings, so you can use either type of fingering without having to switch fingering modes. If you want to play minor, seventh, or minor-seventh chords using the SINGLE FINGER operation in the MULTI FINGER Mode, always press the closest white/black key(s) to the root of the chord.

### FINGERED

This mode lets you produce accompaniment by playing full chords on the auto accompaniment section of the keyboard. The Fingered mode recognizes the various chord types listed on the next page.

### FINGERED ON BASS

This mode accepts the same fingerings as the FINGERED mode, but the lowest note played in the auto accompaniment section of the keyboard is used as the bass note, allowing you to play “on bass” chords. For example, to indicate a C-on-E chord, play a C major chord with E as the lowest note (E, G, C).

### FULL KEYBOARD

This method detects chords in the entire key range. Chords are detected in a way similar to Fingered, even if you split the notes between your left and right hands — for example, playing a bass note with your left hand and a chord with your right, or by playing a chord with your left hand and a melody note with your right.

### AI FINGERED

This mode is basically the same as FINGERED, with the exception that less than three notes can be played to indicate the chords (based on the previously played chord, etc.).

### AI FULL KEYBOARD

When this advanced auto accompaniment mode is engaged, the CVP-209/207 will automatically create appropriate accompaniment while you play just about anything, anywhere on the keyboard using both hands. You don't have to worry about specifying the accompaniment chords. Although the AI Full Keyboard mode is designed to work with many songs, some arrangements may not be suitable for use with this feature.

This mode is similar to FULL KEYBOARD, with the exception that less than three notes can be played to indicate the chords (based on the previously played chord, etc.). 9<sup>th</sup> and 11<sup>th</sup> chords cannot be played.

#### NOTE

Chord detection in the AI Full Keyboard mode occurs at approximately 8th-note intervals. Extremely short chords — less than an 8th note in length — may not be detected.

#### NOTE

In Full Keyboard mode, chords are detected based on the lowest and second lowest notes you play. If the two lowest notes fall within a single octave, those two notes determine the chord. If the lowest note and the second lowest note are separated by more than one octave, the lowest note becomes the bass and the chord is determined from the second lowest note and the other notes played in the same octave.

#### NOTE

**AI**  
Artificial Intelligence

Chord Types Recognized in the Fingered Mode (Example for “C” chords)

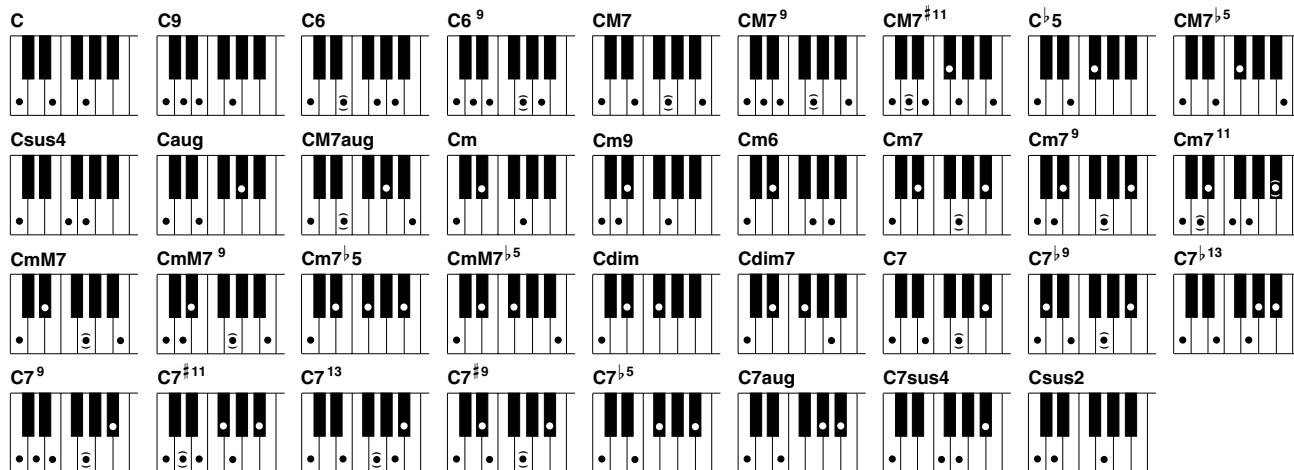

Chord Name [Abbreviation]	Normal Voicing	Display for root “C”
Major [M]	1 - 3 - 5	C
Ninth [9]	1 - 2 - 3 - 5	C9
Sixth [6]	1 - (3) - 5 - 6	C6
Sixth ninth [6 <sup>9</sup> ]	1 - 2 - 3 - (5) - 6 or 3 - 6 - 2*	C6 <sup>9</sup>
Major seventh [M7]	1 - 3 - (5) - 7	CM7
Major seventh ninth [M7 <sup>9</sup> ]	1 - 2 - 3 - (5)j - 7	CM7 <sup>9</sup>
Major seventh add sharp eleventh [M7 <sup>#11</sup> ]	1 - (2) - 3 - #4 - 5 - 7 or 1 - 2 - 3 - #4 - (5) - 7	CM7 <sup>#11</sup>
Flatted fifth [b5]	1 - 3 - b5	C <sup>b5</sup>
Major seventh flatted fifth [M7 <sup>b5</sup> ]	1 - 3 - b5 - 7	CM7 <sup>b5</sup>
Suspended fourth [sus4]	1 - 4 - 5	Csus4
Augmented [aug]	1 - 3 - #5	Caug
Major seventh augmented [M7aug]	1 - (3) - #5 - 7	CM7aug
Minor [m]	1 - b3 - 5	Cm
Minor ninth [m9]	1 - 2 - b3 - 5	Cm9
Minor sixth [m6]	1 - b3 - 5 - 6	Cm6
Minor seventh [m7]	1 - b3 - (5) - b7	Cm7
Minor seventh ninth [m7 <sup>9</sup> ]	1 - 2 - b3 - (5) - b7 or b3 - b7 - 2	Cm7 <sup>9</sup>
Minor seventh eleventh [m7 <sup>11</sup> ]	1 - (2) - b3 - 4 - 5 - (b7)	Cm7 <sup>11</sup>
Minor major seventh [mM7]	1 - b3 - (5) - 7	CmM7
Minor major seventh ninth [mM7 <sup>9</sup> ]	1 - 2 - b3 - (5) - 7	CmM7 <sup>9</sup>
Minor seventh flatted fifth [m7 <sup>b5</sup> ]	1 - b3 - b5 - b7	Cm7 <sup>b5</sup>
Minor major seventh flatted fifth [mM7 <sup>b5</sup> ]	1 - b3 - b5 - 7	CmM7 <sup>b5</sup>
Diminished [dim]	1 - b3 - b5	Cdim
Diminished seventh [dim7]	1 - b3 - b5 - 6	Cdim7
Seventh [7]	1 - 3 - (5) - b7 or 1 - (3) - 5 - b7	C7
Seventh flatted ninth [7 <sup>b9</sup> ]	1 - b2 - 3 - (5) - b7	C7 <sup>b9</sup>
Seventh add flatted thirteenth [7 <sup>b13</sup> ]	1 - 3 - 5 - b6 - b7	C7 <sup>b13</sup>
Seventh ninth [7 <sup>9</sup> ]	1 - 2 - 3 - (5) - b7 or 3 - b7 - 2*	C7 <sup>9</sup>
Seventh add sharp eleventh [7 <sup>#11</sup> ]	1 - (2) - 3 - #4 - 5 - b7 or 1 - 2 - 3 - #4 - (5) - b7	C7 <sup>#11</sup>
Seventh add thirteenth [7 <sup>13</sup> ]	1 - 3 - (5) - 6 - b7 or 3 - 6 - b7	C7 <sup>13</sup>
Seventh sharp ninth [7 <sup>#9</sup> ]	1 - #2 - 3 - (5) - b7	C7 <sup>#9</sup>
Seventh flatted fifth [7 <sup>b5</sup> ]	1 - 3 - b5 - b7	C7 <sup>b5</sup>
Seventh augmented [7aug]	1 - 3 - #5 - b7	C7aug
Seventh suspended fourth [7sus4]	1 - 4 - 5 - b7	C7sus4
Suspended second [sus2]	1 - 2 - 5	Csus2

**NOTE**

- Notes in parentheses can be omitted.
- For FINGERED, FIN-GERED ON BASS, and AI FINGERED, if you play any three adjacent keys (including black keys), the chord sound will be canceled and only the rhythm instruments will continue playing (Chord Cancel function). This let you play back only the rhythm.
- Playing two same root keys in the adjacent octaves produces accompaniment based only on the root.
- A perfect fifth (1 + 5) produces accompaniment based on the root and the fifth.
- The auto accompaniment Style will sometimes not change when related chords are played in sequence (e.g. some minor chords followed by the minor seventh).
- You can also have the CVP-209/207 “teach” you how to play Fingered chords. From the CHORD FINGERING display (page 139), specify the chord you want to learn, and the notes you should press are indicated in the display.

\* Only this voicing (inversion) is recognized. Other chords not marked with an asterisk can be played in any inversion.



# Arranging the Style Pattern (SECTIONS: MAIN A/B/C/D, INTRO, ENDING, BREAK)

The CVP-209/207 features various types of Auto Accompaniment Sections that allow you to vary the arrangement of the Style. They are: Intro, Main, Break and Ending. By switching among them as you play, you can easily produce the dynamic elements of a professional-sounding arrangement in your performance.

**NOTE**

You can also use this function to play only rhythms (page 62).

**NOTE**

- If you press the **[INTRO]** button, you can play back an Intro section while an accompaniment is playing.
- Section button indications — **[BREAK]**, **[INTRO]**, **[MAIN]**, **[ENDING]** buttons  
LED is green — The section is not selected.  
LED is red — The section is currently selected.  
LED is off — No section data; the section cannot be played.
- You can dynamically control the level of the accompaniment by how softly or strongly you play the keys in the Auto Accompaniment section of the keyboard (page 138).
- If you press the **[SYNC. START]** button while an accompaniment is playing, the accompaniment will stop and the CVP-209/207 will enter Synchronized Start standby status.
- You can also change style sections by using the pedal (page 139).
- The Break section lets you add dynamic variations and breaks in the rhythm of the accompaniment, to make your performance sound even more professional. If you press the **[BREAK]** button while an accompaniment is playing, the fill-in will play back for one measure.
- The indicator of the destination section (MAIN A/B/C/D) will flash while the Break is playing.
- When the **[AUTO FILLIN]** button is set to on and the **MAIN [A][B][C][D]** button is pressed after the final half beat (eighth note) of the measure, the fill-in will begin from the next measure.

**1** Select a style (page 60).



**2**

STYLE

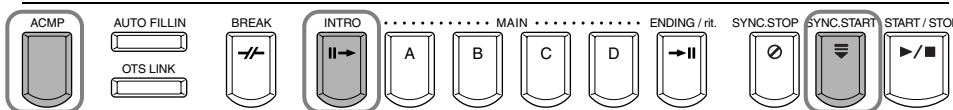

**2-1** Turn the ACMP function on.

**2-3** Turn the SYNC. START function on.

**2-2** Press the **[INTRO]** button. To cancel the INTRO section before starting the style, press the **[INTRO]** button again.



**3**

The Intro section starts as soon as you play a key in the Auto Accompaniment section of the keyboard, and changes to the Main section.

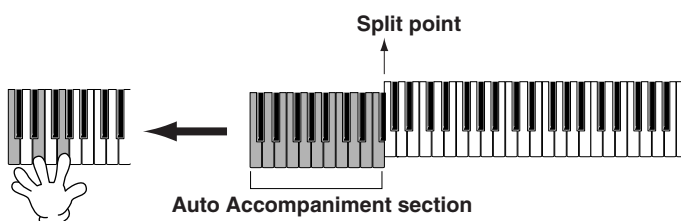

**4**

STYLE

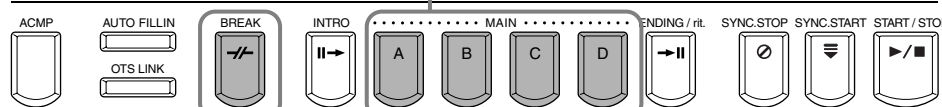

Main sections can be shifted.

Press this button to add breaks.





This switches to the ending section. When the ending is finished, the Style stops automatically. You can have the ending gradually slow down (ritardando) by pressing the same [ENDING/rit.] button again while the ending is playing back.

STYLE

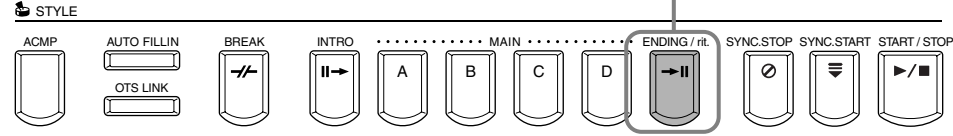

**Fade-in/Fade-out**

The accompaniment style also include a convenient Fade-in/Fade-out function that gradually fades in and fades out the accompaniment. To start the style with a fade-in, press the [FADE IN/OUT] button, then turn SYNC. START on. To cancel the fade-in before starting the style, press the button again.

To fade out and stop the Style, press this button while the style is playing. The time of the fade-in/fade-out can also be set (page 148).

## Stopping the Style Playback While Releasing Keys (SYNC. STOP)

When the Synchro Stop function is engaged, accompaniment playback will stop completely when all keys in the Auto Accompaniment section of the keyboard are released. Accompaniment playback will start again as soon as the key in the Auto Accompaniment section is played.

**1 Turn ACMP (Accompaniment) on.**

↓

**2 Turn SYNC. STOP on.** SYNC. START is also automatically set to on when SYNC. STOP is turned on.

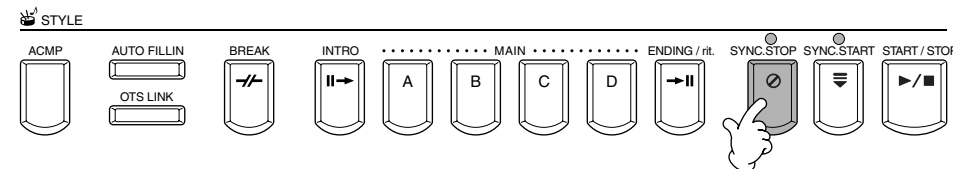

↓

**3 As soon as you play a chord with your left hand, the auto accompaniment starts.**

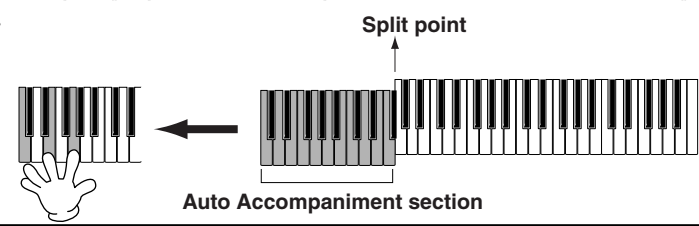

Split point

Auto Accompaniment section

↓

**4 The auto accompaniment stops when you release your left hand from the keys.**

↓

**5 Playing a chord with your left hand automatically restarts the auto accompaniment.**

→



Press the [SYNC. STOP]/[SYNC. START] button again to stop the accompaniment.

- NOTE**
- Styles can also be started by pressing the **STYLE [START/STOP]** button.
  - You can select the Intro and Ending type by pressing the **[E]** button in the **MAIN** window (page 67).
  - If you press the **[INTRO]** button while the ending is playing, the Intro section will begin playing after the ending is finished.
  - When the **[AUTO FILLIN]** button is set to on and you press a **MAIN** button while the ending is playing, fill-in accompaniment will immediately start playing, continuing with the Main section.
  - You can begin the accompaniment by using the Ending instead of the Intro section. In this case, the auto accompaniment doesn't stop when the ending is finished.
  - If you select a different style while the style is not playing, the "default" tempo for that style is also selected. If the accompaniment is playing, the same tempo is maintained even if you select a different style.
  - When **STOP ACMP** is set to on and the accompaniment is not playing, you can play both chords and bass in the Auto Accompaniment section in the keyboard (page 138).

**NOTE**

You can also use the SYNC. STOP function by pressing the auto accompaniment section/left-hand range briefly (page 138).

**NOTE**

Synchro Stop cannot be set to on when the fingering mode is set to Full Keyboard/All Keyboard or the auto accompaniment on the panel is set to off.

## Selecting Intro and Ending Types (INTRO/ENDING)

**1**

**NOTE**  
To call up the [MAIN] display, first press the [DIRECT ACCESS] button, then press the [EXIT] button.

**2**

Select a Intro

Select a Ending

**3** Play the style using the Intro or Ending section (page 30, 31).

## Playing Fill-in patterns automatically when changing accompaniment sections — Auto Fill In

**NOTE**  
**Fill**  
A short phrase used to add variation to the style.

**1**

**2** Play the style and switch among the accompaniment sections as they play (page 30, 31).  
Fill-in patterns play automatically between each change in the Main sections.

**NOTE**  
You can also add a fill-in by pressing the selected MAIN button again.

**END** To cancel the Auto Fill, press the [AUTO FILLIN] button again.

**NOTE**  
You can temporarily disable Auto Fill In during a performance by pressing the next Main section's button twice quickly.

# Appropriate Panel Setting for the Selected Style (ONE TOUCH SETTING)

The convenient One Touch Setting function makes it easy for you to select voices and effects that are appropriate to the style you're playing. Each preset style has four pre-programmed panel setups that you can select by pressing a single button.

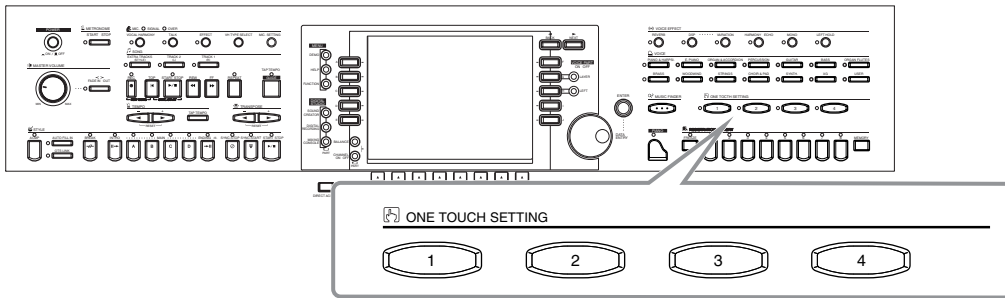

**1** Select a style (page 60).

**2** Press one of the ONE TOUCH SETTING buttons ([1] - [4]).

**LED is red** — The One Touch Setting is currently selected.

**LED is green** — The One Touch Setting is not selected.

**LED is off** — No One Touch Setting data. The button is not available.

Various settings (such as voices, effects, etc.) that match the selected style can be instantly recalled. When the style is not playing, Auto Accompaniment and Sync. Start will automatically be turned on. For details about the One Touch Setting parameters, refer to the separate Data List (Parameter Chart).

**3** As soon as you play a chord with your left hand, the auto accompaniment starts.

Split point

Auto Accompaniment section

**4** Stop the Auto Accompaniment.

STYLE

ACMP AUTO FILLIN BREAK INTRO MAIN A B C D ENDING /rit. SYNC.STOP SYNC.START START/STOP

**5** Try out other One Touch Setting setups. You can also create your own One Touch Setting setups (page 69).

ONE TOUCH SETTING

## Automatically Changing One Touch Settings with the Sections — OTS Link

The convenient OTS (One Touch Setting) Link function lets you automatically have One Touch Settings change when you select a different Main section (A - D).

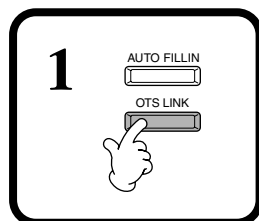

**2** When you switch among the Main sections (A - D), the corresponding One Touch Setting will be called up automatically.  
The Main sections A, B, C, and D correspond to One Touch Settings 1, 2, 3, and 4, respectively.

**NOTE**  
The One Touch Settings can be set to change with the sections in one of two different timings (page 138):

- Immediately when you press a section button.
- At the next measure (in an accompaniment style), after you press a section button.

**END** To cancel the OTS Link function, press the [OTS LINK] button again.

## Registering the Panel Controls in One Touch Setting (ONE TOUCH SETTING)

This section covers how to create your own One Touch Setting setups (four setups per style). For a list of One Touch Setting setup parameters, refer to the separate Data List (Parameter Chart).

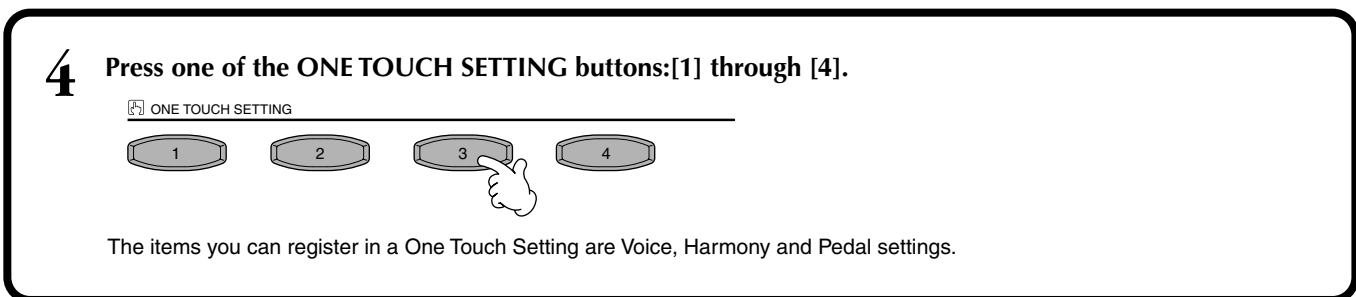

**END** A message prompting you to save the current style will appear. Select “YES” to call up the STYLE display, then save the panel settings (page 39, 45).

**NOTE**  
Unless you store the panel settings here, the registered settings will be deleted when you select a different accompaniment style.

# Calling Up Ideal Setups for Your Music — Music Finder

The Music Finder feature lets you instantly call up the appropriate settings for the instrument — including voice, style, and One Touch Settings — simply by selecting the desired song title. If you want to play a certain song but don't know which style and voice settings would be appropriate, the convenient Music Finder function will help you out. The recommended settings, which together make up a “record,” can also be edited and stored. This lets you create and save your own Music Finder records for future recall.

**NOTE**  
The MUSIC FINDER records and its contents is just one example of the recommended panel setups. You can also create your own Music Finder settings for your favorite songs and genres.

**NOTE**  
Keep in mind that Music Finder is a performance aid in that it automatically finds appropriate accompaniment styles and voices for your playing. Even though you can specify song titles, it does not actually contain song data.

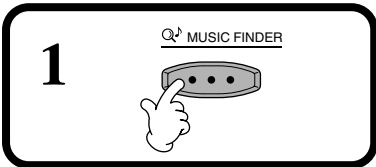
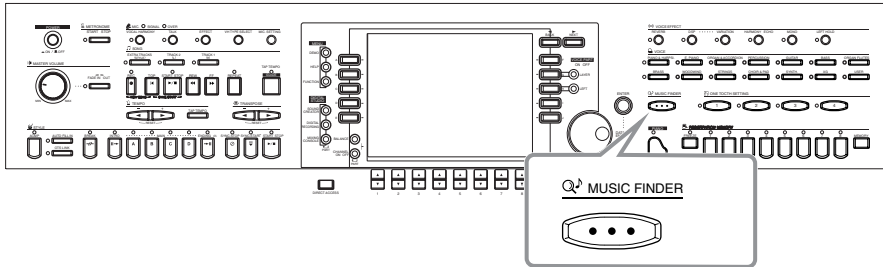

**2 Select a record.** For example, select the top record by pressing the [1▲▼] button to call up the recommended setups. The setting data shown here is referred to as a “record.”

MUSIC	STYLE	BEAT	TEMPO
(Taking the) Easy Way Out	FastHardRock	4/4	120
16 Beat 1	SoftRock	4/4	80
2 Hearts	SoftRock	2/4	66
6/8 Blues	FastHardRock	2/4	68
6/8 March	SoftRock	0	116
6/8 Soul	FastHardRock	6/8	120
60's Groove	FastHardRock	4/4	60
70's Disco 3	FastHardRock	3/4	120
8 Beat 1	OrganBallad	3/4	130
8 Beat 2	OrganBallad	6/8	80
8 Beat 3	SoftRock	4/4	95
8 Beat 4	FastHardRock	2/4	142
8 Beat 4	OrganBallad	6/8	116

**ALL** ..... Show all records.  
**FAVORITE** ..... Show the records that have added to the “Favorite” page.  
**SEARCH1,2** ..... Show the results by SEARCH function (page 71).

**Sorting the records**  
**MUSIC** ..... The record is sorted by song title.  
**STYLE** ..... The record is sorted by style name.  
**BEAT** ..... The record is sorted by beat.  
**TEMPO** ..... The record is sorted by tempo.

**Change the order of the records (ascending or descending).**

**Add the selected record to “Favorite (Bookmark)” page**  
 When you press the [H] button, the “Add selected data to the favorite list? YES/NO” message will be displayed. Select [YES] to add the selected page to “FAVORITE” page.

**Search record(s).** Enter the condition of the search in the MUSIC FINDER SEARCH display (page 71). The results of SEARCH 1 or 2 appear in the “SEARCH 1” or “SEARCH 2” page respectively.

**Call up the MUSIC FINDER RECORD EDIT (page 72) display (for editing the selected record).**

**Select a record by song title.** When sorting records by song title, use the [1▲▼] button to skip up or down through the songs alphabetically. Simultaneously press the [▲▼] buttons to move the cursor to the first record.

**Turn TEMPO LOCK on/off.** TEMPO LOCK function lets you avoid changing the Tempo during style playback when selecting another record. The on/off setting affects all pages (ALL/FAVORITE/SEARCH 1/SEARCH 2).

**Select a record by style name.** When sorting the records by style name, press these buttons to move the cursor to the next /previous style. Simultaneously press the [▲▼] buttons to move the cursor to the first record.

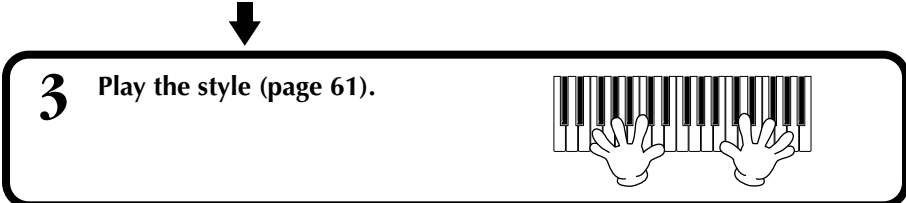

**NOTE**  
Records can be selected by using the [DATA ENTRY] dial and pressing the [ENTER] button.

# Searching the Ideal Setups — Music Finder Search

You can search the record by music title or keywords. The results appears in the display.

**1** Press the [I] (SEARCH 1) button or [J] (SEARCH 2) button in the MUSIC FINDER display.

**2** Enter the conditions for the search (see below), then start search by using [START SEARCH] button.

Start searching the record. The results that satisfy all the conditions appear in the SEARCH page. For details about the search settings in this display, see below.

## ■ [A] MUSIC



Searches by music or song title. Press this button to call up the display for inputting the song title.

When you enter the song title (page 46), the search function calls up all records that contain the entered word or words.

## ■ [B] KEYWORD



Searches by keyboard. Press this button to call up the display for inputting the keyword.

When you enter the keyword (page 46), the search function calls up all records that contain the entered word or words. You can search several

different keywords simultaneously by inserting a separator (comma) between each. The search function finds and displays all records that contain at least one match in the keywords.

## ■ [C] STYLE

Searches by style name. Press this button to call up the STYLE FILE SELECT display. Press the [A] through [J] button in the display to select the desired accompaniment style. This convenient function lets you find all songs that use a certain accompaniment style.

**NOTE**  
The STYLE FILE SELECT display can only be used to select the style name for searching; it cannot be used to call up the actual accompaniment style.

## ■ [D] BEAT

Searches by beat or rhythmic feel.

## ■ [E] SEARCH AREA

Selects a specific location for searching. You can further narrow down your search by using the SEARCH 1 and 2 selections.

## ■ [F]~[H] CLEAR

Clears the entered item at left.

## ■ [1▲▼] TEMPO FROM

You can also narrow your search by specifying a tempo range. This lets you set the minimum tempo for the search. Press the [▲▼] buttons simultaneously to instantly reset the tempo value to the minimum.

## ■ [2▲▼]TEMPO TO

You can also narrow your search by specifying a tempo range. This lets you set the maximum tempo for the search. Press the [▲▼] buttons simultaneously to instantly reset the tempo value to the maximum.

## ■ [3▲▼]~[5▲▼] GENRE

Selects the specific music genre for searching. The available range includes all genres (ANY), the preset genres, and any genres you've entered yourself (page 70).

## ■ [8▼] CANCEL

Press this to cancel the operation and return to the previous display.

# Editing Records — Music Finder Record Edit

From this display, you can call up existing records and edit them to suit your preferences. You can even use this to create your own Music Finder records.

**1** Press the [8▲▼] (RECORD EDIT) button in the MUSIC FINDER display.

**2** Change/clear the record data. You can also register new records. For details about all settings and operations, see below.

**NOTE**  
You can also change/clear a preset record. To avoid changing/clearing the record, register the record as a new record after editing.

**NOTE**  
All Music Finder records can be stored together as a single file (page 151). When calling up a stored file, a message appears prompting you to replace or append the records as desired.

- **Replace:**  
All Music Finder records currently in the instrument are deleted and replaced with the records of the selected file.
- **Append:**  
The records called up are added to the vacant record numbers.

■ **[A] MUSIC**

Selects the music or song title for editing. Press the button to call up the display for inputting the music or song title, then edit the name as desired.



■ **[B] KEYWORD**

Selects the keyword for editing. Press the button to call up the display for inputting the keyword, then edit it as desired.



You can enter several different keywords by inserting a separator (comma) between each.

■ **[C] STYLE**

Selects the style name for editing. Always enter the name when a new record is registered. Press the button to call up the **STYLE FILE SELECT** display. Press the [A] through [J] button in the display to select the desired style you want to change/clear/register.

**NOTE**  
The **STYLE FILE SELECT** display can only be used to select the style name for record editing; it cannot be used to call up the actual accompaniment style.

■ **[D] BEAT**

Selects the beat (time signature) for editing. When another file is selected by pressing the [C] button, the current beat setting is replaced with the beat setting of the selected file.

**NOTE**  
Keep in mind that the Beat setting made here is only for the Music Finder search function; this does not affect the actual Beat setting of the accompaniment style itself.

■ **[E] FAVORITE**

Adds the selected record to the **FAVORITE** page (page 70).

■ **[F]~[H] CLEAR**

Clears the entered item at left.

■ **[I] DELETE RECORD**

Clears the selected record. The deleted record number becomes empty. When you press this button, a message appears prompting you to execute, abort or cancel the operation.  
**YES** ..... Press this to clear the record and close the display.  
**NO** ..... Press this to close the display without clearing the record.  
**CANCEL**..... Press this to close the message box and return to the previous display.

■ **[J] NEW RECORD**

Registers a new record. The smallest available empty record number is used for registering. When you press this button, a message appears prompting you to execute, abort or cancel the operation.  
**YES** ..... Press this to register the record and close the display.  
**NO** ..... Press this to close the display without registering the record.  
**CANCEL**..... Press this to close the message box and return to the previous display.

**NOTE**  
The maximum number of records is 2500, including internal records.



■ [1▼▲] TEMPO

Determines the tempo for the selected style. When changing the style with the [C] button, the tempo is automatically changed to that of the changed style.

■ [3▼▲]~[5▼▲] GENRE

Indicates and changes the genre to which the selected record is assigned. The available range includes all preset genres as well as any you've entered yourself.

■ [6▼▲] GENRE NAME

For entering a genre name. Press the button to call up the display for inputting the genre name, then edit the name as desired. A maximum of 200 genre names can be stored.



The genre name you input becomes effective when the current record is edited (overwritten) by pressing the [8▲] (OK) button, or when a new record is registered by pressing the [J] (NEW RECORD) button.

If you exit from the MUSIC FINDER EDIT display without actually editing or registering a record, the input genre name is deleted.

■ [8▲] OK

Executes all editing and changes to the record. When you press this button, a message appears prompting you to execute, abort or cancel the operation.

**YES** ..... Press this to replace the record and close the display.

**NO** ..... Press this to close the display without replacing the record.

**CANCEL**..... Press this to close the message box and return to the previous display.

■ [8▼] CANCEL

Press this to cancel the operation and return to the **MUSIC FINDER** display.

**NOTE**

To maintain the edited and registered data, make sure to save all Music Finder records as a file (page 151). If no saved, the data will be lost when another Music Finder file is called up or the factory-programmed settings are restored (page 151).

# Song Playback

Here you'll learn how to play back songs. Songs include the internal songs of the instrument, performances you've recorded yourself using the recording functions (page 94), and commercially available song data. You can use this highly versatile feature in a variety of ways — playing along on the keyboard with the recorded song, as well as practicing and learning new music with the Guide (page 79) and Repeat (page 78) functions. You can also display the music notation and lyrics in the LCD.

If you connect a microphone to the CVP-209/207, you can sing along with the song and have vocal harmony parts added automatically (page 128).

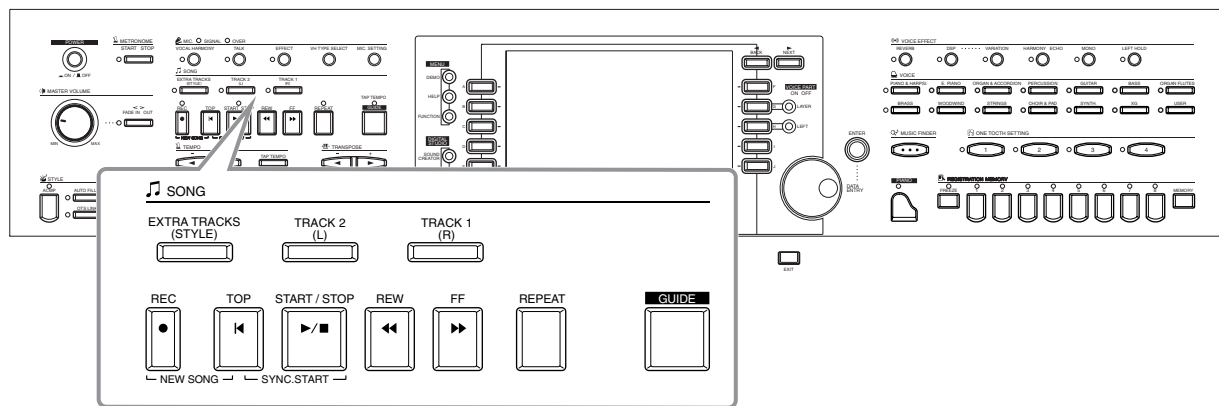

## Compatible Song Types

- Internal songs (Song Book)
- Song data on included disk (50 greats for the Piano)
- Commercially available song data



Disks having this logo mark feature song data compatible with GM (General MIDI).



Disks having this logo mark feature song data compatible with Yamaha's XG format. XG is a significant enhancement of the "GM system level 1" standard, providing more voices, greater editing control, and support for multiple effect sections and effect types.



Disks having this logo mark feature song data compatible with Yamaha's DOC (Disk Orchestra Collection)



Disks having this logo mark feature song data compatible with Yamaha's original MIDI file format.

### NOTE

Commercially available music data is subject to copyright restrictions, and is intended only for your own personal use.

### NOTE

For more information on the song file types compatible with the Clavinova, see page 159.

- Songs you recorded (page 94) and stored to the CVP-209/207 or disk.

# Song Playback

## Playing the Internal Songs

**1**

**NOTE**  
If the **MAIN** screen (at left) is not displayed, press the **[DIRECT ACCESS]** button followed by the **[EXIT]** button.

**NOTE**  
You can also make a variety of other settings (such as tempo, voice selection, settings for the practice functions, etc.) and have them automatically called up when you play back the song (page 106).

**2**

**2-1 Select the PRESET tab with the [BACK] button.**

**2-2 Open a folder and select a song to be played back.**

**NOTE**  
You can enable the Synchro Start for the song by simultaneously pressing the **[TOP]** button and the **SONG [START/STOP]** button. The song starts as soon as you play the keyboard. You can also use this function along with the Style's Synchro Start function (page 61).

**NOTE**  
You can have the volume automatically fade in and fade out at the beginning and end of the song. Simply press the **[FADEIN/OUT]** button at the start of song playback to fade in the song, and press it again at the end of the song to fade out.

**3** The song starts.

Adjust the tempo by using the **TEMPO** [**◀**][**▶**] buttons (page 51) or the **[TAP TEMPO]** button. You can even change the playback speed by tapping out the tempo — simply tap the **[TAP TEMPO]** button twice.

To stop the song immediately, press the button again.

Press the **[EXIT]** button in order to go back to the previous screen.

**NOTE**  
Songs can also be played back continuously. Set **SONG CHAIN PLAY** to **ON** from the **SONG SETTING** display (page 137).

**NOTE**  
Make sure that the Language setting for the instrument (page 151) is the same as that of the file name of the song that you are playing back.

### Simultaneously Playing a Song and an Accompaniment Style

When playing back a song and an accompaniment style at the same time, channels 9 - 16 of the song data are replaced with accompaniment style channels — allowing you to use the auto accompaniment styles and features in place of the accompaniment parts of the song. Make the settings below and play your own chord substitutions in place of the song's chord data.

- [ACMP] button .....ON
- [AUTO FILL IN] button .....ON

- 1** Select the song and start playback by pressing the SONG [START/STOP] button.
- 2** Select the desired accompaniment style.
- 3** Start the style by pressing the STYLE [START/STOP] button.
- 4** While the song is playing, insert a break or change sections (with the STYLE section buttons.)  
Fill-in patterns play when you switch sections.



The style automatically stops when the song finishes or is stopped.

**NOTE**

Some of the internal songs have been created using the accompaniment styles. For these songs, the accompaniment styles are automatically started when starting song playback.

**NOTE**

The accompaniment stops when you stop the song. If the accompaniment style is playing and you start the song, the accompaniment automatically stops. However, for internal songs that use accompaniment styles, the accompaniment style is not stopped.

## Playing Back Songs on Disk

Insert the disk into the drive.

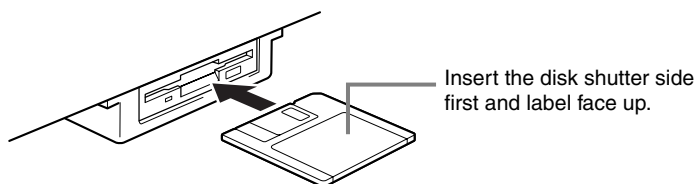

The method for playing back is the same as in the “Playing the Internal Songs” instructions (page 75), except that you should select **FLOPPY DISK** page in the **SONG** display.

## Other Playback-related Operations

### Repeat / Rewind / Fast forward

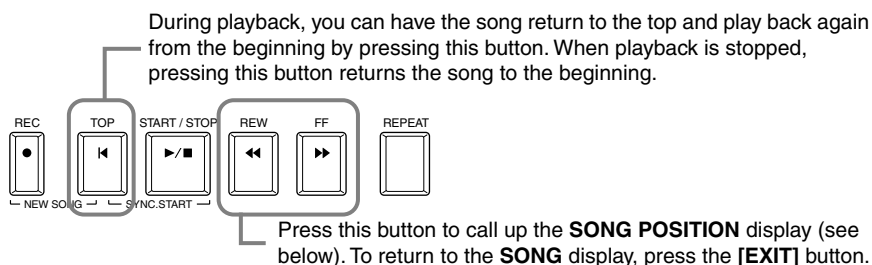

### SONG POSITION display

When “**BAR**” is selected, you can specify a measure number (counted from the beginning of the song) by using the **[REW]** and **[FF]** buttons.  
When “**PHRASE MARK**” is selected, specify the phrase mark number by using the **[REW]** and **[FF]** buttons.

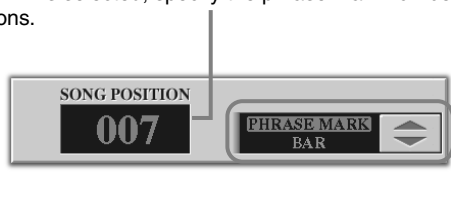

“**PHRASE MARK**” is shown only when the song contains phrase marks. Press the **[J]** button to toggle between “**BAR**” and “**PHRASE MARK**,” then use the **[REW]** and **[FF]** buttons to select the desired measure or phrase mark.

### Adjusting the Volume Balance / Muting Specific Channels

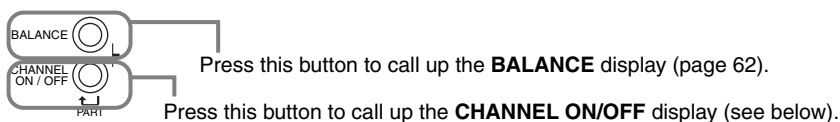

### CHANNEL ON/OFF display

SONG		STYLE		CHANNEL ON / OFF											
1	ON	2	ON	3	ON	4	ON	5	ON	6	ON	7	ON	8	ON
9	ON	10	ON	11	ON	12	ON	13	ON	14	ON	15	ON	16	ON

Select the **[SONG]** tab with the **[CHANNEL ON/OFF]** button, and mute the desired channel by setting it to **[OFF]**. To **solo** a channel (only that channel will sound), hold down the appropriate button corresponding to the channel. To release the solo for the channel, press that channel’s button again.

#### NOTE

Before proceeding, make sure to read the section “Handling the Floppy Disk Drive (FDD) and Floppy Disk” (page 6).

#### NOTE

You can set whether or not the Clavinova automatically calls up the first disk song when a disk is inserted (page 150).

#### NOTE

Some song data for the Clavinova has been recorded with special “free tempo” settings. During playback of such song data, the measure numbers shown in the display will not correspond to the actual measure; this only serves as a reference as to how much of the song has been played back.

#### NOTE

Songs containing a large amount of data may not be able to be read properly by the instrument, and as such you may not be able to select them. The maximum capacity is about 200–300KB, however this may differ depending on the data contents of each song.

#### NOTE

#### Phrase Mark

This data specifies a certain location in the song data.

#### NOTE

#### Channel

Refers to the MIDI channel in the song data. The channels are assigned as shown below for the CVP-209/207.

#### Song

1 - 16

#### Accompaniment Style

9 - 16

## Muting Specific Parts — Track 1/Track 2/Extra Tracks

This feature lets you mute certain parts of the song (Track 1, Track 2, Extra Tracks), and play back only those parts you want to hear. For example, if you want to practice the melody of a song, you can mute just the right-hand part and play that part yourself.

**1** Select the song to be played back (page 74).

**2** Use this button to turn on/off the additional performance parts (all but the right hand/left hand).

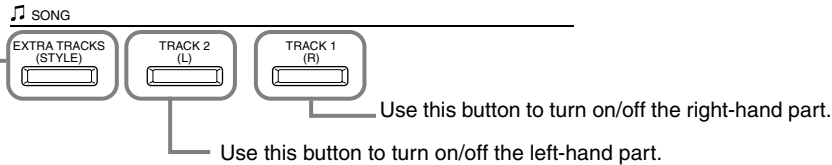

**NOTE**

You can change the channel assignments for Track 1 and Track 2 (page 137), letting you specify which parts are muted when pressing the **[TRACK 1]/[TRACK 2]/[EXTRA TRACKS]** buttons.

**NOTE**

All tracks are automatically set to on when selecting a different song.

**3** Start the song. Adjust the tempo by using the TEMPO [**◀**][**▶**] buttons (page 51).

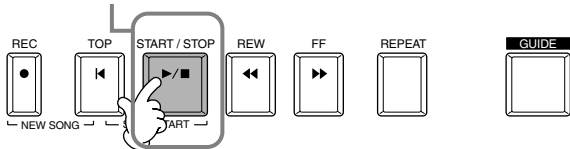

To stop the song, press the button again.

## Repeat Playback of a Specific Range

This feature allows you to specify a certain range of the song (between Point A and Point B), and play it back repeatedly.

**1** Play back the song (page 75, 77).

**2** Press this button at the point you want the repeating phrase to start (Point A). Press this button at the point you want the repeating phrase to end (Point B).

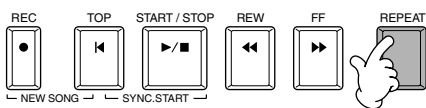

**NOTE**

You can also specify Points A and B when the song is stopped. Set Point A by pressing the **[REPEAT]** button, then use the **[FF]** button to move to the desired end location, then set Point B by pressing the **[REPEAT]** button again.

**3** After an automatic lead-in (to help guide you into the phrase), the range from point A to point B is played back repeatedly. Regardless of whether the song is playing back or is stopped, pressing the **[TOP]** button returns to point A.

**NOTE**

Point B cannot be selected unless Point A has been selected first.

**NOTE**

Specifying only Point A results in repeat playback between Point A and the end of the song.

**NOTE**

The specified A and B points will be erased when selecting a different song number, cancelling the Repeat function, or selecting a different repeat mode — such as Phrase Repeat or repeat in Song Chain Play (page 137).

**4** Stop the song.



To cancel the Repeat function, press the button again.

## Using the Practice Functions —Guide

These fun features make it easy to learn new music. The key guide lamps indicate the notes you should play, when you should play them, and how long you should hold them down. Also, when you sing and play along with a song using a connected microphone, the Clavinova automatically adjusts the timing of the song to match your vocal performance.

### NOTE

You can turn the key guide lamps on/off from the **SONG SETTING** display (page 137).

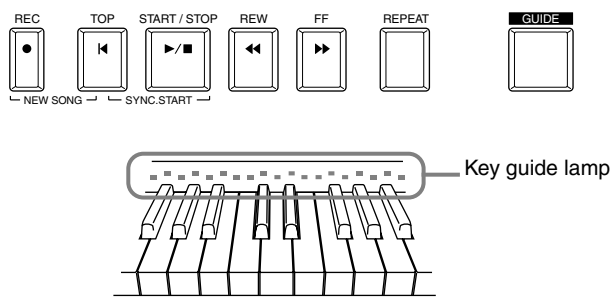

## Practice Functions

### For keyboard performance

#### ■ Follow Lights

When this is selected, you can see which notes you should play by watching the key guide lamps. They light up in time with music, showing you when to play a note. You can also practice at your own pace — since the accompaniment waits for you to play the notes correctly.

#### • Accompaniment Guide

If the song data you're using contains chord data and the [ACMP] button is turned on, you can use the guide lamps (page 137) to help you play chords as well. Watch the guide lamps and try playing the appropriate chords.

#### ■ Any Key

With this function, you can play the melody of a song simply by pressing a single key (any key is OK) in time with the rhythm. As long as you play the key in time with the music, the melody flows smoothly with the song.

### NOTE

You can also determine the timing by which the key guide lamps light to fit your playing preference (Guide Lamp Timing; page 137).

### NOTE

If you want to learn how to play certain chords, use the Chord Tutor function (page 139).

### NOTE

The Accompaniment Guide function cannot be used if the chord fingering method is set to **Single Finger**, **Full keyboard** or **AI Full Keyboard**.

### For sing-along performance

#### ■ Karao-Key

This convenient function lets you control the song and accompaniment playback with just one finger, while you sing along. Simply play a key on the keyboard in time with the music — any key is fine — and the accompaniment parts of the song follow your playing. This lets you control the timing and tempo of the song and accompaniment to perfectly match your singing performance.

#### ■ Vocal CueTIME

Similar to Follow Lights above, you can see which notes to sing by watching the key guide lamps. The Clavinova follows your singing and automatically adjusts the timing and tempo of the song to match your vocal performance.

# Practicing Music with the Guide Functions

**1** Select the desired practice function from the SONG SETTING page in the FUNCTION display (page 137).

Selects the specific practice function.

Turns the key guide lamps on/off.

Determines the timing by which the key guide lamps light.

**JUST** ..... The guide lamp lights in time with the music, at the same time you should play the appropriate notes.

**NEXT** ..... The guide lamps light slightly ahead of the music, indicating the notes you should play next. The guide lamp flashes if you do not play the key with the correct timing.

Determines the channel for playing back the harmony sound of the Vocoder.

Determines whether phrase mark sections in the song will be repeatedly played back or not. When this is set to ON, the specified measures of the phrase play back repeatedly. Call up the SONG POSITION display by pressing either the [REW] button or the [FF] button, and select "PHRASE MARK" by pressing the [J] button. Set the desired phrase mark number by using the [REW] and [FF] buttons.

**2** Select the desired song (page 75, 77) and mute the track you wish to practice (page 78).

**3**

**4**

Start the song and try playing the part you've muted.  
Adjust the tempo by using the **TEMPO** [◀][▶] buttons (page 51).

**5**

Stop the song.

To turn the practice function, press the button again.

**NOTE**  
For details on the **SONG SETTING** display, see page 137.

**NOTE**  
The guide lamps light according to song channel recorded to Tracks 1 and 2 and the chord data in the song (when such data is included). Normally, you can leave the **AUTO SET CH** function set to ON, and the song channel will automatically be set. If the results aren't satisfactory, you'll need to match the **Channel Setting "TRK1 CH"** and **"TRK2 CH"** parameters to the appropriate right- and left-hand parts.

**NOTE**  
**Vocoder**  
This lets you indicate or "play" the harmony notes from the keyboard.

**NOTE**  
**Phrase Mark**  
This data specifies a certain location in the song data.

**NOTE**  
Track 1 or Tracks 1 & 2 are automatically selected for practicing when calling the practice function — as long as you haven't muted the track to be practiced.

**NOTE**  
The key guide lamps sometimes light an octave or two lower/higher than the actual pitch. Any notes outside of the 88-key range cannot be indicated by the key guide lamps.

**NOTE**  
If the right- and left-hand parts recorded to the song data have not been properly separated, the practice functions may not work as expected.



# Displaying Music Notation — Score

With this feature, you can have the notation automatically shown on the display as the song plays. This can be used with your own recordings as well as the internal Demo songs.

**1** Select the desired song (page 75, 77).



**2**

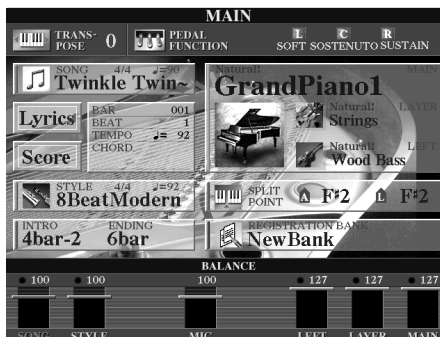
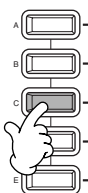

**NOTE**  
If the **MAIN** screen (at left) is not displayed, press the **[DIRECT ACCESS]** button followed by the **[EXIT]** button.

**3**

Enables/disables display of the left-hand key range. Depending on other settings, this parameter may be unavailable and may appear grayed out. If this is the case, go to the detailed setting display (shown below; use the **[8▲▼]** buttons) and set the **LEFT CH.** parameter to any channel except "AUTO." Or, go to the **SONG SETTING** display in the **Function** menu (page 137) and set the **TRACK 2** parameter to any channel except "OFF."

Enables/disables display of the right-hand key range. Channel 1 is automatically selected when **[TRACK1]** is set to **[OFF]** from the **SONG SETTING** display (page 137).

Enables/disables display of the lyrics. If the selected song does not contain lyric data, lyrics are not displayed.

Enables/disables display of the chords. If the selected song does not contain chord data, chords are not displayed.

Enables/disables display of the note name (pitch).

Determines the display resolution (or zoom level) of the notation. The resolutions are selected in order: **X-LARGE** (Extra Large), **LARGE**, **MEDIUM**, and **SMALL**.

This calls up the detailed setting display for notation. For details, see the next page.

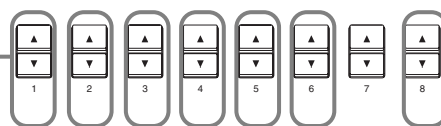

**NOTE**  
The displayed notation is generated by the Clavinova based on the song data. As a result, it may not be exactly the same as commercially available sheet music of the same song — especially when displaying notation of complicated passages or many short notes.

**NOTE**  
Some song data for the Clavinova has been recorded with special "free tempo" settings. For such song data, the tempo, beat, measure and music notation will not be displayed correctly.

**NOTE**  
**[RIGHT]** and **[LEFT]** cannot be turned off at the same time.

**NOTE**  
The note name is indicated at the left of the note. When the space between the notes is too small, the indication may be moved to the top left of the note.

**NOTE**  
You can increase the number of measures that will be displayed by decreasing the other items to be displayed (parts, lyrics, chords, etc.).

**NOTE**  
When accidentals (sharp and flats) and notes cannot be displayed on one line, they are displayed on the next line from the middle of the measure.

**NOTE**  
The notation functions cannot be used to create song data by inputting notes. For information on creating song data, see page 98.

## Detailed Settings for Notation

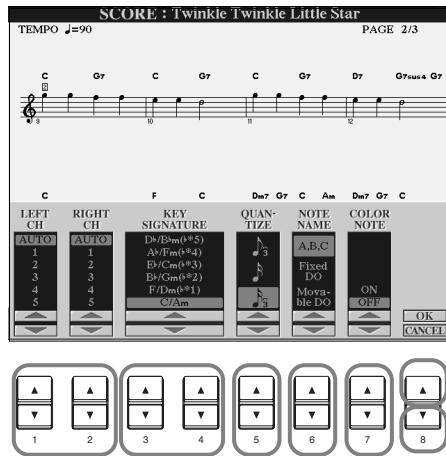

**NOTE**  
When "LEFT" and "RIGHT" are set to the same channel, the notation of the right-hand notes and left-hand notes are displayed in piano format (two connected staves).

### ■ [1▲▼] LEFT CH/[2▲▼] RIGHT CH

This determines the Left channel (channel for the left-hand part) and Right channel (channel for the right-hand part). This setting returns to **AUTO** when a different song is selected.

**AUTO** .....The channels for the right- and left-hand parts are assigned automatically — setting the parts to the same channel as the channel which is specified in the **SONG SETTING** display of the **Function** menu (page 137).

**1-16** .....Assigns the part to the specified channel, 1- 16.

**OFF (LEFT CH only)**.....No channel assignment.

### ■ [3▲▼], [4▲▼] KEY SIGNATURE

This lets you enter key signature changes in the middle of a song, at the stopped position, allowing you to transpose key at any point within a song. For a list of the key signatures, with their relative minor keys and accidentals, see the chart below.

#### Key Signatures and Accidentals

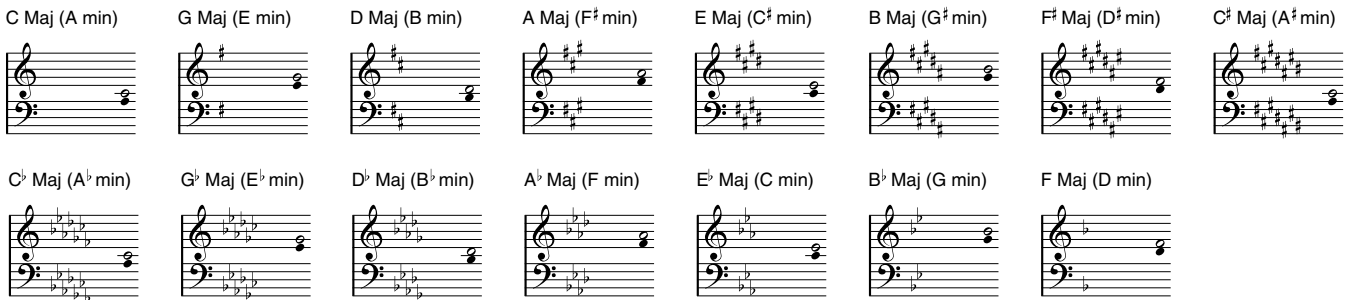

The  $\circ$  note indicates the root note of the major key, and the  $\bullet$  note indicates the root of the relative minor.

### ■ [5▲▼] QUANTIZE

This gives you control over the note resolution in the notation, letting you shift or correct the timing of all displayed notes so that they line up to a particular note value. Make sure to select the smallest note value which is used in the song.

#### Note resolution:

1/4 note, 1/8 note, 1/16 note, 1/32 note, 1/4 note triplet, 1/8 note triplet, 1/16 note triplet, 1/32 note triplet

**NOTE**  
Short notes and ornamented notes (such as trills and grace notes) which are shorter than the Note resolution will not be displayed in the notation.

## ■ [6▲▼] NOTE NAME

When [NOTE NAME] is set to ON, the note name and solfeggio name (do, re, mi, etc.) are indicated.

**ABC** ..... Note names are indicated as letters (C, D, E, F, G, A, B).

**Fixed Do** ..... Note names are indicated in solfeggio and differ depending on the selected language (page 50).

**English** ..... Do Re Mi Fa Sol La Ti

**French** ..... Ut Re Mi Fa Sol La Si

**Italian** ..... Do Re Mi Fa Sol La Si

**German** ..... Do Re Mi Fa Sol La Si

**Spanish** ..... Do re Mi Fa Sol La Si

**Japanese** ..... ドレミファソラシ

**Movable Do** ..... Note names are indicated in solfeggio according to the scale intervals, and as such are relative to the key. The root note is indicated as Do. For example, in the key of G major the root note of Sol would be indicated as Do.

As with “**Fixed Do**,” the indication differs depending on the selected language.

## ■ [7▲▼] COLOR NOTE

When this is set to ON, the notes in the display appear in color (C: red, D: yellow, E: green, F: orange, G: blue, A: purple, and B: white).

## ■ [8▲] OK

This closes the detailed setting display and starts generating the notation. You can also execute this by pressing the [ENTER] button on the panel.

## ■ [8▼] CANCEL

This closes the detailed setting display without changing the settings. You can also execute this by pressing the [EXIT] button or [RECORD] button on the panel.

### **D** NOTE

You can select the display pages (one before and after) by the using the [BACK]/[NEXT] buttons or the pedal (page 139).

# Displaying the Lyrics

This function lets you display the lyrics while the song is playing back — making it easy to sing along with your performance or song playback.

**1** Select the desired song (page 75, 77).

**2**

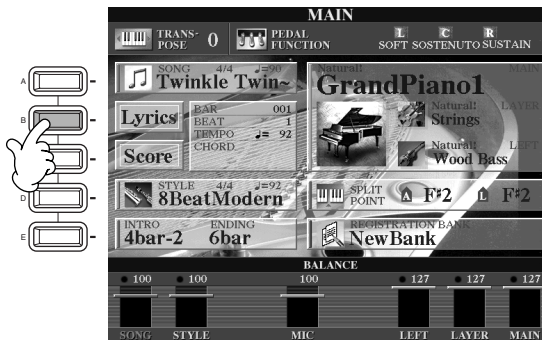

**NOTE**

The language used for lyrics display depends on the particular lyric data. If the lyrics are garbled or unreadable, you can remedy this by changing the "LYRICS LANGUAGE" setting from the SONG SETTING display (page 137).

**3**



Select the BACK GROUND setting.

**NOTE**

When the back ground color is specified in the song data, the BACK GROUND setting cannot be changed.

**NOTE**

If the selected song does not contain lyric data, lyrics are not displayed.

**NOTE**

If the selected song contains chord data, chord names are displayed with the lyrics.

**NOTE**

The lyrics can also be shown on a connected TV (page 144, 153).

**4**

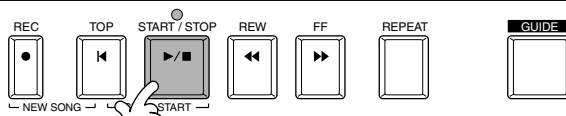

Start the song.

**5**

The color of the lyrics changes as the song plays.

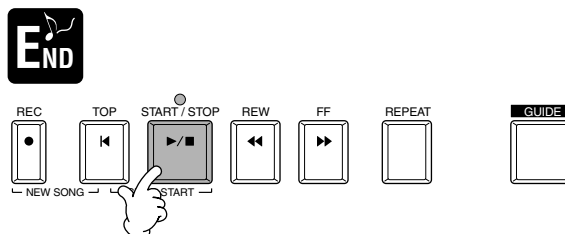

Stop the song.  
To return to the previous page, press the EXIT button.

**NOTE**

The lyrics can be changed (page 109).

# Saving and Recalling Custom Panel Setups — Registration Memory

Registration Memory is a powerful feature that lets you set up the Clavinova just as you want — selecting specific voices, styles, effect settings etc. — and save your custom panel setup for future recall. Then, when you need those settings, simply press the appropriate REGISTRATION MEMORY button.

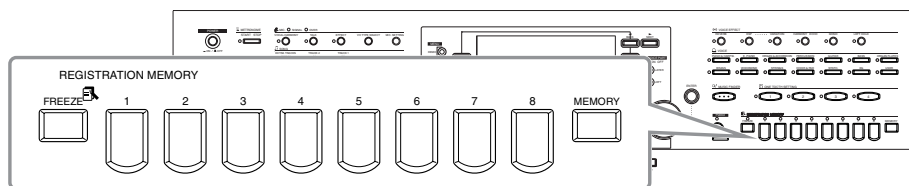

## Registering Panel Setups — Registration Memory

This shows you how to register your custom panel settings to the REGISTRATION MEMORY buttons. Make all the settings you want with the panel controls, and Registration Memory will “remember” them for you.

### 1 Set up the panel controls as desired.

For a list of the settings that can be registered, refer to the separate Data List (Parameter Chart).

### 2

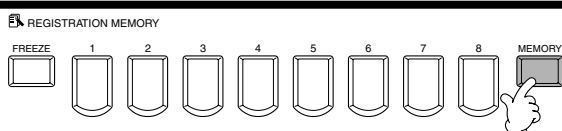

### 3

#### Select the desired parameter groups for the settings you want to register.

You can also use the [DATA ENTRY] dial to navigate in this display. To register a parameter group, checkmark the corresponding box. Groups left without checkmarks will not be included in the Registration Memory setting. This allows you to maintain certain settings, even when switching among Registration Memory presets. You can also use the Freeze function (page 87) to override the Registration Memory changes — letting you prevent certain panel settings from being changed.

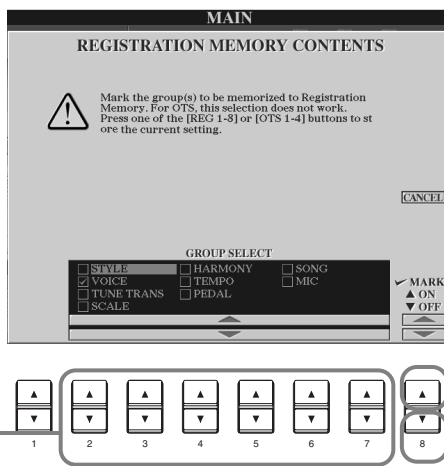

Cancels the registration and returns to the MAIN display. You can also use the [EXIT] button.

Enters a checkmark to the selected box. You can also use the [ENTER] button.

Removes the checkmark from the selected box. You can also use the [ENTER] button.

### Press the desired number button for registering the settings.

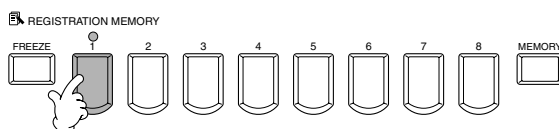

**Indicator is green** ..... The panel setting is registered, but not selected.

**Indicator is red**..... The panel setting is registered and is currently selected.

**Indicator is off**..... The panel setting is not registered.

#### NOTE

The registrations registered here will be lost when the power is turned off, unless you perform the Save operation explained on the next page.

#### NOTE

Any data that was previously registered to the selected REGISTRATION MEMORY button (indicator is green or red) will be erased and replaced by the new settings.

## Saving Your Registration Memory Setups

The settings registered to the **REGISTRATION MEMORY [1]-[8]** buttons are saved as a single file.

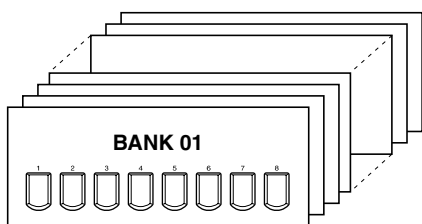

All settings registered to buttons **[1]-[8]** are referred to as a “bank.” The banks can be saved to “**USER**” or “**FLOPPY DISK**” as Registration bank files.

**NOTE**

Keep in mind that the size of the Registration bank files and the memory space they occupy depends on the amount of functions set in each.

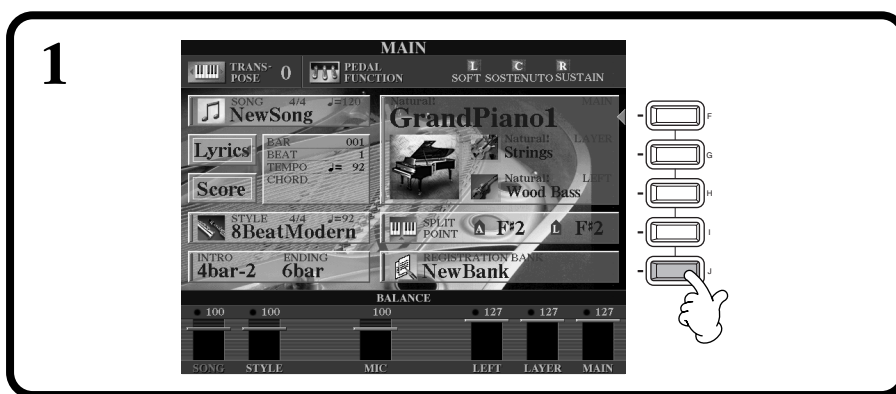

**NOTE**

Press the **[DIRECT ACCESS]** button and **[EXIT]** button to call up the MAIN display.

**2** Save the settings you’ve made to the Registration Memory buttons as a single Registration bank file (page 45).

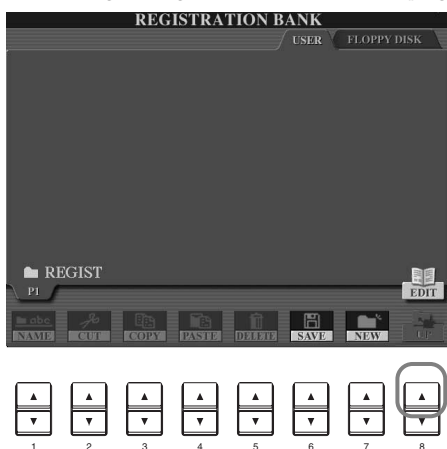

The **REGISTRATION EDIT** display appears. For details on this display, see below.

### REGISTRATION EDIT display

The contents of the current Registration Memory bank (REGIST.) are listed in the **REGISTRATION EDIT** screen. The names of the stored Registration Memory presets are shown in the display and the indicators of the relevant **REGISTRATION MEMORY** buttons are lit in green.

From this screen, you can select, name, or delete the Registration Memory presets.

**Select** ..... Press the **[A] - [J]** buttons. The REGIST. display is linked to the **REGISTRATION MEMORY [1] - [8]** buttons. When you select the Registration Memory preset in the display, the related button turns on (indicator is red).

**Name** ..... This operation is the same as that in “Naming Files and Folders” (page 42) in “Basic Operations — Organizing Your Data.”

**Delete** ..... This operation is the same as that in “Deleting Files/Folders” (page 44) in “Basic Operations — Organizing Your Data.”

**NOTE**

The result of the Name/Delete operation will be lost when the power is turned off unless you return to the **REGISTRATION BANK** display by pressing the **[8▼] (UP)** button and save the data (page 45).

## Recalling a Registration Memory Setup

You can recall all of the panel settings you've made — or only those you specifically want or need. For example, if you de-select "STYLE" in the **REGISTRATION MEMORY** display, you can keep the currently selected style even when you change the Registration Memory preset.

### Recalling the Registered Settings

Select the desired bank in the **REGISTRATION BANK** display (page 86). Press the appropriate **REGISTRATION MEMORY** button (any whose indicators are green) to recall the desired settings.

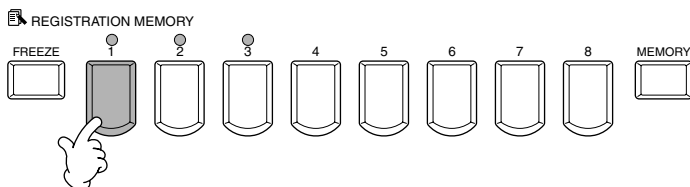

**NOTE**

You can program your Registration Memory presets to be called up in sequence, in any order you desire. Once programmed, the presets 1 - 8 can be selected in sequence with the **[BACK][NEXT]** buttons or the pedal (page 142).

### Selecting the Freeze Settings

**1**

Call up the "FREEZE" page from the **REGIST.SEQUENCE/FREEZE/VOICE SET** screen (page 142).

**2**

FREEZE GROUP SETTING		
GROUP SELECT		
<input checked="" type="checkbox"/> STYLE	<input type="checkbox"/> HARMONY	<input checked="" type="checkbox"/> SONG
<input type="checkbox"/> VOICE	<input checked="" type="checkbox"/> TEMPO	<input type="checkbox"/> MIC
<input type="checkbox"/> TUNE TRANS	<input type="checkbox"/> PEDAL	
<input type="checkbox"/> SCALE		

Enter a checkmark to the selected box.

Removes the checkmark from the selected box.

Select the Freeze settings.

**3** Press the **[FREEZE]** button. When Freeze is active (lamp is lit), the settings you specified in the Freeze page will be maintained or left unchanged, even when changing Registration Memory presets.

**4** Press the appropriate **REGISTRATION MEMORY** button (any whose indicators are green) to recall the desired settings.

# Editing Voices — Sound Creator

The CVP-209/207 has a Sound Creator feature that allows you to create your own voices by editing some parameters of the existing voices. Once you've created a voice, you can save it as a USER voice for future recall.

## NOTE

- The Voice can be edited in realtime while playing back a song/style.
- Keep in mind that adjustments made to the parameters may not make much change in the actual sound depending on the original settings of the voice.

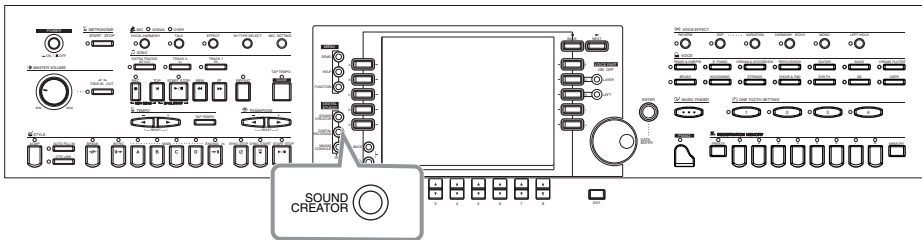

## Operation

- 1 Press the [F], [G] or [H] button to select the Part (MAIN, LAYER or LEFT) containing the voice you wish to edit.

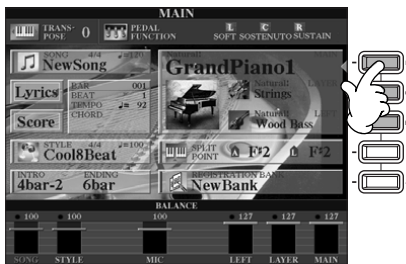

- 2 Press the [SOUND CREATOR] button.



## NOTE

The voice can also be selected in the SOUND CREATOR display.

## CAUTION

The settings are lost if the edited part's voice is switched to another voice. Important data should be saved to User Drive or floppy disk.

- 3 Edit the voice parameters. The operations for each function selected in this step are covered in detail, starting on page 90 (Natural/Regular Voice) and page 93 (Organ Flutes).

Select the desired menu by pressing the [NEXT]/[BACK] button.

### NATURAL VOICE

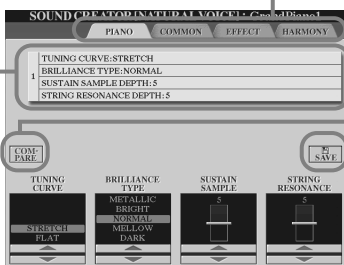

Indicates the parameters available for editing in this display. These correspond to the parameters/values shown at the bottom of the display.

### REGULAR VOICE

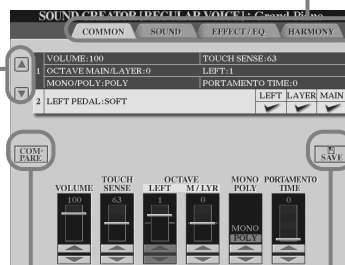

Select the desired menu. The selected menu is highlighted.

Can be used during editing to compare the sound of the original voice with the edited voice.

### ORGAN FLUTES



Opens the Save (Voice) display for saving the edited voice as a User voice (page 45).

- 4 Save the edited voice to the USER drive (Flash ROM) as a USER voice (page 45).

- 5 Press the [USER] button to select the edited voice, and play the keyboard.



## SOUND CREATOR Parameters (Natural/Regular Voices)

PIANO	Determines the parameters unique to piano sounds, such as tuning curve or sustain sampling. This page is available only when the Natural piano voice is selected.
COMMON	Determines the common settings such as voice volume or octave.
SOUND	Determines the timbre/EG (Envelope Generator)/vibrato of the voice (Regular voice only).
EFFECT/EQ	Determines the effect depth/type and equalizer settings.
HARMONY	Determines the Harmony/Echo settings.

**NOTE**

The available parameters differ depending on the selected voice type, Regular or Natural (see below).

**NOTE**

Keep in mind that there are certain parameters whose Sound Creator settings affect only the Main part's voice.

The parameters for Organ Flutes, see page 93.

The following parameters are linked to the ones in each display.

Common parameter	Other location	
MONO	VOICE EFFECT (TOP PANEL)	page 59
PORTAMENTO TIME	MIXING CONSOLE	page 122
LEFT PEDAL TYPE	CONTROLLER (FUNCTION)	page 139
LEFT PEDAL SETTING	CONTROLLER (FUNCTION)	page 139
FILTER BRIGHTNESS	MIXING CONSOLE	page 122
FILTER HARMONIC CONTENT	MIXING CONSOLE	page 122
REVERB DEPTH	MIXING CONSOLE	page 123
CHORUS DEPTH	MIXING CONSOLE	page 123
DSP ON/OFF	VOICE EFFECT (TOP PANEL)	page 58
DSP DEPTH	MIXING CONSOLE	page 123
DSP TYPE/VARIATION	MIXING CONSOLE/VOICE EFFECT (TOP PANEL)	page 58,123
EQ LOW GAIN	MIXING CONSOLE	page 125
EQ HIGH GAIN	MIXING CONSOLE	page 125
HARMONY/ECHO TYPE	HARMONY/ECHO (FUNCTION)	page 143
HARMONY/ECHO VOLUME	HARMONY/ECHO (FUNCTION)	page 143
HARMONY/ECHO SPEED	HARMONY/ECHO (FUNCTION)	page 143
HARMONY/ECHO ASSIGN	HARMONY/ECHO (FUNCTION)	page 143
HARMONY/ECHO CHORD NOTE ONLY	HARMONY/ECHO (FUNCTION)	page 143
HARMONY/ECHO TOUCH LIMIT	HARMONY/ECHO (FUNCTION)	page 143

### Natural Voices and Regular Voices

Built into the CVP-209/207 are two different tone generation sources, Natural and XG. The Natural tone generation source and its voices feature a huge amount of wave memory, giving you enormous and finely detailed expressive power over the sound. The XG source (which powers the Regular voices) provide maximum compatibility with a wide variety of devices and song data.

The maximum amount of polyphony for each tone generation source is set up to best enhance your performance. In general, the songs and styles are played back using the XG source, while the Natural voices are played from the keyboard — allowing you to play the Natural voices with full polyphony, even if the song and style data exceeds the polyphonic limit.

**NOTE**

Voices sounded with the XG source are divided into two groups. One is the original set of Clavinova voices (Cool!, Sweet!, Live!, Live!Drums, Organ Flutes), and the other is the conventional XG set.

Natural!	Cool!	Sweet!	Live!	Live!Drums	OrganFlutes!	XG
Clavinova-exclusive voices						GM/XG-compatible voices
Natural voices (sounded by Natural tone generation source)	Regular voices (sounded by XG tone generation source)					
Used mainly for keyboard-played voices	For keyboard-played voices, song/style playback*					

\* Depending on the particular style selected, a Natural voice may be used for the accompaniment. Usually, songs are played back using the XG voices (page 160); however, you can have them automatically “re-voiced” — using the exceptionally rich and realistic sounds exclusive to the CVP-209/207 (page 121).

## PIANO (Natural Piano Voice has been selected)

The explanations here apply to step #3 on page 88.

Determines the tuning curve, especially for piano voices. Select "FLAT" if you feel the tuning curve of the piano voice does not quite match that of other instruments voices.

**STRETCH**.. Tuning curve particularly for pianos

**FLAT** ..... Tuning curve in which the frequency is octave doubled over the entire keyboard range

These controls are used to adjust the brilliance of the tone. This setting affects all Natural voices globally. When other than piano voice (Natural) is selected, set this on EFFECT page. For details, see the EFFECT page (page 92).

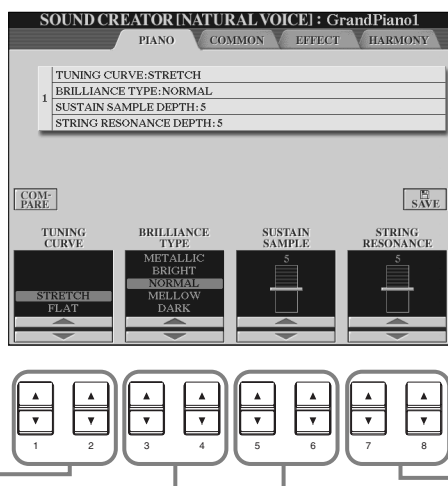

**NOTE**  
The available parameters differ depending on the selected voice.

Determines the depth of string resonance.

Determines the depth of sustain sampling for the damper pedal.

## COMMON

The explanations here apply to step #3 on page 88.

The parameters are the same as for CONTROLLER display. For details, see page 139.

Set the volume of the current edited voice.

Determines the touch sensitivity, or how greatly the volume responds to your playing strength.

- 0 — Produces more dramatic level drops, the more softly you play.
- 64 — Normal response.
- 127 — Produces high volume for any playing strength (fixed).

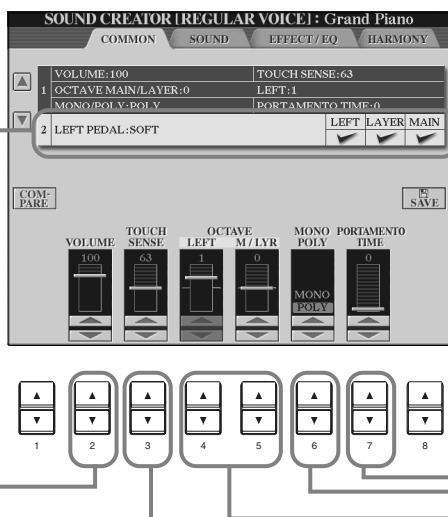

Set the portamento time of each part (MAIN/LAYER/VOICE) (Regular Voice only) (page 122).

This determines whether the voice is played monophonically (Regular Voice only) (page 59).

Shift the octave range of the selected voice up or down in octaves. When the Main or Layer part's voice is used, the M/LYR parameter is available; when the Left part's voice is used, the LEFT parameter is available.

## SOUND (Regular Voice only)

The explanations here apply to step #3 on page 88.

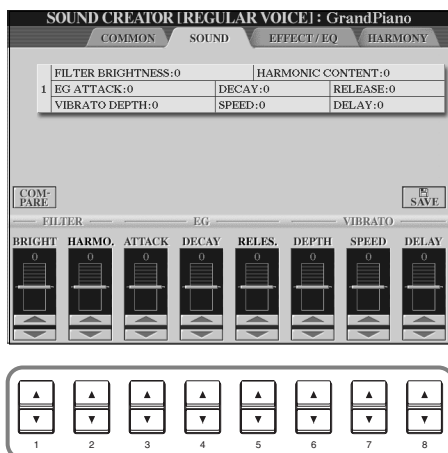

Determines the filter, EG, and vibrato settings (see below).

■ **FILTER**

FILTER settings determine the overall timbre of the sound by boosting or cutting a certain frequency range.

**NOTE**  
In addition to making the sound either brighter or more mellow, Filter can be used to produce electronic, synthesizer-like effects.

• **BRIGHTNESS**

Determines the cutoff frequency or effective frequency range of the filter (see diagram). Higher values result in a brighter sound.

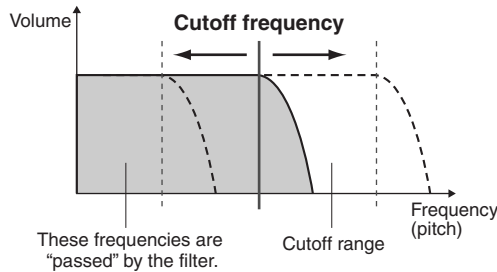

• **Harmonic Content**

Determines the emphasis given to the cutoff frequency (resonance), set in BRIGHTNESS above (see diagram). Higher values result in a more pronounced effect.

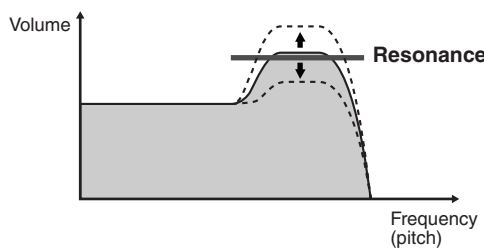

■ **EG**

The EG (Envelope Generator) settings determine how the level of the sound changes in time. This lets you reproduce many sound characteristics of natural acoustic instruments — such as the quick attack and decay of percussion sounds, or the long release of a sustained piano tone.

- **ATTACK** ..... Determines how quickly the sound reaches its maximum level after the key is played. The higher the value, the slower the attack.
- **DECAY** ..... Determines how quickly the sound reaches its sustain level (a slightly lower level than maximum). The higher the value, the slower the decay.
- **RELEASE** ..... Determines how quickly the sound decays to silence after the key is released. The higher the value, the slower the release.

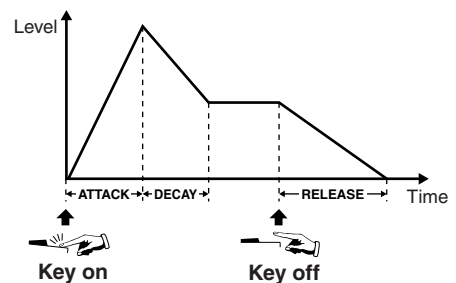

**NOTE**  
If RELEASE is set to a large value, the sustain becomes long.

■ **VIBRATO**

- **DEPTH** ..... Determines the intensity of the Vibrato effect (see diagram). Higher settings result in a more pronounced Vibrato.
- **SPEED** ..... Determines the speed of the Vibrato effect (see diagram).
- **DELAY** ..... Determines the amount of time that elapses between the playing of a key and the start of the Vibrato effect (see diagram). Higher settings increase the delay of the Vibrato onset.

**NOTE**  
**VIBRATO**  
Creates a wavering in the sound by periodically changing the pitch.

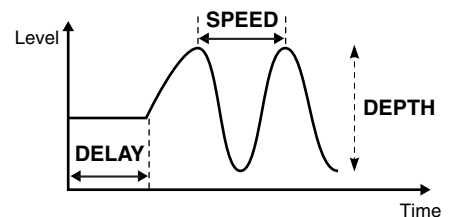

## EFFECT/EQ

The explanations here apply to step #3 on page 88.

### NATURAL VOICE

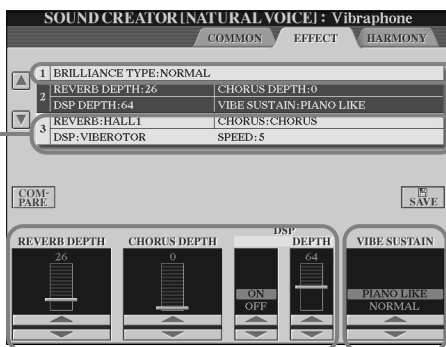

Determines the effect type (Reverb/Chorus/DSP). When a regular voice is selected, the DSP type and Variation are set in two separate menus. For information on the effect structure, see page 126; for a list of available effect types, refer to the separate Data List.

Determines the brilliance of the tone, when a Natural voice is selected. This can also be set from the PIANO page (page 90), when a piano voice is selected.

- **Metallic** ..... Sharp metallic tone
- **Bright** ..... Bright tone
- **Normal** ..... Standard tone
- **Mellow** ..... Soft and mellow tone
- **Dark** ..... Dark tone

#### NOTE

- If you select [Bright] or [Metallic] as the type of brilliance, the volume level will increase slightly. In this case, raising the [MASTER VOLUME] may result in distortion. If this happens, lower the volume accordingly.
- "SPEED" parameter is added when selecting VIBE ROTOR DSP type. This parameter enables you to set the speed of vibrato when you select the Vibraphone voice, recreating the effect of a vibrate pedal.

This parameter enables you to select whether the sound is sustained while you press the keys on the keyboard ("PIANO LIKE"), or the sound is sustained only while you press and hold down the sustain pedal, like playing a real vibraphone ("NORMAL") (for Vibraphone voice).

The same as the "Mixing Console" on page 123.

### REGULAR VOICE

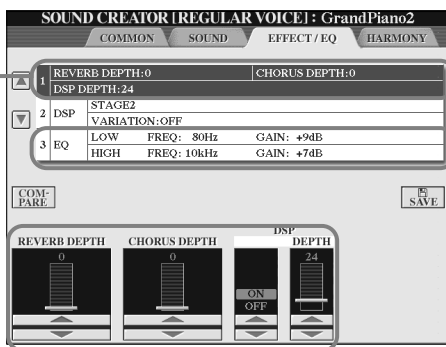

The same as the "Mixing Console" on page 123.

Determines the Frequency and Gain of the Low and High EQ bands.

## HARMONY

The explanations here apply to step #3 on page 88.

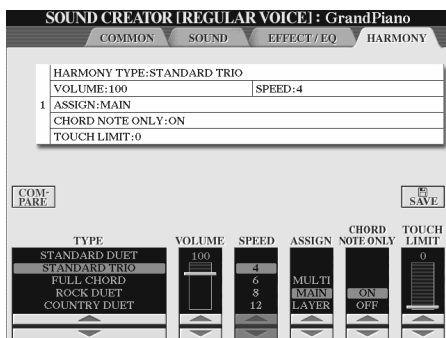

The parameters are the same as for HARMONY/ECHO display of FUNCTION. For details, see page 144.

# Organ Flutes

In addition to the many organ voices in the ORGAN voice category, the CVP-209/207 has an ORGAN FLUTES voice. The explanations here apply to step #3 on page 88.

## Operation

Use button [1▲▼] to adjust the 16' or 5 1/3' footage. You can select the desired footage (16' or 5 1/3') with the [D] button (CVP-209 only).



Select or adjust the parameters (see below).

Adjust the Footage.

**NOTE**

The tremolo and trill effects set via the Harmony/Echo function (page 143) do not affect the Organ Flutes sound (CVP-209 only).

### Parameters

Organ Type	This parameter specifies the type of organ tone generation to be simulated: Sine or Vintage.	
Rotary SP Speed	The Rotary SP Speed ([C]) button alternately switches between the slow and fast rotary speaker speeds when a rotary speaker effect is selected for the Organ Flutes (see "DSP Type" below), and the VOICE EFFECT [DSP] button is turned on (the Rotary SP Speed button has the same effect as the VOICE EFFECT [VARIATION] button).	
Vibrato On/Off	This ([G]) button alternately turns the vibrato effect for the Organ Flutes voice ON or OFF.	
Vibrato Depth	Can be set to any of three levels via the Vibrato Depth ([H]) button. The button sequentially selects a depth of "1", "2", or "3".	
Footage	The footage settings determine the basic sound of the organ flutes. The term "footage" is a reference to the sound generation of traditional pipe organs, in which the sound is produced by pipes of different lengths (in feet). The longer the pipe, the lower the pitch of the sound. Hence, the 16' setting determines the lowest pitched component of the voice, while the 1' setting determines the highest pitched component. The higher the value of the setting, the greater the volume of the corresponding footage. Mixing various volumes of the footages lets you create your own distinctive organ sounds.	
Volume (VOL)	Adjusts the overall volume of the Organ Flutes. The longer the graphic bar, the greater the volume.	
Response (RESP)	The Response control affects both the attack and sustain portion of the sound, increasing or decreasing the response time of the initial swell and release, based on the FOOTAGE controls. The higher the value the slower the swell and release.	
Vibrato Speed	Determines the speed of the vibrato effect controlled by the Vibrato On/Off and Vibrato Depth above.	
Mode	The MODE control selects between two modes: FIRST and EACH. In the FIRST mode, attack is applied only to the first notes played and held simultaneously; while the first notes are held, any subsequently played notes have no attack applied. In the EACH mode, attack is applied equally to all notes.	
Attack (4', 2 2/3', 2')	The ATTACK controls adjust the attack sound of the ORGAN FLUTE voice. The 4', 2 2/3' and 2' controls increase or reduce the amount of attack sound at the corresponding footages. The longer the graphic bar the greater the attack sound.	
Length (LENG)	The LENGTH control affects the attack portion of the sound producing a longer or shorter decay immediately after the initial attack. The longer the graphic bar the longer the decay.	
Reverb Depth Chorus Depth DSP on/off DSP Depth	For details about the digital effects, see pages 58, 123.	
DSP Type	Determines the DSP effect type to be applied to the Organ Flutes voice. Normally this will be one of the fifteen (CVP-209), or seven (CVP-207) available Rotary Speaker effects. If any other type of effect is selected the Rotary SP Speed ([C]) button in the FOOTAGE/VOL/ATTACK display will not control rotary speaker speed. Instead, it will have the same effect as the VOICE EFFECT [VARIATION] button.	
Variation	Variation	Determines whether the DSP variation will be set to Slow or Fast when the Organ Flutes voice is selected (when the Voice Set function is ON — page 143).
	Value	Sets the DSP variation parameter value (e.g., "LFO Freq" for a Rotary Speaker effect) when the DSP variation is turned on.
EQ Low EQ High	The EQ parameters determine the Frequency and Gain of the Low and High EQ bands.	

# Recording Your Performances and Creating Songs

## — Song Creator

With these powerful yet easy-to-use song creating features, you can record your own keyboard performances and store them for future recall. Several different recording methods are available: Quick Recording (page 95), which lets you record easily and quickly; Multi Recording (page 96), which lets you record several different parts; and Step Recording (page 98), which lets you enter notes one by one. Songs can include not only the voice settings for the keyboard performance (Main, Layer, Left), but also the effects, auto accompaniment parts, and Vocal Harmony. The recorded song can be stored to internal memory or floppy disk (page 39, 45).

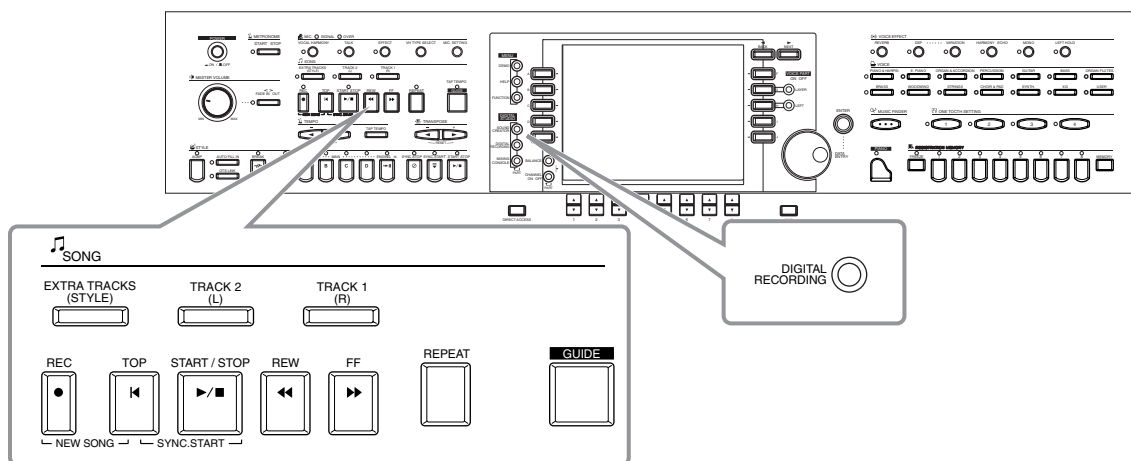

## About Song Recording

### ■ Quick Recording (page 95)

This is the easiest recording method, and lets you quickly record the piano song you are practicing. You can select from three parts: right hand, left hand and auto accompaniment. For example, you can record only your right hand performance, or you can simultaneously record both your right hand and the auto accompaniment.

### ■ Multi Recording (page 96)

This lets you record a song with several different instrument sounds, and create the sound of a full band or orchestra. Record the performance of each instrument individually and create fully orchestrated compositions. You can also record over an existing part on an internal song or a song on disk with your own performance.

### ■ Step Recording (page 98)

This method is like writing music notation on paper. It lets you enter each note individually, by specifying the pitch and length. This is ideal for making precise recordings, or for recording parts that are difficult to play.

### ■ Song Editing (page 104)

The CVP-209/207 also lets you edit the songs you've recorded by the Quick Recording, Multi Recording and Step Recording methods.

#### NOTE

- The internal memory capacity of the Clavinova is about 3.3MB. Memory capacity for 2DD and 2HD floppy disks is about 720KB and 1.44MB, respectively. When you store data to these locations, all file types of the Clavinova (Voice, Style, Song, Registration, etc.) are stored together.
- The microphone input signal cannot be recorded.
- Songs recorded on the CVP-209/207 are automatically recorded as SMF (Standard MIDI File format 0) data. For details on SMF see page 159.
- Playback of the recorded song data can be transmitted from MIDI OUT, letting you play the sounds of a connected external tone generator (page 146).
- The volume level of each channel of the song can be adjusted from the Mixing Console and the settings can be saved. Moreover, even after you've set a voice for your keyboard play during recording, you can record voice selections, so that the voice changes automatically during playback (page 106).

## Quick Recording

This is the easiest recording method — perfect for quickly recording and playing back a piano song you're practicing, so you can check your progress.

### ■ When creating a new song:

1

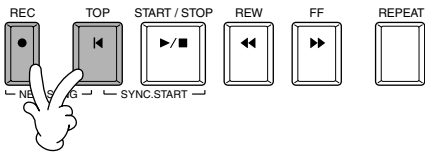

### ■ When recording over the part of an internal song or a song on disk with your own performance:

1 Select the desired song (page 75, 77).

2 Select the voice and accompaniment style you want to use in the song.

If you want to record to the Layer/Left voices, make sure to set the [LAYER]/[LEFT] buttons to ON. Make any other desired settings (Reverb, Chorus, etc.) as well.

3 Simultaneously hold down the [REC] button and press the button corresponding to the track you want to record.

You can select TRACK 1 or TRACK 2 and the EXTRA TRACKS for recording at the same time.

#### To record your keyboard performance:

Press either the [TRACK 1] or [TRACK 2] button.

#### To record the auto accompaniment performance:

Press the [EXTRA TRACKS] button.

To stop recording, press the [REC] button again.

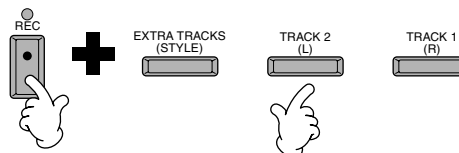

#### NOTE

If the "LAYER" or "LEFT" button is on before pressing the REC button, the corresponding Layer and Left parts are automatically recorded to different channels.

#### NOTE

The performance of track 1/2 is recorded to the channel specified in the SONG SETTING display (page 137).

#### NOTE

You can overdub a second right-hand performance onto Track 2 after recording the first right-hand performance (including the layer voices) on Track 1. To do this, set the [LEFT] button to OFF and repeat steps 2 and 3.

#### NOTE

To pause, press the SONG [START/STOP] button. To resume recording, press the SONG [START/STOP] button again.

#### NOTE

You can also use the metronome click as a guide while recording. The sound of the metronome is not recorded.

4 Recording starts as soon as you play the keyboard.

You can also start recording by pressing the SONG/STYLE [START/STOP] button. Recording can also be started by pressing down the pedal, if the song start/stop function is properly assigned to the pedal (page 139).

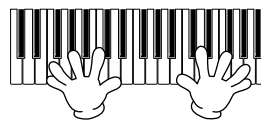

To stop recording, press the [RECORD] button again.

Recording can also be stopped by pressing down the pedal, if the song start/stop function is properly assigned to the pedal (page 139).

### ■ Play back your new song

To play back the performance you just recorded, return the song to the beginning by using the [TOP] button and press the SONG [START/STOP] button.

Playback stops automatically at the end of the song, and returns to the beginning of the song.

You can edit the recorded song data from the SONG CREATOR (1 - 16) displays (page 107).

Press the [6▼] button from the Open/Save display for Song to store the recorded data (page 39, 45).

#### CAUTION

Turning off the power automatically deletes your recorded performance. If you wish to save the recording, make sure to store it to internal memory (USER drive) or floppy disk (page 39, 45).

# Multi Recording

This lets you record a song with several different instrument sounds on up to sixteen channels, and create the sound of a full band or orchestra.

The structure of the channels and parts are shown in the chart below.

Channels	Parts (default settings)	Available parts	Channels	Parts (default settings)	Available parts
1	Voice MAIN	Voice MAIN, LAYER, LEFT Accompaniment style RHYTHM 1 Accompaniment style RHYTHM 2 Accompaniment style BASS Accompaniment style CHORD1 Accompaniment style CHORD2 Accompaniment style PAD Accompaniment style PHRASE1 Accompaniment style PHRASE2 MIDI	9	Accompaniment style RHYTHM 1	Voice MAIN, LAYER, LEFT Accompaniment style RHYTHM 1 Accompaniment style RHYTHM 2 Accompaniment style BASS Accompaniment style CHORD1 Accompaniment style CHORD2 Accompaniment style PAD Accompaniment style PHRASE1 Accompaniment style PHRASE2 MIDI
2	Voice MAIN		10	Accompaniment style RHYTHM 2	
3	Voice MAIN		11	Accompaniment style BASS	
4	Voice MAIN		12	Accompaniment style CHORD1	
5	Voice MAIN		13	Accompaniment style CHORD2	
6	Voice MAIN		14	Accompaniment style PAD	
7	Voice MAIN		15	Accompaniment style PHRASE1	
8	Voice MAIN		16	Accompaniment style PHRASE2	

**About the accompaniment style parts**

- Rhythm** ..... This is the basis for the accompaniment, containing the drum and percussion rhythm patterns. Usually one of the drum kits is used.
- Bass** ..... The Bass part uses various appropriate instrument sounds to match the style, such as acoustic bass, synth bass, and others.
- Chord** ..... This is the rhythmic chord backing, commonly used with piano or guitar voices.
- Pad** ..... This part features sustained chords and commonly uses lush sounds such as strings, organ, and choir.
- Phrase** ..... This part is used for various embellishments and riffs that enhance the song, such as brass section accents and chord arpeggios.

■ When creating a new song:

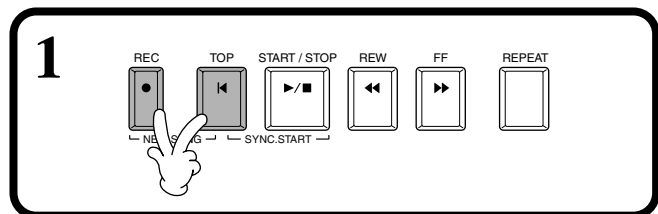

■ When recording over the part of an internal song or a song on disk with your own performance:

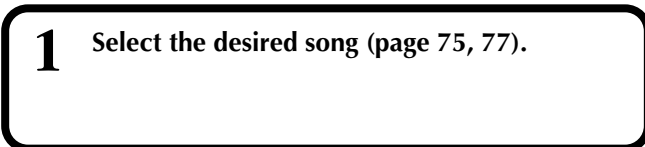

**2 Select the desired channel for recording (set it to "REC") simultaneously holding down the [REC] button and pressing the appropriate button [1▲▼] - [8▲▼]. Several channels can be selected at the same time.**

**REC** ..... Enables recording for the channel  
**ON** ..... Enables playback of the channel  
**OFF** ..... Mutes the channel

To cancel or disable recording, press the [REC] button once again.

SONG	STYLE	CHANNEL ON / OFF							
1	2	3	4	5	6	7	8	9	10
ON	ON	ON	ON	ON	ON	ON	ON	ON	ON
9	10	11	12	13	14	15	16		
ON	ON	ON	ON	ON	ON	ON	ON	ON	ON

**NOTE**  
The part is automatically selected when setting the several channels to "REC" at the same time.



**3 Select the part you want to assign to the channel to be recorded.**

This determines which of the keyboard-played parts (Main/Layer/Left) and the accompaniment style parts (RHYTHM 1/2, BASS, etc.) are recorded to the recording channels selected in step #2.

For a list of the initial default assignments, see page 96.

**4 Recording starts as soon as you play the keyboard.**

You can also start recording by pressing the SONG/STYLE [START/STOP] button. The recording can be started/stopped by pressing the pedal if the recording punch in/out function is set to the pedal (page 103).

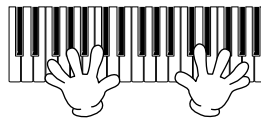
**5 To stop recording, press the [REC] button again.**

You can also use the pedal to stop recording by releasing it, if the recording punch in/out function has been assigned to the pedal (page 103).

**6 Play back your new song.**

To play back the performance you just recorded, return the song to the beginning by using the [TOP] button and press the SONG [START/STOP] button.

Playback stops automatically at the end of the song, and returns to the beginning of the song.

**To record a new part, repeat steps 2 - 6 above.**

You can set previously recorded parts to play back, and monitor them while you record a new part. Continue in this way until you have a finished song.

You can edit the recorded song data from the SONG CREATOR (1 - 16) displays (page 107).

Press the [6▼] button from the Open/Save display for Song to store the recorded data (page 39, 45).

**NOTE****When selecting the MIDI part**

- **Setting a single channel to MIDI**  
All incoming data received via any of the MIDI channels 1 - 16 is recorded. When using an external MIDI keyboard or controller to record, this lets you record without having to set the MIDI transmit channel on the external device.
- **Setting several channels to MIDI**  
When using an external MIDI keyboard or controller to record, this records data only over the set MIDI channel — meaning the external device must also be set to the same channel.

**NOTE**

A single part (with the exception of MIDI parts) cannot be assigned to several channels.

**NOTE**

The settings of the recorded parts is stored temporarily until you execute Quick Recording, select a song, or turn the power off.

**NOTE**

To pause, press the SONG [START/STOP] button. To resume recording, press the SONG [START/STOP] button again.

**NOTE**

You can also use the metronome click as a guide while recording. The sound of the metronome is not recorded.

**CAUTION**

Turning off the power automatically deletes your recorded performance. If you wish to save the recording, make sure to store it to internal memory (USER drive) or floppy disk (page 39, 45).

# Recording Individual Notes — Step Record

This method lets you create a song by entering notes one by one, without having to perform them in real time. This is also convenient for recording the chords and the melody separately.

## Operation

**1** Select an existing song (page 75, 77) to which you want to add parts or re-record. If you want to create a new song, simultaneously press the [RECORD] button and the [TOP] button.



**2** Press the [DIGITAL RECORDING] button.



**3** Press the [A] button to call up the Song Creator display.

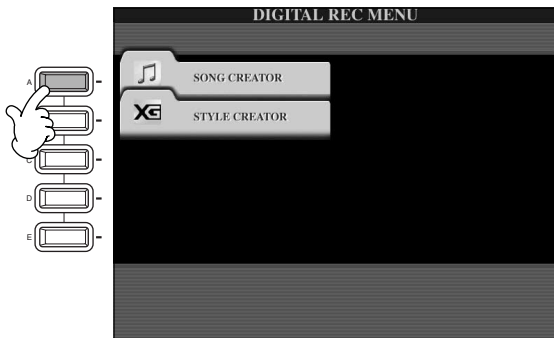

**4** Using the [BACK]/[NEXT] buttons, select the “1 -16” tab for recording melodies and other parts, or select the “CHD” (Chord) tab for recording chords, and after selecting the “1-16” tab, select a record channel with the [F] (CH) button.

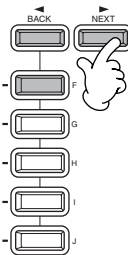
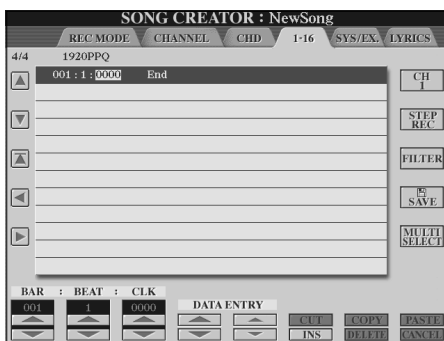

**5** Call up the Step Record display by pressing the [G] button.



**NOTE**  
Any voice, effect and other settings you make in the Mixing Console are automatically cancelled when you call up the CHD (Chord) page.

**NOTE**  
The voices in the USER and FLOPPY DISK pages cannot be selected for Step recording. You can select voices from the PRESET page; however, these may sound slightly different from the original voice.



**6** First, select the desired voice. To enter the note, first specify the length and loudness in this display, then enter the pitch by actually playing the note on the keyboard.

**SONG CREATOR : NewSong**  
STEP RECORD

4/4 1920PPQ

001 : 1 : 0000	Note	F3	84	0002 : 0000
001 : 3 : 0960	Note	E3	70	0000 : 0768
001 : 4 : 0000	Note	F3	67	0000 : 0768
001 : 4 : 0960	Note	A3	72	0000 : 0768
002 : 1 : 0000	Note	A3	87	0002 : 0768
002 : 4 : 1536	End			

BAR : BEAT : CLK  
002 4 0000

Controls and Callouts:

- A, B, C, D, E:** Moves the cursor position up and down.
- C:** Returns the cursor to the beginning of the song (the first note of the first measure).
- 1-8:** Use these to move the selected event, in units of measures (BAR), beat, and clocks. For information on measure/beat/clock settings, see below.
- 1-8 (Note Type):** Specifies the type of note to be input next. (Sixteenth notes are available only when recording the melody.) This also determines the position to which the pointer will advance after a note has been entered.
- F, G, H, I, J:** Determines the velocity (loudness) of the note to be entered (only when recording the melody). For information on velocity settings, see below.
- K, L, M:** Determines the length of the note (as a percentage) from the position at which it is to be entered. (This is available only when recording the melody.) For information on gate time settings, see below.
- DEL:** Deletes the event at the cursor.



To close the STEP RECORD display, press the [EXIT] button. Make sure to store the recorded data by pressing the [I] (SAVE) button (page 45).

### ■ Measure/Beat/Clock

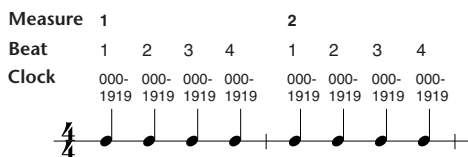

### ■ Velocity

The table below shows the available settings and the corresponding velocity values.

Kbd. Vel	fff	ff	f	mf	mp	p	pp	ppp
Actual playing strength	127	111	95	79	63	47	31	15

### ■ Gate Time

The following settings are available:

- Normal ..... 80%
- Tenuto ..... 99%
- Staccato ..... 40%
- Staccatissimo ..... 20%

**Manual** ..... The gate time (note length) can be specified as a percentage by using the [DATA ENTRY] dial.

## Recording Melodies — Step Record (Note)

In this section, we'll show you how to use Step Recording by guiding you through this actual music example, shown at right.

The operations here apply to step 6 on page 99.



**1**

1-1 Select this note.

1-2 While holding down this note...

**NOTE**

The notation display on the instrument may not be accurate, especially for tied notes or longer notes. To have the notation displayed accurately, set the gate time to tenuto by using the [H] button, and input the notes as desired.

↓

**2**

2-1 Select this note.

2-2

2-3

2-4

↓

**3**

3-2 Select this note.

3-1 Press this button to display the dotted notes.

3-3

↓

**4**

4-2 Select this note.

4-1 Call up the normal notes by pressing this button.

4-3

↓

**NOTE**

To input rests, simply move the measure/beat/clock location for the desired rest time, then input the next note.

**■ Play back the newly created melody**

Use the [C] (▲) button to move the cursor to the beginning of the song, and press the SONG [START/STOP] button to hear the newly entered notes. To actually enter the recorded data, press the [EXIT] button. The entered data can be edited from the SONG CREATOR (1 - 16) display (page 107).

## Recording Chord Changes for the Auto Accompaniment — Step Record (Chord)

The Chord Step recording feature makes it possible to record auto accompaniment chord changes one at a time with precise timing. Since the changes don't have to be played in real time, you can easily create complex, tight chord changes — over which you can record the melody in normal fashion. The operations here apply to step 6 on page 99.

### Entering Chords and Sections (Chord Step)

For example, you can input the following chord progression by the procedure described below.

**NOTE**  
Enter the chords by using the currently selected chord fingering method in the Auto Accompaniment section of the keyboard.

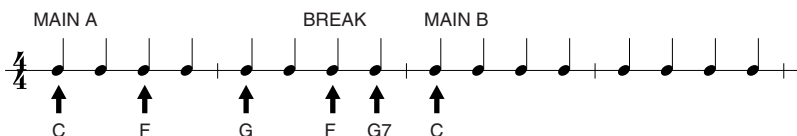

**1** Press the MAIN [A] button to specify the section, and enter the chords as shown at right.

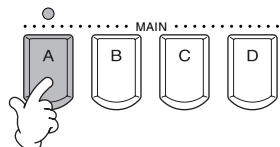

Select this note value and play the chords indicated at right.

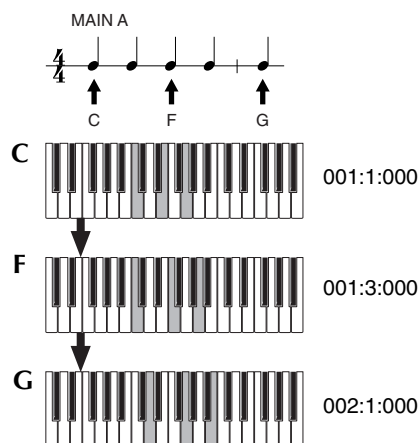

**2** Press the [BREAK] button to specify the Break section, and enter the chords as shown at right.

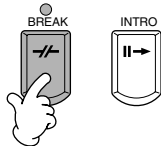

Select this note value and play the chords indicated at right.

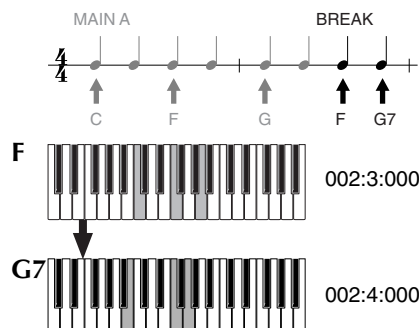

### 3 Press the MAIN [B] button to specify the section and enter the chord indicated at right.

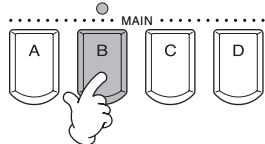

SONG CREATOR : NewSong				
STEP RECORD				
4/4	2PPQ	Style	Cool8Beat	
▲	001 : 1 : 0000	Sect	M	A Main A : 2
▼	001 : 1 : 0000	Chord	C	Maj
▲	001 : 1 : 0000	Tempo	100	
	001 : 3 : 0000	Chord	F	Maj
	002 : 1 : 0000	Chord	G	Maj
	002 : 3 : 0000	Sect	F	Br Break : 1
	002 : 4 : 0000	Chord	G	7
	003 : 1 : 0000	Chord	C	Maj
	003 : 1 : 0000	Sect	F	B Fill In B : 1
	005 : 1 : 0000	End		

Select this note value and play the chords indicated at right.

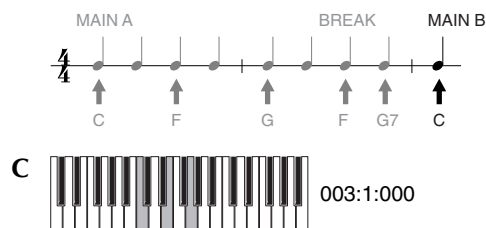

#### ■ Play back the newly created chord progression

Use the [C] (▲) button to move the cursor to the beginning of the song, and press the SONG [START/STOP] button to hear the newly entered notes. To actually enter the recorded data, press the [EXIT] button. The entered data can be edited from the SONG CREATOR (CHD) display (page 108). Finally, press the [F] (EXPAND) button from the SONG CREATOR (CHD) display in order to convert the input data into song data.

#### NOTE

To enter a fill-in, press the [AUTO FILL IN] button and press one of the MAIN [A]–[D] buttons.

#### NOTE

##### END Mark

An “END” mark is shown in the display, indicating the end of the song data. The actual position of the End mark differs depending on the section that is input at the end of the song. When an Ending section is input, the End mark automatically follows the Ending data. When a section other than Ending is input, the End mark is set two measures after the final section. The End mark can be freely set to any position desired.

# Select the Recording Options: Starting, Stopping, Punching In/Out — Rec Mode

From this display you can set up how recording is started and stopped for either Quick Recording or Multi Recording. To call up these settings, select the REC MODE display by using the [BACK][NEXT] button, after performing operation steps 1–3 on page 98.

These settings determine how recording will start.

### Normal

Pressing the SONG [START/STOP] button enables Synchro standby and overwrite recording starts as soon as you start playing the keyboard.

### First Key On

Overwrite recording starts as soon as you start playing the keyboard. This setting also preserves the previous lead-in data, letting you record over the original lead-in without erasing it.

### Punch In At

The song plays back normally up to the indicated Punch In measure (set by the [3▲▼] buttons), then starts overwrite recording at that Punch In measure.

Determines the measure at which Punch In overwrite recording starts (when "PUNCH IN AT" is selected).

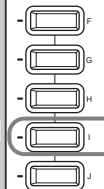
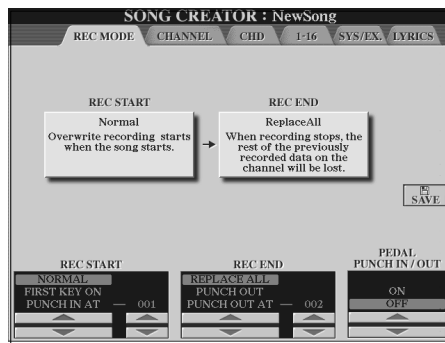

Calls up the SONG display, from which you can save the edited data.

When this is set to ON, you can use the sostenuto (center) pedal to control the punch-in and punch-out points. Press and hold down the sostenuto pedal to record. Recording stops when you release the pedal.

Determines the Punch Out measure — the measure at which Punch In overwrite recording stops (when "PUNCH OUT AT" is selected).

### Replace All

This deletes all data following the point at which recording is stopped.

### Punch Out

This maintains all data following the point at which recording is stopped.

### Punch Out At

Overwrite recording continues until the indicated Punch Out measure (set by the [6▲▼] buttons), then stops at that Punch Out measure, after which song playback continues normally.

### NOTE

When the Pedal Punch In/Out function is set to ON, the current function assignment of the sostenuto pedal is cancelled.

## About Punch In/Out

This feature is useful primarily for re-recording or replacing a specific section of an already recorded channel. The illustrations below indicate a variety of situations in which selected measures in an eight-measure phrase are re-recorded.

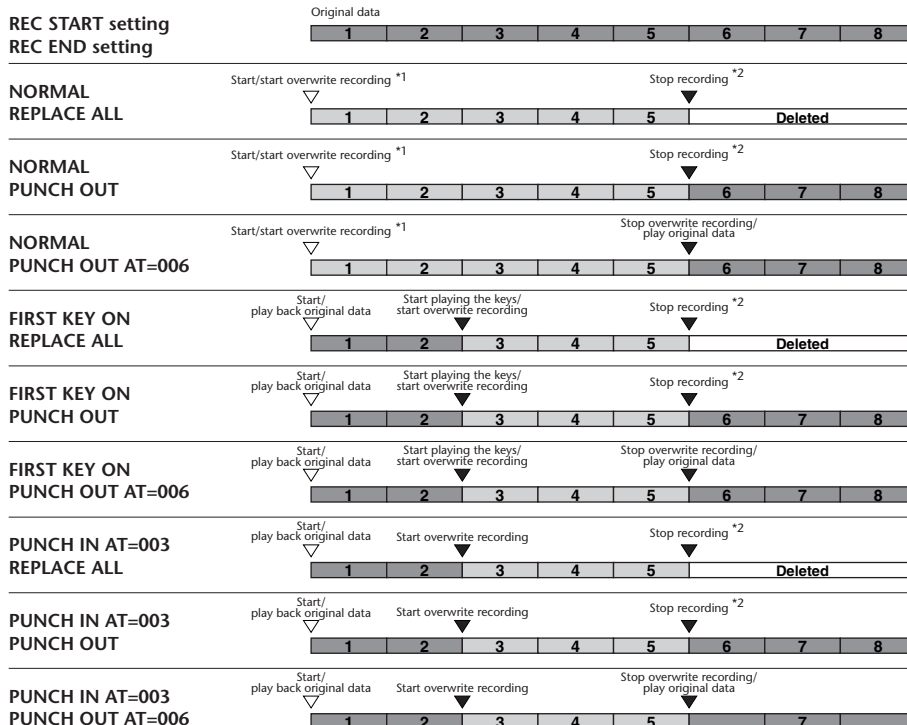

\*1 When measures 1 - 2 are not overwritten, recording starts from measure 3.

\*2 You'll have to press the [REC] button at the end of 5 measures.

Legend:  
 [Dark Grey Box] Previously recorded data  
 [Light Grey Box] Newly recorded data  
 [White Box] Deleted data

## Editing a Recorded Song

Whether you've recorded a song using Quick Recording, Multi Recording, or Step Recording, you can use the editing features to change the song data.

### Editing Channel-related Parameters — Channel

Calling up the operations here apply to step 4 on page 98. To call up the display shown below, use the [BACK]/[NEXT] buttons.

#### Quantize

Quantize lets you “clean up” or tighten the timing of a previously recorded channel. For example, the following musical passage has been written with exact quarter-note and eighth-note values.



Even though you think you may have recorded the passage accurately, your actual performance may be slightly ahead of or behind the beat. Quantize allows you to align all the notes in a channel so that the timing is absolutely accurate to the specified note value (see below).

Use this to select the desired edit operation.

Executes the Quantize operation. After the operation is completed, this button changes to [UNDO], letting you restore the original data if you're not satisfied with the Quantize results. The Undo function only has one level; only the previous operation can be undone.

Calls up the **SONG** display, from which you can save the edited data.

Determines how strongly the notes will be quantized. If a value less than 100% is selected, notes will be moved toward the specified quantization beats only by the specified amount. Applying less than 100% quantization lets you preserve some of the “human” feel in the recording.

Selects the desired channel to be quantized.

Selects the quantize size (resolution). See the below for the details.

#### ■ About Quantize Size

Set the Quantize size to correspond to the smallest notes in the channel you are working with. For example, if the data was recorded with both quarter notes and eighth notes, use 1/8 note for the Quantize size. If you apply a 1/4 note Quantize size, the eighth notes would be moved on top of the quarter notes.

#### One measure of eighth notes before quantization



#### After 1/8 note quantization



#### Quantize Size

1/4 note	1/8 note	1/16 note	1/32 note	1/16 note + 1/8 note triplet *
1/4 note triplet	1/8 note triplet	1/16 note triplet	1/8 note + 1/8 note triplet *	1/16 note + 1/16 note triplet *

The three Quantize settings marked with asterisks (\*) are exceptionally convenient, since they allow you to quantize two different note values at the same time, without compromising the quantization of either one. For example, if you have both straight 1/8 notes and 1/8 note triplets recorded to the same channel, and you quantize to straight 1/8 notes — completely eliminating any triplet feel in the rhythm. However, if you use the 1/8 note + 1/8 note triplet setting, both the straight and triplet notes will be quantized correctly.



## Delete

This lets you delete recorded data in the specified channel.

Use these to select the desired edit operation.

Deletes all data in the selected channel. After the operation is completed, this button changes to **[UNDO]**, letting you restore the original data. The Undo function only has one level; only the previous operation can be undone.

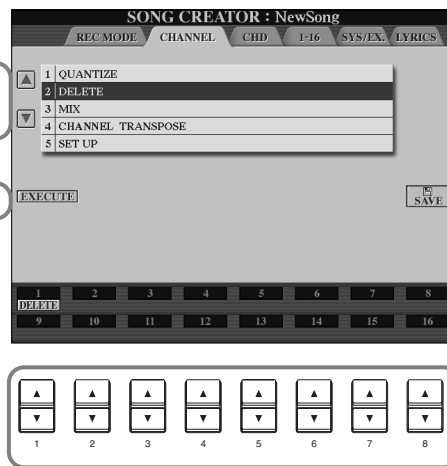

Calls up the **SONG** display, from which you can save the edited data.

These select the channel to be deleted.

## Mix

This function lets you mix the data of two channels and place the results in a different channel. It also lets you copy the data from one channel to another.

Use these to select the desired edit operation.

Executes the Mix operation. After the operation is completed, this button changes to **[UNDO]**, letting you restore the original data if you're not satisfied with the Mix results. The Undo function only has one level; only the previous operation can be undone.

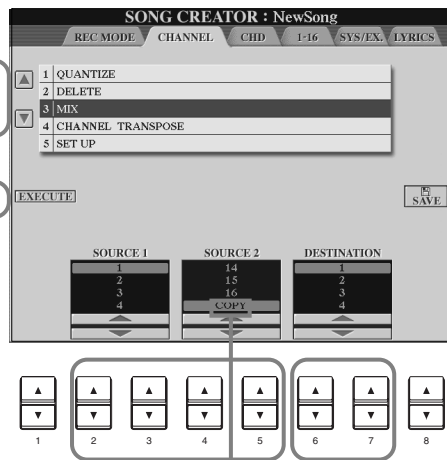

**NOTE**  
All data other than the mixed note data is derived from the Source 1 channel.

Calls up the **SONG** display, from which you can save the edited data.

These let you specify the two source channels to be mixed.

Determines the channel into which the mix or copy results will be placed.

If "COPY" is selected here, the data from Source 1 is copied to the Destination channel.

## Channel Transpose

This allows you to transpose the recorded data of individual channels up or down by a maximum of two octaves in semitone increments.

Use these to select the desired edit operation.

Executes the Channel Transpose operation. After the operation is completed, this button changes to [UNDO], letting you restore the original data if you're not satisfied with the Channel Transpose results. The Undo function only has one level; only the previous operation can be undone.

Toggles between the two channel displays: Channels 1 - 8, and Channels 9 - 16.

To simultaneously set all channels to the same value, adjust the Channel Transpose for one of the channels while holding down this button.

Calls up the **SONG** display, from which you can save the edited data.

Determines the amount of transpose for each channel.

## Set Up

You can change the initial settings of the song — such as voice, level, and tempo — to the current settings of the mixing console or panel controls.

Use these to select the desired edit operation.

Executes the SET UP operation. Once SET UP has been executed, the operation cannot be cancelled or undone.

Calls up the **SONG** display, from which you can save the edited data.

Use this to checkmark the selected item. Checkmarked items are stored with the song.

Determines which playback features and functions will be automatically called up along with the selected song. All events, with the exception of "KEYBOARD VOICE," can be recorded only at the beginning of the song. Before you select or checkmark any of these items (other than Keyboard Voice), make sure to return the song to the beginning by using the [TOP] button, and stop playback.

- Song**.....Stores the tempo setting and all settings made from the Mixing Console.
- Keyboard Voice** .....This lets you automatically set the voice of the keyboard-played parts (Main/Layer/Left) when playing back the song. Stores the keyboard-played voice and the part ON/OFF settings. To record a voice change for the keyboard-played part in the middle of a song, stop the song at the desired point, make the voice change, and press the [D] (EXECUTE) button.
- Lyrics Bkgd/Lng**.....Stores the settings of the Lyrics display.
- Score Setting** .....Stores the settings of the Score display.
- Mic. Setting**.....Stores the microphone settings in the mixing console.
- Guide Setting** .....Stores the settings of the practice functions. When the settings are stored, selecting a song automatically turns on the Guide functions.

## Editing Note Events — 1 - 16

From this display, you can edit individual note events (see below). Calling up operations here apply to step 4 on page 98. Use the [BACK]/[NEXT] buttons to call up the display below.

Use these to move the cursor up/down and select the desired event.

Returns to the beginning position of the current song (the first note of the first measure).

Use these to move the cursor left/right and select the desired parameter of the highlighted event. Keep in mind that moving the cursor away from the just-edited value automatically enters that value.

Determines the current position of the event being edited.

For coarse adjustment of the event value.

For fine adjustment of the event value.

Cuts (deletes) all selected events. The cut events are copied and can be pasted to another location.

Adds a new event to the Event List.



Determines the channel to be edited.

Calls up the **Step Recording** display (page 99).

Calls up the **Filter** display (page 109), letting you select only the events you wish to shown in the Event List.

Calls up the **SONG** display, from which you can save the edited data.

Holding this button down while using the [A] and [B] buttons lets you select multiple events.

Pastes all cut or copied events to the selected location.

If the value at the cursor has been changed, pressing this restores the original value.

Copies all selected events. The copied events can be pasted to another location.

Deletes the event at the cursor position.

**NOTE**

To actually enter an edited value, move the cursor away from the value or press the SONG [START/STOP] button.

### Note Events

Parameter	Description
Note	Determines the pitch, velocity (volume) and length of the note.
Ctrl (Control change)	Determines the control change number and value. For details on control change messages, refer to the separate Data List booklet (MIDI Data Format).
Prog (Program change)	Determines the voice (program) number. For details on program change messages and how to set them, refer to the separate Data List booklet (Voice List).
P.Bnd (Pitch bend)	Determines the pitch bend value.
A.T. (After touch)	Determines the after touch value.

**NOTE**

The sound of the voices recorded with Step recording may sound slightly different from the original.

## Editing Chord Events — CHD

From this display, you can edit the chord events you've recorded to the song. Calling up operations here apply to step 4 on page 98. Use the [BACK]/[NEXT] buttons to call up the display below. With the exception of the [F] (EXPAND) button, the operations here are the same as those in Editing Note Events (page 107).

Press this to convert the recorded chord and section entries into song data.

**NOTE**  
To actually enter an edited value, move the cursor away from the value or press the SONG [START/STOP] button.

### Chord Events

Parameter	Description
Style (Accompaniment style)	Displays the accompaniment style name. To enter an accompaniment style, call up the <b>STYLE</b> display and select the desired style.
Tempo	Determines the tempo value.
Chord	Specifies the chord — its root note, chord type, and on-bass note.
Sect (Section)	Specifies the section — its name and variation.
OnOff (Channel on/off)	Determines whether specific channels (rhythm, bass, etc.) are turned on/off.
CH.Vol (Channel volume)	Determines the level of specific channels (rhythm, bass, etc.).
S.Vol (Style volume)	Determines the level of the entire accompaniment style.

## Editing System Events — SYS/EX. (System Exclusive)

From this display, you can edit recorded System events. Calling up operations here apply to step 4 on page 98. Use the [BACK]/[NEXT] buttons to call up the display below. The operations here are the same as those in Editing Note Events (page 107).

### System Events

Parameter	Description
ScBar (Score initial measure)	This determines the number of the top measure. The measure number is indicated in the MAIN display or in the music notation. Only one value can be specified at the beginning of the song data.
Tempo	Determines the tempo value.
Time (Time signature)	Determines the time signature.
Key	Determines the key, as well as the major/minor setting.
XG Prm (XG parameters)	Allows you to make various detailed changes to the data. For more information on XG parameters, refer to the separate Data List booklet (MIDI Data Format).
SYS/EX. (System Exclusive)	Displays the System Exclusive data in the song. This does not let you change the actual contents of the data; however, it lets you delete, cut, copy, and paste the data.
Meta (Meta event)	Displays the SMF meta events in the song. This does not let you change the actual contents of the data; however, it lets you delete, cut, copy, and paste the data.

## Inputting and Editing Lyrics

This convenient function lets you enter the song name and the lyrics for the song. It also lets you change or correct already existing lyrics. For more information on lyric events, see the chart below. Calling up operations here apply to step 4 on page 98. Use the [BACK]/[NEXT] buttons to call up the display below. The operations here are the same as those in Editing Note Events (page 107).

In the following example, we'll rewrite a portion of the lyrics to one of the songs, "Twinkle Twinkle Little Star."

Select the internal song "Twinkle Twinkle Little Star." The method for selection is the same as described on page 75.

**1** Move the cursor to the event containing the lyric "star."

**2** Move the cursor to the word "star."

**3** Use these buttons to call up the Lyric display, from which you can input lyrics. From the Lyric display (page 46), enter the new word, "(your name)."

**4** Press this button to save the newly changed lyric data.

**NOTE**  
The song "Twinkle Twinkle Little Star" is in the folder "For Children" in the Song Book (page 75).

**NOTE**  
To actually enter an edited value, move the cursor away from the value or press the SONG [START/STOP] button.

### Lyrics Events

Parameter	Description
Name (Song name)	Determines the song name. This calls up the NAME display, from which you can enter the name.
Lyrics	Allows you to enter lyrics.
Code (Other controls)	CR : Enters a line break in the lyrics text. LF : Deletes the currently displayed lyrics and displays the next set of lyrics.

## Customizing the Event List — Filter

This function lets you determine which event types will be shown in the event editing displays. To select an event for display, checkmark the box corresponding to the event name. To filter out an event so that it is not shown on the list, remove the checkmark so that the box is empty.

To call up the display below, press the [H] (FILTER) button from any of the following displays: CHD, 1 - 16, SysEX, or LYRICS (page 107 - page 109).

Calls up the Main Filter display. For more information on each event type, refer to the separate Data List booklet (MIDI Data Format).

Calls up the Control Change Filter display. For more information on each event type, refer to the separate Data List booklet (MIDI Data Format).

Calls up the Accompaniment Filter display. For more information on each event type, refer to the separate Data List booklet (MIDI Data Format).

Enters checkmarks for all items.

Selects only note data; checkmarks for all other boxes are removed.

Reverses the checkmark settings for all boxes. In other words, this enters checkmarks to all boxes that were previously unchecked and vice versa.

Enters/removes the checkmark for the selected item.

Selects the item, scrolling up/down one item at a time.

When "MAIN FILTER" or "ACCOMPANIMENT FILTER" is selected, these select the item, scrolling up/down to the top or the bottom. When "CONTROL CHANGE FILTER" is selected, these select the item, scrolling up/down eight items at a time.

**END** Execute the settings by pressing the [EXIT] button.

# Creating Accompaniment Styles — Style Creator

This powerful feature lets you create your own original styles, which can then be used for auto accompaniment — just as with the preset styles.

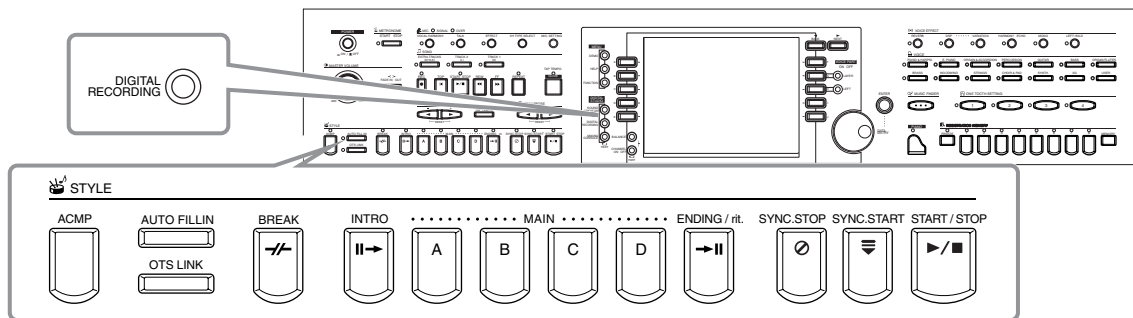

## About Creating Accompaniment Styles

The chart at right shows the basic parts (or “channels”) that make up each section of an accompaniment style. To create an accompaniment style, record patterns to the various channels one by one, for each of the sections you want to create.

### ■ Realtime Recording (page 112)

You can record accompaniment styles by simply playing the parts from the keyboard in real time. However, you don't have to record every part yourself — you can choose an existing preset accompaniment style that is close to the style you want, then add or replace parts in that style as needed to create your own custom style.

Section	Channel
INTRO A - D	RHYTHM 1, RHYTHM 2, BASS, CHORD 1, CHORD 2, PAD, PHRASE 1, PHRASE 2
MAIN A - D	
FILL IN A - D	
BREAK	
ENDING A - D	

#### NOTE

For information on the part structure of accompaniment styles, see page 96.

### Realtime Recording Characteristics

#### • Loop recording

Since auto accompaniment playback repeats the accompaniment patterns of several measures in a “loop,” you can also record patterns in a loop. For example, if you start recording with a two-measure Main section, the two measures are repeatedly recorded. Notes that you record will play back from the next loop (repetition), letting you record new material while hearing the parts you previously recorded.

#### • Overdub recording

This feature lets you record new material to a track already containing recorded data, without deleting the original data. In style recording, the recorded data remains intact, unless you specifically delete it yourself. For example, if you start recording with a two-measure Main section, the two measures are repeated. As you record notes to each pass of the loop (repetition), those notes play back from the next loop, letting you overdub new material while hearing the previous parts.

### ■ Step Recording (page 113)

This method is like writing music notation on paper, since it allows you to enter each note or individually, and specify its length. This is ideal for making precise recordings, or for recording parts that are difficult to play.

### ■ Assembling an Accompaniment Style (page 114)

This convenient feature lets you create composite styles by combining various patterns from the internal preset accompaniment styles. For example, if you want to create your own original 8-beat style, you could take rhythm patterns from the “8 Beat 1” style, use the bass pattern from “8 Beat 2,” and import the chord patterns from the “60's 8 Beat” style — combining the various elements to create one accompaniment style.

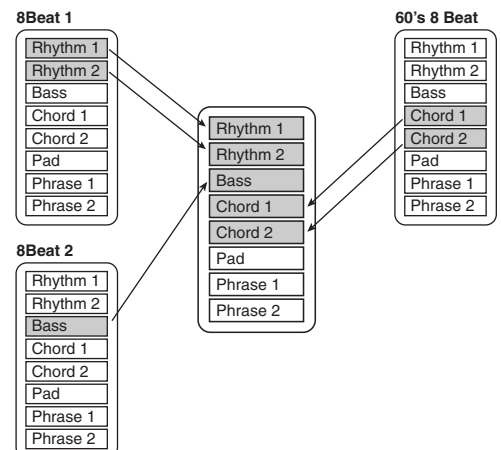

### ■ Editing the created Accompaniment Style (page 115)

With the editing features, you can custom edit the styles you've created by real time recording, step recording, and assembling from other styles.

## Style File Format

The Style File Format (SFF) combines all of Yamaha's auto accompaniment know-how into a single unified format. By using the edit functions, you can take full advantage of the SFF format and freely create your own styles. The chart at right indicates the process by which the accompaniment is played back. (This does not apply to the rhythm tracks.) The basic or "source" pattern in the chart is the original style data. This source pattern is recorded using accompaniment style recording (see below). As shown in the chart at right, the actual output of the accompaniment is determined by various parameter settings and chord changes (played in Auto Accompaniment section of the keyboard) entered to this source pattern.

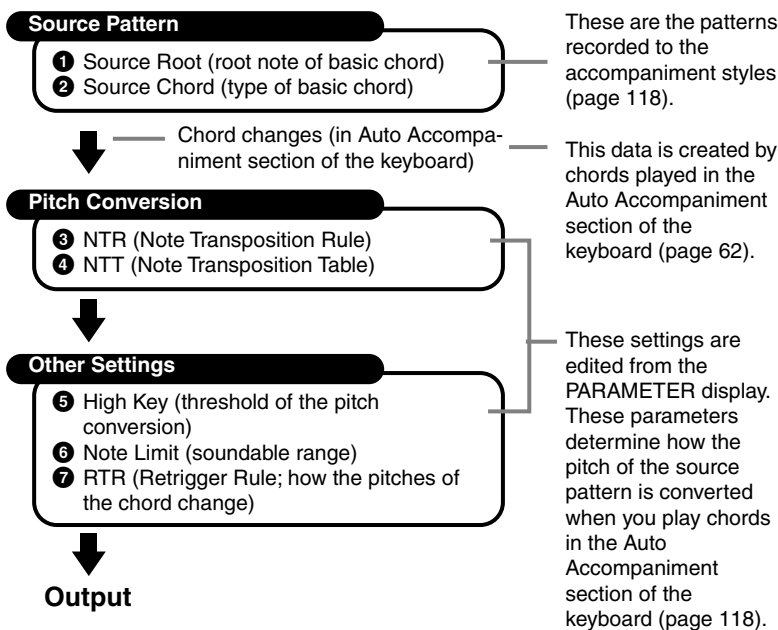

## Operation

**1 Select the desired accompaniment style for editing.** To record a new accompaniment style from scratch, call up the **BASIC** page in the **Style Creator** display and select "New Style" by pressing the [C] button.

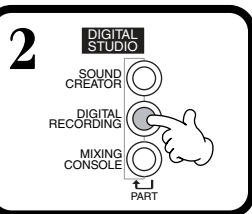

**3**

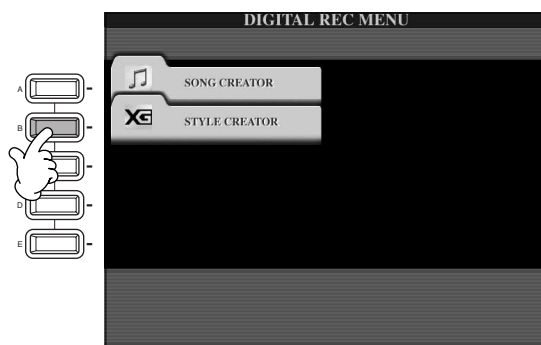

**4 Record and edit the accompaniment style.** For details on the operations for each display, refer to the explanations starting on the next page.

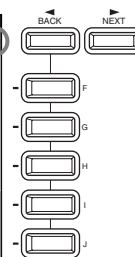

Use the [BACK]/[NEXT] buttons to select the various pages.

**5 Call up the Style display by pressing the [I] (SAVE) button (in Assembly page: [J] button), then save the recorded / edited data to the USER or FLOPPY DISK page.**



Press the [EXIT] button to close the **STYLE CREATOR** display.

# Realtime Recording — Basic

You can use the Realtime Recording features to create your own accompaniment style — either from scratch or based on the preset accompaniment data. The operations here apply to step 4 on page 111.

- 1 Select the desired channel for recording by simultaneously holding down the [F] (REC CH) button and pressing the appropriate [1▲▼] - [8▲▼] button.**

Before recording to one of the non-rhythm channels (**BASS - PHR 2**), make sure to delete the existing data of the appropriate channel. You can make other settings (see the box “Other Parameters in the **BASIC Display**” on page 113) after closing the **REC CHANNEL** display by pressing the [EXIT] button. To call up the **REC CHANNEL** display again, press the [F] (**REC CH**) button.

Calls up the display for changing the tempo or beat (time signature).

Selects an empty style, allowing you to create a new style from scratch.

Available only when the channel is set to [RHY1] or [RHY2], this lets you delete specific percussion sounds during recording. Simultaneously hold down this button and press the key corresponding to the instrument you want to delete.



When this button is pressed, “DELETE” will appear over channels containing data. To delete data from a specific channel, simultaneously hold down this button and press the appropriate [1▲] - [8▲] button. To release or cancel the selection, press the [1▼] - [8▼] button corresponding to the channel you wish to cancel. As long as you continue to hold down the [J] button, you can toggle between deleting and restoring the selected data. **Releasing the [J] button permanently deletes the data.** Before recording to one of the non-rhythm channels (**BASS - PHR 2**), make sure to delete the existing data of the appropriate channel.

**REC** .... Channel is enabled for recording.  
**ON**..... Channel is enabled for playback.  
**OFF**..... Channel is muted.

- 2 First, select the desired voice. Start recording by pressing the STYLE [START/STOP] button.**

The selected section of the style starts playing back. Since the rhythm pattern loops repeatedly, you can record new sounds and notes on each pass while listening to the pattern. Icons above the keys conveniently indicate the percussion instruments assigned to the keys.

**NOTE**  
 If you've enabled Sync Start (by pressing the **SYNC START** button), you can start recording by simply pressing a key on the keyboard.

- 3 Stop recording by pressing the STYLE [START/STOP] button again.**

**NOTE**

- Any voice can be selected for the RHY1 channel, with the exception of Organ Flutes.
- Only Drum Kit/SFX Kit can be selected for the RHY 2 channel.
- For the non-rhythm channels (BASS - PHR 2), all voices with the exception of the Organ Flutes voice/ Drum Kit/SFX Kit can be selected.

- 4 With the REC CHANNEL display shown, close the display by pressing the [EXIT] button.**



**Other Parameters in the BASIC Display**

**[I] (SAVE) button**

Calls up the Style display for saving the accompaniment style data.

**[3▲▼][4▲▼] (Section) buttons**

Determines the section to be recorded.

**[5▲▼][6▲▼] (Pattern Length) buttons**

Determines the length of the selected section's pattern in measures (1 - 32). The Fill In/Break section is fixed at a length of one measure.

**[D] (Execute) button**

Executes the Pattern Length change.

**NOTE**

You can also select the desired section for recording by pressing the appropriate panel button. Pressing one of the Section buttons calls up the SECTION display, from which you can change sections by using the [6▲▼]/[7▲▼] buttons. To actually enter the change, press the [8▲] button. To select the **Fill In** section, press the **[AUTO FILL IN]** button.

**Recording — Precautions**

- The basic chord used for the accompaniment style is called the source chord. All chords that play and the pitches that sound are derived from the source chord. When recording the Main and Fill In sections (for a source chord of CM7), keep the following points in mind:
  - When recording to the Bass or Phrase channels, try to use only the recommended notes; this will ensure that you can play various chords with the accompaniment style and get optimum results. (Other notes may work, providing you use them as short passing tones.)
  - When recording to the Chord or Pad channels, use only the notes of the CM7 chord; this will ensure that you can play various chords with the accompaniment style and get optimum results. (Other notes may work, providing you use them as short passing tones.)

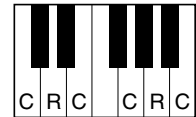

C = chord note  
C, R = recommended note

The source chord is set by default to CM7; however, you can change this to any chord you prefer. Refer to the section "Making Style File Format Settings – Parameter" on page 118.

- When recording Intro and Ending sections, you can ignore the source chord and use any notes or chord progressions you like. In this case, if you set the NTR parameter to "ROOT TRANSPOSE" and NTT to "HARMONIC MINOR" or "MELODIC MINOR" (in the PARAMETER page), the normal pitch conversions that would result from playing different chords are cancelled (for playback) — meaning that the accompaniment pitch conversion will only occur for changes in the root note or major/minor shifts.

**Step Recording**

With this method, you can create a style pattern by entering notes and other data individually, without having to perform them in real time. The operations here apply to step 4 on page 111.

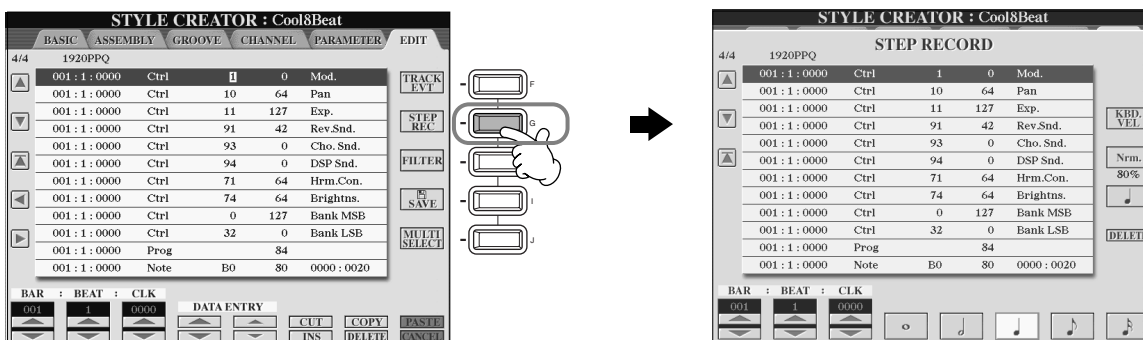

The actual recording process is the same as in Step Recording of songs (page 98), with the exception of the points described below. You can also edit each event from the Edit page, and the editing process the same as in editing songs (page 107).

- In song recording, the end mark position can be changed freely. However, it cannot be changed when creating accompaniment styles. This is because the length of the accompaniment style is automatically fixed according to the selected section. For example, when creating an accompaniment style based on a four-measure section, the end mark position is automatically set to the end of the fourth measure, and cannot be changed from the Step Record screen.
  - When editing the data recorded on the Edit page, you can switch between the type of data you want to edit (event data or control data). Press the [F] (TRACK EVT) button to switch between the Event display (Note, Control Change, etc.) and the Control display (System Exclusive, etc.).
- Make sure to set the record channel from another display (e.g., BASIC display; page 112) beforehand.

# Assembling an Accompaniment Style — Assembly

This convenient function lets you combine accompaniment elements — such as rhythm, bass, and chord patterns — from existing styles, and use them to create your own original accompaniment styles. The operations here apply to step 4 on page 111.

**1** These let you select the accompaniment style that will be used for each channel of your original style. Select the desired channel by pressing the [A] – [D], [F] – [I] buttons and press the same button to call up the **Style** screen, from which you can select the accompaniment style.

**3** After repeating steps 1 and 2 as desired, press the [J] (**SAVE**) button to save the assembled style data. From here, you can store the settings of all channels (RHYTHM1, RHYTHM2, BASS, etc.) to a single accompaniment style.



**2** Selects the style section and channel that will be copied to the corresponding channels, selected with the [A]–[D] and [F]–[I] buttons above.

Determines the playback setting for each channel. You can assemble the accompaniment style while the style section and channel that will be copied are playing.

**SOLO** ..... Mutes all but the selected channel. RHYTHM channels set to REC in the REC CHANNEL display (page 112) are played back simultaneously.

**ON** ..... Plays back the selected channels. Any channels set to ON in the REC CHANNEL display (page 112) are played back simultaneously.

**OFF** ..... Mutes the selected channel. If the selected channel is set to ON in the REC CHANNEL display (page 112), OFF does not appear and is not available.

**NOTE**  
If you change the section and channel in steps #1 and #2, the currently specified section and channel are also changed. The channels being recorded are also changed and recording is stopped automatically.

**NOTE**  
The PLAY TYPE parameter affects only the playback, and does not change the actual accompaniment style data.

# Edit the Created Accompaniment Style

## Change the Rhythmic Feel — Groove and Dynamics

These versatile features give you a wide variety of tools for changing the rhythmic feel of your created accompaniment style. The operations here apply to step 4 on page 111.

### ■ Groove

Use these to select the desired edit operation.

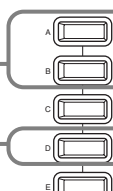

Executes the Groove operation. After the operation is completed, this button changes to [UNDO], letting you restore the original data if you're not satisfied with the Groove results. The Undo function only has one level; only the previous operation can be undone.

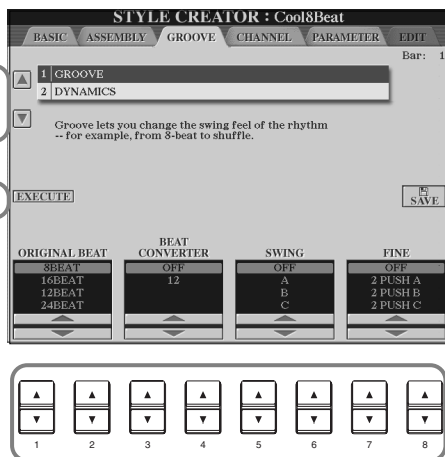

Calls up the **Style** display and lets you store the edited accompaniment style data.

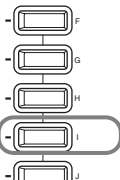

Determines the settings for each of the Groove parameters (see the list below).

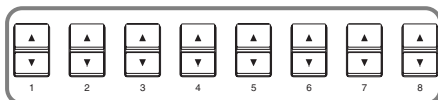

### Groove parameters

<b>Original Beat</b>	Specifies the beats to which Groove timing is to be applied. In other words, if “8 Beat” is selected, Groove timing is applied to the 8th notes; if “12 Beat” is selected, Groove timing is applied to 8th-note triplets.
<b>Beat Converter</b>	Actually changes the timing of the beats (specified in the ORIGINAL BEAT parameter above) to the selected value. For example, when ORIGINAL BEAT is set to “8 Beat” and BEAT CONVERTER is set to “12,” all 8th notes in the section are shifted to 8th-note triplet timing. The “16A” and “16B” Beat Converter which appear when ORIGINAL BEAT is set to “12 Beat” are variations on a basic 16th-note setting.
<b>Swing</b>	Produces a “swing” feel by shifting the timing of the back beats, depending on the ORIGINAL BEAT parameter above. For example, if the specified ORIGINAL BEAT value is “8 Beat”, the Swing parameter will selectively delay the 2nd, 4th, 6th, and 8th beats of each measure to create a swing feel. The settings “A” through “E” produce different degrees of swing, with “A” being the most subtle and “E” being the most pronounced.
<b>Fine</b>	Selects a variety of Groove “templates” to be applied to the selected section. The “PUSH” settings cause certain beats to be played early, while “HEAVY” settings delay the timing of certain beats. The numbered settings (2, 3, 4, 5) determine which beats are to be affected. All beats up to the specified beat—but not including the first beat—will be played early or delayed (for example, the 2nd and 3rd beats, if “3” is selected). In all cases, “A” types produce minimum effect, “B” types produce medium effect, and “C” types produce maximum effect.

■ Dynamics

Use these to select the desired edit operation.

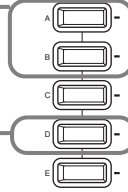

Executes the Dynamics operation. After the operation is completed, this button changes to [UNDO], letting you restore the original data if you're not satisfied with the Dynamics results. The Undo function only has one level; only the previous operation can be undone.

Select the desired channel to which Dynamics is to be applied.

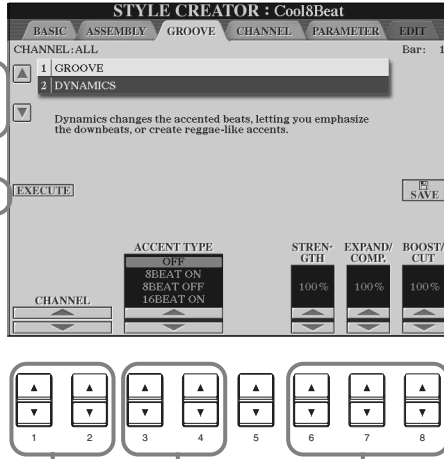

Calls up the **Style** display and lets you store the edited accompaniment style data.

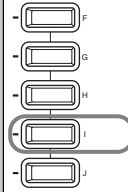

Determines the settings for each of the Dynamics parameters (see the list below).

Dynamics parameters

<b>Accent Type</b>	Selects the type of accent.
<b>Strength</b>	Determines how strongly the selected Accent Type (above) will be applied. The higher the value, the stronger the effect.
<b>Expand/Compress</b>	Expands or compresses the range of velocity values, around a central velocity value "64." Values higher than 100% expand the dynamic range, while values lower than 100% compress it.
<b>Boost/Cut</b>	Boosts or cuts all velocity values in the selected section/channel. Values above 100% boost the overall velocity, while values below 100% reduce it.

**NOTE**  
**Velocity** is determined by how strongly you play the keyboard. The more strongly you play the keyboard, the higher the velocity value and, hence, the louder the sound.

## Editing the Channel Data

In this display, there are five different channel-related edit functions, including Quantize, for editing the recorded accompaniment style data. The operations here apply to step 4 on page 111.

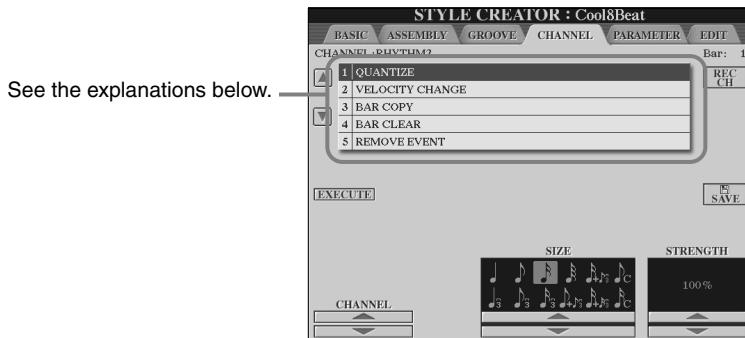

**NOTE**  
Preset channel BASS - PHRASE2 can not be edited.

### ■ Quantize

Refer to page 104.

### ■ Velocity Change

Boosts or cuts the velocity of all notes in the specified channel (selected with the [1▲▼]/[2▲▼] (CHANNEL) buttons), according to the specified percentage (selected with the [4▲▼]/[5▲▼] (BOOST/CUT) buttons).

### ■ Bar Copy

This function allows data to be copied from one measure or group of measures to another location within the specified channel. Use the [4▲▼] (TOP) and [5▲▼] (LAST) buttons to specify the first and last measures in the region to be copied. Use the [6▲▼] (DEST) button to specify the first measure of the destination location, to which the data is to be copied.

### ■ Bar Clear

This function clears all data from the specified range of measures within the selected channel. Use the [4▲▼] (TOP) and [5▲▼] (LAST) buttons to specify the first and last measures in the region to be cleared.

### ■ Remove Event

This function lets you remove specific events from the selected channel. Use the [4▲▼] - [6▲▼] (EVENT) buttons to select the desired event type to be removed.

## Making Style File Format Settings —Parameter

This display provides a variety of style controls— such as determining how the pitch and sound of the recorded style change when playing the chords in the left-hand range of the keyboard. For details about the relationship between the parameters, refer to “Style File Format” on page 111. The operations here are the same as described in step 4 on page 111.

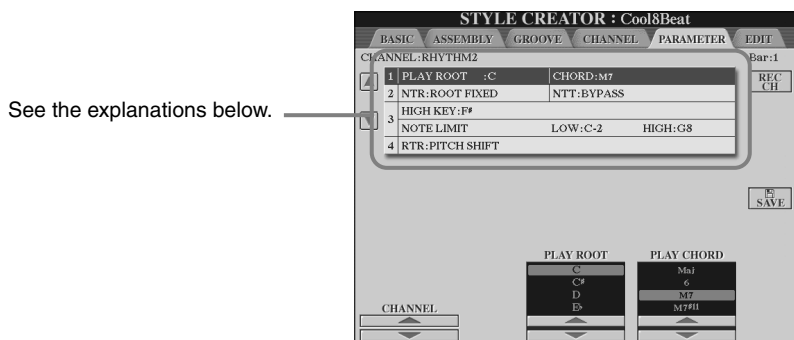

**NOTE**  
When NTR is set to “Root Fixed” and NTT is set to “Bypass,” the “Source Root” and “Source Chord” parameters are changed to “Play Root” and “Play Chord,” respectively. In this case, you can change chords and hear the resulting sound for all channels.

### ■ Source Root/Chord

These settings determine the original key of the source pattern (i.e., the key used when recording the pattern). The default setting of CM7 (with a Source Root of “C” and a Source Type of “M7”), is automatically selected whenever the preset data is deleted prior to recording a new style, regardless of the Source Root and Chord included in the preset data. When you change Source Root / Chord from the default CM7 to another chord, the chord notes and recommended notes will also change, depending on the newly selected chord type. For details on chord notes and recommended notes, see page 113.

#### When the Source Root is C:

<b>CMaj</b> 	<b>C6</b> 	<b>CM7</b> 	<b>CM7#11</b> 	<b>C9</b> 	<b>CM7#9</b> 	<b>C6#9</b> 
<b>Caug</b> 	<b>Cm</b> 	<b>Cm6</b> 	<b>Cm7</b> 	<b>Cm7#5</b> 	<b>Cm#9</b> 	<b>Cm7#9</b> 
<b>CM7#11</b> 	<b>CmM7</b> 	<b>CmM7#9</b> 	<b>Cdim</b> 	<b>Cdim7</b> 	<b>C7</b> 	<b>C7sus4</b> 
<b>C7#5</b> 	<b>C7#9</b> 	<b>C7#11</b> 	<b>C7#13</b> 	<b>C7#9</b> 	<b>C7#13</b> 	<b>C7#9</b> 
<b>CM7aug</b> 	<b>C7aug</b> 	<b>C1+8</b> 	<b>C1+5</b> 	<b>Csus4</b> 	<b>Csus2</b> 	

C = chord note  
C, R = recommended note

### ■ NTR (Note Transposition Rule) and NTT (Note Transposition Table)

#### • NTR (Note Transposition Rule)

This determines the system for pitch conversion of the source pattern. Two settings are available.

##### Root Trans (Root Transpose)

When the root note is transposed, the pitch relationship between notes is maintained. For example, the notes C3, E3 and G3 in the key of C become F3, A3 and C4 when they are transposed to F. Use this setting for channels that contain melody lines.



##### Root Fixed

The note is kept as close as possible to the previous note range. For example, the notes C3, E3 and G3 in the key of C become C3, F3 and A3 when they are transposed to F. Use this setting for channels that contain chord parts.



• **NTT (Note Transposition Table)**

This sets the note transposition table for the source pattern. Six transposition types are available.

**Bypass**

No transposition.

**Melody**

Suitable for melody line transposition. Use this for melody channels such as **Phrase 1** and **Phrase 2**.

**Chord**

Suitable for chord transposition. Use for the **Chord 1** and **Chord 2** channels, especially when they contain piano or guitar-like chordal parts.

**Bass**

Suitable for bass line transposition. This table is basically similar to the Melody table above, but recognizes on-bass chords allowed in the **FINGERED ON BASS** fingering mode. Use this primarily for bass lines.

**Melodic Minor**

When the played chord changes from a major to a minor chord, this table lowers the third interval in the scale by a semitone. When the chord changes from a minor to a major chord, the minor third interval is raised by a semitone. Other notes are not changed.

**Harmonic Minor**

When the played chord changes from a major to a minor chord, this table lowers the third and sixth intervals in the scale by a semitone. When the chord changes from a minor to a major chord, the minor third and flatted sixth intervals are raised by a semitone. Other notes are not changed.

■ **High Key/Note Limit**

• **High Key**

This sets the highest key (upper octave limit) of the note transposition for the chord root change. Any notes calculated to be higher than the highest key are transposed down to the octave just below the highest key. This setting is effective only when the NTR parameter (page 118) is set to "Root Trans."

**Example — When the highest key is F**

Root changes → CM      C#M      . . .      FM      F#M      . . .  
 Notes played → C3-E3-G3      C#3-F3-G#3      F3-A3-C4      F#2-A#2-C#3



• **Note Limit**

This sets the note range (highest and lowest notes) for voices recorded to the style channels. By judicious setting of this range, you can ensure that the voices sound as realistic as possible — in other words, that no notes outside the natural range are sounded (e.g., high bass sounds or low piccolo sound). The actual notes that sound are automatically shifted to the set range.

**Example — When the lowest note is C3 and the highest is D4**

Root changes → CM      C#M      . . .      FM      . . .  
 Notes played → E3-G3-C4      F3-G#3-C#4      F3-A3-C4



■ **RTR (Retrigger Rule)**

These settings determine whether notes stop sounding or not and how they change pitch in response to chord changes.

**Stop**

The notes stop sounding.

**Pitch Shift**

The pitch of the note will bend without a new attack to match the type of the new chord.

**Pitch Shift to Root**

The pitch of the note will bend without a new attack to match the root of the new chord.

**Retrigger**

The note is retriggered with a new attack at a new pitch corresponding to the next chord.

**Retrigger To Root**

The note is retriggered with a new attack at the root note of the next chord. However, the octave of the new note remains the same.

# Adjust the Volume Balance and Changing Voices

## — Mixing Console

Set up just like a real mixing console, this display gives you comprehensive control over the sound.

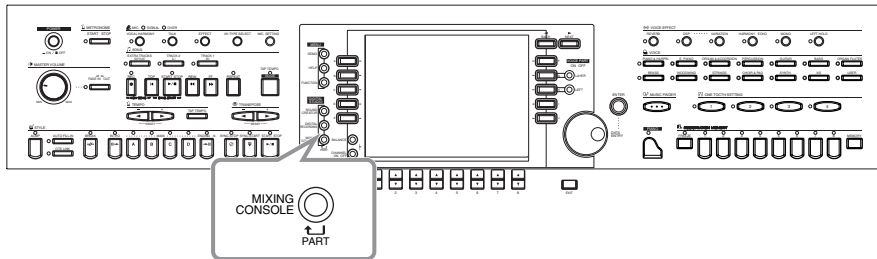

### NOTE

#### Mixing Console

This set of controls lets you adjust the balance of the voices and their stereo position, as well as the amount of effect that is applied to each voice.

You can call up additional basic mixing controls by using the [BALANCE] button and the [CHANNEL ON/OFF] button (page 62).

## Operation

1

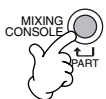

From the **MIXING CONSOLE** display, press the button repeatedly until the desired display is called up. Each press of the button switches among the displays listed below.

### PANEL PART

Includes the keyboard-played parts (Main/Layer, Left), accompaniment parts, song, microphone input.

### STYLE PART

Accompaniment parts

### SONG CH 1 - 8

Channels 1 - 8 of song playback

### SONG CH 9 -16

Channels 9 - 16 of song playback



### NOTE

You can quickly and easily set all parts to the same value for the same parameter (except for the VOICE parameter). Simultaneously hold down the [A] - [J] button that corresponds to the parameter you want to change and use the [1] - [8] buttons or the [DATA ENTRY] dial to change the value.

### NOTE

For details on parameters related to the **Sound Creator**, see page 89.

2

Select the other Mixing Console pages by using the [BACK]/[NEXT] buttons and set the desired parameters.

For information on the various parameters and settings and how to use them, refer to the explanations starting on page 121.



Close the **Mixing Console** display by pressing the [EXIT] button.

### ■ About the parameters

#### • VOL/VOICE (Volume/Voice) (page 121)

This contains settings related to the volume and voice of each part/channel. Here you can also enable the Auto Revoice feature — which automatically plays XG-compatible songs (page 160) with the rich and dynamic voices that are exclusive to the CVP-209/207. This gives you much more authentic and realistic instrument sounds for your song playback.

#### • FILTER (page 122)

These controls affect the tone quality of the voice, letting you add power, punch, or brightness to the sound.

#### • TUNE (page 122)

These give you various tuning controls.

#### • EFFECT (page 123)

These control the amount of effect applied to the sound.

#### • EQ (page 125)

Determines the overall tone quality of the instrument, letting you adjust the sound to match the particular performance space. Also you can adjust the volume or tone quality for each part.



# Setting the Level Balance and Voice — Volume/Voice

The operations for this page apply to step 2 of the procedure on page 120.

**NOTE**

The [RHY1] channel in the STYLE PART display can be assigned to any voice except for the Organ Flute voice.

**NOTE**

When playing GM song data, channel 10 (in the SONG CH 9 - 16 page) can only be used for a Drum Kit voice.

**NOTE**

When changing the rhythm/percussion voices (drum kits, etc.) of the accompaniment style and song from the VOICE parameter, the detailed settings related to the drum voice are reset, and in some cases you may be unable to restore the original sound. In the case of song playback, you can restore the original sound by returning to the beginning of the song and playing back from that point. In the case of accompaniment style play, you can restore the original sound by selecting the same style again.

**1**

Use these to select the **VOICE**, **PANPOT**, or **VOLUME** parameter rows.

Set this to ON to enable automatic replacement of the XG voices (in XG song data) with the special voices of the CVP-209/207. To use the normal XG voice set, turn this off.

Each press of this button switches among the various parts/channels.

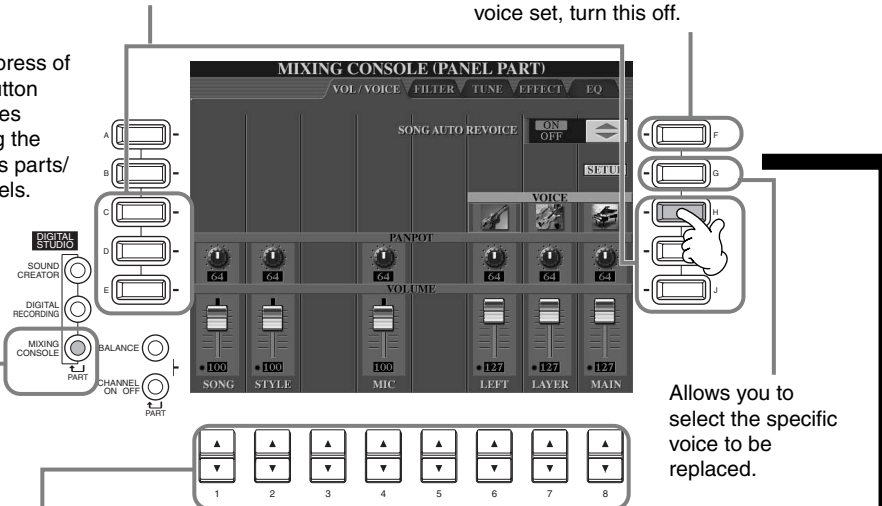

Allows you to select the specific voice to be replaced.

These let you select the voice of each part, and adjust the panpot and volume.

**VOICE**

Calls up the **VOICE** display, from which you can select the desired voice (page 55). When the Style part is selected, neither Organ Flutes voices nor User voices can be selected. When the Song part is selected, User voices cannot be selected.

**PANPOT**

Determines the stereo position of the selected voice or track. A setting of 0 pans the sound hard left, while 64 is at center, and 127 is at hard right.

**VOLUME**

Determines the level of each channel, giving you fine control over the balance of all the parts.

**2**

**ALL REVOICE**

Replaces all of the replaceable XG voices with the rich and authentic voices of the CVP-209/207.

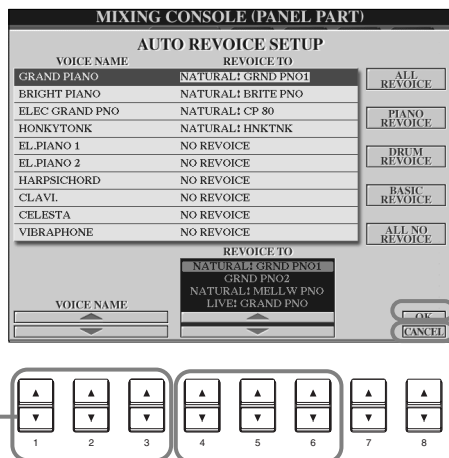

**PIANO REVOICE**

Replaces only the piano voices.

**DRUM REVOICE**

Replaces only the drum voices.

**BASIC REVOICE**

Replaces only the recommended voices that are suitable for playing back the song.

**ALL NO REVOICE**

All the voices are returned to the original XG voices.

Selects the XG voices to be replaced (voices usually used when playing back).

Selects the voices used to replace the XG voices (when SONG AUTO REVOICE is set to ON).

Closes the **Auto Revoice Setup** screen without executing the settings.

Executes the settings and closes the **Auto Revoice Setup** display.

**NOTE**

**PIANO, BASIC and DRUM** can be called up simultaneously.

**NOTE**

Keep in mind that using the Revoice function may result in unnatural or unexpected sound, depending on the particular song data.

## Changing the Tone of the Voice — Filter

The operations for this page apply to step 2 of the procedure on page 120.

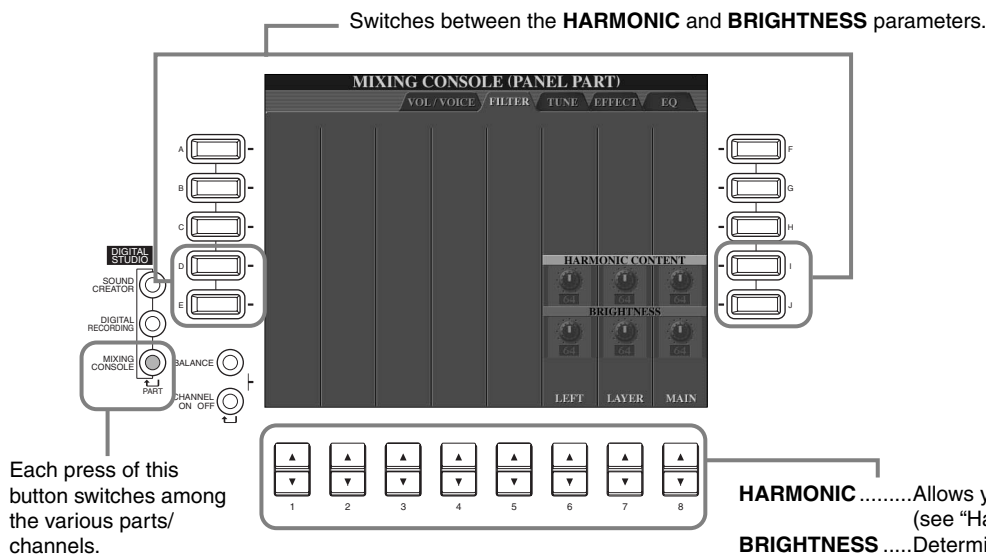

**NOTE**  
For details about the Filter, see page 91.

**NOTE**  
When a **Natural voice** is selected, **Harmonic** and **Brightness** cannot be changed.

**NOTE**  
Be careful with these controls. Depending on the selected voice, extreme settings may result in noise or distortion.

**HARMONIC** ..... Allows you to adjust the resonance effect (see “Harmonic Content” on page 91).  
**BRIGHTNESS** ..... Determines the brightness of the sound by adjusting the cutoff frequency (page 91).

## Changing Pitch-related Settings — Tune

The operations for this page apply to step 2 of the procedure on page 120.

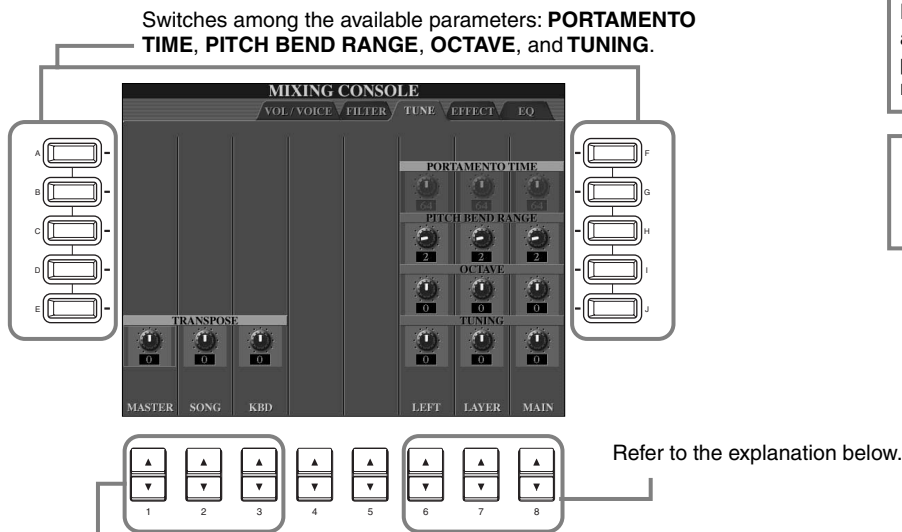

**NOTE**  
**Portamento** is used to create a smooth transition in pitch from one note to the next.

**NOTE**  
When a **Natural voice** is selected, **Portamento Time** cannot be changed.

These increase/decrease (transpose) the pitch in semitone units.  
**MASTER** ... Transposes both the pitch of the keyboard and that of the song playback.  
**SONG** ..... Transposes the pitch of the song playback.  
**KBD** ..... Transposes the pitch of the keyboard.

**PORTAMENTO TIME** ..... When the part is set to Mono (page 59, 90), this determines the Portamento time. The higher the value, the longer the time it takes for the pitch to change. Portamento is only applied when you play legato (playing the next note before releasing the previous one).  
**PITCH BEND RANGE** ..... When the Pitch Bend or Glide effect is assigned to the pedal, this determines the range of the pitch change in semitones.  
**OCTAVE** ..... Determines the range of the pitch change in octaves, over two octaves up or down.  
**TUNING** ..... Determines the pitch of the instrument.

# Adjusting the Effects

The operations for this page apply to step 2 of the procedure on page 120.

**NOTE**

There are three effect sections: Reverb, Chorus, and DSP (which contains a variety of effect types). These are available independently for the Natural voices and Regular voices. For details, refer to the Effect Block list (page 124).

**1**

Indicates the type name for each effect block. When a Natural voice is selected, the type names are indicated above the relevant knobs in the display.

Indicates the type name for each part. When a Natural voice is selected, the effect block names are indicated.

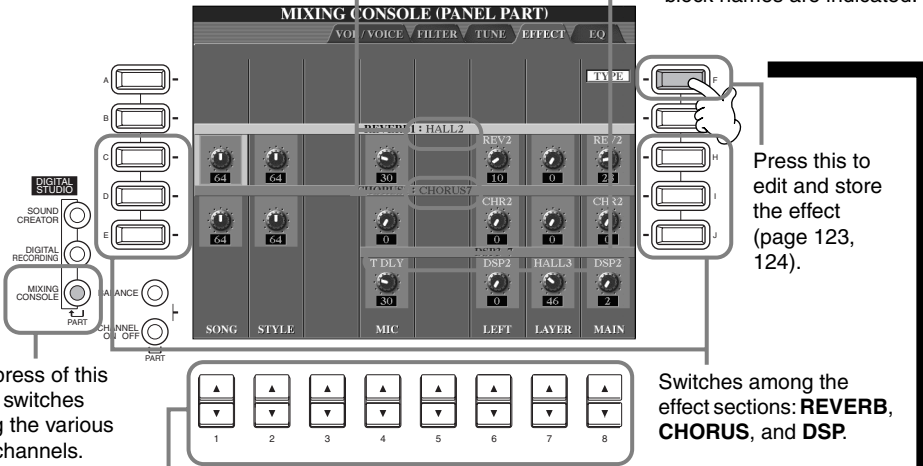

Each press of this button switches among the various parts/channels.

Press this to edit and store the effect (page 123, 124).

Switches among the effect sections: **REVERB**, **CHORUS**, and **DSP**.

Determines the amount of effect that is applied to each part. For more information about the characteristics of each effect, see the **Effect Block** list on page 124.

**2**

When the **BLOCK** parameter is set to **REVERB1**, **CHORUS1**, or **DSP 3-7** (CVP-209)/ **DSP 3-5** (CVP-207), press this to call up the display from which you can change the detailed settings for the effects.

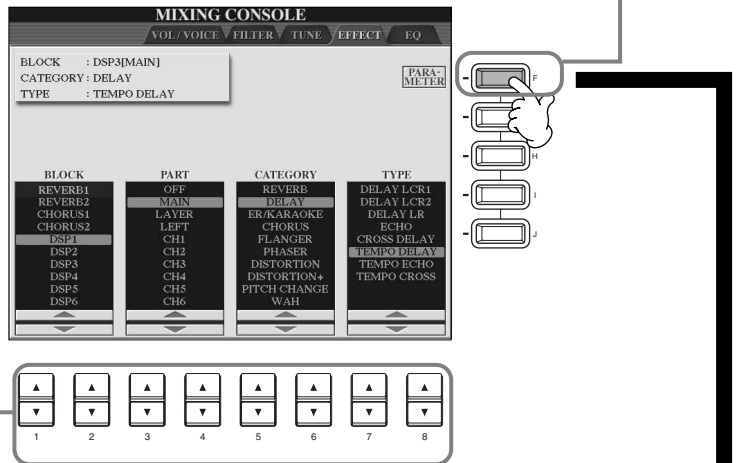

These determine the effect block and let you assign the effect.

**BLOCK** ..... Determines the effect block (group of similar or related effects).

**PART** ..... Determines the part to which the Insertion effect is applied. It is effective only when **BLOCK** is set to "DSP1," **PARAMETER** is set to "CONNECTION," and **VALUE** is set to "Insertion" — or when **BLOCK** is set to "DSP 3-7" (CVP-209) or "DSP 3-5" (CVP-207).

**CATEGORY** .... The various effect programs (in **Type** below) are grouped into categories. This parameter may not be available depending on the selected block.

**TYPE** ..... Determines the type of effect that is assigned to the selected effect block. The actual effect types that are available may differ depending on the selected block.

**3**

Switches between the upper/lower parameters. For the lower parameter, the depth can be changed when the [VARIATION] button is on.

Determines the effect block.

Determines the effect category.

Determines the effect type.

CALLS UP THE DISPLAY FOR STORING THE EFFECT.

Determines the level of the effect (return level). This is not available when BLOCK is set to "DSP1," PARAMETER is set to "CONNECTION," and VALUE is set to "Insertion" or when BLOCK is set to "DSP 3-7" (CVP-209) / "DSP 3-5" (CVP-207).

Determines the value of the selected parameter.

**NOTE**  
This parameter cannot be set when BLOCK is set to "REVERB2," "CHORUS2," or "DSP2" (or "BRILLIANCE.")

**4**

CALLS UP THE DISPLAY FOR NAMING THE USER EFFECT (page 46).

Stores the effect settings you made above to a **User Effect** location (SYSTEM) for future recall. To call up the effect, select **USER** from the **CATEGORY** parameter and select the desired effect from the **TYPE** parameter.

Select the destination to which the effect is to be stored. The number of memory spaces available for the destination differs for each block (refer to the chart below).

**NOTE**  
Keep in mind that in some cases noise may result if you adjust the effect parameters while playing the instrument.

**Effect Block**

Block	Parts	Characteristics	Number of User Effect
<b>REVERB 1</b> (for Regular Voices)	All parts	Reproduces the warm ambience of playing in a concert hall or jazz club.	3
<b>REVERB 2</b> (for Natural Voices)	All parts except microphone (MIC)		—
<b>CHORUS 1</b> (for Regular Voices)	All parts	Produces a rich "fat" sound as if several parts are being played simultaneously.	3
<b>CHORUS 2</b> (for Natural Voices)	All parts except microphone (MIC)		—
<b>DSP 1</b> (for Regular Voices)	Song (Ch. 1 - 16), Style	In addition to reverb and chorus effects, this section features a variety of special effects, including distortion. When "MIC" is selected (CVP-207 only), you can apply various effects to your own voice, via the connected microphone.	3
<b>DSP 2</b> (for Natural Voices)	All parts except microphone (MIC)		—
<b>DSP 3-6</b> (DSP6; CVP-209 only) (for Regular Voices)	Main, Layer, Left, Song (Ch. 1-16), MIC (CVP-207 only)	This lets you apply various effects to your own voice, via the connected microphone.	10
<b>DSP 7</b> (CVP-209 only)	MIC		10

## Adjusting the Sound to Match the Performance Environment — EQ

Usually an equalizer is used to correct the sound output from amps or speakers to match the special character of the room. The sound is divided into several frequency bands, allowing you to correct the sound by raising or lowering the level for each band. The equalizer allows you to adjust the tone or timbre of the sound to match the performance space, or to compensate for certain acoustic characteristics in your room. For example, you can cut some of the low range frequencies when playing on stages or in large studio spaces where the sound is too “boomy,” or boost the high frequencies in rooms and close spaces where the sound is relatively “dead” and free of echoes. The CVP-209/207 possesses a high grade five-band digital equalizer function. With this function, a final effect—tone control—can be added to the output of your instrument.

The explanations here apply to step 2 of the procedure on page 120.

Selects a Master EQ type.

Use the [1▲▼] - [8▲▼] buttons to adjust the EQ Low parameters (amount of gain of the low frequency) for each part.

Each press of this button switches among the various parts/channels.

Select this to call up the MASTER EQ display. Use the [1▲▼] - [8▲▼] buttons to adjust the EQ High parameters (amount of gain of the high frequency) for each part.

Use the [1▲▼] - [8▲▼] buttons to adjust the EQ High parameters (amount of gain of the low frequency) for each part.

Select a MASTER EQ type.

This lets you store your edited PRESET or USER curve to USER 1 or USER 2.

Adjusts the overall gain of all EQ bands simultaneously.

Whenever an EQ band is edited, the corresponding EQ value is highlighted and the number of the edited band appears above the Q and FREQ controls. The Q and FREQ controls can then be used to adjust the Q (bandwidth) and the FREQ (center frequency) of the selected band. The higher the “Q”, the narrower the bandwidth. The available FREQ range is different for each band.

The PRESET and USER curves can be edited as required via the corresponding buttons. Each of the five bands can be boosted or cut by up to 12 dB.

## Effect Structure

The CVP-209/207 features the following digital effect systems, which can be applied independently for the Natural voices (page 89) and the Regular voices (page 89). The effect type, depth, and various parameters can be set with the panel controls.

### About the Effect Connections — System and Insertion

All the effect blocks are connected or routed in one of two ways: System or Insertion. System applies the selected effect to all parts, while Insertion applies the selected effect to one specific part. Reverb, Chorus and DSP 2 are System effects, and DSP 3 - 7 (CVP-209)/DSP 3 - 5 (CVP-207) are Insertion effects. The DSP 1 effect, on the other hand, can be configured for either System or Insertion routing.

The illustration below shows how the various effect blocks are set up and traces the signal flow for the send/return controls set on the CVP-209/207.

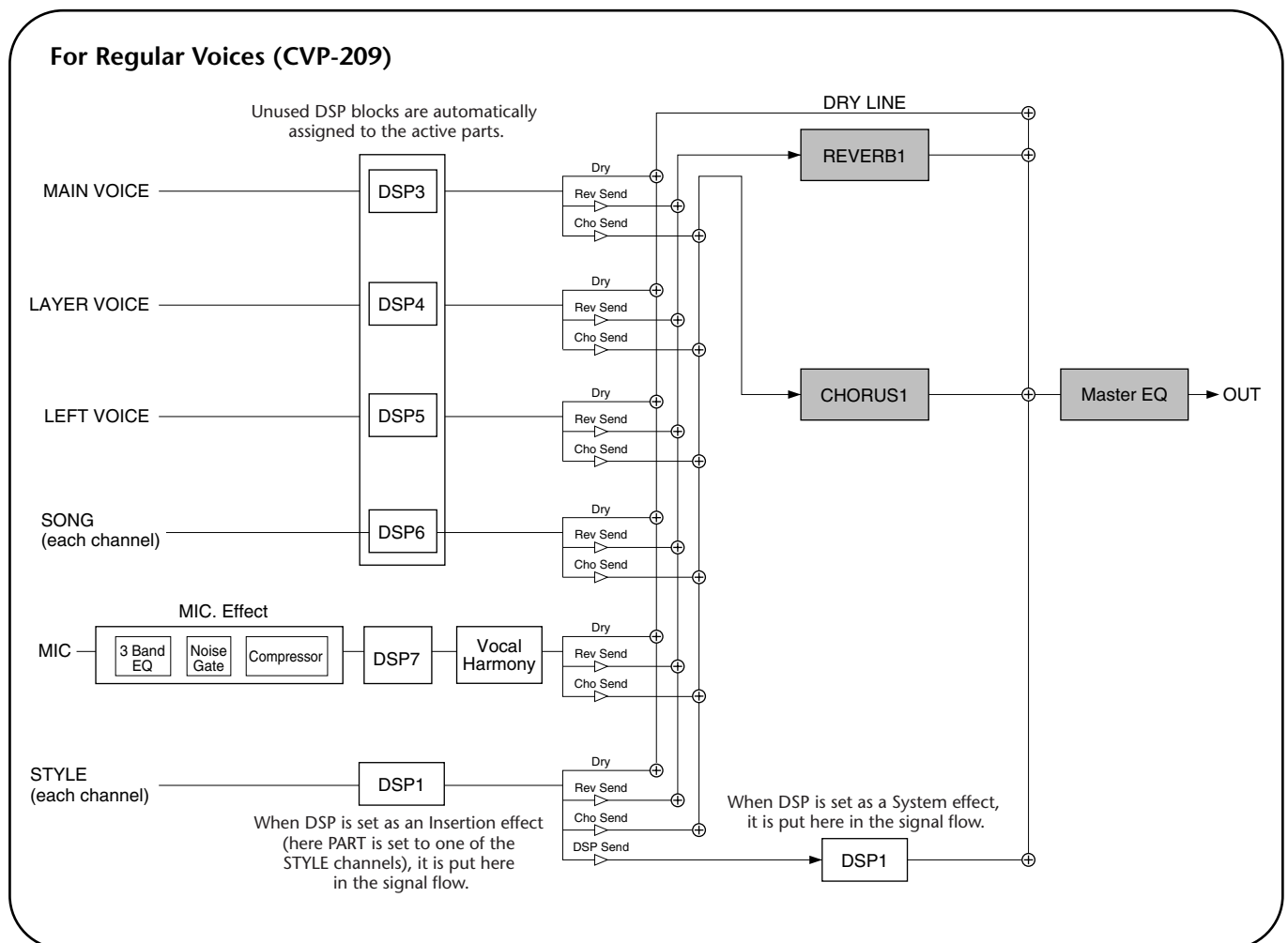

### For Regular Voices (CVP-207)

Unused DSP blocks are automatically assigned to the active parts.

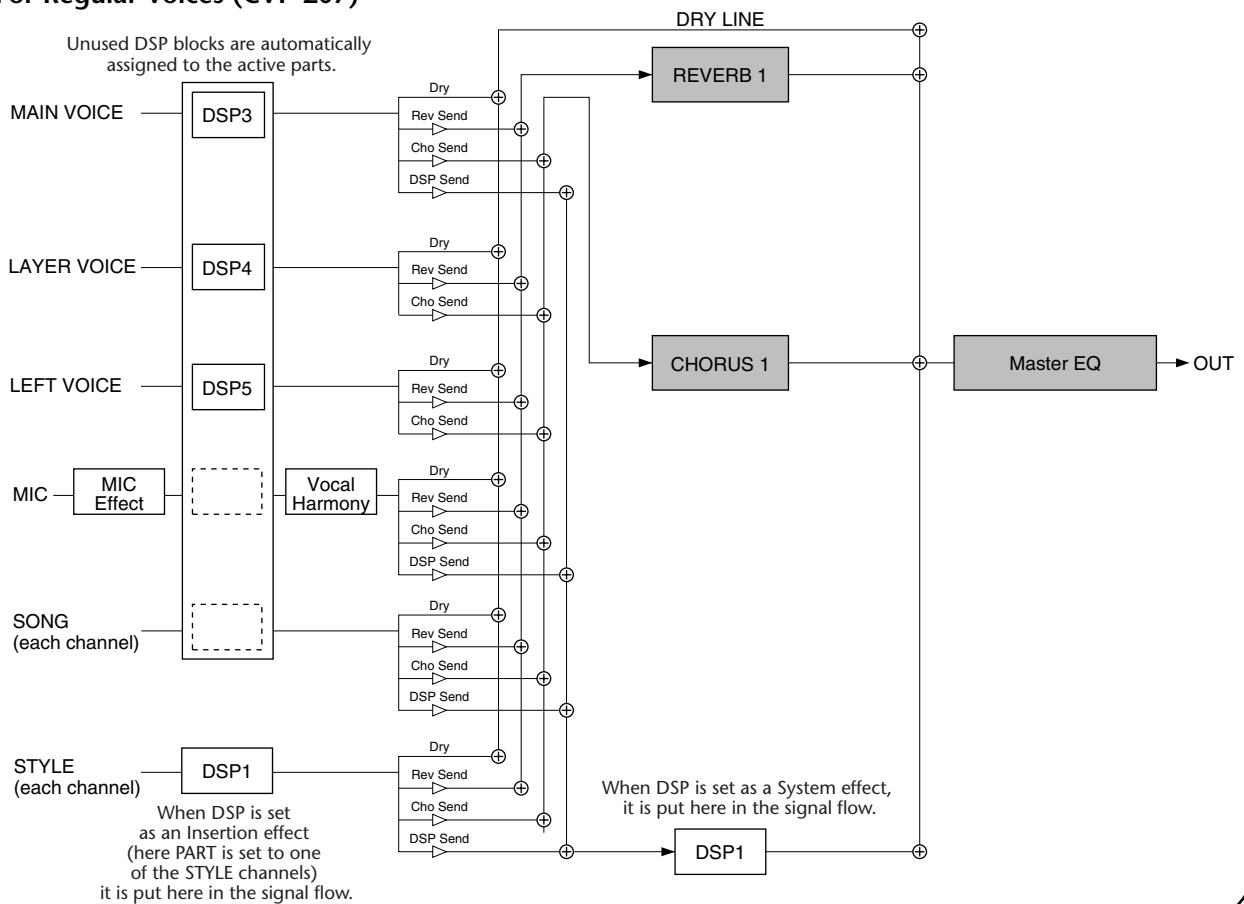

### For Natural Voices

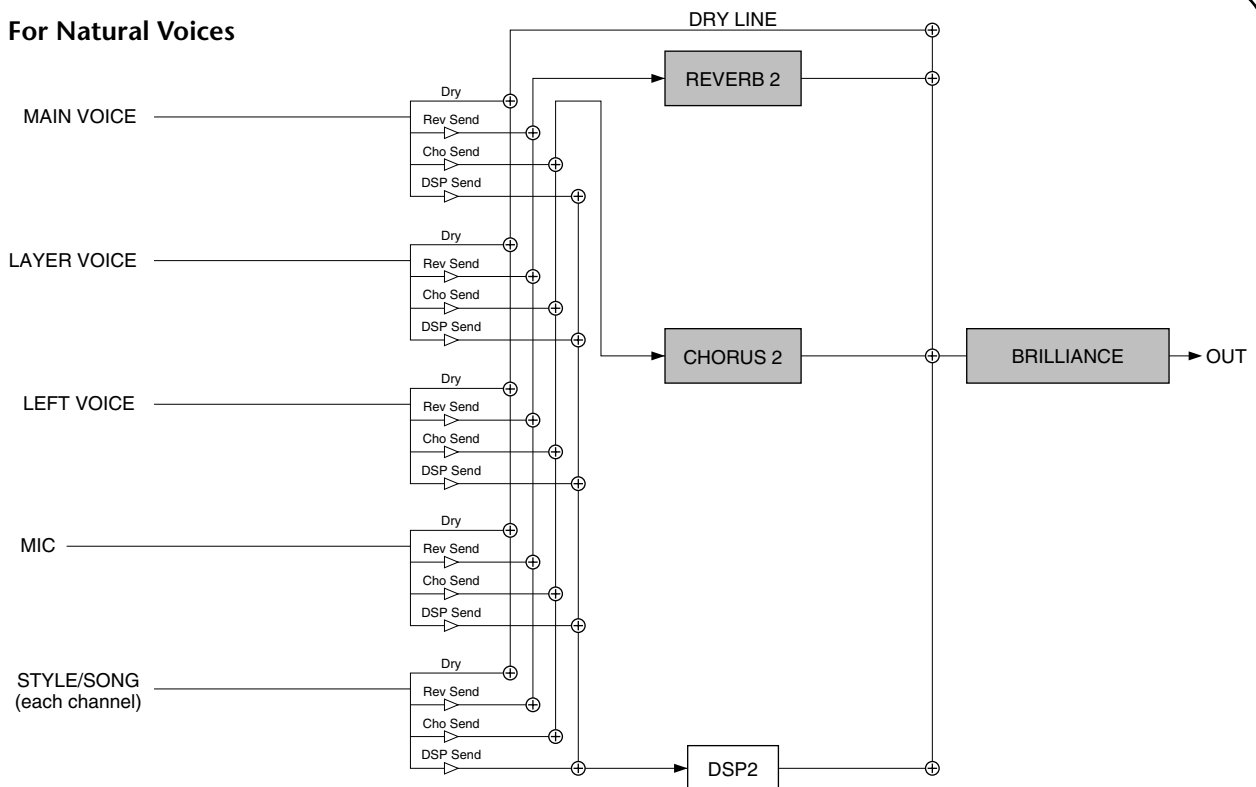

# Using a Microphone — MIC.

This extraordinarily powerful feature uses advanced voice-processing technology to automatically produce vocal harmony based on a single lead vocal. Four distinct harmony modes as well as an extensive selection of preset harmony types are provided. In addition to straightforward harmony, the CVP-209/207 also lets you change the apparent gender of the harmony and/or lead vocal sound. For example, if you are a male singer, you can have the CVP-209/207 automatically generate a two-part female backup. A comprehensive set of parameters gives you exceptionally precise and flexible control over the vocal harmony sound.

**NOTE**  
For details about connecting a microphone, see page 152.

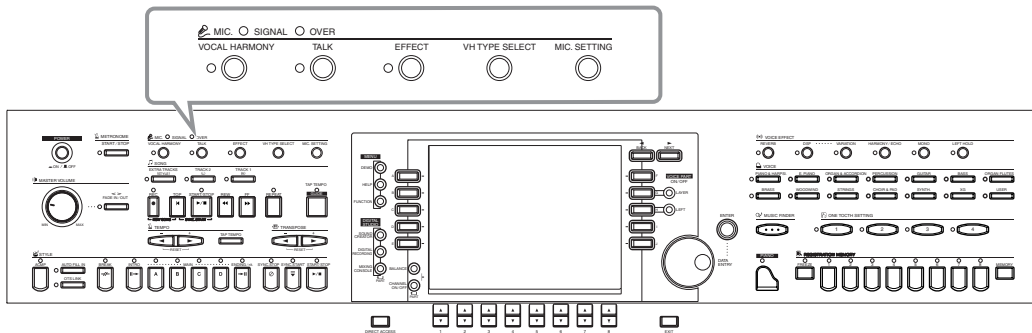

Use the SIGNAL and OVER indicators to determine the appropriate setting (page 152).

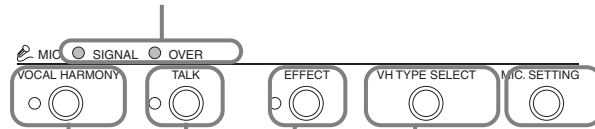

This calls up the **MICROPHONE SETTING** display (page 130) and lets you adjust the level of the microphone and vocal harmony effect.

If you connect a microphone to the CVP-209/207, you can sing along with the song or auto accompaniment and have vocal harmony parts added automatically.

This calls up the **VOCAL HARMONY TYPE** display (see below) and lets you set the desired harmony type.

This convenient function lets you temporarily cancel the vocal harmony or other microphone effects when using a connected microphone. This is especially useful when you talk between songs during a performance.

Determines the on/off setting of the effect applied to the microphone, set in the **MIXING CONSOLE** display (page 123).

## Selecting a Vocal Harmony Type

**1** Press the [VH TYPE SELECT] button.

**2**

Select a Vocal Harmony type.

This lets you adjust the amount of harmony effect that is applied.



3

Save the changed data (page 39, 45).

Select a Vocal Harmony type. Select a Vocal Harmony parameter (see below).

Adjust the parameter value.

Return to the **VOCAL HARMONY TYPE** display.



Press the [EXIT] button to return to the previous display.

**NOTE**  
The saved settings can be named (page 42) or deleted (page 44) in the USER page.

**Vocal Harmony Parameter List**

Chordal Type/Vocoder Type	Determines how the harmony notes are applied.
Harmony Gender Type	Can be set to "Off" or "Auto". When "Auto", the gender of the harmony sound is changed automatically.
Lead Gender Type	Determines whether and how the gender of the lead vocal sound (i.e., the direct microphone sound) will be changed. When "Off" no gender change occurs. When "Unison", "Male" or "Female" is selected the corresponding gender change is applied to the lead vocal. (In this case the number of harmony notes which can be produced in addition to the lead vocal is reduced to one.)
Lead Gender Depth	Adjusts the degree of lead vocal gender change produced when one of the Lead Gender Types (above) is selected.
Lead Pitch Correction	When "Correct" is selected the pitch of the lead vocal is shifted in precise semitone steps. This parameter is only effective when one of the Lead Gender Types is selected.
Auto Upper Gender Threshold	Gender change will occur when the harmony pitch reaches or exceeds the specified number of semitones above the lead vocal pitch.
Auto Lower Gender Threshold	Gender change will occur when the harmony pitch reaches or exceeds the specified number of semitones below the lead vocal pitch.
Upper Gender Depth	Adjusts the degree of gender change applied to harmony notes higher than the Auto Upper Gender Threshold.
Lower Gender Depth	Adjusts the degree of gender change applied to harmony notes lower than the Auto Lower Gender Threshold.
Vibrato Depth	Sets the depth of vibrato applied to the harmony sound. Also affects the lead vocal sound if a Lead Gender Type is selected.
Vibrato Rate	Sets the speed of the vibrato effect.
Vibrato Delay	Specifies the length of the delay before the vibrato effect begins when a note is produced.
Harmony 1/2/3 Volume	Sets the volume of the first, second, or third harmony note, respectively. Harmony notes 1 - 3 are assigned in order of ascending pitch (1 is the lowest pitch, 3 is the highest).
Harmony 1/2/3 Pan	Specifies the stereo (pan) position of the first, second, or third harmony note, respectively. Harmony notes 1 - 3 are assigned in order of ascending pitch (1 is the lowest pitch, 3 is the highest). When "Random" is selected the stereo position of the sound will change randomly whenever the keyboard is played.
Harmony 1/2/3 Detune	Detunes the first, second, or third harmony note respectively by the specified number of cents. Harmony notes 1 - 3 are assigned in order of ascending pitch (1 is the lowest pitch, 3 is the highest).
Pitch to Note	When "ON" the lead vocal sound "plays" the CVP-209/207 tone generator system. (However, dynamic changes in the vocal sound do not affect the volume of the tone generator.)
Pitch to Note Part	Determines which of the CVP-209/207 parts will be controlled by the lead vocal when the Pitch to Note parameter is "ON".

# Making Settings for the Vocal Harmony and Microphone — MICROPHONE SETTING

## Operation

**1** Press the [MIC. SETTING] button.

**END**  
Press the [EXIT] button to return to the previous display.

**2** Select the MICROPHONE SETTING page by using the [BACK]/[NEXT] button and set the parameters.  
For information on the various parameters and settings and how to use them, refer to the explanations below.

## Adjusting the Vocal Harmony Settings and Microphone Effects — OVERALL SETTING

The explanations here apply to step 2 above.

Select the 3BAND EQ.

Select the NOISE GATE/COMPRESSOR.

Select the VOCAL HARMONY CONTROL/MIC.

Use these to change the value for each function or setting. For details, see below.

### ■ 3BAND EQ (3-BAND EQUALIZER)

Usually an equalizer is used to correct the sound output from amps or speakers to match the special character of the room. The sound is divided into several frequency bands, allowing you to correct the sound by raising or lowering the level for each band. The CVP-209/207 features a high grade three-band digital equalizer function for the microphone sound.

- Hz** ..... Adjusts the center frequency of the corresponding band.
- dB** ..... Boosts or cuts the level of the corresponding band by up to 12 dB.

### ■ NOISE GATE

This effect mutes the input signal when the input from the microphone falls below a specified level. This effectively cuts off extraneous noise, allowing the desired signal (vocal, etc.) to pass.

- SW** ..... "SW" is the abbreviation of Switch. This turns Noise Gate on or off.
- TH.** ..... "TH." is the abbreviation of Threshold. This adjusts the input level at which the gate begins to open.

## ■ COMPRESSOR

This effect holds down the output when the input signal from the microphone exceeds a specified level. This is useful when recording a signal with widely varying dynamics. It effectively “compresses” the signal, making soft parts louder and loud parts softer.

**SW**..... “SW” is the abbreviation of Switch. This turns Compressor on or off.

**TH.** ..... “TH.” is the abbreviation of Threshold. This adjusts the input level at which compression begins to be applied.

**RATIO** ..... This adjusts the compression ratio.

**OUT** ..... Adjusts the final output level.

## ■ VOCAL HARMONY CONTROL

The following parameters determine how the harmony is controlled.

### VOCODER CONTROL

The Vocal Harmony effect is controlled by note data — the notes you play on the keyboard and/or the notes of the song data. This parameter lets you determine which notes are used to control the harmony.

#### • SONG CHANNEL

##### MUTE/PLAY:

When set to “MUTE,” the channel selected below is muted (turned off) during keyboard performance or song playback.

##### OFF:

Song data control over harmony is turned off.

##### 1-16:

When playing back a song from disk or external MIDI sequencer, the note data recorded to the assigned song channel controls the harmony.

#### • KEYBOARD

**OFF:** Keyboard control over harmony is turned off.

**UPPER:** Notes played to the right of the split point control the harmony.

**LOWER:** Notes played to the left of the split point control the harmony.

### BALANCE

This lets you set the balance between the lead vocal (your own voice) and Vocal Harmony. Raising this value increases the volume of the Vocal Harmony and decreases that of the lead vocal. When this is set to L<H63 (L: Lead Vocal, H: Vocal Harmony), only the Vocal Harmony is output; when it is set to L63>H, only the lead vocal is output.

### MODE

All of the Vocal Harmony types fall into one of three modes which produce harmony in different ways. The harmony effect is dependent on the selected Vocal Harmony Mode and Track, and this parameter determines how the harmony is applied to your voice. The three modes are described below.

#### VOCODER:

The harmony notes are determined by the notes you play on the keyboard (Main, Layer and Left) and/ or song data which includes Vocal Harmony tracks.

#### CHORDAL:

During accompaniment playback, chords played in the auto accompaniment section of the keyboard control the harmony. During song playback, chords contained in song data control the harmony. (Not available if the song does not contain any chord data.)

#### AUTO:

When the auto accompaniment or Left part is set to ON and if chord data exists in the song, the mode is automatically set to CHORDAL. In all other cases, the mode is set to VOCODER.

### CHORD

The following parameters specify the song data which will be used for chord detection.

**OFF:** Chords are not detected.

**XF:** Chords of XF format are detected.

**1-16:** Chords are detected from note data in the specified song channel.

## ■ MIC (MICROPHONE)

The following parameters determine how the microphone sound is controlled.

**MUTE** ..... When set to OFF, the microphone sound is turned off.

**VOLUME** ..... Adjusts the volume of the microphone sound.

# Setting the Microphone Volume and Related Effects — TALK SETTING

Determines the settings when the [TALK] button is on.  
The explanations here apply to step 2 on page 130.

## VOLUME/PAN/REVERB DEPTH/CHORUS DEPTH/TOTAL VOLUME ATTENUATOR

The screenshot shows the 'TALK SETTING' screen with the following parameters and their controls:

- VOLUME:** 90 (Slider 1)
- PAN:** R6 (Slider 2)
- REVERB DEPTH:** 12 (Slider 3)
- CHORUS DEPTH:** 0 (Slider 4)
- TOTAL VOLUME ATTENUATOR:** -8dB (Slider 5)
- DSP MIC:** OFF (Button 6)
- TYPE:** EQ TEL (Button 7)
- DEPTH:** 127 (Slider 8)

Annotations for the TALK SETTING screen:

- Control 1: This determines the volume of the microphone sound.
- Control 2: This sets the stereo pan position of the microphone sound.
- Control 3: This determines the amount of attenuation to be applied to the overall sound (excepting the microphone input) — allowing you to effectively adjust the balance between your voice and the overall instrument sound.
- Controls 4 and 5: These set the depth of the reverb and chorus effects applied to the microphone sound.

## DSP/TYPER/DEPTH

The screenshot shows the 'DSP MIC' section of the 'TALK SETTING' screen with the following parameters and their controls:

- DSP MIC:** ON/OFF (Button 3)
- TYPE:** EQ TEL (Button 4)
- DEPTH:** 127 (Slider 5)

Annotations for the DSP MIC section:

- Control 3: This turns the DSP effect applied to the microphone sound ON or OFF.
- Control 4: This selects the type of DSP effect to be applied to the microphone sound.
- Control 5: This sets the depth of the DSP effect applied to the microphone sound.

# Making Global and Other Important Settings — Function

The Function mode gives you access to various advanced functions related to the instrument as a whole. These sophisticated functions let you customize the Clavinova to your own musical needs and preferences.

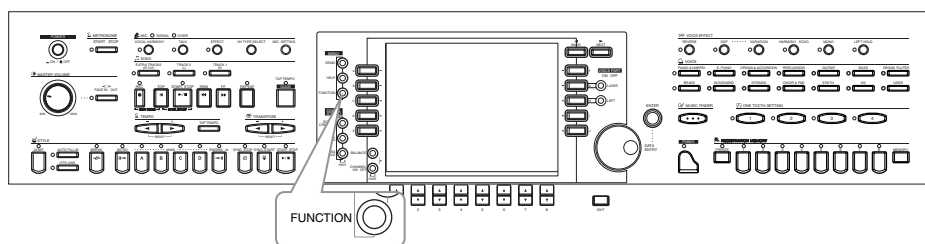

## Operation

1

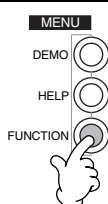

2

Select the desired function.



3

Set the parameters of the selected function.

The operations for each function are covered in the following explanations.



To return to the previous display, press the [EXIT] button.

## Adjusting the Pitch and Tuning — Master Tune and Scale Tune

### ■ Master Tune (page 135)

This allows you to make fine adjustments to the overall pitch of the instrument — letting you accurately match the tuning with that of other instruments.

### ■ Scale Tune (page 135)

This determines the particular tuning system (or temperament) for the instrument. This is especially useful for playing period pieces, to match the tuning system used during specific musical eras.

## Setting Song-related Parameters — Song Settings (page 137)

These allow you to set parameters related to song playback as well as the practice function types.

## Setting Auto Accompaniment-related Parameters — Style Setting, Split Point, and Chord Fingering

### ■ Style Setting / Split Point (page 138)

These determine the auto accompaniment-related settings, and let you set the split point.

### ■ Chord Fingering (page 139)

This determines the method for playing/indicating chords when using the auto accompaniment features. You can even check how to play the chord, since the individual notes are indicated in the display.

## Making Settings for the Pedals and Keyboard — Controller

---

### ■ Pedal (page 139)

These settings determine how the connected pedals (including foot controllers and footswitches) are used. They can be assigned to a variety of functions, letting you control operations with your feet — such as turning the accompaniment style on/off, or triggering Fill In patterns.

### ■ Keyboard / Panel (page 141)

These settings determine the touch sensitivity of the keyboard (how touch affects volume), and let you independently transpose the keyboard, song data, and the entire instrument.

## Setting the Registration Sequence, Freeze, and Voice Set

---

### ■ Registration Sequence (page 142)

This determines the order in which the Registration Memory presets (1 - 8) are called up — by using the [BACK][NEXT] buttons or the pedal.

### ■ Freeze (page 142)

This lets you specify the settings you want to be maintained or left unchanged, even when changing Registration Memory presets.

### ■ Voice Set (page 143)

This lets you determine whether certain voice-related settings (such as Effects, EQ, Harmony, etc.) are automatically called up or not when you select a voice.

## Setting Harmony and Echo (page 143)

---

These let you set the type of Harmony or Echo effect applied to the keyboard-played voices, as well as the amount of effect.

## Showing the Clavinova Display on a TV — Video Out (page 144)

---

These settings determine the contents of the Video Out signal when outputting the CVP-209/207's display contents to a TV monitor (connected to the VIDEO OUT terminal).

## Making MIDI Settings

---

### ■ System (page 145)

These determine various system messages settings (such as Clock, Start/Stop, System Exclusive), as well as Local Control on/off.

### ■ Transmit (page 146)

This determines how playback data is sent to connected MIDI devices — i.e., which parts are assigned to which MIDI Transmit channels. This also lets you specify the type of data to be transmitted over each channel.

### ■ Receive (page 147)

This determines how the parts of the CVP-209/207 respond to data from connected MIDI devices — i.e., which parts are assigned to which MIDI Receive channels. This also lets you specify the type of data to be received over each channel.

### ■ Root (page 147)

This determines the channel(s) recognized for the root notes, for use with the auto accompaniment.

### ■ Chord Detect (page 147)

This determines the channel(s) recognized for the chords, for use with the auto accompaniment.

## Other Settings — Utility

---

### ■ Config 1 (page 148)

This page contains settings for Fade In/Out, Metronome, Parameter Lock, and the Tap sound.

### ■ Config 2 (page 149)

From this page, you can adjust the display, make speaker settings, and change the voice number indication.

### ■ Disk (page 150)

From this page, you can format disks, and copy from disk to disk.

### ■ Owner (page 151)

From this page, you can set the language of the instrument, and input your own name — which is shown automatically every time the power is turned on. Also, you can select a background picture for the MAIN display.

### ■ System Reset (page 151)

This function restores the CVP-209/207 to its original factory settings. You can also specify which types of settings are to be restored, as well as store your own original settings for future recall.

## Fine Tuning the Pitch/Selecting a Scale — Master Tune/Scale Tune

The explanations here apply to step #3 of the procedure on page 133.

### Tuning the Overall Pitch — Master Tune

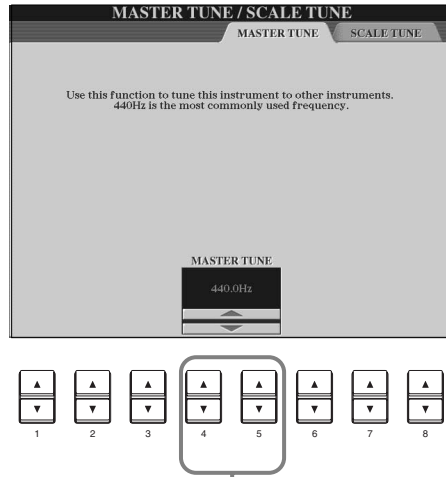

Determines the overall pitch of the CVP-209/207, from 414.8 - 466.8 Hz. Press the 4 or 5 [▲▼] buttons simultaneously to instantly reset the value to the factory setting of 440.0 Hz.

**NOTE**

**Hz (Hertz)**  
This unit of measurement refers to the frequency of a sound, and represents the number of times a sound wave vibrates in a second.

**NOTE**

The Tune function does not affect the Drum Kit or SFX Kit voices.

### Selecting a Scale — Scale Tune

The current tuning of each note is shown above or below the corresponding key.

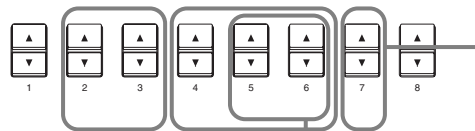
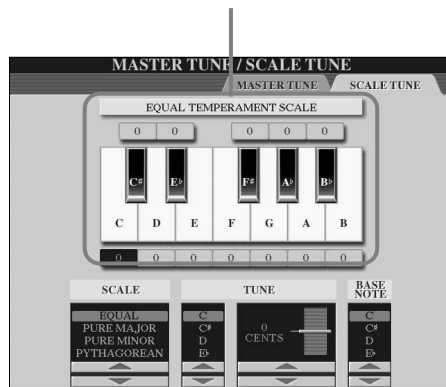

Determines the Scale (page 136).

Determines the fine tuning of the selected note in 1-cent steps. Press the 5 or 6 [▲▼] buttons simultaneously to instantly reset the value to the factory setting.

Determines the note to be tuned and the amount of tuning. The tuning range is from “-64” through “0” to “+63.” Each increment equals one cent (one “cent” is one hundredth of a semitone).

**NOTE**

**Cent**  
A unit of pitch equal to 1/100 of a semitone (100 cents = 1 semitone).

**NOTE**

You can register your original scale tunings to a REGISTRATION MEMORY button. To do this, check-mark “SCALE” in the REGISTRATION MEMORY display (page 85).

Determines the base note for each scale.  
When the base note is changed, the pitch of the keyboard is transposed, yet maintains the original pitch relationship between the notes.

## Scale

### ■ Equal Temperament

The pitch range of each octave is divided equally into twelve parts, with each half-step evenly spaced in pitch. This is the most commonly used tuning in music today.

### ■ Pure Major/Pure Minor

These tunings preserve the pure mathematical intervals of each scale, especially for triad chords (root, third, fifth). You can hear this best in actual vocal harmonies — such as choirs and acapella singing.

### ■ Pythagorean

This scale was devised by the famous Greek philosopher and is created from a series of perfect fifths, which are collapsed into a single octave. The 3rd in this tuning are slightly unstable, but the 4th and 5th are beautiful and suitable for some leads.

### ■ Mean-Tone

This scale was created as an improvement on the Pythagorean scale, by making the major third interval more “in tune.” It was especially popular from the 16th century to the 18th century. Handel, among others, used this scale.

### ■ Werckmeister/Kirnberger

This composite scale combines the Werckmeister and Kirnberger systems, which were themselves improvements on the mean-tone and Pythagorean scales. The main feature of this scale is that each key has its own unique character. The scale was used extensively during the time of Bach and Beethoven, and even now it is often used when performing period music on the harpsichord.

### ■ Arabic

Use these tunings when playing Arabic music.

### Pitch settings for each scale (in cents; example scale of C)

The values shown in this chart are actually rounded off to the nearest whole number for use on the instrument.

	C	C <sup>#</sup>	D	E <sup>b</sup>	E	F	F <sup>#</sup>	G	A <sup>b</sup>	A	B <sup>b</sup>	B
Equal Temperament	0	0	0	0	0	0	0	0	0	0	0	0
Pure Major	0	-29.7	3.9	15.6	-14.1	-2.3	-9.4	2.3	-27.3	-15.6	18.0	-11.7
Pure Minor	0	33.6	3.9	15.6	-14.1	-2.3	31.3	2.3	14.1	-15.6	18.0	-11.7
Pythagorean	0	14.1	3.9	-6.3	7.8	-2.3	11.7	2.3	15.6	6.3	-3.9	10.2
Mean-Tone	0	-24.2	-7.0	10.2	-14.1	3.1	-20.3	-3.1	-27.3	-10.2	7.0	-17.2
Werckmeister	0	-10.2	-7.8	-6.3	-10.2	-2.3	-11.7	-3.9	-7.8	-11.7	-3.9	-7.8
Kirnberger	0	-10.2	-7.0	-6.3	-14.1	-2.3	-10.2	-3.1	-7.8	-10.2	-3.9	-11.7
Arabic1	0	0	-50	0	0	0	0	0	0	-50	0	0
Arabic2	0	0	0	0	-50	0	0	0	0	0	0	-50



# Setting Song-related Parameters — Song Settings

The explanations here apply to step #3 of the procedure on page 133.

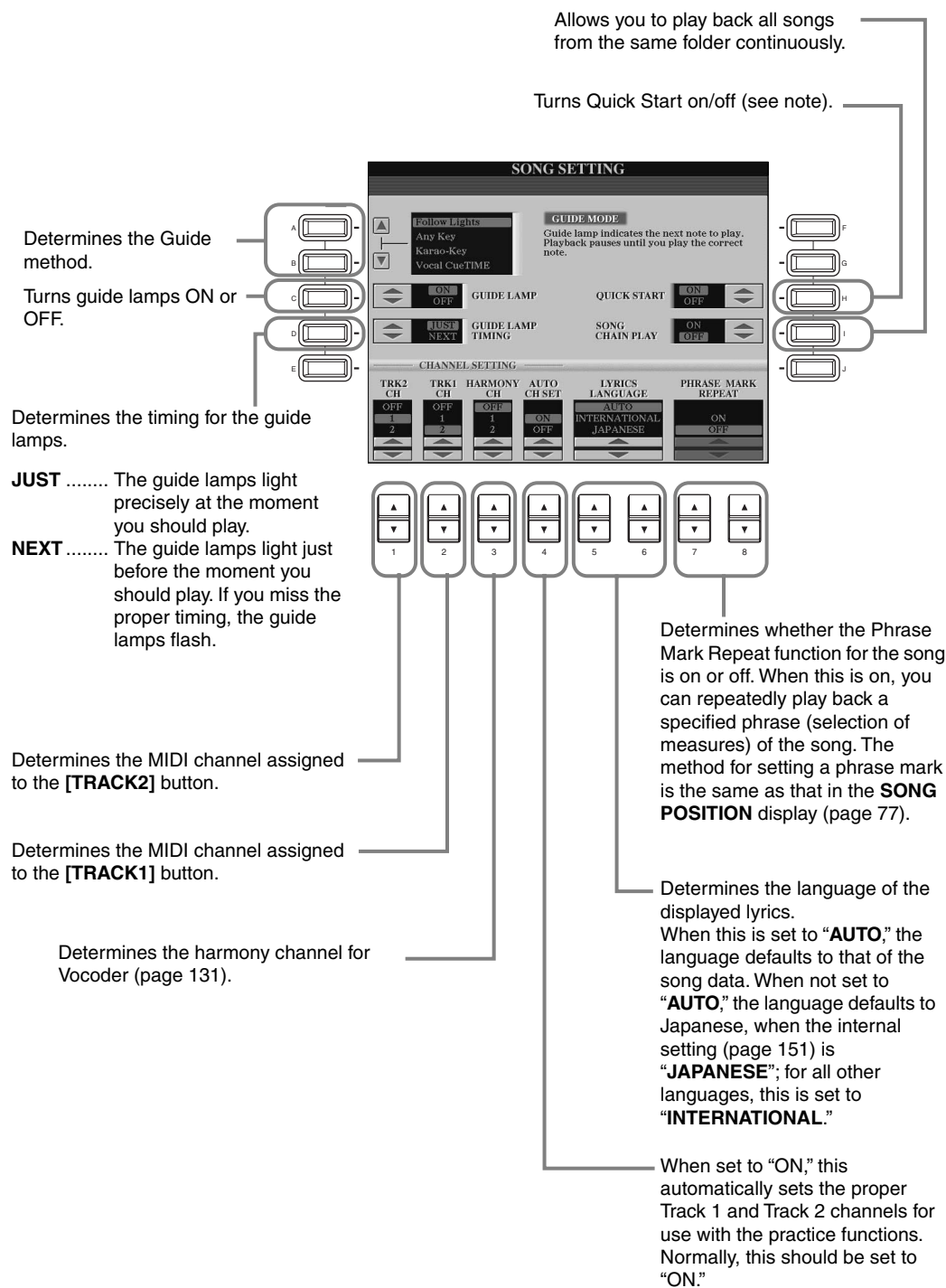

**NOTE**

**Quick Start**

On some commercially available song data, certain settings related to the song (such as voice selection, volume, etc.) are recorded to the first measure, before the actual note data. When Quick Start is set to **"ON,"** the CVP-209/207 reads all initial non-note data of the song at the highest possible speed, then automatically slows down to the appropriate tempo at the first note. This allows you to start playback as quickly as possible, with a minimum pause for reading of data.

**NOTE**

**Channel**

Refers to the MIDI channel (page 158). The channels are assigned as follows:

**Song**

1 - 16

**Accompaniment Style**

9 - 16

**NOTE**

The guide lamps light in response to song channel assigned to Tracks 1 and 2, as well as chord data (when contained in the song). Normally, you can leave the **AUTO SET CH** function set to **ON**, and the song channel will automatically be set. If the results aren't satisfactory, you'll need to match the Channel Setting **"TRK1 CH"** and **"TRK2 CH"** parameters to the appropriate right- and left-hand parts.

**NOTE**

**Phrase Mark**

This data specifies a certain location in the song data.

# Setting Auto Accompaniment-related Parameters — Style Setting, Split Point, and Chord Fingering

The explanations here apply to step #3 of the procedure on page 133.

## Setting Auto Accompaniment-related Parameters — Style Setting and Split Point

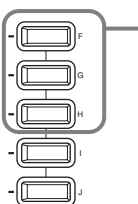
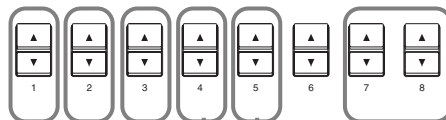
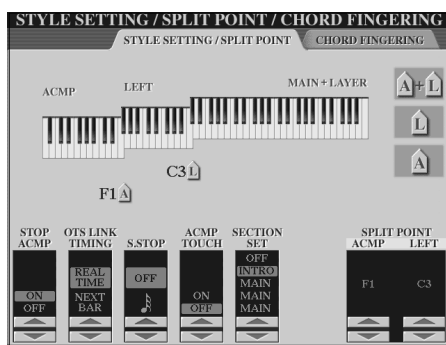

These select the part to which the split point setting is applied: accompaniment, left-hand range, or both. Press the desired key for the split point while holding down one of these buttons. The pressed key is included in the range for the Auto Accompaniment section of the keyboard (ACMP) or the left-hand range (LEFT).

**A+L (ACMP + LEFT)**

Allows you to simultaneously set the split point for both the left-hand range and the Auto Accompaniment section of the keyboard.

**L (LEFT)**

Allows you to set the split point for the left-hand range of the keyboard.

**A (ACMP)**

Allows you to set the split point for the Auto Accompaniment section of the keyboard.

Determines the split points for the auto accompaniment (ACMP) and the left-hand range (LEFT). The same value can be set for both or for each independently, using buttons [F], [G], and [H] (see above). You can use these buttons by themselves to set the split point value.

Determines the default section that is automatically called up when selecting different accompaniment styles (when accompaniment is stopped).

Turns touch response for the accompaniment on/off. When this is set to "ON," the accompaniment volume changes in response to your playing strength (in the Auto Accompaniment section of the keyboard).

The CVP-209/207 lets you automatically enable Sync Stop (page 66) simply by quickly pressing/releasing keys in the Auto Accompaniment section of the keyboard. This parameter lets you set the length of the key-hold time.

This applies to the OTS Link function, in which One Touch Settings are automatically called up with changes in the section. This determines the timing in which the One Touch Settings change with the section. (The [OTS LINK] button must be on.)

**Real Time**

One Touch Setting is immediately called up when you press a section button.

**Next Bar**

One Touch Setting is called up at the next measure, after you press a section button.

Turns the Stop Accompaniment (ACMP) function on/off. When this is set to "ON," you can play the chord and bass sounds of the accompaniment by playing chords — even when the accompaniment style is not playing back.

**NOTE**  
**About Section Set**  
 When any of the Main A-D sections is not included in the accompaniment style data, the nearest section is automatically selected. For example, when Main D is not contained in the selected accompaniment style, Main C will be called up.

**NOTE**  
 Split point can be set in the MAIN display.

**About Split Point**

Split point is the position on keyboard that separates the Auto Accompaniment section (ACMP) and left-hand section (LEFT) from the right-hand section (MAIN). The LEFT split point cannot be set lower than the ACMP split point, and the ACMP split point cannot be set higher than the LEFT split point.

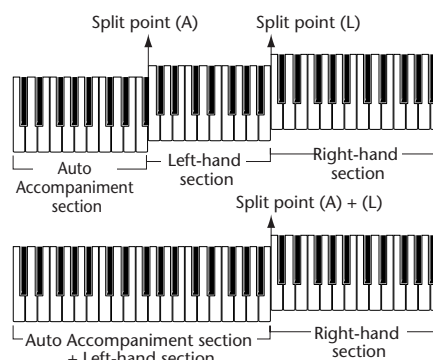

## Setting the Fingering Method — Chord Fingering

This determines how the notes you play on the keyboard indicate or play the chords of the accompaniment. To learn how to play certain chords, use the convenient Chord Tutor function (see note below).

**CHORD TUTOR (FINGERED)**  
CHORD NAME : C

● ...Required  
○ ...Can be omitted  
△ ...Either note can be omitted  
▲ ...Can be omitted when the note indicated by ○ is omitted

Determines the fingering type (page 62).

Indicates the note that belongs to a chord in the music.

This lets you change the root note from the chord.

This lets you change the chord type.

**NOTE**  
The chord indication in the display applies to the Fingering method, regardless if another method is actually selected.

**NOTE**  
**Chord Tutor**  
The Chord Tutor feature is essentially an electronic "chord book" that shows you appropriate fingerings for chords; it is useful when you want to play certain chords. Simply specify the desired chord via the [6▲▼] - [8▲▼] buttons, and the fingerings for the Fingering method are indicated in the display.

## Making Settings for the Pedals and Keyboard — Controller

The explanations here apply to step #3 of the procedure on page 133.

### Making Settings for the Pedals

Determines the particular pedal to which a function is to be assigned.

Determines the function to be assigned to the selected pedal. Any one of the available functions can be assigned to each pedal. For information on the assignable functions, see "Pedal-controllable Functions" on page 140.

If necessary, you can turn the corresponding part ON/OFF or set the control depth (see the next page).

Pedal on/off operation may differ depending on the particular pedal you've connected to the [AUX PEDAL] jack. For example, pressing down on one pedal may turn the selected function on, while pressing a different make/brand of pedal may turn the function off. If necessary, use this setting to reverse the operation.

## Pedal-controllable Functions

<b>VOLUME*</b>	Allows you to use a foot controller (AUX pedal only) to control the volume.
<b>SUSTAIN</b>	When the pedal is pressed notes played have a long sustain. Releasing the pedal immediately stops (damps) any sustained notes.
<b>SOSTENUTO</b>	If you press and hold the pedal here, only the first note will be sustained (the note that you played and held when pressing the pedal). This makes it possible to sustain a chord, for example, while other notes are played staccato.
<b>SOFT</b>	Pressing the pedal subtly reduces the volume and slightly changes the timbre of notes played. It only applies to certain voices — PIANO, for example.
<b>GLIDE</b>	When the pedal is pressed the pitch changes, and then back to normal pitch when the pedal is released.
<b>PORTAMENTO</b>	The portamento effect (a smooth slide between notes) can be produced while the pedal is pressed. Portamento is produced when notes are played legato style (i.e., a note is played while the preceding note is still held). The portamento time can be set via the Mixing Console display (page 122). It does not work for Natural voices.
<b>PITCHBEND*</b>	Bend notes up or down while pedal is pressed. This can only be set to the AUX pedal and the CVP-209/207's damper pedal.
<b>MODULATION*</b>	Applies a vibrato effect to notes played on the keyboard. The depth of the effect increases while pedal is pressed. This does not work for the Natural voices.
<b>DSP VARIATION</b>	Same as the [VARIATION] button. This does not work for the Natural voices.
<b>VIBROTOR ON/OFF</b>	Turns the "VibRotor" effect type (page 123) on and off. This only works for the Natural voices.
<b>HARMONY/ECHO</b>	Same as the [HARMONY/ECHO] button.
<b>VOCAL HARMONY</b>	Same as the [VOCAL HARMONY] button.
<b>TALK</b>	Same as the [TALK] button.
<b>SCORE PAGE+</b>	While the song is stopped, you can turn to the previous score page (one page only).
<b>SCORE PAGE-</b>	While the song is stopped, you can turn to the next score page (one page only).
<b>SONG START/STOP</b>	Same as the SONG [START/STOP] button.
<b>STYLE START/STOP</b>	Same as the STYLE [START/STOP] button.
<b>TAP TEMPO</b>	Same as the [TAP TEMPO] button.
<b>SYNCHRO START</b>	Same as the [SYNCHRO START] button.
<b>SYNCHRO STOP</b>	Same as the [SYNCHRO STOP] button.
<b>INTRO</b>	Same as the [INTRO] button.
<b>MAIN A</b>	Same as the MAIN [A] button.
<b>MAIN B</b>	Same as the MAIN [B] button.
<b>MAIN C</b>	Same as the MAIN [C] button.
<b>MAIN D</b>	Same as the MAIN [D] button.
<b>FILL DOWN</b>	A fill-in plays, automatically followed by the Main section of the button on the immediate left.
<b>FILL SELF</b>	Fill-in starts playing.
<b>BREAK</b>	Break starts playing.
<b>FILL UP</b>	A fill-in plays, automatically followed by the Main section of the button on the immediate right.
<b>ENDING</b>	Same as the [ENDING/rit.] button.
<b>FADE IN/OUT</b>	Same as the [FADE IN/OUT] button.
<b>FING/ON BASS</b>	The pedal alternately switches between the Fingered and On Bass modes (page 62).
<b>BASS HOLD</b>	While the pedal is pressed, the Accompaniment Style bass note will be held even if the chord is changed. If the fingering is set to "FULL KEYBOARD," the function does not work.
<b>PERCUSSION</b>	The pedal plays a percussion instrument selected by the [4▲▼] - [8▲▼] buttons. You can use the keyboard to select the desired percussion instrument.
<b>LAYER ON/OFF</b>	Same as the [LAYER] button.
<b>LEFT ON/OFF</b>	Same as the [LEFT] button.
<b>OTS+</b>	Calls up the next One Touch Setting.
<b>OTS-</b>	Calls up the previous One Touch Setting.

\* For best results, use the optional Yamaha FC7 Foot Controller.

The parameters below correspond to buttons [2▲▼] - [8▲▼], and their availability depends on the selected control Type. For example, if SUSTAIN is selected as the Type, the parameters "HALF PEDAL POINT", "MAIN", "LAYER" and "LEFT" automatically appear in the display.

<b>SONG, STYLE, MIC, LEFT, LAYER, MAIN</b>	These specify the part(s) that will be affected by the pedal.
<b>HALF PEDAL POINT*</b>	You can specify how far down you should press on the right pedal until the damper effect (page 59) starts working. This can be set for certain kinds of pedals, such as the AUX pedal (YAMAHA FC7) or the CVP-209/207's damper pedal.
<b>DEPTH</b>	Determines the depth of the left pedal effect, when SOFT is selected. This only works for the Natural voices.
<b>UP/DOWN</b>	When GLIDE or PITCH BEND is selected, this determines whether the pitch change goes up (is raised) or down (is lowered).
<b>RANGE</b>	When GLIDE or PITCH BEND is selected, this determines the range of the pitch change, in semitones.
<b>ON SPEED</b>	When GLIDE is selected, this determines the speed of the pitch change, when the pedal is pressed.
<b>OFF SPEED</b>	When GLIDE is selected, this determines the speed of the pitch change, when the pedal is released.
<b>KIT</b>	When PERCUSSION is assigned to the pedal, all available drum kits are shown here, letting you select the particular drum kit used for the pedal.
<b>PERCUSSION</b>	When PERCUSSION is assigned to the pedal, all sounds of the selected drum kit (in KIT above) are shown here. This determines the particular instrument sound assigned to the pedal.

\* For best results, use the optional Yamaha FC7 Foot Controller.

# Changing the Touch Sensitivity and Transpose — Keyboard/Panel

## Keyboard Touch

The Touch feature lets you control the volume of the voices by your playing strength. These settings allow you to customize the keyboard's touch response (sensitivity) to your personal playing preferences.

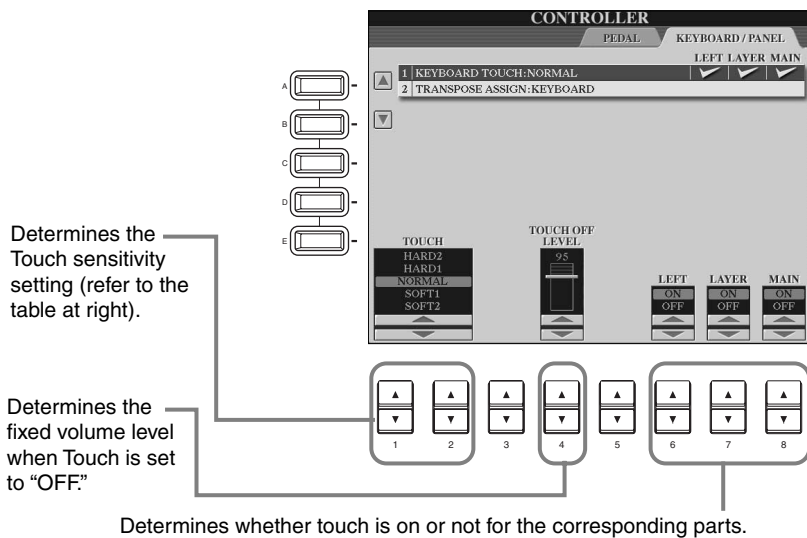

<b>HARD 2</b>	Requires strong playing to produce high volume. Best for players with a heavy touch.
<b>HARD 1</b>	Requires moderately strong playing for higher volume.
<b>NORMAL</b>	Standard touch response.
<b>SOFT 1</b>	Produces high volume with moderate playing strength.
<b>SOFT 2</b>	Produces relatively high volume even with light playing strength. Best for players with a light touch.

**NOTE**  
The TOUCH setting affects all voices globally. Keep in mind that you can set each voice to a different touch sensitivity (TOUCH SENSE). For example, to play a pipe organ voice most authentically, you can set this so that the voice is not affected by touch (page 90).

## Transpose Assign

This determines which aspect of the instrument is affected by the [TRANPOSE] button.

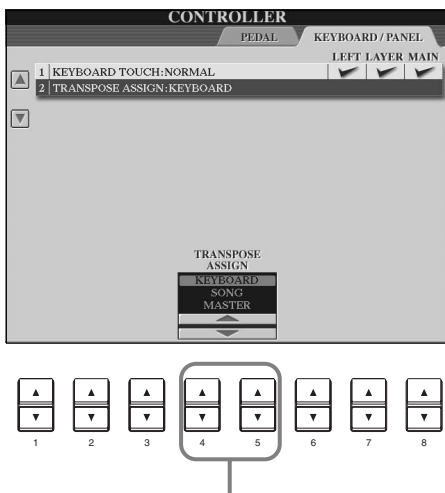

### KEYBOARD

For this setting, Transpose affects the pitch of the keyboard-played voices (Main, Layer, and Left) and the accompaniment styles.

### SONG

For this setting, Transpose affects only the pitch of the songs.

### MASTER

For this setting, Transpose affects the pitch of the entire instrument (keyboard voices, accompaniment styles, and songs).

### Transpose

Allows you to shift the pitch of the keyboard-played voices, accompaniment style playback, and song data in semitone units.

**1** Press one of the [TRANPOSE] buttons.

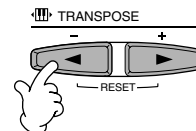

**2** A TRANPOSE pop-up window, selected via TRANSPOSE ASSIGN, appears.



**3** Adjust the value by using the [TRANPOSE] buttons.



Close the TRANPOSE windows by pressing the [EXIT] button.

### • Selectively Transposing Keyboard/Song

These settings can be used to match both the song and your keyboard performance to a certain key. For example, let's say you wish to play and sing along with a certain recorded song. The song data is in F, but you feel most comfortable singing in D, and you are accustomed to playing the keyboard part in C. To match up the keys, keep the Master Transpose setting at "0," set the Keyboard Transpose to "2," and set Song Transpose to "-3." This brings the keyboard part up in pitch and the song data down to your comfortable singing key.

### NOTE

The transpose function does not affect the Drum Kit or SFX Kit voices.

# Setting the Registration Sequence, Freeze, and Voice Set

The explanations here apply to step #3 of the procedure on page 133.

## Specifying the Order for Calling Up Registration Memory Presets — Registration Sequence

You can save your custom panel settings to the Registration Memory presets, and call them up by pressing the appropriate REGISTRATION MEMORY buttons [1] - [8]. The convenient Registration Sequence function lets you call up the presets in any order you specify, by simply using the [BACK]/[NEXT] buttons or the pedal as you play.

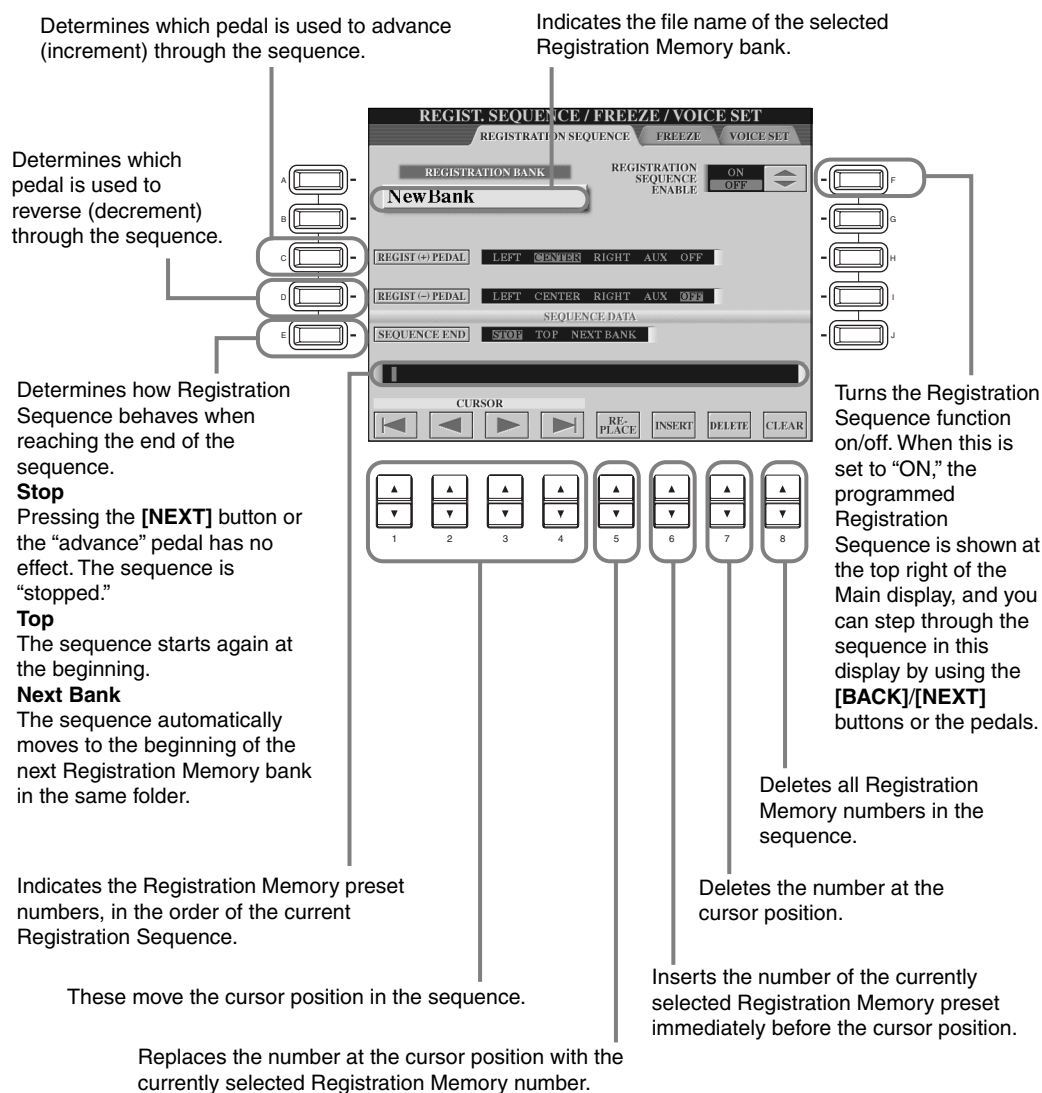

**NOTE**  
 Setting Registration Sequence Enable to "ON" overrides any other Pedal settings (for pedals assigned to "Regist (+) Pedal" and "Regist (-) Pedal" here). These include the pedal settings on page 139, and in Voice Set on page 143.

**NOTE**  
 When both "Regist (+) Pedal" and "Regist (-) Pedal" are set to "OFF," the pedals cannot be used to step through the Registration Sequence; only the [BACK]/[NEXT] buttons can be used in the MAIN display.

**NOTE**  
 When both "Regist (+) Pedal" and "Regist (-) Pedal" are set to the same pedal, "Regist (+) Pedal" takes priority.

**NOTE**  
 Registration Sequence data is included as part of the Registration Memory bank file. To save your newly programmed Registration Sequence, store the current Registration Memory bank file (page 39, 45). Any Registration Sequence data is lost when changing Registration Memory banks, unless you've stored it with the Registration Memory bank file.

**END** Execute the settings by pressing the [EXIT] button.

## Maintaining Panel Settings — Freeze

This lets you specify the settings you want to be maintained or left unchanged, even when changing Registration Memory presets. For details, see page 87.

## Changing the Automatically Selected Voice Settings — Voice Set

When changing voices (selecting a voice file), the settings best matching the voice — the same as those set in the Sound Creator — are always and automatically called up. From this page, you can set the on/off status for each part. For example, each of the preset voices has its own LEFT PEDAL setting; however, even changing voices will not change the LEFT PEDAL setting, if it is set to “OFF” in this page.

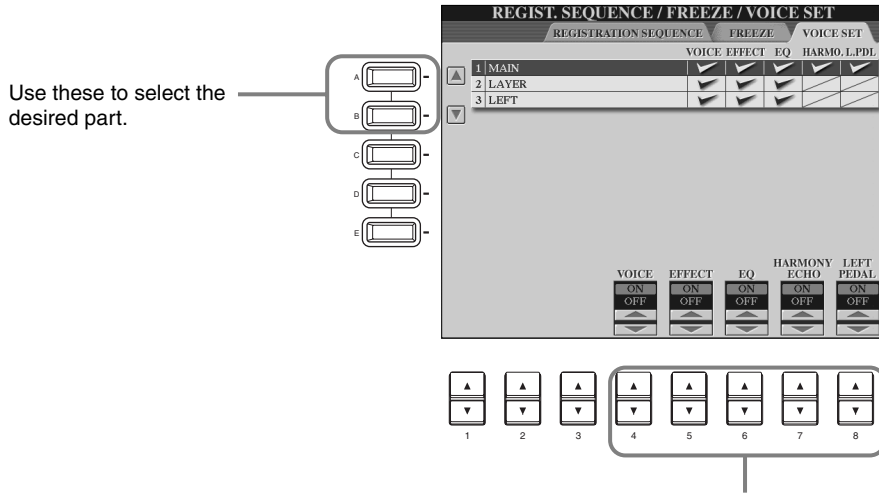

Use these to select the desired part.

**NOTE**  
Normally, these should all be set to “ON.”

**NOTE**  
Harmony/echo and Left pedal assignment cannot be set for the Layer and Left parts.

These determine whether the corresponding voice-related settings (Voice selection, Effects, EQ, Harmony/echo, and left pedal assignment) are automatically called up or not when you select a voice. These settings can be turned on or off independently for each part.

## Setting Harmony and Echo

The explanations here apply to step #3 of the procedure on page 133.

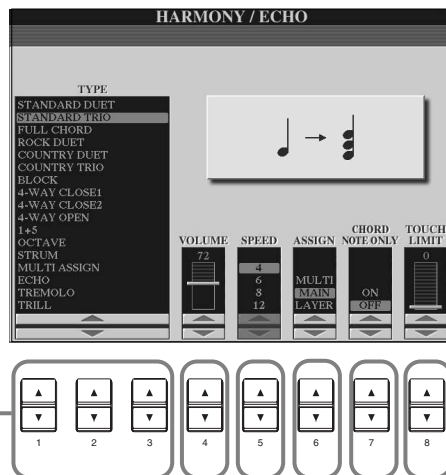

Determines the Harmony type. For details, see page 144.

Determines the level of the Harmony effect.

Determines the speed of the Echo, Tremolo, and Trill effects. This parameter is only available when Echo, Tremolo, or Trill is selected in Type above.

Determines the lowest velocity value at which the harmony note will sound. This allows you to selectively apply the harmony by your playing strength, letting you create harmony accents in the melody. The harmony effect is applied when you play the key strongly (above the set value).

When this is set to “ON,” the Harmony effect is applied only to the note that belongs to a chord played in the Auto Accompaniment section of the keyboard. This parameter is not available when Multi Assign, Echo, Tremolo, or Trill is selected in Type above.

This lets you assign the Harmony effect to various parts. For details, see page 144.

## About the Harmony Types

### When a normal Harmony type (“Standard Duet” through “Strum”) is selected

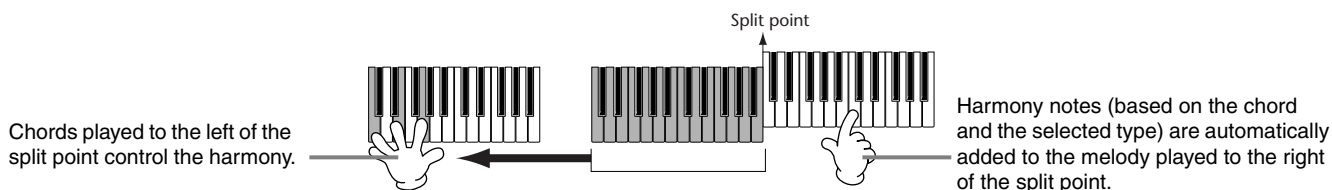

### When “Multi Assign” is selected

Multi Assign automatically assigns notes played simultaneously on the right-hand section of the keyboard to separate parts (voices). For example, if you play two consecutive notes, the first is played by the Main voice and the second by the Layer voice.

### When “Echo” is selected

An echo effect is applied to the note played on the keyboard, in time with the currently set tempo.

### When “Tremolo” is selected

A tremolo effect is applied to the note played on the keyboard, in time with the currently set tempo.

### When “Trill” is selected

Two notes held on the keyboard are played alternately, in time with the currently set tempo.

## About the Harmony Assignments

### Multi

This automatically assigns the 1st, 2nd, 3rd, and 4th added harmony notes to different parts (voices). For example, if the Main and Layer parts are turned on and the “Standard Duet” type is selected, the note you play on the keyboard will be played by the Main voice, and the added harmony note will be played by the Layer voice.

### Main

Harmony is applied only to the Main part.

### Layer

Harmony is applied only to the Layer part. When the Layer part is turned off, Harmony is not applied.

## Showing the Clavinova Display on a TV — Video Out

The explanations here apply to step #3 of the procedure on page 133.

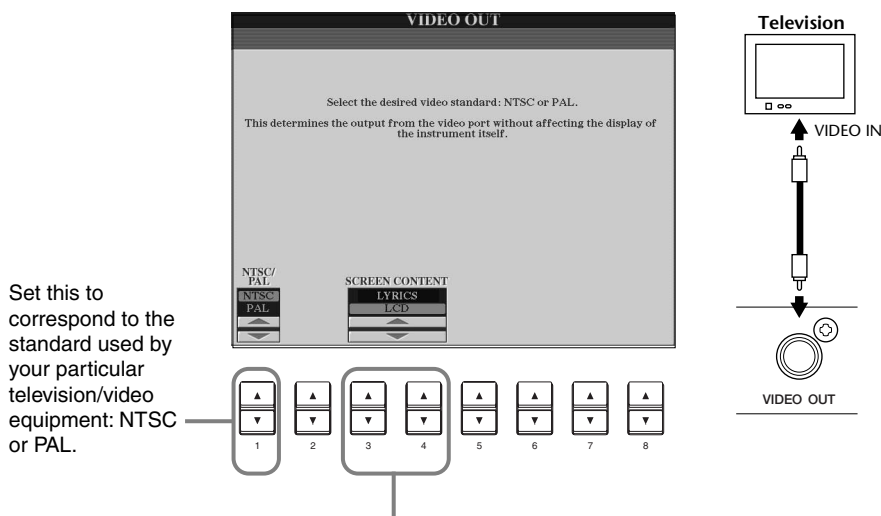

Determines the contents of the Video Out signal, or which data is sent to the video monitor.

**Lyrics**.....Only the lyrics of the song are output via VIDEO OUT, regardless of the display that is called up on the instrument itself. This lets you select other displays and still have the lyrics shown on the monitor.

**LCD**.....The currently selected display is output via VIDEO OUT.

### NOTE

- Occasionally some flashing parallel lines may appear in the television or video monitor. This does not necessarily indicate that the monitor is malfunctioning. You may be able to remedy the situation by changing the Character Color or Background Color parameters. For optimum results, also try adjusting the color settings on the monitor itself.
- Avoid looking at the television or video monitor for prolonged periods of time since doing so could damage your eyesight. Take frequent breaks and focus your eyes on distant objects to avoid eyestrain.
- Keep in mind that even after adjusting all settings as recommended here, the monitor you are using may not show the Clavinova’s display contents as expected (e.g., the display contents may not fit on the screen, the characters may not be completely clear, or the colors may be incorrect).



## Setting the MIDI Parameters

In this section, you can make MIDI-related settings for the instrument. These settings can be stored all together from the USER display, for future recall.

For general information and details about MIDI, see “What is MIDI?” (page 156).

The explanations here apply to step #3 of the procedure on page 133.

### 1 Select the desired template.



**3** Call up the User display and press this button to save the newly edited MIDI settings. Up to ten setups can be saved.

**2** Call up the Edit display, then select and set the desired functions/parameters. For details about each of the MIDI edit displays, see the following pages.



Press the [EXIT] button to return to the previous display.

### Preset MIDI Templates (Factory Set)

<b>All Parts</b>	Transmit all parts including Main, Layer and Left.
<b>Master KBD</b>	The Clavinova functions as a master keyboard for controlling external tone generators or other devices.
<b>KBD &amp; Style</b>	Transmit Upper and Lower keyboard play instead of the individual parts (Main/Layer/Left).
<b>Song</b>	All Transmit channels are set to correspond to the Song channels 1-16. Use this to play the Clavinova song data with an external tone generator, or to record your entire performance to an external sequencer.
<b>Clock Ext.</b>	MIDI IN terminal receives MIDI clock and Clavinova synchronizes with an external MIDI device.
<b>MIDI Accord 1</b>	An ideal setup for controlling the keyboard voice and accompaniment style with a MIDI accordion.
<b>MIDI Accord 2</b>	Chord and bass buttons on a MIDI accordion control the accompaniment style, as well as play the chord and bass parts.
<b>MIDI Pedal 1</b>	The MIDI pedal connected to MIDI IN terminal controls the bass note of the accompaniment.
<b>MIDI Pedal 2</b>	The MIDI pedal connected to MIDI IN terminal plays the bass part.
<b>MIDI OFF</b>	MIDI signals are neither sent nor received.

#### NOTE

The saved settings can be named (page 42) or deleted (page 44) in the User page.

## Making Overall System Settings (Local Control, Clock, etc.) — System

Call up the display as described in step 2 above.

For editing the Clock, Transmit Clock, Receive Transpose, and Start/Stop parameters.

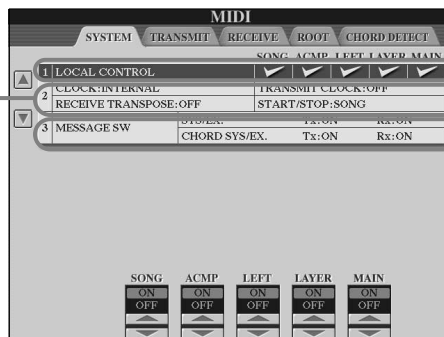

For editing the Local Control parameters.

For editing the Message Switch parameters.

### Local Control

Turns the Local Control for each part on or off. When Local Control is set to “ON,” the keyboard of the CVP-209/207 controls its own (local) internal tone generator, allowing the internal voices to be played directly from the keyboard. If you set Local to “OFF,” the keyboard and controllers are internally disconnected from the CVP-209/207’s tone generator section so that no sound is output when you play the keyboard or use the controllers. For example, this allows you to use an external MIDI sequencer to play the CVP-209/207’s internal voices, and use the CVP-209/207 keyboard to record notes to the external sequencer and/or play an external tone generator.

## Clock, Transmit Clock, Receive Transpose, Start/Stop

### ■ Clock

Determines whether the CVP-209/207 is controlled by its own internal clock or a MIDI clock signal received from an external device. “INTERNAL” is the normal Clock setting when the CVP-209/207 is being used alone. If you are using the CVP-209/207 with an external sequencer, MIDI computer, or other MIDI device, and you want the CVP-209/207 to be synchronized to the external device, set this function to “EXTERNAL.” In the latter case, the external device must be connected to the CVP-209/207 MIDI IN terminal, and must be transmitting an appropriate MIDI clock signal.

### ■ Transmit Clock

Turns MIDI clock transmission on or off. When this is set to “OFF,” no MIDI clock or START/STOP data is transmitted.

### ■ Receive Transpose

When this parameter is set to “OFF,” note data received by the CVP-209/207 is not transposed, and when it is set to “ON,” the received note data is transposed according to the current CVP-209/207 keyboard transpose (page 141) setting.

### ■ Start/Stop

Determines whether incoming FA (start) and FC (stop) messages affect song or style playback.

#### NOTE

##### FA, FC

MIDI messages for starting/stopping the song or style. The “FA” message corresponds to start, and “FC” corresponds to stop.

## Message Switch

- SYS/EX. Tx (TRANSMIT)**..... Turns MIDI transmission of MIDI system exclusive message data ON or OFF.
- SYS/EX. Rx (RECEIVE)** ..... Turns MIDI reception of MIDI exclusive data generated by external equipment ON or OFF.
- CHORD SYS/EX. Tx (TRANSMIT)** ..... Turns MIDI transmission of MIDI chord exclusive data (chord detect — root and type) ON or OFF.
- CHORD SYS/EX. Rx (RECEIVE)**..... Turns MIDI reception of MIDI chord exclusive data generated by external equipment ON or OFF.

## Transmitting MIDI Data — Transmit

This determines which parts will send MIDI data and over which MIDI channel the data will be sent.

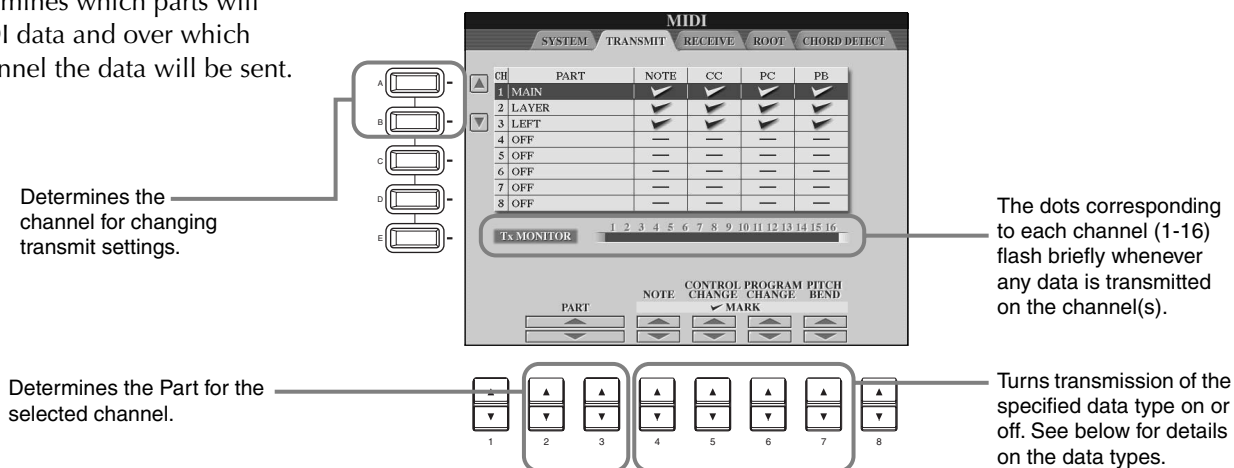

### Data Types in the MIDI TRANSMIT/RECEIVE Display

<b>Note</b>	Messages which are generated when the keyboard is played. Each message includes a specific note number which corresponds to the key which is pressed, plus a velocity value based on how hard the key is played.
<b>Control Change (CC)</b>	Control change data includes pedal and any other controller data.
<b>Program Change (PC)</b>	Program change data corresponds to voice or “patch” numbers.
<b>Pitch Bend (PB)</b>	See page 140.
<b>After Touch (AT)*</b>	With this function, the Clavinova senses how much pressure you apply to the keys while playing, and uses that pressure to affect the sound in various ways, depending on the selected voice. This allows you to play with greater expressiveness and add effects with your playing technique.

\* Available in RECEIVE display only (page 147).

## Receiving MIDI Data — Receive

This determines which parts will receive MIDI data and over which MIDI channel the data will be received.

Determines the channel for changing receive settings.

The dots corresponding to each channel (1 - 32) flash briefly whenever any data is received on the channel(s).

Determines the Part for the selected channel. See below for details about the receive parts.

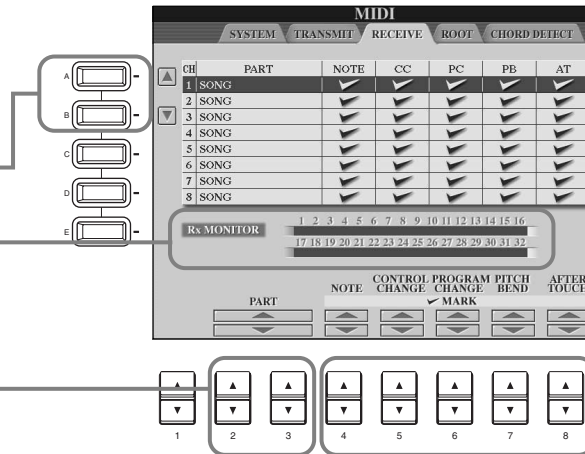

**NOTE**

The MIDI IN/OUT terminals and Port A of the TO HOST terminal (Port A of the CBX driver) correspond to channels 1 - 16. Port B of the TO HOST terminal (Port B of the CBX driver) corresponds to channels 17 - 32.

Turns reception of the specified data type on or off. See page 146 for details on the data types.

### MIDI Receive Parts

<b>OFF</b>	No MIDI data is received.
<b>SONG</b>	Normally, the part receiving the MIDI data corresponds to the part/voice used in playing back the song data. Channels 1 - 16 correspond to song channels 1 - 16, respectively.
<b>MAIN</b>	The MAIN part is controlled by the MIDI data received on the corresponding channel.
<b>LAYER</b>	The LAYER part is controlled by the MIDI data received on the corresponding channel.
<b>LEFT</b>	The LEFT part is controlled by the MIDI data received on the corresponding channel.
<b>KEYBOARD</b>	MIDI note data received by the Clavinova plays the corresponding notes in the same way as if they are played on the keyboard.
<b>ACMP RHYTHM1-2</b>	The received notes are used as the accompaniment RHYTHM 1 and RHYTHM 2 notes.
<b>ACMP BASS</b>	The received notes are used as the accompaniment BASS notes.
<b>ACMP CHORD1-2</b>	The received notes are used as the accompaniment CHORD 1 and CHORD 2 notes.
<b>ACMP PAD</b>	The received notes are used as the accompaniment PAD notes.
<b>ACMP PHRASE1-2</b>	The received notes are used as the accompaniment PHRASE 1 and PHRASE 2 notes.
<b>EXTRA PART1-5</b>	There are five parts specially reserved for receiving and playing MIDI data. Normally, these parts are not used by the instrument itself. When these five channels are enabled, you can use the instrument as a 32-channel multi-timbral tone generator.

## Setting Root Note Channels — Root

The note ON/OFF messages received at the channel(s) set to "ON" are recognized as the root notes in the accompaniment section. The root notes will be detected regardless of the accompaniment ON/OFF and split point settings.

Selects the channels in groups of eight: 1 - 8, 9 - 16, 17 - 24, and 25 - 32, respectively.

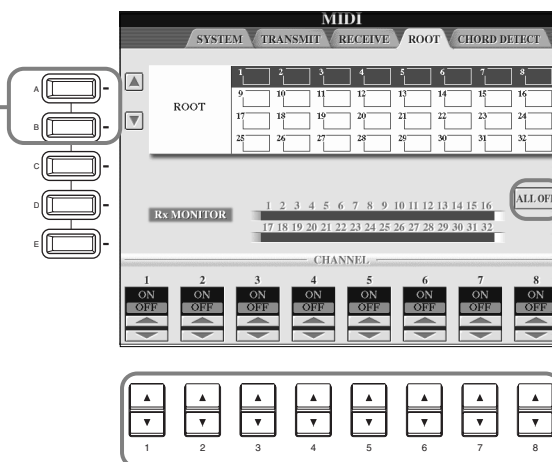

**NOTE**

The MIDI IN/OUT terminals and Port A of the TO HOST terminal (Port A of the CBX driver) correspond to channels 1 - 16. Port B of the TO HOST terminal (Port B of the CBX driver) corresponds to channels 17 - 32.

**NOTE**

When several channels are simultaneously set to "ON," the root note is detected from merged MIDI data received over the channels.

Sets the desired channel to ON or OFF.

Sets all channels to OFF.

## Setting Chord Channels — Chord Detect

The note ON/OFF messages received at the channel(s) set to "ON" are recognized as the chord notes in the accompaniment section. The chords to be detected depend on the fingering type. The root notes will be detected regardless of the accompaniment ON/OFF and split point settings. The operation procedure is basically the same as that of the ROOT display above.

# Other Settings — Utility

The explanations here apply to step #3 of the procedure on page 133.

## Making Settings for Fade In/Out, Metronome, Parameter Lock, and Tap — CONFIG 1

### Fade In Time, Fade Out Time, Fade Out Hold Time

These determine how long it takes for the accompaniment style and song to fade in or fade out.

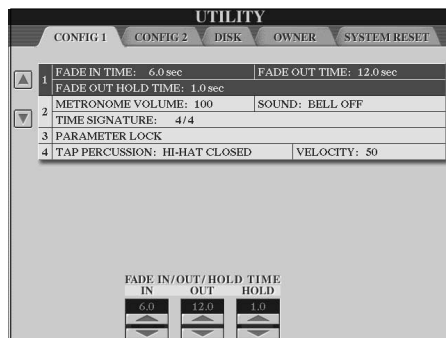

Determines the time it takes for the volume to fade in, or go from minimum to maximum (range of 0 - 20.0 seconds).

Determines the time it takes for the volume to fade out, or go from maximum to minimum (range of 0 - 20.0 seconds).

Determines the time the volume is held at 0 following the fade out (range of 0 - 5.0 seconds).

### Metronome

These let you make settings for the metronome-related parameters.

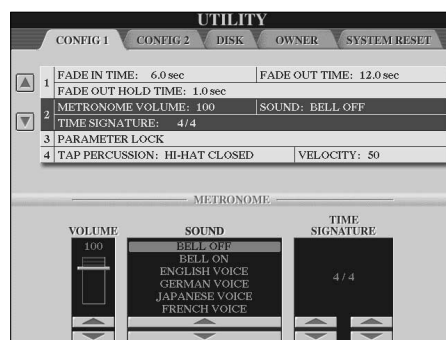

Determines the level of the metronome sound.

- Determines which sound is used for the metronome.
- Bell Off** ..... Conventional metronome sound, with no bell.
- Bell On** ..... Conventional metronome sound, with bell.
- English Voice** ..... Count in English (One, Two, Three, Four)
- German Voice** ..... Count in German (Eins, Zwei, Drei, Vier)
- Japanese Voice** ..... Count in Japanese (Ichi, Ni, San, Shi)
- French Voice** ..... Count in French (Un, Deux, Trois, Quatre)
- Spanish Voice** ..... Count in Spanish (Uno, Dos, Tres, Cuatro)

Determines the time signature of the metronome sound. When you start the song or accompaniment style, the values matching to them are automatically set.

## Parameter Lock

This function is used to “lock” the specified parameters so that they can only be changed directly via the panel controls — in other words, instead of via Registration Memory, One Touch Setting, Music Finder, or song and sequence data.

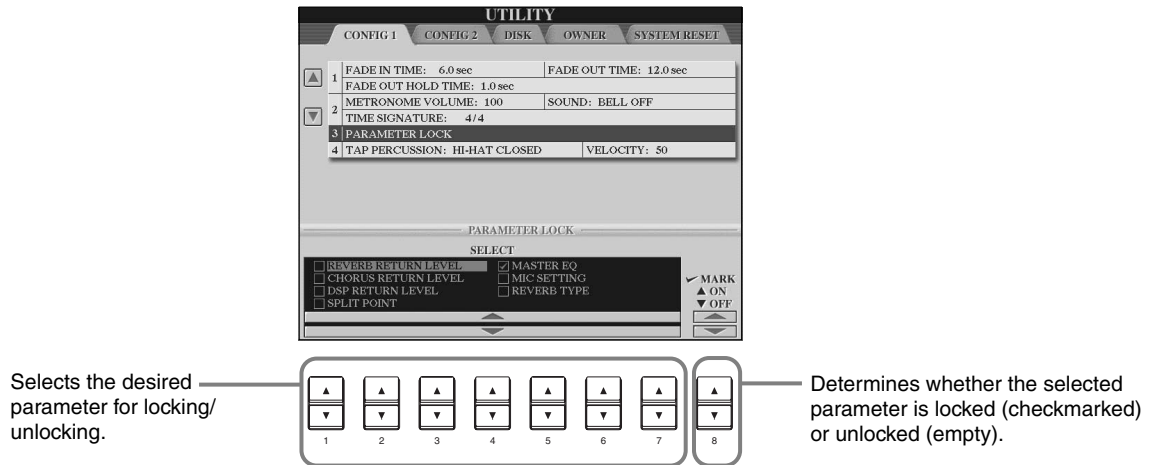

## Tap Count

This lets you change settings of the tap sound, used for the Tap Start function (page 52).

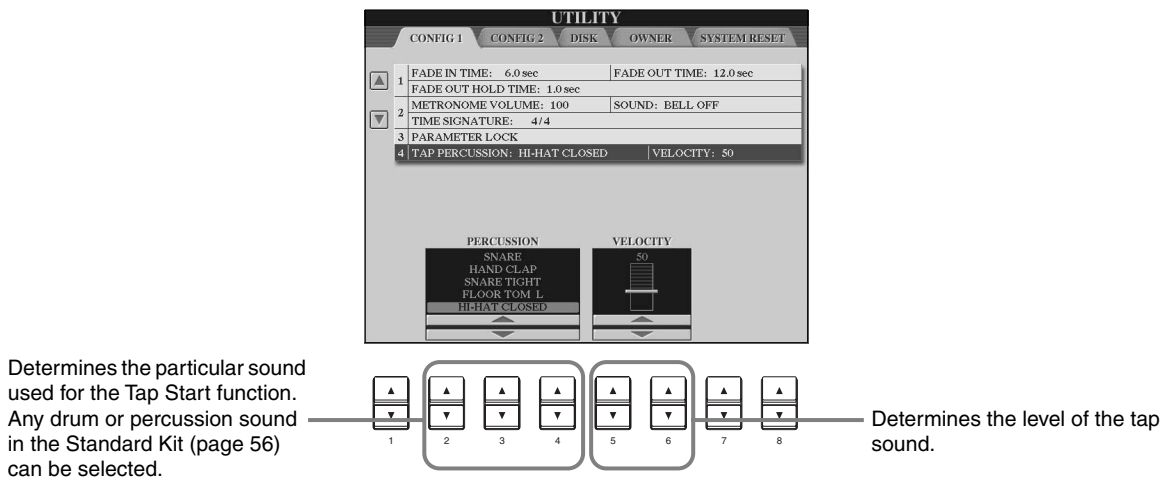

## Making Settings for the Display, Speaker System, and Voice Number Indication — CONFIG 2

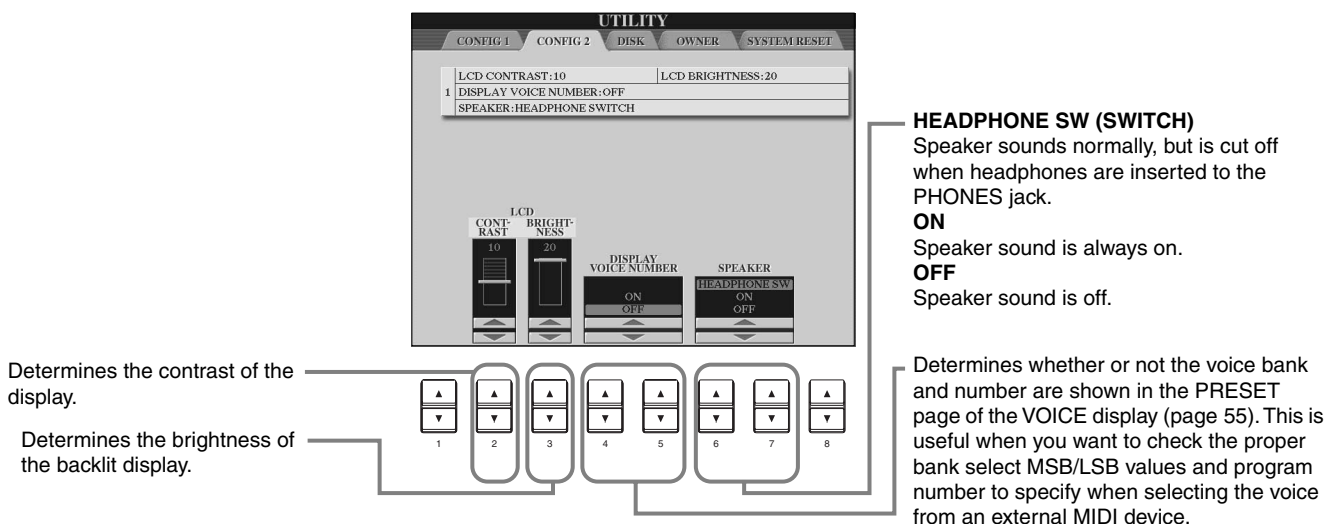

## Copying and Formatting Disks — Disk

Turns the Song Auto Open function on or off. When this is set to "ON," the Clavinova automatically calls up the first disk song when a disk is inserted.

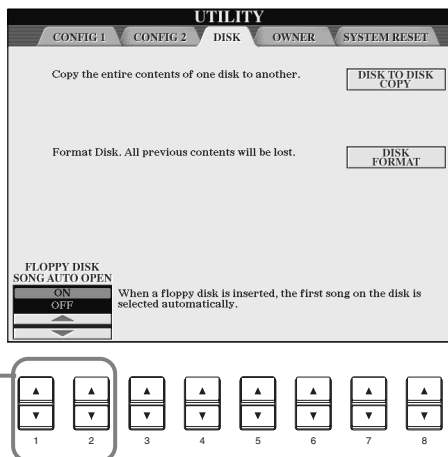

This function copies all the data from one disk to another, letting you back up all your important data before editing. For instructions, see "Copying from Disk to Disk" below.

This function formats a floppy disk (see below).

### NOTE

- Copying cannot be done between a 2DD disk and 2HD disk. When copying, make sure both disks are the same type.
- Depending on the amount of data contained in the original source disk, you may have to swap the two disks several times until all of the data is properly copied.
- Make sure to read the section "Using the Floppy Disk Drive (FDD) and Floppy Disks" on page 6.

### Copying from Disk to Disk

As shown below, first copy the data of the original (source) disk to the CVP-209/207, then copy the data to the backup (destination) disk.

**1** Press the [F] button. A message appears, prompting you to insert the source disk.

**2** Insert the disk containing the original data into the drive and press "OK." A "Now copying" message appears, and the CVP-209/207 begins copying data to internal memory. To abort the operation, press "CANCEL."

**3** At the "Please insert a destination disk and press the OK button" prompt, eject the source disk and replace it with a blank, formatted disk, then press "OK." To abort the operation, press "CANCEL."

**4** When the operation is finished (or when prompted), eject the destination disk.

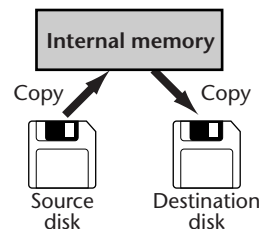

### NOTE

Commercially available music data is subject to protection by copyright laws. Copying commercially available data is strictly prohibited, except for your own personal use. Some music software is purposely copy-protected and cannot be copied.

### Formatting a Disk

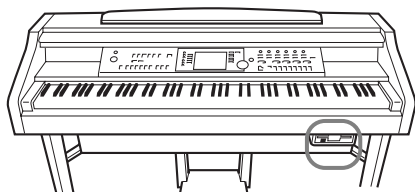

When using an unformatted disk for the first time, make sure to properly format it on the CVP-209/207. This includes blank disks as well as disks already initialized in a different format. Formatting erases all data on the disk.

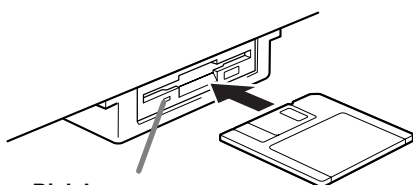

#### Disk Lamp

When the power is turned on, the disk lamp (at the bottom left of the drive) lights to indicate the drive can be used.

Insert the disk with shutter facing away from you and the label side up. To start the Format operation, press the [H] (DISK FORMAT) button, in the DISK page above.

### NOTE

The Format operation initializes a disk with a specific file system, allowing the corresponding device (in this case, the CVP-209/207) to access it properly. Since there are several types of formats and disks available, you should know which ones to use with the CVP-209/207. 2DD disks are formatted to a capacity of 720 KB, and 2HD disks are formatted to a capacity of 1.44 MB.

### CAUTION

Formatting a disk completely erases all data on the disk. Make sure that the disk you're formatting does not contain important data!

## Entering Your Name and Language Preference — Owner

Determines the language used for the display messages. Once you change this setting, all messages will be shown in the selected language.

Press this button to enter an Owner name (page 17; for instructions on naming see page 46). This name is automatically shown when you turn the power on.

Calls up the MAIN PICTURE display, from which you can select the background of the MAIN display.

**NOTE**

When selecting background data from a floppy disk:

- Only bitmap files (.BMP) can be used for the background of the MAIN display. Make sure to use images no larger than 640 x 480 pixels. Smaller images are automatically copied and tiled in the display.
- The selected background will not be displayed when the power is turned on again unless the same disk containing the data has been inserted into the drive.
- The background may take some time to appear. If you want to reduce this time, save the background to the USER page of the MAIN PICTURE display.

**NOTE**

When “JAPANESE” is selected for the Language parameter, and you change this to one of the western languages, the kanji and kana characters of the file name stored in the disk drive are changed to western characters (page 41).

## Restoring the Factory-programmed Settings of the CVP-209/207 — System Reset

This operation lets you restore the CVP-209/207 to its original factory settings. These settings include System Setup, MIDI Setup, User Effect, Music Finder, and Files & Folders.

Restores the System Setup parameters to the original factory settings. You can also restore only the System Setup settings by simultaneously holding down the highest key on the keyboard (C7) and turning on the power.

Restores the MIDI templates to the original factory settings.

Restores the User Effects (page 124) to the original factory settings.

Restores the Music Finder data to the original factory settings.

Deletes all files and folders stored in the User page.

Executes the Factory Reset operation for all items checked above.

These call up the corresponding Open/Save displays. These let you store the corresponding data as files to disk, for future recall. Pressing each of these buttons calls up the corresponding Open/Save display, from which you can select the corresponding PRESET page. From this PRESET page, you can save the relevant data.

**NOTE**

The functions and settings below do not apply to the Factory Reset operation. However, you can restore these to their original settings by calling up the preset System Setup files, using the Open/Save System Files function.  
 Language  
 Owner Name  
 LDC Contrast  
 LCD Brightness  
 Video Out settings (NTSC/PAL)  
 Screen Content

**NOTE**

All Music Finder records can be stored together as a single file. When calling up a stored file, a message appears prompting you to replace or append the records as desired.

**Replace:**  
 All Music Finder records currently in the instrument are deleted and replaced with the records of the selected file.

**Append:**  
 The records called up are added to the vacant record numbers.

# Using Your Clavinova with Other Devices

## ⚠ CAUTION

Before connecting the Clavinova to other electronic components, turn off the power to all the components. Before turning the power on or off to all components, set all volume levels to minimum (0). Otherwise, electrical shock or damage to the components may occur.

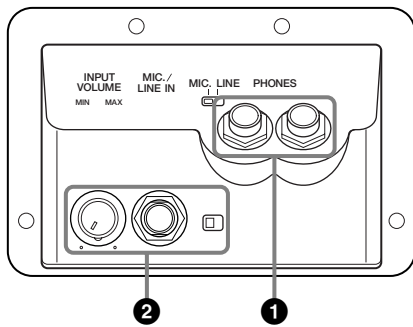

## 1 Using the Headphones (PHONES jacks).

To use headphones, connect them to one of the PHONES jacks (standard 1/4" phone jacks) located on the underside of the keyboard. You can also determine whether or not the internal stereo speaker system is shut off when a pair of headphones is plugged into the PHONES jack (page 149). Two people can enjoy listening to the Clavinova together by connecting two pairs of headphones to the two jacks.

## 2 Connecting the Microphone or Guitar (MIC./LINE IN jack).

By connecting a microphone to the Clavinova, you can enjoy singing along with your own performance or song playback. (A dynamic microphone is recommended.) The Clavinova outputs your vocals or guitar sounds through the built-in speakers.

- 1 Connect your microphone to the MIC./LINE IN jack (standard 1/4" phone jack).

### NOTE

Use an unidirectional microphone for best results.

- 2 Set the [MIC. LINE] switch (located next to the [MIC./LINE IN] jack) to the MIC. position.

MIC. LINE



When connecting a microphone

MIC. LINE



When connecting a guitar

### NOTE

You should set the [MIC. LINE] switch to the LINE position when connecting an audio source with line-level output to the MIC./LINE IN jack.

- 3 Use the [INPUT VOLUME] knob (located next to the MIC./LINE IN jack) to set the microphone volume.

The volume should be set high enough that the SIGNAL lamp on the front panel lights steadily when you sing, but not so high that the OVER lamp lights (page 128).

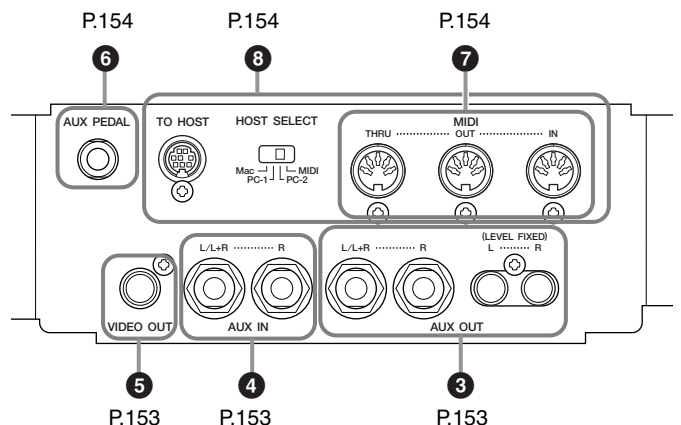
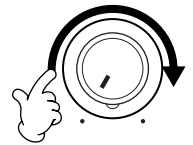



### 3 4 5 Connecting Audio & Video Devices

You can connect the Clavinova to a wide range of audio equipment by using the AUX IN and AUX OUT jacks, which are located at the bottom left of the instrument. Connect as shown in the illustrations below using standard audio cables.

**NOTE**

Use audio cables and adaptor plugs with no resistance.

**CAUTION**

When the Clavinova AUX OUT jacks are connected to an external audio system, first turn on the power to the Clavinova, then to the external audio system. Reverse this order when you turn the power off.

### 3 Playing the sounds of the Clavinova through an external audio system, and recording the sounds to an external recorder (AUX OUT jacks)

**CAUTION**

Never connect the Clavinova AUX OUT jacks to its AUX IN jacks, either directly or via external audio equipment. Such connections could result in a feedback loop that will make normal performance impossible, and may even damage the Clavinova.

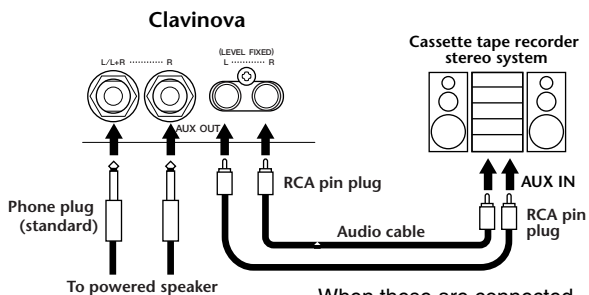

When these are connected (with standard phone plugs), you can use the [MASTER VOLUME] control to adjust the volume of the sound output to the external device.

When these are connected (with RCA pin plug; LEVEL FIXED), the sound is output to the external device at a fixed level, regardless of the [MASTER VOLUME] control setting.

**NOTE**

- If you connect the Clavinova to a monaural device, use only the AUX OUT L/L+R jack.

### 4 Outputting the sound of an external device through the built-in speakers of the Clavinova (AUX IN jacks)

**CAUTION**

When the Clavinova's AUX IN jacks are connected to an external device, first turn on the power of the external device, then that of the Clavinova.

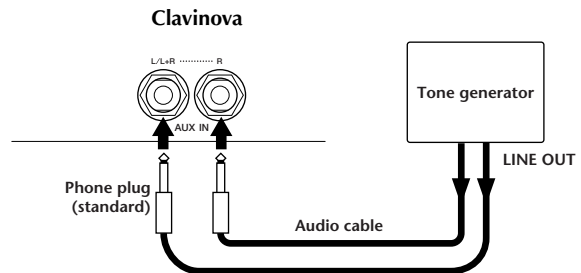

**NOTE**

- The Clavinova's [MASTER VOLUME] setting affects the input signal from the AUX IN jacks.
- If you connect the Clavinova to a monaural device, use only the AUX IN L/L+R jack.

### 5 Showing the display of the Clavinova on a connected TV monitor (VIDEO OUT)

You can connect the Clavinova to a television or video monitor to display the lyrics in your song data or LCD on a larger screen.

The particular contents of the display can also be set (page 144).

**NOTE**

- For information on setting the video standard (NTSC or PAL), refer to page 144. The default setting is "PAL."
- Use an audio-video cable with good high-frequency characteristics and RCA-type pin jacks to connect the Clavinova to a television or video monitor.

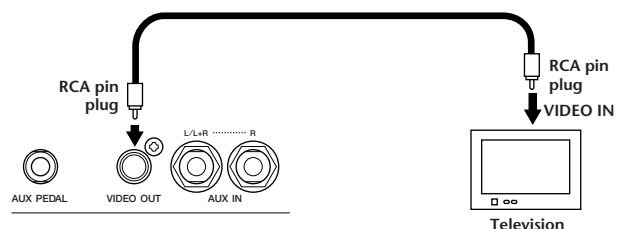

## 6 Using the Pedal (footswitch) or Foot Controller (AUX PEDAL jack)

By connecting an optional Foot Controller (such as the FC7) to the AUX PEDAL jack, you can control any one of a variety of important functions with your foot — such as dynamically adjusting the volume as you play (page 139).

By connecting a Foot Switch (the FC4 or FC5) to this jack, you can replicate the function of some panel buttons, doing things like starting and stopping accompaniment.

### CAUTION

Make sure to connect or disconnect the pedal only when the power is turned off.

## 7 Connecting external MIDI devices (MIDI terminals)

Using a standard MIDI cable, connect the external MIDI device to the MIDI terminal(s) of the Clavinova. Make sure to set the HOST SELECT switch (page 18) to MIDI when you use these connectors. For more information about connections, see “What You Can Do With MIDI” on page 158.

**MIDI IN** ..... Receives MIDI messages from an external MIDI device

**MIDI OUT** ..... Sends out MIDI messages generated by the Clavinova

**MIDI THRU** ..... Simply relays the MIDI messages received at MIDI IN

For a general overview of MIDI and how you can effectively use it, refer to the following sections:

- What’s MIDI? (page 156)
- What You Can Do With MIDI (page 158)
- MIDI functions (page 145)

### NOTE

- Never use MIDI cables longer than 15 meters.

## 8 Connecting to a Computer (MIDI terminals/TO HOST terminal)

Connect your CVP-209/207 to computer and take advantage of the wide range of powerful and versatile software for creating and editing music. The CVP-209/207 can be connected in three ways.

- Using the TO HOST terminal
- Using the MIDI terminals
- Connecting to a USB terminal by using an optional USB interface (UX series)

### NOTE

- You’ll need an appropriate music/MIDI software program (such as a sequencer), compatible with your computer platform.
- When connecting the Clavinova to a personal computer, first turn off the power to both the Clavinova and the computer before connecting any cables and setting the HOST SELECT switch. After making the proper connections and settings, turn on the power of the computer first, then that of the Clavinova.
- If you do not use the TO HOST terminal of the Clavinova, make sure you disconnect the cable from the terminal. If the cable is left connected, the Clavinova may not function properly.
- When the HOST SELECT switch is set to “PC-1,” “PC-2,” or “Mac,” you can use the TO HOST terminal, but the MIDI connectors are disabled since no data transfer occurs via the MIDI connectors. On the other hand, when the HOST SELECT switch is set to “MIDI,” you can use the MIDI connectors, but not the TO HOST terminal since no data is transferred via the TO HOST terminal.

### Note for Windows users (regarding MIDI driver)

To transfer data via the computer’s serial port and the Clavinova’s TO HOST terminal, you need to install a specified MIDI driver (Yamaha CBX driver for Windows). You can download this driver from the XG Library on the Yamaha Web site:  
<http://www.yamaha-xg.com>

## Using the TO HOST terminal

Connect the serial port of the personal computer (RS-232C terminal or RS-422 terminal) to the TO HOST terminal of the CVP-209/207. For the connection cable, use the appropriate cable below (sold separately) that matches the personal computer type.

### NOTE

If your system does not work properly with the connections and settings listed above, your software may require different settings. Check your software operation manual and set the HOST SELECT switch to the proper data transfer rate. (Data transfer rate of "PC-1" is 31,250 bps.)

### ■ IBM-PC/AT (Windows)

Connect the RS-232C terminal on the computer to the TO HOST terminal on the CVP-209/207 using a serial cable (D-SUB 9P → MINI DIN 8P cross cable). Set the CVP-209/207 HOST SELECT switch to the "PC-2." (Data transfer rate is 38,400 bps.)

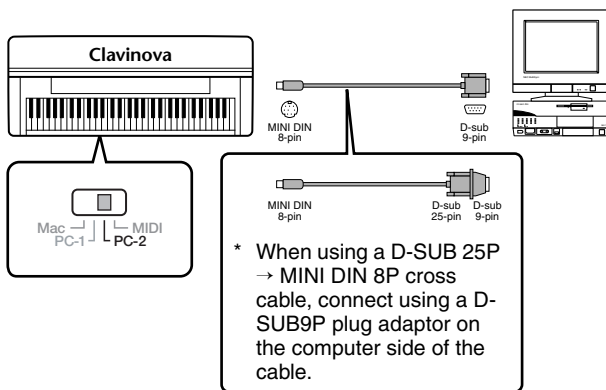

### ■ Macintosh

Connect RS-422 terminal (modem or printer) on the computer to the TO HOST terminal on the CVP-209/207 using a serial cable (system peripheral cable, 8 bit). Set the CVP-209/207 HOST SELECT switch to the "MAC" (Data transfer rate is 31,250 bps).

Set the MIDI interface clock in the sequencer you are using to 1 MHz. For details, refer to the owner's manual for the particular software you are using.

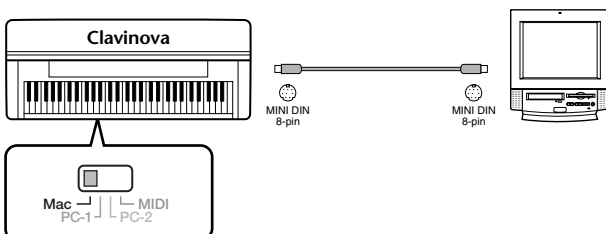

## Using the MIDI terminals

When using a MIDI interface device installed in the personal computer, connect the MIDI terminals of the personal computer and the CVP-209/207 with standard MIDI cables.

- When the computer has a MIDI interface installed, connect the MIDI OUT terminal of the personal computer to the MIDI IN terminal. Set the HOST SELECT switch to "MIDI."

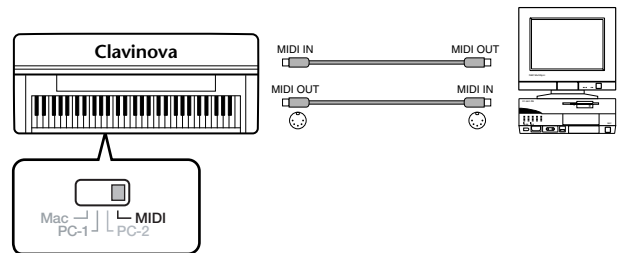

- When using a MIDI interface with a Macintosh series computer, connect the RS-422 terminal of the computer (modem or printer terminal) to the MIDI interface, then connect the MIDI OUT terminal on the MIDI interface to the MIDI IN terminal of the CVP-209/207, as shown in the diagram below. Set the HOST SELECT switch to "MIDI."

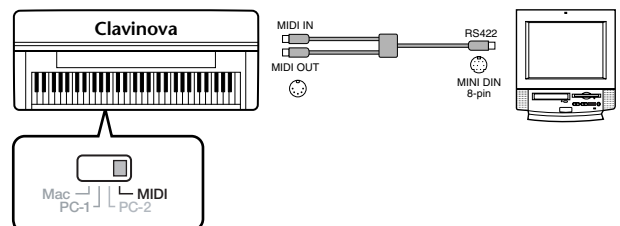

- When the HOST SELECT switch is set to "MIDI," the TO HOST terminal is disabled.
- When using a Macintosh series computer, set the MIDI interface clock setting in the application software to match the setting of the MIDI interface you are using. For details, refer to the owner's manual for the particular software you are using.

### Using the USB terminal on your computer with a USB/MIDI interface (UX256/UX96, etc.)

Connect the UX256/UX96 and the computer with a USB cable. Install the included UX256/UX96 driver to the computer, and connect the UX256/UX96 to the CVP-209/207 with a MIDI cable. Set the HOST SELECT switch on the CVP-209/207 to "MIDI." For details, refer to the owner's manual of the UX256/UX96.

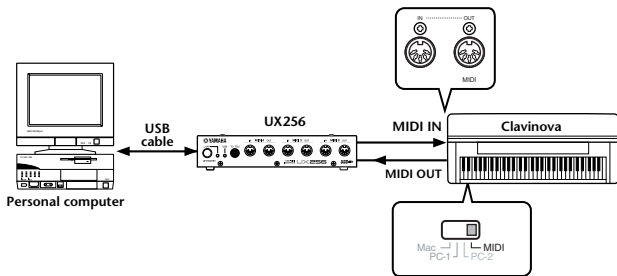

For details about the necessary MIDI settings for computer and sequence software you are using, refer to the relevant owner's manuals.

### What's MIDI?

Let's consider an acoustic piano and a classical guitar as representative acoustic instruments. With the piano, you strike a key, and a hammer inside hits some strings and plays a note. With the guitar, you directly pluck a string and the note sounds.

But how does a digital instrument go about playing a note?

Acoustic guitar note production

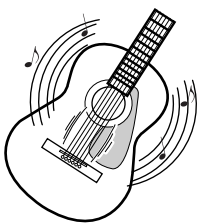

Pluck a string and the body resonates the sound.

Digital instrument note production

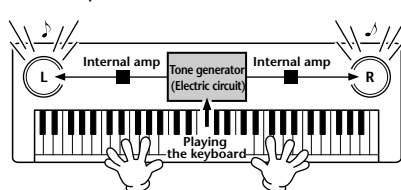

Based on playing information from the keyboard, a sampled note stored in the tone generator is played through the speakers.

As shown in the illustration above, in an electronic instrument, the sampled note (previously recorded note) stored in the **tone generator section** (electronic circuit) is played based on information received from the keyboard, and output through the speakers.

Now let's examine what happens when we play back a recording. When you playback a music CD (for example, a solo piano recording), you're hearing the actual sound (vibrations in air) of the acoustic instrument. This is called audio data, to distinguish it from MIDI data.

Recording and playing back the performance of an acoustic instrument (audio data)

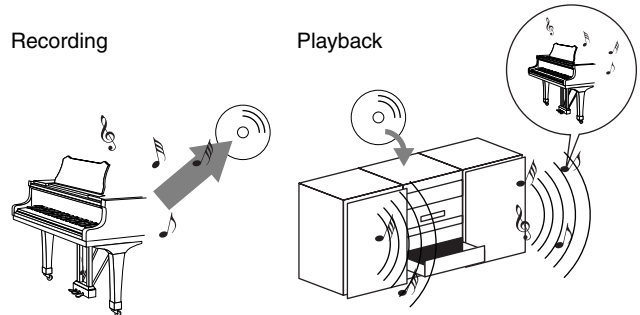

In the above example, the actual acoustic sounds of the pianist's performance are captured in the recording as audio data, and this is recorded to CD. When you play back that CD on your audio system, you can hear the actual piano performance. The piano itself is not necessary, since the recording contains the actual sounds of the piano, and your speakers reproduce them.

Recording and playing back the performance of a digital instrument (MIDI data)

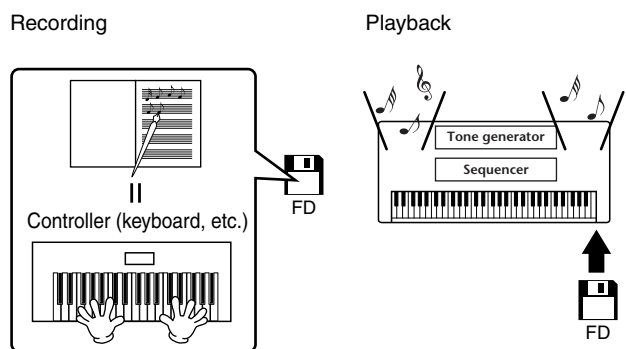

**NOTE**

In the case of digital instruments, the audio signals are sent through output jacks (such as AUX OUT) on the instrument.

The “controller” and “tone generator” in the illustration above are equivalent to the piano in our acoustic example. Here, the player’s performance on the keyboard is captured as MIDI song data (see illustration below). In order to record the audio performance on an acoustic piano, special recording equipment is needed. However, since the Clavinova features a built-in **sequencer** that lets you record performance data, this recording equipment is unnecessary. Instead, your digital instrument — the Clavinova — allows you to both record and play back the data.

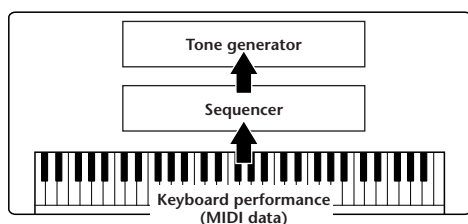

However, we also need a sound source to produce the audio, which eventually comes from your speakers. The **tone generator** of the Clavinova fills this function. The recorded performance is reproduced by the sequencer, playing back the song data, using a tone generator capable of accurately producing various instrument sounds — including that of a piano. Looked at in another way, the relation of the sequencer and the tone generator is similar to that of the pianist and the piano — one plays the other. Since digital instruments handle playback data and the actual sounds independently, we can hear our piano performance played by another instrument, such as guitar or violin.

#### NOTE

Even though it is a single musical instrument, the Clavinova can be thought of as containing several electronic components: a controller, a tone generator, and a sequencer.

Finally, we’ll take a look at the actual data that gets recorded and that serves as the basis for playing the sounds. For example, let’s say you play a “C” quarter note using the grand piano sound on the CVP-209/207 keyboard. Unlike an acoustic instrument that puts out a resonated note, the electronic instrument puts out information from the keyboard such as “with what voice,” “with which key,” “about how strong,” “when was it pressed” and “when was it released.” Then each piece of information is changed into a number value and sent to the tone generator. Using these numbers as a basis, the tone generator plays the stored sampled note.

## Example Keyboard Data

<b>Voice number (with what voice)</b>	01 (grand piano)
<b>Note number (with which key)</b>	60 (C3)
<b>Note on (when was it pressed) and note off (when was it released)</b>	Timing expressed numerically (quarter note)
<b>Velocity (about how strong)</b>	120 (strong)

Panel operations on the CVP-209/207, such as playing the keyboard and selecting voices, are processed and stored as MIDI data. The auto accompaniment styles and songs also consist of MIDI data.

MIDI is an acronym that stands for Musical Instrument Digital Interface, which allows electronic musical instruments to communicate with each other, by sending and receiving compatible Note, Control Change, Program Change and various other types of MIDI data, or messages.

The CVP-209/207 can control a MIDI device by transmitting note related data and various types of controller data. The CVP-209/207 can be controlled by incoming MIDI messages which automatically determine the tone generator mode, select MIDI channels, voices and effects, change parameter values and of course play the voices specified for the various parts.

#### NOTE

MIDI data has the following advantages over audio data:

- The amount of data is much less, letting you easily store MIDI songs to floppy disk.
- The data can be effectively and easily edited, even to the point of changing voices and transforming the data.

MIDI messages can be divided into two groups: Channel messages and System messages.

## Channel Messages

The CVP-209/207 is an electronic instrument that can handle 16 channels (or 32 channels, when using the TO HOST terminal). This is usually expressed as “it can play 16 instruments at the same time.” Channel messages transmit information such as Note ON/OFF, Program Change, for each of the 16 channels.

Message Name	CVP-209/207 Operation/Panel Setting
<b>Note ON/OFF</b>	Messages which are generated when the keyboard is played. Each message includes a specific note number which corresponds to the key which is pressed, plus a velocity value based on how hard the key is played.
<b>Program Change</b>	Voice selecting (control change bank select MSB/LSB setting)
<b>Control Change</b>	Volume, panpot (Mixing Console), etc.

#### NOTE

The performance data of all songs and styles is handled as MIDI data.

### MIDI channels

MIDI performance data is assigned to one of sixteen MIDI channels. Using these channels, 1 - 16, the performance data for sixteen different instrument parts can be simultaneously sent over one MIDI cable.

Think of the MIDI channels as TV channels. Each TV station transmits its broadcasts over a specific channel. Your home TV set receives many different programs simultaneously from several TV stations and you select the appropriate channel to watch the desired program.

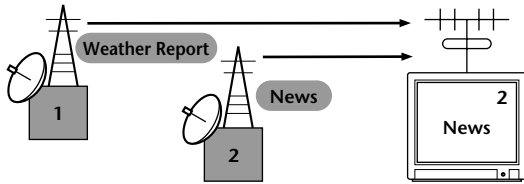

MIDI operates on the same basic principle. The transmitting instrument sends MIDI data on a specific MIDI channel (MIDI Transmit Channel) via a single MIDI cable to the receiving instrument. If the receiving instrument's MIDI channel (MIDI Receive Channel) matches the Transmit Channel, the receiving instrument will sound according to the data sent by the transmitting instrument.

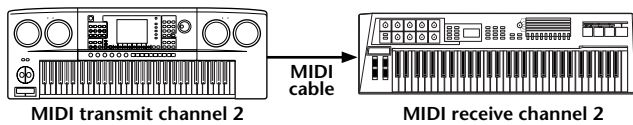

**NOTE**

The Clavinova's keyboard and internal tone generator are also connected by MIDI (page 145).

For example, several tracks (channels) can be transmitted simultaneously, including the style data (as shown below).

Example: Recording the auto accompaniment of the Clavinova to an external sequencer

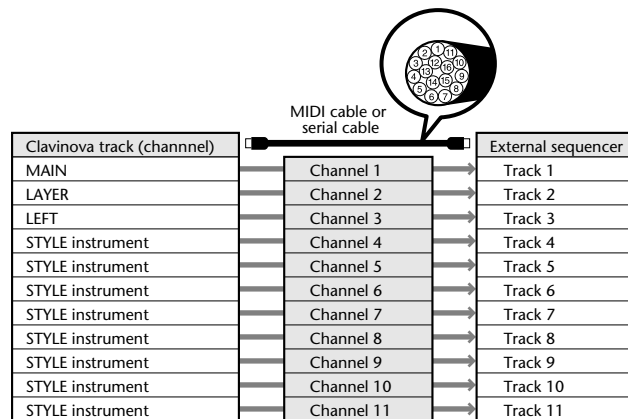

As you can see, it is essential to determine which data is to be sent over which MIDI channel when transmitting MIDI data (page 146). The Clavinova also allows you to determine how the received data is played back. (page 147).

### System Messages

This is data that is used in common by the entire MIDI system. System messages include messages like Exclusive Messages that transmit data unique to each instrument manufacturer and Realtime Messages that control the MIDI device.

Message Name	CVP-209/207 Operation/Panel Setting
System Exclusive Message	Effect type settings (Mixing Console), etc.
Realtime Messages	Clock setting, Start/stop operation

The messages transmitted/received by the CVP-209/207 are shown in the MIDI Data Format and MIDI Implementation Chart in the separate Data List.

## What You Can Do With MIDI

The following MIDI settings can be made on the Clavinova:

- MIDI templates (preset MIDI setups for various applications) (page 145)
  - Transmit (page 146)
  - Receive (page 147)
  - Local Control (page 145)
  - Clock (page 146)
- Record performance data (1-16 channels) using the CVP-209/207 Auto Accompaniment features on an external sequencer (such as a personal computer). After recording, edit the data with the sequencer, then play it again on the CVP-209/207 (playback).

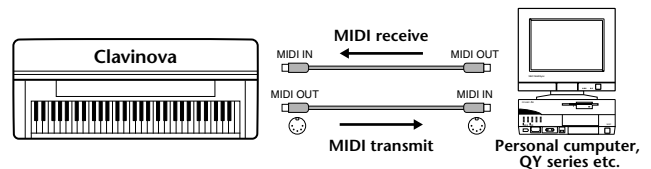

When you want to use the Clavinova as an XG-compatible multi-timbral tone generator, set the receive part for MIDI channels 1 to 16 to "SONG" in MIDI Receive (page 147).

- Play and control the Clavinova from a separate keyboard

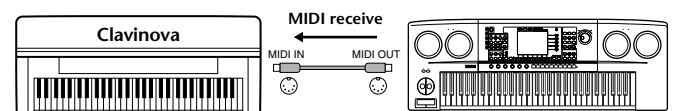

## Data Compatibility

This section covers basic information on data compatibility: whether or not other MIDI devices can playback the data recorded by CVP-209/207, and whether or not the CVP-209/207 can playback commercially available song data or song data created for other instruments or on a computer. Depending on the MIDI device or data characteristics, you may be able to play back the data without any problem, or you may have to perform some special operations before the data can be played back. If you run into problems playing back data, please refer to the information below.

### Disk format

Floppy disks are the main storage medium for data used with various devices, including computers. Different devices have different systems of storing data, therefore it is necessary to first configure the floppy disk to the system of the device being used. This operation is called "formatting."

- There are two types of floppy disks: MF2DD (double sided, double density) and MF2HD (double sided, high density), and each type has different formatting systems.
- CVP-209/207 can record and playback with both types of floppy disks.
- When formatted by the CVP-209/207, a 2DD disk stores up to 720 KB (kilobytes) and a 2HD disk stores up to 1.44 MB (megabytes). (The figures "720 KB" and "1.44MB" indicate the data memory capacity. They are also used to indicate the format type of disk.)
- Playback is only possible when the MIDI device to be used is compatible with the format of the disk.

## Sequence Format

The system which records song data is called "sequence format."

Playback is only possible when the sequence format of the disk matches that of the MIDI device. The CVP-209/207 is compatible with the following formats.

### ■ SMF (Standard MIDI File)

This is the most common sequence format. Standard MIDI Files are generally available as one of two types: Format 0 or Format 1. Many MIDI devices are compatible with Format 0, and most commercially available software is recorded as Format 0.

- The CVP-209/207 is compatible with both Format 0 and Format 1.
- Song data recorded on the CVP-209/207 is automatically recorded as SMF Format 0.
- Song data loaded to the CVP-209/207 is automatically saved as SMF Format 0 regardless of the original format.

### ■ ESEQ

This sequence format is compatible with many of Yamaha's MIDI devices, including the Clavinova series instruments. This is a common format used with various Yamaha software.

### ■ XF

The Yamaha XF format enhances the SMF (Standard MIDI File) format with greater functionality and open-ended expandability for the future.

- The CVP-209/207 is capable of displaying lyrics when an XF file containing lyric data is played.

### ■ Style File

The Style File Format – SFF – is Yamaha's original style file format which uses a unique conversion system to provide high-quality automatic accompaniment based on a wide range of chord types.

## Voice Allocation Format

With MIDI, voices are assigned to specific numbers, called “program numbers.” The numbering standard (order of voice allocation) is referred to as the “voice allocation format.”

Voices may not play back as expected unless the voice allocation format of the song data matches that of the compatible MIDI device used for playback.

The CVP-209/207 is compatible with the following formats.

### **NOTE**

Even if the devices and data used satisfy all the conditions above, the data may still not be completely compatible, depending on the specifications of the devices and particular data recording methods.

### ■ GM System Level 1

This is one of the most common voice allocation formats.

- Many MIDI devices are compatible with GM System Level 1, as is most commercially available software.

### ■ XG

XG is a major enhancement of the GM System Level 1 format, and was developed by Yamaha specifically to provide more voices and variations, as well as greater expressive control over voices and effects, and to ensure compatibility of data well into the future.

- Song data recorded on the CVP-209/207 using voices in the [XG] category is XG-compatible.

### ■ DOC

This voice allocation format is compatible with many of Yamaha’s MIDI devices, including the Clavinova series instruments. This is also a common format used with various Yamaha software.



# CVP-209/207: Keyboard Stand Assembly

## ⚠ CAUTION

- Be careful not to confuse parts, and be sure to install all parts in the correct direction. Please assemble in accordance with the sequence given below.
- Assembly should be carried out by at least two persons.
- Be sure to use the correct screw size, as indicated below. Use of incorrect screws can cause damage.
- Be sure to tighten up all screws upon completing assembly of each unit.
- To disassemble, reverse the assembly sequence given below.

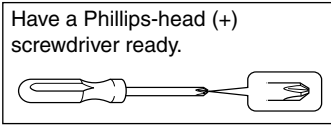

## 1 Remove all parts from the box. Confirm that all parts shown in the illustration are provided.

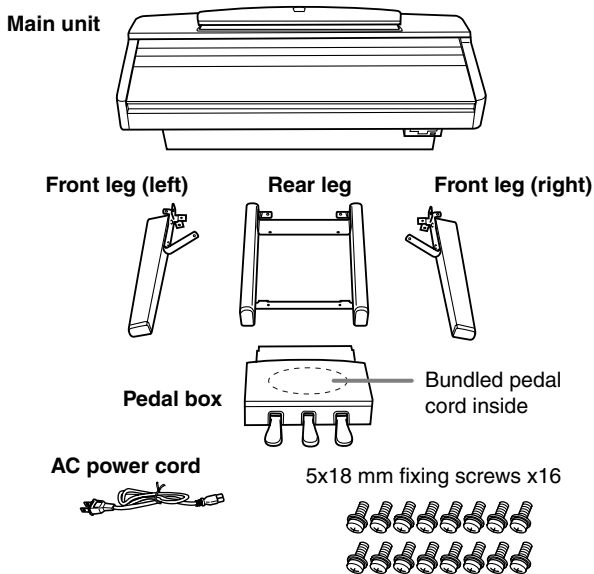

## 2 With the key cover closed and the keyboard side on the bottom, lean the unit against the wall.

### ⚠ CAUTION

- Be careful not to pinch your fingers.
- The top part of the music score stand is not fixed. When you lean the unit against the wall, support the music score stand with your hand so that the stand will not fall.

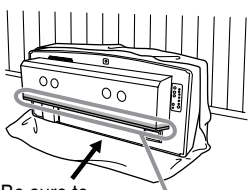

Spread a large soft cloth, such as a blanket, on the floor. Place the unit on the cloth with the keyboard side on the bottom and lean the unit against the wall so that the unit will not fall or slip. Place a soft cloth against the wall to protect the instrument and wall from scratches.

Be sure to position the keyboard side on the bottom.

### ⚠ CAUTION

Please do not touch the speaker net. Doing so may damage the speaker inside.

### ⚠ CAUTION

Do not place the main unit with the rear side facing down.

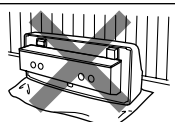

### ⚠ CAUTION

Do not lay the main unit upside-down on the floor.

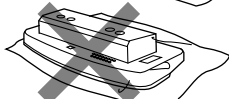

## 3 Remove the speaker box cover from the speaker box.

The speaker cover is attached to the unit with two tabs and velcro tape at several points. To remove the speaker cover, pull them straight down.

Be careful not to touch the speakers when handling the speaker box. Damage may result.

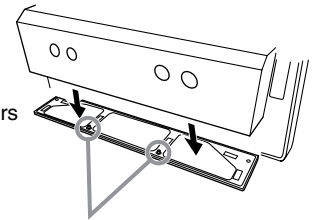

### ⚠ CAUTION

Put your hands at the positions indicated and pull as shown. The speakers are located to either side of these places - avoid touching the speakers as this may damage them.

## 4 Attach the front legs.

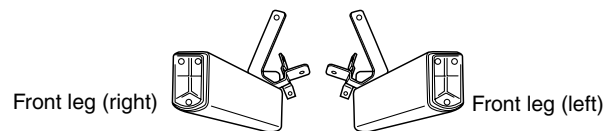

1 Fix the front right leg to the bottom surface of the unit using two screws.

2 Fix the front right leg to the speaker box using three screws.

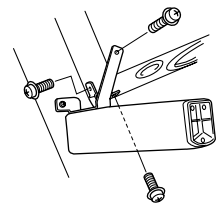
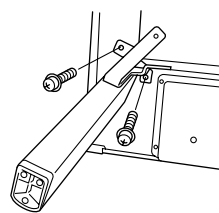

3 Fix the front left leg in the same way.

If the screw holes do not align, loosen the other screws and adjust the position of the front leg.

## 5 Attach the rear leg.

2 Fix the rear legs to the speaker box using two screws.

1 Fix the rear legs to the bottom surface of the unit using two screws.

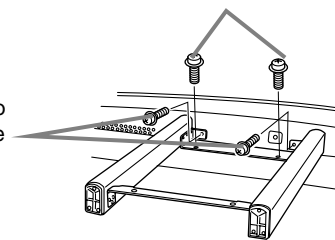

If the screw holes do not align, loosen the other screws and adjust the position of the rear legs.

## 6 Raising the unit to the standing position.

Use the front legs as support to raise the unit.

### ⚠ CAUTION

- Be careful not to pinch your fingers.
- When you raise the unit, do not hold the key cover.

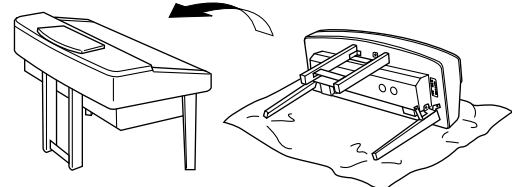

## 7 Installing the pedal box.

- 1 Remove the plastic cover from the rear legs.
- 2 Untie and straighten out the bundled cord attached to the bottom of the pedal box.

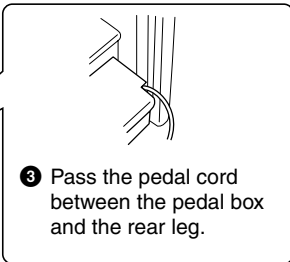
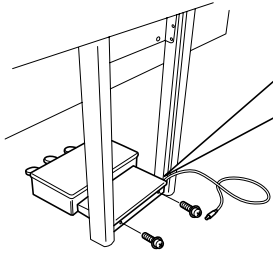
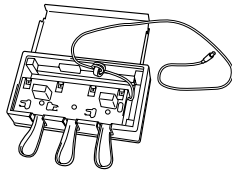
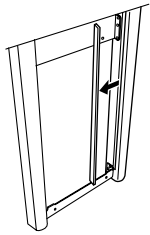

- 3 Pass the pedal cord between the pedal box and the rear leg.
- 4 Make sure that the pedal box lays flat, with no gap between itself and the floor, then affix the pedal box using two screws.

## 8 Connect the pedal cord.

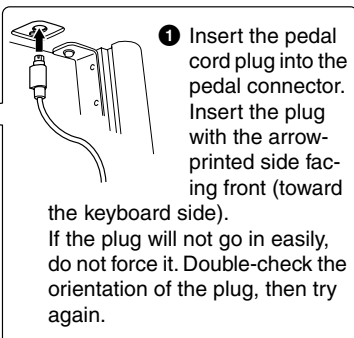
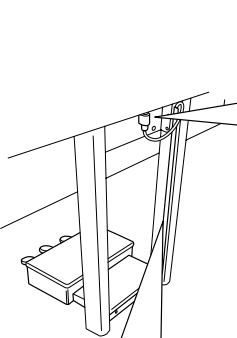

- 1 Insert the pedal cord plug into the pedal connector. Insert the plug with the arrow-printed side facing front (toward the keyboard side). If the plug will not go in easily, do not force it. Double-check the orientation of the plug, then try again.

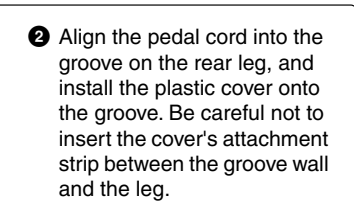
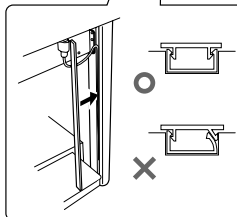

- 2 Align the pedal cord into the groove on the rear leg, and install the plastic cover onto the groove. Be careful not to insert the cover's attachment strip between the groove wall and the leg.

## 9 Installing the speaker cover to the speaker box.

Install the speaker cover on the speaker box so that the dented side comes to the upper-right corner. Align two plugs on the speaker cover with the holes on the speaker box, and push in where the velcro tape strips are attached.

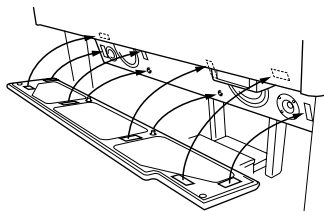

### CAUTION

The speaker cover is made of a very soft material. Pushing in a place where no tab or velcro tape is located may damage the speakers.

## 10 Set the voltage selector and connect the power cord.

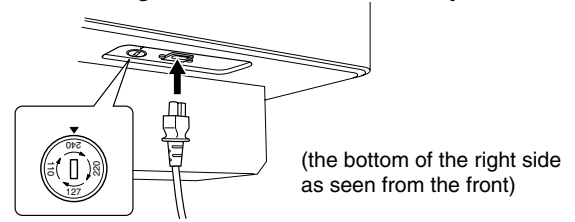

(the bottom of the right side as seen from the front)

### Voltage Selector

Before connecting the AC power cord, check the setting of the voltage selector which is provided in some areas. To set the selector for 110V, 127V, 220V or 240V main voltages, use a "minus" screwdriver to rotate the selector dial so that the correct voltage for your region appears next to the pointer on the panel. The voltage selector is set at 240V when the unit is initially shipped. After the proper voltage has been selected, connect the AC power cord to the AC INLET and an AC wall outlet. A plug adaptor may be also provided in some areas to match the pin configuration of the AC wall outlets in your area.

### WARNING

An improper voltage setting can cause serious damage to the Clavinova or result in improper operation.

### After completing the assembly, please check the following.

- Are there any parts left over?  
→ Review the assembly procedure and correct any errors.
- Is the Clavinova clear of doors and other movable fixtures?  
→ Move the Clavinova to an appropriate location.
- Does the Clavinova make a rattling noise when you shake it?  
→ Tighten all screws.
- Are the pedal and power cords inserted securely into the sockets?  
→ Check the connection.
- If the main unit creaks or is otherwise unsteady when you play on the keyboard, refer to the assembly diagrams and retighten all screws.

When moving the instrument after assembly, always hold the bottom of the main unit.

### CAUTION

Do not hold the key cover or top portion. Improper handling can result in damage to the instrument or personal injury.

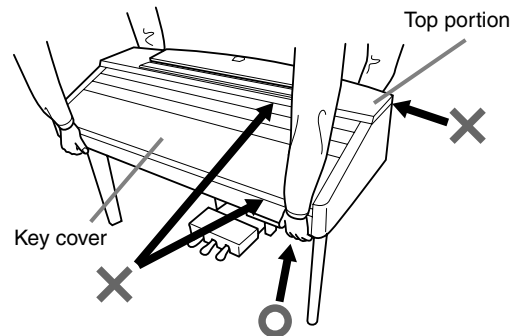

If you move the instrument after assembly, affix the screws on the pedal box again so that the pedal box will lay flat, with no gap between itself and the floor. (See step 7-4.)

# Troubleshooting

Problem	Possible Cause and Solution
<ul style="list-style-type: none"> <li>The Clavinova does not turn on; there is no power.</li> </ul>	<p>Make sure that the Clavinova has been plugged in properly. Securely insert the female plug into the AC socket on the Clavinova, and the male plug into a proper AC outlet (page 17).</p>
<ul style="list-style-type: none"> <li>A click or pop is heard when the power is turned on or off.</li> </ul>	<p>This is normal when electrical current is applied to the instrument.</p>
<ul style="list-style-type: none"> <li>Noise is heard from the Clavinova's speakers.</li> </ul>	<p>Using a mobile phone in close proximity to the Clavinova may produce interference. To prevent this, turn off the mobile phone, or use it further away from the Clavinova.</p>
<ul style="list-style-type: none"> <li>The display is too bright or too dark to read.</li> </ul>	<p>The brightness of the display may be affected by the surrounding temperature; try adjusting the contrast (page 149).</p>
<ul style="list-style-type: none"> <li>The keyboard volume is low compared to that of the Auto Accompaniment or song playback.</li> </ul>	<p>The overall keyboard volume or the independent volume level of the keyboard part may be set too low. Raise the MAIN/LAYER/LEFT volume voices or lower the STYLE/SONG volume in the BALANCE display (page 62).</p>
<ul style="list-style-type: none"> <li>The volume of the Auto Accompaniment or song playback is low compared to that of the keyboard.</li> </ul>	<p>The volume level of one or more accompaniment parts or song channels is set too low. Raise the part or channel level(s) in the appropriate MIXER display (page 121).</p>
<ul style="list-style-type: none"> <li>The overall volume is low, or no sound is heard.</li> </ul>	<ul style="list-style-type: none"> <li>The Master Volume is set too low; set it to an appropriate level with the [MASTER VOLUME] dial.</li> <li>The volume of the individual parts may be set too low. Raise the volume of MAIN, LAYER, LEFT, STYLE, and SONG in the BALANCE display (page 62).</li> <li>Make sure the desired channel is set to ON (page 62, 77).</li> <li>Headphones are connected, disabling the speaker output. (This happens when the speaker setting is set to "HEADPHONE SW"; page 149.) Unplug the headphones.</li> <li>Make sure the speaker setting is set to ON (page 149).</li> <li>Make sure the Local Control function is set to ON (page 145).</li> </ul>
<ul style="list-style-type: none"> <li>The damper, sostenuto and soft functions do not work for the relevant pedals.</li> </ul>	<p>Each pedal has been assigned to a different function. Make sure that each pedal is properly assigned to SUSTAIN, SOSTENUTO, and SOFT (page 139).</p>
<ul style="list-style-type: none"> <li>The damper pedal has no effect, or the sound continuously sustains even when the damper pedal is not pressed.</li> </ul>	<p>The pedal cable/plug may not be properly connected. Make sure to securely insert the pedal plug into the proper jack (page 161 - 162).</p>
<ul style="list-style-type: none"> <li>Not all simultaneously-played notes sound.</li> </ul>	<p>You may be exceeding the maximum polyphony of the Clavinova. When this happens, the earliest played notes will stop sounding, letting the latest played notes sound. See page 165 for information on the maximum polyphony.</p>
<ul style="list-style-type: none"> <li>Accompaniment style or Song playback does not start.</li> </ul>	<ul style="list-style-type: none"> <li>MIDI Clock may be set to "EXTERNAL." Make sure this is set to "INTERNAL" (page 146).</li> <li>Make sure to press the appropriate [START/STOP] button. To play an accompaniment style, press the <b>STYLE</b> [START/STOP] button (page 62); to playback a song, press the <b>SONG</b> [START/STOP] button (page 75).</li> <li>"New Song" (a blank song) has been selected. Make sure to select an appropriate song in the SONG display (page 75).</li> <li>The song has been stopped at the end of the song data. Return to the beginning of the song by pressing the [TOP] button (page 77).</li> </ul>
<ul style="list-style-type: none"> <li>Only the rhythm channel plays.</li> </ul>	<p>Make sure the Auto Accompaniment function is turned on; press the [ACMP] button.</p>
<ul style="list-style-type: none"> <li>The accompaniment style does not start, even when Synchro Start is in standby condition and a key is pressed.</li> </ul>	<p>You may be trying to start accompaniment by playing a key in the right hand range of the keyboard. Make sure to play a key in the left-hand (accompaniment) range of the keyboard.</p>
<ul style="list-style-type: none"> <li>The desired chord is not recognized or output by the auto accompaniment.</li> </ul>	<ul style="list-style-type: none"> <li>You may not be playing the correct keys to indicate the chord. Refer to "Chord Types Recognized in the Fingered Mode" (page 64).</li> <li>You may be playing the keys according to a different fingering mode, and not the one currently selected. Check the accompaniment mode, and play the keys according to the selected mode (page 62).</li> </ul>

Problem	Possible Cause and Solution
<ul style="list-style-type: none"> <li>Auto accompaniment chords are recognized regardless of the split point or where chords are played on the keyboard.</li> </ul>	<p>This is normal if the fingering mode is set to "Full Keyboard" or "AI Full Keyboard." If either of these is selected, chords are recognized over the entire range of the keyboard, irrespective of the split point setting. If desired, select a different fingering mode (page 62).</p>
<ul style="list-style-type: none"> <li>Certain notes sound at the wrong pitch.</li> </ul>	<p>The Scale parameter has probably been set to something other than "Equal," changing the tuning system of the keyboard. Make sure "Equal" is selected as the Scale in the Scale Tune page (page 135).</p>
<ul style="list-style-type: none"> <li>Some channels do not properly play back when playing back song data.</li> </ul>	<p>Make sure that playback of the relevant channel(s) is turned on (page 77).</p>
<ul style="list-style-type: none"> <li>If you experience distorted or out-of-tune sound from the Vocal Harmony feature, your vocal microphone may be picking up extraneous sounds (other than your voice) — the Auto Accompaniment sound from the Clavinova, for example. In particular, bass sounds can cause mistracking of the Vocal Harmony feature.</li> </ul>	<p>The solution to this problem is to ensure that as little extraneous sound as possible is picked up by your vocal microphone:</p> <ul style="list-style-type: none"> <li>Sing as closely to the microphone as possible.</li> <li>Use a directional microphone.</li> <li>Turn down the MASTER VOLUME or volume for each part.</li> <li>Separate the microphone from the instrument's speakers as much as possible.</li> <li>Cut the Low band via the 3 Band EQ function in the MICROPHONE SETTING display (page 130).</li> <li>Increase the microphone input level ("TH.") in the Compressor function from the MICROPHONE SETTING display (page 130).</li> </ul>
<ul style="list-style-type: none"> <li>Appropriate harmony notes are not produced by the Vocal Harmony feature.</li> </ul>	<p>Make sure you are using the appropriate method to specify the harmony notes for the current Vocal Harmony mode. See page 131.</p>
<ul style="list-style-type: none"> <li>The Harmony function does not operate.</li> </ul>	<p>Harmony cannot be used with the Full Keyboard or AI Full Keyboard fingering modes. Select an appropriate fingering mode (page 62).</p>
<ul style="list-style-type: none"> <li>The microphone input signal and Vocal Harmony sound cannot be recorded.</li> </ul>	<p>This is normal; recording the audio input of the microphone is not possible.</p>
<ul style="list-style-type: none"> <li>MIDI data is not transmitted or received via the MIDI terminals, even when MIDI cables are connected properly.</li> </ul>	<p>Make sure the HOST SELECT switch is set to "MIDI" (page 155). The MIDI terminals cannot be used for the other switch settings.</p>
<ul style="list-style-type: none"> <li>When a voice is changed, the previously selected effect is changed.</li> </ul>	<p>Each voice has its own suitable preset values which are automatically recalled when the corresponding Voice Set parameters are turned on (page 143).</p>
<ul style="list-style-type: none"> <li>There is a slight difference in sound quality between notes played on the keyboard.</li> <li>Some voices have a looping sound.</li> <li>Some noise or vibrato is noticeable at higher pitches, depending upon the voice.</li> </ul>	<p>This is normal and is a result of the Clavinova's sampling system.</p>
<ul style="list-style-type: none"> <li>Some voices will jump an octave in pitch when played in the upper or lower registers.</li> </ul>	<p>This is normal. Some voices have a pitch limit which, when reached, causes this type of pitch shift.</p>
<ul style="list-style-type: none"> <li>Disk save operations take a long time.</li> </ul>	<p>This is normal. Keep in mind that it takes approximately 1 minute to save 1 megabyte of data to a floppy disk.</p>
<ul style="list-style-type: none"> <li>The voice produces excessive noise.</li> </ul>	<p>Certain voices may produce noise, depending on the Harmonic Content and/or Brightness settings in the FILTER page of the Mixing Console display (page 122).</p>
<ul style="list-style-type: none"> <li>The sound is distorted or noisy.</li> </ul>	<ul style="list-style-type: none"> <li>The volume may be turned up too high. Make sure all relevant volume settings are appropriate.</li> <li>This may be caused by the effects. Try canceling all unnecessary effects, especially distortion-type effects (page 123).</li> <li>Some filter resonance settings in the Custom Voice Creator display (page 91) can result in distorted sound. Adjust these settings if necessary.</li> <li>Is the gain of the Low band set too high in the Master Equalizer display (Mixing Console — page 125) ?</li> </ul>
<ul style="list-style-type: none"> <li>A strange "flanging" or "doubling" sound occurs. Also, the sound is slightly different each time the keys are played.</li> </ul>	<p>Both the Main and Layer parts are set to "ON," and both parts are set to play the same voice. Set the Layer part to "OFF" (page 57) or change the voice for each part (page 55).</p>

# Specifications

○: available

Model Name		CVP-209	CVP-207		
Sound Source		AWM Dynamic Stereo Sampling			
Display		640 × 480 dots backlit graphic LCD			
Keyboard		88 keys (A-1 - C7)			
Voice	Polyphony (max)	256	192		
	Voice Selection	390 voices + 480 XG voices + 26 Drum Kits			
		Regular Voice	343		
		Sweet Voice	10		
		Cool Voice	6		
		Live Voice	17		
		Natural Voice	37	22	
	Organ Flutes	10 (9 Footages)	10 (8 Footages)		
Sound creator		○			
Effects	Effect Blocks	Reverb	2		
		Chorus	2		
		DSP	7	5	
		Brilliance	1		
		Microphone	1		
	Effect Types	REVERB1	29 Preset+3 User		
		REVERB2	5		
		CHORUS1	25 Preset+3 User		
		CHORUS2	3		
		DSP1	164 Preset+3 User		
		DSP2	12		
		DSP3,4,5,6 (DSP6; CVP-209 only)	164 Preset +10 User	88 Preset +10 User	
		DSP7 (CVP-209 only)	88 Preset +10 User	—	
		Brilliance	5		
	Master EQ	5 Preset + 2 User			
	Part EQ	27 Parts			
	Vocal Harmony		59 Preset +10 User	49 Preset +10 User	
	Accompaniment Style	Number of Accompaniment Styles		231	217
		Number of Session Styles		28	
Number of Pianist Styles		36			
Number of Piano Combo Styles		17			
Fingering		Single Finger, Fingered, Fingered On Bass, Multi Finger, AI Fingered, Full Keyboard, AI Full Keyboard			
Style Creator		○			
OTS (One Touch Setting)		4/Accompaniment Style			
OTS link		○			
Music Finder		Approximately 2500 records			
	Edit	○			

## Specifications

Model Name		CVP-209	CVP-207
Song	Format	SMF (Format 0,1), ESEQ	
	Preset Songs	○	
	Guide	Follow Lights, Any Key, Karao-Key, Vocal CueTIME	
		Guide Lamp	88 Red
	Lyrics	○	
	Score	○	
	Recording	Quick Recording, Multi Recording, Step Recording, Song Editing	
Record Channels		16	
Memory Device	Floppy Disk (2HD,2DD)	○	
	Flash Memory (internal)	4MB	
	Flash Availability	Song (SMF), Style (SFF), Registration, Voice, etc.	
Tempo	Tempo Range	5 - 500	
	Tap Tempo	○	
	Metronome	○	
		Sound	Bell on/off, Human Voices (5 languages)
Registration Memory	Buttons	8	
	Regist Sequence	○	
	Freeze	○	
Others	Demo	Function, Voice, Style	
	Language	6 languages (English, Japanese, German, French, Spanish, Italian)	
	Help	○	
	Direct Access	○	
	Piano setting button (including Piano Lock)	○	
	Master Volume	○	
	Fade In/Out	○	
	Transpose	Keyboard/Song/Master	
	Tuning	○	
	Tuning Curve	Flat/Stretch (Natural Piano Voice only)	
	Scale	Equal Temperament, Pure Major/Pure Minor, Pythagorean, Mean-Tone, Werckmeister/Kirnberger, Arabic 1/2	
	Touch Response	5 level	
	Jacks/Connectors		PHONES × 2, MIDI (THRU, OUT, IN), TO HOST, HOST SELECT SW, AUX PEDAL, AUX IN (L/L+R), AUX OUT (LEVEL FIXED) (L/R), AUX OUT (L/L+R)
MIC (INPUT VOLUME, MIC./ LINE IN), VIDEO OUT			
Pedals	Number of Pedals	3	
	Pedal Functions	VOLUME, SUSTAIN, SOSTENUTO, SOFT, GLIDE, PORTAMENTO, PITCHBEND, MODULATION, DSP VARIATION, VIBROTOR ON/OFF, SONG START/STOP, STYLE START/STOP, etc.	
Amplifiers/ Speakers	Amplifiers	60 W × 2	
	Speakers	(16 cm + 5 cm + 3 cm) × 2	
Dimensions [W × D × H] (with the Music Stand)		1426.0 × 633.5 × 932 mm [56-1/8" × 24-15/16" × 36-11/16"] (1426.0 × 633.5 × 1097.4 mm) [56-1/8" × 24-15/16" × 43-3/16"]	1429.9 × 634.3 × 927.4 mm [56-5/16" × 24-15/16" × 36-1/2"] (1429.9 × 634.3 × 1092.6 mm) [56-5/16" × 24-15/16" × 43-1/8"]
Weight		83.5 Kg (184 lbs., 13 oz)	78.5 Kg (173 lbs., 10 oz)

\* Specifications and descriptions in this owner's manual are for information purposes only. Yamaha Corp. reserves the right to change or modify products or specifications at any time without prior notice. Since specifications, equipment or options may not be the same in every locale, please check with your Yamaha dealer.

# Index

## Numerics

1 - 16 .....	107
[1▲▼] - [8▲▼] buttons .....	18, 39–46
3BAND EQ (3-BAND EQUALIZER) .....	130

## A

[A] - [J] buttons .....	18, 41
Accessories .....	6
Accompaniment Guide .....	79
Accompaniment style parts .....	96
[ACMP] button .....	18, 61
Adjust the Volume Balance and Changing Voices .....	120
Adjusting the Effects .....	123
Adjusting the Sound to Match the Performance	
Environment .....	125
Adjusting the Tempo .....	51
Adjusting the Vocal Harmony Settings	
and Microphone Effects .....	130
Adjusting the Volume Balance .....	62
Adjusting the Volume Balance / Muting Specific Channels .....	77
Adjusting values .....	47
AI .....	63
AI FINGERED .....	63
AI FULL KEYBOARD .....	63
Any Key .....	79
Append .....	72
Applying Voice Effects .....	58
Appropriate Panel Setting for the Selected Style .....	68
Arabic .....	136
Arranging the Style Pattern .....	65
Assembling an Accompaniment Style .....	114
ATTACK .....	91
AUTO .....	20
Auto Revoice .....	121
[AUTO FILLIN] button .....	18, 67
Automatically Changing One Touch Settings	
with the Sections .....	69
AUX IN [L / L+R] [R] jacks .....	19, 153
AUX OUT (LEVEL FIXED) [L] [R] jacks .....	19, 153
AUX OUT [L / L+R] [R] jacks .....	19, 153
[AUX PEDAL] jack .....	19, 154

## B

[BACK] button .....	18, 41, 47
BACK GROUND .....	84
[BALANCE] button .....	18, 62
Bar Clear .....	117
Bar Copy .....	117
Basic Operations — Organizing Your Data .....	39
Bass .....	96
BEAT .....	71, 72
[BREAK] button .....	18, 65
BRIGHTNESS .....	91

## C

Calling Up Ideal Setups for Your Music .....	70
Cent .....	135
Change the Rhythmic Feel .....	115
Changing Pitch-related Settings .....	122
Changing the Automatically Selected Voice Settings .....	143
Changing the Icon .....	47

Changing the Tone of the Voice .....	122
Changing the Touch Sensitivity and Transpose .....	141
Channel .....	62, 77, 104, 117, 137
Channel Messages .....	157
Channel Muting .....	62
[CHANNEL ON / OFF] button .....	18, 62, 77
Channel Transpose .....	106
CHD .....	108
Chord .....	96
Chord Detect .....	147
Chord Events .....	108
Chord Fingering .....	63, 139
Chord Tutor .....	139
Chord Types Recognized in the Fingered Mode .....	64
Chorus .....	126
Clock .....	146
COLOR NOTE .....	83
COMMON .....	90
Compatible Song Types .....	74
COMPRESSOR .....	131
CONFIG 1 .....	148
CONFIG 2 .....	149
Connect the power cord .....	17
Connecting Audio & Video Devices .....	153
Connecting external MIDI devices .....	154
Connecting the Microphone or Guitar .....	152
Connecting to a Computer .....	154
Controller .....	139
Converting into Kanji (Japanese language) .....	46
Cool! .....	56
COPY .....	44
Copying and Formatting Disks .....	150
Copying Files/Folders .....	44
Copying from Disk to Disk .....	150
Creating Accompaniment Styles .....	110
Current Memory .....	40
Customizing the Event List — Filter .....	109
CUT .....	43

## D

Damper pedal .....	19, 59
Data Compatibility .....	159
[DATA ENTRY] dial .....	18, 47
Data Types in the MIDI TRANSMIT/RECEIVE Display .....	146
DECAY .....	91
DELETE .....	44
Delete .....	105
DELETE RECORD .....	72
Deleting Files/Folders .....	44
[DEMO] button .....	14, 18, 53
DEPTH .....	91
Detailed Settings for Notation .....	82
[DIGITAL RECORDING] button .....	14, 18, 94, 110
[DIRECT ACCESS] button .....	18, 48
Direct Access Chart .....	49
Disk .....	150
Disk format .....	159
Disk Orchestra Collection .....	19
Displaying Music Notation .....	81
Displaying the Lyrics .....	84
Displaying Upper Level pages .....	45
DOC .....	160

Drum .....	56
[DSP] button .....	18, 58, 126
Dynamics .....	116

**E**

ECHO .....	59, 143
EDIT .....	113
Edit the Created Accompaniment Style .....	115
Editing a Recorded Song .....	104
Editing Channel-related Parameters .....	104
Editing Chord Events .....	108
Editing Note Events .....	107
Editing Records .....	72
Editing System Events .....	108
Editing the Channel Data .....	117
Editing Voices .....	88
[EFFECT] button .....	18, 128
Effect Block .....	124
Effect Structure .....	126
EFFECT/EQ .....	92
Effects .....	123
EG .....	91
Embellish and enhance your melodies	
— with the automatic Harmony and Echo effects .....	30
END Mark .....	102
ENDING .....	67
[ENDING / rit.] button .....	18, 31, 66
[ENTER] button .....	18, 47
Entering Characters .....	46
Entering Chords and Sections (Chord Step) .....	101
Entering miscellaneous characters (marks) .....	46
Entering numbers .....	46
Entering special character marks	
(umlaut, accent, Japanese “ゝ” and “ゝ”) .....	46
Entering Your Name and Language Preference .....	151
EQ .....	125
Equal Temperament .....	136
ESEQ .....	159
Example Keyboard Data .....	157
[EXIT] button .....	18, 41
exit from small pop-up windows .....	41
[EXTRA TRACKS (STYLE)] button .....	18, 78

**F**

Fade In Time, Fade Out Time, Fade Out Hold Time .....	148
[FADE IN / OUT] button .....	18, 66
FAVORITE .....	72
[FF] button .....	18, 77
File .....	40
File/Folder-related Operations .....	42
Files/folders in a floppy disk .....	43
Fill .....	67
Filter .....	91, 109, 122
FINGERED .....	63
FINGERED ON BASS .....	63
First Key On .....	103
FLOPPY DISK drive .....	40
Floppy disk drive .....	19, 6
Follow Lights .....	79
Foot Controller .....	59, 154
FOOTAGE (Organ Flutes) .....	93
Footswitch .....	59, 154
Formatting a Disk .....	150
[FREEZE] button .....	19, 87, 142
FULL KEYBOARD .....	63
[FUNCTION] button .....	18, 133

**G**

Gate Time .....	99
GENRE .....	71, 73
GENRE NAME .....	73
GM System Level 1 .....	19, 160
Groove .....	115
Groove parameters .....	115
[GUIDE] button .....	14, 18, 79

**H**

Handling the Floppy Disk Drive (FDD) and Floppy Disk .....	6
Harmonic Content .....	91
HARMONY .....	59, 92, 143
Harmony Assignments .....	144
Harmony Types .....	144
[HARMONY / ECHO] button .....	18, 59
Headphones .....	17, 152
Help messages can be displayed in any one of the	
following languages .....	50
[HELP] button .....	18, 50
High Key .....	119
[HOST SELECT] switch .....	19, 154
Hz .....	135

**I**

ICON SELECT .....	47
[INPUT VOLUME] knob .....	19, 152
Inputting and Editing Lyrics .....	109
Instant Selection of Displays .....	48
INTRO .....	67
[INTRO] button .....	18, 31, 65

**K**

Karao-Key .....	79
Key cover .....	16
KEY SIGNATURE .....	82
Keyboard guide lamps .....	19, 79
Keyboard Percussion .....	56
Keyboard Touch .....	141
Keyboard/Panel .....	141
KEYWORD .....	71, 72
Kirnberger .....	136

**L**

Layer .....	57
Layering Two Different Voices .....	57
LCD .....	15
Left .....	58
LEFT CH. .....	82
[LEFT HOLD] button .....	18, 59
Left pedal .....	19, 59
Live! .....	56
Live!Drums .....	56
Local Control .....	145
Loop recording .....	110
Lyrics .....	84, 109
LYRICS BACKGROUND PICTURE .....	84

**M**

MAIN A/B/C/D .....	65
MAIN [A] button .....	18, 65
MAIN [B] button .....	18, 65
MAIN [C] button .....	18, 65
MAIN [D] button .....	18, 65



MAIN PICTURE .....	151
Maintaining Panel Settings .....	142
Maintenance .....	8
Making Global and Other Important Settings.....	133
Making Overall System Settings (Local Control, Clock, etc.) ...	145
Making Settings for Fade In/Out, Metronome, Parameter Lock, and Tap .....	148
Making Settings for the Display, Speaker System, and Voice Number Indication .....	149
Making Settings for the Pedals .....	139
Making Settings for the Pedals and Keyboard .....	139
Making Settings for the Vocal Harmony and Microphone...	130
Making Style File Format Settings .....	118
Master Tune .....	135
Mastering Your Favorite Songs.....	38
[MASTER VOLUME] dial .....	18, 17
Mean-Tone.....	136
Measure/Beat/Clock .....	99
[MEMORY] button.....	19, 85
Message Switch .....	146
Messages.....	8
Metronome .....	148
METRONOME [START / STOP] button .....	18, 51
MIC.....	128
[MIC. LINE] switch .....	19, 152
[MIC. LINE IN] jack.....	19, 152
Microphone .....	128
MICROPHONE SETTING .....	130
[MIC. SETTING] button .....	18, 128
MIDI .....	145
MIDI [THRU] [OUT] [IN] terminals.....	19, 154
MIDI channels.....	158
MIDI IN.....	154
MIDI OUT.....	154
MIDI Receive Parts.....	147
MIDI SETUP .....	151
MIDI terminals .....	154
MIDI THRU.....	154
Mix .....	105
[MIXING CONSOLE] button.....	18, 120
[MONO] button .....	18, 59
Moving Files/Folders .....	43
MULTI FINGER .....	63
Multi Recording .....	96
[MUSIC FINDER] button .....	15, 19, 33, 70
Music Finder Record Edit .....	72
Music Finder Search.....	71
Music Stand .....	16
Muting Specific Parts.....	78
<b>N</b>	
NAME .....	42
Naming Files/Folders.....	42
Natural Voices .....	89
Natural!.....	56
NEW (FOLDER).....	45
NEW RECORD.....	72
[NEXT] button .....	18, 41, 47
NOISE GATE .....	130
Normal.....	103
Note Events .....	107
Note for Windows users (regarding MIDI driver).....	154
Note Limit .....	119
NOTE NAME.....	83
NTR (Note Transposition Rule).....	118
NTT (Note Transposition Table).....	119

<b>O</b>	
OCTAVE .....	122
One Touch Setting .....	32
ONE TOUCH SETTING [1] - [4] buttons.....	19, 68, 69
One-touch Piano Play .....	56
[ON / OFF] button (POWER).....	18, 17
Open/Save displays.....	39
Organ Flutes! .....	56
Organizing Files by Creating a New Folder.....	45
Other Parameters in the Basic Display .....	113
Other Playback-related Operations.....	77
Other Settings .....	148
[OTS LINK] button .....	18, 69
Outputting the sound of an external device through the built-in speakers of the Clavinova.....	153
OVERALL SETTING .....	130
Overdub recording .....	110
Owner .....	151
<b>P</b>	
Pad .....	96
Parameter .....	118
Parameter Lock.....	149
PASTE .....	43, 44
Pedal .....	139
Pedal (Center) .....	59
Pedal (Left) .....	59
Pedal (Right) .....	59
Pedal-controllable Functions.....	140
[PHONES] jacks.....	19, 152
Phrase.....	96
Phrase Mark.....	77, 137
[PIANO] button .....	15, 19, 56
PIANO (SOUND CREATOR).....	90
Piano Lock function .....	56
PITCH BEND RANGE .....	122
Pitch settings for each scale .....	136
Playback of Songs .....	21
Playing a style.....	28, 60
Playing a Style's Rhythm Channels only.....	62
Playing Along with the Clavinova .....	36
Playing and Practicing with the Songs.....	36
Playing Back Songs on Disk.....	77
Playing Different Voices with the Left and Right Hands.....	27
Playing Fill-in patterns automatically when changing accompaniment sections .....	67
Playing Several Sounds Simultaneously.....	57
Playing Styles.....	28
Playing the Demos.....	20, 53
Playing the Internal Songs .....	75
Playing the sounds of the Clavinova through an external audio system, and recording the sounds to an external recorder .....	153
Playing Two Voices Simultaneously .....	26
Playing Voices .....	25
PORTAMENTO TIME.....	122
Practice Functions.....	79
Practicing Music with the Guide Functions.....	80
PRESET drive.....	40
Preset MIDI Templates .....	145
Punch In/Out .....	103
Pure Major.....	136
Pure Minor.....	136
Pythagorean.....	136

- Q**
- QUANTIZE ..... 82
  - Quantize ..... 104, 117
  - Quantize Size ..... 104
  - Quick Recording ..... 95
  - Quick Start ..... 137
- R**
- Realtime Recording ..... 112
  - Realtime Recording Characteristics ..... 110
  - [REC] button ..... 18, 94
  - Rec Mode ..... 103
  - Recalling a Registration Memory Setup ..... 87
  - Recalling the Registered Settings ..... 87
  - Receive ..... 147
  - Receive Transpose ..... 146
  - Receiving MIDI Data ..... 147
  - record ..... 70
  - Recording ..... 37
  - Recording Chord Changes for the Auto Accompaniment ..... 101
  - Recording Individual Notes ..... 98
  - Recording Melodies ..... 100
  - Recording Your Performances and Creating Songs ..... 94
  - Registering Panel Setups ..... 85
  - Registering the Panel Controls in One Touch Setting ..... 69
  - REGISTRATION BANK ..... 86
  - REGISTRATION EDIT display ..... 86
  - REGISTRATION MEMORY [1] – [8] buttons ..... 19, 85
  - Registration Sequence ..... 142
  - Regular Voices ..... 89
  - RELEASE ..... 91
  - Remove Event ..... 117
  - Repeat Playback of a Specific Range ..... 78
  - [REPEAT] button ..... 18, 78
  - Replace ..... 72
  - Resonance ..... 91
  - Restoring the Factory-programmed Settings
    - of the CVP-209/207 ..... 151
  - [REVERB] button ..... 18, 58
  - Reverb ..... 126
  - [REW] button ..... 18, 77
  - Rhythm ..... 96
  - RIGHT CH. .... 82
  - Root ..... 147
  - RTR (Retrigger Rule) ..... 119
- S**
- SAVE ..... 45
  - Save ..... 39, 45
  - Saving Files ..... 45
  - Saving Your Registration Memory Setups ..... 86
  - Scale ..... 136
  - Scale Tune ..... 135
  - Score ..... 81
  - Searching the Ideal Setups ..... 71
  - Searching the Music Finder Records ..... 34
  - Section button indications
    - [BREAK], [INTRO], [MAIN], [ENDING] buttons ..... 65
  - sections ..... 30
  - Select the Recording Options: Starting, Stopping,
    - Punching In/Out ..... 103
  - Selecting a Scale ..... 135
  - Selecting a Voice ..... 55
  - Selecting Files and Folders ..... 41
  - Selecting Intro and Ending Types ..... 67
  - Selecting items ..... 47
  - Selecting the Freeze Settings ..... 87
  - Sequence Format ..... 159
  - sequencer ..... 157
  - Set Up ..... 106
  - Setting Auto Accompaniment-related Parameters ..... 138
  - Setting Chord Channels ..... 147
  - Setting Harmony and Echo ..... 143
  - Setting Root Note Channels ..... 147
  - Setting Separate Voices for the Left and Right Sections
    - of the Keyboard ..... 58
  - Setting Song-related Parameters ..... 137
  - Setting the Fingering Method ..... 139
  - Setting the Level Balance and Voice ..... 121
  - Setting the Microphone Volume and Related Effects ..... 132
  - Setting the MIDI Parameters ..... 145
  - Setting the Registration Sequence, Freeze, and Voice Set ..... 142
  - Setting the volume ..... 17
  - SFX ..... 56
  - Sheet Music Braces ..... 16
  - Showing the Clavinova Display on a TV ..... 144, 153
  - Simultaneously Playing a Song and an Accompaniment
    - Style ..... 76
  - SINGLE FINGER ..... 63
  - SMF (Standard MIDI File) ..... 159
  - Song ..... 14, 74
  - SONG AUTO REVOICE ..... 121
  - Song Book ..... 22, 74
  - Song Creator ..... 94
  - Song Playback ..... 21, 74, 75
  - Song Recording ..... 94
  - Song Settings ..... 137
  - SONG [START / STOP] button ..... 18, 75
  - Sostenuto pedal ..... 19, 59
  - SOUND (SOUND CREATOR) ..... 90
  - SOUND CREATOR Parameters (Natural/Regular Voices) ..... 89
  - [SOUND CREATOR] button ..... 18, 88
  - Source Root/Chord ..... 118
  - Specifying the Order for Calling Up Registration Memory
    - Presets ..... 142
  - SPEED ..... 91
  - Split Point ..... 138
  - Step Record ..... 98
  - Step Record (Chord) ..... 101
  - Step Record (Note) ..... 100
  - Step Recording ..... 113
  - Stopping the Style Playback While Releasing Keys ..... 66
  - Style ..... 14, 60
  - Style Creator ..... 110
  - Style File ..... 19, 159
  - Style File Format ..... 111
  - Style Sections ..... 30
  - Style Setting ..... 138
  - STYLE [START / STOP] button ..... 18, 61
  - sustain ..... 91
  - Sweet! ..... 56
  - [SYNC.START] button ..... 18, 61
  - [SYNC.STOP] button ..... 18, 66
  - SYS/EX. (System Exclusive) ..... 108
  - System ..... 145
  - System Events ..... 108
  - System Messages ..... 158
  - System Reset ..... 151
  - SYSTEM SETUP ..... 151
- T**
- [TALK] button ..... 18, 128
  - TALK SETTING ..... 132

Tap Count .....	149
[TAP TEMPO] button.....	18, 52
TEMPO [◀] [▶] buttons .....	18, 51
TEMPO FROM .....	71
Tempo Indications — MAIN Display .....	52
TEMPO TO .....	71
[TO HOST] terminal.....	15, 19, 154, 155
[TOP] button .....	18, 77
[TRACK 1 (R)] button.....	18, 78
[TRACK 2 (L)] button .....	18, 78
Transmit .....	146
Transmit Clock.....	146
Transmitting MIDI Data.....	146
TRANSPOSE [◀] [▶] buttons.....	18, 141
Transpose Assign .....	141
Tune.....	122
TUNING .....	122
Tuning the Overall Pitch .....	135

## U

UP.....	45
USER drive .....	40
USER EFFECT .....	124, 151
Using the USB terminal on your computer with a USB/MIDI interface (UX256, etc.) .....	156
Using Your Clavinova with Other Devices .....	152
Utility.....	148

## V

[VARIATION] button.....	18, 58
Velocity.....	99, 116
Velocity Change.....	117
[VH TYPE SELECT] button .....	18, 128
VIBRATO .....	91
[VIDEO OUT] jack.....	19, 144, 153
Vocal CueTIME .....	79
[VOCAL HARMONY] button.....	18, 128
VOCAL HARMONY CONTROL.....	131
Vocal Harmony Type .....	128
Voice Allocation Format.....	160
VOICE buttons .....	15, 19, 55
Voice Characteristics .....	56
Voice Effects.....	58
VOICE PART ON / OFF [LAYER] button .....	18, 57
VOICE PART ON / OFF [LEFT] button .....	18, 57
Voice Set.....	143
VOL/ATTACK (Organ Flutes) .....	93
Volume/Voice .....	121

## W

Werckmeister .....	136
What You Can Do With MIDI .....	158
What's MIDI? .....	156

## X

XF .....	19, 159
XG .....	19, 160

# IMPORTANT SAFETY INSTRUCTIONS

## INFORMATION RELATING TO PERSONAL INJURY, ELECTRICAL SHOCK, AND FIRE HAZARD POSSIBILITIES HAS BEEN INCLUDED IN THIS LIST.

**WARNING-** When using any electrical or electronic product, basic precautions should always be followed. These precautions include, but are not limited to, the following:

- 1.** Read all Safety Instructions, Installation Instructions, Special Message Section items, and any Assembly Instructions found in this manual **BEFORE** making any connections, including connection to the main supply.
- 2.** Main Power Supply Verification: Yamaha products are manufactured specifically for the supply voltage in the area where they are to be sold. If you should move, or if any doubt exists about the supply voltage in your area, please contact your dealer for supply voltage verification and (if applicable) instructions. The required supply voltage is printed on the name plate. For name plate location, please refer to the graphic found in the Special Message Section of this manual.
- 3.** This product may be equipped with a polarized plug (one blade wider than the other). If you are unable to insert the plug into the outlet, turn the plug over and try again. If the problem persists, contact an electrician to have the obsolete outlet replaced. Do **NOT** defeat the safety purpose of the plug.
- 4.** Some electronic products utilize external power supplies or adapters. Do **NOT** connect this type of product to any power supply or adapter other than one described in the owners manual, on the name plate, or specifically recommended by Yamaha.
- 5.** **WARNING:** Do not place this product or any other objects on the power cord or place it in a position where anyone could walk on, trip over, or roll anything over power or connecting cords of any kind. The use of an extension cord is not recommended! If you must use an extension cord, the minimum wire size for a 25' cord (or less) is 18 AWG. **NOTE:** The smaller the AWG number, the larger the current handling capacity. For longer extension cords, consult a local electrician.
- 6.** Ventilation: Electronic products, unless specifically designed for enclosed installations, should be placed in locations that do not interfere with proper ventilation. If instructions for enclosed installations are not provided, it must be assumed that unobstructed ventilation is required.
- 7.** Temperature considerations: Electronic products should be installed in locations that do not significantly contribute to their operating temperature. Placement of this product close to heat sources such as; radiators, heat registers and other devices that produce heat should be avoided.
- 8.** This product was **NOT** designed for use in wet/damp locations and should not be used near water or exposed to rain. Examples of wet/damp locations are; near a swimming pool, spa, tub, sink, or wet basement.
- 9.** This product should be used only with the components supplied or; a cart, rack, or stand that is recommended by the manufacturer. If a cart, rack, or stand is used, please observe all safety markings and instructions that accompany the accessory product.
- 10.** The power supply cord (plug) should be disconnected from the outlet when electronic products are to be left unused for extended periods of time. Cords should also be disconnected when there is a high probability of lightning and/or electrical storm activity.
- 11.** Care should be taken that objects do not fall and liquids are not spilled into the enclosure through any openings that may exist.
- 12.** Electrical/electronic products should be serviced by a qualified service person when:
  - a. The power supply cord has been damaged; or
  - b. Objects have fallen, been inserted, or liquids have been spilled into the enclosure through openings; or
  - c. The product has been exposed to rain; or
  - d. The product does not operate, exhibits a marked change in performance; or
  - e. The product has been dropped, or the enclosure of the product has been damaged.
- 13.** Do not attempt to service this product beyond that described in the user-maintenance instructions. All other servicing should be referred to qualified service personnel.
- 14.** This product, either alone or in combination with an amplifier and headphones or speaker/s, may be capable of producing sound levels that could cause permanent hearing loss. **DO NOT** operate for a long period of time at a high volume level or at a level that is uncomfortable. If you experience any hearing loss or ringing in the ears, you should consult an audiologist. **IMPORTANT:** The louder the sound, the shorter the time period before damage occurs.
- 15.** Some Yamaha products may have benches and/or accessory mounting fixtures that are either supplied as a part of the product or as optional accessories. Some of these items are designed to be dealer assembled or installed. Please make sure that benches are stable and any optional fixtures (where applicable) are well secured **BEFORE** using. Benches supplied by Yamaha are designed for seating only. No other uses are recommended.

## PLEASE KEEP THIS MANUAL

## FCC INFORMATION (U.S.A.)

### 1. **IMPORTANT NOTICE: DO NOT MODIFY THIS UNIT!**

This product, when installed as indicated in the instructions contained in this manual, meets FCC requirements. Modifications not expressly approved by Yamaha may void your authority, granted by the FCC, to use the product.

2. **IMPORTANT:** When connecting this product to accessories and/or another product use only high quality shielded cables. Cable/s supplied with this product **MUST** be used. Follow all installation instructions. Failure to follow instructions could void your FCC authorization to use this product in the USA.
3. **NOTE:** This product has been tested and found to comply with the requirements listed in FCC Regulations, Part 15 for Class "B" digital devices. Compliance with these requirements provides a reasonable level of assurance that your use of this product in a residential environment will not result in harmful interference with other electronic devices. This equipment generates/uses radio frequencies and, if not installed and used according to the instructions found in the users manual, may cause interference harmful to the operation of

other electronic devices. Compliance with FCC regulations does not guarantee that interference will not occur in all installations. If this product is found to be the source of interference, which can be determined by turning the unit "OFF" and "ON", please try to eliminate the problem by using one of the following measures:

Relocate either this product or the device that is being affected by the interference.

Utilize power outlets that are on different branch (circuit breaker or fuse) circuits or install AC line filter/s.

In the case of radio or TV interference, relocate/reorient the antenna. If the antenna lead-in is 300 ohm ribbon lead, change the lead-in to co-axial type cable.

If these corrective measures do not produce satisfactory results, please contact the local retailer authorized to distribute this type of product. If you can not locate the appropriate retailer, please contact Yamaha Corporation of America, Electronic Service Division, 6600 Orangethorpe Ave, Buena Park, CA90620

The above statements apply **ONLY** to those products distributed by Yamaha Corporation of America or its subsidiaries.

\* This applies only to products distributed by YAMAHA CORPORATION OF AMERICA.

(class B)

### IMPORTANT NOTICE FOR THE UNITED KINGDOM

#### Connecting the Plug and Cord

**IMPORTANT.** The wires in this mains lead are coloured in accordance with the following code:

BLUE : NEUTRAL  
BROWN : LIVE

As the colours of the wires in the mains lead of this apparatus may not correspond with the coloured markings identifying the terminals in your plug proceed as follows:

The wire which is coloured BLUE must be connected to the terminal which is marked with the letter N or coloured BLACK.

The wire which is coloured BROWN must be connected to the terminal which is marked with the letter L or coloured RED.

Making sure that neither core is connected to the earth terminal of the three pin plug.

(2 wires)

- This applies only to products distributed by Yamaha-Kemble Music (U.K.) Ltd.

**CAUTION:** TO PREVENT ELECTRIC SHOCK, MATCH WIDE BLADE OF PLUG TO WIDE SLOT, FULLY INSERT.

**ATTENTION:** POUR ÉVITER LES CHOCS ÉLECTRIQUES, INTRODUIRE LA LAME LA PLUS LARGE DE LA FICHE DANS LA BORNE CORRESPONDANTE DE LA PRISE ET POUSSER JUSQU' AU FOND.

(polarity)

- This applies only to products distributed by Yamaha Canada Music Ltd.
- Ceci ne s'applique qu'aux produits distribués par Yamaha Canada Musique Ltée.



For details of products, please contact your nearest Yamaha or the authorized distributor listed below.

Pour plus de détails sur les produits, veuillez-vous adresser à Yamaha ou au distributeur le plus proche de vous figurant dans la liste suivante.

Die Einzelheiten zu Produkten sind bei Ihrer unten aufgeführten Niederlassung und bei Yamaha Vertragshändlern in den jeweiligen Bestimmungsländern erhältlich.

Para detalles sobre productos, contacte su tienda Yamaha más cercana o el distribuidor autorizado que se lista debajo.

## NORTH AMERICA

### CANADA

**Yamaha Canada Music Ltd.**  
135 Milner Avenue, Scarborough, Ontario,  
M1S 3R1, Canada  
Tel: 416-298-1311

### U.S.A.

**Yamaha Corporation of America**  
6600 Orangethorpe Ave., Buena Park, Calif. 90620,  
U.S.A.  
Tel: 714-522-9011

## CENTRAL & SOUTH AMERICA

### MEXICO

**Yamaha de Mexico S.A. De C.V.,  
Departamento de ventas**  
Javier Rojo Gomez No.1149, Col. Gpe Del  
Moral, Deleg. Iztapalapa, 09300 Mexico, D.F.  
Tel: 686-00-33

### BRAZIL

**Yamaha Musical do Brasil LTDA.**  
Av. Rebouças 2636, São Paulo, Brasil  
Tel: 011-853-1377

### ARGENTINA

**Yamaha de Panamá S.A. Sucursal de Argentina**  
Viamonte 1145 Piso2-B 1053,  
Buenos Aires, Argentina  
Tel: 1-4371-7021

### PANAMA AND OTHER LATIN AMERICAN COUNTRIES/ CARIBBEAN COUNTRIES

**Yamaha de Panamá S.A.**  
Torre Banco General, Piso 7, Urbanización Marbella,  
Calle 47 y Aquilino de la Guardia,  
Ciudad de Panamá, Panamá  
Tel: 507-269-5311

## EUROPE

### THE UNITED KINGDOM

**Yamaha-Kemble Music (U.K.) Ltd.**  
Sherbourne Drive, Tilbrook, Milton Keynes,  
MK7 8BL, England  
Tel: 01908-366700

### IRELAND

**Danfay Ltd.**  
61D, Sallynoggin Road, Dun Laoghaire, Co. Dublin  
Tel: 01-2859177

### GERMANY/SWITZERLAND

**Yamaha Europa GmbH.**  
Siemensstraße 22-34, 25462 Rellingen,  
F.R. of Germany  
Tel: 04101-3030

### AUSTRIA

**Yamaha Music Austria**  
Schleiergasse 20, A-1100 Wien Austria  
Tel: 01-60203900

### THE NETHERLANDS

**Yamaha Music Nederland**  
Kanaalweg 18G, 3526KL, Utrecht, The Netherlands  
Tel: 030-2828411

### BELGIUM

**Yamaha Music Belgium**  
Keiberg Imperiastraat 8, 1930 Zaventem, Belgium  
Tel: 02-7258220

### FRANCE

**Yamaha Musique France,  
Division Claviers**  
BP 70-77312 Marne-la-Vallée Cedex 2, France  
Tel: 01-64-61-4000

### ITALY

**Yamaha Musica Italia S.P.A.**  
Viale Italia 88, 20020 Lainate (Milano), Italy  
Tel: 02-935-771

### SPAIN/PORTUGAL

**Yamaha-Hazen Electronica Musical, S.A.**  
Ctra. de la Coruna km. 17, 200, 28230  
Las Rozas (Madrid) Spain  
Tel: 91-201-0700

### GREECE

**Philippe Nakas S.A.**  
Navarinou Street 13, P.Code 10680, Athens, Greece  
Tel: 01-364-7111

### SWEDEN

**Yamaha Scandinavia AB**  
J. A. Wettergrens Gata 1  
Box 30053  
S-400 43 Göteborg, Sweden  
Tel: 031 89 34 00

### DENMARK

**YS Copenhagen Liaison Office**  
Generatorvej 8B  
DK-2730 Herlev, Denmark  
Tel: 44 92 49 00

### FINLAND

**F-Musiikki Oy**  
Kluuvikatu 6, P.O. Box 260,  
SF-00101 Helsinki, Finland  
Tel: 09 618511

### NORWAY

**Norsk filial av Yamaha Scandinavia AB**  
Grini Næringspark 1  
N-1345 Østerås, Norway  
Tel: 67 16 77 70

### ICELAND

**Skifan HF**  
Skeifan 17 P.O. Box 8120  
IS-128 Reykjavik, Iceland  
Tel: 525 5000

### OTHER EUROPEAN COUNTRIES

**Yamaha Europa GmbH.**  
Siemensstraße 22-34, 25462 Rellingen,  
F.R. of Germany  
Tel: 04101-3030

## AFRICA

**Yamaha Corporation,  
Asia-Pacific Music Marketing Group**  
Nakazawa-cho 10-1, Hamamatsu, Japan 430-8650  
Tel: 053-460-2312

## MIDDLE EAST

### TURKEY/CYPRUS

**Yamaha Europa GmbH.**  
Siemensstraße 22-34, 25462 Rellingen,  
F.R. of Germany  
Tel: 04101-3030

### OTHER COUNTRIES

**Yamaha Music Gulf FZE**  
LB21-128 Jebel Ali Freezone  
P.O.Box 17328, Dubai, U.A.E.  
Tel: 971-4-881-5868

## ASIA

### HONG KONG

**Tom Lee Music Co., Ltd.**  
11/F., Silvercord Tower 1, 30 Canton Road,  
Tsimshatsui, Kowloon, Hong Kong  
Tel: 2737-7688

### INDONESIA

**PT. Yamaha Music Indonesia (Distributor)  
PT. Nusantara**  
Gedung Yamaha Music Center, Jalan Jend. Gatot  
Subroto Kav. 4, Jakarta 12930, Indonesia  
Tel: 21-520-2577

### KOREA

**Yamaha Music Korea Ltd.**  
Tong-Yang Securities Bldg. 16F 23-8 Yoido-dong,  
Youngdungpo-ku, Seoul, Korea  
Tel: 02-3770-0661

### MALAYSIA

**Yamaha Music Malaysia, Sdn., Bhd.**  
Lot 8, Jalan Perbandaran, 47301 Kelana Jaya,  
Petaling Jaya, Selangor, Malaysia  
Tel: 3-703-0900

### PHILIPPINES

**Yupango Music Corporation**  
339 Gil J. Puyat Avenue, P.O. Box 885 MCPO,  
Makati, Metro Manila, Philippines  
Tel: 819-7551

### SINGAPORE

**Yamaha Music Asia Pte., Ltd.**  
11 Ubi Road #06-00, Meiban Industrial Building,  
Singapore  
Tel: 65-747-4374

### TAIWAN

**Yamaha KHS Music Co., Ltd.**  
10F, 150, Tun-Hwa Northroad,  
Taipei, Taiwan, R.O.C.  
Tel: 02-2713-8999

### THAILAND

**Siam Music Yamaha Co., Ltd.**  
121/60-61 RS Tower 17th Floor,  
Ratchadaphisek RD., Dindaeng,  
Bangkok 10320, Thailand  
Tel: 02-641-2951

### THE PEOPLE'S REPUBLIC OF CHINA AND OTHER ASIAN COUNTRIES

**Yamaha Corporation,  
Asia-Pacific Music Marketing Group**  
Nakazawa-cho 10-1, Hamamatsu, Japan 430-8650  
Tel: 053-460-2317

## OCEANIA

### AUSTRALIA

**Yamaha Music Australia Pty. Ltd.**  
Level 1, 99 Queensbridge Street, Southbank, Victoria  
3006, Australia  
Tel: 3-9693-5111

### NEW ZEALAND

**Music Houses of N.Z. Ltd.**  
146/148 Captain Springs Road, Te Papapa,  
Auckland, New Zealand  
Tel: 9-634-0099

### COUNTRIES AND TRUST TERRITORIES IN PACIFIC OCEAN

**Yamaha Corporation,  
Asia-Pacific Music Marketing Group**  
Nakazawa-cho 10-1, Hamamatsu, Japan 430-8650  
Tel: 053-460-2312

**HEAD OFFICE** Yamaha Corporation, Pro Audio & Digital Musical Instrument Division  
Nakazawa-cho 10-1, Hamamatsu, Japan 430-8650  
Tel: 053-460-3273



**Clavinova Web site (English only)**

<http://www.yamahaclavinova.com/>

**Yamaha Manual Library (English version only)**

<http://www2.yamaha.co.jp/manual/english/>