

YAMAHA MUSIC DISK RECORDER

MDR-3

(Exclusively for Electone Use)
(Nur für Verwendung mit Electone)
(Usage réservé exclusivement aux Electones)
(Exclusivamente para empleo en Electones)

USER'S GUIDE

BEDIENUNGSANLEITUNG

MODE D'EMPLOI

MANUAL DE INSTRUCCIONES

Thank you for purchasing the YAMAHA Music Disk Recorder MDR-3.

Developed as a dedicated peripheral device for the Yamaha Electone, the Music Disk Recorder MDR-3 is a MIDI-compatible performance recorder which offers the features below.

- Because the MDR-3 is a digital recorder that records performances using MIDI signals, it can produce very high-fidelity playback of your performances.
- In addition to the simultaneous recording of performances at multiple keyboards of the Electone, the MDR-3 can also record multiple parts independently and record such parts as obbligato or percussion.
- A specific part can be recorded during the playback of previously recorded parts.
- Besides Performance data, the MDR-3 can also record Registrations and various other types of data memorized at the Electone.
- During playback, MDR-3 can either play back all of the recorded parts as well as cancel the playback of selected parts.
- The buttons and indicator lamps of MDR-3 are arranged to correspond to the Electone's keyboards, so you check the part being recorded or played back at a glance.

To obtain the fullest use of the outstanding features of the MDR-3 under optimum operating conditions, please read through this User's Guide carefully.

Herzlichen Glückwunsch zum Kauf des Yamaha Music Disk Recorders MDR-3.

Der Music Disk Recorder MDR-3 ist eine MIDI-Recorder und wurde als speziell angepaßtes Peripheriegerät für die Yamaha-Electones entwickelt. Er hat die folgenden Merkmale.

- Da MDR-3 ein digital arbeitender Recorder zur Aufzeichnung von Spieldaten mit MIDI-Signalen ist, ermöglicht er HiFi-Wiedergabe Ihres Spiels.
- Neben der simultanen Aufnahme von Spiel auf mehreren Tastaturen des Electone ermöglicht der MDR-3 auch getrennte Aufzeichnung von mehreren Parts wie etwa Obligato oder Perkussion.
- Ein bestimmter Part kann während der Wiedergabe von vorher aufgezeichneten Parts aufgenommen werden.
- Außer Spieldaten kann MDR-3 auch Registrierungen und andere Gruppendaten des Electone aufzeichnen.
- Bei der Wiedergabe kann MDR-3 entweder alle aufgezeichneten Parts wiedergeben oder die Wiedergabe von bestimmten Parts löschen.
- Die Tasten und Anzeigelämpchen des MDR-3 sind so angeordnet, daß sie der Tastatur der Electones entsprechen. So können die aufgezeichneten oder wiedergegebenen Parts auf einen Blick erkannt werden.

Um die hervorragenden Merkmale des MDR-3 voll auszunutzen und das Gerät optimal einzusetzen, lesen Sie bitte diese Bedienungsanleitung sorgfältig durch.

Avant tout, merci d'avoir porté votre choix sur le l'enregistreur sur disque musical MDR-3 de YAMAHA.

Développé en tant de dispositif périphérique à usage exclusif pour les Electones Yamaha, cet enregistreur sur disque musical MDR-3 est un enregistreur de performance compatible MIDI, doté des caractéristiques suivantes.

- Du fait que le MDR-3 soit un enregistreur numérique qui enregistre des performances en employant des signaux MIDI, il est capable de reproduire très fidèlement les performances.
- En plus de la fonction d'enregistrement simultané des performances de plusieurs claviers d'Electone, le MDR-3 peut aussi enregistrer des parties indépendantes et les assigner en tant que partie obligée ou percussion.
- Il est possible d'enregistrer une partie spécifique pendant la lecture des parties précédemment enregistrées.
- En plus des données de performance, le MDR-3 peut également enregistrer des registres et autres types de données mémorisés dans l'Electone.
- Pendant la lecture, le MDR-3 peut tout aussi bien reproduire toutes les parties enregistrées que d'annuler la lecture de parties sélectionnées.
- L'agencement des touches et témoins du MDR-3 a été étudié pour correspondre aux claviers des Electones, de sorte qu'il soit possible de vérifier en un coup d'oeil la partie qui s'enregistre ou qui est reproduite.

Afin de faire bon usage des caractéristiques étonnantes du MDR-3 dans des conditions d'exploitation optimales, veiller à lire attentivement ce manuel de l'utilisateur.

Muchas gracias por la adquisición del grabador de discos musicales MDR-3 YAMAHA.

Desarrollado como dispositivo periférico dedicado para el Electone Yamaha, el grabador de discos musicales MDR-3 es un grabador de gran rendimiento compatible con MIDI que brinda las características siguientes.

- Como el MDR-3 es un grabador digital que graba empleando señales MIDI, puede ofrecer una reproducción de alta fidelidad de sus actuaciones.
- Además de la grabación simultánea de las actuaciones en los teclados múltiples del Electone, el MDR-3 puede grabar también independientemente partes múltiples y hacerlo como obbligato o percusión.
- Una parte específica podrá grabarse durante la reproducción de partes previamente grabadas.
- Además de datos de actuación, el MDR-3 puede grabar también registros y otros tipos de datos memorizados en el Electone.
- Durante la reproducción, el MDR-3 puede reproducir todas las partes grabadas así como cancelar la reproducción de partes seleccionadas.
- Los botones y lámparas indicadoras del MDR-3 están dispuestos para coincidir con los teclados del Electone, por lo que usted podrá comprobar de una ojeada la parte que esté grabando o reproduciéndose.

Para sacar el máximo partido de las notables características del MDR-3 en las condiciones óptimas de operación, lea cuidadosamente este manual de instrucciones.

CONTENTS

I. INTRODUCTION	Page
1. Handling Precautions	2
2. Connection Procedures	3
3. Messages at the Digital Display	3
4. Description of the Parts	4
5. Formatting a Disk	5
II. RECORDING	
1. Normal Recording	6
2. Part Recording	8
3. Recording the Lead Voice, Arpeggio Chord, and Keyboard Percussion Parts	10
4. Recording Registrations	13

III. PLAYBACK	
1. Normal Playback	14
2. Minus-One Playback	15
3. Repeated Playback	16
4. Other Playback Control	17
IV. OTHER OPERATIONS	
1. SONG COPY	18
2. SONG DELETE	19
● Recorded Data and Recording Channels	20
● Troubleshooting	21
● FCC Information	21
● MIDI Data Transferred during Recording/Playback	22
● Specifications	24
● MIDI Implementation Chart	25

INHALTSVERZEICHNIS

I. EINLEITUNG	Seite
1. Vorsichtsmaßnahmen zum Betrieb	2
2. Anschlüsse	3
3. Meldungen im Digitaldisplay	3
4. Beschreibung der Bedienungselemente	4
5. Formatieren von Disketten	5
II. AUFNAHME	
1. Normale Aufnahme	6
2. Aufnahme von Parts	8
3. Aufnahme von Lead Voice, Arpeggio Chord und Keyboard Percussion Parts	10
4. Aufnahme von Registrierungen	13

III. WIEDERGABE	
1. Normale Wiedergabe	14
2. Minus-One-Wiedergabe	15
3. Wiederholte Wiedergabe	16
4. Andere Wiedergabe-Einstellungen	17
IV. ANDERE BETRIEBSARTEN	
1. SONG COPY	18
2. SONG DELETE	19
● Aufgezeichnete Daten und Aufnahmekanäle	20
● Fehlersuche	21
● Bei Aufnahme/Wiedergabe übertragene MIDI-Daten	22
● Technische Daten	24
● MIDI Implementation Chart	25

TABLE DES MATIERES

I. INTRODUCTION	Page
1. Précautions	2
2. Connexions	3
3. Messages de l'affichage numérique	3
4. Description des commandes	4
5. Formattage de disque	5
II. ENREGISTREMENT	
1. Enregistrement ordinaire	6
2. Enregistrement partiel	8
3. Enregistrement des parties de la voix principale, des accords en arpegge et des percussions au clavier	10
4. Enregistrement des registres	13

III. LECTURE	
1. Lecture ordinaire	14
2. Lecture "moins un"	15
3. Lecture répétée	16
4. Autre réglage de lecture	17
IV. AUTRES OPERATIONS	
1. SONG COPY	18
2. SONG DELETE	19
● Données enregistrées et canaux d'enregistrement	20
● Guide de dépannage	21
● Données MIDI transférées pendant l'enregistrement/lecture	22
● Spécifications	24
● Schéma d'implantation MIDI	25

ÍNDICE

I. INTRODUCCIÓN	Página
1. Precauciones de manejo	2
2. Procedimientos de conexión	3
3. Mensajes del visualizador digital	3
4. Descripción de las partes	4
5. Formateo de un disco	5
II. GRABACIÓN	
1. Grabación normal	6
2. Grabación de partes	8
3. Grabación de las partes de la voz principal, acordes con arpeggio, y percusión del teclado	10
4. Grabación de registros	13

III. REPRODUCCIÓN	
1. Reproducción normal	14
2. Reproducción menos equis	15
3. Reproducción repetida	16
4. Otros controles de reproducción	17
IV. OTRAS OPERACIONES	
1. Copia de canciones	18
2. Borrado de canciones	19
● Datos grabados y canales de grabación	20
● Guía para la solución de problemas	21
● Datos de MIDI transferidos durante la grabación/reproducción	22
● Especificaciones	24
● Tabla de implementación de MIDI	25

I-1 Handling Precautions

Power Supply

- Make sure to use only the YAMAHA power adapter suitable for your area.
 - ▶ **USA, Canada, and Europe (except U.K.):** PA-3L or PA-4 (PA-40 for the USA).
 - ▶ **Other areas:** PA-4.
- In case of electrical storm probability, unplug the power cord from the electrical socket in advance.
- If you will not use the MDR-3 for a long period of time, unplug the power adapter from the electrical outlet.

Power Cord

- Be careful not to touch the power plug with wet hands; you may receive an electric shock.
- To prevent damage and short-circuiting of the cord wires, always hold the plug when unplugging the cord and never pull on the cord.

Connection

- Before connecting the MDR-3, make sure that the POWER switch of the Electone is turned OFF.
- Before transporting the MDR-3, make sure to disconnect its power cord and MIDI cables.

Handling

- Never remodel the MDR-3 nor disassemble its parts yourself. Such actions can cause serious damage to the MDR-3.
- Never subject the buttons and switches to unnecessary force.
- To prevent damage and short-circuiting of the cord wires, always hold the plug when unplugging the cord and never pull on the cord.
- If water accidentally enters inside the MDR-3, immediately turn OFF the POWER switch, unplug the power cord, and contact the Yamaha Music Dealer where you purchased this unit.

Choosing an Installation Site

- Avoid places exposed to direct sunlight.
- Avoid places exposed to excessive moisture, dust, and excessively low temperatures.

Cleaning the Outer Case

- Clean the outer case by wiping it with a soft, dry cloth.
- Never use thinner, benzine, chemically harsh solvents nor chemically-treated cloths.
- If the case is particularly dirty, moisten a soft, clean cloth in a mild detergent diluted with water, wring the cloth out well, then wipe off the soiled areas. Next, wipe the unit again with a dry cloth.

If the MDR-3 Operates Abnormally

- If the MDR-3 produces an abnormal odor or smoke, immediately unplug the power cord and contact the Yamaha Music Dealer where you purchased this unit.

Disk Compatibility

- Be sure to use only **3.5-inch doubled-sided double-density (2DD) microfloppy disks**. Other disk types are incompatible with the MDR-3 and may lead to mechanical failure, data errors, or other problems.
- Before recording a performance on a new disk, make sure to format that disk first. (→page 5)

Precautions on Microfloppy Disk Use

- Never open the disk's shutter. Dirt or dust on the internal magnetic surface will cause data errors.
- Never leave disks near a speaker, TV, or other device that emits a strong magnetic field.
- Do not store them in places exposed to direct sunlight or sources of high temperature.
- Do not place heavy objects, such as books or notebooks, on top of the disks.
- Avoid getting the disks wet by spilling water, etc.
- Make sure to store the disks within the below environment:
 - ▶ Storage temperature: 4° to 53°C (39° to 127°F)
 - ▶ Storage humidity: 8 to 90% RH
 - ▶ Location where disks are unlikely to be exposed to dust, sand, smoke, etc.
- Be sure to apply the label at the proper position. To change the label, never cover the old label with a new label; always remove the old label first.

The Write-Protect Tab

- **Write-Protect ON:** When the Write-Protect tab is moved toward the outside of the disk, data cannot be written to the disk so the current data will be protected.
- **Write-Protect OFF:** When the Write-Protect tab is moved toward the inside of the disk, data can be written to the disk.

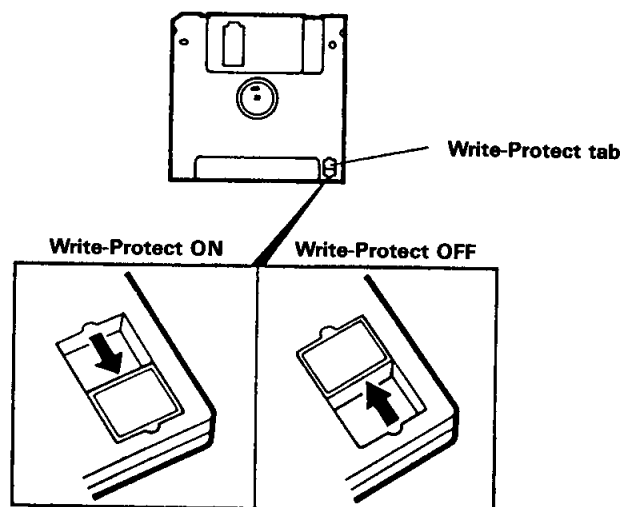

I-2 Connection Procedures

Input/Output Jacks on the Rear Panel

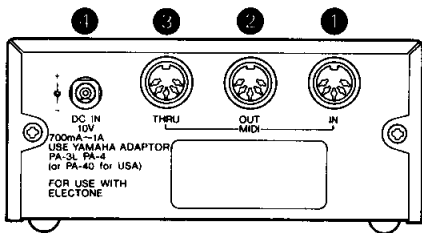

- ① **MIDI IN:** This jack receives the MIDI signals, and is connected to the Electone's MIDI OUT jack.
- ② **MIDI OUT:** This jack transmits the MIDI signals, and is connected to the Electone's MIDI IN jack.
- ③ **MIDI THRU:** This jack transfers the signals received at the MIDI IN jack without processing them. If you wish to transmit signals from the Electone to another device, such as a Voice Expander, connect this jack to the MIDI IN jack of that device.
- ④ **DC IN:** This jack is connected to the power adapter.

Basic Connection Procedure

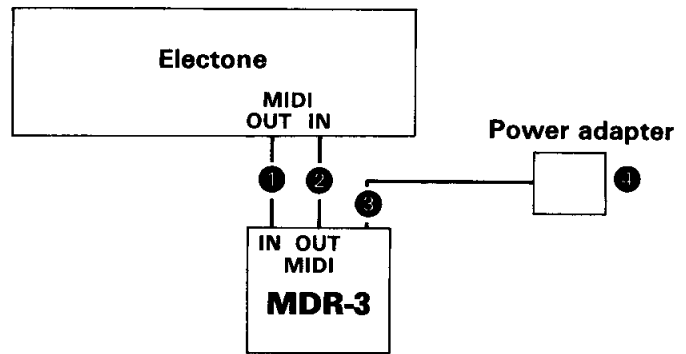

- ① Use the MIDI cable provided to connect [MIDI OUT] of the Electone to [MIDI IN] of the MDR-3.
- ② Use the MIDI cable provided to connect [MIDI IN] of the Electone to [MIDI OUT] of the MDR-3.
- ③ Connect the power adapter to [DC IN] of the MDR-3.
- ④ Plug the power adapter into an electrical outlet.

I-3 Messages at the Digital Display

If an operation is improperly performed or some other error occurs, one of the messages below will appear at the Digital Display. If a message appears, correct the situation as described in the table below.

Display	Description of the Messages
1n5t	No disk is installed. Install a disk.
F0t t	The installed disk is not formatted. Format the disk. (→page 5)
P t o t	① The installed disk is write-protected, so the Record, Song Copy, and Song Delete jobs cannot be performed. Set the disk's Write-Protect tab to the OFF position. (→page 2) ② If you are using a copy-protected playback-only disk, this message may appear when the MIDI cables are not securely connected, when you try to perform recording, Song Copy, or Song Delete, or when you try to copy the files of that copy-protected disk to another disk.
FULL	① The disk's memory capacity is full, so the Record or Song Copy job cannot be performed. Install another formatted disk. ② Data is already recorded at all Song Nos., so the Song Copy job cannot be performed. Press [STOP], then delete any unnecessary songs. ③ When you attempt to record a part, this message will appear if there is not enough remaining memory to record the part.
EP t Y	No Song Nos. are recorded with data, so the Song Copy job cannot be performed. Press [STOP].
c F 0 1	An error occurred because the disk was removed during recording or playback. Press [STOP], then start the job over again.
c F 0 2	The installed disk cannot be played back at MDR-3. Press [STOP], then insert a compatible disk.
c F 0 6	Recording cannot be performed because an excessively large amount of MIDI data was received at the same time. Press [STOP].
c F 0 7	The disk is bad and cannot be formatted. Press [STOP], then install another disk.
c F 0 8	An error occurred during the transmission or reception of MIDI signals. Press [STOP].
c F 0 9	An error occurred at the MDR-3 internal memory (RAM). Press [STOP]; then turn the MDR-3 POWER switch OFF then back ON again. If this same error message reappears even after MDR-3 is turned back ON, your MDR-3 requires repair so contact your Yamaha Music Dealer.

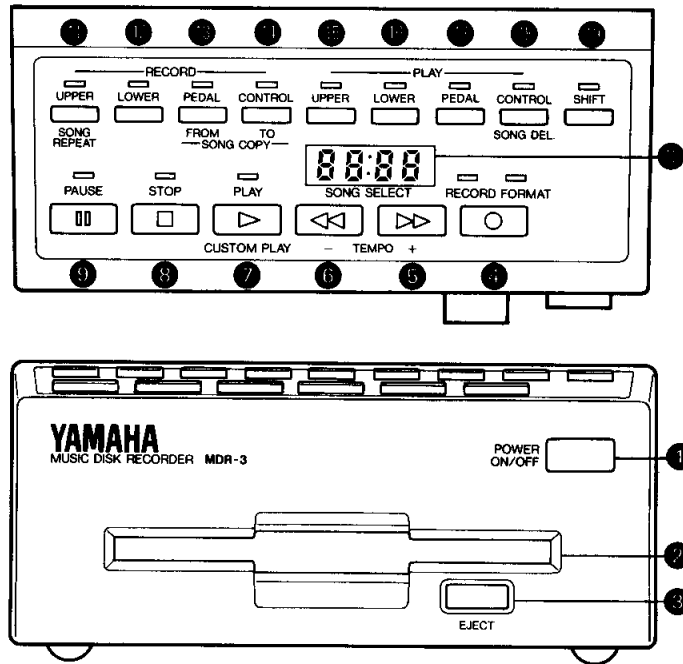

① **[POWER ON/OFF]**: This switch controls the ON/OFF status of the power supply to the MDR-3. During recording or playback, never turn OFF the power.

② **Disk drive door**: A 3.5-inch microfloppy disk (2DD) is inserted through this door to be driven by the disk drive.

③ **[EJECT] button**: Press this button to eject an installed disk from the disk drive.

④ **[RECORD]/[FORMAT]**: To begin recording, press this button first. By holding down [SHIFT] while you press this button, you can format a disk.

⑤ **[SONG SELECT/TEMPO +]/[>>]**: Press this button to increase the Song No. By holding down [SHIFT] while you press this button, you can speed up the tempo of playback. If the button pressed during playback, the disk is advanced to a later position in the performance at high speed.

⑥ **[SONG SELECT/TEMPO -]/[<<]**: Press this button to decrease the Song No. By holding down [SHIFT] while you press this button, you can slow down the tempo of playback. If this button is pressed during playback, the disk is reversed to a previous position in the performance at high speed.

⑦ **[PLAY]/[CUSTOM PLAY]**: When this button is pressed in STOP status, MDR-3 begins transmitting Registrations and other data currently memorized at the Electone then performs playback of the performance. If it is pressed after pressing [RECORD] (while the RECORD lamp is lit), MDR-3 begins receiving Registrations and other data as well as recording your performance. By holding down [SHIFT] while you press this button, the playback or recording of only your performance is begun.

⑧ **[STOP]**: Press this button to stop recording or playback.

⑨ **[PAUSE]**: During playback, press this button if you wish to temporarily stop playback.

● **Digital Display**: This display indicates the Song No. in STOP status, the amount of available memory during recording, or the time elapsed during playback. At other times, it indicates the current status, messages, and other information.

■ [RECORD] Section

● **[UPPER]/[SONG REPEAT]**: When this button is turned ON during recording, your performance on the Upper Keyboard is recorded. By holding down [SHIFT] while you press this button, playback of a song can be repeated (SONG REPEAT).

● **[LOWER]**: When this button is turned ON during recording, your performance on the Lower Keyboard is recorded.

● **[PEDAL]/[SONG COPY FROM]**: When this button is turned ON during recording, your performance on the Pedal Keyboard is recorded. By holding down [SHIFT] while you press this button, you can select the source Song No. that you wish to copy.

● **[CONTROL]/[SONG COPY TO]**: When this button is turned ON during recording, the data of the Expression Pedal or other control data is recorded. By holding down [SHIFT] while you press this button, you can select the destination Song No. to which the source Song No. will be copied.

■ [PLAY] Section

● **[UPPER]**: If this button is ON when playback or recording is started, the recorded performance of the Upper Keyboard is played back.

● **[LOWER]**: If this button is ON when playback or recording is started, the recorded performance of the Lower Keyboard is played back.

● **[PEDAL]**: If this button is ON when playback or recording is started, the recorded performance of the Pedal Keyboard is played back.

● **[CONTROL]/[SONG DEL.]**: If this button is ON when playback or recording is started, the recorded data of the Expression Pedal or other controller is recalled to MDR-3. By holding down [SHIFT] while you press this button, you can delete a song.

● **[SHIFT]**: While this button is held down, if you press a button labelled with two functions, the lower function that is labelled in green can be selected.

I-5 Formatting a Disk

Before recording a performance at MDR-3, you must first follow the steps below to format the disk you plan to use.

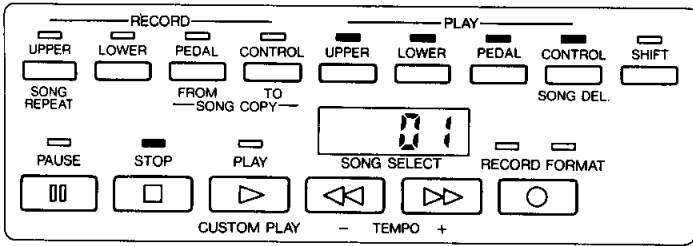

① Turn ON the POWER switch.

When MDR-3 is turned ON, the STOP lamp lights up and the STOP status is entered, as shown in the figure on the left.

NOTE: If a formatted disk is already installed, press [EJECT] to remove that disk.

NOTE: When you install a disk that was not formatted for use with MDR-3 then attempt to perform recording or other jobs, "Fort" appears at the Digital Display to prompt you to format that disk.

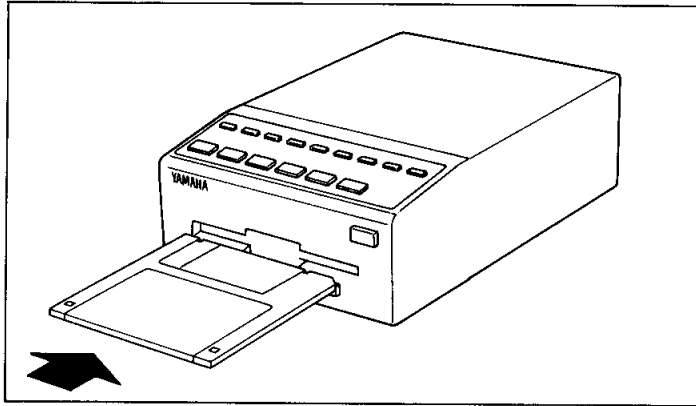

② Install the disk to be formatted.

Install the unformatted disk (or a disk that has not been formatted for use with MDR-3) with its label facing up, as shown on the left, then insert it straight into the disk drive until it locks into place.

NOTE: Before inserting the disk, make sure the disk's Write-Protect tab is set to OFF.

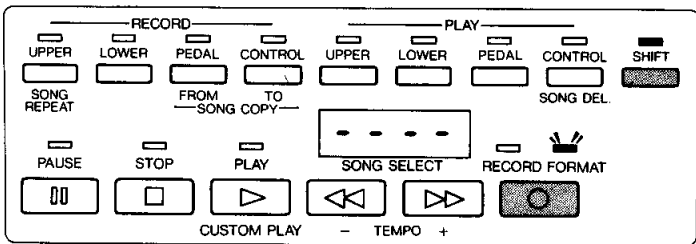

③ While holding down [SHIFT], press [FORMAT].

"----" appears at the Digital Display to indicate that formatting can be performed and the FORMAT lamp begins blinking.

CAUTION: If you format a disk that contains previously recorded data, that data will all be erased. If you pressed [SHIFT]+[FORMAT] by mistake, press [STOP] to cancel the formatting job.

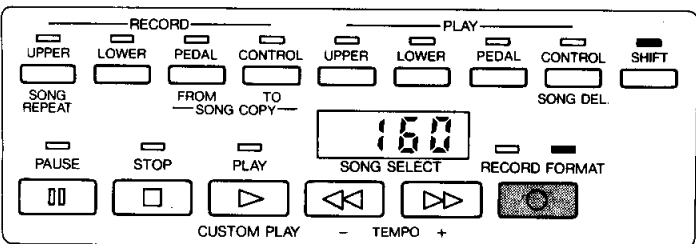

④ Press [FORMAT].

When the FORMAT lamp stops blinking and remains lit, formatting is begun. "160" appears at the Digital Display as soon as formatting is started, then the Digital Display counts down to "001".

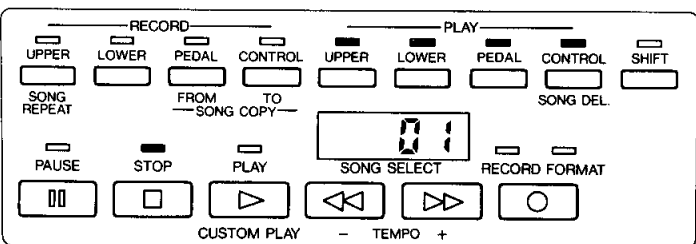

⑤ When formatting is completed, the STOP status is automatically entered.

When formatting is completed, the FORMAT lamp goes off and STOP status is resumed. At the Digital Display, Song No. "01" appears.

II-1 Normal Recording

By simply pressing the [RECORD] button followed by the [PLAY] button, you can record a performance at the Electone and/or record Registrations and other data currently memorized at the Electone.

① Set the Registration and other functions at the Electone.

Register the data of all the Registrations required for your performance in Registration Memory, including the data of the first Registration to be used in your song.

NOTE: During normal recording, the Registrations and other data memorized at the Electone will be recorded at MDR-3 as soon as recording is started. For details on the data that can be recorded by MDR-3, see page 20.

② Turn ON the POWER switch of MDR-3, then install a formatted disk (→page 5).

Turn ON MDR-3, then install a formatted disk (→page 5). As shown on the right, "01" appears at the Digital Display to indicate that Song No. 01 is currently selected.

③ Use [SONG SELECT] to select the Song No. to be recorded.

You can select a Song No. from 01 to 16. Use the [SONG SELECT] buttons to change the numeral at the Digital Display and select the desired Song No.

▶ **[+]:** Each time [+] is pressed, the Song No. is increased by one, and returns to "01" after "16".

▶ **[-]:** Each time this button is pressed, the Song No. is decreased by one, and returns to "16" after "01".

④ Press [RECORD].

The RECORD lamp lights up to indicate that recording can be performed, and the PLAY lamp begins blinking.

NOTE: While [RECORD] is ON, the parts that will be recorded are indicated by lit lamps at the RECORD section. Whenever MDR-3 is turned ON, the lamps of all parts from [UPPER] to [CONTROL] will be lit; this indicates that a regular performance at the Electone can be recorded exactly as it is performed.

NOTE: If the selected Song No. already contains recorded data, the Song No. at the Digital Display will blink to attract your attention. (→page 7)

⑤ Press [PLAY].

The PLAY lamp lights up, then the Registrations and other data which are currently memorized at the Electone are recorded first. During this time, a "-" mark moves from left to right at the Digital Display to indicate that the Registrations and other data are being recorded.

NOTE: The time required to record Registrations and other data will vary with the Electone model and the type of data currently memorized at the Electone. (→page 20)

NOTE: If you do not wish to record the Registrations and other data, you can start recording by performing a Custom Play job instead. (→pages 8 to 10)

ELECTONE

● Register the required Registrations in the Registration Memory.

* Register the required Registrations in Registration Memory, including the Registration to be used first.

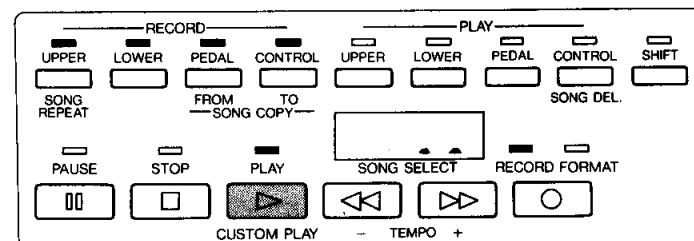
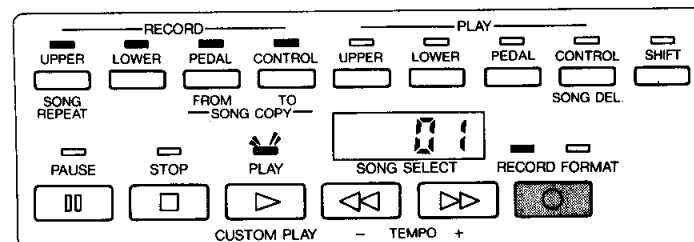
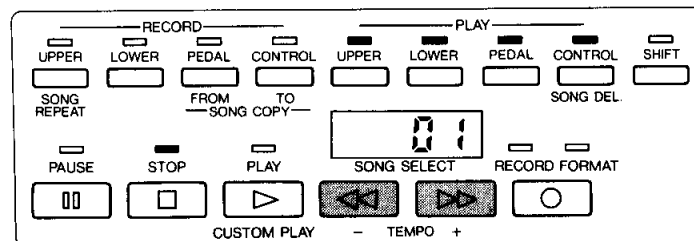
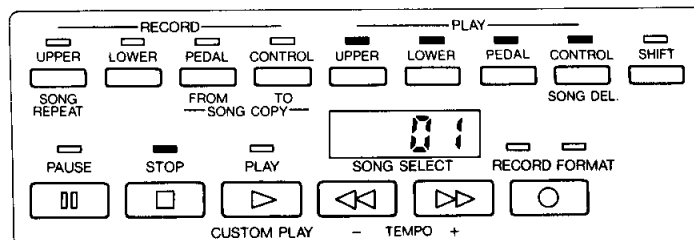

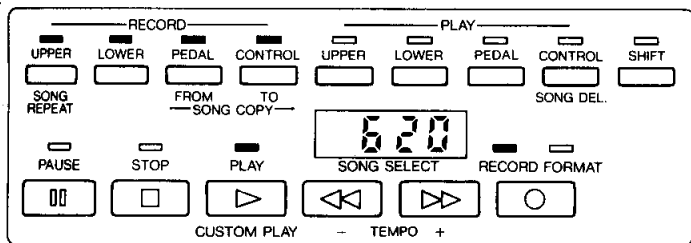

- ⑥ After numerals appear at the Digital Display, press the numeric button of Registration Memory that will recall the Registration to be used at the beginning of the song, and then start your performance.

When the recording of Registrations and other data is completed, numerals indicating the available memory on the disk will appear at the Digital Display. At this point, start your performance at the Electone.

The performances at each keyboard, control by the Expression Pedal, selection of different Registrations of the Registration Memory, starting/stopping of the rhythm, and other operations at the Electone panel will be recorded exactly as they are executed. (→page 20)

NOTE: If you intend to use rhythm, start the rhythm after the available memory display appears at the Digital Display.

NOTE: The numeric value (in kilobyte units) indicating the available memory gradually decreases as recording is being performed. The maximum memory capacity of one disk is 634k bytes.

- ⑦ When you finish performing, press [STOP].

When [STOP] is pressed, both the RECORD and PLAY lamps go out, then STOP status is resumed. If you press [PLAY] in this status, you can play back the performance that you have just recorded.

NOTE: When the available memory is displayed as "008" or lower, the numerals begin blinking to attract your attention. If this happens, stop the recording before the display reaches "000".

CAUTION: During recording, never turn OFF the POWER switch of MDR-3 nor press the EJECT button.

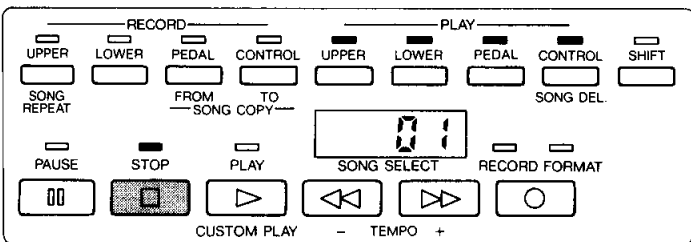

If the selected Song No. already contains recorded data

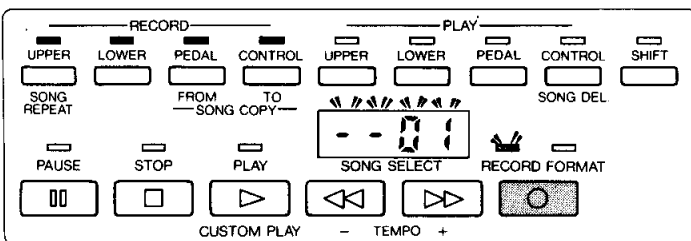

Whenever you select a Song No. that already contains recorded data then press [RECORD], "--" appears at the leftmost columns of the Digital Display (as shown on the left) and will blink along with the Song No. to attract your attention.

▶ To cancel recording: Press [STOP].

▶ To record your performance to another Song No.: Use [SONG SELECT] to change the Song No.

▶ To record your performance to the current Song No.: When you press [RECORD] again, the RECORD lamp remains lit and recording can be performed. When you perform normal recording of new data to a Song No. that already contains data, note that the original data will be replaced by the new data.

To end recording and start your performance again (Retry)

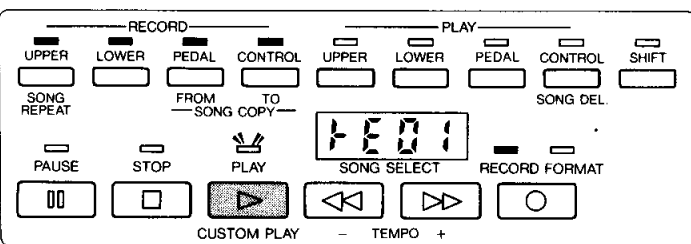

If you make a mistake during recording, you can start recording over again by pressing [STOP], deleting the data recorded for the currently selected Song No., then pressing [RECORD] once more. The procedure below, however, is an easier way to start recording your performance over again.

- ① Press [PLAY] during recording.

When you press [PLAY] during recording, recording is stopped and you are returned to the beginning of the disk. "rE" (retry) appears at the leftmost columns of the Digital Display and the PLAY lamp begins blinking.

- ② Press [PLAY] once more, then start recording over again.

The PLAY lamp remains lit and the available memory display immediately appears at the Digital Display. At this point, start your performance from the beginning to record it over again. The previously recorded performance will be replaced by the recording of the new performance.

NOTE: If you press [STOP] without pressing [PLAY] again, the previously recorded Performance data will not be erased.

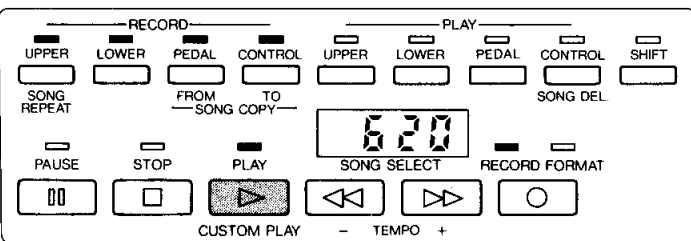

II-2 Part Recording

The performances of individual parts can be independently recorded. As an example, this section describes the steps for recording the accompaniment first and the melody second.

① At the Electone, set the required Registrations and other panel settings.

Register the data of all Registrations you will require for the accompaniment and melody in the Registration Memory, including the data of the first Registration to be used in your song.

② Install a disk at MDR-3, then select a Song No. that contains no recorded data.

For details on this step, see page 6.

ELECTONE

- Register the required Registrations in the Registration Memory.
- * Register the required Registrations in Registration Memory, including the Registration to be used first.

MDR-3

- Turn ON the POWER switch, then install a disk.
- Select the Song No. to which you will record your performance.

Recording the Accompaniment

③ Press [RECORD].

When the RECORD lamp lights up, you can use the buttons at the RECORD section to select the parts to be recorded. Because the accompaniment will be recorded first in this example, check that the LOWER, PEDAL, and CONTROL lamps are lit. (The status of the [UPPER] button makes no difference here, so its lamp may be on or off.)

NOTE: [UPPER], [LOWER], and [PEDAL] respectively correspond to the Upper, Lower, and Pedal Keyboards. [CONTROL] is used to record changes in the Expression Pedal, Registration Memory selection, and other Control data. (→page 20)

④ Press [PLAY].

The PLAY lamp lights up, and the Registrations and other data are recorded first. While this data is being recorded, a “_” mark moves from left to right at the Digital Display. When recording of this data is completed, the available memory display appears.

⑤ After numerals appear at the Digital Display, begin recording your accompaniment.

After the available memory display appears at the Digital Display, begin playing the Lower and Pedal Keyboards to record the accompaniment.

NOTE: If you wish to use the rhythm, start the rhythm after the numerals appear at the Digital Display, then begin performing the accompaniment. In case the rhythm is to be used, insert an Intro pattern at the start of the rhythm; when you later record the melody, the Intro pattern will help you accurately determine when to start performing the melody. If necessary, also use Fill In and Ending patterns. (→page 20)

NOTE: It is also possible to program Rhythm sequences, Chord sequences, and/or Registration changes to the C.S.P. and/or R.S.P. of an HS Series Electone (or to the Sequencer of an HX Series Electone) in advance, then record that pre-programmed data at MDR-3.

NOTE: AUTO BASS CHORD can also be used for recording the accompaniment.

NOTE: If you need to make the volume louder or softer, use the Expression Pedal. To switch to another Registration, press the corresponding numeric button of Registration Memory at the desired moment.

⑥ After you finish recording the accompaniment, press [STOP].

The STOP status is resumed, and the Song No. appears at the Digital Display.

NOTE: If you wish to perform the accompaniment over again, press [RECORD] then repeat the recording of your performance using the same settings. If you press [PLAY] instead of [STOP], the Retry function allows you to immediately begin recording over again. (→page 7)

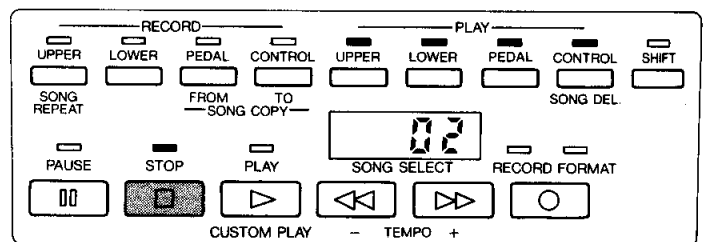
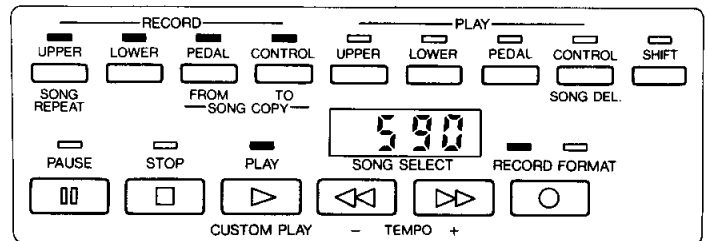
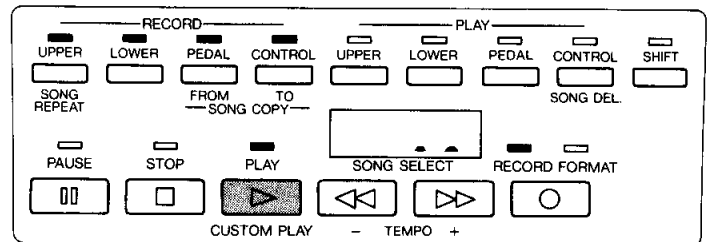
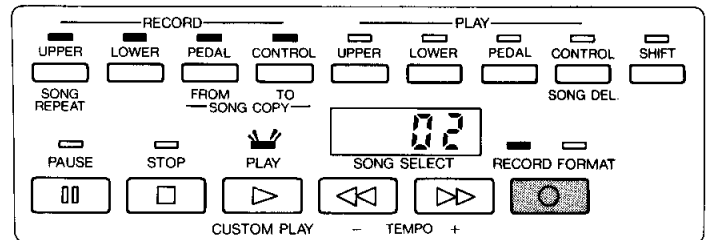

Recording the Melody

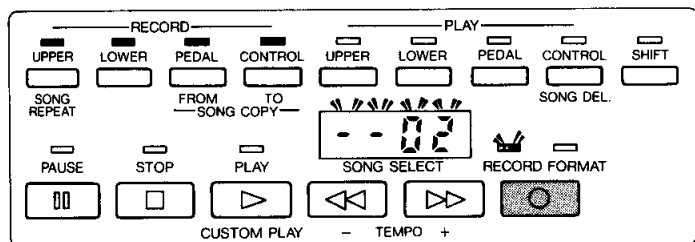

⑦ Press [RECORD].

After you finish recording the accompaniment, press [RECORD]. Since the Song No. contains the recorded data of the accompaniment, "--" appears at the leftmost columns of the Digital Display and blinks along with the Song No. to warn you that the selected Song No. already contains recorded data.

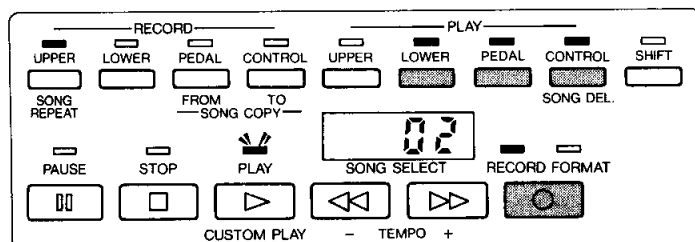

⑧ Press [RECORD] again, then turn ON [LOWER], [PEDAL], and [CONTROL] at the PLAY section.

To play back the recorded parts, turn ON [LOWER], [PEDAL], and [CONTROL] at the PLAY section. The LOWER, PEDAL, and CONTROL parts at the RECORD section will automatically be turned OFF.

NOTE: While [RECORD] is ON, the parts of the PLAY section that have lit lamps can be played back during recording. Note that any RECORD section part corresponding to a PLAY section part with a lit lamp is turned OFF so that its previously recorded performance will not be erased during the recording of another part.

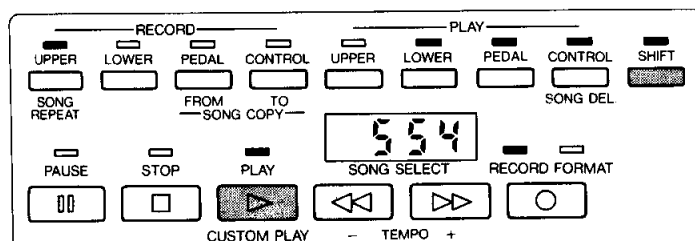

⑨ While holding down [SHIFT], press [CUSTOM PLAY].

When you start recording by pressing [SHIFT]+[CUSTOM PLAY], the available memory display immediately appears at the Digital Display and the playback of the previously recorded part is begun.

NOTE: If recording is started by pressing only [PLAY], the Registrations and other data will be recorded again, so you will have to wait until the available memory display reappears. By starting recording by pressing [SHIFT]+[CUSTOM PLAY], you can begin recording your performance immediately.

⑩ Play the Upper Keyboard and begin recording the melody.

While listening to the part being played back, start performing the melody at the proper timing. If you have recorded an Intro pattern, time the start of your performance to begin after the playback of the Intro pattern.

NOTE: The length of a subsequently recorded part cannot exceed the length of the previously recorded part(s).

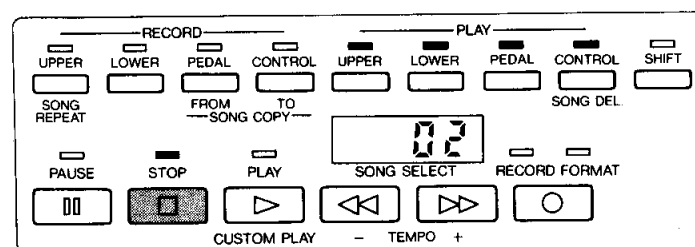

⑪ After you finish recording the melody, press [STOP].

The STOP status is resumed and the Song No. appears at the Digital Display. If you press [PLAY] in this status, you can play back both of the parts you have recorded.

NOTE: If you wish to perform the melody over again, repeat the recording using the same settings. If you press [PLAY] instead of [STOP], the Retry function allows you to immediately begin recording over again. (→page 7)

NOTE: When recording multiple parts, the parts can be recorded in any sequence. You can also separately record the LOWER part and PEDAL part, then record the Expression Pedal changes, Registration changes, and other control data separately as the CONTROL part. In addition to recording the UPPER, LOWER, and PEDAL parts, you can also record the part of a Lead Voice, Arpeggio Chord Voice (the data of only the pressed keys), and a rhythm accompaniment using Keyboard Percussion. (→pages 10 to 12)

Separately from the UPPER, LOWER, and PEDAL parts, you can also record the part of a Lead Voice, Arpeggio Chord accompaniment (the data of only the pressed keys), and a rhythm accompaniment using Keyboard Percussion. If you will be using these parts, attach the auxiliary operation sheet provided onto the MDR-3 panel.

Recording an Obligato Part using the Lead Voice

- 1 Set the Electone so that the Lead Voice will be sounded from its Upper Keyboard.

At the UPPER ENSEMBLE section, turn ON the LEAD button then select a Lead Voice and set its volume level. If using multiple Registrations, memorize the necessary Registrations to Registration Memory.

- 2 Assign a separate Receiving Channel for the Lead Voice.

To assign a separate Receiving Channel, perform the operation described on the right at your Electone.

NOTE: In case of normal recording in which the Lead Voice is set as the Voice of the Upper (or Lower) Keyboard, you need not perform the procedure on the right nor the steps below.

- 3 Record all of the other parts first. (→pages 6 to 9)

After pressing [RECORD], press [PLAY] to record all of the other parts except the Lead Voice. At this time, the Receiving Channel for the Lead Voice is separated, so the Lead Voice will not be sounded. When recording is completed, press [STOP].

NOTE: If you are using HS-8 and wish to record a Lead Voice while controlling its pitch by Pitch Bend, hold down [EXTERNAL/MIDI CONTROL] while you press [4]. Now, proceed to Step 4.

- 4 When you are ready to begin recording the Lead Voice, press [RECORD].

Since the Song No. contains the recorded data of the other parts, "--" appears at the leftmost columns of the Digital Display and blinks along with the Song No.

- 5 Press [RECORD] again, then turn ON all the buttons of the PLAY section.

After turning ON [RECORD], turn ON all parts at the PLAY section so that the previously recorded parts will be played back while you record the Lead Voice. All parts of the RECORD section will be automatically turned OFF.

- 6 Hold down [SHIFT] while you turn ON [UPPER] at the RECORD section.

To begin recording your Lead Voice performance, hold down [SHIFT] while you turn ON [UPPER] at the RECORD section.

NOTE: When this step is performed, the Channel No. of the Performance data of the Electone's Upper Keyboard is changed to a different Channel No., enabling the Lead Voice performance to be separately recorded at MDR-3. Note that as soon as you release [SHIFT], [UPPER] at the RECORD section will automatically be turned OFF. (→page 20)

NOTE: Before starting recording, press some keys at the Upper Keyboard to make sure the Lead Voice is sounded.

- 7 To record your performance at the Upper Keyboard using the Lead Voice, hold down [SHIFT] while you press [CUSTOM PLAY].

Starting recording by pressing [SHIFT]+[CUSTOM PLAY] causes the playback of all previously recorded parts to begin immediately, so perform the obligato part (or other lead part) at the Upper Keyboard while listening to the playback. The Lead Voice performance will be recorded separately from your performance at the Upper Keyboard (the UPPER part). When you finish performing, press [STOP].

HS Series: Display the MULTI MENU 10 display, then hold down [EXTERNAL/MIDI CONTROL] while you press [1]. (→page 76 in the "HS USER'S GUIDE")
HX Series: Using the Basic Channel function of MIDI Control, set [IN] of [4.LEAD] to "4". (→page 69 in the "HX USER'S GUIDE")

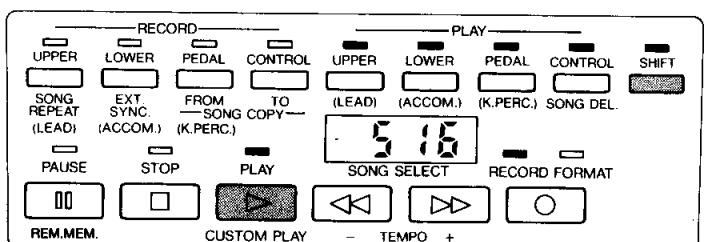
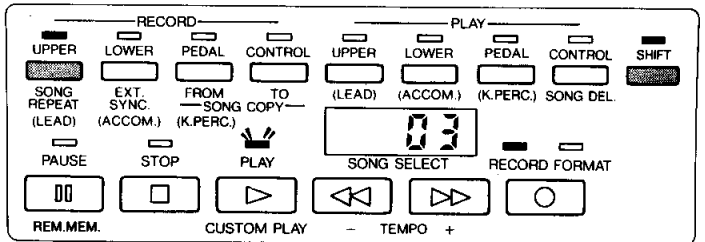
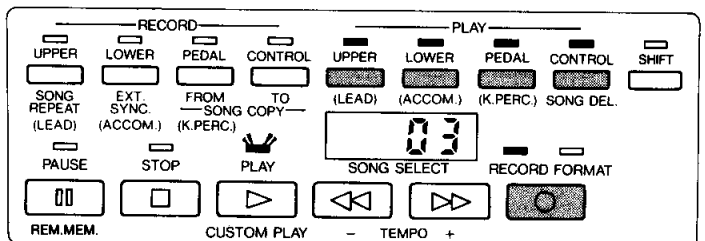
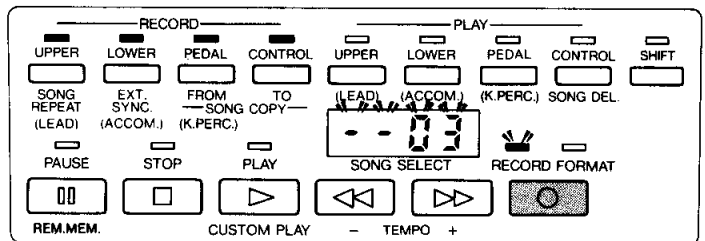
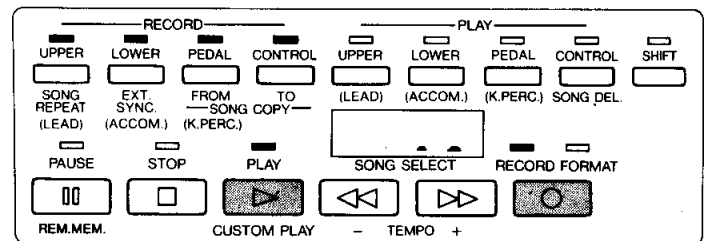

Recording a Part Using an ARPEGGIO CHORD Voice (HS Series)

HS Series: Display the MULTI MENU 10 display, then hold down [EXTERNAL/MIDI CONTROL] while you press [2]. (→page 76 in the "HS USER'S GUIDE")

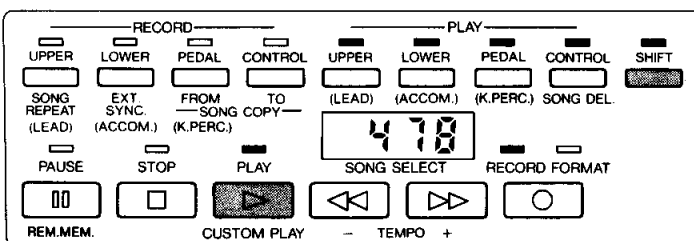
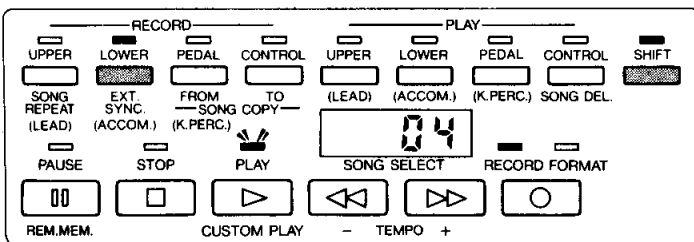
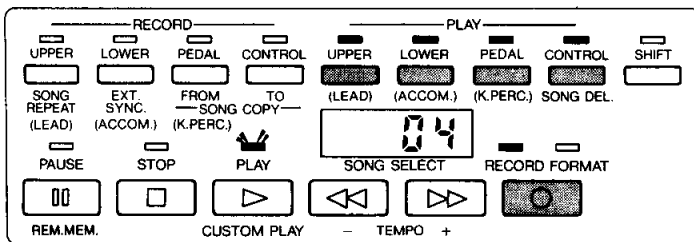
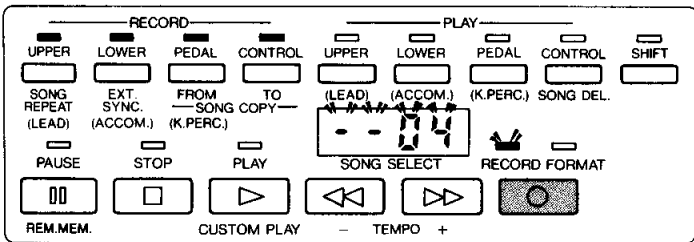
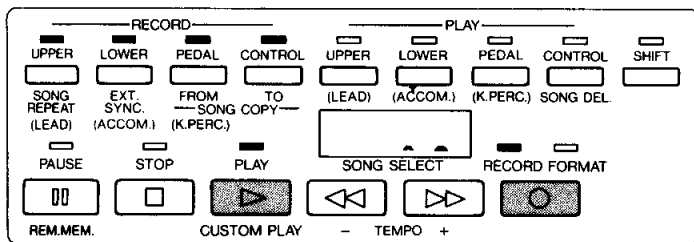

- 1 Set the HS Series Electone so that the Arpeggio Chord Voice will be sounded from its Lower Keyboard.

Select the Arpeggio Chord Voice and set its volume level. If using multiple Registrations, memorize the necessary Registrations to Registration Memory.

- 2 At the HS Series Electone, assign a separate Receiving Channel for the Arpeggio Chord Voice.

To assign a separate Receiving channel, perform the operation described on the left.

NOTE: In case of normal recording in which the Arpeggio Chord Voice is set as the Voice of the Lower Keyboard, you need not perform the procedure on the left nor the steps below.

NOTE: With the HX Series, it is not possible to play back a Chord Accompaniment performance on a different Channel No. from the Lower Keyboard performance.

- 3 Record all of the other parts first. (→pages 6 to 9)

After pressing [RECORD], press [PLAY] to record all of the other parts except the Arpeggio Chord Voice. At this time, the Receiving Channel for the Arpeggio Chord Voice is separated, so the Arpeggio Chord Voice will not be sounded. When recording is completed, press [STOP].

- 4 When you are ready to begin recording the Arpeggio Chord Voice, press [RECORD].

Since the Song No. contains the recorded data of the other parts, "--" appears at the leftmost columns of the Digital Display and blinks along with the Song No.

- 5 Press [RECORD] again, then turn ON all the buttons of the PLAY section.

After turning ON [RECORD], turn ON all parts at the PLAY section so that the previously recorded parts will be played back while you record the Arpeggio Chord Voice. All parts of the RECORD section will be automatically turned OFF.

- 6 Hold down [SHIFT] while you turn ON [LOWER] at the RECORD section.

To begin recording your Arpeggio Chord performance, hold down [SHIFT] while you turn ON [LOWER] at the RECORD section.

NOTE: When this step is performed, the Channel No. of the Performance data of the Electone's Lower Keyboard is changed to a different Channel No., enabling the Arpeggio Chord Voice performance to be separately recorded at MDR-3. Note that as soon as you release [SHIFT], [LOWER] at the RECORD section will automatically be turned OFF. (→page 20)

NOTE: Before starting recording, press some keys at the Lower Keyboard to make sure the Arpeggio Chord Voice is sounded.

- 7 To record your performance on the Lower Keyboard, hold down [SHIFT] while you press [CUSTOM PLAY].

Starting recording by pressing [SHIFT]+[CUSTOM PLAY] causes the playback of all previously recorded parts to begin immediately, so perform at the Lower Keyboard while listening to the playback. The Arpeggio Chord Voice performance will be recorded separately from your performance at the Lower Keyboard (the LOWER part). When you finish performing, press [STOP].

NOTE: If you record your performance on the Lower Keyboard according to the above steps, the Arpeggio Chord Voice will be sounded independently of the rhythm so your exact performance will be recorded.

Recording a Rhythm Part Using Keyboard Percussion

① At the Electone, perform the settings required for recording a Keyboard Percussion part.

First of all, perform the operations described on the right.

NOTE: In case you wish to record the basic Rhythm patterns using the Rhythm function and record only the variation patterns as a Keyboard Percussion part, create the basic Rhythm patterns in advance then program the Rhythm sequence to R.S.P. of the HS Series Electone (or the Sequencer for an HX Series Electone).

② Press [RECORD], then hold down [SHIFT] while you turn ON [PEDAL] at the RECORD section.

After turning ON [RECORD], hold down [SHIFT] while you turn ON [PEDAL] at the RECORD section in order to record your Keyboard Percussion performance.

NOTE: When this step is performed, the Performance data of the Lower and Pedal Keyboards will be recorded to MDR-3 over separate channels from the LOWER and PEDAL parts. (→page 20) And as soon as [SHIFT] is released, the LOWER and PEDAL parts at the RECORD section are automatically turned OFF.

③ To start recording your Keyboard Percussion performance, hold down [SHIFT] while you press [CUSTOM PLAY].

If you have an HS Series Electone, play the Lower Keyboard to record the Keyboard Percussion performance. With an HX Series Electone, play the keys that have been assigned with rhythm instruments by the Keyboard Percussion Assign function.

NOTE: In case you have programmed a Rhythm sequence and wish to record the rhythm together with your Keyboard Percussion performance, start the rhythm then add the desired Keyboard Percussion sounds at the required moments.

④ At the Electone, perform the settings required for recording the other parts.

After your finish recording the Keyboard Percussion part, perform the appropriate operations on the right at the Electone in order to record the other parts.

⑤ Press [RECORD] twice.

If you wish to play back only the recorded Keyboard Percussion sound after pressing [RECORD] twice, hold down [SHIFT] while you turn ON [PEDAL] at the PLAY section.

⑥ Press [PLAY], then record the other parts.

Record the Registrations and other data then, while listening to the previously recorded rhythm, record the performance of the other parts besides Keyboard Percussion.

NOTE: During the playback of song that has been recorded with a Keyboard Percussion part, the recorded Keyboard Percussion performance will be played back although the the Keyboard Percussion lamp will be OFF at the Electone's panel.

NOTE: If you wish to record another part while listening to the playback of the rhythm pattern programmed at the R.S.P., turn on [R.S.P. PLAY] before you start the rhythm.

HS Series

- Turn OFF the Keyboard Percussion function.
- Also turn OFF all other Voice Sections.

HX Series

- Turn ON the Keyboard Percussion function.
- Turn OFF all other Voice Sections.
- Use the Basic Channel function to set [OUT] of [LK] to "OFF". (→page 69 in the "HX USER'S GUIDE")

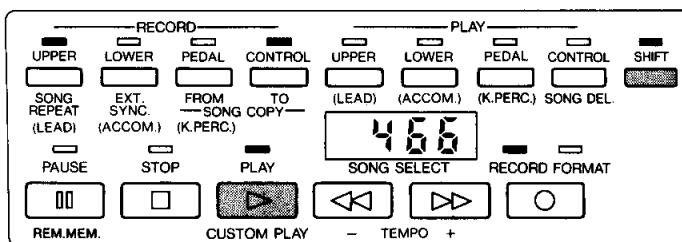
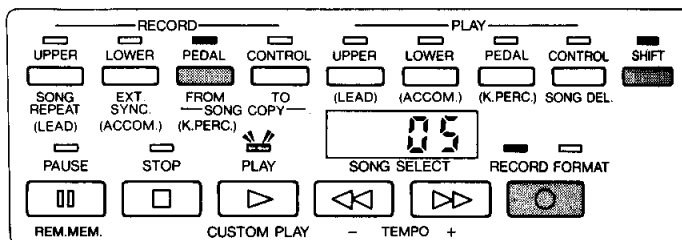

HS Series

- Turn ON all other Voice Sections, except Keyboard Percussion.

HX Series

- Turn OFF the Keyboard Percussion function.
- Turn ON all other Voice Sections.
- Use the Basic Channel function to reset [OUT] of [LK] to "2".

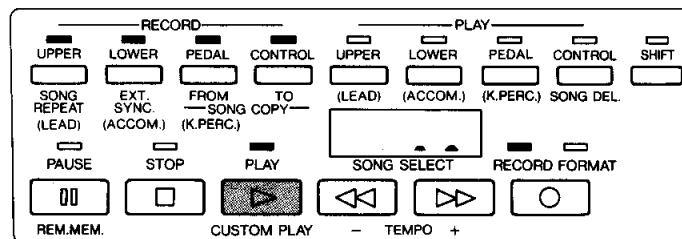
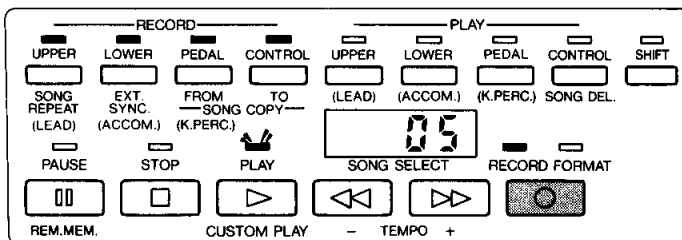

II-4 Recording Registrations

Recording the Registrations (Using MDR-3 in place of a RAM Pack)

By following the steps below, you can also record only the Registrations without recording a performance.

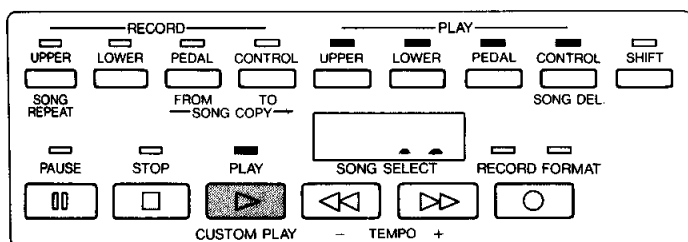
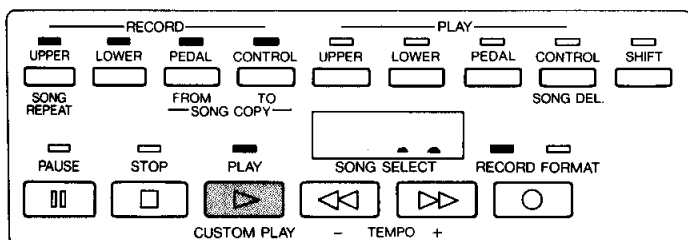
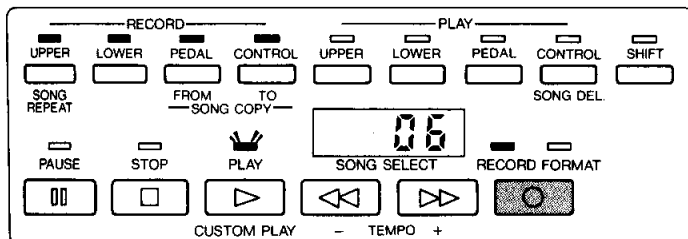

- 1 At the Electone, memorize the Registrations and other data that you wish to record at MDR-3.

For information on the contents of the Registrations and other data that can be recorded at MDR-3, see page 20.

- 2 Select a Song No. for which you wish to record the Registrations, then press [RECORD].

If the selected Song No. already contains recorded data, “_ _” appears at the leftmost columns of the Digital Display and blinks along with the Song No. In this case, use [SONG SELECT] to select another Song No.

- 3 Press [PLAY] to record the Registrations, then press [STOP] when the “_” mark begins moving.

After pressing [PLAY], press [STOP] as soon as the “_” mark begins moving across the Digital Display. “_ _ _ _” begins blinking to indicate that the Registrations and other data are being recorded. When recording is completed, the STOP status is automatically resumed.

How to Transmit the Recorded Registrations

Select a Song No. that contains only the recorded data of Registrations and other non-performance data, then press [PLAY]. A “_” mark moves from left to right at the Digital Display to indicate that the recorded data is being transmitted to the Electone. When transmission of the data is completed, MDR-3 automatically resumes STOP status. (This same status is entered after Registration and other non-performance data have been read from a RAM Pack.) Press a Registration Memory button to set the desired Registration, then begin your performance.

Replacing Only the Registrations

After performing a normal recording, if you wish to use the same Performance data but substitute different Registrations, perform the steps below.

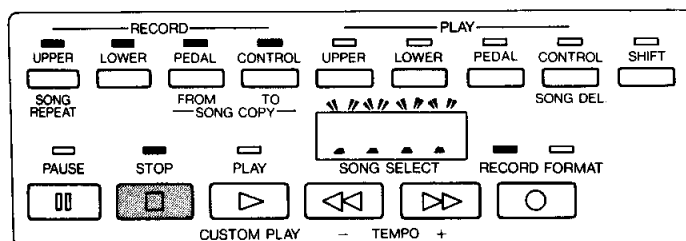
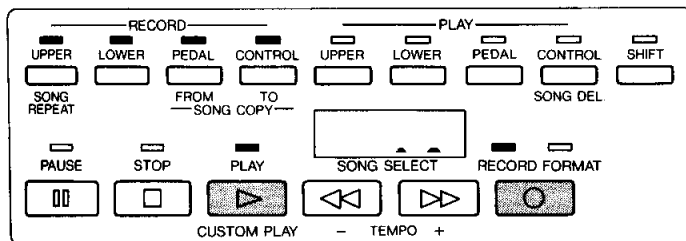

- 1 At the Electone, register the new data of the first and/or subsequent Registrations that you wish to substitute.

- 2 After selecting the Song No. for which you wish to replace the Registrations, press the numeric button of Registration Memory that corresponds to the Registration to be used at the beginning of the song. Next, press [RECORD] twice, then press [PLAY].

A “_” mark moves across the Digital Display and the previously recorded Registrations and other non-performance data are erased to allow MDR-3 to record the new Registrations that were memorized in Step 1 above.

- 3 Before the available memory display appears at the Digital Display, press [STOP].

Press [STOP] while the “_” mark is still moving across the Digital Display. “_ _ _ _” begins blinking at the Digital Display to indicate that the Registrations and other non-performance data are being received by MDR-3 from the Electone. When reception is completed, MDR-3 automatically resumes STOP status.

III-1 Normal Playback

You can play back your recorded Electone performance by simply pressing [PLAY]. Registrations and other data will also be recalled to the Electone.

① Select the Song No. to be played back.

A Song No. from 01 to 16 can be selected. Use the [SONG SELECT] buttons to change the numeral at the Digital Display and select the desired Song No.

▶ [+]: Each time [+] is pressed, the Song No. is increased by one, and returns to "01" after "16".

▶ [-]: Each time this button is pressed, the Song No. is decreased by one, and returns to "16" after "01".

NOTE: In STOP status, the parts that can be played back are indicated by lit lamps at the PLAY section. Whenever MDR-3 is turned ON, the lamps of all parts from [UPPER] to [CONTROL] will be lit; this indicates that a regular performance at the Electone can be played back.

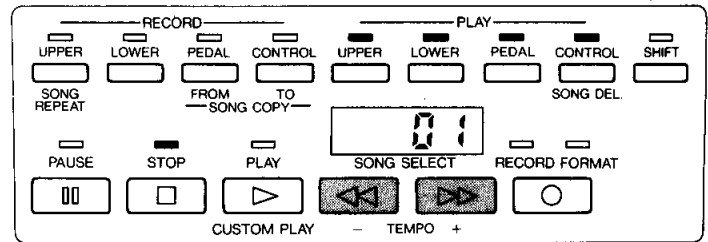

② Press [PLAY].

The PLAY lamp lights up, then the Registrations and other data are transmitted from MDR-3 to the Electone first. During this time, a "_" mark moves from left to right at the Digital Display to indicate that the Registrations and other data are being transmitted to the Electone.

NOTE: The time required to transmit Registrations and other data will be identical to the time that was required during recording. (→page 6)

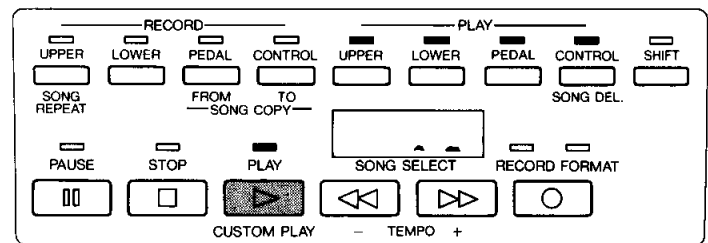

③ The time appears at the Digital Display, and playback of the performance is started.

When the transmission of Registrations and other data is completed, numerals indicating the elapsed playback time appear at the Digital Display and playback is started.

NOTE: Playback of the performance may not always start immediately after the playback time appears at the Digital Display. During recording, if some time passed after the available memory display appeared at the Digital Display and before you began performing, the start of playback will also be delayed for the same amount of time.

CAUTION: During playback, never turn OFF the POWER switch of MDR-3 nor press the EJECT button.

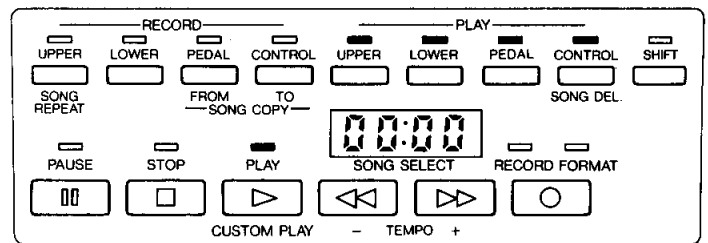

[Stopping Playback]

When the recorded performance is played back until its end, playback is automatically stopped and MDR-3 resumes STOP status.

To stop playback before the end of the performance, press [STOP] and MDR-3 immediately resumes STOP status.

In either of the above cases, you can restart playback from the beginning by pressing [PLAY] again (or pressing [SHIFT]+[CUSTOM PLAY]).

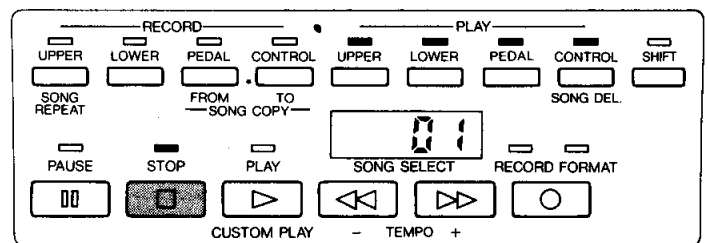

[CUSTOM PLAY: For Playback of Only the Performance]

If you wish to play back only the performance without the Registrations and other data, start playback by holding down [SHIFT] while you press [CUSTOM PLAY].

When [SHIFT]+[CUSTOM PLAY] are pressed, the playback time immediately appears at the Digital Display, then the playback of the performance is started.

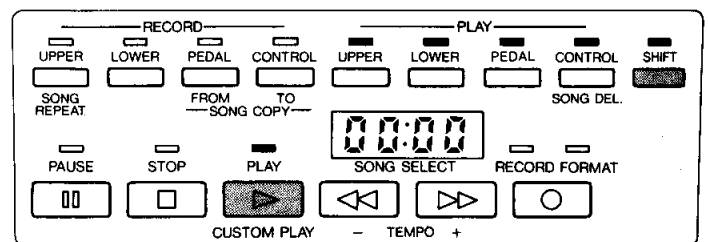

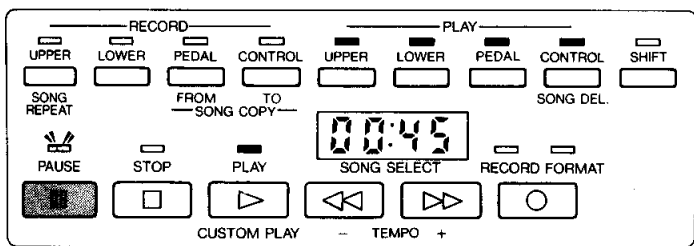

[PAUSE: To Temporarily Stop Playback]

By pressing [PAUSE] during playback, you can temporarily stop the playback. While playback is in PAUSE status, the PAUSE lamp blinks and the playback time at the Digital Display does not advance.

To cancel PAUSE status, press [PAUSE] once more and playback will be resumed from the point at which it was stopped.

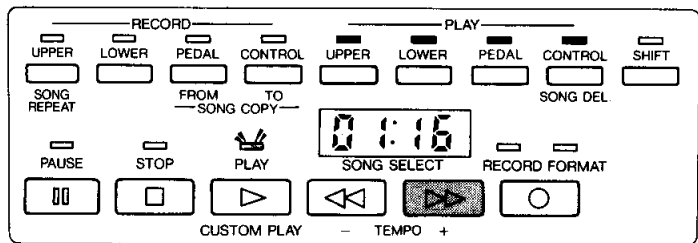

[Fast Forward and Fast Reverse Operations]

During playback, press [FF] to advance to a later position in the performance or press [RR] to return to an earlier position. While [FF] or [RR] is held down, playback is discontinued but the playback time at the Digital Display is advanced or reversed according to the song position; to locate the desired position in the performance, hold down either button until the playback time at which you wish to begin playback appears at the Digital Display.

MDR-3 enters PAUSE status when the button is released, so next press [PLAY]. Playback is then started from the position corresponding to the time shown at the Digital Display.

NOTE: The speed of a Fast Forward or Fast Reverse operation is five times faster than normal playback speed.

III-2 Minus-One Playback

This feature allows you to play back the recorded parts of a performance so that the playback of only specific parts will be cancelled.

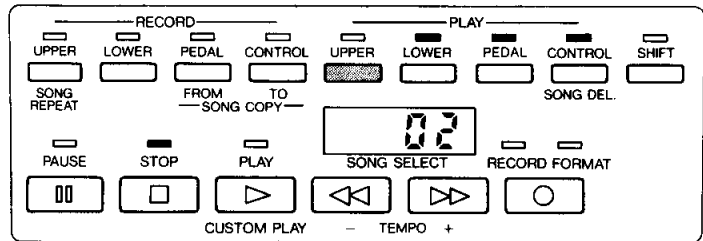

① Select the Song No. to be played back, then turn OFF any part for which playback is to be cancelled.

In STOP status, turn OFF any PLAY section part among [UPPER] to [CONTROL] for which you want to cancel playback. (In the example on the left, [UPPER] is turned OFF to cancel the playback of the Upper Keyboard performance.)

NOTE: The playback of any number of parts can be cancelled.

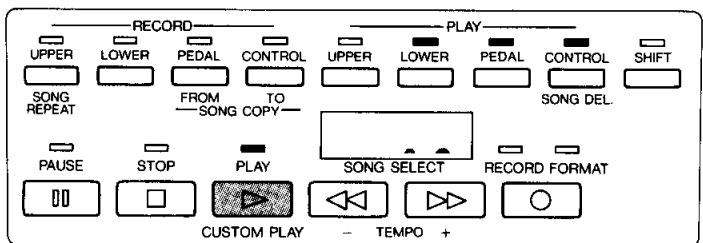

② Press [PLAY].

The PLAY lamp lights up, then the Registrations and other data are transmitted from MDR-3 to the Electone first. When the transmission of this data is completed, playback of the performance — minus the UPPER part that was turned OFF in Step ① — is started.

③ Perform the cancelled part at the Electone.

Now try playing the cancelled part at the Electone along with the minus-one playback. (In this case, play the Upper Keyboard part.)

When the playback reaches the end of the recorded performance, playback is automatically stopped and STOP status is resumed.

*During the playback of a performance that was recorded while using the C.S.P., the tempo of the rhythm may be abnormal in certain cases. To avoid this, before you start recording, make sure that the panel Registration is identical to the first Registration programmed at the C.S.P.

III-3 Repeated Playback

This feature allows you repeatedly play back all the songs recorded on the disk or only a specific recorded song.

① Select a Song No.

First of all, use [SONG SELECT] to select a Song No.

► **For repeated playback of all songs:** Select the Song No. of the first song you wish to play back.

► **For repeated playback of one song:** Select the Song No. of the song you wish to play back.

NOTE: If necessary, also select the parts that you wish to be repeatedly played back.

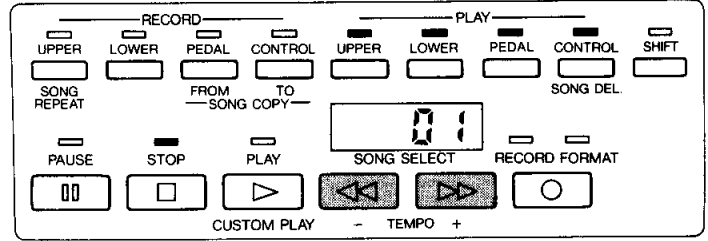

②-① Hold down [SHIFT] while you press [SONG REPEAT].

The SHIFT and SONG REPEAT lamps light up, then "ALL" appears at the Digital Display. For repeated playback of all songs, press [PLAY] in this status.

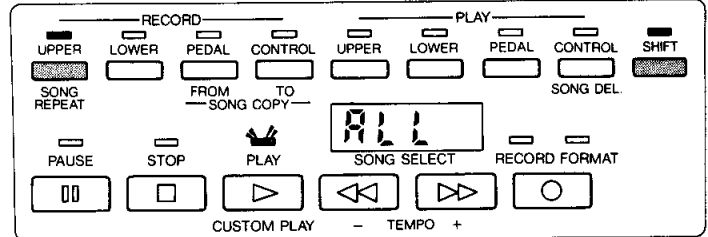

②-② To repeat playback of a single song, hold down [SHIFT] while you press [SONG REPEAT] again.

"Sing" appears at the Digital Display to indicate that repeated playback of only a single song can be performed.

NOTE: To cancel the Song Repeat mode at this point, press [STOP].

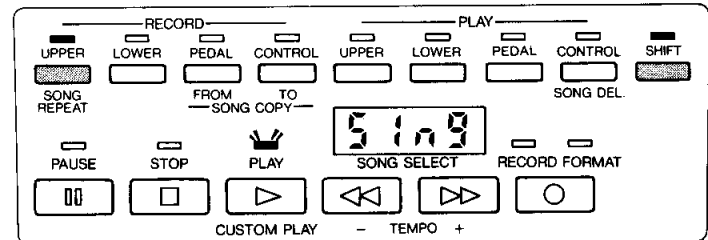

③ Press [PLAY].

First of all, the Song No. to be played back is displayed, then the Registrations and other data are transmitted to the Electone. During transmission, a "_" mark moves across the Digital Display. When transmission is completed, the playback time display appears and the playback of the performance is started.

► **The repeated playback of all songs:** When the playback of the first song is completed, the Song No. of the next song to be played back is displayed, its Registrations and other data are transmitted, then that song is played back. Similarly for subsequent songs, only the Song Nos. that contain recorded data are located, then consecutively transmitted and played back.

► **The repeated playback of one song:** When the song is played back until its end, the same Song No. is displayed, its Registrations and other data are re-transmitted, then playback is repeated.

NOTE: If you press [SHIFT] + [CUSTOM PLAY] to start playback instead of pressing [PLAY], you can repeatedly playback only the performance.

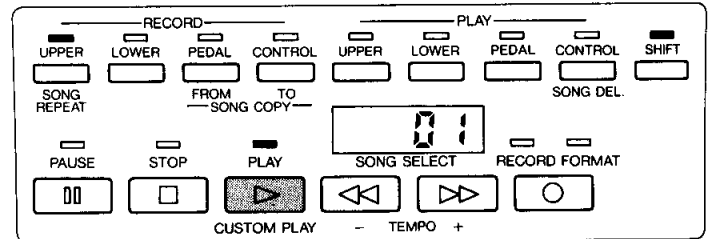

④ Press [STOP].

To discontinue repeated playback, press [STOP]. The PLAY lamp goes out and STOP status is resumed.

NOTE: In case of repeated playback of a single song, if the selected Song No. contains no recorded data, "00:00" appears at the Digital Display then STOP status is resumed. In case of repeated playback of all songs, if none of the Song Nos. on the disk contain recorded data, "00:00" appears at the Digital Display then STOP status is resumed.

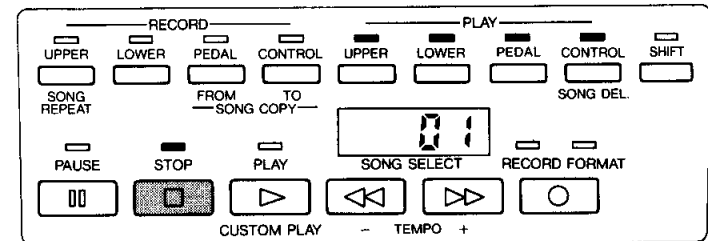

III-4 Other Playback Control

Changing the Playback Tempo

To change the tempo of the playback, follow the steps below.

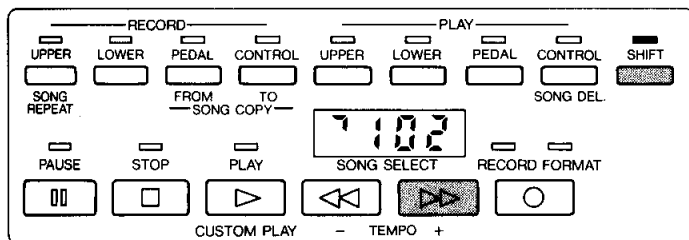

[Changing the Tempo of Playback]

► **To speed up the tempo:** Hold down [SHIFT] while you press [TEMPO +]. Each time you press [TEMPO +], the playback tempo becomes faster.

► **To slow down the tempo:** Hold down [SHIFT] while you press [TEMPO -]. Each time you press [TEMPO -], the playback tempo becomes slower.

NOTE: When the playback tempo is changed as above, numerals appear briefly at the Digital Display. This value represents the changed tempo as a percentage of the recording tempo ("100"). If the tempo is increased, this value will be greater than 100; if decreased, it will be lower than 100.

NOTE: The range in which the playback tempo can be changed is approximately 50% to 200%, but varies with the type of Electone connected to MDR-3.

NOTE: Changing the tempo will not change the pitch of the music being played back.

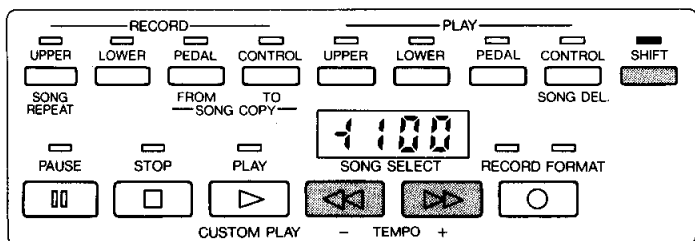

[Restoring the Original Recording Tempo]

After the playback tempo has been changed, you may wish to restore the original tempo used during recording. In this case, hold down [SHIFT] while you simultaneously press [TEMPO +] and [TEMPO -]; "100" will briefly appear at the Digital Display, indicating that the recording tempo has been restored.

NOTE: A change in the playback tempo remains valid even if the Song Nos. are changed. If you wish to change the tempo for the playback tempo of a single song, perform the step above as soon as the playback of that song is finished to restore the recording tempo.

Switching to External Sync Mode

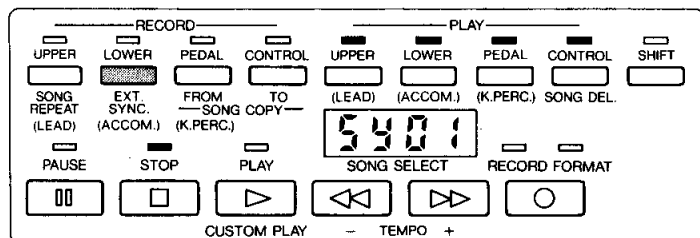

Whenever MDR-3 is turned ON, it is initially set to Internal Sync mode. In case you have connected a rhythm sequencer or similar device and wish to synchronize MDR-3 with the tempo of that device, perform the step below.

► **To switch to External Sync mode:** Hold down [LOWER] at the RECORD section while you turn ON the POWER switch.

CAUTION: If you perform normal recording or playback in External Sync mode, the tempo may go out of sync. For performing normal recording or playback, therefore, do not switch to External Sync mode. (You may wish to play back a performance recorded at MDR-3 at the same tempo in which it was recorded. Before starting to record, in this case, set the tempo of the device which will be transmitting the MIDI clocks to MDR-3 to the tempo of ♩ = 156.)

NOTE: While MDR-3 is in External Sync mode, its recording or playback will be synchronized with the MIDI clocks of the connected device. (The ME Series does not support MDR-3's External Sync mode.)

NOTE: To restore Internal Sync mode, either hold down [SHIFT] while you press [LOWER] at the RECORD section (the LOWER lamp goes out) or turn OFF the MDR-3 POWER switch.

Controlling the Start/Stop of Playback from the Electone

Performing the procedure below has the same effect as pressing [PLAY] at MDR-3. That is, the PLAY lamp lights up, Registrations and other data are transmitted to the Electone, then playback is started.

► **HS Series:** Display the MULTI MENU 10 display, then hold down [EXTERNAL/MIDI CONTROL] while you press [LEAD/DELAY] at the extreme left position.

► **HX Series:** Display "4.EXT. CONTROL" at the MULTI MENU, press [ENTER], then press SUB DATA CONTROL button [1].

To discontinue playback before it is finished, perform the procedure below. MDR-3 will resume STOP status just as when its [STOP] button is pressed.

► **HS Series:** Hold down [EXTERNAL/MIDI CONTROL] while you press [LEAD/DEPTH] at the second from the left position.

► **HX Series:** Press SUB DATA CONTROL button [2].

IV-1 SONG COPY

This function lets you copy the data recorded at a Song No. to another Song No.

[To Copy the Data of Song No. 07 to Song No. 09]

① Use [SONG SELECT] to select the source Song No. of the Song Copy job.

Use [SONG SELECT] to display the source Song No. that contains the recorded data you wish to copy at the Digital Display.

NOTE: Before recording a specific part over again or other similar cases, you can protect the previously recorded performance by copying the recorded Performance data to a different Song No.

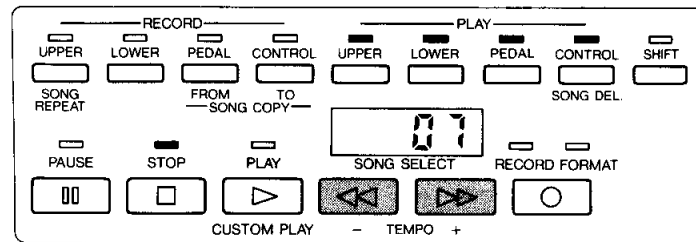

② Hold down [SHIFT] while you press [SONG COPY FROM].

The Song No. you selected in Step ① appears at the two leftmost columns of the Digital Display as the source Song No. And "--" is displayed at the two rightmost columns of the Digital Display to indicate that the destination Song No. has not yet been specified.

NOTE: If the Song No. selected in Step ① contains no recorded data, MDR-3 automatically searches for and displays the next Song No. (in numeric order) which contains recorded data.

NOTE: Even after completing Step ②, you can still use [SONG SELECT] to select a different source Song No.

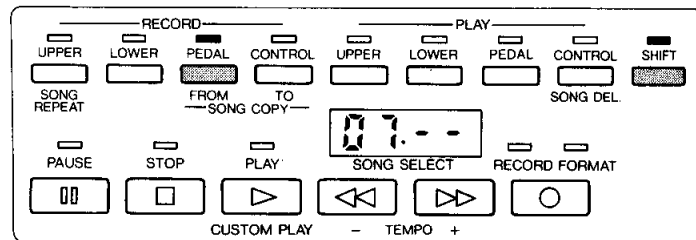

③ Hold down [SHIFT] while you press [SONG COPY TO].

MDR-3 automatically searches for a Song No. that contains no recorded data, and displays its number at the two rightmost columns of the Digital Display as the destination Song No.

NOTE: If all Song Nos. already contain recorded data, "FULL" appears at the Digital Display. The Song Copy job cannot be executed in this case, so press [STOP] then perform the Song Delete job to erase the data of any unnecessary Song Nos. (→page 19)

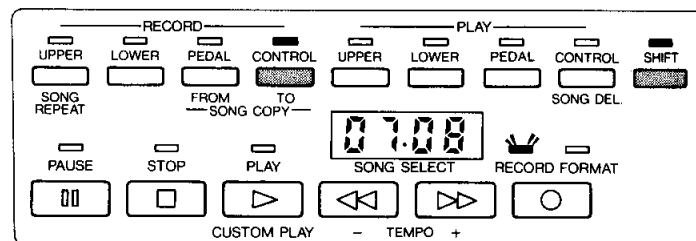

④ Use [SONG SELECT] to select the destination Song No. of the Song Copy job.

If you wish to select a different destination Song No. than the one that is displayed, use [SONG SELECT]. MDR-3 will only search for Song Nos. that contain no recorded data and display them sequentially at the two rightmost columns of the Digital Display.

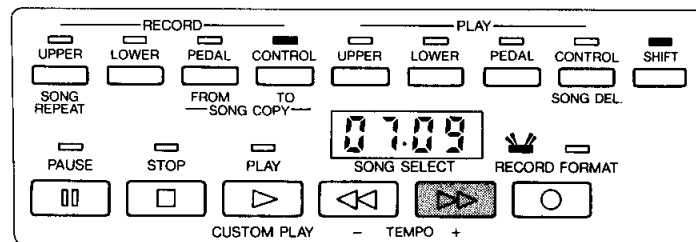

⑤ Press [RECORD].

The RECORD lamp stops blinking and remains lit, then the Song Copy job is executed. The Digital Display displays the file size of the source Song No. as a numeric value which decreases as the Song data is copied. When the displayed value reaches "000", the Song Copy job is completed and STOP status is automatically resumed.

NOTE: If the disk has no available memory at the time the Song Copy procedure is performed, "FULL" appears at the Digital Display to indicate that the Song Copy job cannot be executed.

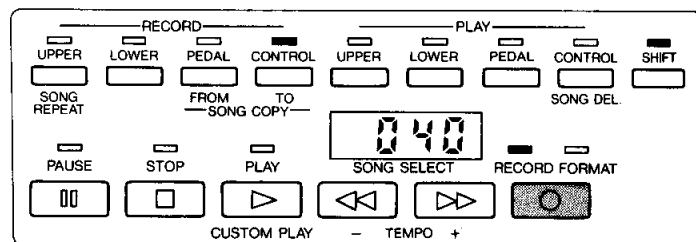

IV-2 SONG DELETE

If the data you have recorded for a Song No. becomes no longer necessary, you can erase the data by following the steps below.

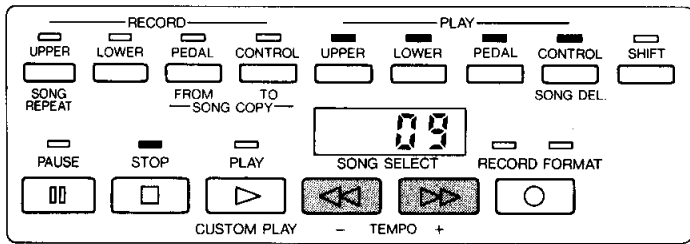

[To Delete the Data of Song No. 09]

① Use [SONG SELECT] to select the Song No. to be deleted.

Use [SONG SELECT] to display the Song No. that contains the recorded data you wish to delete at the Digital Display.

NOTE: Whenever the disk is completely full of data or does not have enough memory to complete a recording or Song Copy job, "FULL" appears at the Digital Display to indicate that the recording or Song Copy job cannot be executed. If this happens, select a Song No. that contains unnecessary data, then perform Steps ② and ③ below.

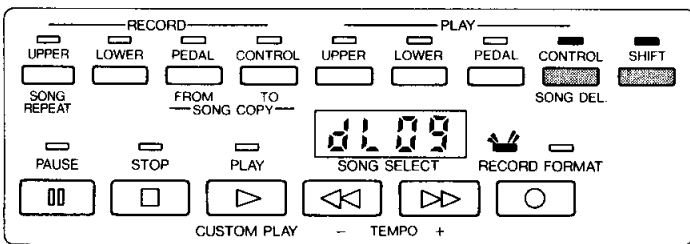

② Hold down [SHIFT] while you press [SONG DEL].

At the Digital Display, "dL" (Delete) appears at the two leftmost columns and the Song No. selected in Step ① appears at the two rightmost columns. Also, the RECORD lamp begins blinking.

NOTE: Even after completing Step ②, you can still use [SONG SELECT] to select a different Song No. to be deleted.

NOTE: To cancel the Song Delete job, press [STOP].

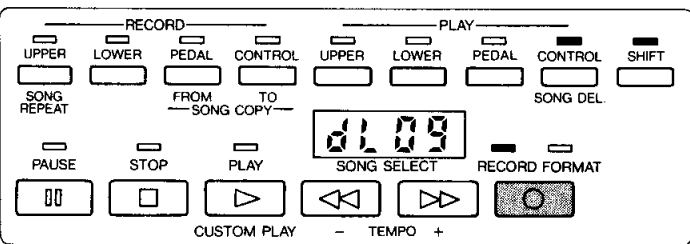

③ Press [RECORD].

The RECORD lamp stops blinking and remains lit, then the Song Delete job is executed. When the data of the selected Song No. is completely deleted, STOP status is automatically resumed.

NOTE: To continue deleting the data of other Song Nos., repeat Steps ① through ③.

Checking the Remaining Memory

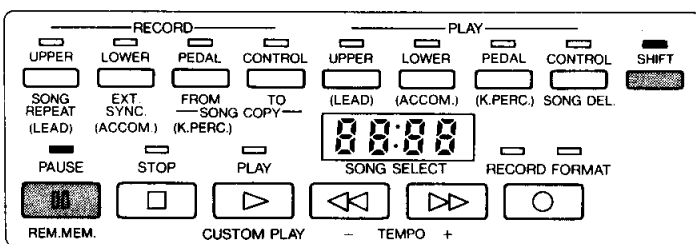

When the step below is performed in Stop status, the disk's remaining memory appears as a numeric value at the Digital Display so you can check how much memory area is still available.

► Hold down [SHIFT] while you press [PAUSE/REM.MEM.].

Note that the figure indicating the remaining memory is displayed only while the above buttons are depressed.

Recorded Data and Recording Channels

The figure below is a graphic representation of the data which is recorded during a normal recording job.

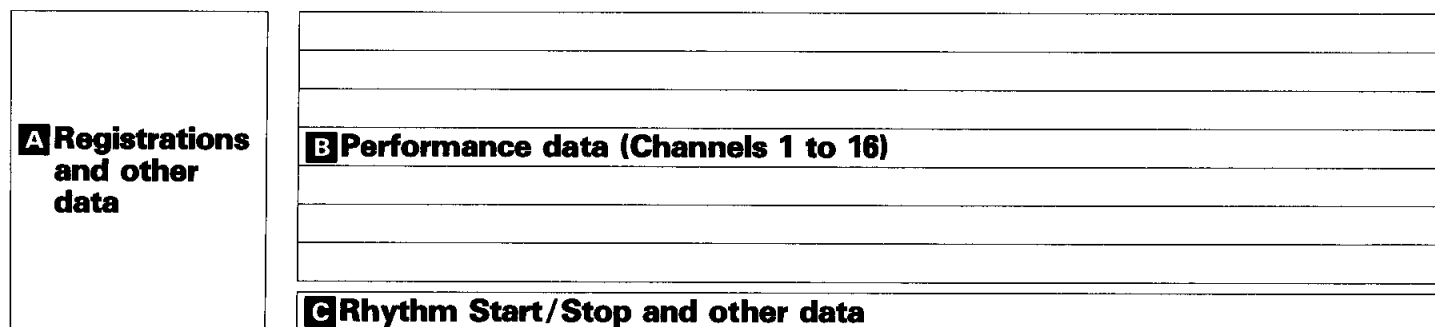

The data recorded at **A** = Registrations and other data

During normal recording, Registrations and other data currently memorized at the Electone (Bulk data) are initially recorded. During Custom recording, Registrations and other data are not recorded. In case an HS or HX Series Electone is used, the data that can be recorded consists of the following.

- Data memorized at the Registration Memory *1
- Data of the C.S.P./R.S.P. (HS Series) or Sequencer (HX Series)
- Data of User Rhythm patterns or User Rhythmic patterns (HS Series only).
- Data of User Voices.
- F.M.P. data (HS Series) *2
- Data of the current Registration *3

- *1: With an HX Series Electone, Registration data that cannot be memorized at Registration Memory (Vibrato, Combi. User Voices, Effectors, etc.) can also be recorded.
- *2: With an HS Series Electone, you can disable the transmission of F.M.P. data as follows: Display the MULTI MENU 10 display, then hold down [EXTERNAL/MIDI CONTROL] while you press [UPPER ORCHESTRAL DEPTH]. If you perform this step before starting recording, you can reduce the amount of time required for recording Registrations and other data at MDR-3.
- *3: The data which is currently set at the Electone panel at the time recording is started will be recorded separately from the Registration Memory data. Note that only this current Registration data is recorded during Custom recording and that its corresponding panel settings will also be recalled to the Electone during Custom playback.

The data Recorded at **B** = Performance data

The basic Performance data – which indicates the timing at which a key was pressed and released (Key ON/OFF status), the note to be played, and its volume level – and the Control data of the Expression Pedal, etc. are recorded at **B**. In case an HS or HX Series Electone is used, the Performance data of each part recorded at MDR-3 will conform to the table below.

- The various data recorded at **B** are called "MIDI Channel Messages." The Performance data of each Electone keyboard (each part) is sent to a different channel, and MDR-3 records that data using the Channel Nos. listed below. (In the Control part, Exclusive Messages are also recorded.)

Recorded Part	Recorded Data	Recording CH
[UPPER]	Performance data of the Upper Keyboard (Key ON/OFF status, After Touch, Sustain ON/OFF status) *1	1
[LOWER]	Performance data of the Lower Keyboard (Key ON/OFF status, After Touch, Sustain ON/OFF status) *1	2
[PEDAL]	Performance data of the Pedal Keyboard (Key ON/OFF status, After Touch, Sustain ON/OFF status) *1	3
[CONTROL]	Control data indicating changes at the Expression Pedal, Registration Memory selection, and so on. *2	16
[SHIFT]+[UPPER]	Performance data of the Lead Voice (Key ON/OFF status, After Touch)	*3 4
[SHIFT]+[LOWER]	Performance data of the Arpeggio Chord Voice (Key ON/OFF status, After Touch) (HS Series only)	*4 5
[SHIFT]+[PEDAL]	Performance data of Keyboard Percussion (Key ON/OFF status)	*5 15

- *1: With an HS Series Electone, the data indicating changes in Registration Memory selection is also recorded.
- *2: Exclusive Messages, which contain the data of Fill In patterns, Intro/Ending patterns, Foot Switch control, Knee Lever control, Tempo, and changes in the panel switches, are also recorded. In case an HS-8 or HX Series Electone is used, the Control data of the Modulation Wheel, 2nd Expression Pedal, and Pitch Wheel are also recorded.

- *3: The received Upper Keyboard Performance data (Channel 1) is recorded over Channel 4 instead. If Channel 4 signals are received, they will be directly recorded at Channel 4.
- *4: The received Lower Keyboard Performance data (Channel 2) is recorded over Channel 5 instead. If Channel 5 signals are received, they will be directly recorded at Channel 5.
- *5: The received Lower and Pedal Keyboard Performance data (Channels 2 and 3) is recorded over Channel 15 instead. If Channel 15 signals are received, they will be directly recorded at Channel 15.

The data Recorded at **C** = Rhythm Start/Stop and other data

The Rhythm Start/Stop data and other Realtime Messages can be recorded separately from **B**.

- Rhythm Start/Stop data *1
- Clock data *2

- *1: The Start/Stop data of the C.S.P./R.S.P. (HS Series) or of the Sequencer (HX Series) is also recorded.
- *2: Clock messages (F8H) will only be recorded at MDR-3 during the first Record job.

NOTE: The Rhythm Start/Stop data and the data of Channels 6 to 14 are recorded during the first recording job and will not be rewritten during subsequent recording jobs. It is possible to rewrite the data of Channels 6 to 14 during a subsequent recording job, however, if all of its recorded parts in **B** have been turned OFF.

Troubleshooting

Please note that the occurrence of any of the symptoms described below does not indicate a mechanical failure.

Symptom	Cause and Solution
Recording or playback cannot be performed.	① Improper execution of recording or playback is sometimes caused by improper operation of MDR-3 or an incompatible power supply. ② The PLAY section button for selecting the required parts may be turned OFF. Turn ON the necessary PLAY section part buttons. ③ The Electone's Receiving Channel may be different from the Channel No. used by MDR-3 for recording. Check the settings of the Electone's Receiving Channels.
A total of 16 songs cannot be recorded.	If a single Song No. contains a large volume of recorded data, the disk may not have enough available memory left to record the maximum of 16 songs.
Recording is stopped before the performance is finished, or the Song Copy job cannot be performed.	The amount of recorded data on the disk is already close to the maximum limit. Either use another disk or delete the data of any unnecessary Song Nos. (→page 19)
The playback of the performance differs from the recording.	Certain Electone models that can be used for recording are functionally incapable of transferring Performance data as MIDI signals. Before recording the performance of an Electone that is not of the HS or HX Series, be sure to check its MIDI specifications.
In addition to the Upper Keyboard or Lower Keyboard performance, a performance using a Lead Voice or Arpeggio Chord Voice (HS Series only) cannot be recorded or played back.	① When recording, you forgot to turn ON [RECORD] then hold down [SHIFT] while you turned ON [UPPER] (Lead Voice) or [LOWER] (Arpeggio Chord Voice). ② The Lead Voice or Arpeggio Chord Voice performance was not assigned to a separate Receiving Channel. Other causes may be involved, so check the procedure for recording a Lead Voice or Arpeggio Chord Voice part. (→pages 10 and 11)
The Keyboard Percussion performance is not recorded, or it is recorded but a different rhythm is played back.	When recording, you forgot to turn ON [RECORD] then hold down [SHIFT] while you turned ON [PEDAL] (Keyboard Percussion). Other causes may be involved, so check the procedure for recording a Keyboard Percussion part. (→page 12)
The rhythm does not start at the beginning of recording, or the rhythm starts but stops in the middle of the performance.	MDR-3 is designed so that the rhythm cannot be started at the very beginning of recording. If you wish to use the rhythm, start it after the available memory display appears at the Digital Display.
When a Fast Forward or Fast Reverse operation is performed, the timing of the rhythm and of the performance go out of sync.	Unless you are using an HS or HX Series Electone, do not perform the Fast Forward or Fast Reverse operations.
The played back notes of the Electone are sounded continuously.	During playback, you turned OFF the POWER switch or removed the disk by pressing [EJECT]. Whenever you wish to stop the playback, always press [STOP].
When playback is attempted using a non-Electone instrument, the notes are continuously sounded.	Because MDR-3 is a dedicated performance recorder for Electone use, it may sound notes continuously if it is connected to a non-Electone instrument; this does not indicate, however, a mechanical failure of MDR-3.

FCC INFORMATION (USA)

While the following statements are provided to comply with FCC Regulations in the United States, the corrective measures listed are applicable worldwide.

This equipment use frequencies that appear in the radio frequency range, and if installed in the immediate proximity of some types of audio or video devices within three meters (approximately ten feet), interference may occur.

This equipment has been type-tested and found to comply with the specifications set for a class B computer in accordance with those specifications listed in sub-part J, part 15 of the FCC rules. These rules are designed to provide a reasonable measure of protection against such interference. However, this does not guarantee that interference will not occur.

If this equipment should be suspected of causing interference with other electronic devices, verification can be made by turning this equipment off and on. If the interference continues when this equipment is off, this equipment is not the source of the interference. If this equipment does appear to be the source of the interference, you should try to correct the situation by using one or more of the following measures:

- Relocate either this equipment or the electronic device that is being affected by the interference.
- Utilize power outlets for this equipment and the device being affected that are on different branch (circuit breaker or fuse) circuits, or install AC line filters.
- In the case of radio-TV interference, relocate the antenna or if the antenna lead-in is 300 ohm ribbon lead, change the lead-in to coaxial type cable.

If these corrective measures do not produce satisfactory results, please contact an authorized Yamaha Electone™ dealer for suggestions and/or corrective measures. If you can not locate an authorized Yamaha Electone™ dealer in your general area, please contact the Electone™ Service Department, YAMAHA MUSIC CORP, U.S.A. 6600 Orangethorpe Ave., Buena Park, CA 90620.

If for any reason, you should need additional information relating to radio or TV interference, you may find a booklet prepared by the Federal Communications Commission Helpful: "How to Identify and Resolve Radio-TV Interference Problems." This booklet, Stock # 004-000-00345-4, is available from the US. Government Printing Office, Washington DC. 20402.

During Recording / Bei Aufnahme / Pendant l'enregistrement / Durante la grabación

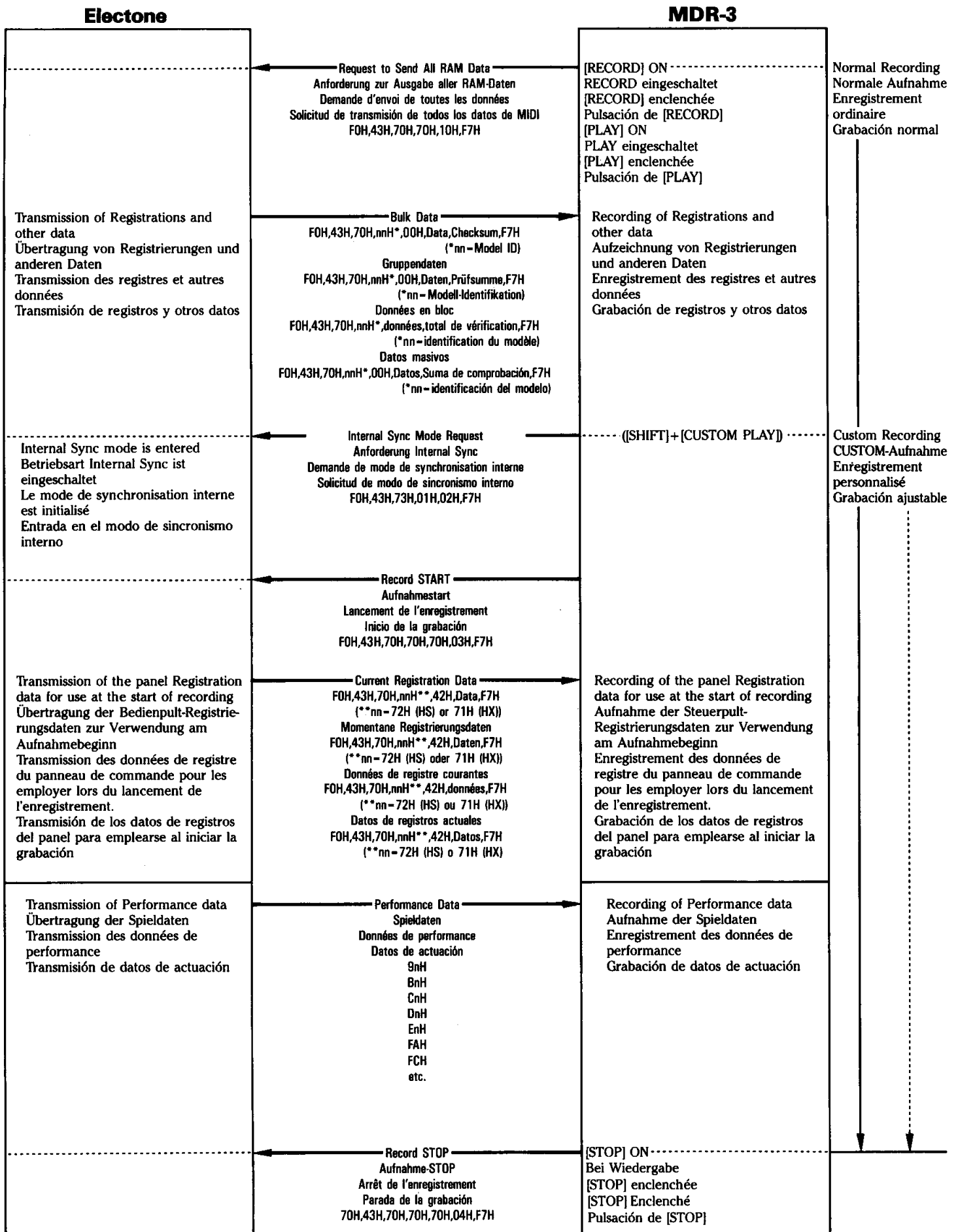

Electone

MDR-3

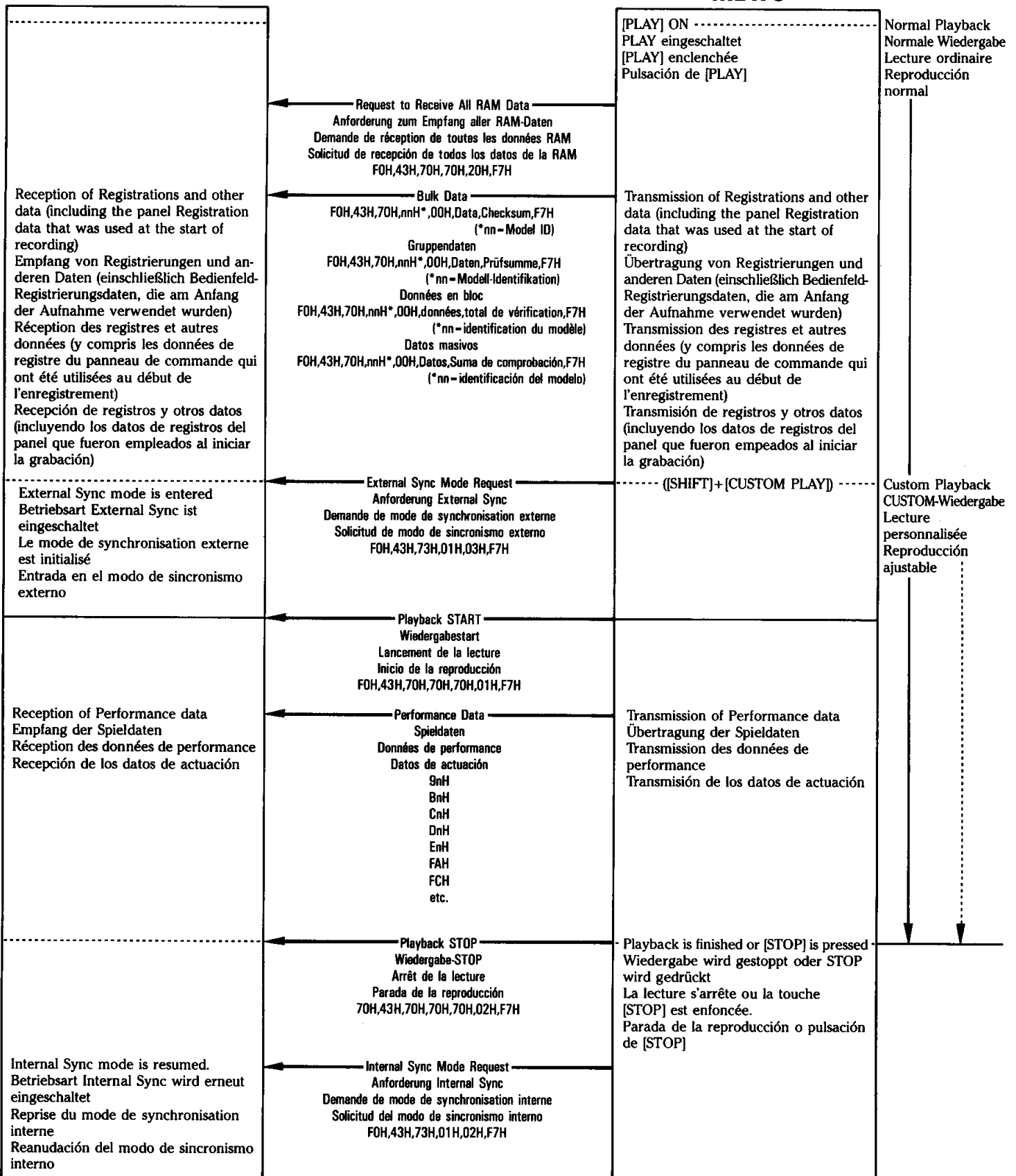

*In case Bulk data is not successfully transmitted by MDR-3 or received by the Electone, an Unacknowledge (NAK) signal (FOH, 43H, 70H, 70H, 38H, 00H, F7H) is sent from the Electone to MDR-3, then MDR-3 transmits the Bulk data once more. If the second attempt to transfer Bulk data is also unsuccessful, the operation will be discontinued.

*Wenn Gruppendaten nicht erfolgreich durch MDR-3 übertragen oder vom Electone empfangen werden, wird ein Nicht-Erkant-Signal (NAK) (FOH, 43H, 70H, 70H, 38H, 00H, F7H) vom Electone zum MDR-3 ausgegeben, und MDR-3 gibt die Gruppendaten erneut aus. Wenn auch der zweite Versuch zur Übertragung von Gruppendaten erfolglos ist, wird das Verfahren abgebrochen.

*Au cas où les données en bloc ne seraient pas transmises par le MDR-3, ou pas reçues par l'Electone, un signal de non reconnaissance (NAK="unacknowledge") (FOH, 43H, 70H, 70H, 38H, 00H, F7H) est envoyé de l'Electone au MDR-3, puis le MDR-3 envoie à nouveau les données en bloc. Si la deuxième tentative d'envoi des données en bloc échoue, cette opération va s'interrompre.

*En caso de que el MDR-3 no transmita satisfactoriamente los datos masivos o de que el Electone no los reciba, el Electone enviará al MDR-3 una señal de ausencia de recibo (NAK) (FOH, 43H, 70H, 70H, 38H, 00H, F7H), después de lo cual el MDR-3 transmitirá una vez más los datos masivos. Si el segundo intento de transferencia de datos masivos resulta también insatisfactorio, la operación cesará.

Specifications Spécifications

Model: Music Disk Recorder
Recording media: 3.5-inch microfloppy disks (2DD)
Disk format: MSX-DOS (MS-DOS Ver. 1.25)
Memory capacity: 634k bytes/16 songs maximum
Control: RECORD/FORMAT, SONG SELECT/TEMPO +/▷▷, SONG SELECT/TEMPO -/◁◁, PLAY/CUSTOM PLAY, STOP, PAUSE.
RECORD Section: UPPER/SONG REPEAT, LOWER, PEDAL/SONG COPY FROM, CONTROL/SONG COPY TO.
PLAY Section: UPPER, LOWER, PEDAL, CONTROL/SONG DEL., SHIFT.
Display: Four-digit seven-segment LED
Other components: POWER switch, disk drive, EJECT button
Input/Output jacks: MIDI IN, MIDI OUT, MIDI THRU, DC IN.
Rated input voltage: 10 V DC
Rated input current: Minimum 700 mA up to 1A

Modell: Musik Disk Recorder
Datenträger: 3,5-Zoll Mikrodisketten (2DD)
Betriebssystem: MSX-DOS (MS-DOS Ver. 1.25)
Speicherkapazität: 634 kB/maximal 16 Titel
Bedienungselemente: RECORD/FORMAT, SONG SELECT/TEMPO +/▷▷, SONG SELECT/TEMPO -/◁◁, PLAY/CUSTOM PLAY, STOP, PAUSE.
RECORD-Sektion: UPPER/SONG REPEAT, LOWER, PEDAL/SONG COPY FROM, CONTROL/SONG COPY TO.
PLAY-Sektion: UPPER, LOWER, PEDAL, CONTROL/SONG DEL., SHIFT.
Display: 4stellige LED mit sieben Segmenten
Weitere Bedienelemente: Netzschalter, Laufwerk, Auswurfaste
Ein/Ausgangsbuchsen: MIDI IN, MIDI OUT, MIDI THRU, DC IN.
Betriebsspannung: 10 V Gleichstrom
Betriebsstromstärke: Minimum 700 mA bis 1 A

Modèle: Enregistreur sur disque musical
Médium d'enregistrement: Mini disque de 3,5 pouces (2DD)
Format du disque: MSX-DOS (MS-DOS, ver. 1.25)
Capacité de la mémoire: 634 koctets/16 compositions maximum
Réglages: RECORD/FORMAT, SONG SELECT/TEMPO +/▷▷, SONG SELECT/TEMPO -/◁◁, PLAY/CUSTOM PLAY, STOP, PAUSE.
Section RECORD: UPPER/SONG REPEAT, LOWER, PEDAL/SONG COPY FROM, CONTROL/SONG COPY TO.
Section PLAY: UPPER, LOWER, PEDAL, CONTROL/SONG DEL., SHIFT.
Affichage: Quatre chiffres DEL à 7 segments
Autres composants: Interrupteur POWER, unité d'entraînement de disque, touche EJECT.
Prises d'entrée/sortie: MIDI IN, MIDI OUT, MIDI THRU, DC IN.
Tension d'entrée nominale: 10 V CC
Courant d'entrée nominal: De 700 mA à 1 A

Modelo: Grabador de discos musicales
Medio de grabación: Microdisco flexible de 3,5 pulgadas (2DD)
Formato del disco: MSX-DOS (MS-DOS Ver. 1.25)
Capacidad de memoria: 634 kilobytes/16 canciones como máximo
Controles: RECORD/FORMAT, SONG SELECT/TEMPO +/▷▷, SONG SELECT/TEMPO -/◁◁, PLAY/CUSTOM PLAY, STOP, PAUSE
Sección RECORD: UPPER/SONG REPEAT, LOWER, PEDAL/SONG COPY FROM, CONTROL/SONG COPY TO
Sección PLAY: UPPER, LOWER, PEDAL, CONTROL/SONG DEL., SHIFT
Visualizador: Cuatro dígitos de LED de siete elementos
Otros componentes: Interruptor POWER, unidad de disco, botón EJECT
Tomas de entrada/salida: MIDI IN, MIDI OUT, MIDI THRU, DC IN
Tensión nominal de entrada: 10V CC
Corriente nominal de entrada: Mínima de 700 mA hasta 1A

Technische Daten Especificaciones

Rated power consumption: 7.5 W
External dimensions: 135 (W) × 200 (D) × 63.5 (H) mm
Weight: 1.3 kg
Accessories: 3.5-inch 2DD microfloppy disk × 1
MIDI cable (1.5m length) × 2
Auxiliary operation sheet
Options: Mounting bracket BRT-3 (for use with the HS Series Electone)
Power adaptor PA-3L or PA-4 (PA-40 for the USA)
[Reference: Names of the Created Files]
Registration files MDR_nn.ROO
Event files MDR_nn.EVT
*nn=00 to 15 (Song Nos. 01 to 16)

Leistungsaufnahme: 7,5 W
Außenabmessungen: 135 × 200 × 63,5 (B × T × H) mm
Gewicht: 1,3 kg
Zubehör: 3,5-Zoll-Mikrodiskette (2DD) × 1
MIDI-Kabel (1,5 m lang) × 2
Bedienungsblatt
Sonderzubehör: Halteklammer BRT-3 (zur Verwendung mit Electones der HS-Serie)
Netzteil PA-3L oder PA-4 (PA-40 für die USA)

[Beispiel: Namen von erzeugten Dateien]
Registrierungsdatei: MDR_nn.ROO
Spieldatei: MDR_nn.EVT
*nn=00 bis 15 (Titelnummer 01 bis 16)

Consommation d'alimentation nominale: 7,5 W
Dimensions hors tout: 135 (L) × 200 (P) × 63,5 (H) mm
Poids: 1,3 kg
Accessoires: Mini-disque de 3,5 pouces 2DD × 1
Cordon MIDI (1,5 m de long) × 2
Feuille d'exploitation supplémentaire
Options: Support de montage BRT-3 (pour utiliser avec les Electones de la série HS)
Adaptateur d'alimentation PA-3L ou PA-4 (PA-40 pour les Etats-Unis)

[Référence: Noms des fichiers créés]
Fichiers des registres: MDR_nn.ROO
Fichiers évènement: MDR_nn.EVT
*nn=00 à 15 (n° de composition de 01 à 16)

Consumo nominal: 7,5 W
Dimensiones externas: 135 (An) × 200 (Prf) × 63,5 (Al) mm
Peso: 1,3 kg
Accesorios: Microdisco flexible 2DD de 3,5 pulgadas × 1
Cable de MIDI (1,5 m de longitud)
Hoja de operación auxiliar
Opciones: Soporte de montaje BRT-3 (para emplear con un Electone de la serie HS)
Adaptador de alimentación PA-3L o PA-4 (P-40 para EE.UU.)

[Referencia: Nombres de los archivos creados]
Archivos de registros: MDR_nn.ROO
Archivos de eventos: MDR_nn.EVT
*nn=00 a 15 (números de canciones 01 a 16)

MUSIC DISK RECORDER MDR-3

MIDI Implementation Chart/MIDI Implementantation Chart

Schéma d'implantation MIDI/Tabla de implementación de MIDI

Date: 6/30, 1988
Version: C

Function	Transmitted	Recognized	Remarks
Basic Channel Default Changes	all channels ×	all channels ×	not Basic ch.
Mode Default Messages Altered	Mode 1 *****	Mode 1 *****	
Note Number True Voice	0-127 *****	0-127	
Velocity Note ON Note OFF	<input type="radio"/> 9nH, v=0-127 <input type="radio"/> 8nH, v=0-127	<input type="radio"/> 9nH, v=0-127 <input type="radio"/> 8nH, v=0-127	
After Touch Key's CH's	<input type="radio"/> <input type="radio"/>	<input type="radio"/> <input type="radio"/>	
Pitch Bender	<input type="radio"/>	<input type="radio"/>	
Control Change 0-63 64-121	<input type="radio"/> <input type="radio"/>	<input type="radio"/> <input type="radio"/>	
Program Change True #	<input type="radio"/> *****	<input type="radio"/>	
System Exclusive	<input type="radio"/>	<input type="radio"/>	
System Common Song Pos Song Sel Tune	<input type="radio"/> <input type="radio"/> <input type="radio"/>	<input type="radio"/> <input type="radio"/> <input type="radio"/>	
System Real Time Clock Commands	<input type="radio"/> <input type="radio"/>	<input type="radio"/> <input type="radio"/>	
Aux Messages Local ON/OFF All Notes OFF Active Sense Reset	<input type="radio"/> <input type="radio"/> <input type="radio"/> <input type="radio"/>	<input type="radio"/> <input type="radio"/> × <input type="radio"/>	
Notes			

Mode 1: OMNI ON, POLY
Mode 3: OMNI OFF, POLY

Mode 2: OMNI ON, MONO
Mode 4: OMNI OFF, MONO

○: Yes
×: No

YAMAHA
YAMAHA CORPORATION
P.O.Box 1, Hamamatsu, Japan