



LIVE STREAMING MIXER
AG 08

Contents

Introduction	5
<hr/>	
About this Guide	5
How the manuals are organized	7
Product features	8
Accessories	10
Installing AG08 Controller	11
Component names and functions	12
<hr/>	
Rear panel	12
Front side	17
Getting ready to use this product	26
<hr/>	
Connecting to your computer and configuring the settings (Windows)	26
Connecting to your computer and configuring the settings (Mac)	29
Connecting to an iPad/iPhone	32
Connecting to Android devices	34
Using this product for livestreaming (17LIVE, Twitch, YouTube Live)	36
<hr/>	
Using this product with your computer	36
Using with an iPad/iPhone	44
Using this product with an Android device	50
Operations while livestreaming	54
Connecting your musical instrument or music player	55
Using this product for a podcast	56
<hr/>	
Using WaveLab Cast	56

Using this product in music production	57
Using Cubase AI with your computer	57
Using Cubasis LE with an iPad/iPhone	58
Using the dedicated app	59
Using AG08 Controller	59
Using the GATE function	64
About the GATE	64
Using the COMP function	65
About the COMP	65
Using the voice changer	66
Adjusting the voice formant and pitch	66
Using the presets	68
Recalling the presets	68
Saving a preset	69
Using STEREO PAIR	70
About STEREO PAIR	70
Using the DUCKER function	71
About the DUCKER	71
Using the MAXIMIZER function	72
About the MAXIMIZER	72
Adding delay to the streaming audio	73
About STREAMING OUT DELAY	73

Adjusts the balance of sound being monitored	74
<hr/>	
About MONITOR MIX	74
Using the sound pad	75
<hr/>	
Using the sound pad for playback	75
Making detailed settings for each pad	76
Recording to the sound pad	77
Assigning audio files to the sound pad	79
Updating this unit	80
<hr/>	
Updating the firmware of this unit	80
Troubleshooting	84
<hr/>	
Power-related	84
Audio-related and other issues	85
Restoring the product to factory default settings (initialization)	87
Appendix	88
<hr/>	
General specifications	88
Input / Output characteristics	89
Dimensions	91
Block diagram	92
Level diagram	93

Introduction

About this Guide

Notice regarding the contents of this guide

This user guide explains about connecting and operating this product for the user. The precautions and other matters are classified as follows.

-  **WARNING**

This content indicates “risk of serious injury or death.”

-  **CAUTION**

This content indicates “risk of injury.”

- **NOTICE**

Indicates points that you must observe in order to prevent product failure, damage or malfunction and data loss, as well as to protect the environment.

- **NOTE**

Indicates notes on instructions, restrictions on functions, and additional information that may be helpful.

- All illustrations and screens shown in this guide are for explanatory purposes.
- Any company names, product names or related names in this document are the registered trademarks or trademarks of their respective owners.
- Software may be revised and updated without prior notice.
- Steinberg Media Technologies GmbH and Yamaha Corporation make no representations or warranties with regard to the use of the software and documentation
- and cannot be held responsible for the results of the use of this guide and the software.

Protection of copyright

- Do not use this product for any purpose that may infringe upon the rights of any third party including copyrights, as established by law in each country or region.
- Yamaha bears no responsibility for any infringement upon third party rights that may occur as a result of using this product.
- The copyright of the “content”^{*1} installed in this product belongs to Steinberg Media Technologies GmbH, Yamaha Corporation, or its copyright holder. Except as permitted by copyright laws and other relevant laws, such as copying for personal use, it is prohibited to “reproduce or divert”^{*2} without the permission of the copyright holder. When using the content, consult with a copyright expert. If you create music or perform with the contents through the original use of the product, and then record and distribute them, the permission of Yamaha Corporation is not required regardless of whether the distribution method is paid or free of charge.

- *1 The word “content” includes computer programs, sound data, accompaniment style data, MIDI data, waveform data, voice recording data, music scores and score data, and other related data.
- *2 The phrase “reproduce or repurpose” includes extracting the content that is built into or included with this product, or recording and distributing it in a form that closely resembles the original.

Trademarks

The trademarks used in this guide are as follows.

- Steinberg, Cubase, Cubasis and WaveLab Cast are registered trademarks of Steinberg Media Technologies GmbH.
- Windows is a registered trademark or trademark of Microsoft Corporation in the United States and other countries.
- Apple, Mac, iPad, iPhone, iPadOS, App Store and Lightning are trademarks of Apple Inc., registered in the U.S. and in other countries.
- Android and YouTube are trademarks of Google LLC.

All company names, product names and other such listings in this guide are the registered trademarks or trademarks of their respective companies.

How the manuals are organized

The manuals that cover this product are listed below.

Printed manuals

The manual that is included with this product.

- Start Guide
Explains the basic methods used to connect this product to external devices and how to configure the settings, as well as the name and function of each part.
- Safety Guide
Explains the safety-related points you must be aware of when using this product.

Online manuals

- User Guide (this guide)
Explains the name and function of each part, how to connect to various devices and how to set things up for making sound. This also explains how to use this product in different situations.

NOTE

You can download these manuals from the Yamaha website. The latest manual data is always available on the Yamaha website, so please make use of these resources as necessary.

<https://download.yamaha.com/>

Product features

This is a Live streaming mixer that's used for livestreaming and other uses via connection to your computer, iPad or smartphone. This product includes a variety of effects and functions to produce a great livestream.

■ Built-in voice changer for livestream production

You can apply a wide array of effects to the voice audio inputted to channel 1, including a voice changer and more. Use the dedicated "AG08 Controller" app to make detailed adjustments to the tonal character of the voice changer.

■ Sound pad for adding excitement to your livestream

You can use the six pad buttons on this unit for easily adding sound effects. Use the dedicated "AG08 Controller" app to change the sounds for each pad.

■ Three USB audio input/output channels and a physical fader design for controlling the volume

You can individually assign the playback audio to the channel 3/4, 5/6 and 7/8 faders on this unit from multiple applications running on a computer that's connected to this unit via USB, and mix this with the audio inputted to this unit and with the sound pad's playback sounds to create a livestream mix. Also, the three USB output channels on this product output individually to multiple applications on your computer. For example, you can use these in combination to create the optimum mixes respectively for the chat audio and for the livestream audio in your livestream that features guests and voice chat.

■ Preset buttons for instantly switching between channel 1 sound settings

You can use the four preset buttons on this unit to instantly switch between audio effect settings for channel 1.

Each preset can be configured in detail using the "AG08 Controller" dedicated app.

■ A variety of built-in effects for adjusting the character of the sound

You can turn on/off the voice changer (CH1), amp simulator (CH2), the gate/compressor/equalizer and reverb/delay of this product.

Each effect can be configured in detail using the "AG08 Controller" dedicated app.

■ Includes "WaveLab Cast" audio editing software

A license for "WaveLab Cast" is included with this product. You can use this software for podcasting or for editing the audio in your video contents.

■ Includes "Cubase AI" DAW software

A license for "Cubase AI" is included with this product. You can use this software for the tasks required in basic music production, including recording, editing, mixing and more.

■ **Stable operations using the dedicated AC adapter**

Use the included AC adapter to supply the necessary power for stable operations.

■ **Making detailed settings using the “AG08 Controller” dedicated app**

You can use AG08 Controller to freely configure the DSP effects built into the AG08 as well as the channel 1 presets, sound pad samples and more.

Accessories

The items included with this product are listed below. Check whether all of these items have been properly packaged with the product.

- AC adapter PA-150B × 1
- USB cable (USB-C to USB-C), 1.5 m × 1
- Safety Guide × 1
- Start Guide × 1
- WaveLab Cast Download Information × 1
- Cubase AI Download Information × 1

Installing AG08 Controller

To use AG08 Controller, download the app from the following website or from the App Store.

Windows/Mac

<https://www.yamaha.com/2/ag08/>

iPad

Search for AG08 Controller in the App Store and install. Note that AG08 Controller is not compatible with the iPhone.

NOTE

Along with the above app, you must also install the “Yamaha Steinberg USB Driver” so that this product can be recognized by your Windows or Mac computer.

Component names and functions

Rear panel

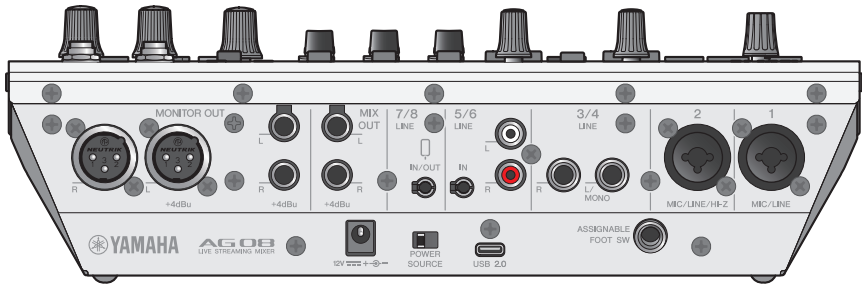

Bottom part of rear panel

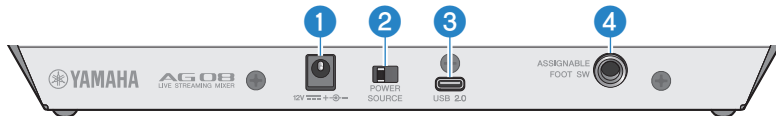

1 [12V] DC port

Connect the included AC adapter here.

2 [POWER SOURCE] selector switch

Selects which port is used to power this product. Set this to the [USB 2.0] side when powering this product via the [USB 2.0] port, and set this to the [12V] DC port side when powering this product via the [12V] DC port.

3 [USB 2.0] port (Type C)

Connect your computer or iPad/iPhone. When connecting a computer, power will be supplied from the computer to this unit. When connecting an iPad/iPhone, connect the included AC adapter separately to the [12V] DC port.

NOTE

A dedicated driver is required to use this product with a computer. Download and install the driver from the following website.

- <https://www.yamaha.com/2/ag08/>

NOTICE

- Do not connect any other devices to the USB 2.0 port except for a computer, iPad or iPhone.
- A 5 V and 1.5 A power supply is required to operate this product on bus power. If a sufficient amount of power is not available for a stable power supply, supply power separately via the [12V] DC port.

Points of caution when using the USB port

- Observe the following points to prevent loss of data when connecting the USB port to other devices.
- Observe the following before inserting or unplugging the USB cable.
 - Quit all applications.
 - Make sure that no data is being transmitted from this product.
- After you unplug the cable, make sure to wait for at least six seconds before plugging the cable in again. Rapidly plugging in and unplugging the cable may cause a malfunction.

4 [ASSIGNABLE FOOT SW] connector

Connect a footswitch (such as a Yamaha FC5, sold separately) here. You can set the INPUT MUTE, TAP TEMPO, VOICE EFFECT and OUTPUT DIMMER functions to be used with the foot switch. Use the AG08 Controller app to assign these functions. Press the menu [≡] button on the AG08 Controller, and select Settings → FOOT SW to make the settings.

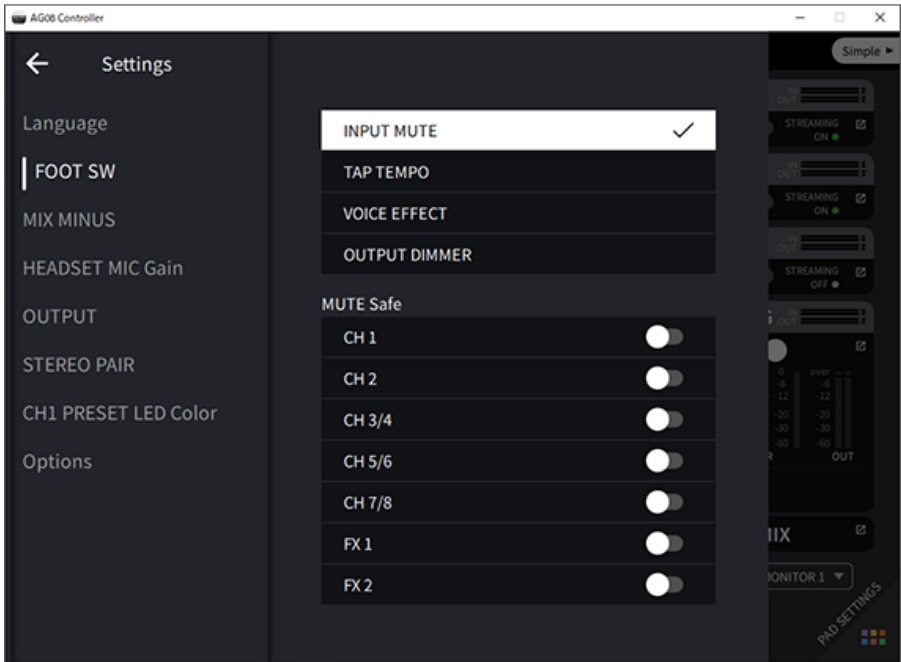

Top part of rear panel

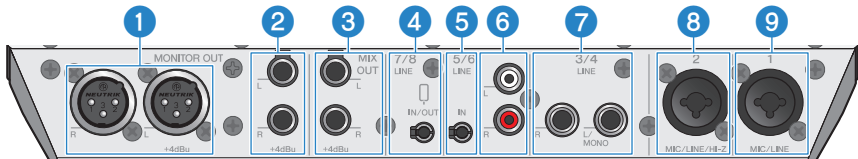

1 [MONITOR OUT] chassis connectors (XLR)

Connect your powered monitor speaker or similar equipment here. These are compatible with XLR connectors.

2 [MONITOR OUT] connectors (phone)

Connect your powered monitor speaker or similar equipment here. These are compatible with phone plugs (balanced/unbalanced).

3 [MIX OUT] connectors (phone)

These are electronically-balanced phone type output connectors for outputting the mixed signal in stereo.

4 [CH7/8 (□) LINE IN/OUT] smartphone input/output connector (compatible with four-conductor (TRRS) 3.5 mm stereo mini-plugs)

This input/output connector can be used in many different situations. Compatible with four-conductor stereo mini-plugs (CTIA-compliant). You can connect your smartphone or tablet such as an Android device here, and use an application to add sound effects such as audio cues or background music. Adjust the output volume on the connected device. You can send the audio signal from this product to a connected device.

5 [CH5/6 LINE IN] connector (compatible with three-conductor (TRS) 3.5 mm stereo mini-plugs)

Connect an electronic musical instrument, audio device or other line-level equipment here. Compatible with stereo mini-plug cables.

6 [CH5/6 LINE IN] connectors (RCA pin type)

Connect an electronic musical instrument, audio device or other line-level equipment here. Compatible with RCA pin type plugs. Three-conductor (TRS) 3.5 mm stereo mini plugs are given priority over RCA pin type plugs. You cannot use both types at the same time.

7 [CH3/4 LINE] connectors (phone type)

Connect an electronic musical instrument, audio device or other line-level equipment here. Compatible with phone plugs.

8 [CH2 MIC/LINE/HI-Z] connector

Connect your mic, electronic musical instrument or other device here. Compatible with both XLR and phone plugs. You can also connect a device with high output impedance like an electric guitar or bass guitar here.

9 [CH1 MIC/LINE] connector

Connect your mic, electronic musical instrument or other device here. Compatible with both XLR and phone plugs.

Plug type

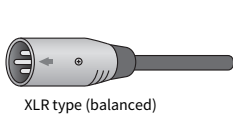

Assigning output signals to the outputs

NOTE

You can use the AG08 Controller app to change which signal outputs to the [MONITOR OUT] chassis connectors/connectors, the [MIX OUT] connectors and the [CH7/8 LINE IN/OUT] connector.

Component names and functions > Rear panel

- Output for the [MONITOR OUT] connectors

In the AG08 Controller app, use the MONITOR OUT settings shown at the bottom right corner of the Detail mode screen to select the output.



Component names and functions > Rear panel

- Output for [MIX OUT] connectors and [CH7/8 LINE IN/OUT] connector
Press the menu [☰] button on the AG08 Controller, and select Settings → OUTPUT to make the settings.

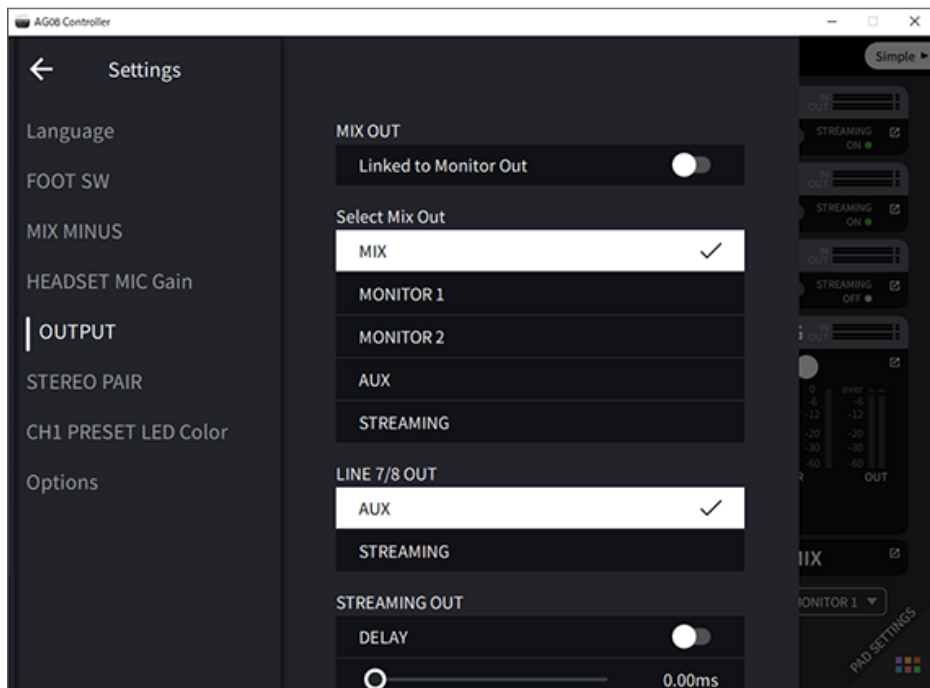

For the signals for MIX, MONITOR1, MONITOR2, AUX and STREAMING, refer to the block diagram.

Front side

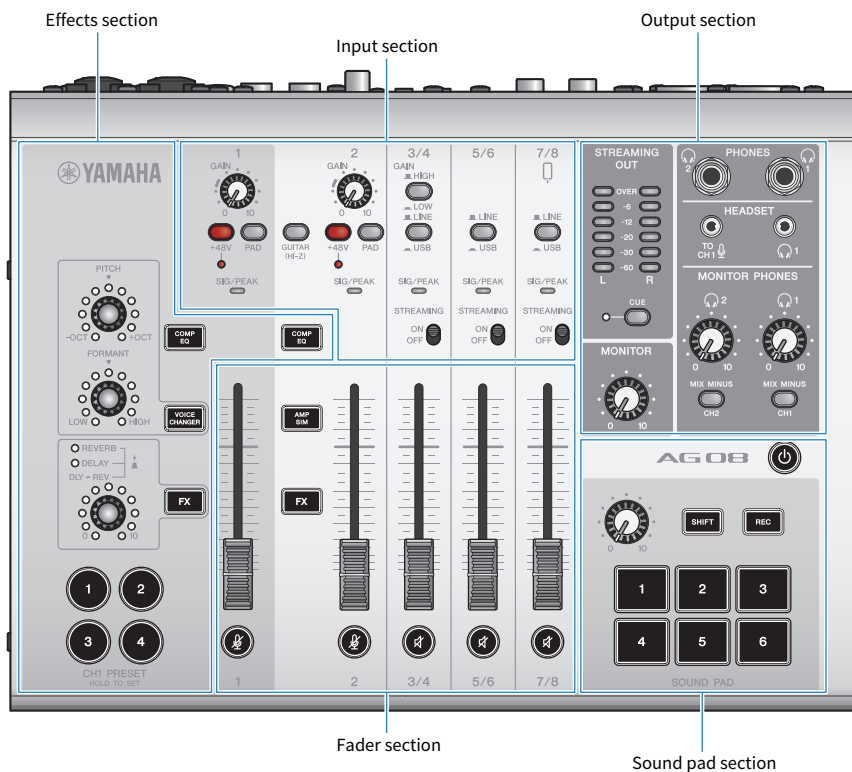

Top panel input section

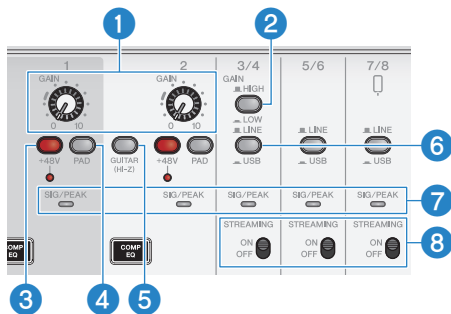

1 [GAIN] knobs

Determines the base volume for the respective channel. Adjust the knobs so that the [SIG/PEAK] LED lights up red only briefly when you sing loudly or play strongly.

2 [GAIN HIGH/LOW] selector switch

Determines the base volume for channels 3/4. Set this to LOW () if the [SIG/PEAK] LED keeps lighting up red or if the sound is distorting.

NOTE

Turn the channel faders to the minimum setting before you toggle the [GAIN HIGH/LOW] selector switch. This is because you may hear a noise when the switch is toggled.

3 Phantom [+48V] switch/[+48V] LED

When this switch is turned on (), the [+48V] LED lights, and DC +48V phantom power is supplied to the XLR plug connected to the mic/line input connectors for channels 1 and 2.

Turn this switch on when you are using a condenser mic.

NOTE



- Turn the switch off if you don't need phantom power.
- To prevent this product or your external device from malfunctioning and to prevent noise, turn this switch off before connecting a device that does not support phantom power to channels 1 or 2.
- To prevent this product or your external device from malfunctioning and to prevent noise, do not unplug or insert a cable into channel 1 or 2 while the switch is still on.
- To prevent this product or your external device from malfunctioning and to prevent noise, turn phantom power on/off only when the channel 1/2 faders are at minimum setting.

4 [PAD] switch

These switches attenuate the input signal level.

Turn these switches on if the input audio sounds distorted or if it seems too loud.

5 [GUITAR (HI-Z)] switch

Use this switch to change the input impedance for channel 2, either on () or off (). Set this to on when directly connecting an instrument with high output impedance like an electric guitar or bass guitar to channel 2. If you will use the "on" setting for this switch, connect your instrument to this product with an unbalanced phone connector. The product will not work correctly if you use a balanced cable.



WARNING

- Set the output controls such as the [MONITOR] knob and the [MONITOR PHONES] () knob to their minimum setting before toggling this switch. This is because the levels may suddenly get loud, which could damage your hearing or cause external devices to malfunction.

6 [LINE/USB] selector switches

These switches toggle between the audio source from the analog input connectors of channels 3/4, 5/6 and 7/8 and the input audio from the USB port. For details on what happens when this is switched to USB, see "Settings on the computer" in "Connecting to your computer and configuring the settings (Windows)" (p.26) or "Settings on the computer" in "Connecting to your computer and configuring the settings (Mac)" (p.29).



WARNING

- Adjust the volume before you toggle these switches. This is because the levels may suddenly get loud depending on the device you've connected, which could damage your hearing or cause external devices to malfunction.

7 [SIG/PEAK] LED

Use these indicators to check the input signal levels. To send audio at an appropriate volume to your computer, adjust the levels for each channel so that the green LEDs light up but the red LEDs only briefly light up when a loud sound is input.

8 [STREAMING ON/OFF] switch

These switches toggle the output to the livestream bus (STREAMING bus) of the input from channels 3/4, 5/6 and 7/8.

Fader section

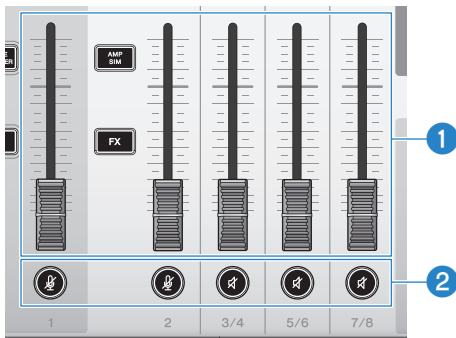

1 Channel faders

Adjusts the output level of the audio input from channels 1–8.

NOTE

When channels 1 and 2 are linked as a STEREO PAIR (p.70), use the channel 1 fader to adjust the channel 1 and 2 output levels. Channel 2 fader operations are disabled.

2 () () Mute buttons

Toggles the mute feature on (the LED lights up red) or off (the LED goes dark). You can use this to silence the sound when you take a short break or in similar situations while livestreaming.

NOTE

- The LEDs flash when you are muting a channel using the INPUT MUTE function with a foot switch.
- When channels 1 and 2 are linked as a STEREO PAIR (p.70), the channel 1/2 mute buttons switch the mute on/off in tandem.

Effects section

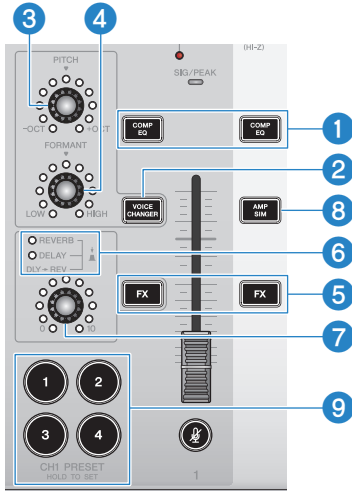

1 [COMP EQ] buttons

These buttons toggle the gate/compressor/equalizer on or off for channels 1 and 2. This is set at the optimal setting for livestreaming by default. This keeps down unnecessary noise in the low end and helps smooth out differences in the input levels.

NOTE

When channels 1 and 2 are linked as a STEREO PAIR (p.70), the channel 1/2 [COMP EQ] buttons switch on/off in tandem.

2 [VOICE CHANGER] button

Toggles the voice changer function for channel 1 on/off.

NOTE

When channels 1 and 2 are linked as a STEREO PAIR (p.70), the voice change function is turned off, and the [VOICE CHANGER] button goes dark.

3 [PITCH] knob

Turn this knob to adjust the pitch for the channel 1 voice. You can change the pitch within a range of one octave up or down.



When the parameter value is at zero, only the center LED lights up.

NOTE

When channels 1 and 2 are linked as a STEREO PAIR (p.70), the [PITCH] knob adjustment is disabled and the LED goes dark.

4 [FORMANT] knob

Turn this knob to adjust the formant for the channel 1 voice. Turn this towards LOW for a more masculine voice, and turn this towards HIGH for a more feminine voice.

NOTE

When channels 1 and 2 are linked as a STEREO PAIR (p.70), the [FORMANT] knob adjustment is disabled and the LED goes dark.

5 [FX] buttons

Toggles the send on/off to FX 1 from channel 1 and to FX 2 from channel 2.

NOTE

- The LEDs flash when you are using the INPUT MUTE function with a footswitch during send off.
- When channels 1 and 2 are linked as a STEREO PAIR (p.70), the channel 1/2 [FX] buttons switch on/off in tandem.

6 FX TYPE ([REVERB]/[DELAY]/[DLY→REV]) LEDs

Use these indicators to check the FX effect type for channel 1.

When REVERB is selected, the REVERB indicator lights up; when DELAY is selected, the DELAY indicator lights up; and when DLY→REV (DELAY→REVERB) is selected, both indicators light up.

7 FX SEND knobs

Use these knobs to control the send level for FX1 of channel 1.

Push these knobs to toggle the effect type for FX1 of channel 1.

8 [AMP SIM] button

Toggles the amp simulator function for channel 2 on/off. The amp simulator recreates the sound of playing an electric guitar through an amplifier. This simulates the characteristic “distorted” amp sound that’s heard when you directly connect an electric guitar.

NOTE

When channels 1 and 2 are linked as a STEREO PAIR (p.70), the amp simulator function is turned off, and the [AMP SIM] button goes dark.

9 [CH1 PRESET] [1]–[4] buttons

Use these buttons to register effect combinations for channel 1 as a preset, and recall them later. The button lights up for the preset you recall. You can store four presets. With AG08 Controller, you can select from six different colors for the button LEDs. Use AG08 Controller to change the LED colors. See “Using the presets” (p.68) for how to register the presets.

NOTE

When channels 1 and 2 are linked as a STEREO PAIR (p.70), the preset registration and recall functions are turned off, and the preset buttons go dark.

Top panel output section

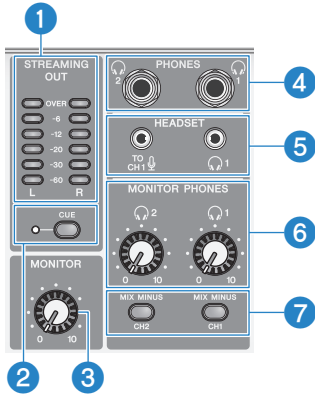

1 [STREAMING OUT] LED level meters

These meters display the level of signal used for the streaming bus (STREAMING bus). Each horizontal meter lights up when its signal level (shown in the middle, in units of dB) is exceeded. When the signal level exceeds 0 dB, the OVER LED lights up red.

2 [CUE] switch

When this is turned on, the STREAMING OUT signal is output to both MONITOR PHONES 1 and 2, and the indicator to the left of the switch lights up. Turn this on when you want to check the streaming signal in headphones.

3 [MONITOR] knob

Adjusts the volume of audio sent to the device connected to the [MONITOR OUT] connectors.

4 [PHONES 1 (🎧)/PHONES 2 (🎧)] connector (phone type)

Connect your headphones here. Compatible with stereo phone plugs. When using headphones or earphones with a stereo mini-plug, you can also use the [HEADSET] headphones [🎧] output connector.

5 [HEADSET] mic [CH1] input connector

Connect a headset mic here. Normally, the plug is pink. The audio input from this connector is sent to channel 1.

NOTE

When you connect a mic plug into the [HEADSET] mic [CH1] input connector, the audio from the device connected to the [CH1 MIC/LINE] connector is muted.

NOTE

Use AG08 Controller to set the gain for the signal input from the [HEADSET] mic [CH1] input connector, instead of using the channel 1 [GAIN] knob on the top panel. Press the menu [☰] button on the AG08 Controller app, and select Settings → HEADSET MIC Gain to configure the settings.

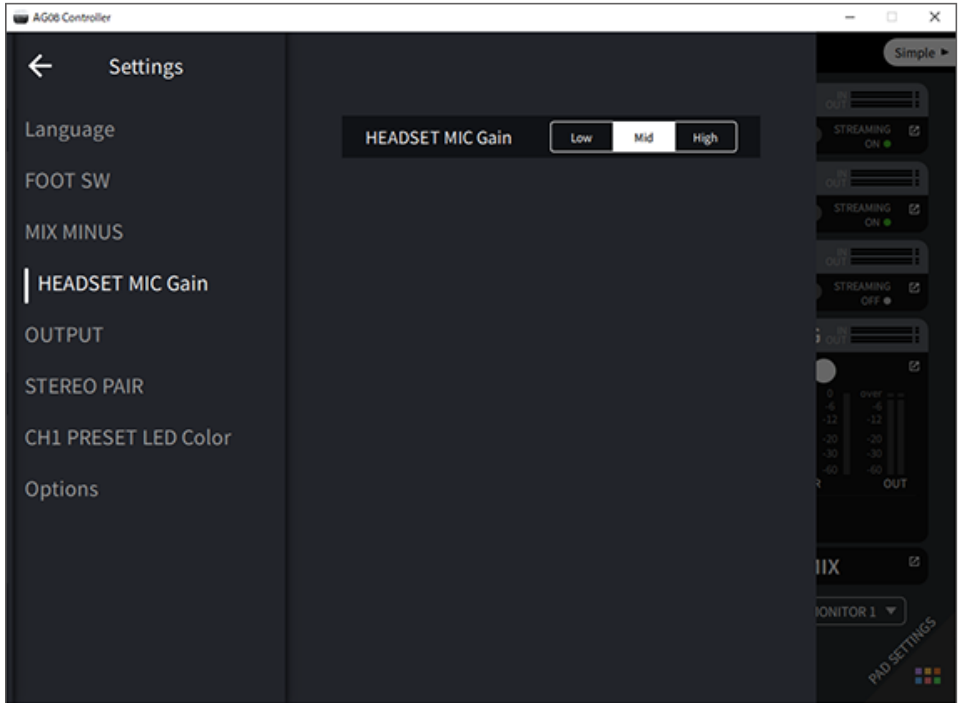

[HEADSET] headphones [🎧] output connector

Connect the headset's headphones here. Normally, the plug is light green. The audio that is output is the same as that of the headphones [🎧] output connector.

6 [MONITOR PHONES 1 (🎧)/MONITOR PHONES 2 (🎧)] knobs

These knobs adjust the volume for the headphones connected to the headphones [PHONES 1(🎧)/PHONES 2(🎧)] connectors or the [HEADSET] headphones [🎧] output connector.

7 [MIX MINUS CH1/MIX MINUS CH2] switch

When this is turned on (🔴), the sound inputted to channels 1 and 2 is not output to the [PHONES 1(🎧)/PHONES 2(🎧)] connectors (monitoring OFF). Use this when you don't want to hear your own voice during monitoring.

For example, turn the [MIX MINUS] switch on when there is no need to hear your own voice or your own playing in headphones during a livestream or when recording.

NOTE

- You can use the AG08 Controller app to add channels that are not outputted during monitoring. Press the menu [☰] button on the AG08 Controller, and select Settings → MIX MINUS to make the settings.
- When channels 1 and 2 are linked with STEREO PAIR (p.70) and you turn this on (☑), channel 1/2 are not output while monitoring, regardless of the settings in AG08 Controller.

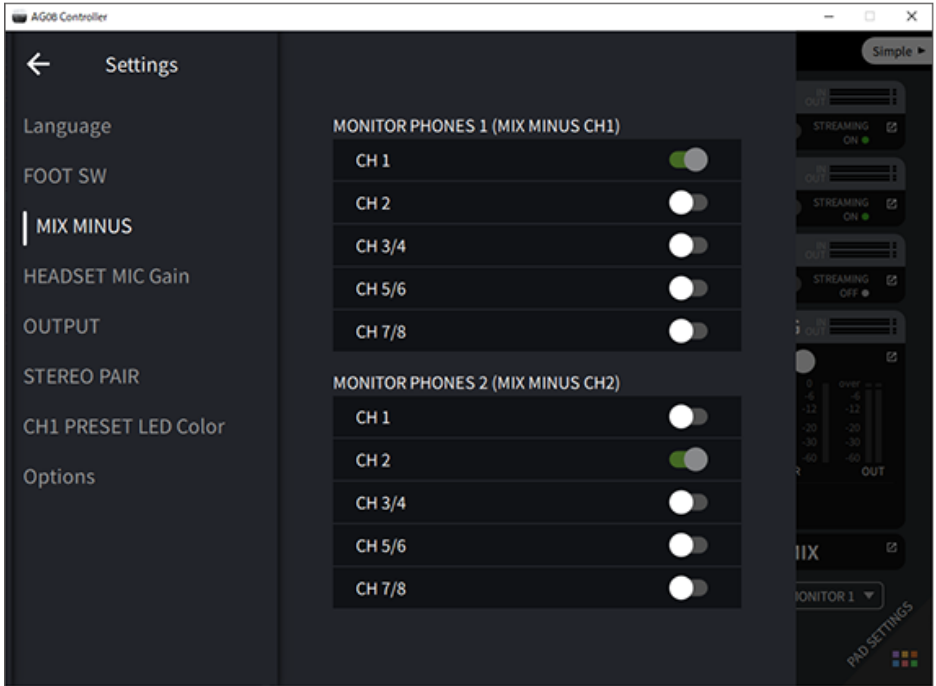

Top panel sound pad section

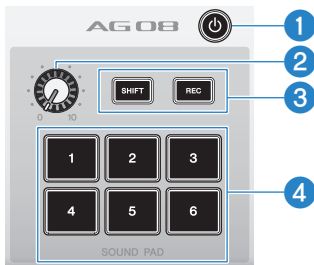

1 [⏻] (standby/on) switch

Toggles between power standby and on. To set this to standby while the power is on, long-press the switch for at least two seconds. It takes about eight seconds to completely switch to standby.

NOTICE

- Rapidly toggling this switch between standby and on may cause the product to malfunction. After you toggle the switch to standby, make sure to wait for at least six seconds before toggling the switch on again.

NOTE

The switch flashes when there is not enough power supplied from the computer.

2 Sound pad level knob

Adjusts the output level of the audio from the sound pad.

3 [SHIFT]/[REC] buttons

Use the [SHIFT]/[REC] buttons in combination with the [SOUND PAD] buttons to record with the sound pad. See “Recording to the sound pad” (p.77) for details.

4 [SOUND PAD] [1]–[6] buttons

These buttons play back/record audio files such as sound effects that you have previously registered. You can use these to record the sound pad data on this unit, or use the AG08 Controller app to import audio files. With AG08 Controller, you can select from six different colors for the button LEDs. Use AG08 Controller to change the LED colors. See “Using the sound pad” (p.75) for how to register the sound pad data.

Getting ready to use this product

Connecting to your computer and configuring the settings (Windows)

First, you must download and install the “Yamaha Steinberg USB Driver” from the following Yamaha website, so that your computer can recognize this product.

<https://www.yamaha.com/2/ag08/>

NOTE

- For the installation steps, see the installation guide found in the compressed file you downloaded.
- For a list of compatible operating systems, see the Yamaha website listed above.

- 1 Remove all USB devices from your computer except for the mouse and keyboard.**
- 2 Make sure that the volume on this product and on the connected device is turned all the way down.**
- 3 Connect the included AC adapter to the [12V] DC port on the rear panel, and slide the [POWER SOURCE] selector switch to [12V] DC (left side).**

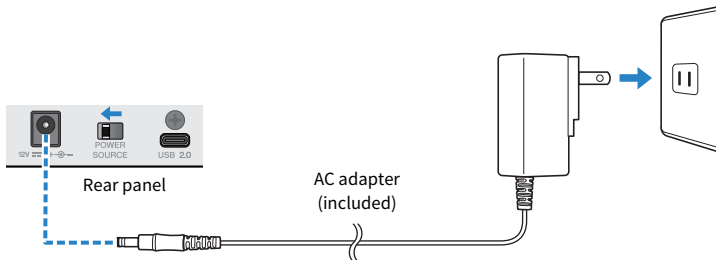

- 4 After installing the driver, use the included USB cable to connect this product to the computer.**

Connect the devices directly without using a USB hub.

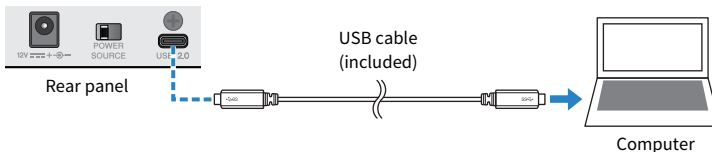

NOTE

If you are using a computer that doesn't have a USB-C port, use a commercially available USB-A to USB-C cable to connect the devices.

5 Turn the [⏻] (standby/on) switch on.

6 After the LED light animation on the top panel of this unit finishes, check whether the LED of the [⏻] (standby/on) switch on this product is lit.

If you've connected the devices before installing the driver, go ahead and install the driver.

Settings on the computer

Change the output/input setting on your computer to "AG08".

1 Open the "Search" box from the "Taskbar".

The method of opening the "Search" box may differ depending on your computer's settings.

2 Type "Sound" into the "Search" box screen, and then select "Sound Settings" from the menu that appears.

3 On the "Sound" screen, select [CH3/4 (Yamaha AG08)] in Output, and use the [LINE/USB] selector switch for channels 3/4 on this product to select "USB".

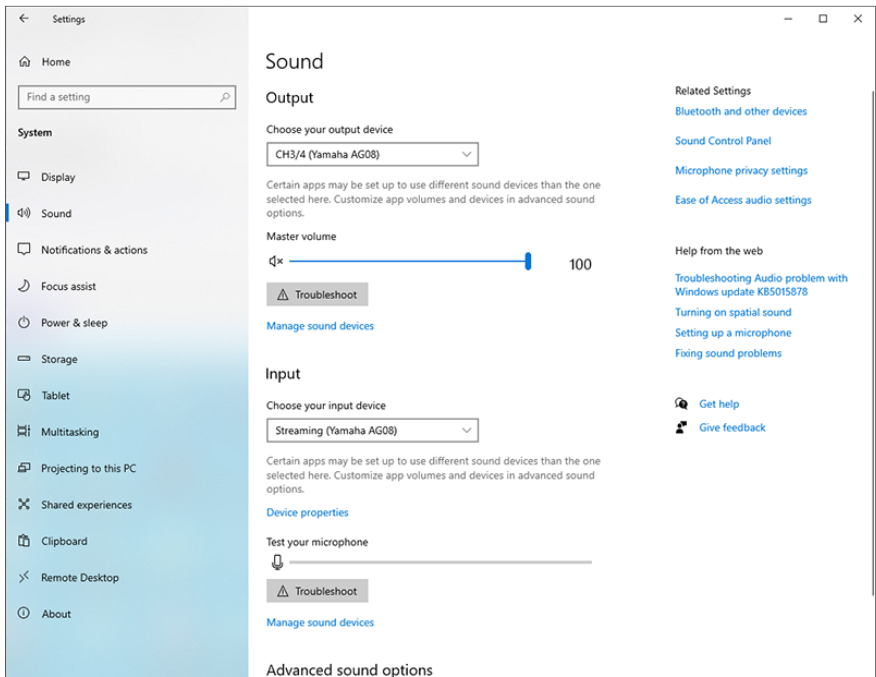

NOTE

- In step 3, when you select [CH5/6 (Yamaha AG08)] for Output, the computer starts outputting to the USB inputs of channels 5/6 on this product. Use the [LINE/USB] selector switch for channels 5/6 on this product to select "USB".
- In step 3, when you select [CH7/8 (Yamaha AG08)] for Output, the computer starts outputting to the USB inputs of channels 7/8 on this product. Use the [LINE/USB] selector switch for channels 7/8 on this product to select "USB".
- AG08 Controller app SOUND PAD audio files used for import or while adjusting the sound are output according to these settings.

4 On the "Sound" screen, select "Streaming (Yamaha AG08)" for the input.

The STREAMING OUT (mix for livestreaming) output from this product is inputted to the computer.

NOTE

- In step 4, when you select [Voice (Yamaha AG08)] for the input, only the channel 1 and channel 2 mix is inputted to the computer.
- In step 4, when you select [AUX (Yamaha AG08)] for the input, the AUX OUT from this product (see the block diagram for details) is inputted to the computer.

NOTE

This product can be powered by a computer that has a USB Type-C port supplying at least 5 V/1.5 A of current via a USB-C to USB-C cable, without the need to connect a AC adapter.

- 1) Remove all USB devices from your computer except for the mouse and keyboard.
- 2) Make sure that the volume on this product and on the connected device is turned all the way down.
- 3) After installing the driver, use the included USB cable to connect this product to the computer, and slide the [POWER SOURCE] selector switch on the rear panel to the [USB 2.0] port side (right side).

Connect the devices directly without using a USB hub.

- 4) Turn the [⏻] (standby/on) switch on.
- 5) After the LED light animation on the top panel of this unit finishes, check whether the LED of the [⏻] (standby/on) switch on this product is lit.

If you've connected the devices before installing the driver, go ahead and install the driver.

The LED of the [⏻] (standby/on) switch on this product flashes when there is not enough power supplied from the computer, and this product will not start up normally. In this case, use the included AC adapter.

Connecting to your computer and configuring the settings (Mac)

First, you must download and install the “Yamaha Steinberg USB Driver” from the following Yamaha website, so that your computer can recognize this product.

<https://www.yamaha.com/2/ag08/>

NOTE

- For the installation steps, see the installation guide found in the compressed file you downloaded.
- For a list of compatible operating systems, see the Yamaha website listed above.

- 1 Remove all USB devices from your computer except for the mouse and keyboard.**
- 2 Make sure that the volume on this product and on the connected device is turned all the way down.**
- 3 Connect the included AC adapter to the [12V] DC port on the rear panel, and slide the [POWER SOURCE] selector switch to [12V] DC (left side).**

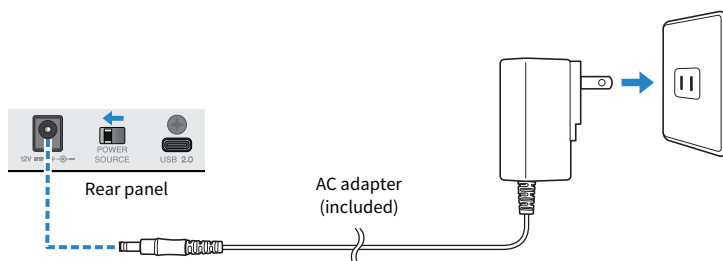

- 4 Use the included USB cable to connect this product to the computer.**

Connect the devices directly without using a USB hub.

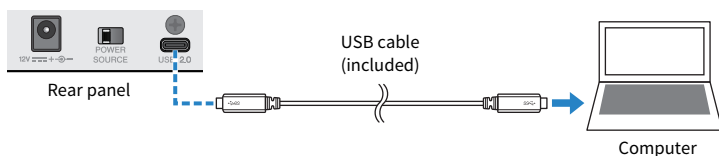

NOTE

If you are using a Mac that doesn't have a USB-C port, use a commercially available USB-A to USB-C cable to connect the devices.

- 5 After the LED light animation on the top panel of this unit finishes, check whether the LED of the [⏻] (standby/on) switch on this product is lit.**

Getting ready to use this product > Connecting to your computer and configuring the settings (Mac)

Settings on the computer

- 1 Open “Finder” → “Go” → “Applications” → “Utilities” → “Audio MIDI Setup”.
- 2 Select [Yamaha AG08 Streaming / CH3-4] from the list on the left side of the Audio Devices screen.

If the Audio Devices screen is not shown, select “Show Audio Devices” from the “Window” menu to make it appear.

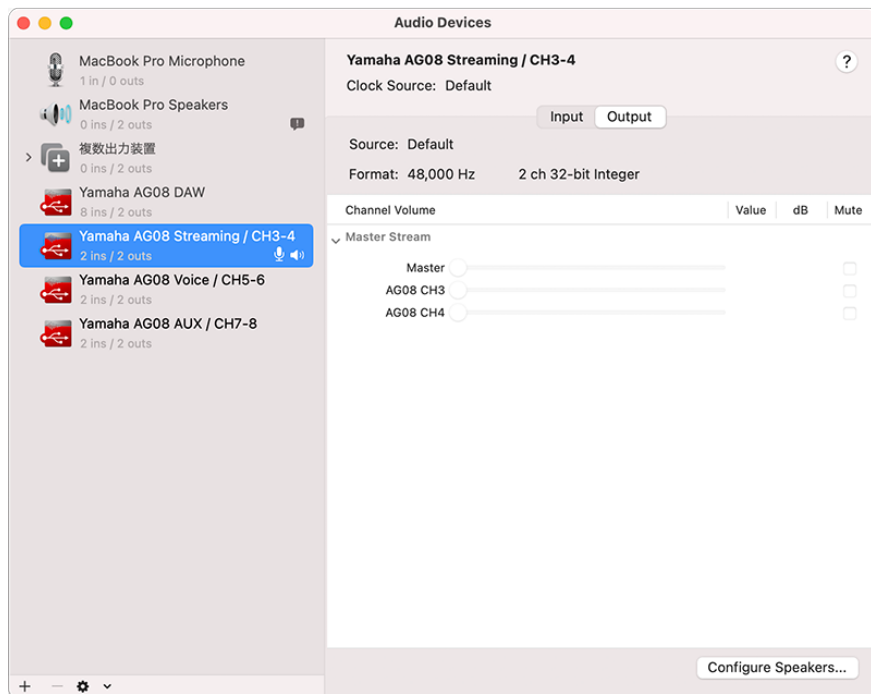

- 3 Click [v] at the bottom left of the screen and select “Use This Device For Sound Output”.
- 4 Similarly, select “Use This Device For Sound Input”.

Once you’ve finished steps 3 and 4, the mic and speaker icons at the bottom right of [Yamaha AG08 Streaming / CH3-4] in the list appear.

- 5 The **STREAMING OUT (mix for livestreaming) output from this product is inputted to the computer, and the computer starts outputting to the USB inputs of channels 3/4 on this product. Use the [LINE/USB] selector switch for channels 3/4 on this product to select “USB”.**

NOTE

- In step 2, when you select [Yamaha AG08 Voice / CH5-6], only the channel 1/2 mix from this product is inputted to the computer, and the computer starts outputting to the USB inputs of channels 5/6 on this product. Use the [LINE/USB] selector switch for channels 5/6 on this product to select “USB”.
- In step 2, when you select Yamaha AG08 AUX / CH7-8, the AUX OUT from this product (see the block diagram for details) is inputted to the computer, and the computer starts outputting to the USB inputs of channels 7/8 on this product. Use the [LINE/USB] selector switch for channels 7/8 on this product to select “USB”.
- AG08 Controller app SOUND PAD audio files used for import or while adjusting the sound are output according to these settings.

6 Quit “Audio MIDI Setup.”

NOTE

This product can be powered by a computer that has a USB Type-C port supplying at least 5 V/1.5 A of current via a USB-C to USB-C cable, without the need to connect a AC adapter.

- 1) Remove all USB devices from your computer except for the mouse and keyboard.
- 2) Make sure that the volume on this product and on the connected device is turned all the way down.
- 3) After installing the driver, use the included USB cable to connect this product to the computer, and slide the [POWER SOURCE] selector switch on the rear panel to the [USB 2.0] port side (right side).

Connect the devices directly without using a USB hub.

- 4) Turn the [⏻] (standby/on) switch on.
- 5) After the LED light animation on the top panel of this unit finishes, check whether the LED of the [⏻] (standby/on) switch on this product is lit.

If you've connected the devices before installing the driver, go ahead and install the driver.

The LED of the [⏻] (standby/on) switch on this product flashes when there is not enough power supplied from the computer, and this product will not start up normally. In this case, use the included AC adapter.

Connecting to an iPad/iPhone

This explains what to do to power this unit, up through connecting to an iPad/iPhone.

What you need

- Apple Lightning to USB 3 Camera Adapter and a commercially available USB-A to USB-C cable (for iPads and iPhones with a Lightning connector)
- Apple USB-C Digital AV Multiport Adapter and the included USB-C to USB-C charging cable (when using an iPad/iPhone with a USB-C connector)

NOTE

- When using this product for streaming or for long periods of time, have a power supply on hand to power your iPad/ iPhone.
- For a list of compatible operating systems, see the following Yamaha website.
 - <https://www.yamaha.com/2/ag08/>

1 Make sure that the volume on this product and on the connected device is turned all the way down.

2 Connect the included AC adapter to the [12V] DC port on the rear panel, and slide the [POWER SOURCE] selector switch to [12V] DC (left side).

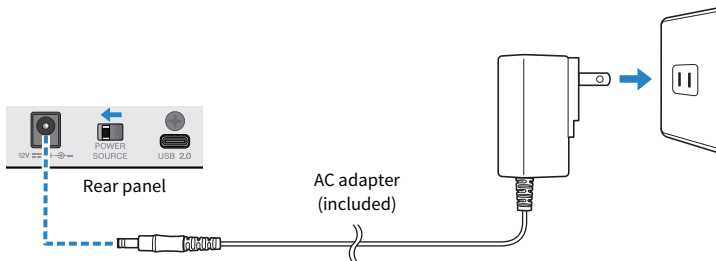

3 Turn the [⏻] (standby/on) switch on.

4 After the LED light animation on the top panel of this unit finishes, check whether the LED of the [⏻] (standby/on) switch on this product is lit.

5 Use a commercially available USB-A to USB-C cable to connect this product to an Apple Lightning to USB 3 Camera Adapter.

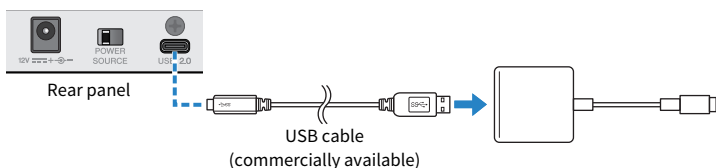

6 Connect the Apple Lightning cable to the iPad/iPhone.

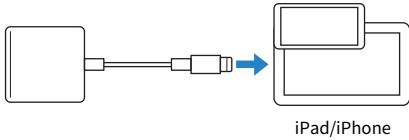

NOTE

If you're using an iPad/iPhone that features a USB-C connector, use the Apple USB-C Digital AV Multiport Adapter. You can also use the included USB-C cable to connect your iPad/iPhone directly to this product. However, the amount of time you can use the iPad/iPhone is limited by how much battery charge remains on that device.

This product is automatically recognized by the iPad/iPhone once connected.

There is no need to configure any settings on the iPad/iPhone.

Connecting to Android devices

This explains what to do to power this unit, up through connecting to an Android device.

What you need

- 3.5 mm 4-conductor stereo mini cable

NOTE

- This product can't input/output audio via the USB cable.
- The audio signal sent to the Android device is monaural.
- When using this product for streaming or otherwise using it for long periods of time, have a power supply on hand for powering your Android device.

- 1 Make sure that the volume on this product and on the connected device is turned all the way down.**
- 2 Connect the included AC adapter to the [12V] DC port on the rear panel, and slide the [POWER SOURCE] selector switch to [12V] DC (left side).**

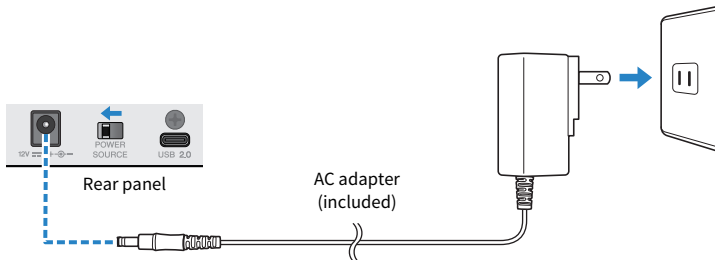

- 3 Turn the [⏻] (standby/on) switch on.**
- 4 After the LED light animation on the top panel of this unit finishes, check whether the LED of the [⏻] (standby/on) switch on this product is lit.**

5 Using a 3.5 mm four-conductor (TRRS) stereo mini cable, connect the [CH7/8 ()] LINE IN/OUT] smartphone input/output connector to the headset connector on your Android device.

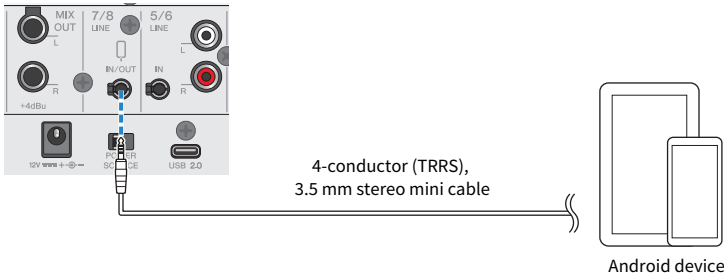

NOTE

- You will need a conversion adapter cable if your Android device does not have a connector for connecting stereo mini plugs.
 - For example, for Android devices that use a USB-C port to input/output audio, you'll need a USB-C to 3.5 mm four-conductor (TRRS) earphone connector conversion adapter cable.
- Use a four-conductor (TRRS) stereo mini cable, not a two- or three-conductor (TS/TRS) cable.

2-conductor (TS)	3-conductor (TRS)	4-conductor (TRRS)
 One insulator band	 Two insulator bands	 Three insulator bands
No	No	Yes

Once connected, use your music playback or recording app to test whether the audio is being inputted and outputted.

Using this product for livestreaming (17LIVE, Twitch, YouTube Live)

Using this product with your computer

This explains how to use this product with your Windows PC or Mac to configure the settings and make the necessary operations to livestream your voice or your singing to 17LIVE, Twitch, YouTube Live or other such services. (17LIVE, Twitch and YouTube Live are the names of streaming apps.)

What you need

- This product
- Windows or Mac computer (on which the AG08 Controller and livestreaming apps are installed)
- Install the “AG08 Controller” app from the following website.
<https://www.yamaha.com/2/ag08/>
- Headphones or earphones (PHONES 1: stereo phone plug or 3.5 mm stereo mini-plug) (PHONES 2: stereo phone plug)
- USB-C to USB-C cable (included), or a commercially available USB-A to USB-C cable
- AC adapter (included)
- Microphone

1 Connect this unit to your computer.

Connect by referring to “Getting ready to use this product” → “Connecting to your computer and configuring the settings (Windows)/(Mac)”.

- “Connecting to your computer and configuring the settings (Windows)” (p.26)
- “Connecting to your computer and configuring the settings (Mac)” (p.29)

Using this product for livestreaming (17LIVE, Twitch, YouTube Live) > Using this product with your computer

2 Connect your headphones or earphones to the output connector.

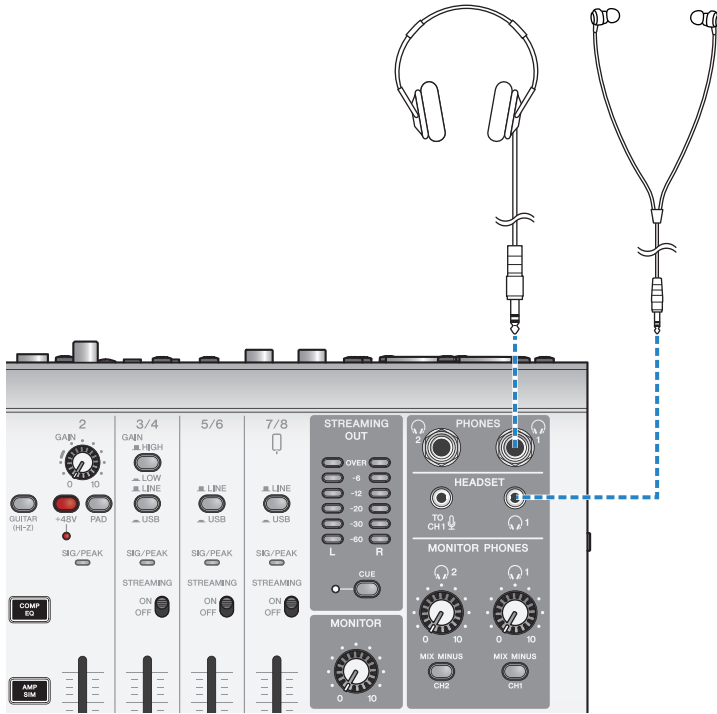

3 Connect the mic to the channel 1 mic/line input connector.

Connect a headset microphone to the [HEADSET] mic input connector.

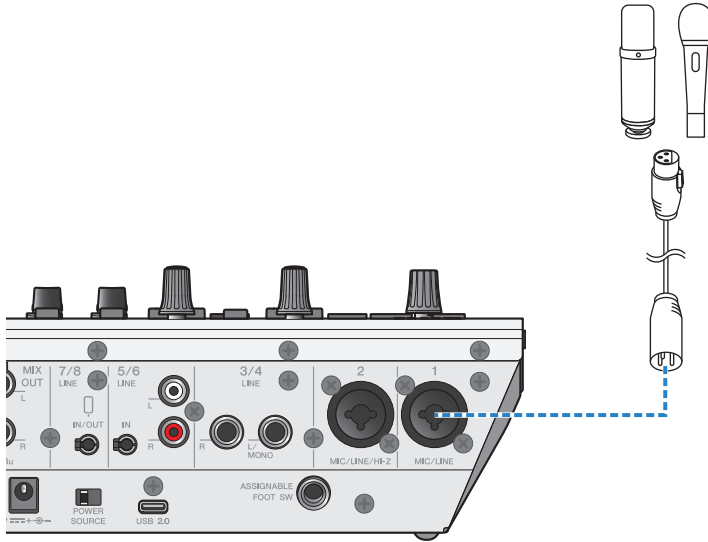

Now that you've made these connections, configure the settings for this unit.

4 Turn the [⏻] (standby/on) switch on.

5 Configure the settings on the AG.

Make the settings for each switch on the front panel as follows.



- [PAD] switch: off
- Phantom [+48V] switch: on (when using a condenser mic)
- Channel 1 [GAIN] knob, fader: as appropriate (see illustration)
- [MIX MINUS]: off

6 Use the Sound Check function to configure the connection with your computer and the levels on this product.

- About the Sound Check function

When using a computer, follow the instructions from the Sound Check function in the AG08 Controller app to configure the connection with your computer and the levels on this product.

Press the menu [☰] button on the AG08 Controller app and tap Sound Check to start the Sound Check function.

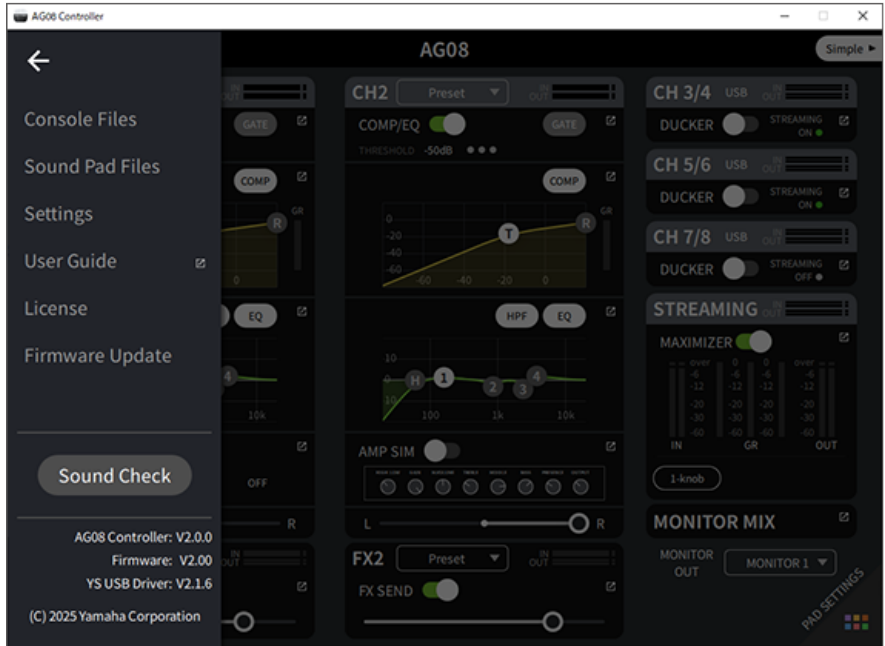

Using this product for livestreaming (17LIVE, Twitch, YouTube Live) > Using this product with your computer

Follow the instructions from the Sound Check function to configure the connection with your computer and the levels on this product.

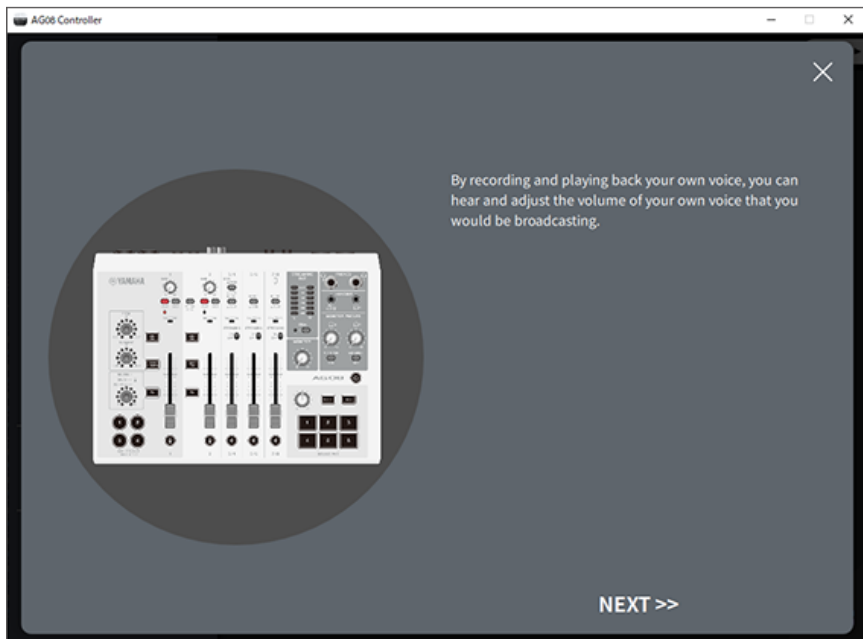

If the output/input settings for the computer are not finished, a sound settings screen like the one below is shown.

Using this product for livestreaming (17LIVE, Twitch, YouTube Live) > Using this product with your computer

Set the destination channels for the background music and voice chat audio.

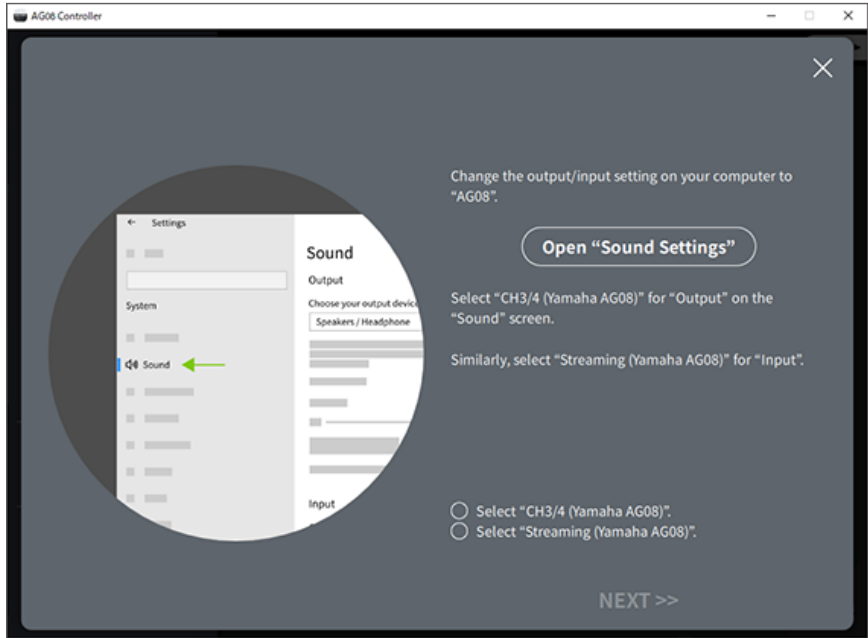

NOTE

- For Windows, see "Connecting to your computer and configuring the settings (Windows)" (p.26).
- For macOS, see "Connecting to your computer and configuring the settings (Mac)" (p.29).

7 Adjust the volume using the [MONITOR PHONES] [🔊] knob while speaking into the mic.

Adjusting the volume using the [MONITOR PHONES] [🔊] knob has no effect on the volume of the livestreaming audio.

8 Start the livestream.

Use the faders to adjust the respective volumes.

Launch the livestreaming app and check the balance for the listeners.

NOTE

See "Audio-related and other issues" (p.85) if you don't hear any sound.

Livestreaming with OBS

Here, we explain how to use OBS, as an example of how to use livestreaming software. To download and install OBS, see the official OBS website.

1 Launch OBS, and open the "Settings" screen from "File".

Using this product for livestreaming (17LIVE, Twitch, YouTube Live) > Using this product with your computer

- 2 On the left-hand navigation menu, click “Audio”.**
- 3 For the “Desktop Audio” settings in “Global Audio Devices”, use “Default” or “Disabled”.**
- 4 Similarly, for the “Mic/Auxiliary Audio” settings in “Global Audio Devices”, use the [Streaming (Yamaha AG08)] setting.**
- 5 On the left-hand navigation menu, click “Stream”.**
- 6 Select the streaming service to use, and input the stream key as necessary that you received from the service.**
- 7 Close the “Settings” screen.**
- 8 Start the livestream.**

NOTE

To chat on Discord while streaming a game, set the input device in the “Audio Settings” of Discord to “AG08 Voice”, and set the output device to “AG08 CH5/6”. Set the [LINE/USB] selector switch for channels 5/6 to [USB].

Streaming a conversation on your smartphone via computer

When you want to stream the conversation you’re having on your smartphone via the computer (such as when guests are participating via phone call), use a 3.5 mm four-conductor (TRRS) stereo mini cable to connect the [LINE 7/8 IN/OUT] smartphone input/output connector to the headset connector on your smartphone (iPhone, Android device, etc.).

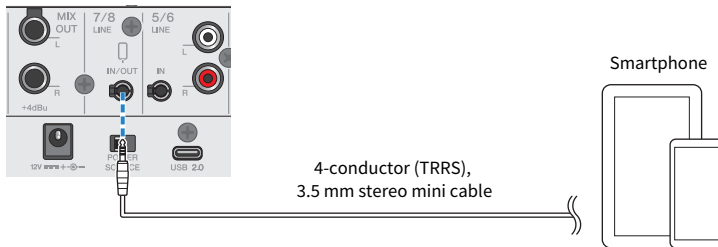

The default output setting for the smartphone input/output connector is AUX, which prevents the other party’s own voice from looping back to them when you are making a smartphone call.

NOTE

You will need a conversion adapter cable if your smartphone does not have a connector for connecting stereo mini plugs. For example, for Android devices that use a USB-C port to input/output audio, you’ll need a USB-C to 3.5 mm four-conductor (TRRS) earphone connector conversion adapter cable. For iPhones equipped with a Lightning connector, you will need a Lightning to 3.5 mm Headphone Jack Adapter.

Using with an iPad/iPhone

This explains how to configure the settings and use this product with your iPad/iPhone to livestream your voice or your singing to 17LIVE, Twitch, YouTube Live or other such services. (17LIVE, Twitch and YouTube Live are the names of streaming apps.)

What you need

- This product
- iPad/iPhone
 - When using an iPad, search for and install the “AG08 Controller” app in the App Store. (Note that AG08 Controller cannot be used on iPhones.)
- Headphones or earphones (PHONES 1: stereo phone plug or 3.5 mm stereo mini-plug) (PHONES 2: stereo phone plug)
- Apple Lightning to USB 3 Camera Adapter and a commercially available USB-A to USB-C cable (for iPad/iPhone with a Lightning connector)
- Included USB-C to USB-C cable (when connecting to an iPad/iPhone that features a USB-C connector)
- AC adapter (included)
- Microphone

1 Connect your iPad/iPhone.

Make the necessary connections by referring to “Getting ready to use this product” → “Connecting to an iPad/iPhone”.

- “Connecting to an iPad/iPhone” (p.32)

Using this product for livestreaming (17LIVE, Twitch, YouTube Live) > Using with an iPad/iPhone

2 Connect your headphones or earphones to the output connector.

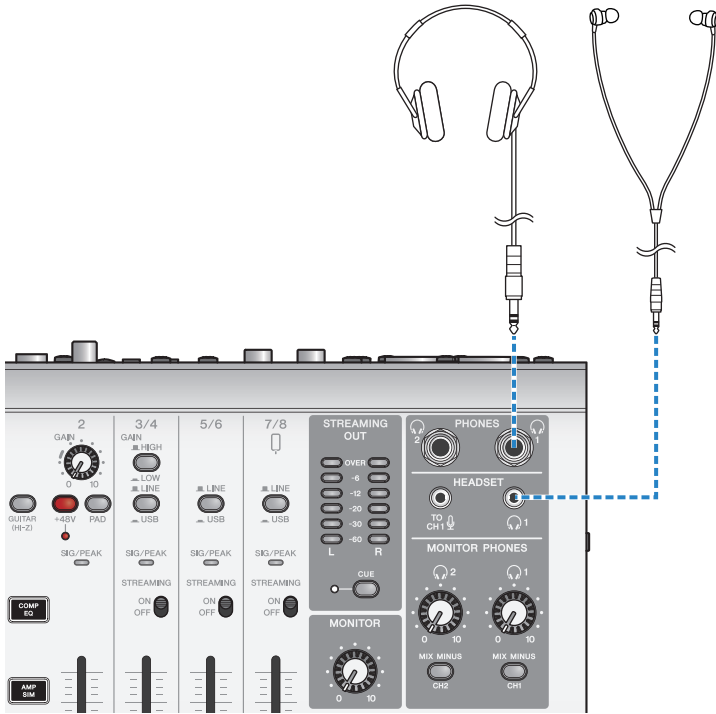

Using this product for livestreaming (17LIVE, Twitch, YouTube Live) > Using with an iPad/iPhone

3 Connect the mic to the channel 1 mic/line input connector.

Connect a headset microphone to the [HEADSET] mic input connector.

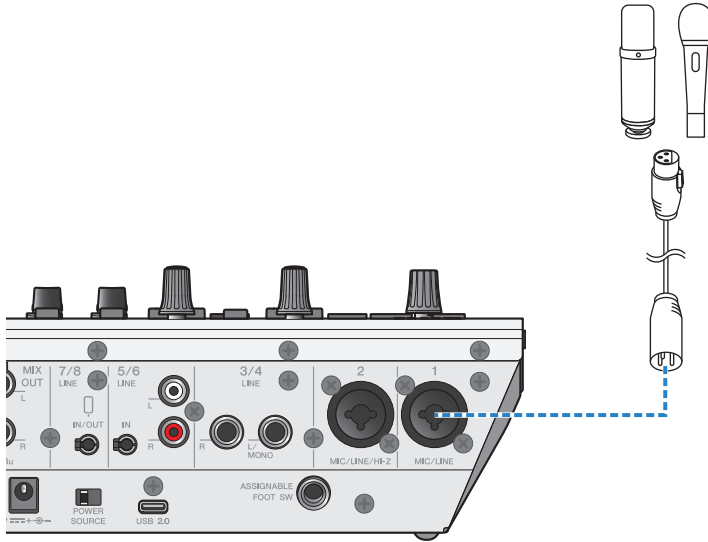

Now that you've made these connections, configure the settings for this unit.

4 Turn the [⏻] (standby/on) switch on.

5 Configure the settings on the AG.

Make the settings for each switch on the front panel as follows.

- [PAD] switch: off
- Phantom [+48V] switch: on (when using a condenser mic)
- Channel 1 [GAIN] knob, fader: as appropriate (see illustration)
- [MIX MINUS]: off



6 Use the Sound Check function to configure the connection with your iPad and the levels on this product.

- About the Sound Check function

When using an iPad, follow the instructions from the Sound Check function in the AG08 Controller app to configure the connection with your computer and the levels on this product.

Press the menu [☰] button on the AG08 Controller app and tap Sound Check to start the Sound Check function.

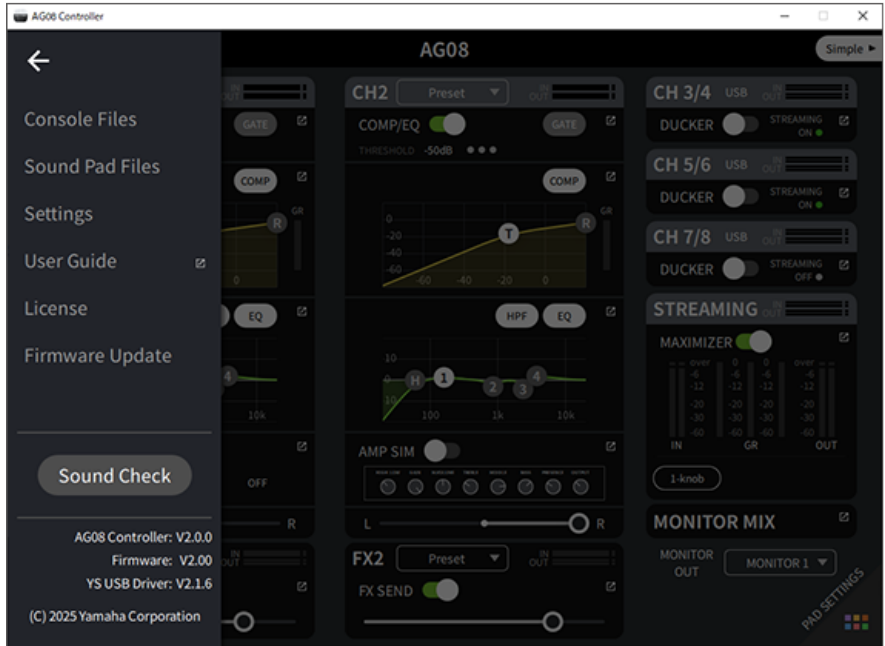

Using this product for livestreaming (17LIVE, Twitch, YouTube Live) > Using with an iPad/iPhone

Follow the instructions from the Sound Check function to configure the connection with your iPad and the levels on this product.

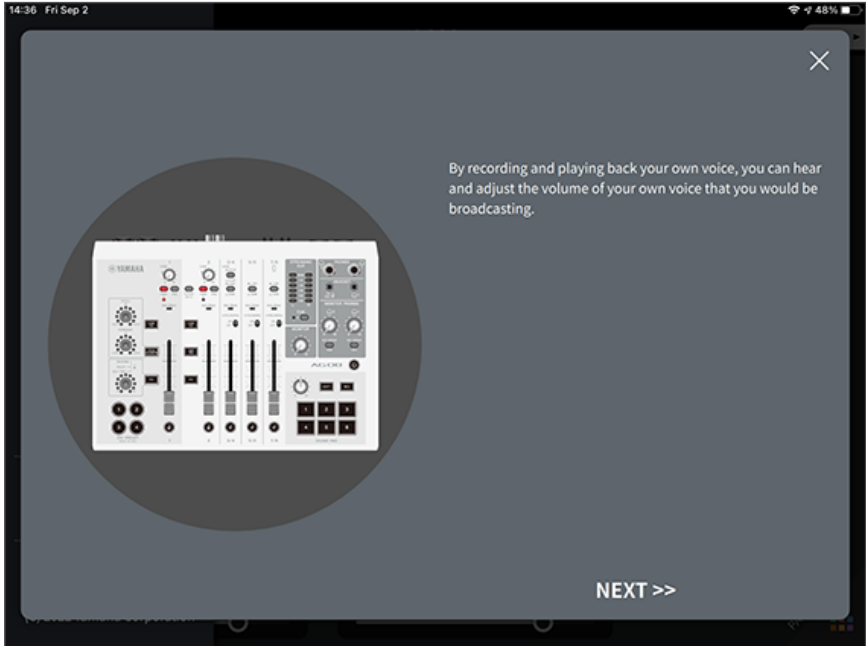

7 Adjust the volume using the [MONITOR PHONES] [] knob while speaking into the mic.

Adjusting the volume using the [MONITOR PHONES] [] knob has no effect on the volume of the livestreaming audio.

8 Start the livestream.

Use the faders to adjust the respective volumes.

Launch the livestreaming app and check the balance for the listeners.

NOTE

See “Audio-related and other issues” (p.85) if you don’t hear any sound.

Using this product for livestreaming (17LIVE, Twitch, YouTube Live) > Using this product with an Android device

Using this product with an Android device

This explains how to configure the settings and use this product with your Android device to livestream your voice or your singing to 17LIVE, Twitch, YouTube Live or other such services. (17LIVE, Twitch and YouTube Live are the names of streaming apps.) When using your Android device for these voice streaming apps, the sound from this product will not be sent to the apps even when connected via USB cable. You'll need to connect using a 3.5 mm 4-conductor (TRRS) stereo mini cable.

What you need

- This product
- Android device
- Headphones or earphones (PHONES 1: stereo phone plug or 3.5 mm stereo mini-plug) (PHONES 2: stereo phone plug)
- 3.5 mm 4-conductor stereo mini cable
- AC adapter (included)
- Microphone

1 Connect your Android device.

Make the necessary connections by referring to “Getting ready to use this product” → “Connecting to Android devices”.

- “Connecting to Android devices” (p.34)

Using this product for livestreaming (17LIVE, Twitch, YouTube Live) > Using this product with an Android device

2 Connect your headphones or earphones to the output connector.

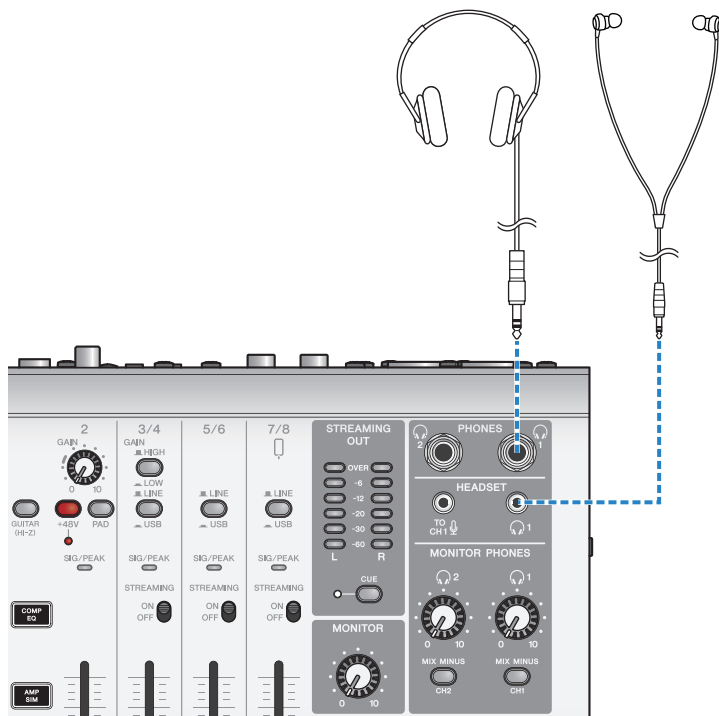

Using this product for livestreaming (17LIVE, Twitch, YouTube Live) > Using this product with an Android device

3 Connect the mic to the channel 1 mic/line input connector.

Connect a headset microphone to the [HEADSET] mic input connector.

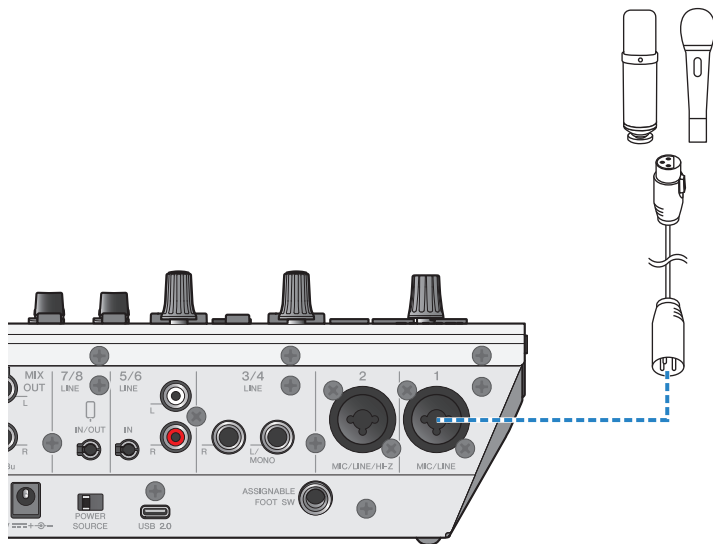

4 Turn the [⏻] (standby/on) switch on.

Using this product for livestreaming (17LIVE, Twitch, YouTube Live) > Using this product with an Android device

5 Configure the settings on the AG.



Make the settings for each switch on the front panel as follows.

- [PAD] switch: off
- Phantom [+48V] switch: on (when using a condenser mic)
- Channel 1 [GAIN] knob, fader: as appropriate (see illustration)
- [MIX MINUS]: off

6 Adjust the volume using the [MONITOR PHONES] [🔊] knob while speaking into the mic.

Adjusting the volume using the [MONITOR PHONES] [🔊] knob has no effect on the volume of the livestreaming audio.

7 Start the livestream.

Use the faders to adjust the respective volumes.

Launch the livestreaming app and check the balance for the listeners.

NOTE

See “Audio-related and other issues” (p.85) if you don’t hear any sound.

Operations while livestreaming

This explains the operations you can use while livestreaming.

■ Mute the mic

If you will be leaving your seat or otherwise taking a break during the livestream, turn the [] button on (the LED lights up), so that the sound from the mic is not broadcasted.

■ Adding reverb to your voice

To add reverb to the mic audio, switch the [FX] button on (the LED lights up).

Using this product for livestreaming (17LIVE, Twitch, YouTube Live) > Connecting your musical instrument or music player

Connecting your musical instrument or music player

This shows you how to connect your musical instrument or music player and configure the settings to add background music or sound effects.

■ Connecting an instrument

Connect the guitar to the channel 2 [CH2 MIC/LINE/HI-Z] connectors using an unbalanced phone cable, and turn the [GUITAR (HI-Z)] switch on (▲).

Connect your digital piano, synthesizer or other digital instrument to the [CH3/4 LINE] connector, and set the [LINE/USB] selector switch to LINE.

■ Connecting a music player

Connect your music player to the [CH5/6 LINE] connectors or to the [CH7/8 LINE IN/OUT] connectors, and set the [LINE/USB] selector switch to LINE.

NOTE

You may need a conversion cable, an effects unit or other means to connect your instrument. Check the method for connecting that applies to your instrument.

Using this product for a podcast

Using WaveLab Cast

WaveLab Cast is an app for Windows and Mac that's optimal for producing podcast audio/video contents. The app allows you to easily record, edit and stream your content.

WaveLab Cast setup:

Refer to the following page to download the app and activate the license.

<https://www.steinberg.net/getwavelabcast>

NOTE

You will need a download access code to download this app. This code is listed on the printed WaveLab Cast Download Information that's included with this product.

The WaveLab Cast manual can be obtained by searching at the following website.

<https://steinberg.help/>

Using this product in music production

Using Cubase AI with your computer

Use Cubase AI in combination with this product to record and edit audio and so on. Cubase AI is DAW software for music production that lets you record, playback and edit audio using your computer.

Cubase AI setup:

Refer to the following page to download the app and activate the license.

<https://www.steinberg.net/getcubaseai>

NOTE

You will need a download access code to download this app. This code is listed on the printed Cubase AI Download Information that's included with this product.

The Cubase AI manual can be obtained by searching at the following website.

<https://steinberg.help/>

Using Cubasis LE with an iPad/iPhone

Use Cubasis LE in combination with this product to record and edit audio. Cubasis LE is a basic version of the mobile DAW Cubasis. As with Cubasis, this is a music production app that lets you record, play back and edit audio from your iPad/iPhone.

To use this app, search for and download “Cubasis LE” from the App Store.

For more details on Cubasis LE, see the following Steinberg website.

<https://www.steinberg.net/getcubasisle>

Using the dedicated app

Using AG08 Controller

To make detailed settings for this product, use the AG08 Controller app. AG08 Controller is an intuitive application that's easy to operate. Here's a brief summary of how the app works.

[Detail] mode: SOUND SETTING screen

Use this screen to configure the signal processing for each channel.

Press the [🔍] button for the respective field opens the detailed settings screen.



Using the dedicated app > Using AG08 Controller

The screen shown below contains the detailed settings for the EQ.



You can edit the various parameters with the following operations.

- Moving the sliders
- Moving the handles in the graph
- Typing a value into the parameter text box

NOTE

- The above operations are only available when you see a slider, handle or parameter text box for the respective parameter.
- Double-click the value of a parameter to show the parameter text box.

[Simple] mode

Use this mode to make easy settings for the channel 1 effects by selecting your use case (vocal character, mic type and so on).

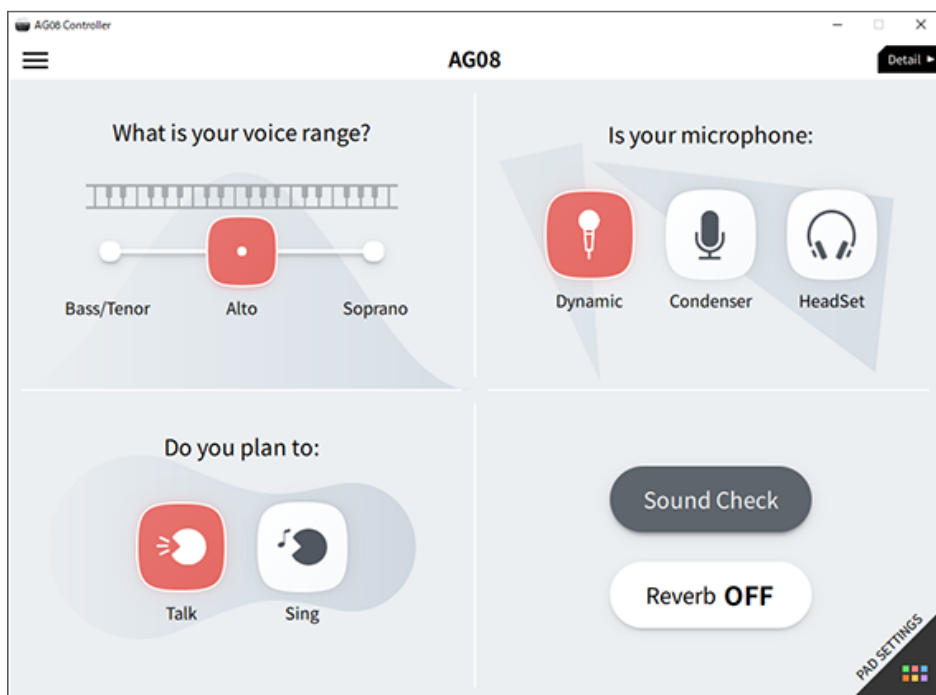

Using the dedicated app > Using AG08 Controller

PAD SETTINGS screen

Use this screen to configure the sound pad-related settings.



Using the dedicated app > Using AG08 Controller

Other menus

[Detail] mode: press the [☰] button at the top left of the SOUND SETTING screen or [Simple] screen to show the menu. This also shows the screens for making other detailed settings, backing up the data and so on.

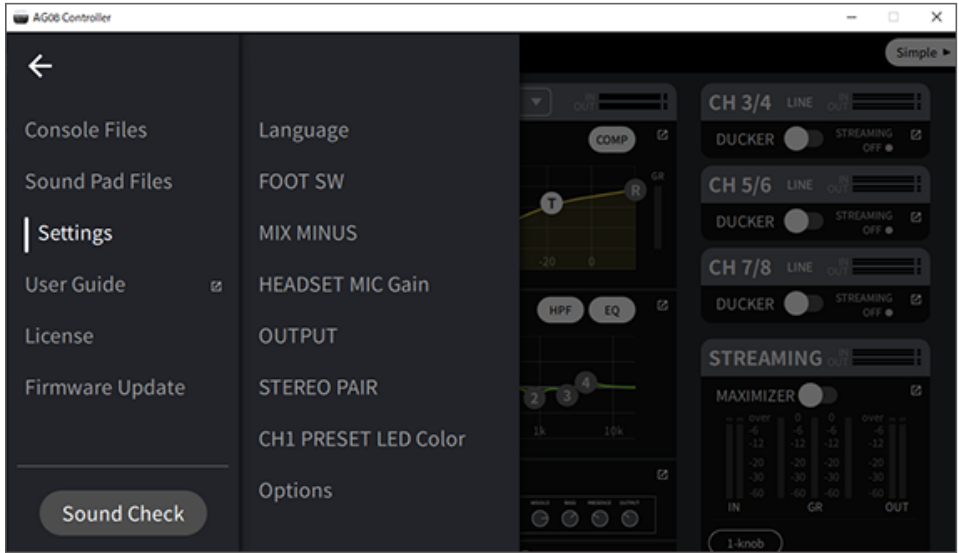

Using the GATE function

About the GATE

Reducing the ambient noise picked up by a mic

Channels 1 and 2 on the AG08 feature a built-in GATE function. When you're not speaking into the mic, this function automatically lowers the input audio level to attenuate the ambient noise. When you speak into the mic, the function restores the volume to its original setting.

Use the AG08 Controller app to configure the GATE settings. On the Detail mode screen in the AG08 Controller app, press the [GATE] button for the channel 1/2 GATE field to configure the GATE.

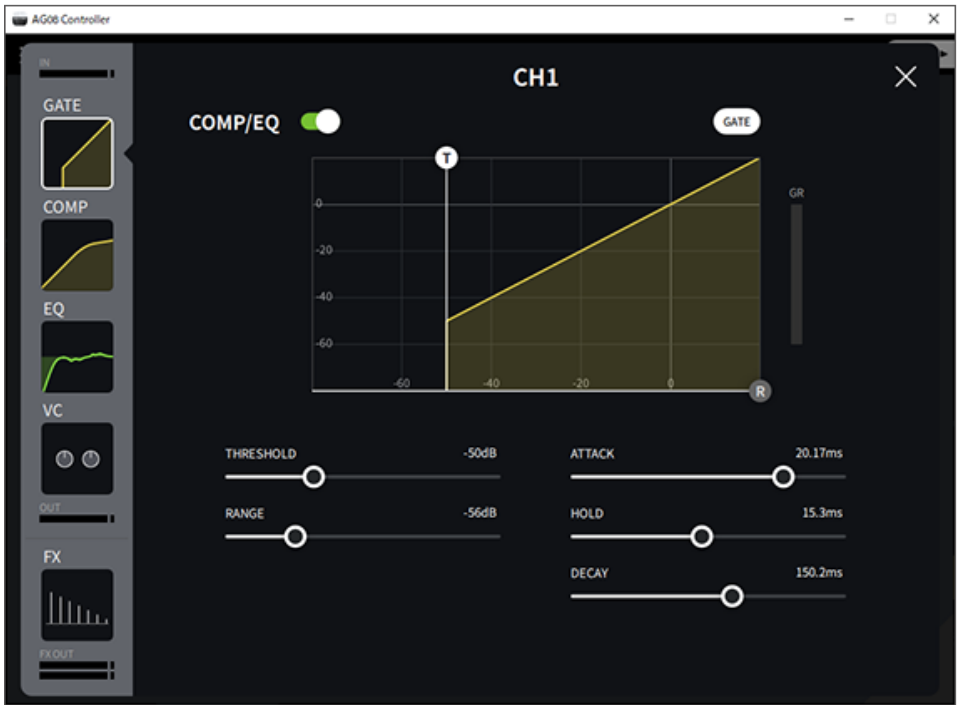

NOTE

When channels 1 and 2 are linked as a STEREO PAIR (p.70), both channels 1 and 2 share the same GATE settings.

Using the COMP function

About the COMP

Levels out the differences in the mic input volume

Channels 1 and 2 on the AG08 feature a built-in COMP function. The COMPRESSOR compresses the level of audio signals that exceed the set threshold, smoothing out any noticeable changes in volume. The COMPANDER H and COMPANDER S smooth out the changes in volume, while still retaining similar sound pressure levels and reducing ambient noise. COMPANDER H offers greater noise attenuation, whereas COMPANDER S uses less noise attenuation.

Use the AG08 Controller app to configure the COMP settings. On the Detail mode screen in the AG08 Controller app, press the [Z] button for the channel 1/2 COMP field to configure the COMP.



NOTE

When channels 1 and 2 are linked as a STEREO PAIR (p.70), both channels 1 and 2 share the same COMP settings.

Using the voice changer

Adjusting the voice formant and pitch

- 1 Turn on the [VOICE CHANGER] button for channel 1.

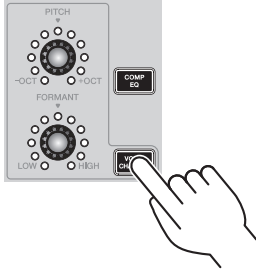

- 2 Use the [PITCH] and [FORMANT] knobs to adjust the voice formant and pitch to your liking.

You can use the AG08 Controller app to recall presets that you've already created, or to add effects like Radio Voice or Pitch Fix.

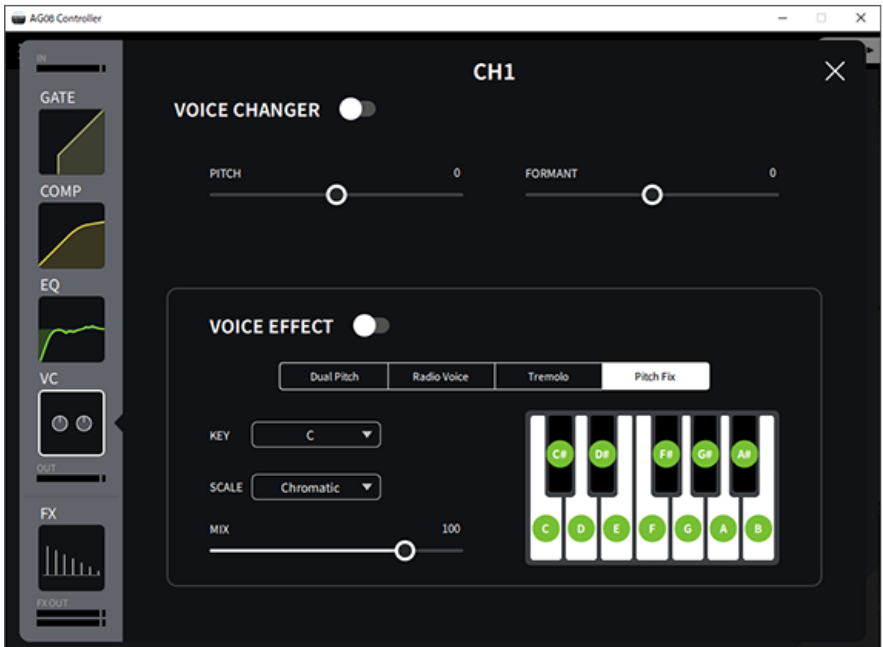

Using the voice changer > Adjusting the voice formant and pitch

NOTE

When channels 1 and 2 are linked as a STEREO PAIR (p.70), the voice changer is turned off.

Using the presets

Recalling the presets

You can use the [CH1 PRESET] [1]–[4] buttons to recall the effect settings (presets) you've saved.

1 Press a [CH1 PRESET] button ([1]–[4]) to recall a preset.

The selected preset buttons lights up, and the effect settings (preset) are recalled. Pressing the button again makes it go dark, and the unit returns to the state it was in before you selected the preset.



NOTE

- When you adjust the effects after recalling a preset, the preset button flashes.
- The mute, fader level and pan settings are not saved.
- When channels 1 and 2 are linked as a STEREO PAIR (p.70), presets cannot be recalled and the preset buttons go dark.

Saving a preset

This shows how to save the effect settings to a preset button.

- 1 Use the controls and the AG08 Controller app to adjust the effects.**
- 2 Press and hold a [CH1 PRESET] button to which you wish to save ([1]-[4]), for at least two seconds.**

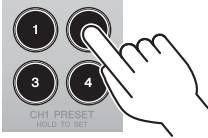

NOTE

- With AG08 Controller, you can select from six different colors for the button LEDs. Press the menu [☰] button on the AG08 Controller app, and select Settings → CH1 PRESET LED Color to make the settings.

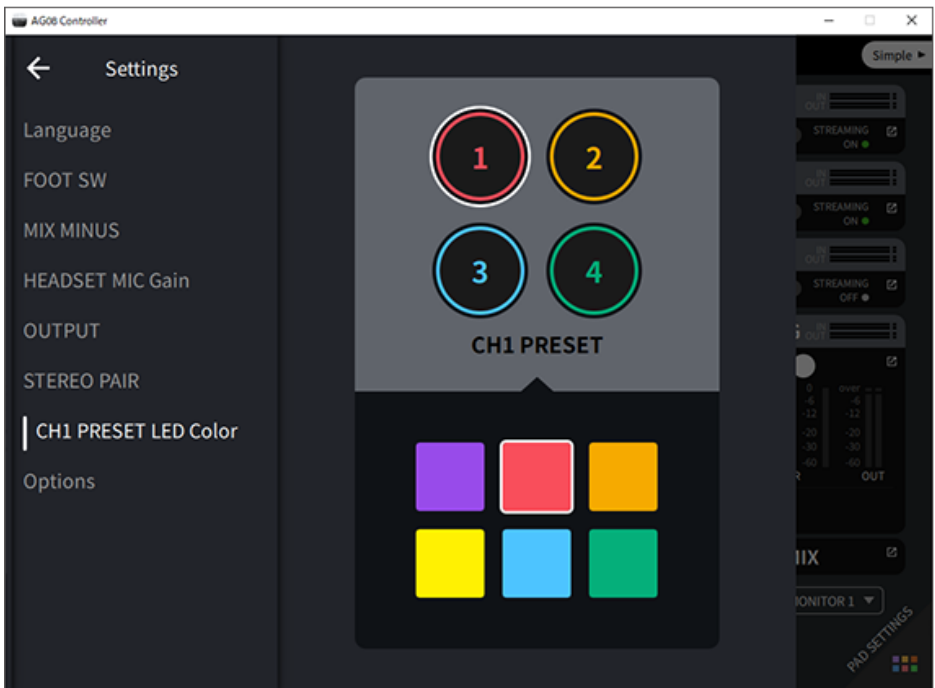

- When channels 1 and 2 are linked as a STEREO PAIR (p.70), presets cannot be registered and the preset buttons go dark.

Using STEREO PAIR

About STEREO PAIR

Channels 1 and 2 on the AG08 feature a built-in STEREO PAIR function. You can use STEREO PAIR to link channel 1 with channel 2, creating a single stereo channel. For example, this function is useful for ASMR streaming, which uses a stereo or binaural mic.

Use the AG08 Controller app to configure the STEREO PAIR settings. Press the menu [☰] button on the AG08 Controller, and select Settings → STEREO PAIR. A popup window appears when you press the STEREO PAIR [🔗] button. Select [OK]. The STEREO PAIR screen shown below is shown on the Detail mode screen.



NOTE

- Settings that are shared by channels 1/2 when linked are gate/compressor/equalizer, reverb/delay, mute and MONITOR MIX.
- The [GAIN] knob on this unit as well as the phantom [+48V] switch, the [PAD] switch and the [GUITAR (HI-Z)] switch (CH2) are not shared via link.
- When you turn the link on, the voice changer (CH1)/amp simulator (CH2) turn off, and you cannot recall or save presets.
- You can control the output level for the channel 1/2 input audio by operating the channel 1 fader.
- When STEREO PAIR is being used, STEREO PAIR is canceled when you switch to the Simple mode screen from the Detail mode screen.

Using the DUCKER function

About the DUCKER

Attenuating the channel 3/4–7/8 levels according to the mic input

Channels 3/4–7/8 on the AG08 feature a built-in DUCKER function. With this function, the volume of background music or other audio inputted to channels 3/4 through 7/8 is automatically attenuated when someone speaks into a mic connected to channel 1 or 2, without the need to operate the faders yourself. Once the person stops speaking into the mic, this function automatically brings the audio back up to its original level.

Use the AG08 Controller app to configure the DUCKER settings. On the Detail mode screen in the AG08 Controller app, press the [M] button for the channel 3/4, 5/6 or 7/8 field to configure the DUCKER.

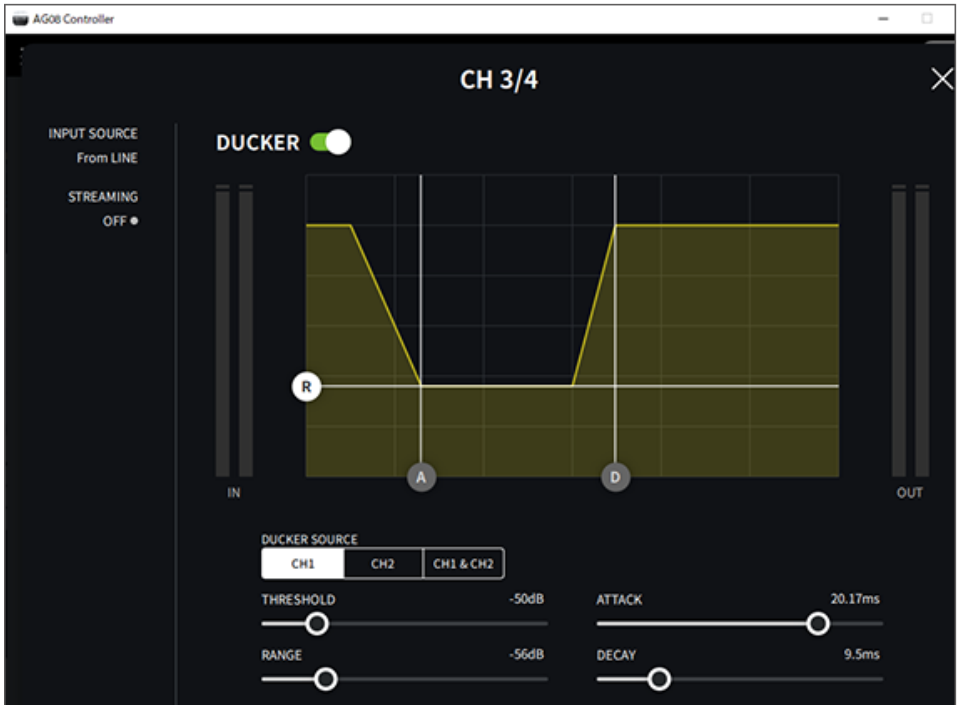

Using the MAXIMIZER function

About the MAXIMIZER

Leveling out the volume for livestreaming

The STREAMING OUT on the AG08 features a built-in MAXIMIZER function, which is a multi-band compressor. You can use this to minimize changes in volume and maximize the sound pressure levels, by setting a compressor for the LOW, MID and HIGH frequency bands.

Use the AG08 Controller app to configure the MAXIMIZER settings. On the Detail mode screen in the AG08 Controller app, press the [M] button in the STREAMING field to configure the MAXIMIZER.

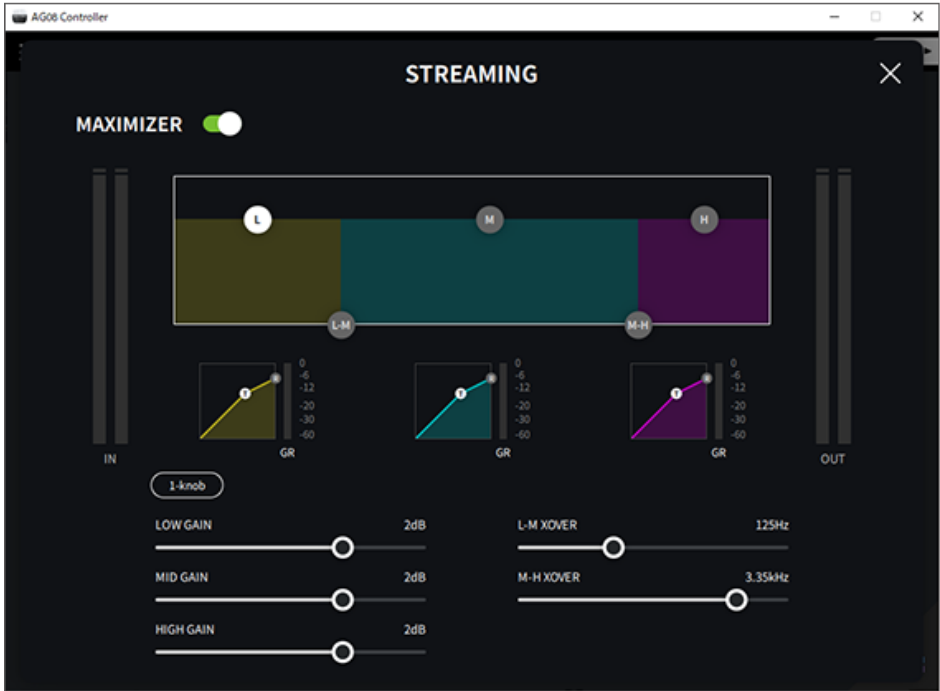

Adding delay to the streaming audio

About STREAMING OUT DELAY

You can add DELAY to the output (STREAMING OUT) used for streaming on the AG08. Make use of this feature when you need to correct timing discrepancies between the audio and the streaming video.

Use the AG08 Controller app to configure the STREAMING OUT DELAY settings. Press the menu [☰] button on AG08 Controller, and select Settings → OUTPUT → DELAY to configure the settings.

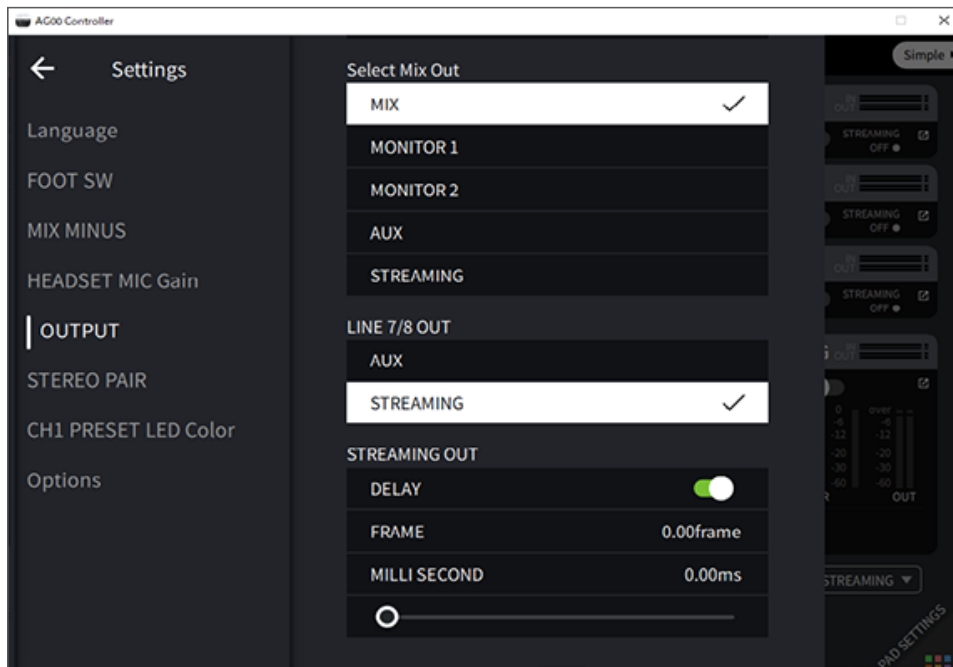

Adjusts the balance of sound being monitored

About MONITOR MIX

You can change the balance of sound you hear through headphones or other audio equipment. Use this function to lower the volume of your own voice or of a musical performance when monitoring, raise the volume of the game sound and so forth.

Use the AG08 Controller app to configure the MONITOR MIX settings. On the Detail mode screen in the AG08 Controller app, press the [MIX] button in the MONITOR MIX field to configure the MONITOR MIX settings.

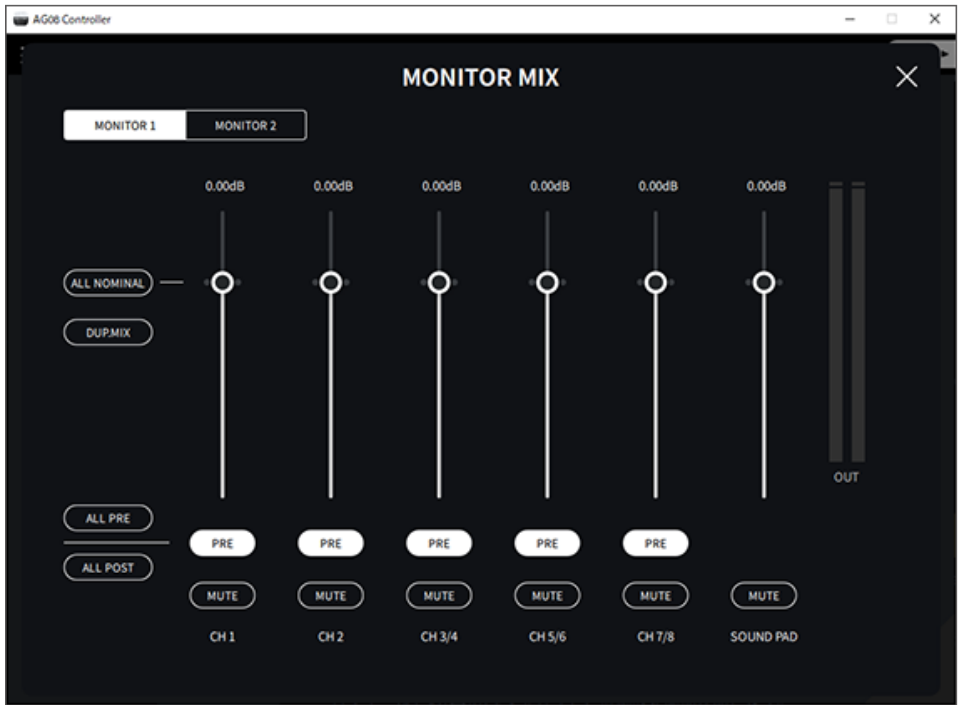

NOTE

- You can set separate volume balances for MONITOR1 and MONITOR2.
- Adjusting the volume using MONITOR MIX has no effect on the volume of the livestreaming audio.
- When channels 1 and 2 are linked as a STEREO PAIR (p.70), the channel 1/2 output level, mute on/off and PRE/POST settings work in tandem.
- The effect that's heard when the [MIX MINUS CH1/MIX MINUS CH2] switches are on do not change, regardless of the MONITOR MIX settings.

Using the sound pad

Using the sound pad for playback

You can assign and play back audio files assigned to the six buttons of the sound pad. Use these for playing jingles or sound effects to match the situation. You can use the AG08 Controller app to set the volume and playback method for each pad.

1 Press a button ([1]–[6]) on the SOUND PAD.

This plays back the audio file that's assigned to the SOUND PAD button you pressed.

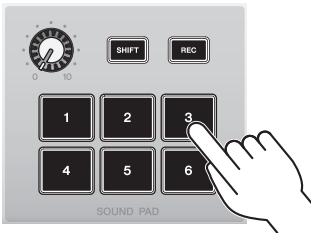

If the playback mode is set to ONE SHOT, playback starts from the beginning when you press a pad, continues once to the end and stops.

If the playback mode is set to HOLD, playback repeats as long as you hold down the pad.

If the playback mode is set to LOOP, the audio file plays back in a loop (repeatedly) when you press a pad, and stops when you press the pad again.

2 Turn the sound pad level knob to adjust the playback level.



Using the sound pad > Making detailed settings for each pad

Making detailed settings for each pad

You can configure the detailed settings for each pad ([1]–[6]) from the PAD SETTINGS screen in the AG08 Controller app.



Select the pad to configure in the top left part of the screen. Set the parameters in the bottom left part of the screen for the pad you selected, including the name (Rename), the pad's LED color, waveform display, playback mode, pad output level and FX send level.

Make the settings for the FX (reverb) on the right side of the screen.

Recording to the sound pad

NOTE

The available recording time is five seconds.

1 Press the [REC] button.

The product enters REC STANDBY mode.

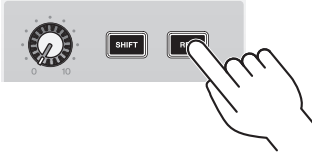

To exit REC STANDBY mode, press the [SHIFT] button and the [REC] button at the same time.

2 Use the [SOUND PAD] [1]–[6] buttons to select the pad to which you will record.

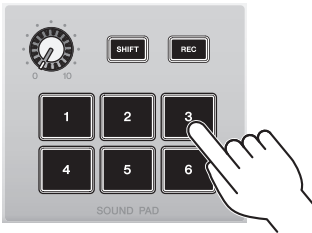

NOTE

When you long-press a pad to select it, you can check the contents of that sound pad while the button is pressed.

3 To start recording, press the REC button again.

Recording starts. When you press the [SHIFT] and [REC] buttons at the same time, the recorded data is saved in this unit, and the unit exits REC STANDBY mode. If you don't want to save the data, press the [SHIFT] button and the [SOUND PAD] button of the record destination at the same time. Doing so erases the recorded data and returns the unit to REC STANDBY mode.

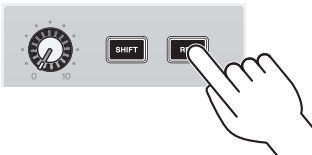

Using the sound pad > Recording to the sound pad

NOTE

If the AG08 Controller app is connected, data begins synchronizing between the AG08 Controller app and this unit, and the [SOUND PAD] [1]-[6] buttons flash blue in a cyclical manner. You cannot operate this product while synchronization is in progress. Do not turn off the AG08, quit the AG08 Controller app or unplug the USB cable while data is synchronizing.

Assigning audio files to the sound pad

You can import audio files from your computer or iPad in .wav, .flac or .mp3 format to this unit, adjust the length and assign them to the SOUND PAD [1]–[6] buttons on the top panel.

Select the pad to configure in the upper left part of the PAD SETTINGS screen, and press the [🔊] button in the “waveform view” field to display the screen shown below.

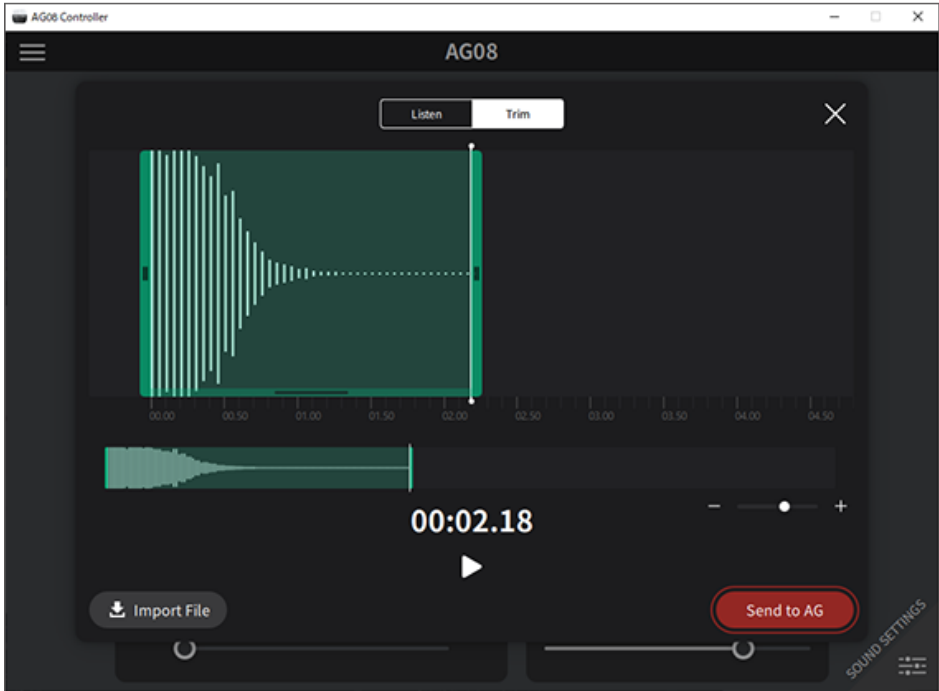

Press the [Import File] button to select an audio file and import the data into the AG08 Controller app. Use the onscreen controls to adjust the length of the audio file, and press the [Send to AG] button to send the data to the AG08. You can adjust the length and trim (delete) the silence at the beginning and end of the recorded data, both for audio files saved on your computer or iPad and for data saved on the AG08.

NOTE

- You cannot operate the [SOUND PAD] [1]–[6] buttons on the AG08 while data is being sent. Do not turn off the AG08, quit the AG08 Controller app or unplug the USB cable while data is being sent.
- Audio files that are longer than 30 minutes cannot be imported.
- A maximum of five seconds of linear PCM data (16-bit, 48 kHz) is saved on the AG08.

Updating this unit

Updating the firmware of this unit

To update the firmware of the AG08, use the firmware update function in AG08 Controller for Mac or AG08 Controller for Windows.

NOTE

You can't update the firmware on the AG08 Controller for iPadOS app that's used for the iPad.

Getting ready

Use a USB cable to connect the AG08 to your computer, on which Yamaha Steinberg USB Driver and AG08 Controller are installed.

Steps to follow

- 1 Turn on the AG08.**
- 2 Launch AG08 Controller.**

Updating this unit > Updating the firmware of this unit

- 3** If the firmware version of the AG08 is older than that of the firmware installed on the AG08 Controller, a firmware update screen appears automatically. Check the version and press the [START] button.



This starts the firmware update.

During the update, the channel 1, 2 [+48V] LEDs on the AG08 flash alternately and all other LEDs go dark.

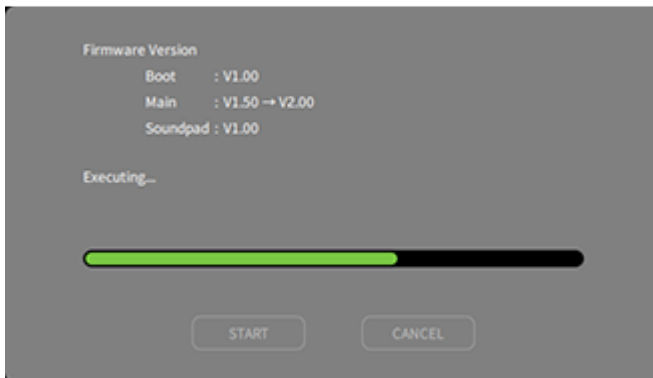

Updating this unit > Updating the firmware of this unit

4 Once the update is finished, a confirmation screen appears. Press the [OK] button.

Now you're finished with the firmware update.

If you've pressed the [CANCEL] button in step 3, you can press the AG08 Controller menu [☰] button to select Firmware Update, after which the firmware update screen appears.

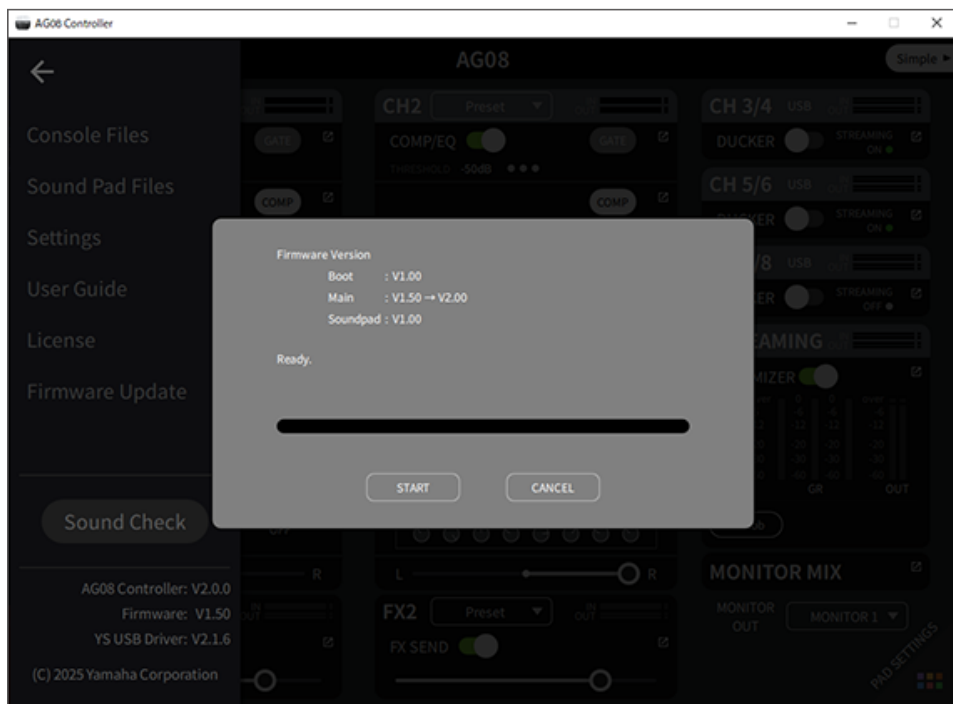

Updating this unit > Updating the firmware of this unit

NOTE

If the firmware version of the AG08 is newer than or the same as the version used for updating, the following message is shown and the firmware cannot be updated.

- If the AG08 firmware version is newer

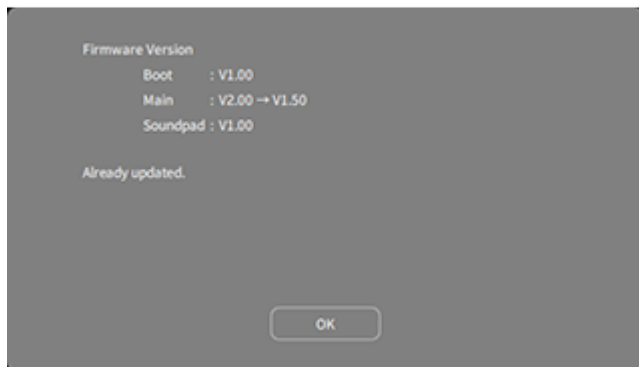

- If the AG08 firmware version is the same

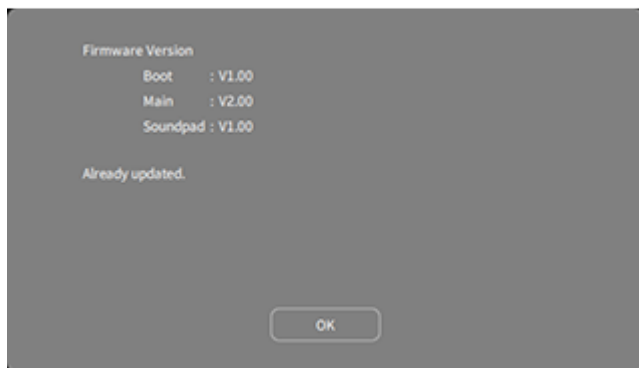

Troubleshooting

Power-related

The power LED will not light up

● Is the power of this product turned on?

The LED will not light up if this product is not turned on.

- This product must be supplied power from the included AC adapter. Connect the included AC adapter to the [12V] DC port on the rear panel.

The power LED is flashing, or lights only intermittently

● There might be a problem with the power supply.

- The LED flashes when there is some kind of problem with the power supply. Connect the included AC adapter to the [12V] DC port on the rear panel.

● Are you using the appropriate USB cable?

- Make sure to use the included USB cable.
- For iPads/iPhones with a Lightning connector: an Apple Lightning to USB 3 Camera Adapter and a commercially available USB-A to USB-C cable is required.

Audio-related and other issues

Your computer (Windows PC/Mac) does not recognize this product

● Have you installed the driver?

You must install the Yamaha Steinberg USB Driver if you wish to connect this product to a computer (Windows PC/Mac).

- Refer to the following website for how to install the Yamaha Steinberg USB Driver.
<https://www.yamaha.com/2/ag08/>

No sound is heard

● Are you using the appropriate settings for the [STREAMING ON/OFF] switch?

● Are any external devices (such as a mic) or powered monitor speakers connected correctly?

● Are the connecting cables shorted out or otherwise disconnected?

● Have you turned on the power of any connected electronic instruments or powered monitor speakers?

● Are the [GAIN] knob, the faders, the [MONITOR] knob and the [MONITOR PHONES] [🎧] knob adjusted appropriately?

● Is the [LINE/USB] selector switch set correctly?

● Is the [GAIN HIGH/LOW] selector switch set correctly?

- Set the switch to [HIGH]. If the volume from the sound source is too low, you may not be able to hear the sound when this switch is set to [LOW].

● Is the [MIX MINUS] switch turned on?

● If you are using Internet livestreaming software, have you adjusted the volume in the software?

Sound is distorted or noisy

● Is the channel [SIG/PEAK] LED lit up red?

- Try lowering the [GAIN] knob and turning the [PAD] switch on.

● Are the [OVER] indicators (red) on the [STREAMING OUT] LED level meters lit up?

- Adjust the fader for each channel. [OVER] does not go dark on the [STREAMING OUT] LED level meters, even though the volume is turned down on the [MONITOR] and [MONITOR PHONES] [🎧] knobs.

● Are the levels set too high on the devices connected to this product?

- Lower the volume of the connected devices.

● Is the [LINE/USB] selector switch set correctly?

● Is the [GAIN HIGH/LOW] selector switch set correctly?

- Set the switch to [LOW]. If the volume from the sound source is too high, the sound may distort when the switch is set to [HIGH].

Making the vocals or speech sound clearer

● **Set the [COMP EQ] button to on (the button lights up orange).**

- A parameter that's appropriate for Internet livestreaming is already set for this button by factory default, which keeps down unnecessary noise in the low end and helps smooth out differences in the input levels.

Reverb is not applied

● **Is the FX effect type for channel 1 set to REVERB?**

The [VOICE CHANGER] button, [AMP SIM] button, channel 2 fader, [CH1 PRESET] button, [PITCH] knob and [FORMANT] knob are unresponsive

● **STEREO PAIR (p.70) may be on. Turn STEREO PAIR off as necessary.**

Restoring the product to factory default settings (initialization)

Follow the steps below to initialize and restore the product to its factory default settings. This initializes all of the settings including the parameters you modified using the AG08 or the AG08 Controller app, the CH1 PRESET data, the SOUND PAD audio data and so on.

- 1 Set the [⏻] (standby/on) switch to standby for the time being.**
- 2 Set the [⏻] (standby/on) switch to on while holding down the [COMP EQ] button for channel 1.**

All of the LEDs on the top panel flash twice, and initialization begins. Wait until the LED light animation is finished. Initialization takes about 50 seconds.

Appendix

General specifications

0 dBu = 0.775 Vrms, Output impedance of signal generator (Rs) = 150 Ω

All level controls are nominal if not specified. The nominal knob setting is at the three-o'clock position.

Frequency response	Input channels *4 →MONITOR OUT	+0.5 dB/-1.5 dB (20 Hz to 20 kHz) with a nominal output level reference @ 1 kHz; GAIN knob: min
Total harmonic distortion *1 (THD+N)	Input channels *4 →MONITOR OUT	0.03 % @ 0 dBu (20 Hz to 20 kHz); GAIN knob: min
		0.008 % @ +4 dBu (1 kHz), GAIN knob: min
Hum and noise *2 (20 Hz to 20 kHz)	Equivalent input noise	-128 dBu (mono input channel, Rs: 150 Ω; GAIN knob: max)
	Residual output noise	-93 dBu (MONITOR OUT, MONITOR knob: min)
Crosstalk (1 kHz) *3 *4		-80 dB
Input channels		Monaural (MIC/LINE): 2, including HEADSET MIC (plug-in power) input (CH 1 MIC and HEADSET MIC cannot be used simultaneously), Stereo (LINE): 3
Output channels		MONITOR OUT: 1, MIX OUT: 1, PHONES: 2, AUX OUT: 1
Input channel features	PAD (CH1, CH2)	26 dB
	DSP	CH1: COMP/EQ, VOICE CHANGER, REVERB, MUTE
		CH2: COMP/EQ, AMP SIM, REVERB, MUTE
		CH 3/4, 5/6, 7/8: DUCKER, MUTE
PEAK LED	Red LED lights up when signal level is 3 dB below clipping level	
Output channel features	DSP	SOUND PAD
		MAXIMIZER, CUE, DELAY
Level meter	USB OUTPUT level	2 × 6 segment LED meters
USB audio	8 IN / 14 OUT	USB Audio Class 2.0 compliant; sampling frequency up to 48 kHz; bit depth: 24-bit
Phantom power voltage		+48 V
FOOT SW		INPUT MUTE, TAP TEMPO, VOICE EFFECT, OUTPUT DIMMER
Power requirements		DC 12 V, 1.5 A / USB Type-C 5 V, 1.5 A
Power consumption		7.5 W
Dimensions (W × H × D)		290 mm × 88 mm × 222 mm
Net weight		2.2 kg
Included accessories		PA-150B AC adapter, USB 2.0 cable (1.5 m), Start Guide, Safety Guide, WaveLab Cast Download Information, Cubase AI Download Information
Optional accessories		FC5 foot switch
Operating temperature		0 to +40°C

*1 Measured with 22 kHz LPF.

*2 Measured with A-weighting filter.

*3 Measured with 1 kHz band pass filter.

*4 Not including the headset mic (plug-in power) input and the AUX OUT circuit.

Input / Output characteristics

Analog Input Characteristics

0 dBu = 0.775 Vrms

Input Terminals	PAD 26 dB	GAIN Trim / SW Position	Actual Load Impedance	Nominal impedance	Input level			Connectors
					Sensitivity *1	Nominal	Max. before clip	
MIC/LINE 1-2	OFF	10	3 k Ω	50-600 Ω Mics/Lines	-76 dBu (0.123 mV)	-60 dBu (0.775 mV)	-50 dBu (2.451 mV)	Combo *2 (balanced)
		0			-30 dBu (24.50 mV)	-14 dBu (154.6 mV)	-4 dBu (489.0 mV)	
	ON	10			-50 dBu (2.451 mV)	-34 dBu (15.46 mV)	-24 dBu (48.90 mV)	
		0			-4 dBu (489.0 mV)	+12 dBu (3.085 V)	+22 dBu (9.757 V)	
HEADSET MIC	-	HIGH	1.5 k Ω *4	-	-58 dBu (0.976 mV)	-42 dBu (6.156 mV)	-32 dBu (19.47 mV)	3.5 mm phone for CH 1 HEADSET MIC (plug-in power / unbalanced)
		MID			-48 dBu (3.085 mV)	-32 dBu (19.47 mV)	-22 dBu (61.56 mV)	
		LOW			-38 dBu (9.757 mV)	-22 dBu (61.56 mV)	-12 dBu (194.7 mV)	
INPUT CH2 GUITAR *5	OFF	10	1 M Ω	-	-72 dBu (0.195 mV)	-56 dBu (1.228 mV)	-46 dBu (3.884 mV)	Phone *3 (unbalanced)
		0			-26 dBu (38.84 mV)	-10 dBu (245.1 mV)	0 dBu (775.0 mV)	
	ON	10			-46 dBu (3.884 mV)	-30 dBu (24.51 mV)	-20 dBu (77.50 mV)	
		0			0 dBu (0.775 V)	-	+10 dBu (2.451 V)	
LINE 3/4	-	HIGH	10 k Ω	600 Ω line	-24 dBu (48.90 mV)	-8 dBu (308.5 mV)	+2 dBu (975.7 mV)	LINE 3/4 phone *3 (unbalanced)
		LOW			-14 dBu (154.6 mV)	+2 dBu (975.7 mV)	+12 dBu (3.085 V)	
LINE 5/6, 7/8	-	-	10 k Ω	600 Ω line	-24 dBu (48.90 mV)	-8 dBu (308.5 mV)	+2 dBu (975.7 mV)	LINE 5/6 RCA pin and 3.5 mm phone *6 (unbalanced) LINE 7/8 3.5 mm phone *7 (CTIA)

*1 "Input sensitivity" is the lowest level that will produce an output of +4 dBu (1.23 V) or the nominal output level when the unit is set to maximum gain (all level controls are at their maximum position)

*2 1 & Sleeve = GND, 2 & Tip = HOT, 3 & Ring = COLD

*3 Tip = Signal, Sleeve = GND

*4 For CH 1, HEADSET MIC

*5 For CH 2, GUITAR switch is ON

Appendix > Input / Output characteristics

*6 Tip = Signal L, Ring = Signal R, Sleeve = GND

*7 Tip = Signal L, Ring 1 = Signal R, Ring 2 = GND, Sleeve = Output for smartphone

Analog Output Characteristics

0 dBu = 0.775 Vrms

Output Terminals	Actual Source Impedance	Nominal impedance	Output level		Connectors
			Nominal	Max. before clip	
MONITOR OUT [L, R]	150 Ω	10 kΩ line	+4 dBu (1.228 V)	+14 dBu (3.884 V)	XLR-3-32 *8 Phone *9 (balanced)
MIX OUT [L, R]	150 Ω	10 kΩ line	+4 dBu (1.228 V)	+14 dBu (3.884 V)	Phone *9 (balanced)
PHONES	120 Ω	40 Ω phone	1.5 mW + 1.5 mW	6 mW + 6 mW	Phone 3.5 mm phone
AUX OUT	150 Ω	1.5 kΩ line	-30 dBu (24.51 mV)	-20 dBu (77.50 mV)	3.5 mm phone *10 (CTIA)

*8 1 = Ground, 2 = Hot, 3 = Cold

*9 Tip = HOT, Ring = COLD, Sleeve = GND

*10 Tip = Signal L, Ring 1 = Signal R, Ring 2 = GND, Sleeve = Output for smartphone

Digital Input / Output Characteristics

Terminals	Format	Data Length	Fs	Connectors
USB	USB Audio Class 2.0 / Yamaha Steinberg USB Driver	24-bit	48 kHz	USB Type-C

The contents of this guide apply to the latest specifications as of the publishing date.

Dimensions

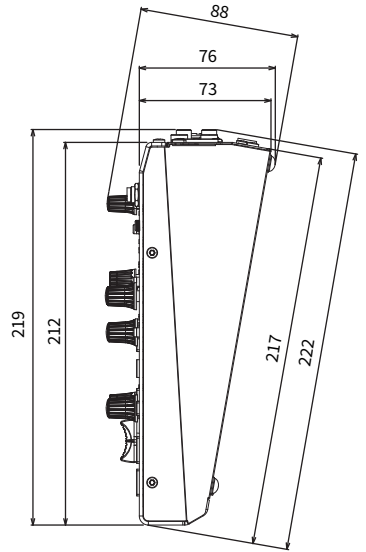
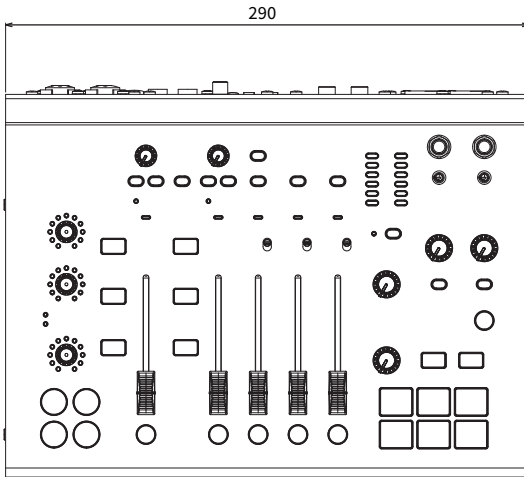
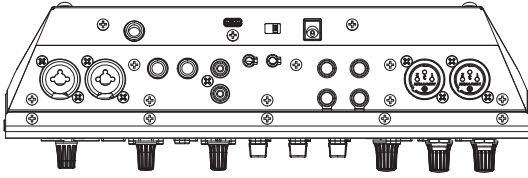

Units: mm

Block diagram

See the following Yamaha website for the AG08 block diagram.

<https://www.yamaha.com/2/ag08/>

Level diagram

See the following Yamaha website for the AG08 level diagram.

<https://www.yamaha.com/2/ag08/>

Yamaha Pro Audio global website
<https://www.yamahaproaudio.com/>

Yamaha Downloads
<https://download.yamaha.com/>

© 2023 Yamaha Corporation

Published 01/2025 AM-C0