



YAMAHA

Clavinova

CVP-98
CVP-96
CVP-600

Reference Manual
Referenzanleitung
Manuel de référence
Manual de referencia

Table of Contents (English)

Messages	2
Troubleshooting	6
MIDI and Data Compatibility	8
MIDI Data Format	9
MIDI Implementation Chart	25
Voice List	26
Drum/key Assignment List	32
Style List	34
Parameter Chart	35
Fingering Chart	36
Specifications	37
CVP-600: Assembly	38
CVP-98/96: Assembly	46

Table des matières (Français)

Messages	2
Dépistage des pannes	6
MIDI et la compatibilité des données	8
Format des données MIDI	9
Feuille d'implantation MIDI	25
Liste des voix	26
Liste d'assignation instrument de batterie/touche du clavier	32
Liste des styles	34
Tableau des paramètres	35
Tablature	36
Spécifications	37
CVP-600: Montage	38
CVP-98/96: Montage	46

Inhalt (Deutsch)











Displaymeldungen	2
Fehlersuche	6
MIDI und Datenkompatibilität	8
MIDI-Datenformat	9
MIDI-Implementierungstabelle	25
Stimmenverzeichnis	26
Verzeichnis der Schlagzeugklänge	32
Style-Verzeichnis	34
Parameterübersicht	35
Akkordliste	36
Technische Daten	37
CVP-600: Zusammenbau	38
CVP-98/96: Zusammenbau	46

Índice (Español)









Mensajes	2
Localización y reparación de averías	6
MIDI y compatibilidad de datos	8
Formato de datos MIDI	9
Gráfico de puesta en práctica de MIDI	25
Lista de voces	26
Lista de asignaciones de teclas/batería	32
Lista de estilos	34
Gráfica de parámetros	35
Gráfica de digitado	36
Especificaciones	37
CVP-600: Montaje	38
CVP-98/96: Montaje	46

Messages



● Common Messages



 No disk !	<p>This prompt appears when there is no disk in the disk drive.</p> <p>➤ Put the proper disk in the drive and attempt the operation again.</p>
 No songs !	<p>When renaming the original song or converting the data this prompt will warn you in the event that there is no song data.</p> <p>➤ Select a data-containing song, or insert a disk with song data into the floppy disk drive.</p>
 No file !	<p>This message appears if there is no Registration Memory, Micro Tuning, or related data on the currently inserted disk when you attempt a file-related operation.</p> <p>➤ Create a file or insert a disk with a proper file.</p>
 Start disk format ? <input type="button" value="OK"/> <input type="button" value="CANCEL"/>	<p>This message appears when a new disk or a non-Clavinova formatted disk has been inserted into the disk drive. (See page 106 in the Owner's Manual.)</p> <p>➤ Press OK if you want to format the disk. Press CANCEL if you want to abort the formatting process.</p>
 Protected disk !	<p>This message appears when you attempt to record or perform other file operations to a disk whose write-protect tab is set to "write protect."</p> <p>➤ Set the write-protect tab to the recordable position (page 7 in the Owner's Manual) then try the operation again. If the operation still cannot be performed, the disk itself has internal write protection, making it impossible to perform recording or file operations on the disk.</p>
 Protected songs !	<p>This message appears when you attempt to record over parts or perform other operations on files that are incompatible or do not allow such operations. Depending on the file type, operations such as additional recording, copying, deleting, etc. may not be possible on the CVP-98/96/600.</p>
 Disk read/write error ! <input type="button" value="OK"/>	<p>An error occurred while writing to (as in recording or storing files) or reading from the disk.</p> <p>➤ Try the operation again after pressing the OK button. If the error occurs a second time, the disk or the disk drive unit may be faulty. If you suspect the drive to be at fault, refer the problem to your Yamaha dealer.</p>
 Completed !	<p>This appears for a few seconds when a time consuming operation such as format, song copy, etc. is finished.</p>
 Don't remove the disk !	<p>This message appears when data is being transferred between the Clavinova and the disk.</p> <p>➤ The message disappears automatically when the operation is finished.</p>
 Are you sure ? <input type="button" value="YES"/> <input type="button" value="NO"/>	<p>When operations such as Song Delete or Format are selected, this prompts you to confirm whether you want to go ahead with the operation or not.</p> <p>➤ Press YES to execute the operation. Press NO to return to the previous display.</p>
 Disk full ! <input type="button" value="OK"/>	<p>The currently loaded disk is full and cannot hold any more data.</p> <p>➤ Press the OK button, then delete any unnecessary data in the disk (page 138 in the Owner's Manual), or use a disk that has more available space. If this appears during song recording, recording will stop and recorded data up to that point will be saved automatically.</p>

Messages











 Too many files ! <input type="button" value="OK"/>	<p>A 2DD and a 2HD disk can hold up to 60 song files each. A 2DD disk can hold about 110 files (of various types), and a 2HD disk can hold up to about 220 files. This message appears when you try to produce more files than the disk is capable of storing.</p> <p>➤ Press the OK button, then delete any unnecessary files in the disk (page 138 in the Owner's Manual), or use a disk that has more available space.</p>
 Same name ! Overwrite ? <input type="button" value="OK"/> <input type="button" value="CANCEL"/>	<p>A file with the same name exists.</p> <p>➤ Press the OK button if you wish to overwrite the original file with new data, or press CANCEL to abort the operation.</p>
 This button can't be used during recording or playback !	<p>This message appears when you try to perform operations which cannot be done during recording or playback, such as data conversion, etc.</p> <p>➤ Stop song recording or playback, or exit from the recording/playback mode, then perform the operation again.</p>
 This button can't be used during playback !	<p>This appears when you try to execute operations that cannot be performed during playback, such as changing the number of repeats of the Guide function.</p> <p>➤ Stop song playback, or exit from the playback mode, then perform the operation again.</p>
 Button not valid !	<p>A button that does not have a function in the current mode has been pressed.</p>
 Disk read/write operation in process !	<p>This message appears when you try to execute other operations while reading data from the disk or saving data.</p> <p>➤ Wait until the data read/write operation is completed, then perform the operation again.</p>
 Memory write operation in process !	<p>This message appears when you attempt to execute another operation while writing edited data of a song recorded to internal RAM.</p> <p>➤ Complete the data write operation, then perform the other operation.</p>
 Delete CVP MEMORY ? <input type="button" value="YES"/> <input type="button" value="NO"/>	<p>This message appears when executing an operation that results in deleting data recorded to the internal RAM, such as playback of disk software.</p> <p>➤ Press YES to delete the data recorded to the internal RAM, then perform the desired operation. Press the NO button if you want to keep the data.</p>
 Convert to CVP songs ? <input type="button" value="YES"/> <input type="button" value="NO"/>	<p>This message appears when you attempt to record over or edit data of commercially available software or data recorded on Clavinovas other than the CVP-94/92/98/96/600.</p> <p>➤ Press YES to convert the data for recording/editing on the CVP-94/92/98/96/600. Press NO if you don't want to convert the data.</p>

● Song Copy Related Messages

 Number of disk exchange (1) <input type="button" value="OK"/> <input type="button" value="CANCEL"/>	<p>This message informs you of the number of times the disks must be exchanged when copying a song to a different disk before starting the song copy operation. (See page 137 in the Owner's Manual.)</p>
 Insert Disk 2. (1 / 3) <input type="button" value="CANCEL"/>	<p>Insert the destination disk to be copied. (See page 137 in the Owner's Manual.)</p>
 Please select destination song number. SONG 1 [v] <input type="button" value="OK"/> <input type="button" value="CANCEL"/>	<p>When copying a song from the source disk to another disk, this message prompts you to specify the song number in the destination disk to which the song is to be copied, when the disk is first inserted. (See page 137 in the Owner's Manual.)</p>



 Insert Disk 1. (2/ 3) <div style="text-align: right;"><input type="button" value="CANCEL"/></div>	<p>This message prompts you to insert the source disk when copying songs to a second disk. (See page 137 in the Owner's Manual.)</p>
 Select a different number !	<p>This appears when the same song number is selected for both source and destination in the song copy operation.</p> <p>➤ Change the destination song number.</p>

● Custom Style Related Messages

 CUSTOM STYLE Please select a source style.	<p>This message appears for a few seconds when the Custom Style mode is engaged. (See page 68 in the Owner's Manual.)</p>
 Clear style ? <div style="text-align: right;"><input type="button" value="OK"/> <input type="button" value="CANCEL"/></div>	<p>This confirmation prompt appears when you attempt to change the beat parameter in the Custom Style mode. (See page 70 in the Owner's Manual.)</p>
 Clear section ? <div style="text-align: right;"><input type="button" value="OK"/> <input type="button" value="CANCEL"/></div>	<p>This confirmation prompt appears when you attempt to change the number of measures in the Custom Style mode. (See page 70 in the Owner's Manual.)</p>
 Clear part ? <div style="text-align: right;"><input type="button" value="OK"/> <input type="button" value="CANCEL"/></div>	<p>This confirmation prompt appears when you attempt to perform operations which can only be done after deleting the part of the original style in the Custom Style mode. (See page 71 in the Owner's Manual.)</p>
 Store Bossa NovaX ? <div style="border: 1px solid black; padding: 2px; margin-bottom: 5px;"> MEMORY No. 1 (TEMP.STYLE) </div> <div style="text-align: right;"><input type="button" value="OK"/> <input type="button" value="CANCEL"/></div>	<p>This confirmation prompt appears when you attempt a store operation in the Custom Style mode. (See page 74 in the Owner's Manual.)</p> <p>This also appears when you attempt to change styles before storing. (See page 79 in the Owner's Manual.)</p>
 Store Bossa NovaX ? <div style="border: 1px solid black; padding: 2px; margin-bottom: 5px;"> MEMORY No. 1 (TEMP.STYLE) </div> <div style="text-align: right;"><input type="button" value="YES"/> <input type="button" value="NO"/> <input type="button" value="CANCEL"/></div>	<p>This confirmation prompt appears when you attempt to exit from the Custom Style mode before storing data. (See page 79 in the Owner's Manual.)</p> <p>➤ Select YES to store. Press NO to exit without storing data. Press CANCEL to return to the previous display without storing data. (See page 79 in the Owner's Manual.)</p>
 Can't recall ! <div style="text-align: right;"><input type="button" value="OK"/></div>	<p>This message appears when the Recall Section operation in the Custom Style mode cannot be performed, due to changes in the time signature (beat). (See page 74 in the Owner's Manual.)</p>
 Please store to memory before saving to disk <div style="text-align: right;"><input type="button" value="OK"/></div>	<p>If the data has not been stored to memory before saving to disk in the Custom Style mode, this message prompts you to store the data before proceeding. (See page 76 in the Owner's Manual.)</p>
 Not enough memory ! Please delete an unneeded style or simplify the current style. <div style="text-align: right;"><input type="button" value="DELETE"/> <input type="button" value="CANCEL"/></div>	<p>This message appears if there is not enough internal memory space left when storing data in the Custom Style mode. (See page 78 in the Owner's Manual.)</p>
 Delete style ? <div style="border: 1px solid black; padding: 2px; margin-bottom: 5px;"> MEMORY No. 1 (Beat Pop1) (17KB) </div> <div style="text-align: right;"><input type="button" value="OK"/> <input type="button" value="CANCEL"/></div>	<p>This message appears when DELETE is selected from the display shown above.</p> <p>➤ Select the style to be deleted and press the OK button. Press CANCEL if you do not want to delete the style.</p>
 Not enough memory ! <div style="text-align: right;"><input type="button" value="OK"/></div>	<p>This message appears when memory capacity has become full during recording in the Custom Style mode (page 78 in the Owner's Manual). This also appears when memory has become full during recording of a song to internal RAM. In this case, recording will stop and data recorded up to that point will be saved automatically.</p>

Messages



● Recorded Data Conversion Related Messages

 2HD disk not valid ! Please copy to 2DD disk. <input type="button" value="OK"/>	This message appears if a 2HD disk is used when performing conversion of the recorded data. ➤ Press OK and copy the song data to be converted to a 2DD disk, then perform the data conversion using the disk.
 Completed ! SONG No. 2	Following conversion of the song data, this message displays the song number to which the data was saved.



● Initial Data Change Related Messages

 Write edited data ? <input type="button" value="YES"/> <input type="button" value="NO"/> <input type="button" value="CANCEL"/>	This confirmation message appears if you attempt to exit the Initial Edit function without writing the data. ➤ Press YES to write the changed data. Press NO to exit without writing. Press CANCEL to return to the Initial Edit display without writing.
--	---





● Chord Sequence Related Messages

 Save recorded data ? <input type="button" value="YES"/> <input type="button" value="NO"/> <input type="button" value="CANCEL"/>	This confirmation message appears if you attempt to exit the Chord Sequence function during recording. ➤ Press YES to store the recorded data. Press NO to exit without storing. Press CANCEL to return to the Chord Sequence display without storing.
 Button not valid ! Enter at the top of measure.	This message appears during Chord Sequence recording when you attempt to enter an accompaniment style or section change at a position other than the beginning of a measure. ➤ Record changes of accompaniment style or section only at the beginning of the measure. (See page 118 in the Owner's Manual.)

● Style File Load Related Messages

 Not enough memory ! Delete an unneeded style ? MEMORY No. 118Beat Pop1 K17KB <input type="button" value="DELETE"/> <input type="button" value="CANCEL"/>	This message appears when you attempt to load a Style file without there being enough memory to hold the specified file. (See page 82 in the Owner's Manual.)
 Too much data for LISTEN function ! Please load data.	Some Style Files are too large to be handled by the LISTEN feature in the Style File Load function. (See page 81 in the Owner's Manual.)

● Other Messages

 HOST is offline !	This message appears when the host computer is not turned on, the connecting cable is not properly connected, the HOST SELECT switch is not in the proper position, or the MIDI driver or MIDI application is not active. In this case, turn the power off on both the Clavinova and the computer, and check the cable connection and the position of the HOST SELECT switch. Once the connection and HOST SELECT switch position is verified, turn the power of the computer on first, then the Clavinova, to check if the MIDI driver and MIDI application function properly.
 Back up data erased and replaced by factory data.	As long as the Clavinova is regularly used, data is retained in memory. If the instrument is left unused for a week or longer before being turned on again, the data is erased and this message appears. This message also appears when you recall all factory data. (See page 147 in the Owner's Manual.)
 Hardware error !	A problem has been detected in the hardware system during power on. ➤ Refer the problem to your Yamaha dealer.
 Clean the disk head ! <input type="button" value="OK"/>	The disk head is dirty. Clean the disk head using a commercially available head cleaning disk.

Troubleshooting

Problem	Cause	Solution
The power of the Clavinova does not turn on.	The power cable plugs are not inserted either in the Clavinova or a proper AC outlet.	Securely insert one of the cable plugs into the instrument itself, and the other plug into a proper AC outlet.
A click or pop sound is produced when turning on/off the power.	Electrical current is flowing into the instrument.	This is normal, and is no cause for concern.
The LCD display is too bright or too dark to read.	The brightness may be changed by the surrounding temperature.	Adjust the contrast of the display by using the [CONTRAST] control. (See page 15 in the Owner's Manual.)
The pop-up display does not open.	The [DISPLAY HOLD] lamp is lit.	Press the [DISPLAY HOLD] button so that the lamp goes out. (See page 15 in the Owner's Manual.)
The keyboard sound volume is low compared to that of the Auto Accompaniment or disk playback.	The independent volume level of the keyboard performance sound is too low.	Raise the volume of the keyboard performance in the Mixer display. (See page 94 in the Owner's Manual.)
The sound of the Auto Accompaniment or disk playback is low compared to that of the keyboard.	The [ACMP/SONG VOLUME] is low.	Raise the [ACMP/SONG VOLUME] level.
The entire sound is low or no sound comes out.	The [MASTER VOLUME] is low.	Raise the [MASTER VOLUME].
	Headphones are connected.	Unplug the headphones.
	Local Control is set to off.	Set Local Control to on. (See page 144 in the Owner's Manual.)
The damper pedal has no effect, or the sound continuously sustains even when the damper pedal is not pressed.	The pedal cord plug is not connected.	Securely insert the pedal cord plug into the proper jack. (See page 40 in this manual for the CVP-600 and page 48 for the CVP-98/96.)
Auto Accompaniment or disk playback does not start.	MIDI Sync is set to "EXT."	Set MIDI Sync to "INT.". (See page 144 in the Owner's Manual.)
When the keyboard is played, not all of the notes sound.	Notes have been played beyond the total simultaneous polyphonic capacity (maximum number of notes).	The tone generation system is configured such that later notes have priority, occasionally resulting in previous notes being cut off. See the "Specifications" section on page 37 in this Manual for information on the simultaneous polyphonic capacity.
Auto Accompaniment does not play back.	Auto Accompaniment is not turned on.	Press the [ACMP ON] button to turn on Auto Accompaniment.

Troubleshooting

Problem	Cause	Solution
The desired chord cannot be recognized or output by the Auto Accompaniment.	The keys are not being played correctly.	Refer to the “Fingering Chart” (page 36 in this Manual).
	The keys are not being played according to the selected Auto Accompaniment type.	Check the Auto Accompaniment type, and play the keys according to the selected type. (See page 56 in the Owner’s Manual.)
The maximum of 60 songs cannot be recorded.	The memory capacity is full because the playing time of one or more songs is long, or many functions were used.	Delete unnecessary songs (page 138 in the Owner’s Manual) or record to a new disk.
Some tracks do not played back when playing back data.	Playback of the track(s) is set to off.	Set playback for the non-sounding tracks to on. (See pages 91 and 94 in the Owner’s Manual.)



*** If a “Hardware Error!” message appears in the display when turning on the power, contact your local Yamaha dealer immediately, since this indicates some sort of internal damage to the instrument.**

MIDI and Data Compatibility

■ MIDI

MIDI (Musical Instrument Digital Interface) is a worldwide standard communication interface that allows MIDI-compatible musical instruments and equipment to share musical information and control one another.

- Depending on the MIDI device, the transmittable/receivable data differs, and only data which is commonly recognized among the connected MIDI devices can be transmitted or received. You can check whether your instrument supports certain data types by referring to the MIDI Implementation Chart in the owner's manual for that instrument. The MIDI Implementation Chart for the CVP-98/96/600 is found on page 25 in this Manual.

MIDI Terminals

Data received via the MIDI IN terminal is re-transmitted unchanged through this terminal.

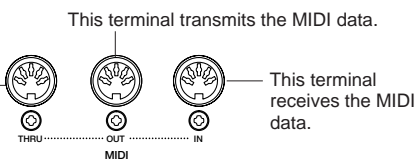

MIDI Cable

Connect MIDI devices with special MIDI cables.

- The various MIDI settings can be made from the Function section's MIDI 1 - 3 pages.
- Further information on MIDI and its applications is available in various music books and magazines.

■ Data Compatibility

This section covers basic information on data compatibility: whether or not other MIDI devices can playback the data recorded by CVP-98/96/600, and whether or not the CVP-98/96/600 can playback commercially available song data or song data created for other instruments or on a computer.

Depending on the MIDI device or data characteristics, you may be able to play back the data without any problem, or you may have to perform some special operations before the data can be played back. If you run into problems playing back data, please refer to the information below.

● Basic Check Points

The data and the MIDI device must match in regards to the items below.

- Disk Format
- Sequence format
- Voice allocation format

● Disk format

Floppy disks are the main storage medium for data used with various devices, including computers. Different devices have different systems of storing data, therefore it is necessary to first configure the floppy disk to the system of the device being used. This operation is called "formatting."

- There are two types of floppy disks: MF2DD (double sided, double density) and MF2HD (double sided, high density), and each type has different formatting systems.
- CVP-98/96/600 can record and playback with both types of floppy disks.
- When formatted by the CVP-98/96/600, a 2DD disk stores up to 720 KB (kilobytes) and a 2HD disk stores up to 1.44 MB (megabytes). (The figures "720 KB" and "1.44 MB" indicate the data memory capacity. They are also used to indicate the format type of disk.)
- Playback is only possible when the MIDI device to be used is compatible with the format of the disk.

● Sequence Format

The system which records song data is called "sequence format."

- Playback is only possible when the sequence format of the disk matches that of the MIDI device.

[Common Sequence Formats] SMF (Standard MIDI File)

This is the most common sequence format.

- Standard MIDI Files are generally available as one of two types: Format 0 or Format 1.
- Many MIDI devices are compatible with Format 0, and most commercially available software is recorded as Format 0.
- The CVP-98/96/600 is compatible with both Format 0 and Format 1 (for Format 1, up to a maximum of 17 chunks).
- Song data recorded on the CVP-98/96/600 is automatically recorded as SMF Format 0.

ESEQ

This sequence format is compatible with many of Yamaha's MIDI devices, including the Clavinova series instruments.

This is a common format used with various Yamaha software.

- The CVP-98/96/600 is compatible with ESEQ.

● Voice Allocation Format

With MIDI, voices are assigned to specific numbers, called "program numbers." The numbering standard (order of voice allocation) is referred to as the "voice allocation format."

- Voices may not play back as expected unless the voice allocation format of the song data matches that of the compatible MIDI device used for playback.

[Main Voice Allocation Formats]

GM System Level 1

This is one of the most common voice allocation formats.

- Many MIDI devices are compatible with GM System Level 1, as is most commercially available software.
- The CVP-98/96/600 is compatible with GM System Level 1.

XG

XG is a major enhancement of the GM System Level 1 format, and was developed by Yamaha specifically to provide more voices and variations, as well as greater expressive control over voices and effects, and to ensure compatibility of data well into the future.

- The CVP-98/96/600 is compatible with XG.
- Song data recorded on the CVP-98/96/600 is automatically given XG voice allocation.

DOC

This voice allocation format is compatible with many of Yamaha's MIDI devices, including the Clavinova series instruments.











This is also a common format used with various Yamaha software.









- The CVP-98/96/600 is compatible with DOC.

Even if the devices and data used satisfy all the conditions above, the data may still not be completely compatible, depending on the specifications of the devices and particular data recording methods.



Displaymeldungen

● Allgemeine Meldungen



 No disk !	<p>Diese Meldung weist darauf hin, daß keine Diskette im Laufwerk eingelegt ist.</p> <p>➤ Legen Sie die richtige Diskette ein, und wiederholen Sie den Bedienvorgang.</p>
 No songs !	<p>Diese Warnmeldung weist beim Benennen bzw. Kopieren eigener Songdaten darauf hin, daß bei der gewählten Songnummer bzw. auf der Diskette keine Songdaten gespeichert sind.</p> <p>➤ Wählen Sie die richtige (Daten enthaltene) Songnummer, oder legen Sie eine Diskette mit Songdateien ein.</p>
 No file !	<p>Diese Warnmeldung weist beim versuchten Ausführen einer dateispezifischen Operation darauf hin, daß auf der eingelegten Diskette keine entsprechende Datei (z.B. Registration- oder Stimmungsdatei) gespeichert ist.</p> <p>➤ Legen Sie eine Datei an, oder legen Sie die richtige Diskette ein, und wiederholen Sie den Bedienvorgang.</p>
 Start disk format ? <input type="button" value="OK"/> <input type="button" value="CANCEL"/>	<p>Diese Meldung erscheint, wenn Sie eine neue (unformatierte) Diskette oder eine mit einem anderen Gerät formatierte Diskette einlegen. (Siehe Seite 106 in der Bedienungsanleitung.)</p> <p>➤ Drücken Sie OK, um die Diskette zu formatieren, oder aber CANCEL, um den Vorgang ohne Formatierung abzubrechen.</p>
 Protected disk !	<p>Diese Meldung wird angezeigt, wenn Sie versuchen, mit einer Diskette aufzunehmen oder Daten zu speichern, deren Schreibschutzknopf auf "schreibgeschützt" steht.</p> <p>➤ Stellen Sie den Schreibschutzknopf auf "schreibfähig" (Seite 7 in der Bedienungsanleitung), um den Bedienvorgang dann noch einmal auszuführen. Sollte die Bedienung erneut verweigert werden, sind die Dateien der Diskette selbst schreibgeschützt, so daß die Diskette nicht zum Aufnehmen oder Speichern verwendet werden kann.</p>
 Protected songs !	<p>Diese Meldung erscheint, wenn Sie versuchen, einen Song zu bearbeiten, der mit einem anderen System erstellt wurde oder schreibgeschützt ist. Songdaten anderer Systeme können unter Umständen nicht mit dem CVP-98/96/600 nachbearbeitet, kopiert oder gelöscht werden.</p>
 Disk read/write error ! <input type="button" value="OK"/>	<p>Beim Beschreiben (Aufnehmen oder Speichern von Daten) bzw. Lesen der Diskette ist ein Fehler aufgetreten.</p> <p>➤ Drücken Sie die OK-Displaytaste, und wiederholen Sie den Bedienvorgang. Sollte der Fehler ein zweites Mal auftreten, ist die Diskette oder das Laufwerk unter Umständen verschmutzt bzw. defekt. Wenn Sie einen Laufwerkdefekt annehmen, wenden Sie sich an Ihren Yamaha-Fachhändler.</p>
 Completed !	<p>Diese Meldung erscheint, wenn eine länger dauernde Diskettenoperation (Formatierung, Kopieren eines Songs u. dgl.) abgeschlossen ist.</p>
 Don't remove the disk !	<p>Diese Meldung wird angezeigt, während Daten zwischen dem Clavinova und dem Laufwerk transferiert werden.</p> <p>➤ Die Meldung verschwindet automatisch, sobald der Schreib-/Lesevorgang abgeschlossen ist.</p>
 Are you sure ? <input type="button" value="YES"/> <input type="button" value="NO"/>	<p>Diese Meldung fordert Sie vor einer Operation wie Löschen eines Songs oder Formatierung einer Diskette auf, die Ausführung des Vorgangs zu bestätigen.</p> <p>➤ Drücken Sie YES, um den Vorgang auszuführen. Drücken Sie NO, um ohne Ausführung des Vorgangs zur früheren Anzeige zurückzugehen.</p>
 Disk full ! <input type="button" value="OK"/>	<p>Die eingelegte Diskette ist voll und kann keine weiteren Daten speichern.</p> <p>➤ Drücken Sie die OK-Displaytaste, und löschen Sie dann nicht mehr gebrauchte Daten von der Diskette (Seite 138 in der Bedienungsanleitung), oder verwenden Sie eine andere Diskette, auf der noch ausreichend Speicherraum frei ist. Wenn diese Meldung beim Aufnehmen eines Songs angezeigt wird (OK wird in diesem Fall nicht angeboten), stoppt die Aufnahme, wobei die Daten bis zu diesem Punkt automatisch gespeichert werden.</p>

 Too many files ! <input type="button" value="OK"/>	<p>Auf einer 2DD- oder 2HD-Diskette können jeweils bis zu 60 Song-Dateien gespeichert werden. Eine 2DD-Diskette kann etwa 110 Dateien (unterschiedlichen Typs) speichern, und eine 2HD-Diskette etwa 220.</p> <p>Diese Meldung wird angezeigt, wenn Sie versuchen, mehr als die zulässige Anzahl an Dateien auf einer Diskette zu speichern.</p> <ul style="list-style-type: none"> ➤ Drücken Sie die OK-Displaytaste, und löschen Sie dann nicht mehr gebrauchte Dateien von der Diskette (Seite 138 in der Bedienungsanleitung), oder verwenden Sie eine Diskette mit ausreichend freiem Speicherraum.
 Same name ! Overwrite ? <input type="button" value="OK"/> <input type="button" value="CANCEL"/>	<p>Eine Datei mit demselben Namen existiert bereits.</p> <ul style="list-style-type: none"> ➤ Drücken Sie die OK-Displaytaste, um die ältere Datei zu löschen und durch die neue zu ersetzen, oder aber CANCEL, um den Vorgang abzubrechen.
 This button can't be used during recordings or playback !	<p>Diese Meldung wird angezeigt, wenn Sie versuchen, während der Aufnahme oder Wiedergabe eines Songs einen unzulässigen Vorgang auszuführen (Dateikonversion, Formatierung o. dgl.).</p> <ul style="list-style-type: none"> ➤ Stoppen Sie den Aufnahme- oder Wiedergabebetrieb, oder verlassen Sie den Aufnahme- bzw. Wiedergabemodus, um den Vorgang danach auszuführen.
 This button can't be used during playback !	<p>Diese Meldung wird angezeigt, wenn Sie versuchen, während der Song-Wiedergabe einen unzulässigen Vorgang auszuführen (Ändern der Anzahl an Wiederholungen für Guide-Übungsfunktion u. dgl.).</p> <ul style="list-style-type: none"> ➤ Stoppen Sie den Wiedergabebetrieb, oder verlassen Sie den Wiedergabemodus, um den Vorgang danach auszuführen.
 Button not valid !	<p>Sie haben eine Taste betätigt, die im aktuellen Modus keine Funktion hat.</p>
 Disk read/write operation in process !	<p>Diese Meldung erscheint, wenn Sie versuchen, einen anderen Vorgang auszuführen, während Daten auf die Diskette geschrieben oder von der Diskette gelesen werden.</p> <ul style="list-style-type: none"> ➤ Warten Sie, bis der Schreib-/Lesevorgang beendet ist, und führen Sie den Vorgang danach aus.
 Memory write operation in process !	<p>Diese Meldung erscheint, wenn Sie versuchen, einen anderen Vorgang auszuführen, während bei der Bearbeitung eines im internen RAM aufgenommenen Songs Daten gespeichert werden.</p> <ul style="list-style-type: none"> ➤ Warten Sie, bis die Daten gespeichert sind, und führen Sie den Vorgang danach aus.
 Delete CVP MEMORY ? <input type="button" value="YES"/> <input type="button" value="NO"/>	<p>Diese Meldung erscheint, wenn ein Vorgang ausgeführt wird, der ein Löschen der im internen RAM gespeicherten Daten zur Folge hat (z. B. Abspielen von Disketten-Software).</p> <ul style="list-style-type: none"> ➤ Drücken Sie YES, um die Daten im internen RAM zu löschen und den Vorgang auszuführen. Wenn die Daten nicht gelöscht werden sollen, drücken Sie NO, um den Vorgang abzubrechen.
 Convert to CVP songs ? <input type="button" value="YES"/> <input type="button" value="NO"/>	<p>Diese Meldung erscheint, wenn Sie versuchen, einen auf Diskette erworbenen Song oder Daten, die mit einem anderen Clavinova-Modell als dem CVP-94/92/98/96/600 aufgezeichnet wurden, durch eine Neuaufnahme zu ergänzen oder anderweitig zu bearbeiten.</p> <ul style="list-style-type: none"> ➤ Drücken Sie YES, um die Daten zur Bearbeitung auf dem CVP-94/92/98/96/600 zu konvertieren. Drücken Sie NO, wenn die Daten nicht konvertiert werden sollen.











● Beim Kopieren von Songs angezeigte Meldungen

 Number of disk exchange (1) <input type="button" value="OK"/> <input type="button" value="CANCEL"/>	<p>Diese Meldung gibt beim Kopieren einer Song-Datei auf eine andere Diskette vor dem Starten des Kopiervorgangs darüber Auskunft, wie oft Quellen- und Zieldiskette gegeneinander ausgetauscht werden müssen. (Siehe Seite 137 in der Bedienungsanleitung.)</p>
 Insert Disk 2. (1 / 3) <input type="button" value="CANCEL"/>	<p>Diese Meldung weist Sie an, die Zieldiskette einzulegen. (Siehe Seite 137 in der Bedienungsanleitung.)</p>
 Please select destination song number. <input type="text" value="SONG 1"/> <input type="button" value="OK"/> <input type="button" value="CANCEL"/>	<p>Wenn Sie beim Kopieren einer Song-Datei auf eine andere Diskette die Zieldiskette das erste Mal einlegen, fordert Sie diese Meldung auf, die Songnummer zu wählen, an der die Kopie abgelegt werden soll. (Siehe Seite 137 in der Bedienungsanleitung.)</p>

Displaymeldungen

 Insert Disk 1. (2/ 3) <div style="text-align: right;"><input type="button" value="CANCEL"/></div>	<p>Diese Meldung weist Sie beim Kopieren einer Song-Datei auf eine andere Diskette an, die Quellediskette einzulegen. (Siehe Seite 137 in der Bedienungsanleitung.)</p>
 Select a different number !	<p>Diese Meldung wird angezeigt, wenn als Quelle und Ziel dieselbe Songnummer gewählt wurde. > Ändern Sie die Ziel-Songnummer.</p>

● Beim Programmieren von Styles angezeigte Meldungen

 CUSTOM STYLE Please select a source style.	<p>Diese Meldung wird beim Aufrufen des CUSTOM STYLE-Modus einige Sekunden lang angezeigt. (Siehe Seite 68 in der Bedienungsanleitung.)</p>
 Clear style ? <div style="text-align: right;"><input type="button" value="OK"/> <input type="button" value="CANCEL"/></div>	<p>Diese Bestätigungsaufforderung erscheint, wenn Sie versuchen, im CUSTOM STYLE-Modus die Taktart zu ändern. (Siehe Seite 70 in der Bedienungsanleitung.)</p>
 Clear section ? <div style="text-align: right;"><input type="button" value="OK"/> <input type="button" value="CANCEL"/></div>	<p>Diese Bestätigungsaufforderung erscheint, wenn Sie versuchen, im CUSTOM STYLE-Modus die Taktzahl zu ändern. (Siehe Seite 70 in der Bedienungsanleitung.)</p>
 Clear part ? <div style="text-align: right;"><input type="button" value="OK"/> <input type="button" value="CANCEL"/></div>	<p>Diese Bestätigungsaufforderung erscheint, wenn Sie versuchen, im CUSTOM STYLE-Modus einen Vorgang auszuführen, der nur nach Löschen der Part-Daten des Original-Styles möglich ist. (Siehe Seite 71 in der Bedienungsanleitung.)</p>
 Store Bossa NovaX ? <div style="border: 1px solid black; padding: 2px; display: inline-block; margin-bottom: 5px;"> MEMORY No. 1 (TEMP.STYLE) </div> <div style="text-align: right;"><input type="button" value="OK"/> <input type="button" value="CANCEL"/></div>	<p>Diese Bestätigungsaufforderung erscheint, wenn Sie versuchen, im CUSTOM STYLE-Modus einen Speichervorgang auszuführen. (Siehe Seite 74 in der Bedienungsanleitung.) Die Meldung wird auch angezeigt, wenn Sie versuchen, einen anderen Style zu wählen, ohne die Custom-Style-Daten zu speichern. (Siehe Seite 79 in der Bedienungsanleitung.)</p>
 Store Bossa NovaX ? <div style="border: 1px solid black; padding: 2px; display: inline-block; margin-bottom: 5px;"> MEMORY No. 1 (TEMP.STYLE) </div> <div style="text-align: right;"><input type="button" value="YES"/> <input type="button" value="NO"/> <input type="button" value="CANCEL"/></div>	<p>Diese Meldung wird angezeigt, wenn Sie versuchen, den CUSTOM STYLE-Modus zu verlassen, ohne die Daten zu speichern. (Siehe Seite 79 in der Bedienungsanleitung.) > Drücken Sie OK, um die Daten zu speichern. Drücken Sie NO, um den Modus zu verlassen, ohne die Daten zu speichern. Drücken Sie CANCEL, wenn Sie die Daten noch nicht speichern und wieder zur früheren Anzeige gelangen wollen. (Siehe Seite 79 in der Bedienungsanleitung.)</p>
 Can't recall ! <div style="text-align: right;"><input type="button" value="OK"/></div>	<p>Diese Meldung wird angezeigt, wenn die RECALL SECTION-Funktion des Custom STYLE-Modus nicht ausgeführt werden kann (z.B. nach Ändern der Taktart). (Siehe Seite 74 in der Bedienungsanleitung.)</p>
 Please store to memory before saving to disk <div style="text-align: right;"><input type="button" value="OK"/></div>	<p>Diese Bestätigungsaufforderung erscheint im CUSTOM STYLE-Modus, wenn Sie versuchen, den programmierten Style auf Diskette sicherzustellen, ohne ihn zuvor intern gespeichert zu haben. (Siehe Seite 76 in der Bedienungsanleitung.)</p>
 Not enough memory ! Please delete an unneeded style or simplify the current style. <div style="text-align: right;"><input type="button" value="DELETE"/> <input type="button" value="CANCEL"/></div>	<p>Diese Meldung erscheint, wenn der Platz im internen RAM zum Speichern des Custom-Styles nicht ausreicht. (Siehe Seite 78 in der Bedienungsanleitung.)</p>
 Delete style ? <div style="border: 1px solid black; padding: 2px; display: inline-block; margin-bottom: 5px;"> MEMORY No. 1 (8Beat Pop1 (17KB)) </div> <div style="text-align: right;"><input type="button" value="OK"/> <input type="button" value="CANCEL"/></div>	<p>Diese Meldung erscheint, wenn auf der vorangehend beschriebenen Anzeige DELETE gewählt wird. > Wählen Sie den zu löschenden Style, und drücken Sie die OK-Displaytaste. Wenn keine Daten gelöscht werden sollen, drücken Sie CANCEL.</p>
 Not enough memory ! <div style="text-align: right;"><input type="button" value="OK"/></div>	<p>Diese Meldung wird angezeigt, wenn der Speicher beim Programmieren im CUSTOM STYLE-Modus voll wird (Seite 78 in der Bedienungsanleitung). Die Meldung wird auch angezeigt, wenn der Speicher beim Aufnehmen eines Songs im internen RAM voll wird. In diesem Fall stoppt die Aufnahme (OK wird nicht angeboten), und alle Daten bis zu diesem Punkt werden automatisch gespeichert.</p>

● Beim Konvertieren von Daten angezeigte Meldungen

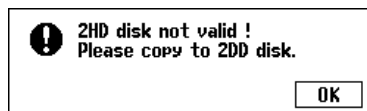

Diese Meldung erscheint, wenn versucht wird, eine Datei auf einer 2HD-Diskette zu konvertieren.

- > Drücken Sie **OK**, um den zu konvertierenden Song auf eine 2DD-Diskette zu kopieren, mit der die Konvertierung dann möglich ist.

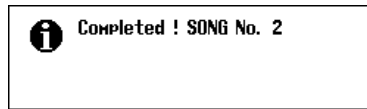

Diese Meldung zeigt nach der erfolgreichen Konvertierung an, unter welcher Nummer die konvertierte Datei gespeichert wurde.

● Beim Ändern von Anfangsdaten angezeigte Meldungen

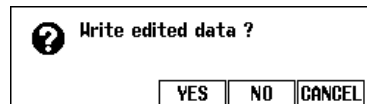

Diese Bestätigungsaufforderung erscheint, wenn Sie versuchen, die INITIAL EDIT-Anzeige zu verlassen, ohne die bearbeiteten Anfangsdaten zu speichern.

- > Drücken Sie **YES**, um die geänderten Daten zu speichern. Drücken Sie **NO**, um die Funktion ohne Speichern der Daten zu verlassen. Drücken Sie **CANCEL**, um ohne Speichern der Daten wieder zur INITIAL EDIT-Anzeige zurückzugehen.

● Beim Aufnehmen von Akkordsequenzen angezeigte Meldungen

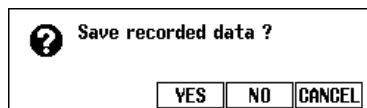

Diese Bestätigungsaufforderung erscheint, wenn Sie versuchen, die CHORD SEQUENCE-Funktion während der Aufnahme zu verlassen.

- > Drücken Sie **YES**, um die aufgenommenen Daten zu speichern. Drücken Sie **NO**, um die Funktion ohne Speichern der Daten zu verlassen. Drücken Sie **CANCEL**, um ohne Speichern der Daten wieder zur CHORD SEQUENCE-Anzeige zurückzugehen.

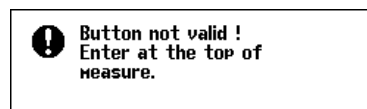

Diese Meldung erscheint bei der CHORD SEQUENCE-Aufnahme, wenn Sie versuchen, eine Style- oder Sektionsänderung an einem anderen Punkt als dem Anfang eines Taktes einzugeben.

- > Setzen Sie Style- oder Sektionsänderungen stets am Taktanfang. (Siehe Seite 118 in der Bedienungsanleitung.)

● Beim Laden von Style-Dateien angezeigte Meldungen

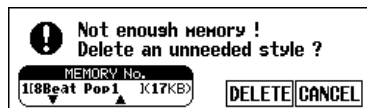

Diese Meldung erscheint, wenn der freie Platz im internen Speicher beim versuchten Laden einer Style-Datei nicht ausreicht. (Siehe Seite 82 in der Bedienungsanleitung.)

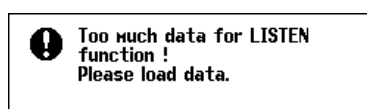

Manche Style-Dateien sind zu umfangreich für die **LISTEN**-Funktion auf der STYLE FILE LOAD-Anzeige. (Siehe Seite 81 in der Bedienungsanleitung.)

● Andere Meldungen

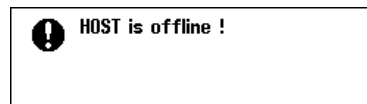

Diese Nachricht erscheint, wenn der Hostcomputer nicht eingeschaltet, das Verbindungskabel nicht korrekt angeschlossen, der HOST SELECT-Schalter nicht richtig eingestellt oder der MIDI-Treiber bzw. das MIDI-Anwendungsprogramm nicht aktiv ist. In diesem Fall schalten Sie sowohl das Clavinova als auch den Computer aus, um dann die Kabelverbindungen sowie die Einstellung des HOST SELECT-Schalters zu überprüfen. Wenn die Verbindungen stimmen und der HOST SELECT-Schalter richtig eingestellt ist, schalten Sie zunächst den Computer und erst danach das Clavinova ein, um dann den MIDI-Treiber und das MIDI-Anwendungsprogramm auf ordnungsgemäße Funktion zu prüfen.

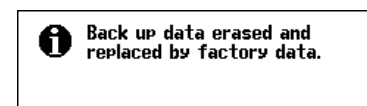

Solange das Clavinova regelmäßig benutzt wird, bleiben die Daten (Einstellungen) im Speicher erhalten. Wenn das Instrument jedoch eine Woche oder länger ausgeschaltet war, weist diese Meldung darauf hin, daß die Daten gelöscht wurden. Diese Meldung wird auch angezeigt, wenn Sie das Instrument auf die werkseitigen Vorgabeeinstellungen rücksetzen. (Siehe Seite 147 in der Bedienungsanleitung.)

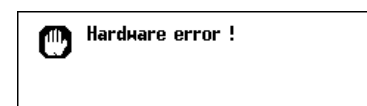

Beim Einschalten wurde ein Hardware-Fehler festgestellt.

- > Wenden Sie sich an Ihren Yamaha-Fachhändler.

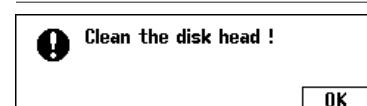

Der Schreib/Lese-Kopf des Diskettenlaufwerks ist schmutzig. Reinigen Sie ihn mit einer im Fachhandel erhältlichen Reinigungsdiskette.

Fehlersuche

Problem	Ursache	Abhilfe
Das Clavinova kann nicht eingeschaltet werden.	Das Netzkabel ist nicht (fest) angeschlossen.	Schließen Sie den kleinen Stecker des Netzkabels fest an die Buchse des Instruments an und den Netzstecker an eine Steckdose.
Beim Einschalten ist ein Klick- oder Ploppgeräusch zu hören.	In das Instrument fließender Stromstoß.	Dies ist normal und kein Grund zur Besorgnis.
Das Display ist zu hell oder zu dunkel.	Die Helligkeit kann sich mit der Umgebungstemperatur ändern.	Stellen Sie das Display mit dem [CONTRAST] -Regler ein. (Siehe Seite 15 in der Bedienungsanleitung.)
Die Pop-up Anzeige wird nicht eingeblendet.	Die [DISPLAY HOLD] -Anzeigelampe leuchtet.	Drücken Sie die [DISPLAY HOLD] -Taste, so daß die Anzeigelampe erlischt. (Siehe Seite 15 in der Bedienungsanleitung.)
Die Tastatur-Tonlautstärke ist im Vergleich zur Begleitungs- bzw. Disketten-Wiedergabelautstärke zu niedrig.	Die Tastatur-Lautstärke ist zu niedrig eingestellt.	Stellen Sie auf der MIXER-Anzeige einen höheren Tastatur-Lautstärkewert ein. (Siehe Seite 94 in der Bedienungsanleitung.)
Die Begleitungs- bzw. Disketten-Wiedergabelautstärke ist im Vergleich zur Tastatur-Lautstärke zu niedrig.	Der [ACMP/SONG VOLUME] -Regler ist zu niedrig eingestellt.	Stellen Sie den [ACMP/SONG VOLUME] -Regler höher ein.
Die Lautstärke insgesamt ist zu niedrig, oder es ist gar kein Ton zu hören.	Der [MASTER VOLUME] -Regler ist zu niedrig eingestellt.	Stellen Sie den [MASTER VOLUME] -Regler höher ein.
	Kopfhörer sind angeschlossen.	Trennen Sie die Kopfhörer ab.
	Local-Steuerung ist ausgeschaltet.	Schalten Sie die Local-Steuerung wieder ein. (Siehe Seite 144 in der Bedienungsanleitung.)
Das Dämpferpedal arbeitet nicht, oder Noten werden ausgehalten, obwohl das Dämpferpedal nicht betätigt wird.	Das Pedalkabel ist nicht angeschlossen.	Schließen Sie das Pedalkabel fest an die entsprechende Buchse an. (CVP-600 siehe Seite 40 und CVP-98/96 Seite 48 in dieser Anleitung.)
Die Begleitungs- oder Disketten-Wiedergabe kann nicht gestartet werden.	Die MIDI-Taktsteuerung (SYNC) ist auf "EXT" eingestellt.	Stellen Sie die MIDI-Taktsteuerung auf "INT". (Siehe Seite 144 in der Bedienungsanleitung.)
Beim Spielen auf der Tastatur bleiben manche Noten stumm.	Die Polyphoniekapazität (Zahl der gleichzeitig in Ton umsetzbaren Noten) wurde überschritten.	Das Tonerzeugungssystem ist so konfiguriert, daß bei einer Überschreitung der Kapazität später gespielte Noten Priorität haben und die jeweils ältesten verstummen. Mehr über die Polyphoniekapazität erfahren Sie im Abschnitt "Technische Daten" auf Seite 37 in dieser Anleitung.
Die automatische Baß/Akkord-Begleitung wird nicht gespielt.	AUTO ACCOMPANIMENT ist ausgeschaltet.	Drücken Sie die [ACMP ON] -Taste, um die automatische Baß/Akkord-Begleitung einzuschalten.

Problem	Ursache	Abhilfe
Akkorde werden von der AUTO AC-COMPANIMENT-Funktion nicht richtig erkannt oder umgesetzt.	Die falschen Tasten wurden angeschlagen.	Siehe "Akkordliste" (Seite 36 in dieser Anleitung).
	Es wurden nicht die zum gewählten Akkordgriff-Modus passenden Tasten angeschlagen.	Sehen Sie nach, welcher Akkordgriff-Modus gewählt ist, und schlagen Sie dazu passende Tasten an. (Siehe Seite 56 in der Bedienungsanleitung.)
Die Disketten-Speicherkapazität von 60 Songs wird nicht erreicht.	Wenn manche der Songs extrem lang sind und mit vielen Funktionen aufgenommen wurden, können nicht so viele Songs gespeichert werden.	Löschen Sie nicht mehr gebrauchte Dateien (Seite 138 in der Bedienungsanleitung) oder verwenden Sie eine neue Diskette.
Einige Spuren werden bei der Wiedergabe von Daten nicht gespielt.	Die Spuren sind ausgeschaltet.	Schalten Sie die "stummen" Spuren ein. (Siehe Seiten 91 und 94 in der Bedienungsanleitung.)



* **Wenn die Meldung "Hardware Error!" nach dem Einschalten angezeigt wird, wenden Sie sich bitte sofort an Ihren Yamaha-Händler, da dies auf einen internen Defekt schließen lässt.**

MIDI und Datenkompatibilität

■ MIDI

MIDI (Musical Instrument Digital Interface) ist ein weltweiter Kommunikationsschnittstellenstandard, der es MIDI-kompatiblen Musikinstrumenten und Geräten ermöglicht, musikalische Information auszutauschen und sich gegenseitig zu steuern.

- Die übertragbaren/empfangbaren MIDI-Daten sind je nach MIDI-Gerät unterschiedlich, wobei die Gesamtheit aller MIDI-Daten jedoch standardisiert ist, so daß eine eindeutige Kommunikation gewährleistet wird. Welche Daten vom jeweiligen Gerät gesendet bzw. empfangen werden, können Sie der MIDI-Implementierungstabelle entnehmen, die in der Dokumentation jedes MIDI-Instruments enthalten ist. Die MIDI-Implementierungstabelle des CVP-98/96/600 ist auf Seite 25 in dieser Anleitung abgedruckt.

MIDI-Buchsen

Über die MIDI IN-Buchse empfangene Daten werden unverändert an dieser Buchse wieder ausgegeben.

Über diese Buchse werden MIDI-Daten gesendet.

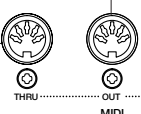

Über diese Buchse werden MIDI-Daten empfangen.

MIDI-Kabel

Verbinden Sie die MIDI-Geräte mit speziell hierfür vorgesehenen MIDI-Kabeln.

- Die verschiedenen MIDI-Einstellungen können auf den FUNCTION-Anzeigen MIDI 1 bis MIDI 3 vorgenommen werden.
- Einschlägige Bücher und Zeitschriften über MIDI und seine Anwendungen sind im Fachhandel erhältlich.

■ Datenkompatibilität

Dieser Abschnitt gibt eine kurze Übersicht über die Datenkompatibilität: welche MIDI-Geräte die mit dem CVP-98/96/600 aufgezeichneten Daten abspielen können, und welche der im Fachhandel für andere Instrumente erhältlichen oder auf einem anderen Instrument bzw. Computer erstellten Song-Daten das CVP-98/96/600 abspielen kann.

Die Dateien gewisser MIDI-Geräte können problemlos abgespielt werden, während für andere unter Umständen ein besonderes Verfahren erforderlich ist. Sollten Sie beim Abspielen von Daten Probleme haben, beachten Sie bitte die im folgenden erläuterten Punkte.

● Grundlegende Prüfpunkte

Die Daten und das MIDI-Gerät müssen hinsichtlich der folgenden Formate kompatibel sein:

- Diskettenformat
- Sequenzformat
- Stimmenzuordnungsformat

● Diskettenformat

Das weitverbreitetste Medium zum Speichern von Daten ist wohl die Floppy-Diskette, die früher nur Computern vorbehalten war. Bei Disketten ist zu beachten, daß es gerätespezifische Unterschiede in der Einteilung des Speicherplatzes und beim Aufzeichnungsverfahren gibt, weshalb Disketten vor Gebrauch "initialisiert" (systemkompatibel gemacht) werden müssen. Dies erreicht man durch das "Formatieren" der Disketten.

- Es gibt zwei Arten von Disketten: MF2DD (doppelseitig, doppelte Schreibdichte) und MF2HD (doppelseitig, hohe Schreibdichte). Beide Arten werden unterschiedlich formatiert.
- Beim CVP-98/96/600 können beide Diskettenarten für Aufnahme und Wiedergabe verwendet werden.
- Das CVP-98/96/600 formatiert 2DD-Disketten auf 720 KB (Kilobyte) und 2HD-Disketten auf 1,44 MB. (Die Werte "720 KB" und "1,44 MB" entsprechen der Speicherkapazität, werden jedoch oft auch zur Identifizierung der Diskettenart herangezogen.)

- Die Wiedergabe ("Lesen") der gespeicherten Daten ist nur möglich, wenn das MIDI-Gerät mit dem Format der Diskette kompatibel ist.

● Sequenzformat

Unter "Sequenzformat" wird das System verstanden, nach dem Songdaten aufgezeichnet werden.

- Eine Wiedergabe der Songdaten ist nur möglich, wenn das MIDI-Gerät mit dem Sequenzformat der Diskettendaten kompatibel ist.

[Allgemeine Sequenzformate]

SMF (Standard MIDI File)

Dies ist das verbreitetste Sequenzformat.

- Standard MIDI-Dateien haben eines von zwei Formaten: Format 0 oder Format 1.
- Viele MIDI-Geräte sind mit Format 0 kompatibel, und der Großteil der im Handel erhältliche Software ist im Format 0 aufgezeichnet.
- Das CVP-98/96/600 ist sowohl mit Format 0 als auch mit Format 1 kompatibel (bei Format 1 max. 17 Stücke).
- Auf dem CVP-98/96/600 aufgenommene Songs werden automatisch im Format 0 aufgezeichnet.

ESEQ

Viele MIDI-Geräte von Yamaha, unter anderem auch die Clavinova-Modelle, sind auch mit diesem Format kompatibel. Dies ist ein oft für Yamaha-Software verwendetes Format.

- Das CVP-98/96/600 ist mit ESEQ kompatibel.

● Stimmenzuordnungsformat

Bei MIDI sind die Stimmen (Voices) spezifischen Nummern zugeordnet, die "Programmnummern" genannt werden. Diese Nummernzuordnung wird "Stimmenzuordnungsformat" genannt.

- Beim Abspielen eines Songs auf einem anderen MIDI-Gerät kann dieses die Daten nur dann originalgetreu wiedergeben, wenn es mit derselben Stimmenzuordnungsformat arbeitet wie das Aufnahmegerät.

[Wichtigste Stimmenzuordnungsformate]

GM System Level 1

Dies ist das gebräuchlichste Stimmenzuordnungsformat.

- Viele MIDI-Geräte sind mit GM System Level 1 kompatibel, und ein Großteil der im Handel erhältlichen Software ist entsprechend programmiert.
- Das CVP-98/96/600 ist mit GM System Level 1 kompatibel.

XG

XG ist eine Bereicherung des GM System Level 1-Formats und wurde von Yamaha speziell zu dem Zweck entwickelt, mehr Stimmen- und Variationsvielfalt sowie eine bessere expressive Steuerung von Stimmen und Effekten zu bieten, wobei auch die langfristige Kompatibilität von Daten berücksichtigt wurde.

- Das CVP-98/96/600 ist mit XG kompatibel.
- Songdaten werden vom CVP-98/96/600 mit XG-Stimmenzuordnung aufgezeichnet.

DOC

Viele MIDI-Geräte von Yamaha, unter anderem auch die Clavinova-Modelle, sind auch mit diesem Stimmenzuordnungsformat kompatibel.











Ein Großteil der Yamaha-Software ist im DOC-Format erhältlich.









- Das CVP-98/96/600 ist mit DOC kompatibel.

Auch wenn die Geräte und Daten alle obengenannten Voraussetzungen erfüllen, sind die Daten je nach Gerätespezifikation und Aufzeichnungsverfahren unter Umständen nur bedingt kompatibel.



Messages



● Messages communs

 No disk !	<p>Ce message apparaît quand il n'y a pas de disquette dans le lecteur.</p> <p>➤ Introduisez une disquette dans le lecteur et recommencez la procédure.</p>
 No songs !	<p>Lorsque vous changez le nom des données personnelles, ou que vous convertissez des données, ce message vous avertit dans le cas où il n'y a pas de données de morceau.</p> <p>➤ Sélectionnez un morceau contenant des données ou insérez une disquette avec des données dans le lecteur de disquette.</p>
 No file !	<p>Ce message apparaît quand il n'y a pas de mémoire de registration, de micro-accord ou de données concernées dans la disquette actuellement insérée lorsque vous essayez d'exécuter une opération de disquette.</p> <p>➤ Créez un fichier ou insérez une disquette avec le bon fichier.</p>
 Start disk format ? <input type="button" value="OK"/> <input type="button" value="CANCEL"/>	<p>Ce message apparaît quand vous introduisez une disquette neuve ou une disquette formatée pour un autre système que le Clavinova dans le lecteur de disquette. (Voir page 106 dans le mode d'emploi).</p> <p>➤ Appuyez sur OK si vous désirez formater la disquette. Appuyez sur CANCEL si vous voulez abandonner le processus de formatage.</p>
 Protected disk !	<p>Ce message apparaît quand vous essayez d'enregistrer ou d'exécuter d'autres opérations de fichier sur une disquette dont la languette de protection contre l'écriture est positionnée sur "write protect" (écriture protégée).</p> <p>➤ Placez la languette de protection contre l'écriture sur la position destinée à l'enregistrement (page 7 dans le mode d'emploi), puis recommencez la procédure. Si vous ne pouvez toujours pas réaliser cette opération, c'est que la disquette elle-même est pourvue d'une protection interne contre l'écriture qui ne vous permet pas d'enregistrer ou de procéder à des opérations de fichier.</p>
 Protected songs !	<p>Ce message apparaît quand vous essayez d'enregistrer sur des parties ou d'exécuter d'autres opérations de fichier qui sont incompatibles ou ne permettent pas de telles opérations. Selon le type de fichier, les opérations telles que les enregistrements supplémentaires, la copie, l'effacement, etc., peuvent s'avérer impossibles sur le CVP-98/96/600.</p>
 Disk read/write error ! <input type="button" value="OK"/>	<p>Une erreur s'est produite pendant l'écriture sur la disquette (comme dans un enregistrement ou la sauvegarde des fichiers) ou la lecture à partir de la disquette.</p> <p>➤ Recommencez la procédure après avoir appuyé sur la touche OK. Si l'erreur se produit une seconde fois, la disquette ou le lecteur est peut-être défectueux. Si vous pensez que le lecteur est à l'origine du problème, consultez votre revendeur Yamaha.</p>
 Completed !	<p>Ce message apparaît pendant quelques secondes, quand une opération demandant un certain temps, telle que le formatage, la copie d'un morceau, est terminée.</p>
 Don't remove the disk !	<p>Ce message apparaît quand les données sont en cours de transfert entre le Clavinova et la disquette.</p> <p>➤ Le message disparaît automatiquement quand l'opération est terminée.</p>
 Are you sure ? <input type="button" value="YES"/> <input type="button" value="NO"/>	<p>Lorsque vous sélectionnez des opérations telles que l'effacement d'un morceau ou le formatage, ce message vous demande de confirmer si vous voulez continuer l'opération ou non.</p> <p>➤ Appuyez sur YES pour exécuter l'opération ou sur NO pour revenir à l'afficheur précédent.</p>
 Disk full ! <input type="button" value="OK"/>	<p>La disquette actuellement chargée est pleine et ne peut plus accepter de données.</p> <p>➤ Appuyez sur la touche OK, puis effacez toutes les données inutiles sur la disquette (page 138 dans le mode d'emploi), ou utilisez une disquette avec suffisamment d'espace disponible. Si ce message apparaît pendant l'enregistrement d'un morceau, (dans ce cas OK n'apparaît pas), l'enregistrement s'arrête et les données enregistrées jusqu'à ce point sont automatiquement sauvegardées.</p>











 Too many files ! <input type="button" value="OK"/>	<p>Les disquettes 2DD et 2HD peuvent contenir chacune 60 fichiers de morceau. Une disquette 2DD peut accepter environ 100 fichiers (de diverses sortes) tandis que la disquette 2HD en accepte 220 environ.</p> <p>Ce message apparaît quand vous essayez de produire plus de fichiers que la disquette n'est capable d'en sauvegarder.</p> <ul style="list-style-type: none"> > Appuyez sur OK, puis effacez les fichiers inutiles sur la disquette (page 138 dans le mode d'emploi) ou utilisez une disquette qui comprend plus d'espace disponible.
 Same name ! Overwrite ? <input type="button" value="OK"/> <input type="button" value="CANCEL"/>	<p>Un fichier portant le même nom existe.</p> <ul style="list-style-type: none"> > Appuyez sur OK si vous désirez remplacer le fichier d'origine avec les nouvelles données ou appuyez sur CANCEL pour abandonner l'opération.
 This button can't be used during recordings or playback !	<p>Ce message apparaît quand vous essayez de réaliser des opérations qui sont impossibles pendant l'enregistrement ou la reproduction, telles que la conversion, le formatage, etc.</p> <ul style="list-style-type: none"> > Arrêtez l'enregistrement ou la reproduction du morceau, ou sortez du mode enregistrement/reproduction, puis recommencez l'opération.
 This button can't be used during playback !	<p>Ce message apparaît quand vous essayez de réaliser des opérations qui ne peuvent pas être exécutées pendant la reproduction, telles que le changement du nombre de répétitions de la fonction guide.</p> <ul style="list-style-type: none"> > Arrêtez la reproduction du morceau, ou sortez du mode de reproduction, puis recommencez l'opération.
 Button not valid !	<p>Vous avez appuyé sur une touche qui n'a aucune fonction dans le mode actuel.</p>
 Disk read/write operation in process !	<p>Ce message apparaît quand vous essayez de lire des données de la disquette ou de sauvegarder des données.</p> <ul style="list-style-type: none"> > Attendez jusqu'à ce que l'opération de lecture/écriture soit terminée, puis recommencez l'opération.
 Memory write operation in process !	<p>Ce message apparaît quand vous voulez exécuter une autre opération pendant l'écriture des données éditées d'un morceau enregistré dans la RAM interne.</p> <ul style="list-style-type: none"> > Terminez d'abord l'opération d'écriture des données, puis réalisez l'autre opération.
 Delete CVP MEMORY ? <input type="button" value="YES"/> <input type="button" value="NO"/>	<p>Ce message apparaît lors de l'exécution d'une opération qui résulte dans l'effacement des données enregistrées dans la RAM interne, telle que la reproduction du logiciel de disquette.</p> <ul style="list-style-type: none"> > Appuyez sur YES pour effacer les données enregistrées sur la RAM interne, puis procédez à l'opération désirée. Appuyez sur la touche NO si vous voulez conserver les données.
 Convert to CVP songs ? <input type="button" value="YES"/> <input type="button" value="NO"/>	<p>Ce message apparaît quand vous essayez d'éditer les données ou d'enregistrer sur un logiciel disponible dans le commerce, ou des données enregistrées sur des Clavinova autres que le CVP-94/92/98/96/600.</p> <ul style="list-style-type: none"> > Appuyez sur YES pour convertir les données pour l'enregistrement/l'édition sur le CVP-94/92/98/96/600. Appuyez sur NO lorsque vous ne souhaitez pas convertir les données.

● Messages se rapportant à la copie de morceau

 Number of disk exchange (1) <input type="button" value="OK"/> <input type="button" value="CANCEL"/>	<p>Ce message vous informe du nombre de fois que vous devez changer de disquette pendant la copie d'un morceau sur une disquette différente avant de commencer l'opération de copie de morceau. (Voir page 137 dans le mode d'emploi).</p>
 Insert Disk 2. (1 / 3) <input type="button" value="CANCEL"/>	<p>Introduisez la disquette de destination à copier. (Voir page 137 dans le mode d'emploi).</p>
 Please select destination songs number. <input type="text" value="SONG 1"/> <input type="button" value="OK"/> <input type="button" value="CANCEL"/>	<p>Lorsque vous copiez un morceau d'une disquette source sur une autre disquette, ce message vous invite à spécifier le numéro du morceau sur la disquette de destination sur laquelle le morceau est copié lors de l'insertion de disquette. (Voir page 137 dans le mode d'emploi).</p>

 Insert Disk 1. (2/ 3) <div style="text-align: right;"><input type="button" value="CANCEL"/></div>	<p>Ce message vous invite à insérer la disquette source lorsque vous copiez des morceaux sur une seconde disquette. (Voir page 137 dans le mode d'emploi).</p>
 Select a different number !	<p>Ce message apparaît quand le même numéro de morceau est sélectionné pour la source comme pour la destination dans l'opération de copie de morceau.</p> <p>> Changez le numéro de morceau de destination.</p>

● Messages se rapportant au style personnel

 CUSTOM STYLE Please select a source style.	<p>Ce message apparaît pendant quelques secondes lorsque vous appelez le mode de style personnel. (Voir page 68 dans le mode d'emploi).</p>
 Clear style ? <div style="text-align: right;"><input type="button" value="OK"/> <input type="button" value="CANCEL"/></div>	<p>Ce message de confirmation apparaît quand vous essayez de changer le paramètre de temps dans le mode de style personnel. (Voir page 70 dans le mode d'emploi).</p>
 Clear section ? <div style="text-align: right;"><input type="button" value="OK"/> <input type="button" value="CANCEL"/></div>	<p>Ce message de confirmation apparaît quand vous essayez de modifier le nombre de mesures dans le mode de style personnel. (Voir page 70 dans le mode d'emploi).</p>
 Clear part ? <div style="text-align: right;"><input type="button" value="OK"/> <input type="button" value="CANCEL"/></div>	<p>Ce message de confirmation apparaît quand vous essayez de réaliser des opérations qui ne peuvent l'être qu'après l'effacement de la partie de style d'origine dans le mode de style personnel. (Voir page 71 dans le mode d'emploi).</p>
 Store Bossa NovaX ? <div style="border: 1px solid black; padding: 2px; margin-bottom: 5px;"> MEMORY No. 1 (TEMP. STYLE) </div> <div style="text-align: right;"><input type="button" value="OK"/> <input type="button" value="CANCEL"/></div>	<p>Ce message de confirmation apparaît quand vous essayez de faire une opération de sauvegarde dans le mode de style personnel. (Voir page 74 dans le mode d'emploi). Il apparaît également lorsque vous essayez de changer de style avant de sauvegarder. (Voir page 79 dans le mode d'emploi).</p>
 Store Bossa NovaX ? <div style="border: 1px solid black; padding: 2px; margin-bottom: 5px;"> MEMORY No. 1 (TEMP. STYLE) </div> <div style="text-align: right;"><input type="button" value="YES"/> <input type="button" value="NO"/> <input type="button" value="CANCEL"/></div>	<p>Ce message de confirmation apparaît quand vous essayez de sortir du mode de style personnel avant la sauvegarde des données. (Voir page 79 dans le mode d'emploi).</p> <p>> Sélectionnez YES pour sauvegarder. Appuyez sur NO pour sortir sans sauvegarder de données, Appuyez sur CANCEL pour revenir à l'afficheur précédent sans sauvegarder de données. (Voir page 79 dans le mode d'emploi).</p>
 Can't recall ! <div style="text-align: right;"><input type="button" value="OK"/></div>	<p>Ce message apparaît quand vous ne pouvez réaliser une opération de rappel de section dans le mode de style personnel parce que la mesure a été modifiée. (Voir page 74 dans le mode d'emploi).</p>
 Please store to memory before saving to disk <div style="text-align: right;"><input type="button" value="OK"/></div>	<p>Si les données n'ont pas été sauvegardées dans la mémoire avant d'être sauvegardées sur disquette dans le mode de style personnel, ce message vous invite à sauvegarder avant de continuer. (Voir page 76 dans le mode d'emploi).</p>
 Not enough memory ! Please delete an unneeded style or simplify the current style. <div style="text-align: right;"><input type="button" value="DELETE"/> <input type="button" value="CANCEL"/></div>	<p>Ce message apparaît quand la capacité de la mémoire interne est insuffisante lors de la sauvegarde des données dans le mode de style personnel. (Voir page 78 dans le mode d'emploi).</p>
 Delete style ? <div style="border: 1px solid black; padding: 2px; margin-bottom: 5px;"> MEMORY No. 1 (8Beat Pop1 - K17KB) </div> <div style="text-align: right;"><input type="button" value="OK"/> <input type="button" value="CANCEL"/></div>	<p>Ce message apparaît quand vous sélectionnez DELETE à partir de l'afficheur mentionné ci-dessus.</p> <p>> Sélectionnez le style à effacer et appuyez sur la touche OK. Appuyez sur CANCEL si vous ne souhaitez pas effacer le style.</p>
 Not enough memory ! <div style="text-align: right;"><input type="button" value="OK"/></div>	<p>Ce message apparaît quand la mémoire devient pleine pendant un enregistrement dans le mode de style personnel. (Voir page 78 dans le mode d'emploi). Il apparaît également quand la mémoire devient pleine pendant l'enregistrement d'un morceau dans la RAM interne. Dans ce cas (OK n'apparaît pas), l'enregistrement s'arrête et les données enregistrées jusqu'à ce point sont automatiquement sauvegardées.</p>

Messages

● Messages se rapportant aux conversions des données enregistrées

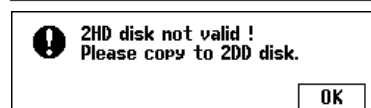

Ce message apparaît quand vous utilisez une disquette 2HD pour procéder à la conversion des données enregistrées.

- Appuyez sur **OK** et copiez les données de morceau à convertir sur une disquette 2DD, puis procédez à la conversion en utilisant la disquette.

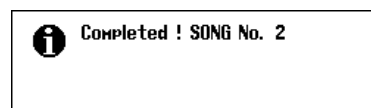

A la suite de la conversion des données, ce message affiche le numéro de morceau sous lequel les données ont été sauvegardées.

● Messages se rapportant aux changements de données initiales

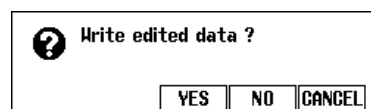

Ce message de confirmation apparaît quand vous essayez de sortir de la fonction d'édition initiale sans écrire les données.

- Appuyez sur **YES** pour écrire les données modifiées. Appuyez sur **NO** pour sortir sans rien écrire. Appuyez sur **CANCEL** pour revenir à l'afficheur d'édition initiale sans rien écrire.

● Messages se rapportant aux séquences d'accord

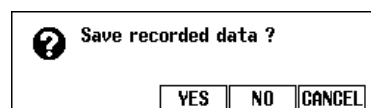

Ce message de confirmation apparaît quand vous essayez de sortir de la fonction de séquence d'accords pendant l'enregistrement.

- Appuyez sur **YES** pour sauvegarder les données enregistrées. Appuyez sur **NO** pour sortir sans sauvegarder. Appuyez sur **CANCEL** pour revenir à l'afficheur de séquence d'accords sans rien sauvegarder.

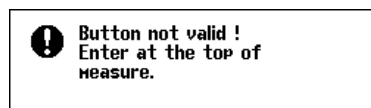

Ce message apparaît pendant l'enregistrement de la séquence d'accords, quand vous essayez d'introduire un style d'accompagnement ou un changement de section à une position autre que le commencement d'une mesure.

- Enregistrez les modifications du style d'accompagnement ou de section seulement au début d'une mesure. (Voir page 118 dans le mode d'emploi).

● Messages se rapportant au chargement des fichiers de style

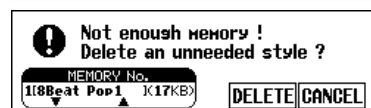

Ce message apparaît quand vous essayez de charger un fichier de style sans qu'il y ait suffisamment de mémoire pour contenir le fichier spécifié. (Voir page 82 dans le mode d'emploi).

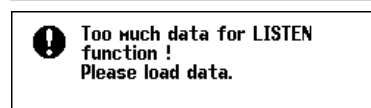

Certains fichiers de données sont trop gros pour que la fonction **LISTEN** puisse les gérer dans la fonction chargement de fichier de style. (Voir page 81 dans le mode d'emploi).

● Autres messages

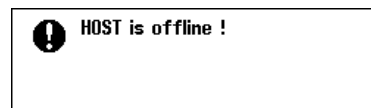

Ce message apparaît lorsque l'ordinateur hôte n'est pas sous tension, lorsque les connexions n'ont pas été effectuées correctement, que le commutateur **HOST SELECT** ne se trouve pas sur la position appropriée ou que le programme pilote MIDI ou le programme d'application MIDI n'est pas activé. Dans ce cas, mettez le Clavinova et l'ordinateur sous tension puis vérifiez le branchement des câbles et le positionnement du commutateur **HOST SELECT**. Après s'être assuré que les connexions ont été effectuées correctement et que le commutateur **HOST SELECT** se trouve bien sur la position appropriée, mettez d'abord l'ordinateur sous tension puis le Clavinova sous tension de manière à vérifier si le programme pilote MIDI et le programme d'application MIDI réagissent normalement.

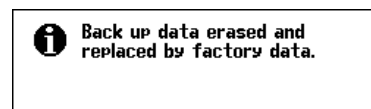

Tant que le Clavinova est régulièrement utilisé, les données sont conservées dans la mémoire. Ce message apparaît lorsque vous n'avez pas mis l'instrument sous tension pendant une semaine ou plus et les données sont alors effacées. Ce message apparaît également quand vous rappelez tous les réglages de départ usine. (Voir page 147 dans le mode d'emploi).

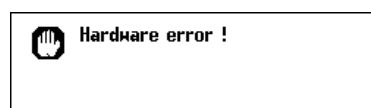

Un problème est détecté au niveau du système de matériel au moment de la mise sous tension.

- Adressez-vous à votre revendeur Yamaha.

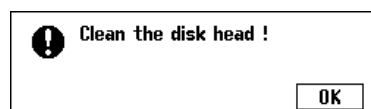

La tête de disquette est sale. Nettoyez-la avec une disquette de nettoyage de tête disponible dans le commerce.

Dépistage des pannes

Problème	Cause	Solution
Impossible de mettre le Clavinova sous tension.	Les prises du cordon d'alimentation ne sont pas insérées soit dans le Clavinova soit dans la prise murale secteur.	Introduisez fermement l'une des prises du cordon dans l'instrument lui-même et l'autre prise dans une prise murale adéquate.
Un dé clic ou un "pop" se produit à la mise sous tension ou hors tension.	Le courant électrique passe dans l'instrument.	C'est un phénomène normal, qui n'est pas un sujet d'inquiétude.
L'afficheur à cristaux liquides est trop brillant ou trop foncé pour être lisible.	La brillance est peut-être modifiée par la température ambiante.	Réglez le contraste de l'afficheur en utilisant le bouton de commande [CONTRAST] . (Voir page 15 dans le mode d'emploi).
L'afficheur temporaire ne s'ouvre pas.	Le témoin [DISPLAY HOLD] est allumé..	Appuyez sur la touche [DISPLAY HOLD] afin que le témoin s'éteigne. (Voir page 15 dans le mode d'emploi).
Le volume de son du clavier est faible comparé à celui de l'accompagnement automatique ou à celui de la reproduction de disquette.	Le niveau de volume indépendant du son de performance au clavier est trop bas.	Augmentez le volume de la performance au clavier dans l'afficheur Mixer. (Voir page 94 dans le mode d'emploi).
Le son de l'accompagnement automatique ou de la reproduction de disquette est faible comparé à celui de la performance au clavier.	[ACMP/SONG VOLUME] est bas.	Augmentez le niveau [ACMP/SONG VOLUME] .
L'ensemble du son est faible ou aucun son ne sort.	[MASTER VOLUME] est bas.	Augmentez [MASTER VOLUME] .
	Le casque d'écoute est branché.	Débranchez le casque.
	La commande locale est désactivée.	Activez la commande locale. (Voir page 144 dans le mode d'emploi).
La pédale de sustain est sans effet ou le son est continuellement maintenu, même quand vous n'appuyez pas sur la pédale de sustain.	Le cordon de connexion de la pédale n'est pas raccordé.	Introduisez correctement le cordon de connexion de la pédale dans la bonne prise. (Reportez-vous à la page 41 du présent mode d'emploi du modèle CVP-600 et à la page 49 du mode d'emploi du CVP-98/96.).
L'accompagnement automatique ou la reproduction de la disquette ne commence pas.	La synchro MIDI est fixée sur "EXT".	Fixez la synchro MIDI sur "INT". (Voir page 144 dans le mode d'emploi).
Quand vous jouez sur le clavier, toutes les notes ne sont pas audibles;	Les notes sont jouées au-delà de la capacité polyphonique simultanée totale (nombre maximum de notes).	Le système de génération de sons est configuré de telle manière que les dernières notes ont priorité, ce qui fait qu'occasionnellement les notes précédentes sont coupées. Reportez-vous à la section "Spécifications" de la page 37 de ce manuel pour toutes les informations sur la capacité polyphonique simultanée.
L'accompagnement automatique n'est pas reproduit.	L'accompagnement automatique n'est pas activé.	Appuyez sur la touche [ACMP ON] pour activer l'accompagnement automatique.

Dépistage des pannes

Problème	Cause	Solution
L'accompagnement automatique ne reconnaît pas l'accord souhaité ou ne le sort pas.	Vous ne jouez pas les touches correctement.	Reportez-vous au "Tablature" (page 36 de ce manuel).
	Vous ne jouez pas les touches en fonction du type d'accompagnement automatique sélectionné.	Vérifiez le type d'accompagnement automatique et jouez les touches en fonction de ce type sélectionné. (Voir page 56 dans le mode d'emploi).
Impossible d'enregistrer le maximum de 60 morceaux.	La capacité mémoire est pleine car le temps de reproduction d'un morceau ou de plusieurs morceaux est long, ou vous avez utilisé de nombreuses fonctions.	Effacez les morceaux inutiles (page 138 dans le mode d'emploi) ou enregistrez sur une nouvelle disquette.
Lors de la reproduction des données, certaines pistes ne sont pas reproduites.	La reproduction de piste(s) est désactivée.	Activez la reproduction des pistes qui ne sont pas audibles. (Voir pages 91, 94 dans le mode d'emploi).



- * **Si un message "Hardware Error !" apparaît sur l'afficheur à la mise sous tension, prenez immédiatement contact avec votre revendeur Yamaha, car ce message indique certainement un endommagement interne de votre instrument.**

MIDI et la compatibilité des données

■ MIDI

MIDI (Musical Instrument Digital Interface) est une interface standard de communication mondiale qui permet aux instruments de musique et à leurs équipements compatibles MIDI de partager des informations musicales et de se commander les uns les autres.

- Les données transmissibles/recevables varient selon les appareils MIDI et seules les données qui sont communément reconnues parmi les appareils MIDI connectés peuvent être transmises ou reçues. Vous pouvez vérifier si votre instrument accepte certains types de données en vous référant à la feuille d'implantation MIDI dans le mode d'emploi de l'instrument. Vous trouverez la feuille d'implantation MIDI du CVP-98/96/600 page 25 de ce manuel.

Connecteurs MIDI

Les données reçues via le connecteur MIDI IN sont retransmises inchangées via ce connecteur.

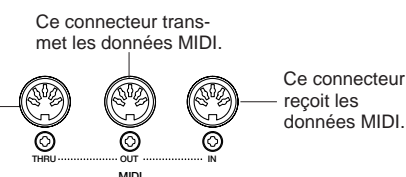

Câble MIDI

Raccordez les appareils MIDI avec les câbles spéciaux MIDI.

- Vous pouvez procéder aux divers réglages MIDI à partir de la section fonction des pages 1 - 3 MIDI.
- Vous trouverez de plus amples informations sur MIDI et ses applications dans les livres et magazines de musique.

■ Compatibilité des données

Cette section couvre les informations de base sur la compatibilité des données : à savoir, si les autres appareils MIDI peuvent ou non reproduire les données enregistrées sur le CVP-98/96/600 et si le CVP-98/96/600 peut ou non reproduire les données de morceaux disponibles dans le commerce ou les données de morceaux créés pour d'autres instruments ou sur un ordinateur.

En fonction de l'appareil MIDI ou des caractéristiques de données, vous pourrez reproduire les données sans problème ou vous devrez procéder à des opérations spéciales avant de pouvoir reproduire ces données. Si vous rencontrez des problèmes pour reproduire vos données, veuillez vous reporter aux informations mentionnées ci-dessous.

● Points de base à vérifier

Les données et les appareils MIDI doivent correspondre au niveau des points indiqués ci-dessous.

- **Format de disquette**
- **Format de séquence**
- **Format d'allocation de voix**

● Format de disquette

Les disquettes sont le moyen de sauvegarde principal des données utilisées avec divers appareils, dont les ordinateurs. Les appareils différents sont dotés de systèmes différents de sauvegarde des données et il est donc nécessaire de configurer tout d'abord la disquette au système de l'appareil utilisé. Cette opération s'appelle le "formatage".

- Il y a deux sortes de disquettes : MF2DD (double face, double densité) et MF2HD (double face, haute densité) et chacun de ces types dispose d'un système de formatage différent.
- Le CVP-98/96/600 peut enregistrer et reproduire avec ces deux types de disquettes.
- Lorsqu'elles sont formatées par le CVP-98/96/600, une disquette 2DD sauvegarde jusqu'à 720 KO (kilo-octets) et une disquette 2HD jusqu'à 1,44 MO (méga-octets). (Les chiffres "720 KO" et "1,44 MO" indiquent la capacité mémoire des disquettes. Ils sont également utilisés pour identifier le type de format de la disquette).

- Vous ne pouvez reproduire que lorsque l'appareil MIDI à utiliser est compatible avec le format de la disquette.

● Format de séquence

Le système qui enregistre les données de morceaux est appelé "format de séquence".

- Vous ne pouvez reproduire que lorsque le format de séquence des disquettes correspond à celui des appareils MIDI.

[Formats de séquence communs]

SMF (Fichier MIDI standard)

C'est le format de séquence le plus commun.

- Les fichiers MIDI standard sont généralement disponibles sous l'un de ces deux types : Format 0 ou Format 1.
- De nombreux appareils MIDI sont compatibles avec le format 0 et la plupart des logiciels disponibles dans le commerce sont enregistrés dans le format 0.
- Le CVP-98/96/600 est compatible avec le format 0 et le format 1 (pour le format 1, jusqu'à un maximum de 17 gros morceaux).
- Les données enregistrées sur le CVP-98/96/600 sont automatiquement enregistrées comme SMF de format 0.

ESEQ

Ce format de séquence est compatible avec de nombreux appareils MIDI de Yamaha, y compris les instruments de la série Clavinova. C'est le format commun utilisé pour différents logiciels Yamaha.

- Le CVP-98/96/600 est compatible avec le format ESEQ.

● Format d'allocation de voix

Avec MIDI, les voix sont assignées à des numéros spécifiques, appelés "numéros de programmes". Le standard de numérotation (ordre d'allocation de voix), est appelé le "format d'allocation de voix".

- La reproduction des voix peut s'avérer différente des résultats escomptés à moins que le format d'allocation de voix des données corresponde à celui de l'appareil MIDI compatible utilisé pour la reproduction.

[Principaux formats d'allocation de voix]

Niveau 1 du système GM

C'est l'un des formats d'allocation de voix les plus courants.

- De nombreux appareils MIDI sont compatibles avec le niveau 1 du système GM, comme la plupart des logiciels disponibles dans le commerce.
- Le CVP-98/96/600 est compatible avec le niveau 1 du système GM.

XG

XG est une amélioration majeure du format de niveau 1 du système GM qui a été développé par Yamaha, spécialement pour offrir plus de voix et de variations, de même qu'une plus grande commande expressive sur les voix et les effets et aussi pour assurer la compatibilité des données dans l'avenir.

- Le CVP-98/96/600 est compatible avec le format XG.
- Les données enregistrées sur le CVP-98/96/600 reçoivent automatiquement une allocation de voix XG.

DOC











Ce format d'allocation de voix est compatible avec de nombreux appareils MIDI de Yamaha, y compris les instruments de la série Clavinova. C'est aussi un format commun utilisé avec les divers logiciels Yamaha.









- Le CVP-98/96/600 est compatible avec le format DOC.

Même quand les appareils et les données satisfont à toutes les conditions mentionnées ci-dessus, les données pas toujours entièrement compatibles, en fonction des spécifications des appareils et notamment des méthodes d'enregistrement des données.



Mensajes













Mensajes comunes

 No disk !	<p>Este mensaje aparece cuando no hay ningún disco en la unidad de discos.</p> <p>➤ Ponga el disco apropiado en la unidad de discos y vuelva a intentar la operación</p>
 No songs !	<p>Cuando cambia el nombre de la canción original o convierte los datos, aparecerá este mensaje para avisarle que no hay datos de canción.</p> <p>➤ Seleccione una canción que contenga datos, o inserte un disco con datos de canción en la unidad de discos flexibles.</p>
 No file !	<p>Este mensaje aparece si no hay datos de la memoria de registros, de microafinación, ni otros datos relacionados en el disco actualmente insertado cuando usted intenta hacer una operación relacionada con archivos.</p> <p>➤ Cree un archivo o inserte un disco con un archivo adecuado.</p>
 Start disk format ? <input type="button" value="OK"/> <input type="button" value="CANCEL"/>	<p>Este mensaje aparece cuando se ha insertado en la unidad de discos un disco nuevo o un disco que no está formateado para la Clavinova. (Vea la página 106 del manual de instrucciones.)</p> <p>➤ Presione OK si desea formatear el disco. Presione CANCEL si desea abortar el proceso de formato.</p>
 Protected disk !	<p>Este mensaje aparece cuando usted intenta grabar o efectuar otras operaciones de archivos en un disco cuyo lengüeta de protección contra escritura está colocada en el lado de "protección contra escritura".</p> <p>➤ Ajuste la lengüeta de protección contra escritura en la posición de escritura permitida (página 7 del manual de instrucciones) e intente de nuevo la operación. Si todavía no puede realizarse la operación, significa que el disco tiene en sí protección interna, haciendo imposible las operaciones de escritura o de archivos en el disco.</p>
 Protected songs !	<p>Este mensaje aparece cuando se intentan grabar partes u otras operaciones de archivos que no son compatible o que no permiten tales operaciones. Dependiendo del tipo de archivo, las operaciones tales como las de grabación adicional, copiado, borrado, etc. pueden resultar imposibles en la CVP-98/96/600.</p>
 Disk read/write error ! <input type="button" value="OK"/>	<p>Ha ocurrido un error durante la escritura (como por ejemplo al grabar o almacenar archivos) o al leer del disco.</p> <p>➤ Intente de nuevo la operación después de presionar el botón OK. Si el error vuelve a ocurrir, significa que el disco o la unidad de discos están defectuosos. Si usted sospecha que la unidad de discos está defectuosa, mencione este problema a su distribuidor Yamaha.</p>
 Completed !	<p>Aparece durante algunos segundos cuando se ha terminado una operación que lleva cierto tiempo en completarse como por ejemplo las de formato, copiado de canciones, etc.</p>
 Don't remove the disk !	<p>Este mensaje aparece cuando los datos se transfieren entre la Clavinova y el disco.</p> <p>➤ El mensaje desaparece automáticamente cuando se termina la operación.</p>
 Are you sure ? <input type="button" value="YES"/> <input type="button" value="NO"/>	<p>Cuando se seleccionan operaciones tales como las de borrado de canciones o de formato, este mensaje le hace confirmar si desea proseguir o no con la operación.</p> <p>➤ Presione YES para ejecutar la operación. Presione NO para volver a la visualización anterior.</p>
 Disk full ! <input type="button" value="OK"/>	<p>El disco actualmente insertado está lleno y no tiene espacio para almacenar más datos.</p> <p>➤ Presione el botón OK, y borre los datos que no sean necesarios del disco (página 138 del manual de instrucciones), o emplee un disco que tenga más espacio libre disponible. Si aparece durante la grabación de canciones (en este caso no aparecerá OK), la grabación se detendrá y los datos grabados hasta ese punto se almacenarán automáticamente.</p>

 Too many files ! <input type="button" value="OK"/>	<p>Un disco del tipo 2DD o del tipo 2HD tiene cabida para 60 archivos de canciones. Un disco 2DD tiene cabina para unos 110 archivos (de varios tipos), y un disco 2HD tiene cabina para unos 220 archivos.</p> <p>Este mensaje aparece cuando se intentan producir más archivos de los que es capaz el disco.</p> <ul style="list-style-type: none"> > Presione el botón OK, y borre los archivos innecesarios del disco (página 138 del manual de instrucciones), o emplee un disco que tenga más espacio disponible.
 Same name ! Overwrite ? <input type="button" value="OK"/> <input type="button" value="CANCEL"/>	<p>Existe un nombre con el mismo archivo.</p> <ul style="list-style-type: none"> > Presione el botón OK si desea sobrescribir el archivo original con los datos nuevos, o presione CANCEL para abortar la operación.
 This button can't be used during recording or playback !	<p>Este mensaje aparece cuando se intentan efectuar operaciones que no pueden hacerse durante la grabación o reproducción, tales como las de conversión de datos, formateado, etc.</p> <ul style="list-style-type: none"> > Detenga la grabación o reproducción, o salga del modo de grabación/reproducción, y efectúe entonces la operación.
 This button can't be used during playback !	<p>Este mensaje aparece cuando se intentan efectuar otras operaciones mientras se leen o almacenan datos en el disco.</p> <ul style="list-style-type: none"> > Detenga la reproducción de la canción, o salga del modo de reproducción, y efectúe entonces la operación.
 Button not valid !	<p>Se ha presionado un botón que no tiene una función en el modo actual.</p>
 Disk read/write operation in process !	<p>Este mensaje aparece cuando se intentan ejecutar otras operaciones mientras se leen o almacenan datos en el disco.</p> <ul style="list-style-type: none"> > Espere a que se termine la operación de lectura/escritura de datos, y efectúe entonces la operación.
 Memory write operation in process !	<p>Este mensaje aparece cuando se intentan ejecutar otras operaciones mientras se escriben datos editados de una canción grabada en la RAM interna.</p> <ul style="list-style-type: none"> > Complete la operación de escritura de datos y luego efectúe la otra operación.
 Delete CVP MEMORY ? <input type="button" value="YES"/> <input type="button" value="NO"/>	<p>Este mensaje aparece cuando se ejecuta una operación que ocasiona el borrado de los datos grabados en la RAM interna, como por ejemplo la reproducción de programas de discos.</p> <ul style="list-style-type: none"> > Presione YES para borrar los datos grabados en la RAM interna, y efectúe entonces la operación deseada. Presione el botón NO si desea conservar los datos.
 Convert to CVP songs ? <input type="button" value="YES"/> <input type="button" value="NO"/>	<p>Este mensaje aparece cuando se intenta grabar encima de datos de edición o de programas de venta en el mercado, o datos grabados en otras Clavinovas que no son las CVP-94/92/98/96/600.</p> <ul style="list-style-type: none"> > Presione YES para convertir los datos para grabación/edición en las CVP-94/92/98/96/600. Presione NO si no desea convertir los datos.

● Mensajes relacionados con el copiado de canciones

 Number of disk exchange (1) <input type="button" value="OK"/> <input type="button" value="CANCEL"/>	<p>Este mensaje le informa de las veces que los discos deben intercambiarse cuando se copia una canción a otro disco antes de empezar la operación de copiado de discos. (Vea la página 137 del manual de instrucciones.)</p>
 Insert Disk 2. (1 / 3) <input type="button" value="CANCEL"/>	<p>Inserte el disco de destino a copiarse. (Vea la página 137 del manual de instrucciones.)</p>
 Please select destination song number. <div style="border: 1px solid black; padding: 2px; width: fit-content;">SONG 1 </div> <input type="button" value="OK"/> <input type="button" value="CANCEL"/>	<p>Cuando copia una canción del disco de origen a otro disco, este mensaje le indica que especifique el número de canción en el disco de destino al que debe copiarse la canción, cuando se inserta primero el disco. (Vea la página 137 del manual de instrucciones.)</p>

 Insert Disk 1. (2 / 3) <input type="button" value="CANCEL"/>	<p>Este mensaje le indica que inserte el disco de origen cuando copie canciones a un segundo disco. (Vea la página 137 del manual de instrucciones.)</p>
 Select a different number !	<p>Aparece cuando se selecciona el mismo número de canción para el origen y destino en la operación de copiado de canciones.</p> <p>➤ Cambie el número de canción de destino.</p>
<h2>● Mensajes relacionados con los estilos de usuario</h2>	
 CUSTOM STYLE Please select a source style.	<p>Este mensaje aparece durante algunos segundos cuando se activa el modo de estilos del usuario. (Vea la página 68 del manual de instrucciones.)</p>
 Clear style ? <input type="button" value="OK"/> <input type="button" value="CANCEL"/>	<p>Este mensaje de confirmación aparece cuando se intenta cambiar el parámetro del tiempo en el modo de estilo de usuario. (Vea la página 70 del manual de instrucciones.)</p>
 Clear section ? <input type="button" value="OK"/> <input type="button" value="CANCEL"/>	<p>Este mensaje de confirmación aparece cuando se intenta cambiar el número de compases en el modo de estilo de usuario. (Vea la página 70 del manual de instrucciones.)</p>
 Clear part ? <input type="button" value="OK"/> <input type="button" value="CANCEL"/>	<p>Este mensaje de confirmación aparece cuando se intenta efectuar alguna operación que sólo puede hacerse después de borrar la parte del estilo original en el modo de estilos del usuario. (Vea la página 71 del manual de instrucciones.)</p>
 Store Bossa NovaX ? MEMORY No. 1 TEMP. STYLE 1 <input type="button" value="OK"/> <input type="button" value="CANCEL"/>	<p>Este mensaje de confirmación aparece cuando se intenta una operación de almacenamiento en el modo de estilos de usuario. (Vea la página 74 del manual de instrucciones.) También aparece cuando se intenta cambiar de estilo antes del almacenamiento. (Vea la página 79 del manual de instrucciones.)</p>
 Store Bossa NovaX ? MEMORY No. 1 TEMP. STYLE 1 <input type="button" value="YES"/> <input type="button" value="NO"/> <input type="button" value="CANCEL"/>	<p>Este mensaje de confirmación aparece cuando se intenta salir del modo de estilos de usuario antes de almacenar los datos. (Vea la página 79 del manual de instrucciones.)</p> <p>➤ Seleccione YES para almacenarlos. Presione NO para salir sin almacenar los datos. Presione CANCEL para volver a la visualización anterior sin almacenar los datos. (Vea la página 79 del manual de instrucciones.)</p>
 Can't recall ! <input type="button" value="OK"/>	<p>Este mensaje aparece cuando no puede efectuarse la operación de la sección de llamada del modo de estilos del usuario, debido a cambios en la signatura de tiempo (tiempo). (Vea la página 74 del manual de instrucciones.)</p>
 Please store to memory before saving to disk <input type="button" value="OK"/>	<p>Si los datos no se han puesto en la memoria antes de su almacenamiento en el disco en el modo de estilos del usuario, este mensaje le indica que ponga los datos en la memoria antes de proseguir. (Vea la página 76 del manual de instrucciones.)</p>
 Not enough memory ! Please delete an unneeded style or simplify the current style. <input type="button" value="DELETE"/> <input type="button" value="CANCEL"/>	<p>Este mensaje aparece cuando no hay suficiente espacio de memoria interna para almacenar los datos en el modo de estilos del usuario. (Vea la página 78 del manual de instrucciones.)</p>
 Delete style ? MEMORY No. 1 188Beat Pop1 17KB <input type="button" value="OK"/> <input type="button" value="CANCEL"/>	<p>Este mensaje aparece cuando se selecciona DELETE desde la visualización arriba mostrada.</p> <p>➤ Seleccione el estilo a borrarse y presione el botón OK. Presione CANCEL si no desea borrar el estilo.</p>
 Not enough memory ! <input type="button" value="OK"/>	<p>Este mensaje aparece cuando la capacidad de la memoria se ha llenado durante la grabación en el modo de estilos del usuario (página 78 del manual de instrucciones.) También aparece cuando se ha llenado la memoria durante la grabación de una canción en la RAM interna. En este caso (OK no aparece), la grabación se parará y los datos grabados hasta ese punto se almacenarán automáticamente.</p>

● Mensajes relacionados con la conversión de datos grabados

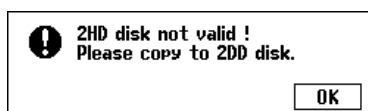

Este mensaje aparece si se emplea un disco 2HD para efectuar la conversión de los datos grabados.

- Presione **OK** y copie los datos de canción a convertirse a un disco 2DD, y efectúe entonces la conversión de datos empleando el disco.

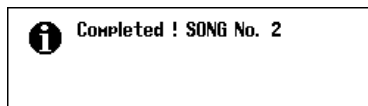

Después de la conversión de los datos de canción, aparece este mensaje mostrando el número de la canción en la que se han almacenado los datos.

● Mensajes relacionados con cambios de datos iniciales

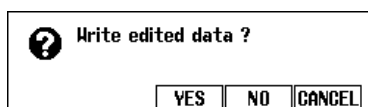

Este mensaje de confirmación aparece si intenta salir de la función de edición inicial sin escribir los datos.

- Presione **YES** para escribir los datos cambiados. Presione **NO** para salir sin escribirlos. Presione **CANCEL** para volver a la visualización de edición inicial sin escribirlos.

● Mensajes relacionados con secuencias de acordes

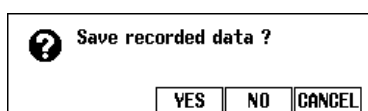

Este mensaje de confirmación aparece si intenta salir de la función de secuencias de acordes durante la grabación.

- Presione **YES** para almacenar los datos grabados. Presione **NO** para salir sin almacenarlos. Presione **CANCEL** para volver a la visualización de secuencia de acordes sin almacenar.

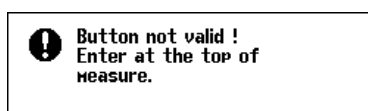

Este mensaje aparece durante la grabación de secuencias de acordes cuando se intenta introducir un estilo de acompañamiento o cambio de sección en una posición que no es el principio de un compás.

- Grabe los cambios de estilo de acompañamiento o de sección sólo al principio del compás. (Vea la página 118 del manual de instrucciones.)

● Mensajes relacionados con la carga de archivos de estilos

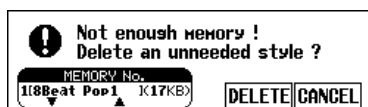

Este mensaje aparece cuando se intenta cargar un archivo de estilos sin haber suficiente memoria para el archivo especificado. (Vea la página 82 del manual de instrucciones.)

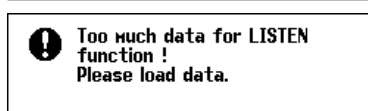

Algunos archivos de estilos son demasiado grandes para poder ser manipulados por la característica **LISTEN** de la función de carga de archivos de estilos. (Vea la página 81 del manual de instrucciones.)

● Otros mensajes

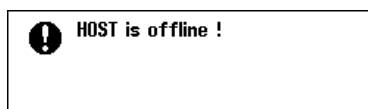

Este mensaje aparece cuando el ordenador principal no tiene la alimentación conectada, cuando el selector **HOST SELECT** no está en la posición correcta, o cuando el driver de MIDI o la aplicación MIDI no están activados. En este caso, desconecte la alimentación de la Clavinova y del ordenador, y compruebe la conexión del cable y la posición del selector **HOST SELECT**. Una vez ha verificado la conexión y la posición del selector **HOST SELECT**, conecte primero la alimentación del ordenador y luego la de la Clavinova, para comprobar si el driver de MIDI y la aplicación MIDI funcionan correctamente.

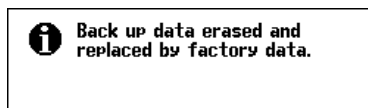

Mientras se emplee regularmente la Clavinova, los datos se retienen en la memoria. Si se deja sin utilizar el instrumento durante una semana o período más largo antes de volver a conectar la alimentación, los datos se borran y aparece este mensaje. Este mensaje también aparece cuando usted activa todos los datos de fábrica. (Vea la página 147 del manual de instrucciones.)



Se ha detectado un problema en el sistema del hardware durante la conexión de la alimentación.

- Pregunte a su distribuidor Yamaha sobre este problema.

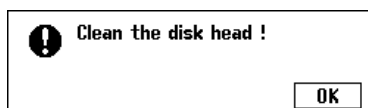

La cabeza del disco está sucia. Limpie la cabeza del disco empleando un disco de limpieza de cabezas de venta en las tiendas del ramo.

Localización y reparación de averías.....

Problema	Causa	Solución
La alimentación de la Clavinova no se conecta.	Las clavijas del cable de la alimentación no están insertadas en la Clavinova o en la toma de corriente de CA.	Inserte bien una de las clavijas del cable en el instrumento y la otra en una toma adecuada de corriente de CA.
Suena un sonido seco o de ruido cuando se conecta/desconecta la alimentación.	Circula la corriente eléctrica al instrumento.	Esto es normal, y no hay por qué preocuparse.
El visualizador LCD tiene demasiado brillo o es demasiado oscuro para leerse.	El brillo puede cambiar debido a la temperatura ambiental.	Ajuste el contraste del visualizador empleando el control [CONTRAST] . (Vea la página 15 del manual de instrucciones.)
La pantalla instantánea no se abre.	La lámpara [DISPLAY HOLD] está encendida.	Presione el botón [DISPLAY HOLD] para que se apague la lámpara. (Vea la página 15 del manual de instrucciones.)
El volumen del sonido del teclado es bajo en comparación con el del acompañamiento automático o de la reproducción de discos.	El nivel de volumen independiente del sonido de interpretación del teclado tiene un ajuste demasiado bajo.	Suba el volumen de interpretación del teclado en la visualización de MIXER . (Vea la página 94 del manual de instrucciones.)
El sonido del acompañamiento automático o de la reproducción de discos es bajo en comparación con el del teclado.	El ajuste de [ACMP/SONG VOLUME] es bajo.	Aumente el nivel de [ACMP/SONG VOLUME] .
Todo el sonido es bajo o no sale sonido.	El ajuste de [MASTER VOLUME] es bajo.	Aumente el nivel de [MASTER VOLUME] .
	Los auriculares están conectados.	Desconecte los auriculares.
	El control local está desactivado.	Active el control local. (Vea la página 144 del manual de instrucciones.)
El pedal apagador no tiene ningún efecto, o el sonido se sostiene continuamente incluso cuando no se pisa el pedal.	La clavija del cable del pedal no está enchufada.	Inserte correctamente la clavija del cable del pedal en la toma adecuada. (Vea la página 41 de este manual para la CVP-600, y la página 49 para la CVP-98/96.)
El acompañamiento automático o la reproducción de discos no se inician.	MIDI Sync se ha ajustado a "EXT".	Ajuste MIDI Sync a "INT." (Vea la página 144 del manual de instrucciones.)
Cuando se toca el teclado, no suenan todas las notas.	Se han tocado notas que exceden la capacidad de polifonía simultánea del teclado (número máximo de notas).	El sistema de generación de notas está configurado de modo que las últimas notas tienen prioridad, pudiendo provocar el corte de notas anteriores. Vea la sección de "Especificaciones" de la página 37 de este manual para encontrar información sobre la capacidad polifónica simultánea.
No se reproduce el acompañamiento automático.	El acompañamiento automático no está activado.	Presione el botón [ACMP ON] para activar el acompañamiento automático.

Problema	Causa	Solución
El acorde deseado no se reconoce o no se emite con el acompañamiento automático.	Las teclas no se tocan correctamente.	Consulte la “Gráfica de digitado” (página 36 de este manual).
	Las teclas no se tocan de acuerdo con el tipo de acompañamiento automático seleccionado.	Compruebe el tipo del acompañamiento automático, y toque las teclas de acuerdo con el tipo seleccionado. (Vea la página 56 del manual de instrucciones.)
No pueden grabarse el máximo de 60 canciones.	La capacidad de la memoria está llena porque el tiempo de interpretación de una o más canciones es largo, o porque se han usado muchas funciones.	Borre las canciones innecesarias (página 138 del manual de instrucciones) o grabe en un disco nuevo.
Algunas pistas no se reproducen durante la reproducción de datos.	Se ha desactivado la reproducción de las pistas.	Active la reproducción de las pistas que no suenan. (Vea las páginas 91, 94 del manual de instrucciones.)



- * Si aparece un mensaje de “Hardware Error!” en el visualizador cuando se conecta la alimentación, póngase en contacto inmediatamente con el distribuidor Yamaha porque indica algún tipo de daño interno del instrumento.

MIDI y compatibilidad de datos

■ MIDI

MIDI (interfaz digital de instrumentos musicales) es una interfaz de comunicaciones de normas internacionales que permite a instrumentos y equipos musicales compatibles con MIDI intercambiar y compartir información y control musical.

- Dependiendo del dispositivo MIDI, los datos que pueden transmitirse/recibirse son distintos, y sólo los datos que normalmente se reconocen entre los dispositivos MIDI conectados pueden transmitirse y recibirse. Podrá comprobar si su instrumento apoya ciertos tipos de datos consultando la gráfica de implementación MIDI del manual de instrucciones del instrumento. La gráfica de implementación MIDI de la CVP-98/96/600 está en la página 25 de este manual.

Terminales MIDI

Los datos recibidos a través del terminal MIDI IN se retransmiten sin cambiar por este terminal.

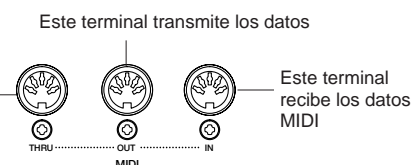

Cable MIDI

Conecte los dispositivos MIDI con cables MIDI especiales.

- Pueden hacerse varios ajustes MIDI desde las páginas MIDI 1 - 3 de la sección de "Function".
- Para más información sobre MIDI y sus aplicaciones, consulte libros y revistas musicales.

■ Compatibilidad de datos

Esta sección abarca la información básica sobre la compatibilidad de datos: si otros dispositivos MIDI pueden reproducir los datos granados con la CVP-98/96/600, y si la CVP-98/96/600 puede reproducir datos de canciones de venta en las tiendas del ramo creados para otros instrumentos o en un ordenador.

Dependiendo de las características del dispositivo MIDI o de los datos, es posible reproducir los datos sin ningún problema, o es posible que se tengan que realizar operaciones especiales antes de reproducir los datos. Si tiene algún problema con la reproducción de datos, consulte la información siguiente.

● Puntos básicos de comprobación

Los datos y el dispositivo MIDI deben corresponderse en cuanto a los puntos siguientes.

- Formato de disco
- Formato de secuencias
- Formato de asignación de voces

● Formato de disco

Los discos flexibles son un medio de almacenamiento principal para datos y se emplean con varios dispositivos, incluyendo ordenadores. Los dispositivos tienen sistemas diferentes para almacenar los datos, por lo que es necesario primero configurar el disco flexible para el dispositivo en el que se va a utilizar. Esta operación se denomina "formateado".

- Hay dos tipos de discos flexibles: MF2DD (dos caras, densidad doble) y MF2HD (dos caras, alta densidad), y cada uno tiene sistemas de formateado distintos.
- La CVP-98/96/600 puede grabar y reproducir en ambos tipos de discos flexibles.
- Los discos 2DD, cuando se han formateado con la CVP-98/96/600, tienen una capacidad de 720 KB (kilobytes) y un disco 2HD puede almacenar hasta 1,44 MB (megabytes). (Los números de "720 KB" y "1,44 MB" indican la capacidad de memoria de datos. También se emplean para indicar el tipo de formato del disco.)
- La reproducción sólo es posible cuando el dispositivo MIDI a utilizarse es compatible con el formato del disco.

● Formato de secuencias

El sistema que graba datos de canción se denomina "formato de secuencias".

- La reproducción sólo es posible cuando el formato de secuencias del disco corresponde con el del dispositivo MIDI.

[Formatos de secuencias comunes]

SMF (archivo MIDI estándar)

Este es el formato de secuencias más común.

- Los archivos MIDI estándar están normalmente disponibles en uno de los dos tipos: Formato 0 o formato 1.
- Muchos dispositivos MIDI son compatibles con el formato 0, y la mayor parte de programas de venta en las tiendas del ramo están grabados en el formato 0.
- La CVP-98/96/600 es compatible con ambos formatos, el 0 y el 1 (para el formato 1, hasta un máximo de 17 bloques de información).
- Los datos de canción grabados en la CVP-98/96/600 se graban automáticamente en el formato 0 de SMF.

ESEQ

Este formato de secuencias es compatible con muchos de los dispositivos MIDI Yamaha, incluyendo instrumentos de la serie de la Clavinova. Es un formato común empleado con varios programas de Yamaha.

- La CVP-98/96/600 es compatible con ESEQ.

● Formato de asignación de voces

Con el sistema MIDI, las voces se asignan a números específicos, denominados "números de programa". La norma de numeración (orden de asignación de voces) se denomina "formato de asignación de voces".

- Es posible que las voces no se reproduzcan como se espera a menos que el formato de asignación de voces de los datos de canción corresponda con el del dispositivo MIDI compatible utilizado para la reproducción.

[Formatos principales de asignación de voces]

Sistema GM de nivel 1

Este es uno de los formatos de asignación de voces más comunes.

- Muchos dispositivos MIDI son compatibles con el sistema GM de nivel 1, así como la mayor parte de programas de venta en las tiendas del ramo.
- La CVP-98/96/600 es compatible con el sistema GM de nivel 1.

XG

XG es una mejora importante del formato del sistema GM de nivel 1, y fue desarrollado por Yamaha especialmente para proporcionar más voces y variaciones, así como mayor control de la expresión de voces y efectos, y para asegurar compatibilidad de datos para el futuro.

- La CVP-98/96/600 es compatible con XG.
- Los datos de canción grabados en la CVP-98/96/600 reciben automáticamente asignación de voces XG.

DOC

Este formato de asignación de voces es compatible con muchos de los dispositivos MIDI de Yamaha, incluyendo los instrumentos de la serie de la Clavinova.

Este formato también es comúnmente empleado en los programas de Yamaha de venta en las tiendas del ramo.

- La CVP-98/96/600 es compatible con DOC.

Aunque los dispositivos y datos empleados satisfagan todas las condiciones de arriba, es posible que los datos no acaben de ser compatibles del tono, dependiendo de las especificaciones de los dispositivos y métodos particulares de grabación de los datos.

MIDI Data Format / MIDI-Datenformat / Format des données MIDI / Formato de datos MIDI

Many MIDI messages listed in the MIDI Data Format are expressed in decimal numbers, binary numbers and hexadecimal numbers. Hexadecimal numbers may include the letter "H" as a suffix. Also, "n" can freely be defined as any whole number.

To enter data/values, refer to the table below.

Decimal	Hexadecimal	Binary	Decimal	Hexadecimal	Binary
0	00	0000 0000	64	40	0100 0000
1	01	0000 0001	65	41	0100 0001
2	02	0000 0010	66	42	0100 0010
3	03	0000 0011	67	43	0100 0011
4	04	0000 0100	68	44	0100 0100
5	05	0000 0101	69	45	0100 0101
6	06	0000 0110	70	46	0100 0110
7	07	0000 0111	71	47	0100 0111
8	08	0000 1000	72	48	0100 1000
9	09	0000 1001	73	49	0100 1001
10	0A	0000 1010	74	4A	0100 1010
11	0B	0000 1011	75	4B	0100 1011
12	0C	0000 1100	76	4C	0100 1100
13	0D	0000 1101	77	4D	0100 1101
14	0E	0000 1110	78	4E	0100 1110
15	0F	0000 1111	79	4F	0100 1111
16	10	0001 0000	80	50	0101 0000
17	11	0001 0001	81	51	0101 0001
18	12	0001 0010	82	52	0101 0010
19	13	0001 0011	83	53	0101 0011
20	14	0001 0100	84	54	0101 0100
21	15	0001 0101	85	55	0101 0101
22	16	0001 0110	86	56	0101 0110
23	17	0001 0111	87	57	0101 0111
24	18	0001 1000	88	58	0101 1000
25	19	0001 1001	89	59	0101 1001
26	1A	0001 1010	90	5A	0101 1010
27	1B	0001 1011	91	5B	0101 1011
28	1C	0001 1100	92	5C	0101 1100
29	1D	0001 1101	93	5D	0101 1101
30	1E	0001 1110	94	5E	0101 1110
31	1F	0001 1111	95	5F	0101 1111
32	20	0010 0000	96	60	0110 0000
33	21	0010 0001	97	61	0110 0001
34	22	0010 0010	98	62	0110 0010
35	23	0010 0011	99	63	0110 0011
36	24	0010 0100	100	64	0110 0100
37	25	0010 0101	101	65	0110 0101
38	26	0010 0110	102	66	0110 0110
39	27	0010 0111	103	67	0110 0111
40	28	0010 1000	104	68	0110 1000
41	29	0010 1001	105	69	0110 1001
42	2A	0010 1010	106	6A	0110 1010
43	2B	0010 1011	107	6B	0110 1011
44	2C	0010 1100	108	6C	0110 1100
45	2D	0010 1101	109	6D	0110 1101
46	2E	0010 1110	110	6E	0110 1110
47	2F	0010 1111	111	6F	0110 1111
48	30	0011 0000	112	70	0111 0000
49	31	0011 0001	113	71	0111 0001
50	32	0011 0010	114	72	0111 0010
51	33	0011 0011	115	73	0111 0011
52	34	0011 0100	116	74	0111 0100
53	35	0011 0101	117	75	0111 0101
54	36	0011 0110	118	76	0111 0110
55	37	0011 0111	119	77	0111 0111
56	38	0011 1000	120	78	0111 1000
57	39	0011 1001	121	79	0111 1001
58	3A	0011 1010	122	7A	0111 1010
59	3B	0011 1011	123	7B	0111 1011
60	3C	0011 1100	124	7C	0111 1100
61	3D	0011 1101	125	7D	0111 1101
62	3E	0011 1110	126	7E	0111 1110
63	3F	0011 1111	127	7F	0111 1111

- Except the table above, for example 144-159(decimal)/9nH/1001 0000-1001 1111(binary) displays the Note On Message for each channel (1-16). 176-191/ BnH/1011 0000-1011 1111 displays the Control Change Message for each channel (1-16). 192-207/CnH/1100 0000-1100 1111 displays the Program Change Message for each channel (1-16). 240/FOH/1111 0000 denotes the start of a System Exclusive Message. 247/F7H/1111 0111 denotes the end of a System Exclusive Message.
- aaH (hexadecimal)/0aaaaaaa (binary) denotes the data address. The address contains High, Mid, and Low.
- bbH/0bbbbbbb denotes the byte count.
- ccH/0ccccccc denotes the check sum.
- ddH/0ddddddd denotes the data/value.

(1) TRANSMIT FLOW

MIDI OUT	← KEY ON/OFF	9nH
	CONTROL CHANGE	BnH
	BANK SELECT MSB	BnH,00H
	BANK SELECT LSB	BnH,20H
	DATA ENTRY MSB	BnH,06H
	DATA ENTRY LSB	BnH,26H
	MAIN VOLUME	BnH,07H
	PANPOT	BnH,0AH
	EXPRESSION	BnH,0BH
	SUSTAIN	BnH,40H
	SOSTENUTE	BnH,42H
	SOFT PEDAL	BnH,43H
	REVERB SEND LEVEL	BnH,5BH
	VARIATION SEND LEVEL	BnH,5EH
	PROGRAM CHANGE	CnH
	SYSTEM EXCLUSIVE MESSAGE	
	<YAMAHA MIDI FORMAT>	
	<UNIVERSAL>	
	UNIVERSAL REALTIME	FOH 7FH.....F7H
	UNIVERSAL NON-REALTIME	FOH 7EH.....F7H
	<XG STANDARD>	
	XG PARAMETER CHANGE	FOH 43H 1nH 4CH aaH aaH aaH ddHddH F7H
	XG BULK DUMP	FOH 43H 0nH 4CH bbH bbH aaH aaH aaH ddH.....ddH ccH F7H
	<CLAVINOVA MIDI COMPLIANCE>	
	<SPECIAL OPERATORS>	
	SYSTEM REALTIME MESSAGE	
	MIDI CLOCK	F8H
	START	FAH
	STOP	FCH
	ACTIVE SENSING	FEH

(2) RECEIVE FLOW

MIDI IN	→ KEY OFF	8nH
	KEY ON/OFF	9nH
	CONTROL CHANGE	
	BANK SELECT MSB	BnH,00H
	BANK SELECT LSB	BnH,20H
	MODULATION	BnH,01H
	PORTAMENTO TIME	BnH,05H
	DATA ENTRY MSB	BnH,06H
	DATA ENTRY LSB	BnH,26H
	MAIN VOLUME	BnH,07H
	PANPOT	BnH,0AH
	EXPRESSION	BnH,0BH
	SUSTAIN	BnH,40H
	PORTAMENTO	BnH,41H
	SOSTENUTO	BnH,42H
	SOFT PEDAL	BnH,43H
	HARMONIC CONTENT	BnH,47H
	RELEASE TIME	BnH,48H
	ATTACK TIME	BnH,49H
	BRIGHTNESS	BnH,4AH
	PORTAMENTO CONTROL	BnH,54H
	REVERB SEND LEVEL	BnH,5BH
	CHORUS SEND LEVEL	BnH,5DH
	VARIATION SEND LEVEL	BnH,5EH
	DATA INCREMENT	BnH,60H
	DATA DECREMENT	BnH,61H
	NRPN LSB	BnH,62H
	NRPN MSB	BnH,63H
	VIBRATO RATE	BnH,63H,01H,62H,08H,06H,mmH
	VIBRATO DEPTH	BnH,63H,01H,62H,09H,06H,mmH
	VIBRATO DELAY	BnH,63H,01H,62H,0AH,06H,mmH
	FILTER CUTOFF FREQ.	BnH,63H,01H,62H,20H,06H,mmH
	FILTER RESONANCE	BnH,63H,01H,62H,21H,06H,mmH
	AEG ATTACK TIME	BnH,63H,01H,62H,63H,06H,mmH
	AEG DECAY TIME	BnH,63H,01H,62H,64H,06H,mmH
	AEG RELEASE	BnH,63H,01H,62H,66H,06H,mmH
	DRUM INST	
	CUTOFF FREQ.	BnH,63H,14H,62H,rrH,06H,mmH
	FILTER RESONANCE	BnH,63H,15H,62H,rrH,06H,mmH

*1

AEG ATTACK RATE	BnH,63H,16H,62H,rrH,06H,mmH
AEG DECAY RATE	BnH,63H,17H,62H,rrH,06H,mmH
PITCH COARSE	BnH,63H,18H,62H,rrH,06H,mmH
PITCH FINE	BnH,63H,19H,62H,rrH,06H,mmH
LEVEL	BnH,63H,1AH,62H,rrH,06H,mmH
PANPOT	BnH,63H,1CH,62H,rrH,06H,mmH
REVERB SEND	BnH,63H,1DH,62H,rrH,06H,mmH
CHORUS SEND	BnH,63H,1EH,62H,rrH,06H,mmH
VARIATION SEND	BnH,63H,1FH,62H,rrH,06H,mmH
RPN LSB	BnH,64H
RPN MSB	BnH,65H
PITCH BEND SENS.	BnH,65H,00H,64H,00H,06H,mmH
FINE TUNING	BnH,65H,00H,64H,01H,06H,mmH, 26H,IlH
COARSE TUNING	BnH,65H,00H,64H,02H,06H,mmH
NULL	BnH,65H,7FH,64H,7FH
ALL SOUND OFF	BnH,78H,00H
RESET ALL CONTROLLERS	BnH,79H,00H
ALL NOTES OFF	BnH,7BH,00H
OMNI OFF	BnH,7CH,00H
OMNI ON	BnH,7DH,00H
MONO	BnH,7EH
POLY	BnH,7FH
PROGRAM CHANGE	CnH
CHANNEL AFTER TOUCH	DnH
PITCH BEND CHANGE	EnH
SYSTEM EXCLUSIVE MESSAGE	
<YAMAHA MIDI FORMAT>	
<UNIVERSAL>	
UNIVERSAL REALTIME	F0H 7FH.....F7H
UNIVERSAL NON-REALTIME	F0H 7EH.....F7H
<XG STANDARD>	
XG PARAMETER CHANGE	F0H 43H 1nH 4CH aaH aaH aaH ddHddH F7H
XG BULK DUMP	F0H 43H 0nH 4CH bbH bbH aaH aaH aaH ddH.....ddH ccH F7H
PARAMETER REQUEST	F0H 43H 3nH 4CH aaH aaH aaH F7H
DUMP REQUEST	F0H 43H 2nH 4CH aaH aaH aaH F7H
<CLAVINOVA MIDI COMPLIANCE>	
<SPETIAL OPERATORS>	
<Others>	
SYSTEM REALTIME MESSAGE	
MIDI CLOCK	F8H
START	FAH
STOP	FCH
ACTIVE SENSING	FEH

*** PROGRAM NUMBER: XG SFX KIT number correspondence**

P = 1 SFX1 Kit
P = 2 SFX2 Kit

When DRUM VOICE is selected and program change data for a different DRUM VOICE is received, the currently selected DRUM VOICE will be replaced with the new DRUM VOICE.

(3-1-4) CHANNEL AFTER TOUCH (Recive only)

STATUS 1101nnnn(DnH) n = 0 - 15 VOICE CHANNEL NUMBER
VALUE 0vvvvvvv v = 0 - 127 AFTER TOUCH VALUE

(3-1-5) PITCH BEND CHANGE

STATUS 1110nnnn(EnH) n = 0 - 15 VOICE CHANNEL NUMBER
LSB 0vvvvvvv PITCH BEND CHANGE LSB
MSB 0vvvvvvv PITCH BEND CHANGE MSB

(3-1-6) CONTROL CHANGE

STATUS 1011nnnn(BnH) n = 0 - 15 VOICE CHANNEL NUMBER
CONTROL NUMBER 0ccccccc
CONTROL VALUE 0vvvvvvv

*** Transmit CONTROL NUMBER.**

c = 0 BANK SELECT MSB ; v = 0:XG NORMAL,
64:SFX NORMAL,
126:XG SFX KIT,
127:XG DRUM

c = 32 BANK SELECT LSB ; v = 0 - 127 *3
c = 6 DATA ENTRY MSB ; v = 0 - 127 *1
c = 38 DATA ENTRY LSB ; v = 0 - 127 *1
c = 7 MAIN VOLUME ; v = 0 - 127
c = 10 PANPOT ; v = 0 - 127
c = 11 EXPRESSION ; v = 0 - 127
c = 64 SUSTAIN ; v = 0-63:OFF, 64-127:ON *2
c = 66 SOSTENUTO ; v = 0-63:OFF, 64-127:ON *2
c = 67 SOFT PEDAL ; v = 0-63:OFF, 64-127:ON *2
c = 91 REVERB SEND LEVEL ; v = 0 - 127
c = 94 VARIATION SEND LEVEL ; v = 0 - 127
(When only Connection = 1[System])

*** Receive CONTROL NUMBER.**

c = 0 BANK SELECT MSB ; v = 0:XG NORMAL,
64:SFX NORMAL,
126:XG SFX KIT,
127:XG DRUM

c = 32 BANK SELECT LSB ; v = 0 - 127 *3
c = 1 MODULATION ; v = 0 - 127 *2
c = 5 PORTAMENTO TIME ; v = 0 - 127 *2
c = 6 DATA ENTRY MSB ; v = 0 - 127 *1
c = 38 DATA ENTRY LSB ; v = 0 - 127 *1
c = 7 MAIN VOLUME ; v = 0 - 127
c = 10 PANPOT ; v = 0 - 127
c = 11 EXPRESSION ; v = 0 - 127
c = 64 SUSTAIN ; v = 0-63:OFF, 64-127:ON *2
c = 65 PORTAMENTO ; v = 0-63:OFF, 64-127:ON *2
c = 66 SOSTENUTO ; v = 0-63:OFF, 64-127:ON *2
c = 67 SOFT PEDAL ; v = 0-63:OFF, 64-127:ON *2
c = 71 HARMONIC CONTENT ; v = 0:-64 - 64:0 - 127:+63 *2
c = 72 RELEASE TIME ; v = 0:-64 - 64:0 - 127:+63 *2
c = 73 ATTACK TIME ; v = 0:-64 - 64:0 - 127:+63 *2
c = 74 BRIGHTNESS ; v = 0:-64 - 64:0 - 127:+63 *2
c = 84 PORTAMENT CONTROL ; v = 0 - 127 *2
c = 91 REVERB SEND LEVEL ; v = 0 - 127
c = 93 CHORUS SEND LEVEL ; v = 0 - 127
c = 94 VARIATION SEND LEVEL ; v = 0 - 127
(When only Connection = 1[System])
c = 96 DATA INCREMENT ; v = 127 *1
c = 97 DATA DECREMENT ; v = 127 *1

*1 Only when setting the appointed parameter with RPN, NRPN.

*2 Does not effect Rhythm Voice.

*3 MSB=0, anything other than 63 is 0.

• Until a PROGRAM CHANGE message is received, the BANK SELECT operation will be suspended. When a Voice, including VOICE BANK, is changed, set the BANK SELECT and Program Change Message, and transmit in the following order, BANK SELECT MSB, LSB, PROGRAM CHANGE.

• MODULATION controls the Vibrato Depth.

• PORTAMENTO TIME controls the Pitch Change Speed when the Portamento Switch = ON. 0 being the shortest time, and 127 being the longest.

(3) TRANSMIT/RECEIVE DATA

(3-1) CHANNEL VOICE MESSAGES

(3-1-1) KEY OFF(Recive only)

STATUS 1000nnnn(8nH) n = 0 - 15 VOICE CHANNEL NUMBER
NOTE NUMBER 0kkkkkkk k = 0 (C-2) - 127 (G8)
VELOCITY 0vvvvvvv v: ignored

(3-1-2) KEY ON/OFF

STATUS 1001nnnn(9nH) n = 0 - 15 VOICE CHANNEL NUMBER
NOTE NUMBER 0kkkkkkk k = 0 (C-2) - 127 (G8)
VELOCITY 0vvvvvvv (v ≠ 0) NOTE ON
00000000 (v = 0) NOTE OFF

(3-1-3) PROGRAM CHANGE

STATUS 1100nnnn(CnH) n = 0 - 15 VOICE CHANNEL NUMBER
PROGRAM NUMBER 0ppppppp p = 0 - 127

*** PROGRAM NUMBER: XG DRUM VOICE number correspondence**

P = 0 Standard Kit
P = 1 Standard2 Kit
P = 8 Room Kit
P = 16 Rock Kit
P = 24 Elctmic Kit
P = 25 Analog Kit
P = 27 Dance Kit
P = 32 Jazz Kit
P = 40 Brush Kit
P = 48 Classic Kit

- PANPOT changes the value for the melody voice and rhythm voice in relation to the preset value.
- Portamento time is fixed to 0 when the PORTAMENTO CONTROL is used.
- HARMONIC CONTENT applies adjustment to the resonance value that is set by the voice. This parameter specifies relative change with the value of 64 producing 0 adjustment. As values get higher the sound becomes increasingly eccentric. Note that for some voices the effective parameter range is narrower than the legal parameter range.
- RELEASE TIME applies adjustment to the envelope release time set by the voice. This parameter specifies relative change with the value of 64 producing 0 adjustment.
- ATTACK TIME applies adjustment to the envelope attack time set by the voice. This parameter specifies relative change with the value of 64 producing 0 adjustment.
- BRIGHTNESS applies adjustment to the cut-off frequency set by the voice. This parameter specifies relative change with the value of 64 producing 0 adjustment. Lower voices produce a softer sound. For some voices the effective parameter range is narrower than the legal parameter range.

(3-2) CHANNEL MODE MESSAGES

STATUS	1011nnnn(BnH)	n = 0 - 15 VOICE CHANNEL NUMBER
CONTROL NUMBER	0ccccccc	c = CONTROL NUMBER
CONTROL VALUE	0vvvvvvv	v = DATA VALUE

(3-2-1) ALL SOUND OFF (Recv only)

(CONTROL NUMBER = 78H , DATA VALUE = 0)

Switches off all sound from the channel. Does not reset Note On and Hold On conditions established by Channel Messages.

(3-2-2) RESET ALL CONTROLLERS (Recv only)

(CONTROL NUMBER = 79H , DATA VALUE = 0)

Resets controllers as follows.

PITCH BEND CHANGE	0 (Center)
AFTER TOUCH	0 (min.)
MODULATION	0 (min.)
EXPRESSION	127 (max.)
SUSTAIN	0 (off)
SOSTENUTO	0 (off)
SOFT PEDAL	0 (off)
NRPN	Sets number to null. (Internal data remains unchanged)
RPN	Sets number to null. (Internal data remains unchanged)
PORTAMENT CONTROL	Resets portamento source note number
PORTAMENTO	0 (off)

(3-2-3) ALL NOTES OFF (Recv only)

(CONTROL NUMBER = 7BH , DATA VALUE = 0)

Switches off all of the channel's "on" notes. However, any notes being held by SUSTAIN or SOSTENUTO continue to sound until SUSTAIN/SOSTENUTO goes off.

(3-2-4) OMNI OFF (Recv only) (CONTROL NUMBER = 7CH , DATA VALUE = 0)

Same processing as for All Notes Off.

(3-2-5) OMNI ON (Recv only) (CONTROL NUMBER = 7DH , DATA VALUE = 0)

Same processing as for All Notes Off. Omni On is not executed.

(3-2-6) MONO (Recv only) (CONTROL NUMBER = 7EH , DATA VALUE = 0)

Same processing as for All Notes Off. If the 3rd byte is in a range of 0-16 the corresponding channel will be changed to Mode 4 (m=1).

(3-2-7) POLY (Recv only) (CONTROL NUMBER = 7FH , DATA VALUE = 0)

Same processing as for All Sounds Off and the corresponding channel will be changed to Mode 3.

(3-3) REGISTERED PARAMETER NUMBER(RPN)

STATUS	1011nnnn(BnH)	n = 0 - 15 VOICE CHANNEL NUMBER
RPN LSB	01100100(64H)	
RPN LSB NUMBER	0ppppppp	p = RPN LSB(refer to the list below)
RPN MSB	01100101(65H)	
RPN MSB NUMBER	0qqqqqqq	q = RPN MSB(refer to the list below)
DATA ENTRY MSB	00000110(06H)	
DATA VALUE	0mmmmmmm	m = Data Value
DATA ENTRY LSB	00100110(26H)	
DATA VALUE	0lllllll	l = Data Value

First appoints the parameter for RPN MSB/LSB, then sets the parameter value for data entry MSB/LSB.

RPN	D.ENTRY	PARAMETER NAME	DATA RANGE
LSB MSB	MSB LSB		
00H 00H	mmH —	PITCH BEND SENSITIVITY	00H - 18H (0 - 24 semitones)
01H 00H	mmH llH	FINE TUNE	{mmH,llH} = {00H,00H} - {40H,00H} - {7FH,7FH} (-8192*100/8192) - 0 - (+8192*100/8192)
02H 00H	mmH —	COARSE TUNE	28H - 40H - 58H (-24 - 0 +24 semitones)
7FH 7FH	— —	NULL	

Clears the current RPN number setting. Does not change the internal parameter settings.

(3-4) NON-REGISTERED PARAMETER NUMBER(NRPN) (Recv only)

STATUS	1011nnnn(BnH)	n = 0 - 15 VOICE CHANNEL NUMBER
NRPN LSB	01100010(62H)	
NRPN LSB NUMBER	0ppppppp	p = NRPN LSB(refer to the list below)
NRPN MSB	01100011(63H)	
NRPN MSB NUMBER	0qqqqqqq	q = NRPN MSB(refer to the list below)
DATA ENTRY MSB	00000110(06H)	
DATA VALUE	0mmmmmmm	m = Data Value

First appoints the parameter for NRPN MSB/LSB, then sets the parameter value for data entry MSB/LSB.

NRPN	D.ENTRY	PARAMETER NAME	DATA RANGE
MSB LSB	MSB LSB		
01H 08H	mmH —	VIBRATO RATE	00H - 40H - 7FH (-64 - 0 +63)
01H 09H	mmH —	VIBRATO DEPTH	00H - 40H - 7FH (-64 - 0 +63)
01H 0AH	mmH —	VIBRATO DELAY	00H - 40H - 7FH (-64 - 0 +63)
01H 20H	mmH —	FILTER CUTOFF FREQUENCY	00H - 40H - 7FH (-64 - 0 +63)
01H 21H	mmH —	FILTER RESONANCE	00H - 40H - 7FH (-64 - 0 +63)
01H 63H	mmH —	EG ATTACK TIME	00H - 40H - 7FH (-64 - 0 +63)
01H 64H	mmH —	EG DECAY TIME	00H - 40H - 7FH (-64 - 0 +63)
01H 66H	mmH —	EG RELEASE	00H - 40H - 7FH (-64 - 0 +63)
14H rrH	mmH —	DRUM FILTER CUTOFF FREQ.	00H - 40H - 7FH (-64 - 0 +63)
15H rrH	mmH —	DRUM FILTER RESONANCE	00H - 40H - 7FH (-64 - 0 +63)
16H rrH	mmH —	DRUM AEG ATTACK RATE	00H - 40H - 7FH (-64 - 0 +63)
17H rrH	mmH —	DRUM AEG DECAY RATE	00H - 40H - 7FH (-64 - 0 +63)
18H rrH	mmH —	DRUM PITCH COARSE	00H - 40H - 7FH (-64 - 0 +63)
19H rrH	mmH —	DRUM PITCH FINE	00H - 40H - 7FH (-64 - 0 +63)
1AH rrH	mmH —	DRUM LEVEL	00H - 7FH (0 - max.)
1CH rrH	mmH —	DRUM PANPOT	00H ,01H - 40H - 7FH (random,left - center - right)
1DH rrH	mmH —	DRUM REVERB SEND LEVEL	00H - 7FH (0 - max.)
1EH rrH	mmH —	DRUM CHORUS SEND LEVEL	00H - 7FH (0 - max.)
1FH rrH	mmH —	DRUM VARIATION SEND LEVEL	00H - 7FH (0 - max.)

The MSG14H-1FH (for drums) message is accepted as long as the channel is set with a drum voice.

rrH : drum instrument note number

(3-5) SYSTEM REALTIME MESSAGES

(3-5-1) MIDI CLOCK

STATUS 11111000 (F8H)

Transmission: 96 clocks per measure are transmitted.

Reception: If the instrument's clock is set to external, after FAH is received from the external device the instrument's clock will sync with the 96 beats per measure received from the external device.

Decides whether the internal clock, or Timing Clocks received via the MIDI IN will be used.

(3-5-2) START

STATUS 11111010 (FAH)

Transmission: Transmitted when instrument's Rhythm or Song playback is started.

Reception: Depending upon the condition, Rhythm, Song Playback, or Song Rec will start.

(3-5-3) STOP

STATUS 11111100 (FCH)

Transmission: Transmitted when instrument's Rhythm or Song playback is stopped.

Reception: Depending upon the condition, Rhythm, Song Playback, or Song Rec will stop.

(3-5-4) ACTIVE SENSING

STATUS 11111110 (FEH)

Transmission: Transmitted approximately once every 200msec.

Reception: Sensing is started once this Code is received. If Status or Data is not received within 400ms, the MIDI Receive Buffer will be cleared, and all notes, including those being sustained, will be cut OFF. Also, all control values will be reset to their factory defaults.

(3-6) SYSTEM EXCLUSIVE MESSAGE

(3-6-1) YAMAHA MIDI FORMAT

(3-6-1-1) SECTION CONTROL

binary	hexadecimal	
11110000	F0	Exclusive status
01000011	43	YAMAHA ID
01111110	7E	Style
00000000	00	
0sssssss	SS	Switch No.
		00H : INTRO A
		01H~07H : INTRO B
		08H : MAIN A
		09H~0FH : MAIN B
		10H : FILL IN AA
		11H~17H : FILL IN BB
		18H : FILL IN AB
		19H~1FH : FILL IN BA
		20H : ENDING A
		21H~27H : ENDING B
0ddddd	DD	Switch On/Off: 00H(Off),7FH(On)
11110111	F7	End of Exclusive

When an ON code is received, the appointed section will be changed.

(3-6-1-2) TEMPO CONTROL

binary	hexadecimal	
11110000	F0	Exclusive status
01000011	43	YAMAHA ID
01111110	7E	Style
00000000	01	
0ttttt	TT	Tempo4
0ttttt	TT	Tempo3
0ttttt	TT	Tempo2
0ttttt	TT	Tempo1
11110111	F7	End of Exclusive

The internal clock will be set to the received Tempo value.

Tempo Meta Event is a large data block (24-bit), it is divided into 4 groups with 7-bits going into each of the Tempos 1-4 (4 receives the remaining 3 bits).

(3-6-2) UNIVERSAL SYSTEM EXCLUSIVE

(3-6-2-1) UNIVERSAL REALTIME MESSAGE

(3-6-2-1-1) MIDI MASTER VOLUME (Recive only)

binary	hexadecimal	
11110000	F0	Exclusive status
01111110	7F	Universal Realtime
01111111	7F	ID of target Device
00001001	04	Sub-ID #1=Device Control Message
00000001	01	Sub-ID #2=Master Volume
0sssssss	SS	Volume LSB
0ttttt	TT	Volume MSB
11110111	F7	End of Exclusive
or		
11110000	F0	Exclusive status
01111110	7F	Universal Realtime
0xxxxxxx	XN	When N is received N=0-F, whichever is received. When N is transmitted N always=0. X = don't care
00001001	04	Sub-ID #1=Device Control Message
00000001	01	Sub-ID #2=Master Volume
0sssssss	SS	Volume LSB
0ttttt	TT	Volume MSB
11110111	F7	End of Exclusive

The volume for all channels will be changed simultaneously.

The TT value is used as the MIDI Master Volume value. (the ss value is ignored.)

(3-6-2-2) UNIVERSAL NON REALTIME MESSAGE

(3-6-2-2-1) GENERAL MIDI SYSTEM ON

binary	hexadecimal	
11110000	F0	Exclusive status
01111110	7E	Universal Non-Realtime
01111111	7F	ID of target Device
00001001	09	Sub-ID #1=General MIDI Message
00000001	01	Sub-ID #2=General MIDI On
11110111	F7	End of Exclusive
or		

11110000	F0	Exclusive status
01111110	7E	Universal Non-Realtime
0xxxxxxx	XN	When N is received N=0-F, whichever is received. When N is transmitted N always=0. X = don't care
00001001	09	Sub-ID #1=General MIDI Message
00000001	01	Sub-ID #2=General MIDI On
11110111	F7	End of Exclusive

Depending upon the received ON message, the System Mode will be changed to XG.

Except MIDI Master Tuning, all control data be reset to default values.

This message requires approximately 50ms to execute, so sufficient time should be allowed before the next message is sent.

(3-6-3) XG STANDARD

(3-6-3-1) XG PARAMETER CHANGE

(3-6-3-1-1) XG SYSTEM ON

binary	hexadecimal	
11110000	F0	Exclusive status
01000011	43	YAMAHA ID
0001nnnn	1N	Device Number
01001100	4C	Model ID
00000000	00	Address High
00000000	00	Address Mid
01111110	7E	Address Low
00000000	00	Data
11110111	F7	End of Exclusive

Depending upon the received ON message, the SYSTEM MODE will be changed to XG. Controllers will be reset, all values of Multi Part and Effect, and All System values denoted by "XG" data within All System will be reset to default values in the table.

This message requires approximately 50ms to execute, so sufficient time should be allowed before the next message is sent.

(3-6-3-1-2) XG PARAMETER CHANGE

binary	hexadecimal	
11110000	F0	Exclusive status
01000011	43	YAMAHA ID
0001nnnn	1N	Device Number
01001100	4C	Model ID
0aaaaaaa	AA	Address High
0aaaaaaa	AA	Address Mid
0aaaaaaa	AA	Address Low
0ddddd	DD	Data
11110111	F7	End of Exclusive

For parameters with data size of 2 or 4, transmit the appropriate number of data bytes.

For more information on Address and Parameters, refer to < Table 1-2 > (page 14) and < Table 1-4 > ~ < Table 1-8 > (pages 15-19).

The 4 data types listed below are transmitted and received.

(These are transmitted only after a Parameter change request is received.)

XG System Data
Multi Effect Data
Multi EQ Data
Multi Part Data
Drums Setup Data

(3-6-3-2) XG BULK DUMP

binary	hexadecimal	
11110000	F0	Exclusive status
01000011	43	YAMAHA ID
0000nnnn	0N	Device Number
01001100	4C	Model ID
0bbbbbbb	BB	ByteCount
0bbbbbbb	BB	ByteCount
0aaaaaaa	AA	Address High
0aaaaaaa	AA	Address Mid
0aaaaaaa	AA	Address Low
0ddddd	DD	Data
0ccccccc	CC	Check sum
11110111	F7	End of Exclusive

For more information on Address and Byte Count, refer to < Table 1-2 > ~ < Table 1-8 > (pages 14-19).

The Check Sum value is set such that the sum of Byte Count, Address, Data, and Check Sum has value zero in its seven least significant bits.

If the top of the block is appointed to the Address the XG Bulk Dump, Bulk Request will be received.

The Block is a unit that consists of the data, arranged in the list, as the Total Size.

The 5 data types listed below are transmitted and received.
(These are transmitted only after a Bulk Dump request is received.)

System Data
Multi Effect Data(Individual effect unit)
Multi EQ Data
Multi Part Data(Individual part unit)
Drums Setup Data(Individual note unit)
System Information(Individual only)

(3-6-3-3) XG PARAMETER REQUEST (Recv only)

binary	hexadecimal	
11110000	F0	Exclusive status
01000011	43	YAMAHA ID
0011nnnn	3n	Device Number
01001100	4C	Model ID
0aaaaaaa	AA	Address High
0aaaaaaa	AA	Address Mid
0aaaaaaa	AA	Address Low
11110111	F7	End of Exclusive

For more information on Address and Byte Count refer to < Table 1-2 > (page 14) and < Table 1-4 > ~ < Table 1-8 > (pages 15-19).

The 4 data types listed below are received.

System Data
Multi Effect Data
Multi EQ Data
Multi Part Data
Drums Setup Data

(3-6-3-4) XG DUMP REQUEST (Recv only)

binary	hexadecimal	
11110000	F0	Exclusive status
01000011	43	YAMAHA ID
0010nnnn	2n	Device Number
01001100	4C	Model ID
0aaaaaaa	AA	Address High
0aaaaaaa	AA	Address Mid
0aaaaaaa	AA	Address Low
11110111	F7	End of Exclusive

For more information on Address and Byte Count refer to < Table 1-2 > ~ < Table 1-8 > (pages 14-19).

The 5 data types listed below are received.

System Data
Multi Effect Data(Individual module unit)
Multi EQ Data
Multi Part Data(Individual part unit)
Drums Setup Data(Individual note unit)
System Information

(3-6-4) CLAVINOVA MIDI COMPLIANCE

(3-6-4-1) INTERNAL CLOCK / EXTERNAL CLOCK (Recv only)

binary	hexadecimal	
11110000	F0	Exclusive status
01000011	43	YAMAHA ID
01110011	73	Clavinova ID
00000001	01	Clavinova common ID
0000001n	0N	N: 2(Internal Clock),3(External Clock)
11110111	F7	End of Exclusive

(3-6-4-2) DOC MULTI TIMBRE ON / OFF (Recv only)

binary	hexadecimal	
11110000	F0	Exclusive status
01000011	43	YAMAHA ID
01110011	73	Clavinova ID
00000001	01	Clavinova common ID
00000110	1N	N: 3(DOC Multi Timbre Off),4(DOC Multi Timbre On)
11110111	F7	End of Exclusive

(3-6-4-3) PANEL LED ON / OFF (Recv only)

binary	hexadecimal	
11110000	F0	Exclusive status
01000011	43	YAMAHA ID
01110011	73	Clavinova ID
01000101	45	CVP-98/96/600/94/92
00011010	1A	PANEL LED On/Off
0mmmmmmm	MM	MM: 00H(LED Off),01H(LED On),02H(The LED flashes) 03H (LED All off), 04H (Panel LED returns to normal operation)
00000000	00	
0nnnnnnn	NN	LED No.
11110111	F7	End of Exclusive

Remotely switches the Panel LED On/Off.

(3-6-4-4) STYLE NUMBER

binary	hexadecimal	
11110000	F0	Exclusive status
01000011	43	YAMAHA ID
01110011	73	Clavinova ID
01000101	45	CVP-98/96/600/94/92
00011101	1D	Style No.
00000000	00	
0ccccccc	CC	Style No. MSB
0ddddddd	DD	Style No. LSB
11110111	F7	End of Exclusive

(3-6-4-5) MIDI FA CANCEL (Recv only)

binary	hexadecimal	
11110000	F0	Exclusive status
01000011	43	YAMAHA ID
01110011	73	Clavinova ID
01000101	01	Clavinova common ID
01100001	61	MIDI FA Cancel
11110111	F7	End of Exclusive

If this message is received, even if FAH is received the Rhythm will not start.

(3-6-5) SPECIAL OPERATORS

(3-6-5-1) SPLIT POINT

binary	hexadecimal	
11110000	F0	Exclusive status
01000011	43	YAMAHA ID
01110011	73	Clavinova ID
01000101	01	Clavinova common ID
00010001	11	Sub ID
00000000	00	
00010100	14	Split Point
0ddddddd	DD	Split Key No.
11110111	F7	End of Exclusive

(3-6-5-2) FINGERING

binary	hexadecimal	
11110000	F0	Exclusive status
01000011	43	YAMAHA ID
01110011	73	Clavinova ID
01000101	01	Clavinova common ID
00010001	11	Sub ID
00000000	00	
01000000	40	Fingering
0000dddd	0D	0D: 00H(Off),01H(Single Finger),02H(Fingered), 04H(Full Keyboard),07H(Multi Finger)
11110111	F7	End of Exclusive

(3-6-5-3) ACCOMP VOLUME

binary	hexadecimal	
11110000	F0	Exclusive status
01000011	43	YAMAHA ID
01110011	73	Clavinova ID
01000101	01	Clavinova common ID
00010001	11	Sub ID
0000nnnn	0N	Part: 00H(All Part),05H(Rhythm),0AH(Bass), 06H(Chord),0DH(Pad),07H(Phrase)
01000000	42	Accomp Volume
0ddddddd	DD	Volume Data: 00H~7FH
11110111	F7	End of Exclusive

(3-6-5-4) CHANNEL DETUNE

binary	hexadecimal	
11110000	F0	Exclusive status
01000011	43	YAMAHA ID
01110011	73	Clavinova ID
01000101	45	CVP-98/96/600/94/92 ID
00010001	11	Sub ID
0000nnnn	0N	N = MIDI Channel
01000011	43	Dual Detune
0vvvvvvv	VV	Value VV: 00H - 40H - 7FH (-64 - 0 - +63)
11110111	F7	End of Exclusive

The Channel Detune message only affects the specified channel.

MIDI Data Format / MIDI-Datenformat / Format des données MIDI / Formato de datos MIDI

(3-6-5-5) VOLUME ,EXPRESSION AND PAN REALTIME CONTROL OFF

binary	hexadecimal	
11110000	F0	Exclusive status
01000011	43	YAMAHA ID
01110011	73	Clavinova ID
01000101	45	CVP-98/96/600/94/92 ID
00010001	11	Sub ID
0000nnnn	0N	N = MIDI Channel
01001001	45	Volume and Expression Realtime Control Off
0vvvvvvv	VV	Value VV: off=7FH, on=00H
11110111	F7	End of Exclusive

When "On" is received, subsequent volume, expression, and PAN changes are only valid after the reception of the next key on. Normal operation resumes when "Off" is received.

(3-6-5-6) MIDI KEY LED MODE ON / OFF (Recive only)

binary	hexadecimal	
11110000	F0	Exclusive status
01000011	43	YAMAHA ID
01110011	73	Clavinova ID
01000101	01	Sub ID
00010001	11	Sub ID
0000nnnn	0N	N = MIDI Channel
01000111	47	MIDI Key LED Mode On / Off
0ddddd	DD	DD: 00H(Key LED Mode Off),01H(Key LED Mode On + no tone), 02H(Key LED Mode On + tone)
11110111	F7	End of Exclusive

(3-6-6) Others

(3-6-6-1) MIDI MASTER TUNING (Recive only)

binary	hexadecimal	
11110000	F0	Exclusive status
01000011	43	YAMAHA ID
0001nnnn	1N	When N is received N=0-F, whichever is received.
00100111	27	Model ID
00110000	30	Sub ID
00000000	00	
00000000	00	
0mmmmmmm	MM	Master Tune MSB
0lllllll	LL	Master Tune LSB
0ccccccc	CC	don't care
11110111	F7	End of Exclusive

Changes tuning of all channels.

MM, LL values are used to define the MIDI Master Tuning value.

T = M-128

T : Tuning value (-99cent - +99cent)

M : A single byte value (28-228) consists of bytes 0-3 of MM = MSB, bytes 0-3 of LL = LSB.

In this setting, GM System ON, XG System ON will not be reset.

< Table 1-1 >

Parameter Basic Address

Parameter	Parameter Change Address			Description	
	(H)	(M)	(L)		
SYSTEM	00	00	00	System	
	00	00	7D	Drum Setup Reset	
	00	00	7E	XG System On	
	00	00	7F	All Parameter Reset	
INFORMATION	01	00	00	System Information	
EFFECT 1	02	01	00	Effect1(Reverb,Chorus,Variation)	
MULTI PART	08	00	00	Multi Part 1	
	:	:	:	:	
	08	0F	00	Multi Part 16	
	08	10	00	Reserved	
:	:	:	:	:	
DRUM	30	0D	00	Drum Setup 1	
	31	0D	00	Drum Setup 2	
	3n	0D	00	note number 13	
	3n	0E	00	note number 14	
	:	:	:	:	:
	3n	5B	00	note number 91	
	3F	nn	nn	Reserved	

< Table 1-2 >

MIDI Parameter Change table (SYSTEM)

Address (H)	Size (H)	Data (H)	Parameter Name (H)	Description	Default	Value(H)
00	00	00	0000	Master Tune	-102.4..+102.3[cent]	00 04 00 00
		01	..07FF		1st bit3-0 -> bit15-12	(0400)
		02			2nd bit3-0 -> bit11-8	(With XG, GM On, it will not reset.)
		03			3rd bit3-0 -> bit7-4	
					4th bit3-0 -> bit3-0	
	04	1	00..7F	Master Volume	0..127	7F
	05	1		Not Used		
	06	1	28..58	Transpose	-24..+24[semitones]	40
	7D	n		Drum Setup Reset	n=Drum Setup Number	
	7E	00		XG System On	00=XG System on	
	7F	00		All Parameter Reset	00=on (receive only)	
TOTAL SIZE 6						

< Table 1-3 >

MIDI Parameter table (System information)

Address (H)	Size	Data (H)	Parameter Name (H)	Description
01	00	E	20..7F	Model Name
		:		32..127(ASCII)
		0D		
		0E	1 00	
		0F	1 00	

TOTAL SIZE 10

(Transmitted by Dump Request. Not received. Bulk Dump Only)

< Table 1-4 >

MIDI Parameter Change table (EFFECT 1)

Address (H)	Size	Data (H)	Parameter Name (H)	Description	Default	Value(H)	
02	01	00	2	00..7F	Reverb Type MSB	Refer to the Effect Type List	01(=HALL1)
				00..7F	Reverb Type LSB	00 : basic type	00
		02	1	00..7F	Reverb Parameter 1	Refer to the Ef. Parameter List	Depend on Reverb type
		03	1	00..7F	Reverb Parameter 2	Refer to the Ef. Parameter List	Depend on Reverb type
		04	1	00..7F	Reverb Parameter 3	Refer to the Ef. Parameter List	Depend on Reverb type
		05	1	00..7F	Reverb Parameter 4	Refer to the Ef. Parameter List	Depend on Reverb type
		06	1	00..7F	Reverb Parameter 5	Refer to the Ef. Parameter List	Depend on Reverb type
		07	1	00..7F	Reverb Parameter 6	Refer to the Ef. Parameter List	Depend on Reverb type
		08	1	00..7F	Reverb Parameter 7	Refer to the Ef. Parameter List	Depend on Reverb type
		09	1	00..7F	Reverb Parameter 8	Refer to the Ef. Parameter List	Depend on Reverb type
		0A	1	00..7F	Reverb Parameter 9	Refer to the Ef. Parameter List	Depend on Reverb type
		0B	1	00..7F	Reverb Parameter 10	Refer to the Ef. Parameter List	Depend on Reverb type
		0C	1	00..7F	Reverb Return	-∞..0..+6dB(0..96..127)	60
		0D	1	01..7F	Reverb Pan	L63..C..R63(1..64..127)	40

TOTAL SIZE 0E

02	01	10	1	00..7F	Reverb Parameter 11	Refer to the Ef. Parameter List	Depend on Reverb type
		11	1	00..7F	Reverb Parameter 12	Refer to the Ef. Parameter List	Depend on Reverb type
		12	1	00..7F	Reverb Parameter 13	Refer to the Ef. Parameter List	Depend on Reverb type
		13	1	00..7F	Reverb Parameter 14	Refer to the Ef. Parameter List	Depend on Reverb type
		14	1	00..7F	Reverb Parameter 15	Refer to the Ef. Parameter List	Depend on Reverb type
		15	1	00..7F	Reverb Parameter 16	Refer to the Ef. Parameter List	Depend on Reverb type

TOTAL SIZE 6

02	01	20	2	00..7F	Chorus Type MSB	Refer to the Effect Type List	41(=Chorus1)
				00..7F	Chorus Type LSB	00 : basic type	00
		22	1	00..7F	Chorus Parameter 1	Refer to the Ef. Parameter List	Depend on Chorus Type
		23	1	00..7F	Chorus Parameter 2	Refer to the Ef. Parameter List	Depend on Chorus Type
		24	1	00..7F	Chorus Parameter 3	Refer to the Ef. Parameter List	Depend on Chorus Type
		25	1	00..7F	Chorus Parameter 4	Refer to the Ef. Parameter List	Depend on Chorus Type
		26	1	00..7F	Chorus Parameter 5	Refer to the Ef. Parameter List	Depend on Chorus Type
		27	1	00..7F	Chorus Parameter 6	Refer to the Ef. Parameter List	Depend on Chorus Type
		28	1	00..7F	Chorus Parameter 7	Refer to the Ef. Parameter List	Depend on Chorus Type
		29	1	00..7F	Chorus Parameter 8	Refer to the Ef. Parameter List	Depend on Chorus Type
		2A	1	00..7F	Chorus Parameter 9	Refer to the Ef. Parameter List	Depend on Chorus Type
		2B	1	00..7F	Chorus Parameter 10	Refer to the Ef. Parameter List	Depend on Chorus Type
		2C	1	00..7F	Chorus Return	-∞..0..+6dB(0..96..127)	60
		2D	1	01..7F	Chorus Pan	L63..C..R63(1..64..127)	40
		2E	1	00..7F	Send Chorus To Reverb	-∞..0..+6dB(0..96..127)	00

TOTAL SIZE 0F

02	01	30	1	00..7F	Chorus Parameter 11	Refer to the Ef. Parameter List	Depend on Chorus Type
		31	1	00..7F	Chorus Parameter 12	Refer to the Ef. Parameter List	Depend on Chorus Type
		32	1	00..7F	Chorus Parameter 13	Refer to the Ef. Parameter List	Depend on Chorus Type
		33	1	00..7F	Chorus Parameter 14	Refer to the Ef. Parameter List	Depend on Chorus Type
		34	1	00..7F	Chorus Parameter 15	Refer to the Ef. Parameter List	Depend on Chorus Type
		35	1	00..7F	Chorus Parameter 16	Refer to the Ef. Parameter List	Depend on Chorus Type

TOTAL SIZE 6

02	01	40	2	00..7F	Variation Type MSB	Refer to the Effect Type List	"05(=DELAY L,C,R)"
				00..7F	Variation Type LSB	00 : basic type	00
		42	2	00..7F	Vari. Param. 1 MSB	Refer to the Ef. Parameter List	Depend on Vari. Type
				00..7F	Vari. Param. 1 LSB	Refer to the Ef. Parameter List	Depend on Vari. Type
		44	2	00..7F	Vari. Param. 2 MSB	Refer to the Ef. Parameter List	Depend on Vari. Type
				00..7F	Vari. Param. 2 LSB	Refer to the Ef. Parameter List	Depend on Vari. Type
		46	2	00..7F	Vari. Param. 3 MSB	Refer to the Ef. Parameter List	Depend on Vari. Type
				00..7F	Vari. Param. 3 LSB	Refer to the Ef. Parameter List	Depend on Vari. Type
		48	2	00..7F	Vari. Param. 4 MSB	Refer to the Ef. Parameter List	Depend on Vari. Type
				00..7F	Vari. Param. 4 LSB	Refer to the Ef. Parameter List	Depend on Vari. Type

MIDI Data Format / MIDI-Datenformat / Format des données MIDI / Formato de datos MIDI

4A	2	00..7F	Vari. Param. 5 MSB	Refer to the Ef. Parameter List	Depend on Vari. Type		
		00..7F	Vari. Param. 5 LSB	Refer to the Ef. Parameter List	Depend on Vari. Type		
4C	2	00..7F	Vari. Param. 6 MSB	Refer to the Ef. Parameter List	Depend on Vari. Type		
		00..7F	Vari. Param. 6 LSB	Refer to the Ef. Parameter List	Depend on Vari. Type		
4E	2	00..7F	Vari. Param. 7 MSB	Refer to the Ef. Parameter List	Depend on Vari. Type		
		00..7F	Vari. Param. 7 LSB	Refer to the Ef. Parameter List	Depend on Vari. Type		
50	2	00..7F	Vari. Param. 8 MSB	Refer to the Ef. Parameter List	Depend on Vari. Type		
		00..7F	Vari. Param. 8 LSB	Refer to the Ef. Parameter List	Depend on Vari. Type		
52	2	00..7F	Vari. Param. 9 MSB	Refer to the Ef. Parameter List	Depend on Vari. Type		
		00..7F	Vari. Param. 9 LSB	Refer to the Ef. Parameter List	Depend on Vari. Type		
54	2	00..7F	Vari. Param. 10 MSB	Refer to the Ef. Parameter List	Depend on Vari. Type		
		00..7F	Vari. Param. 10 LSB	Refer to the Ef. Parameter List	Depend on Vari. Type		
56	1	00..7F	Variation Return	-∞..0..+6dB(0..96..127)	60		
57	1	01..7F	Variation Pan	L63..C..R63(1..64..127)	40		
58	1	00..7F	Send Vari. To Reverb	-∞..0..+6dB(0..96..127)	00		
59	1	00..7F	Send Vari. To Chorus	-∞..0..+6dB(0..96..127)	00		
5A	1	00..01	Variation Connection	0:insertion,1:system	00		
5B	1	00..1F	Variation Part	part1..32(0..31),off(127)	7F		
5C	1	01..7F	MW Vari. Ctrl Depth	-63..+63	40		
5D	1	01..7F	PB Vari. Ctrl Depth	-63..+63	40		
5E	1	01..7F	CAT Vari. Ctrl Depth	-63..+63	40		
5F	1	01..7F	Not Used				
60	1	01..7F	Not Used				
TOTAL SIZE 21							
02	01	70	1	00..7F	Variation Parameter 11	option Parameter	Depend on Variation Type
		71	1	00..7F	Variation Parameter 12	option Parameter	Depend on Variation Type
		72	1	00..7F	Variation Parameter 13	option Parameter	Depend on Variation Type
		73	1	00..7F	Variation Parameter 14	option Parameter	Depend on Variation Type
		74	1	00..7F	Variation Parameter 15	option Parameter	Depend on Variation Type
		75	1	00..7F	Variation Parameter 16	option Parameter	Depend on Variation Type
TOTAL SIZE 6							

< Table 1-5 >

MIDI Parameter Change table (MULTI EQ)

Address (H)	Size (H)	Data (H)	Parameter Name (H)	Description	Default	Value(H)	
02	40	00	1	34..4C	EQ Type	0:FLAT	0
					1:JAZZ		
					2:POPS		
					3:ROCK		
					4:CLASSIC		
		01	1	34..4C	EQ Gain1	-12..+12[dB]	40
		02	1	04..28	EQ Frequency1	32..2000[Hz]	0C
		03	1	01..78	EQ Q1	0.1..12.0	07
		04	1	00..01	EQ Shape1	00:Shelving,01:Peaking	00
		05	1	34..4C	EQ Gain2	-12..+12[dB]	40
		06	1	0E..36	EQ Frequency2	0.1..10[KHz]	1C
		07	1	01..78	EQ Q2	0.1..12.0	07
		08	1		Not Used		
		09	1	34..4C	EQ Gain3	-12..+12[dB]	40
		0A	1	0E..36	EQ Frequency3	0.1..10[KHz]	22
		0B	1	01..78	EQ Q3	0.1..12.0	07
		0C	1		Not Used		
		0D	1	34..4C	EQ Gain4	-12..+12[dB]	40
		0E	1	0E..36	EQ Frequency4	0.1..10[KHz]	2E
		0F	1	01..78	EQ Q4	0.1..12.0	07
		10	1		Not Used		
		11	1	34..4C	EQ Gain5	-12..+12[dB]	40
		12	1	1C..3A	EQ Frequency5	0.5..16.0[KHz]	3C
		13	1	01..78	EQ Q5	0.1..12.0	07
		14	1	00..01	EQ Shape5	00:Shelving,01:Peaking	00
TOTAL SIZE 15							

< Table 1-6 >

MIDI Parameter Change table (EFFECT 2)

Address (H)	Size (H)	Data (H)	Parameter Name (H)	Description	Default	Value(H)	
03	00	00	2	00..7F	Insertion Type MSB	Refer to the Ef. Type List	"49(=DISTORTION)"
				00..7F	Insertion Type LSB	00 : basic type	00
		02	1	00..7F	Insertion Parameter1	Refer to the Ef. Parameter List	Depend on Ins. Type
		03	1	00..7F	Insertion Parameter2	Refer to the Ef. Parameter List	Depend on Ins. Type
		04	1	00..7F	Insertion Parameter3	Refer to the Ef. Parameter List	Depend on Ins. Type

05	1	00..7F	Insertion Parameter4	Refer to the Ef. Parameter List	Depend on Ins. Type
06	1	00..7F	Insertion Parameter5	Refer to the Ef. Parameter List	Depend on Ins. Type
07	1	00..7F	Insertion Parameter6	Refer to the Ef. Parameter List	Depend on Ins. Type
08	1	00..7F	Insertion Parameter7	Refer to the Ef. Parameter List	Depend on Ins. Type
09	1	00..7F	Insertion Parameter8	Refer to the Ef. Parameter List	Depend on Ins. Type
0A	1	00..7F	Insertion Parameter9	Refer to the Ef. Parameter List	Depend on Ins. Type
0B	1	00..7F	Insertion Parameter10	Refer to the Ef. Parameter List	Depend on Ins. Type
0C	1	00..7F	Insertion Part	Part1..16,OFF	7F
0D	1	00..7F	MW INS CTRL DPT		
0E	1	00..7F	BEND INS CTRL DPT		
0F	1	00..7F	CAT INS CTRL DPT		
10	1	00..7F	Not Used		
11	1	00..7F	Not Used		

TOTAL SIZE 12

03	00	20	1	00..7F	Insertion Parameter11	Refer to the Ef. Parameter List	Depend on Ins. Type
		21	1	00..7F	Insertion Parameter12	Refer to the Ef. Parameter List	Depend on Ins. Type
		22	1	00..7F	Insertion Parameter13	Refer to the Ef. Parameter List	Depend on Ins. Type
		23	1	00..7F	Insertion Parameter14	Refer to the Ef. Parameter List	Depend on Ins. Type
		24	1	00..7F	Insertion Parameter15	Refer to the Ef. Parameter List	Depend on Ins. Type
		25	1	00..7F	Insertion Parameter16	Refer to the Ef. Parameter List	Depend on Ins. Type

TOTAL SIZE 06

03	00	30	2	00..7F	Ins. Param.1 MSB	Refer to the Ef. Parameter List	Depend on Ins. Type
				00..7F	Ins. Param.1 LSB	Refer to the Ef. Parameter List	Depend on Ins. Type
03	00	32	2	00..7F	Ins. Param.2 MSB	Refer to the Ef. Parameter List	Depend on Ins. Type
				00..7F	Ins. Param.2 LSB	Refer to the Ef. Parameter List	Depend on Ins. Type
03	00	34	2	00..7F	Ins. Param.3 MSB	Refer to the Ef. Parameter List	Depend on Ins. Type
				00..7F	Ins. Param.3 LSB	Refer to the Ef. Parameter List	Depend on Ins. Type
03	00	36	2	00..7F	Ins. Param.4 MSB	Refer to the Ef. Parameter List	Depend on Ins. Type
				00..7F	Ins. Param.4 LSB	Refer to the Ef. Parameter List	Depend on Ins. Type
03	00	38	2	00..7F	Ins. Param.5 MSB	Refer to the Ef. Parameter List	Depend on Ins. Type
				00..7F	Ins. Param.5 LSB	Refer to the Ef. Parameter List	Depend on Ins. Type
03	00	3A	2	00..7F	Ins. Param.6 MSB	Refer to the Ef. Parameter List	Depend on Ins. Type
				00..7F	Ins. Param.6 LSB	Refer to the Ef. Parameter List	Depend on Ins. Type
03	00	3C	2	00..7F	Ins. Param.7 MSB	Refer to the Ef. Parameter List	Depend on Ins. Type
				00..7F	Ins. Param.7 LSB	Refer to the Ef. Parameter List	Depend on Ins. Type
03	00	3E	2	00..7F	Ins. Param.8 MSB	Refer to the Ef. Parameter List	Depend on Ins. Type
				00..7F	Ins. Param.8 LSB	Refer to the Ef. Parameter List	Depend on Ins. Type
03	00	40	2	00..7F	Ins. Param.9 MSB	Refer to the Ef. Parameter List	Depend on Ins. Type
				00..7F	Ins. Param.9 LSB	Refer to the Ef. Parameter List	Depend on Ins. Type
03	00	42	2	00..7F	Ins. Param.10 MSB	Refer to the Ef. Parameter List	Depend on Ins. Type
				00..7F	Ins. Param.10 LSB	Refer to the Ef. Parameter List	Depend on Ins. Type

TOTAL SIZE 14

For effect types that do not require MSB, the Parameters for Address 02-0B will be received. Address 30-42 will not be received.

For effect types that require MSB, the Parameters for Address 30-42 will be received. Address 02-0B will not be received.

When Bulk Dumps that include Effect Type data are transmitted, the Parameters for Address 02 - 0B will always be transmitted. But, effects that require MSB, when the bulk dump is received the Parameters for Address 02 - 0B will not be received.

< Table 1-7 >

MIDI Parameter Change table (MULTI PART)

Address (H)	Size	Data (H)	Parameter Name (H)	Description	Default	Value(H)	
08	nn	00	1	00..20	Element Reserve	0..32	0(Part10),2(Others)
	nn	01	1	00..7F	Bank Select MSB	0..127	7F(Part10),00(Others)
	nn	02	1	00..7F	Bank Select LSB	0..127	00
	nn	03	1	00..7F	Program Number	1..128	00
	nn	04	1	00..0F, 7F	Rcv Channel	0..16;1..16,127;off	Part No.
	nn	05	1	00..01	Mono/Poly Mode	0:mono,1:poly	01
	nn	06	1	00..02	Same Note Number	0:single	00
				Key On Assign	1:multi		
					2:inst (for DRUM)		
	nn	07	1	00..02	Part Mode	0:normal	00 (Except Part10)
					1..3:drum thru,drum1..2		01 (Part10)
	nn	08	1	28..58	Note Shift	-24..+24[semitones]	40
	nn	09	2	00..FF	Detune	-12.8..+12.7[Hz]	08 00
	nn	0A				1st bit3..0 -> bit7..4	(80)
						2nd bit3..0 -> bit3..0	
	nn	0B	1	00..7F	Volume	0..127	64
	nn	0C	1	00..7F	Velocity Sense Depth	0..127	40
	nn	0D	1	00..7F	Velocity Sense Offset	0..127	40
	nn	0E	1	00..7F	Pan	0:random	40
					L63..C..R63(1..64..127)		

MIDI Data Format / MIDI-Datenformat / Format des données MIDI / Formato de datos MIDI ●●

nn	0F	1	00..7F	Note Limit Low	C-2..G8	00
nn	10	1	00..7F	Note Limit High	C-2..G8	7F
nn	11	1	00..7F	Dry Level	0..127	7F
nn	12	1	00..7F	Chorus Send	0..127	00
nn	13	1	00..7F	Reverb Send	0..127	28
nn	14	1	00..7F	Variation Send	0..127	00
nn	15	1	00..7F	Vibrato Rate	-64..+63	40
nn	16	1	00..7F	Vibrato Depth	-64..+63	40
nn	17	1	00..7F	Vibrato Delay	-64..+63	40
nn	18	1	00..7F	Filter Cutoff Freq.	-64..+63	40
nn	19	1	00..7F	Filter Resonance	-64..+63	40
nn	1A	1	00..7F	EG Attack Time	-64..+63	40
nn	1B	1	00..7F	EG Decay Time	-64..+63	40
nn	1C	1	00..7F	EG Release Time	-64..+63	40
nn	1D	1	28..58	MW Pitch Control	-24..+24[semitones]	40
nn	1E	1	00..7F	MW Filter Control	-9600..+9450[cent]	40
nn	1F	1	00..7F	MW Amp. Control	-100..+100[%]	40
nn	20	1	00..7F	MW LFO PMod Depth	0..127	0A
nn	21	1	00..7F	MW LFO FMod Depth	0..127	00
nn	22	1	00..7F	MW LFO AMod Depth	0..127	00
nn	23	1	28..58	Bend Pitch Control	-24..+24[semitones]	42
nn	24	1	00..7F	Bend Filter Control	-9600..+9450[cent]	40
nn	25	1	00..7F	Bend Amp. Control	-100..+100[%]	40
nn	26	1	00..7F	Bend LFO PMod Depth	0..127	00
nn	27	1	00..7F	Bend LFO FMod Depth	0..127	00
nn	28	1	00..7F	Bend LFO AMod Depth	0..127	00

TOTAL SIZE 29

nn	30			Not Used		
	:			:		
nn	40			Not Used		
nn	41	1	00..7F	Scale Tuning C	-64..+63[cent]	40
nn	42	1	00..7F	Scale Tuning C#	-64..+63[cent]	40
nn	43	1	00..7F	Scale Tuning D	-64..+63[cent]	40
nn	44	1	00..7F	Scale Tuning D#	-64..+63[cent]	40
nn	45	1	00..7F	Scale Tuning E	-64..+63[cent]	40
nn	46	1	00..7F	Scale Tuning F	-64..+63[cent]	40
nn	47	1	00..7F	Scale Tuning F#	-64..+63[cent]	40
nn	48	1	00..7F	Scale Tuning G	-64..+63[cent]	40
nn	49	1	00..7F	Scale Tuning G#	-64..+63[cent]	40
nn	4A	1	00..7F	Scale Tuning A	-64..+63[cent]	40
nn	4B	1	00..7F	Scale Tuning A#	-64..+63[cent]	40
nn	4C	1	00..7F	Scale Tuning B	-64..+63[cent]	40
nn	4D	1	28..58	CAT Pitch Control	-24..+24[semitones]	40
nn	4E	1	00..7F	CAT Filter Control	-9600..+9450[cent]	40
nn	4F	1	00..7F	CAT Amplitude Control	-100..+100[%]	40
nn	50	1	00..7F	CAT LFO PMod Depth	0..127	00
nn	51	1	00..7F	CAT LFO FMod Depth	0..127	00
nn	52	1	00..7F	CAT LFO AMod Depth	0..127	00
nn	53			Not Used		
	:			:		
	66			Not Used		
nn	67	1	00..01	Portamento Switch	off/on	00
nn	68	1	00..7F	Portamento Time	0..127	00
nn	69			Not Used		
	:			:		
	6E			Not Used		

TOTAL SIZE 3F

nn = PartNumber

If there is a Drum Voice assigned to the Part, the following parameters are ineffective.

- Bank Select LSB
- Amp EG
- Portamento
- Soft Pedal
- Mono/Poly
- Scale Tuning

<Table 1-8 >

MIDI Parameter Change table (DRUM SETUP)

Address (H)	Size	Data (H)	Parameter Name (H)	Description	Default	Value(H)	
3n	rr	00	1	00..7F	Pitch Coarse	-64..+63	40
3n	rr	01	1	00..7F	Pitch Fine	-64..+63[cent]	40
3n	rr	02	1	00..7F	Level	0..127	Depend on the Note
3n	rr	03	1	00..7F	Alternate Group	0:off,1..127	Depend on the Note
3n	rr	04	1	00..7F	Pan	0:random L63..C..R63(1..64..127)	Depend on the Note
3n	rr	05	1	00..7F	Reverb Send Level	0..127	Depend on the Note
3n	rr	06	1	00..7F	Chorus Send Level	0..127	Depend on the Note
3n	rr	07	1	00..7F	Variation Send Level	0..127	7F
3n	rr	08	1	00..01	Key Assign	0:single,1:multi	00
3n	rr	09	1	00..01	Rcv Note Off	off/on	Depend on the Note
3n	rr	0A	1	00..01	Rcv Note On	off/on	01
3n	rr	0B	1	00..7F	Filter Cutoff Freq.	-64..63	40
3n	rr	0C	1	00..7F	Filter Resonance	-64..63	40
3n	rr	0D	1	00..7F	EG Attack Rate	-64..63	40
3n	rr	0E	1	00..7F	EG Decay1 Rate	-64..63	40
3n	rr	0F	1	00..7F	EG Decay2 Rate	-64..63	40
TOTAL SIZE 10							

n:Drum Setup Number(0 - 1)

rr:note number(0DH - 54H)

If XG SYSTEM ON and/or GM On message is received, all Drum Setup Parameter will be reset to default values.

According to the Drum Setup Reset message, individual Drum Setup Parameters can be reset to default values.

< Table 1-9 > Effect Type List

	XG ESSENTIAL EFFECT
	Same as LSB=0
	XG OPTION EFFECT

* If the received value does not contain an effect type in the TYPE LSB, The LSB will be directed to TYPE 0.

* Panel Effects are based on the "[Number] Effect Name".

REVERB TYPE

TYPE	TYPE LSB	01	02	03..07	08	09..15	16	17	18	19	20	21..
000	NO EFFECT											
001	[1]HALL1	[2]HALL2					[3]HALL3	[4]HALL4	[5]HALL5			
002	[6]ROOM1	ROOM2	[7]ROOM2				[8]ROOM3	ROOM	ROOM	[9]ROOM4		
003	[10]STAGE1	[11]STAGE2					STAGE	[12]STAGE3				
004	[13]PLATE						PLATE	PLATE				
005..015	NO EFFECT											
016	[14]WHITE ROOM											
017	[15]TUNNEL											
018	CANYON											
019	[16]BASEMENT											
020..127	NO EFFECT											

CHORUS TYPE

TYPE	TYPE LSB	01	02	03..07	08	09..15	16	17	18	19	20	21..
000	NO EFFECT											
001..064	NO EFFECT											
065	CHORUS1	CHORUS2	CHORUS3		CHORUS4							
066	CELESTE1	CELESTE2	CELESTE3		CELESTE4		CELESTE	CELESTE				
067	FLANGER 1	FLANGER2			FLANGER3		FLANGER	FLANGER				
068	SYMPHONIC											
069..071	NO EFFECT											
072	PHASER 1											
073..086	NO EFFECT											
087	ENSEMBLE DETUNE											
088..127	NO EFFECT											

MIDI Data Format / MIDI-Datenformat / Format des données MIDI / Formato de datos MIDI ●●

VARIATION EFFECT TYPE

TYPE	TYPE LSB											
MSB	00	01	02	03..07	08	09..15	16	17	18	19	20	21..
000	NO EFFECT											
001	[1]HALL1	[2]HALL2					[3]HALL3	HALL	HALL			
002	[4]ROOM1	ROOM2	[5]ROOM2				[6]ROOM3	ROOM	ROOM	ROOM		
003	[7]STAGE1	[8]STAGE2					STAGE	[9]STAGE3				
004	PLATE						PLATE	PLATE				
005	DELAY L,C,R						[17]DELAY LCR					
006	[18]DELAY L,R											
007	[19]ECHO											
008	[20]CROSS DELAY											
009	ER1	ER2										
010	GATE REVERB											
011	REVERS GATE											
012..015	NO EFFECT											
016	WHITE ROOM											
017	TUNNEL											
018	CANYON											
019	BASEMENT											
020	KARAOKE 1	KARAOKE 2	KARAOKE 3									
021..063	NO EFFECT											
064	THRU											
065	CHORUS1	CHORUS2	CHORUS		CHORUS							
066	[13]CELESTE	[12]CHORUS3	CELESTE3		[11]CHORUS2		CHORUS	[10]CHORUS1	[22] [23]ROTARY			
067	FLANGER 1	FLANGER			FLANGER		[14]FLANGER	FLANGER				
068	SYMPHONIC						[15]SYMPHONIC					
069	ROTARY SP.						Rotary Sp					
070	TREMOLO						[21]TREMOLO	Rotary Sp				
071	AUTO PAN						[16]AUTO PAN	Rotary Sp	Rotary Sp	Rotary Sp	Tremolo	Gtr Tremolo
072	[24]PHASER				PHASER							
073	DISTORTION	COMP+DISTORTION										
074	OVER DRIVE											
075	AMP SIM.											
076	3BAND EQ						DIST.HARD	DIST.SOFT				
077	2BAND EQ						EQ DISCO	EQ TEL				
078	AUTO WAH	AUTO WAH+DIST	AUTO WAH+OVERDRIVE				[25]WAH					
079	THRU											
080	PITCH CHANGE	PITCH CHANGE2										
081	THRU											
082	TOUCH WAH 1	TOUCH WAH+DIST	TOUCH WAH+OVERDRIVE		TOUCH WAH 2							
083	COMPRESSOR											
084	NOISE GATE											
085	VOICE CANCEL											
086	2WAY ROTARY SP											
087	ENSEMBLE DETUNE											
088	AMBIENCE											
089..127	THRU											

INSERTION EFFECT TYPE

TYPE	TYPE LSB											
MSB	00	01	02	03..07	08	09..15	16	17	18	19	20	21..
000	THRU											
001	HALL 1	HALL 2					HALL	HALL	HALL			
002	ROOM 1	ROOM 2	ROOM 3				ROOM	ROOM	ROOM	ROOM		
003	STAGE 1	STAGE 2					STAGE	STAGE				
004	PLATE						PLATE	PLATE				
005	DELAY L,C,R						Delay LCR					
006	DELAY L,R											
007	ECHO											
008	CROSS DELAY											
009..019	THRU											
020	KARAOKE 1	KARAOKE 2	KARAOKE 3									
021..064	THRU											
065	CHORUS 1	CHORUS 2	CHORUS 3		CHORUS 4							
066	CELESTE 1	CELESTE 2	CELESTE 3		CELESTE 4		CHORUS	CHORUS	Rotary Sp			
067	FLANGER 1	FLANGER 2			FLANGER 3		FLANGER	FLANGER				
068	SYMPHONIC						Symphonic					
069	ROTARY SPEAKER 1						Rotary Sp					
070	TREMOLO						Tremolo	Rotary Sp				
071	AUTO PAN						AutoPan	Rotary Sp	Rotary Sp	Tremolo	Gtr Tremolo	
072	PHASER 1											
073	DISTORTION											
074	OVER DRIVE											
075	AMP SIMULATOR											
076	3BAND EQ						DIST.HARD	DIST.SOFT				
077	2-BAND EQ						EQ DISCO	EQ TEL				
078	AUTO WAH(LFO)						Auto Wah					
079..081	THRU											
082	TOUCH WAH 1				TOUCH WAH 2							
083	COMPRESSOR											
084	NOISE GATE											
085..086	THRU											
087	ENSEMBLE DETUNE											
088..127	THRU											

< Table 1-10 > Effect Parameter List

HALL1,HALL2, ROOM1,ROOM2,ROOM3, STAGE1,STAGE2
PLATE (reverb, variation, insertion block)

No.	Parameter	Value	See Table	Control
1	Reverb Time	0.3-30.0s	0-69	table#4
2	Diffusion	0-10	0-10	
3	Initial Delay	0-63	table#5	
4	HPF Cutoff	Thru-8.0kHz	0-52	table#3
5	LPF Cutoff	1.0k-Thru	34-60	table#3
6				
7				
8				
9				
10	Dry/Wet	D63>W - D=W - D<W63	1-127	●
11	Rev Delay	0-63	table#5	
12	Density	0-4 (reverb, variation block) 0-2 (insertion block)	0-4 0-2	
13	Er/Rev Balance	E63>R - E=R - E<R63	1-127	
14	High Damp	0.1-1.0	1-10	
15	Feedback Level	-63+63	1-127	
16				

WHITE ROOM, TUNNEL, CANYON, BASEMENT (reverb, variation block)

No.	Parameter	Value	See Table	Control
1	Reverb Time	0.3-30.0s	0-69	table#4
2	Diffusion	0-10	0-10	
3	Initial Delay	0-63	table#5	
4	HPF Cutoff	Thru-8.0kHz	0-52	table#3
5	LPF Cutoff	1.0k-Thru	34-60	table#3
6	Width	0.5-10.2m	0-37	table#11
7	Height	0.5-20.2m	0-73	table#11
8	Depth	0.5-30.2m	0-104	table#11
9	Wall Vary	0-30	0-30	
10	Dry/Wet	D63>W - D=W - D<W63	1-127	●
11	Rev Delay	0-63	table#5	
12	Density	0-4	0-4	
13	Er/Rev Balance	E63>R - E=R - E<R63	1-127	
14	High Damp	0.1-1.0	1-10	
15	Feedback Level	-63+63	1-127	
16				

DELAY L,C,R (variation, insertion block)

No.	Parameter	Value	See Table	Control
1	Lch Delay	0.1-1486.0ms (variation block) 0.1-742.9ms (insertion block)	1-14860 1-7429	
2	Rch Delay	0.1-1486.0ms (variation block) 0.1-742.9ms (insertion block)	1-14860 1-7429	
3	Cch Delay	0.1-1486.0ms (variation block) 0.1-742.9ms (insertion block)	1-14860 1-7429	
4	Feedback Delay	0.1-1486.0ms (variation block) 0.1-742.9ms (insertion block)	1-14860 1-7429	
5	Feedback Level	-63+63	1-127	
6	Cch Level	0-127	0-127	
7	High Damp	0.1-1.0	1-10	
8				
9				
10	Dry/Wet	D63>W - D=W - D<W63	1-127	●
11				
12				
13	EQ Low Frequency	32Hz-2.0kHz	4-40	table#3
14	EQ Low Gain	-12+12dB	52-76	
15	EQ High Frequency	500Hz-16.0kHz	28-58	table#3
16	EQ High Gain	-12+12dB	52-76	

DELAY L,R (variation, insertion block)

No.	Parameter	Value	See Table	Control
1	Lch Delay	0.1-1486.0ms (variation block) 0.1-742.9ms (insertion block)	1-14860 1-7429	
2	Rch Delay	0.1-1486.0ms (variation block) 0.1-742.9ms (insertion block)	1-14860 1-7429	
3	Feedback Delay 1	0.1-1486.0ms (variation block) 0.1-742.9ms (insertion block)	1-14860 1-7429	
4	Feedback Delay 2	0.1-1486.0ms (variation block) 0.1-742.9ms (insertion block)	1-14860 1-7429	
5	Feedback Level	-63+63	1-127	
6	High Damp	0.1-1.0	1-10	
7				
8				
9				
10	Dry/Wet	D63>W - D=W - D<W63	1-127	●
11				
12				
13	EQ Low Frequency	32Hz-2.0kHz	4-40	table#3
14	EQ Low Gain	-12+12dB	52-76	
15	EQ High Frequency	500Hz-16.0kHz	28-58	table#3
16	EQ High Gain	-12+12dB	52-76	

ECHO (variation, insertion block)

No.	Parameter	Value	See Table	Control
1	Lch Delay1	0.1-743.0ms (variation block) 0.1-371.4ms (insertion block)	1-7430 1-3714	
2	Lch Feedback Level	-63+63	1-127	
3	Rch Delay1	0.1-743.0ms (variation block) 0.1-371.4ms (insertion block)	1-7430 1-3714	
4	Rch Feedback Level	-63+63	1-127	
5	High Damp	0.1-1.0	1-10	
6	Lch Delay2	0.1-743.0ms (variation block) 0.1-371.4ms (insertion block)	1-7430 1-3714	
7	Rch Delay2	0.1-743.0ms (variation block) 0.1-371.4ms (insertion block)	1-7430 1-3714	
8	Delay2 Level	0-127	0-127	
9				
10	Dry/Wet	D63>W - D=W - D<W63	1-127	●
11				
12				
13	EQ Low Frequency	32Hz-2.0kHz	4-40	table#3
14	EQ Low Gain	-12+12dB	52-76	
15	EQ High Frequency	500Hz-16.0kHz	28-58	table#3
16	EQ High Gain	-12+12dB	52-76	

CROSS DELAY (variation, insertion block)

No.	Parameter	Value	See Table	Control
1	L->R Delay	0.1-743.0ms (variation block) 0.1-371.4ms (insertion block)	1-7430 1-3714	
2	R->L Delay	0.1-743.0ms (variation block) 0.1-371.4ms (insertion block)	1-7430 1-3714	
3	Feedback Level	-63+63	1-127	
4	Input Select	L,R,L&R	0-2	
5	High Damp	0.1-1.0	1-10	
6				
7				
8				
9	Dry/Wet	D63>W - D=W - D<W63	1-127	●
10				
11				
12				
13	EQ Low Frequency	32Hz-2.0kHz	4-40	table#3
14	EQ Low Gain	-12+12dB	52-76	
15	EQ High Frequency	500Hz-16.0kHz	28-58	table#3
16	EQ High Gain	-12+12dB	52-76	

EARLY REF1,EARLY REF2(variation block)

No.	Parameter	Value	See Table	Control
1	Type	S-H, L-H, Rdm, Rvs, Plt, Spr	0-5	
2	Room Size	0.1-7.0	0-44	table#6
3	Diffusion	0-10	0-10	
4	Initial Delay	0-63	0-63	table#5
5	Feedback Level	-63+63	1-127	
6	HPF Cutoff	Thru-8.0kHz	0-52	table#3
7	LPF Cutoff	1.0k-Thru	34-60	table#3
8				
9				
10	Dry/Wet	D63>W - D=W - D<W63	1-127	●
11	Liveness	0-10	0-10	
12	Density	0-3	0-3	
13	High Damp	0.1-1.0	1-10	
14				
15				
16				

GATE REVERB, REVERSE GATE (variation block)

No.	Parameter	Value	See Table	Control
1	Type	TypeA, TypeB	0-1	
2	Room Size	0.1-20.0	0-127	table#6
3	Diffusion	0-10	0-10	
4	Initial Delay	0-127	0-127	table#5
5	Feedback Level	-63+63	1-127	
6	HPF Cutoff	Thru-8.0kHz	0-52	table#3
7	LPF Cutoff	1.0k-Thru	34-60	table#3
8				
9				
10	Dry/Wet	D63>W - D=W - D<W63	1-127	●
11	Liveness	0-10	0-10	
12	Density	0-3	0-3	
13	High Damp	0.1-1.0	1-10	
14				
15				
16				

KARAOKE1,2,3 (variation, insertion block)

No.	Parameter	Value	See Table	Control
1	Delay Time	0-127	0-127	table#7
2	Feedback Level	-63+63	1-127	
3	HPF Cutoff	Thru-8.0kHz	0-52	table#3
4	LPF Cutoff	1.0k-Thru	34-60	table#3
5				
6				
7				
8				
9				
10	Dry/Wet	D63>W - D=W - D<W63	1-127	●
11				
12				
13				
14				
15				
16				

CHORUS1,2,3,4, CELESTE1,2,3,4 (chorus, variation, insertion block)

No.	Parameter	Value	See Table	Control
1	LFO Frequency	0.00Hz-39.7Hz	0-127	table#1
2	LFO Depth	0-127	0-127	
3	Feedback Level	-63+63	1-127	
4	Delay Offset	0-127	0-127	table#2
5				
6	EQ Low Frequency	32Hz-2.0kHz	4-40	table#3
7	EQ Low Gain	-12+12dB	52-76	
8	EQ High Frequency	500Hz-16.0kHz	28-58	table#3
9	EQ High Gain	-12+12dB	52-76	
10	Dry/Wet	D63>W - D=W - D<W63	1-127	●
11				
12	EQ Mid Frequency	100Hz-10.0kHz (variation block)	14-54	table#3
13	EQ Mid Gain	-12+12dB (variation block)	52-76	
14	EQ Mid Width	1.0-12.0 (variation block)	10-120	
15				
16	Input Mode	mono/stereo	0-1	

FLANGER1,2,3 (chorus, variation, insertion block)

No.	Parameter	Value	See Table	Control
1	LFO Frequency	0.00Hz-39.7Hz	0-127	table#1
2	LFO Depth	0-127	0-127	
3	Feedback Level	-63+63	1-127	
4	Delay Offset	0-127	0-127	table#2
5				
6	EQ Low Frequency	32Hz-2.0kHz	4-40	table#3
7	EQ Low Gain	-12+12dB	52-76	
8	EQ High Frequency	500Hz-16.0kHz	28-58	table#3
9	EQ High Gain	-12+12dB	52-76	
10	Dry/Wet	D63>W - D=W - D<W63	1-127	●
11				
12	EQ Mid Frequency	100Hz-10.0kHz (variation block)	14-54	table#3
13	EQ Mid Gain	-12+12dB (variation block)	52-76	
14	EQ Mid Width	1.0-12.0 (variation block)	10-120	
15	LFO Phase Difference	-180+180deg(resolution=3deg.)	4-124	
16				

MIDI Data Format / MIDI-Datenformat / Format des données MIDI / Formato de datos MIDI ●●

SYMPHONIC (chorus, variation, insertion block)

No.	Parameter	Value	See Table	Control
1	LFO Frequency	0.00Hz–39.7Hz	0–127	table#1
2	LFO Depth	0–127	0–127	
3	Delay Offset	0–127	table#2	
4				
5				
6	EQ Low Frequency	32Hz–2.0kHz	4–40	table#3
7	EQ Low Gain	-12→+12dB	52–76	
8	EQ High Frequency	500Hz–16.0kHz	28–58	table#3
9	EQ High Gain	-12→+12dB	52–76	
10	Dry/Wet	D63>W – D=W – D<W63	1–127	●
11	EQ Mid Frequency	100Hz–10.0kHz (variation block)	14–54	table#3
12	EQ Mid Gain	-12→+12dB (variation block)	52–76	
13	EQ Mid Width	1.0–12.0 (variation block)	10–120	
14				
15				
16				

ENSEMBLE DETUNE (chorus, variation, insertion block)

No.	Parameter	Value	See Table	Control
1	Detune	-50→+50cent	14–114	
2	Lch Init Delay	0–127	0–127	table#2
3	Rch Init Delay	0–127	0–127	table#2
4				
5				
6				
7				
8				
9				
10	Dry/Wet	D63>W – D=W – D<W63	1–127	●
11	EQ Low Frequency	32Hz–2.0kHz (variation, insertion block)	4–40	table#3
12	EQ Low Gain	-12→+12dB (variation, insertion block)	52–76	
13	EQ High Frequency	500Hz–16.0kHz (variation, insertion block)	28–58	table#3
14	EQ High Gain	-12→+12dB (variation, insertion block)	52–76	
15				
16				

AMBIENCE (variation block)

No.	Parameter	Value	See Table	Control
1	Delay Time	0–127	0–127	table#2
2	Output Phase	normal/invers	0–1	
3				
4				
5				
6	EQ Low Frequency	32Hz–2.0kHz	4–40	table#3
7	EQ Low Gain	-12→+12dB	52–76	
8	EQ High Frequency	500Hz–16.0kHz	28–58	table#3
9	EQ High Gain	-12→+12dB	52–76	
10	Dry/Wet	D63>W – D=W – D<W63	1–127	●
11				
12				
13				
14				
15				
16				

ROTARY SPEAKER (variation, insertion block)

No.	Parameter	Value	See Table	Control
1	LFO Frequency	0.00Hz–39.7Hz	0–127	table#1
2	LFO Depth	0–127	0–127	
3				
4				
5				
6	EQ Low Frequency	32Hz–2.0kHz	4–40	table#3
7	EQ Low Gain	-12→+12dB	52–76	
8	EQ High Frequency	500Hz–16.0kHz	28–58	table#3
9	EQ High Gain	-12→+12dB	52–76	
10	Dry/Wet	D63>W – D=W – D<W63	1–127	●
11	EQ Mid Frequency	100Hz–10.0kHz (variation block)	14–54	table#3
12	EQ Mid Gain	-12→+12dB (variation block)	52–76	
13	EQ Mid Width	1.0–12.0 (variation block)	10–120	
14				
15				
16				

2WAY ROTARY SPEAKER (variation block)

No.	Parameter	Value	See Table	Control
1	Rotor Speed	0.0Hz–39.7Hz	0–127	table#1
2	Drive Low	0–127	0–127	
3	Drive High	0–127	0–127	
4	Low/High	L63>H – L=H – L<H63	1–127	
5				
6	EQ Low Frequency	32Hz–2.0kHz	4–40	table#3
7	EQ Low Gain	-12→+12dB	52–76	
8	EQ High Frequency	500Hz–16.0kHz	28–58	table#3
9	EQ High Gain	-12→+12dB	52–76	
10				
11	Crossover Frequency	100Hz–10.0kHz	14–54	table#3
12	Mic L-R Angle	0deg–180deg(resolution=3deg.)	0–60	
13				
14				
15				
16				

TREMOLO (variation, insertion block)

No.	Parameter	Value	See Table	Control
1	LFO Frequency	0.00Hz–39.7Hz	0–127	table#1
2	AM Depth	0–127	0–127	
3	PM Depth	0–127	0–127	
4				
5				
6	EQ Low Frequency	32Hz–2.0kHz	4–40	table#3
7	EQ Low Gain	-12→+12dB	52–76	
8	EQ High Frequency	500Hz–16.0kHz	28–58	table#3
9	EQ High Gain	-12→+12dB	52–76	
10				
11	EQ Mid Frequency	100Hz–10.0kHz (variation block)	14–54	table#3
12	EQ Mid Gain	-12→+12dB (variation block)	52–76	
13	EQ Mid Width	1.0–12.0 (variation block)	10–120	
14	LFO Phase Difference	-180→+180deg(resolution=3deg.)	4–124	
15	Input Mode	mono/stereo	0–1	
16				

AUTO PAN (variation, insertion block)

No.	Parameter	Value	See Table	Control
1	LFO Frequency	0.00Hz–39.7Hz	0–127	table#1
2	L/R Depth	0–127	0–127	
3	F/R Depth	0–127	0–127	
4	PAN Direction	L<->R,L->R,L<-R,Lturn,Rturn,L/R	0–5	
5				
6	EQ Low Frequency	32Hz–2.0kHz	4–40	table#3
7	EQ Low Gain	-12→+12dB	52–76	
8	EQ High Frequency	500Hz–16.0kHz	28–58	table#3
9	EQ High Gain	-12→+12dB	52–76	
10				
11	EQ Mid Frequency	100Hz–10.0kHz (variation block)	14–54	table#3
12	EQ Mid Gain	-12→+12dB (variation block)	52–76	
13	EQ Mid Width	1.0–12.0 (variation block)	10–120	
14				
15				
16				

PHASER 1 (chorus, variation, insertion block)

No.	Parameter	Value	See Table	Control
1	LFO Frequency	0.00Hz–39.7Hz	0–127	table#1
2	LFO Depth	0–127	0–127	
3	Phase Shift Offset	0–127	0–127	
4	Feedback Level	-63→+63	1–127	
5				
6	EQ Low Frequency	32Hz–2.0kHz	4–40	table#3
7	EQ Low Gain	-12→+12dB	52–76	
8	EQ High Frequency	500Hz–16.0kHz	28–58	table#3
9	EQ High Gain	-12→+12dB	52–76	
10	Dry/Wet	D63>W – D=W – D<W63	1–127	●
11	Stage	4, 5, 6 (chorus, insertion block)	4–6	
12	Diffusion	4→12 (variation block)	4–12	
13		mono/stereo	0–1	
14				
15				
16				

PHASER 2 (variation block)

No.	Parameter	Value	See Table	Control
1	LFO Frequency	0.00Hz–39.7Hz	0–127	table#1
2	LFO Depth	0–127	0–127	
3	Phase Shift Offset	0–127	0–127	
4	Feedback Level	-63→+63	1–127	
5				
6	EQ Low Frequency	32Hz–2.0kHz	4–40	table#3
7	EQ Low Gain	-12→+12dB	52–76	
8	EQ High Frequency	500Hz–16.0kHz	28–58	table#3
9	EQ High Gain	-12→+12dB	52–76	
10	Dry/Wet	D63>W – D=W – D<W63	1–127	●
11	Stage	3, 4, 5, 6	3–6	
12				
13	LFO Phase Difference	-180deg→+180deg(resolution=3deg.)	4–124	
14				
15				
16				

DISTORTION, OVERDRIVE (variation, insertion block)

No.	Parameter	Value	See Table	Control
1	Drive	0–127	0–127	●
2	EQ Low Frequency	32Hz–2.0kHz	4–40	table#3
3	EQ Low Gain	-12→+12dB	52–76	
4	LPF Cutoff	1.0k–Thru	34–60	table#3
5	Output Level	0–127	0–127	
6				
7	EQ Mid Frequency	100Hz–10.0kHz	14–54	table#3
8	EQ Mid Gain	-12→+12dB	52–76	
9	EQ Mid Width	1.0–12.0	10–120	
10	Dry/Wet	D63>W – D=W – D<W63	1–127	●
11	Edge(Clip Curve)	0–127	0–127	mild-sharp
12				
13				
14				
15				
16				

COMP+DIST (variation block)

No.	Parameter	Value	See Table	Control
1	Drive	0–127	0–127	●
2	EQ Low Frequency	32Hz–2.0kHz	4–40	table#3
3	EQ Low Gain	-12→+12dB	52–76	
4	LPF Cutoff	1.0k–Thru	34–60	table#3
5	Output Level	0–127	0–127	
6				
7	EQ Mid Frequency	100Hz–10.0kHz	14–54	table#3
8	EQ Mid Gain	-12→+12dB	52–76	
9	EQ Mid Width	1.0–12.0	10–120	
10	Dry/Wet	D63>W – D=W – D<W63	1–127	●
11	Edge(Clip Curve)	0–127	0–127	mild-sharp
12	Attack	1ms–40ms	0–19	table#8
13	Release	10ms–680ms	0–15	table#9
14	Threshold	-48dB–6dB	79–121	
15	Ratio	1.0–20.0	0–7	table#10
16				

AMP SIMULATOR (variation, insertion block)

No.	Parameter	Value	See Table	Control
1	Drive	0-127		●
2	AMP Type	Off Stack, Combo, Tube		
3	LPF Cutoff	1.0k-Thru	table#3	
4	Output Level	0-127		
5				
6				
7				
8				
9	Dry/Wet	D63>W - D=W - D<W63		
10				
11	Edge(Clip Curve)	0-127		mild-sharp
12				
13				
14				
15				
16				

3BAND EQ(MONO) (variation, insertion block)

No.	Parameter	Value	See Table	Control
1	EQ Low Gain	-12+12dB		
2	EQ Mid Frequency	100Hz-10.0kHz	table#3	
3	EQ Mid Gain	-12+12dB		
4	EQ Mid Width	1.0-12.0		
5	EQ High Gain	-12+12dB		
6	EQ Low Frequency	50Hz-2.0kHz	table#3	
7	EQ High Frequency	500Hz-16.0kHz	table#3	
8				
9				
10				
11				
12				
13				
14				
15	Input Mode	mono/stereo		0-1
16				

2BAND EQ(STEREO) (variation, insertion block)

No.	Parameter	Value	See Table	Control
1	EQ Low Frequency	32Hz-2.0kHz	table#3	
2	EQ Low Gain	-12+12dB		
3	EQ High Frequency	500Hz-16.0kHz	table#3	
4	EQ High Gain	-12+12dB		
5				
6				
7				
8				
9				
10				
11				
12				
13				
14				
15				
16				

AUTO WAH (variation, insertion block)

No.	Parameter	Value	See Table	Control
1	LFO Frequency	0.00Hz-39.7Hz	0-127	
2	LFO Depth	0-127	0-127	
3	Cutoff Frequency Offset	0-127	0-127	●
4	Resonance	1.0-12.0	10-120	
5				
6	EQ Low Frequency	32Hz-2.0kHz	4-40	table#3
7	EQ Low Gain	-12+12dB	52-76	
8	EQ High Frequency	500Hz-16.0kHz	28-58	table#3
9	EQ High Gain	-12+12dB	52-76	
10	Dry/Wet	D63>W - D=W - D<W63	1-127	
11	Drive	0-127	0-127	
12				
13				
14				
15				
16				

AUTO WAH+DIST, AUTO WHA+ODRV (variation block)

No.	Parameter	Value	See Table	Control
1	LFO Frequency	0.00Hz-39.7Hz	0-127	
2	LFO Depth	0-127	0-127	
3	Cutoff Frequency Offset	0-127	0-127	●
4	Resonance	1.0-12.0	10-120	
5				
6	EQ Low Frequency	32Hz-2.0kHz	4-40	table#3
7	EQ Low Gain	-12+12dB	52-76	
8	EQ High Frequency	500Hz-16.0kHz	28-58	table#3
9	EQ High Gain	-12+12dB	52-76	
10	Dry/Wet	D63>W - D=W - D<W63	1-127	
11	Drive	0-127	0-127	
12	EQ Low Gain(distortion)	-12+12dB	52-76	
13	EQ Mid Gain(distortion)	-12+12dB	52-76	
14	LPF Cutoff	1.0kHz-thru	34-60	table#3
15	Output Level	0-127	0-127	
16				

TOUCH WAH 1 (variation, insertion block), TOUCH WAH+DIST (variation block)

No.	Parameter	Value	See Table	Control
1	Sensitive	0-127		●
2	Cutoff Frequency Offset	0-127		
3	Resonance	1.0-12.0	10-120	
4				
5				
6	EQ Low Frequency	32Hz-2.0kHz	4-40	table#3
7	EQ Low Gain	-12+12dB	52-76	
8	EQ High Frequency	500Hz-16.0kHz	28-58	table#3
9	EQ High Gain	-12+12dB	52-76	
10	Dry/Wet	D63>W - D=W - D<W63	1-127	
11	Drive	0-127	0-127	
12				
13				
14				
15				
16				

TOUCH WAH 2 (variation, insertion block), TOUCH WAH+ODRV (variation block)

No.	Parameter	Value	See Table	Control
1	Sensitive	0-127		●
2	Cutoff Frequency Offset	0-127		
3	Resonance	1.0-12.0	10-120	
4				
5				
6	EQ Low Frequency	32Hz-2.0kHz	4-40	table#3
7	EQ Low Gain	-12+12dB	52-76	
8	EQ High Frequency	500Hz-16.0kHz	28-58	table#3
9	EQ High Gain	-12+12dB	52-76	
10	Dry/Wet	D63>W - D=W - D<W63	1-127	
11	Drive	0-127	0-127	
12	EQ Low Gain(distortion)	-12+12dB	52-76	
13	EQ Mid Gain(distortion)	-12+12dB	52-76	
14	LPF Cutoff	1.0kHz-thru	34-60	table#3
15	Output Level	0-127	0-127	
16				

PITCH CHANGE 1 (variation block)

No.	Parameter	Value	See Table	Control
1	Pitch	-24+24	40-88	
2	Initial Delay	0-127	0-127	table#7
3	Fine 1	-50Hz+50Hz	14-114	
4	Fine 2	-50Hz+50Hz	14-114	
5	Feedback Level	-99+99%	1-127	
6				
7				
8				
9				
10	Dry/Wet	D63>W - D=W - D<W63	1-127	●
11	Pan 1	L63-R63	1-127	
12	Output Level 1	0-127	0-127	
13	Pan 2	L63-R63	1-127	
14	Output Level 2	0-127	0-127	
15				
16				

PITCH CHANGE 2 (variation block)

No.	Parameter	Value	See Table	Control
1	Pitch	-24+24	40-88	
2	Initial Delay	0-127	0-127	table#7
3	Fine 1	-50+50cent	14-114	
4	Fine 2	-50+50cent	14-114	
5	Feedback Level	-99+99%	1-127	
6				
7				
8				
9				
10	Dry/Wet	D63>W - D=W - D<W63	1-127	●
11	Pan 1	L63-R63	1-127	
12	Output Level 1	0-127	0-127	
13	Pan 2	L63-R63	1-127	
14	Output Level 2	0-127	0-127	
15				
16				

COMPRESSOR (variation, insertion block)

No.	Parameter	Value	See Table	Control
1	Attack	1-40ms	0-19	
2	Release	10-680ms	0-15	table#8
3	Threshold	-48-6dB	79-121	table#9
4	Ratio	1.0-20.0	0-7	table#10
5	Output Level	0-127	0-127	
6				
7				
8				
9				
10				
11				
12				
13				
14				
15				
16				

NOISE GATE (variation, insertion block)

No.	Parameter	Value	See Table	Control
1	Attack	1-40ms	0-19	table#8
2	Release	10-680ms	0-15	table#9
3	Threshold	-72-30dB	55-97	
4	Output Level	0-127	0-127	
5				
6				
7				
8				
9				
10				
11				
12				
13				
14				
15				
16				

MIDI Data Format / MIDI-Datenformat / Format des données MIDI / Formato de datos MIDI

< Table 1-11 > Effect Data Value Assign Table

Table#1
LFO Frequency

Data	Value	Data	Value	Data	Value	Data	Value
0	0.00	32	1.35	64	2.69	96	8.41
1	0.04	33	1.39	65	2.78	97	8.75
2	0.08	34	1.43	66	2.86	98	9.08
3	0.13	35	1.47	67	2.94	99	9.42
4	0.17	36	1.51	68	3.03	100	9.76
5	0.21	37	1.56	69	3.11	101	10.1
6	0.25	38	1.60	70	3.20	102	10.8
7	0.29	39	1.64	71	3.28	103	11.4
8	0.34	40	1.68	72	3.37	104	12.1
9	0.38	41	1.72	73	3.45	105	12.8
10	0.42	42	1.77	74	3.53	106	13.5
11	0.46	43	1.81	75	3.62	107	14.1
12	0.51	44	1.85	76	3.70	108	14.8
13	0.55	45	1.89	77	3.87	109	15.5
14	0.59	46	1.94	78	4.04	110	16.2
15	0.63	47	1.98	79	4.21	111	16.8
16	0.67	48	2.02	80	4.37	112	17.5
17	0.72	49	2.06	81	4.54	113	18.2
18	0.76	50	2.10	82	4.71	114	19.5
19	0.80	51	2.15	83	4.88	115	20.9
20	0.84	52	2.19	84	5.05	116	22.2
21	0.88	53	2.23	85	5.22	117	23.6
22	0.93	54	2.27	86	5.38	118	24.9
23	0.97	55	2.31	87	5.55	119	26.2
24	1.01	56	2.36	88	5.72	120	27.6
25	1.05	57	2.40	89	6.06	121	28.9
26	1.09	58	2.44	90	6.39	122	30.3
27	1.14	59	2.48	91	6.73	123	31.6
28	1.18	60	2.52	92	7.07	124	33.0
29	1.22	61	2.57	93	7.40	125	34.3
30	1.26	62	2.61	94	7.74	126	37.0
31	1.30	63	2.65	95	8.08	127	39.7

Table#4
Reverb time

Data	Value	Data	Value	Data	Value
0	0.3	32	3.5	64	17.0
1	0.4	33	3.6	65	18.0
2	0.5	34	3.7	66	19.0
3	0.6	35	3.8	67	20.0
4	0.7	36	3.9	68	25.0
5	0.8	37	4.0	69	30.0
6	0.9	38	4.1		
7	1.0	39	4.2		
8	1.1	40	4.3		
9	1.2	41	4.4		
10	1.3	42	4.5		
11	1.4	43	4.6		
12	1.5	44	4.7		
13	1.6	45	4.8		
14	1.7	46	4.9		
15	1.8	47	5.0		
16	1.9	48	5.5		
17	2.0	49	6.0		
18	2.1	50	6.5		
19	2.2	51	7.0		
20	2.3	52	7.5		
21	2.4	53	8.0		
22	2.5	54	8.5		
23	2.6	55	9.0		
24	2.7	56	9.5		
25	2.8	57	10.0		
26	2.9	58	11.0		
27	3.0	59	12.0		
28	3.1	60	13.0		
29	3.2	61	14.0		
30	3.3	62	15.0		
31	3.4	63	16.0		

Table#7
Delay Time(400.Oms)

Data	Value	Data	Value	Data	Value	Data	Value
0	0.1	32	100.9	64	201.6	96	302.4
1	3.2	33	104.0	65	204.8	97	305.5
2	6.4	34	107.2	66	207.9	98	308.7
3	9.5	35	110.3	67	211.1	99	311.8
4	12.7	36	113.5	68	214.2	100	315.0
5	15.8	37	116.6	69	217.4	101	318.1
6	19.0	38	119.8	70	220.5	102	321.3
7	22.1	39	122.9	71	223.7	103	324.4
8	25.3	40	126.1	72	226.8	104	327.6
9	28.4	41	129.2	73	230.0	105	330.7
10	31.6	42	132.4	74	233.1	106	333.9
11	34.7	43	135.5	75	236.3	107	337.0
12	37.9	44	138.6	76	239.4	108	340.2
13	41.0	45	141.8	77	242.6	109	343.3
14	44.2	46	144.9	78	245.7	110	346.5
15	47.3	47	148.1	79	248.9	111	349.6
16	50.5	48	151.2	80	252.0	112	352.8
17	53.6	49	154.4	81	255.2	113	355.9
18	56.8	50	157.5	82	258.3	114	359.1
19	59.9	51	160.7	83	261.5	115	362.2
20	63.1	52	163.8	84	264.6	116	365.4
21	66.2	53	167.0	85	267.7	117	368.5
22	69.4	54	170.1	86	270.9	118	371.7
23	72.5	55	173.3	87	274.0	119	374.8
24	75.7	56	176.4	88	277.2	120	378.0
25	78.8	57	179.6	89	280.3	121	381.1
26	82.0	58	182.7	90	283.5	122	384.3
27	85.1	59	185.9	91	286.6	123	387.4
28	88.3	60	189.0	92	289.8	124	390.6
29	91.4	61	192.2	93	292.9	125	393.7
30	94.6	62	195.3	94	296.1	126	396.9
31	97.7	63	198.5	95	299.2	127	400.0

Table#11
Reverb Width;Depth;Height

Data	Value	Data	Value	Data	Value	Data	Value
0	0.5	32	8.8	64	17.6	96	27.5
1	0.8	33	9.1	65	17.9	98	28.1
2	1.0	34	9.4	66	18.2	99	28.5
3	1.3	35	9.6	67	18.5	100	28.8
4	1.5	36	9.9	68	18.8	101	29.2
5	1.8	37	10.2	69	19.1	102	29.5
6	2.0	38	10.4	70	19.4	103	29.9
7	2.3	39	10.7	71	19.7	104	30.2
8	2.6	40	11.0	72	20.0		
9	2.8	41	11.2	73	20.2		
10	3.1	42	11.5	74	20.5		
11	3.3	43	11.8	75	20.8		
12	3.6	44	12.1	76	21.1		
13	3.9	45	12.3	77	21.4		
14	4.1	46	12.6	78	21.7		
15	4.4	47	12.9	79	22.0		
16	4.6	48	13.1	80	22.4		
17	4.9	49	13.4	81	22.7		
18	5.2	50	13.7	82	23.0		
19	5.4	51	14.0	83	23.3		
20	5.7	52	14.2	84	23.6		
21	5.9	53	14.5	85	23.9		
22	6.2	54	14.8	86	24.2		
23	6.5	55	15.1	87	24.5		
24	6.7	56	15.4	88	24.9		
25	7.0	57	15.6	89	25.2		
26	7.2	58	15.9	90	25.5		
27	7.5	59	16.2	91	25.8		
28	7.8	60	16.5	92	26.1		
29	8.0	61	16.8	93	26.5		
30	8.3	62	17.1	94	26.8		
31	8.6	63	17.3	95	27.1		

Table#2
Modulation Delay Offset

Data	Value	Data	Value	Data	Value	Data	Value
0	0.0	32	3.2	64	6.4	96	9.6
1	0.1	33	3.3	65	6.5	97	9.7
2	0.2	34	3.4	66	6.6	98	9.8
3	0.3	35	3.5	67	6.7	99	9.9
4	0.4	36	3.6	68	6.8	100	10.0
5	0.5	37	3.7	69	6.9	101	11.1
6	0.6	38	3.8	70	7.0	102	12.2
7	0.7	39	3.9	71	7.1	103	13.3
8	0.8	40	4.0	72	7.2	104	14.4
9	0.9	41	4.1	73	7.3	105	15.5
10	1.0	42	4.2	74	7.4	106	17.1
11	1.1	43	4.3	75	7.5	107	18.6
12	1.2	44	4.4	76	7.6	108	20.2
13	1.3	45	4.5	77	7.7	109	21.8
14	1.4	46	4.6	78	7.8	110	23.3
15	1.5	47	4.7	79	7.9	111	24.9
16	1.6	48	4.8	80	8.0	112	26.5
17	1.7	49	4.9	81	8.1	113	28.0
18	1.8	50	5.0	82	8.2	114	29.6
19	1.9	51	5.1	83	8.3	115	31.2
20	2.0	52	5.2	84	8.4	116	32.8
21	2.1	53	5.3	85	8.5	117	34.3
22	2.2	54	5.4	86	8.6	118	35.9
23	2.3	55	5.5	87	8.7	119	37.5
24	2.4	56	5.6	88	8.8	120	39.0
25	2.5	57	5.7	89	8.9	121	40.6
26	2.6	58	5.8	90	9.0	122	42.2
27	2.7	59	5.9	91	9.1	123	43.7
28	2.8	60	6.0	92	9.2	124	45.3
29	2.9	61	6.1	93	9.3	125	46.9
30	3.0	62	6.2	94	9.4	126	48.4
31	3.1	63	6.3	95	9.5	127	50.0

Table#5
Delay Time(200.Oms)

Data	Value	Data	Value	Data	Value	Data	Value
0	0.1	32	50.5	64	100.8	96	151.2
1	1.7	33	52.0	65	102.4	97	152.8
2	3.2	34	53.6	66	104.0	98	154.4
3	4.8	35	55.2	67	105.6	99	155.9
4	6.4	36	56.8	68	107.1	100	157.5
5	8.0	37	58.3	69	108.7	101	159.1
6	9.5	38	59.9	70	110.3	102	160.6
7	11.1	39	61.5	71	111.9	103	162.2
8	12.7	40	63.1	72	113.4	104	163.8
9	14.3	41	64.6	73	115.0	105	165.4
10	15.8	42	66.2	74	116.6	106	166.9
11	17.4	43	67.8	75	118.2	107	168.5
12	19.0	44	69.4	76	119.7	108	170.1
13	20.6	45	70.9	77	121.3	109	171.7
14	22.1	46	72.5	78	122.9	110	173.2
15	23.7	47	74.1	79	124.4	111	174.8
16	25.3	48	75.7	80	126.0	112	176.4
17	26.9	49	77.2				

Voice List / Stimmenverzeichnis / Liste des voix / Lista de voces



Category	Voice Name	Voice #			
		MSB #	LSB #	Program Change #	
Piano	Grand Piano	0	112	0	
	Bright Piano	0	112	1	
	Mellow Piano	0	114	0	
	Rock Piano	0	113	1	
	Mono Piano	0	113	0	
	Piano EP	0	115	2	
	Honky Tonk	0	112	3	
	Harpsichord1	0	112	6	
	Harpsichord2	0	113	6	
	Grand Harpsi	0	115	6	
	E.Piano	Elec. Piano	0	113	4
DX EP		0	112	5	
CP80		0	116	2	
Jazz EP 1		0	116	4	
DX EP Modern		0	115	5	
Stage EP		0	117	4	
Galaxy EP		0	113	5	
Funky EP		0	114	4	
Hyper EP		0	115	4	
Dream EP		0	114	5	
Jazz EP 2		0	112	4	
Wire EP		0	113	5	
Tremolo EP		0	118	4	
Clavi.		0	112	7	
Vibes		Vibes	0	112	11
	Jazz Vibes	0	113	11	
	Celesta	0	112	8	
	Marimba	0	112	12	
	Glockenspiel	0	112	9	
	Xylophone	0	112	13	
	TubularBells	0	112	14	
	Music Box	0	112	10	
	Steel Drums	0	112	114	
	Guitar	Gut Guitar	0	112	24
		Folk Guitar	0	112	25
Jazz Guitar1		0	112	26	
Banjo		0	112	105	
Harp		0	112	46	
Nylon Guitar		0	113	24	
Steel Guitar		0	113	25	
Jazz Guitar2		0	113	26	
Clean Guitar		0	112	27	
Dist. Guitar		0	112	30	
12Str.Guitar		0	115	25	
Mute Guitar		0	112	28	
HawaiianGtr.		0	114	26	
OctaveGuitar		0	115	26	
Clavi. Tone / Synth	Clavinova T.	0	112	88	
	NewAge Pad1	0	113	88	
	NewAge Pad2	0	115	88	
	Square Lead	0	112	80	
	Saw. Lead	0	112	81	
	Synth Pf	0	114	88	

Category	Voice Name	Voice #			
		MSB #	LSB #	Program Change #	
Clavi. Tone / Synth	Strings Pad	0	112	51	
	Atmosphere	0	112	99	
	Brass Bells	0	112	93	
	SynthCrystal	0	112	96	
	Synth Bell	0	116	88	
	Brass Pad	0	112	90	
	Choir Pad	0	112	91	
	Cosmic Pad	0	112	101	
	Quack Lead	0	112	87	
	Organ	Pipe Organ	0	112	19
		Class. Organ	0	113	19
Chapel Organ		0	115	19	
Jazz Organ		0	112	16	
Accordion		0	115	21	
Perc. Organ		0	112	17	
Trem. Organ		0	112	18	
Rock Organ		0	113	18	
Theatre Org.		0	114	16	
Organ Combi.		0	116	16	
Elec. Organ		0	113	16	
French Accrd		0	112	21	
Tango Accrd.		0	112	23	
Strings / Choir		Orch.Strings	0	115	48
	Strings	0	112	48	
	Violin	0	112	40	
	Pizzicato	0	112	45	
	Choir	0	115	52	
	Class. Strs.	0	114	48	
	PopularStrs.	0	116	48	
	StringsSlow1	0	112	49	
	StringsSlow2	0	112	49	
	Choir Oohs	0	112	53	
	ChamberStrs.	0	113	48	
	Cello	0	112	42	
	Syn. Strings	0	112	50	
	Synth Choir	0	112	52	
OrchestraHit	0	112	55		
Brass	BigBnd Brass	0	115	61	
	Small Brass	0	113	61	
	Trumpet	0	112	56	
	Trombone	0	112	57	
	French Horn	0	112	60	
	BrassSection	0	112	61	
	Octave Brass	0	114	61	
	MuteTrumpet1	0	113	59	
	MuteTrumpet2	0	112	59	
	Tuba	0	112	58	
	Synth Brass1	0	112	62	
	Synth Brass2	0	112	63	
	Soft Trumpet	0	112	56	
	Flugel Horn	0	113	56	
	Brass&Sax	0	116	61	



Voice List / Stimmenverzeichnis / Liste des voix / Lista de voces

Category	Voice Name	Voice #			
		MSB #	LSB #	Program Change #	
Sax / Flute	Tenor Sax	0	112	66	
	Alto Sax	0	112	65	
	Flute	0	112	73	
	Oboe	0	112	68	
	Clarinet	0	112	71	
	Soprano Sax	0	112	64	
	Baritone Sax	0	112	67	
	Pan Flute	0	112	75	
	Bassoon	0	112	70	
	Harmonica	0	112	22	
	Piccolo	0	112	72	
	Recorder	0	112	74	
	Sax&Clarinet	0	113	65	
	Sax Section	0	114	65	
Bass	WindEnsemble	0	113	73	
	Acous.Bass 1	0	112	32	
	Acous.Bass 2	0	113	32	
	E. Bass Slap	0	112	33	
	Finger Bass	0	114	33	
	Timpani	0	112	47	
	Elec. Bass	0	113	33	
	FretlessBass	0	112	35	
	Slap Bass	0	112	36	
	Synth Bass 1	0	112	38	
	Synth Bass 2	0	112	39	
	Pick Bass	0	112	34	
	Organ Bass	0	117	16	
	Bass&Cymbal	0	114	32	
	Drums	Standard Kit	127	0	0
		Standard2Kit	127	0	1
Room Kit		127	0	8	
Rock Kit		127	0	16	
Electro Kit		127	0	24	
Analog Kit		127	0	25	
Dance Kit		127	0	27	
Jazz Kit		127	0	32	
Brush Kit		127	0	40	
Classic Kit		127	0	48	
SFX1 Kit		126	0	0	
SFX2 Kit		126	0	1	
XG	GrandPno	0	0	0	
	GrndPnoK	0	1	0	
	MelloGrP	0	18	0	
	PianoStr	0	40	0	
	Dream	0	41	0	
	BritePno	0	0	1	
	BritPnoK	0	1	1	
	El.Grand	0	0	2	
	ElGrPnoK	0	1	2	
	Det.CP80	0	32	2	
	LayerCP1	0	40	2	
	LayerCP2	0	41	2	
	HnkyTonk	0	0	3	

Category	Voice Name	Voice #		
		MSB #	LSB #	Program Change #
XG	HnkyTnkK	0	1	3
	E.Piano1	0	0	4
	El.Pno1K	0	1	4
	MelloEP1	0	18	4
	Chor.EP1	0	32	4
	HardEl.P	0	40	4
	VX El.P1	0	45	4
	60sEl.P1	0	64	4
	E.Piano2	0	0	5
	El.Pno2K	0	1	5
	Chor.EP2	0	32	5
	DX Hard	0	33	5
	DXLegend	0	34	5
	DX Phase	0	40	5
	DX+Analg	0	41	5
	DXKotoEP	0	42	5
	VX El.P2	0	45	5
	Harpsi.	0	0	6
	Harpsi.K	0	1	6
	Harpsi.2	0	25	6
	Harpsi.3	0	35	6
	Clavi	0	0	7
	Clavi K	0	1	7
	ClaviWah	0	27	7
	PulseClv	0	64	7
	PierceCl	0	65	7
	Celesta	0	0	8
	Glocken	0	0	9
	MusicBox	0	0	10
	Orgel	0	64	10
	Vibes	0	0	11
	Vibes K	0	1	11
	HardVibe	0	45	11
	Marimba	0	0	12
	MarimbaK	0	1	12
	SineMrmb	0	64	12
	Balimba	0	97	12
	Log Drum	0	98	12
	Xylophon	0	0	13
	TubulBel	0	0	14
	ChrchBel	0	96	14
	Carillon	0	97	14
Dulcimer	0	0	15	
Dulcimer2	0	35	15	
Cimbalom	0	96	15	
Santur	0	97	15	
DrawOrgn	0	0	16	
DetDrwOr	0	32	16	
60sDrOr1	0	33	16	
60sDrOr2	0	34	16	
70sDrOr1	0	35	16	
DrawOrg2	0	36	16	
60sDrOr3	0	37	16	

Voice List / Stimmenverzeichnis / Liste des voix / Lista de voces.....

Category	Voice Name	Voice #		
		MSB #	LSB #	Program Change #
XG	EvenBar	0	38	16
	16+2'2/3	0	40	16
	Organ Ba	0	64	16
	70sDrOr2	0	65	16
	CheezOrg	0	66	16
	DrawOrg3	0	67	16
	PercOrgn	0	0	17
	70sPcOr1	0	24	17
	DetPrcOr	0	32	17
	Lite Org	0	33	17
	PercOrg2	0	37	17
	RockOrgn	0	0	18
	RotaryOr	0	64	18
	SloRotar	0	65	18
	FstRotar	0	66	18
	ChrchOrg	0	0	19
	ChurOrg3	0	32	19
	ChurOrg2	0	35	19
	NotreDam	0	40	19
	OrgFlute	0	64	19
	TrmOrgFl	0	65	19
	ReedOrgn	0	0	20
	Puff Org	0	40	20
	Acordion	0	0	21
	AccordIt	0	32	21
	Harmnica	0	0	22
	Harmo. 2	0	32	22
	TangoAcd	0	0	23
	TngoAcd2	0	64	23
	NylonGtr	0	0	24
	NylonGt2	0	16	24
	NylonGt3	0	25	24
	VelGtHrm	0	43	24
	Ukulele	0	96	24
	SteelGtr	0	0	25
	SteelGt2	0	16	25
	12StrGtr	0	35	25
	Nyln&Stl	0	40	25
	Stl&Body	0	41	25
	Mandolin	0	96	25
	Jazz Gtr	0	0	26
	MelloGtr	0	18	26
	Jazz Amp	0	32	26
	CleanGtr	0	0	27
	ChorusGt	0	32	27
	Mute Gtr	0	0	28
	FunkGtr1	0	40	28
	MuteStlG	0	41	28
	FunkGtr2	0	43	28
	Jazz Man	0	45	28
Ovrdrive	0	0	29	
Gt.Pinch	0	43	29	
Dist.Gtr	0	0	30	

Category	Voice Name	Voice #		
		MSB #	LSB #	Program Change #
XG	FeedbkGt	0	40	30
	FeedbGt2	0	41	30
	GtrHarmo	0	0	31
	GtFeedbk	0	65	31
	GtrHrmo2	0	66	31
	Aco.Bass	0	0	32
	JazzRthm	0	40	32
	VXUprght	0	45	32
	FngrBass	0	0	33
	FingrDrk	0	18	33
	FlangeBa	0	27	33
	Ba&DstEG	0	40	33
	FngrSlap	0	43	33
	FngBass2	0	45	33
	Mod.Bass	0	65	33
	PickBass	0	0	34
	MutePkBa	0	28	34
	Fretless	0	0	35
	Fretles2	0	32	35
	Fretles3	0	33	35
	Fretles4	0	34	35
	SynFretl	0	96	35
	SmthFrt1	0	97	35
	SlapBas1	0	0	36
	ResoSlap	0	27	36
	PunchThm	0	32	36
	SlapBas2	0	0	37
	VeloSlap	0	43	37
	SynBass1	0	0	38
	SynBa1Dk	0	18	38
	FastResB	0	20	38
	AcidBass	0	24	38
	Civ Bass	0	35	38
	TechnoBa	0	40	38
	Orbiter	0	64	38
	Sqr.Bass	0	65	38
	RubberBa	0	66	38
	Hammer	0	96	38
	SynBass2	0	0	39
	MelloSBa	0	6	39
	Seq Bass	0	12	39
	ClkSynBa	0	18	39
	SynBa2Dk	0	19	39
	SmthSynB	0	32	39
ModulrBa	0	40	39	
DX Bass	0	41	39	
X WireBa	0	64	39	
Violin	0	0	40	
Slow Vln	0	8	40	
Viola	0	0	41	
Cello	0	0	42	
Contrabs	0	0	43	
Trem.Str	0	0	44	

Voice List / Stimmenverzeichnis / Liste des voix / Lista de voces

Category	Voice Name	Voice #		
		MSB #	LSB #	Program Change #
XG	SlwTrStr	0	8	44
	Susp. Str	0	40	44
	Pizz.Str	0	0	45
	Harp	0	0	46
	YangChin	0	40	46
	Timpani	0	0	47
	Strings1	0	0	48
	S.Strngs	0	3	48
	Slow Str	0	8	48
	Arco Str	0	24	48
	60sStrng	0	35	48
	Orchestr	0	40	48
	Orchstr2	0	41	48
	TremOrch	0	42	48
	Velo.Str	0	45	48
	Strings2	0	0	49
	S.SlwStr	0	3	49
	LegatoSt	0	8	49
	Warm Str	0	40	49
	Kingdom	0	41	49
	70s Str	0	64	49
	Strings3	0	65	49
	Syn Str1	0	0	50
	Reso Str	0	27	50
	Syn Str4	0	64	50
	Syn Str5	0	65	50
	Syn Str2	0	0	51
	ChoirAah	0	0	52
	S.Choir	0	3	52
	Ch.Aahs2	0	16	52
	MelChoir	0	32	52
	ChoirStr	0	40	52
	VoiceOoh	0	0	53
	SynVoice	0	0	54
	SyVoice2	0	40	54
	Choral	0	41	54
	AnaVoice	0	64	54
	Orch.Hit	0	0	55
	OrchHit2	0	35	55
	Impact	0	64	55
	Trumpet	0	0	56
	Trumpet2	0	16	56
	BriteTrp	0	17	56
	Warm Trp	0	32	56
	Trombone	0	0	57
	Trmbone2	0	18	57
	Tuba	0	0	58
	Tuba 2	0	16	58
	Mute Trp	0	0	59
	Fr.Horn	0	0	60
	FrHrSolo	0	6	60
	FrHorn 2	0	32	60
	HornOrch	0	37	60

Category	Voice Name	Voice #		
		MSB #	LSB #	Program Change #
XG	BrssSect	0	0	61
	Tp&TbSec	0	35	61
	BrssSec2	0	40	61
	HiBrass	0	41	61
	MelloBrs	0	42	61
	SynBrss1	0	0	62
	Quack Br	0	12	62
	RezSynBr	0	20	62
	PolyBrss	0	24	62
	SynBrss3	0	27	62
	JumpBrss	0	32	62
	AnVelBr1	0	45	62
	AnVelBr2	0	64	62
	SynBrss2	0	0	63
	Soft Brs	0	18	63
	SynBrss4	0	40	63
	ChoirBrs	0	41	63
	VelBrss2	0	45	63
	AnaBrss2	0	64	63
	SprnoSax	0	0	64
	Alto Sax	0	0	65
	Sax Sect	0	40	65
	HyprAlto	0	43	65
	TenorSax	0	0	66
	BrthTnSx	0	40	66
	SoftTenr	0	41	66
	TnrSax 2	0	64	66
	Bari.Sax	0	0	67
	Oboe	0	0	68
	Eng.Horn	0	0	69
	Bassoon	0	0	70
	Clarinet	0	0	71
	Piccolo	0	0	72
	Flute	0	0	73
	Recorder	0	0	74
	PanFlute	0	0	75
	Bottle	0	0	76
	Shakhchi	0	0	77
	Whistle	0	0	78
	Ocarina	0	0	79
	SquareLd	0	0	80
	SquarLd2	0	6	80
	LMSquare	0	8	80
	Hollow	0	18	80
	Shroud	0	19	80
	Mellow	0	64	80
	SoloSine	0	65	80
	SineLead	0	66	80
	Saw Lead	0	0	81
	Saw Ld 2	0	6	81
	ThickSaw	0	8	81
	Dyna Saw	0	18	81
	Digi Saw	0	19	81

Voice List / Stimmenverzeichnis / Liste des voix / Lista de voces

Category	Voice Name	Voice #		
		MSB #	LSB #	Program Change #
XG	Sci-Fi	0	0	103
	Starz	0	64	103
	Sitar	0	0	104
	DetSitar	0	32	104
	Sitar 2	0	35	104
	Tambra	0	96	104
	Tamboura	0	97	104
	Banjo	0	0	105
	MuteBnjo	0	28	105
	Rabab	0	96	105
	Gopichnt	0	97	105
	Oud	0	98	105
	Shamisen	0	0	106
	Koto	0	0	107
	Taisho-k	0	96	107
	Kanoon	0	97	107
	Kalimba	0	0	108
	Bagpipe	0	0	109
	Fiddle	0	0	110
	Shanai	0	0	111
	Shanai 2	0	64	111
	Pungi	0	96	111
	Hichriki	0	97	111
	TnklBell	0	0	112
	Bonang	0	96	112
	Altair	0	97	112
	Gamelan	0	98	112
	S.Gamlan	0	99	112
	Rama Cym	0	100	112
	AsianBel	0	101	112
	Agogo	0	0	113
	SteelDrm	0	0	114
	GlasPerc	0	97	114
	ThaiBell	0	98	114
	WoodBlok	0	0	115
	Castanet	0	96	115
	TaikoDrm	0	0	116
	Gr.Cassa	0	96	116
	MelodTom	0	0	117
	Mel Tom2	0	64	117
	Real Tom	0	65	117
	Rock Tom	0	66	117
	Syn Drum	0	0	118
	Ana Tom	0	64	118
	ElecPerc	0	65	118
	RevCymb1	0	0	119
	FretNoiz	0	0	120
	BrthNoiz	0	0	121
	Seashore	0	0	122
	Tweet	0	0	123
	Telephone	0	0	124
	Helicptr	0	0	125
	Applause	0	0	126

Category	Voice Name	Voice #		
		MSB #	LSB #	Program Change #
XG	Gunshot	0	0	127
	CuttngNz	64	0	0
	CttngNz2	64	0	1
	Str Slap	64	0	3
	Fl.KClik	64	0	16
	Shower	64	0	32
	Thunder	64	0	33
	Wind	64	0	34
	Stream	64	0	35
	Bubble	64	0	36
	Feed	64	0	37
	Dog	64	0	48
	Horse	64	0	49
	Tweet 2	64	0	50
	Ghost	64	0	54
	Maou	64	0	55
	Tel.Dial	64	0	64
	DoorSqek	64	0	65
	DoorSlam	64	0	66
	ScratchC	64	0	67
	ScratchS	64	0	68
	WindChim	64	0	69
	Telphon2	64	0	70
	CarElgnt	64	0	80
	CarTSqel	64	0	81
	Car Pass	64	0	82
	CarCrash	64	0	83
	Siren	64	0	84
	Train	64	0	85
	JetPlane	64	0	86
	Starship	64	0	87
	Burst	64	0	88
	Coaster	64	0	89
	Submarin	64	0	90
	Laugh	64	0	96
	Scream	64	0	97
	Punch	64	0	98
	Heart	64	0	99
	Footstep	64	0	100
	MchinGun	64	0	112
	LaserGun	64	0	113
	Xplosion	64	0	114
	Firework	64	0	115

Drum/key Assignment List / Verzeichnis der Liste d'assignation instrument de batterie/ Lista de asignaciones de teclas/batería

Bank Select MSB					127	127	127	127	127	127
Bank Select LSB					0	0	0	0	0	0
Program # (1-128)					1	2	9	17	25	26
Keyboard Note	MIDI		Key off	Alternate assign	Standard Kit	Standard Kit 2	Room Kit	Rock Kit	Electronic Kit	Analog Kit
	Note #	Note								
C# 1	13	C# -1			Surdo Mute	Surdo Mute	Surdo Mute	Surdo Mute	Surdo Mute	Surdo Mute
D 1	14	D -1		3	Surdo Open	Surdo Open	Surdo Open	Surdo Open	Surdo Open	Surdo Open
D# 1	15	D# -1			Hi Q	Hi Q	Hi Q	Hi Q	Hi Q	Hi Q
E 1	16	E -1			Whip Slap	Whip Slap	Whip Slap	Whip Slap	Whip Slap	Whip Slap
F 1	17	F -1		4	Scratch H	Scratch H	Scratch H	Scratch H	Scratch H	Scratch H
F# 1	18	F# -1		4	Scratch L	Scratch L	Scratch L	Scratch L	Scratch L	Scratch L
G 1	19	G -1			Finger Snap	Finger Snap	Finger Snap	Finger Snap	Finger Snap	Finger Snap
G# 1	20	G# -1			Click Noise	Click Noise	Click Noise	Click Noise	Click Noise	Click Noise
A 1	21	A -1			Mtrnm Click	Mtrnm Click	Mtrnm Click	Mtrnm Click	Mtrnm Click	Mtrnm Click
A# 1	22	A# -1			Mtrnm Bell	Mtrnm Bell	Mtrnm Bell	Mtrnm Bell	Mtrnm Bell	Mtrnm Bell
B 1	23	B -1			Seq Click L	Seq Click L	Seq Click L	Seq Click L	Seq Click L	Seq Click L
C 2	24	C 0			Seq Click H	Seq Click H	Seq Click H	Seq Click H	Seq Click H	Seq Click H
C# 2	25	C# 0			Brush Tap	Brush Tap	Brush Tap	Brush Tap	Brush Tap	Brush Tap
D 2	26	D 0	○		Brush Swirl	Brush Swirl	Brush Swirl	Brush Swirl	Brush Swirl	Brush Swirl
D# 2	27	D# 0			Brush Slap	Brush Slap	Brush Slap	Brush Slap	Brush Slap	Brush Slap
E 2	28	E 0	○		BrushTapSwrl	BrushTapSwrl	BrushTapSwrl	BrushTapSwrl	ReversCymbal	ReversCymbal
F 2	29	F 0	○		Snare Roll	Snare Roll 2	Snare Roll	Snare Roll	Snare Roll	Snare Roll
F# 2	30	F# 0			Castanet	Castanet	Castanet	Castanet	Hi Q 2	Hi Q 2
G 2	31	G 0			Snare Soft	Snare Soft 2	Snare Soft	Snare Noisy	SnrSnpylctr	SnareNoisy 4
G# 2	32	G# 0			Sticks	Sticks	Sticks	Sticks	Sticks	Sticks
A 2	33	A 0			Kick Soft	Kick Soft	Kick Soft	Kick Tight 2	Kick 3	Kick Tight 2
A# 2	34	A# 0			OpenRimShot	RimShotHSht	OpenRimShot	OpenRimShot	OpenRimShot	OpenRimShot
B 2	35	B 0			Kick Tight	KickTghtShrt	Kick Tight	Kick 2	Kick Gate	KickAnlgShrt
C 3	36	C 1			Kick	Kick Short	Kick	Kick Gate	KckGateHeavy	Kick Analog
C# 3	37	C# 1			Side Stick	Side Stick	Side Stick	Side Stick	Side Stick	SideStickAn
D 3	38	D 1			Snare	Snare Short	Snare Snappy	Snare Rock	SnareNoisy 2	SnareAnalog
D# 3	39	D# 1			Hand Clap	Hand Clap	Hand Clap	Hand Clap	Hand Clap	Hand Clap
E 3	40	E 1			Snare Tight	SnareTight H	SnrTightSnp	SnareRockRim	SnareNoisy 3	SnareAnalog2
F 3	41	F 1			Floor Tom L	Floor Tom L	Tom Room 1	Tom Rock 1	TomElectro 1	Tom Analog 1
F# 3	42	F# 1		1	Hi-HatClosed	Hi-HatClosed	Hi-HatClosed	Hi-HatClosed	Hi-HatClosed	HatCloseAnlg
G 3	43	G 1			Floor Tom H	Floor Tom H	Tom Room 2	Tom Rock 2	TomElectro 2	Tom Analog 2
G# 3	44	G# 1		1	Hi-Hat Pedal	Hi-Hat Pedal	Hi-Hat Pedal	Hi-Hat Pedal	Hi-Hat Pedal	HatCloseAn 2
A 3	45	A 1			Low Tom	Low Tom	Tom Room 3	Tom Rock 3	TomElectro 3	Tom Analog 3
A# 3	46	A# 1		1	Hi-Hat Open	Hi-Hat Open	Hi-Hat Open	Hi-Hat Open	Hi-Hat Open	HatOpen Anlg
B 3	47	B 1			Mid Tom L	Mid Tom L	Tom Room 4	Tom Rock 4	TomElectro 4	Tom Analog 4
C 4	48	C 2			Mid Tom H	Mid Tom H	Tom Room 5	Tom Rock 5	TomElectro 5	Tom Analog 5
C# 4	49	C# 2			CrashCymbal1	CrashCymbal1	CrashCymbal1	CrashCymbal1	CrashCymbal1	Crash Analog
D 4	50	D 2			High Tom	High Tom	Tom Room 6	Tom Rock 6	TomElectro 6	Tom Analog 6
D# 4	51	D# 2			RideCymbal 1	RideCymbal 1	RideCymbal 1	RideCymbal 1	RideCymbal 1	RideCymbal 1
E 4	52	E 2			Chinese Cym	Chinese Cym	Chinese Cym	Chinese Cym	Chinese Cym	Chinese Cym
F 4	53	F 2			Ride Cym Cup	Ride Cym Cup	Ride Cym Cup	Ride Cym Cup	Ride Cym Cup	Ride Cym Cup
F# 4	54	F# 2			Tambourine	Tambourine	Tambourine	Tambourine	Tambourine	Tambourine
G 4	55	G 2			SplashCymbal	SplashCymbal	SplashCymbal	SplashCymbal	SplashCymbal	SplashCymbal
G# 4	56	G# 2			Cowbell	Cowbell	Cowbell	Cowbell	Cowbell	Cowbell Anlg
A 4	57	A 2			CrashCymbal2	CrashCymbal2	CrashCymbal2	CrashCymbal2	CrashCymbal2	CrashCymbal2
A# 4	58	A# 2			Vibraslap	Vibraslap	Vibraslap	Vibraslap	Vibraslap	Vibraslap
B 4	59	B 2			RideCymbal 2	RideCymbal 2	RideCymbal 2	RideCymbal 2	RideCymbal 2	RideCymbal 2
C 5	60	C 3			Bongo H	Bongo H	Bongo H	Bongo H	Bongo H	Bongo H
C# 5	61	C# 3			Bongo L	Bongo L	Bongo L	Bongo L	Bongo L	Bongo L
D 5	62	D 3			Conga H Mute	Conga H Mute	Conga H Mute	Conga H Mute	Conga H Mute	Conga Anlg H
D# 5	63	D# 3			Conga H Open	Conga H Open	Conga H Open	Conga H Open	Conga H Open	Conga Anlg M
E 5	64	E 3			Conga L	Conga L	Conga L	Conga L	Conga L	Conga Anlg L
F 5	65	F 3			Timbale H	Timbale H	Timbale H	Timbale H	Timbale H	Timbale H
F# 5	66	F# 3			Timbale L	Timbale L	Timbale L	Timbale L	Timbale L	Timbale L
G 5	67	G 3			Agogo H	Agogo H	Agogo H	Agogo H	Agogo H	Agogo H
G# 5	68	G# 3			Agogo L	Agogo L	Agogo L	Agogo L	Agogo L	Agogo L
A 5	69	A 3			Cabasa	Cabasa	Cabasa	Cabasa	Cabasa	Cabasa
A# 5	70	A# 3			Maracas	Maracas	Maracas	Maracas	Maracas	Maracas 2
B 5	71	B 3	○		SambaWhistlH	SambaWhistlH	SambaWhistlH	SambaWhistlH	SambaWhistlH	SambaWhistlH
C 6	72	C 4	○		SambaWhistlL	SambaWhistlL	SambaWhistlL	SambaWhistlL	SambaWhistlL	SambaWhistlL
C# 6	73	C# 4			Guiro Short	Guiro Short	Guiro Short	Guiro Short	Guiro Short	Guiro Short
D 6	74	D 4	○		Guiro Long	Guiro Long	Guiro Long	Guiro Long	Guiro Long	Guiro Long
D# 6	75	D# 4			Claves	Claves	Claves	Claves	Claves	Claves 2
E 6	76	E 4			Wood Block H	Wood Block H	Wood Block H	Wood Block H	Wood Block H	Wood Block H
F 6	77	F 4			Wood Block L	Wood Block L	Wood Block L	Wood Block L	Wood Block L	Wood Block L
F# 6	78	F# 4			Cuica Mute	Cuica Mute	Cuica Mute	Cuica Mute	Scratch H 2	Scratch H 2
G 6	79	G 4			Cuica Open	Cuica Open	Cuica Open	Cuica Open	Scratch L 2	Scratch L 3
G# 6	80	G# 4		2	TriangleMute	TriangleMute	TriangleMute	TriangleMute	TriangleMute	TriangleMute
A 6	81	A 4		2	TriangleOpen	TriangleOpen	TriangleOpen	TriangleOpen	TriangleOpen	TriangleOpen
A# 6	82	A# 4			Shaker	Shaker	Shaker	Shaker	Shaker	Shaker
B 6	83	B 4			Jingle Bells	Jingle Bells	Jingle Bells	Jingle Bells	Jingle Bells	Jingle Bells
C 7	84	C 5			Bell Tree	Bell Tree	Bell Tree	Bell Tree	Bell Tree	Bell Tree
-	85	C# 5								
-	86	D 5								
-	87	D# 5								
-	88	E 5								
-	89	F 5								
-	90	F# 5								
-	91	G 5								

- Key Off: Keys marked "○" stop sounding the instant they are released.
- Alternate Assign: Playing any instrument within a numbered group will immediately stop the sound of any other instrument in the same group of the same number.

- Key Off: Durch "○" gekennzeichnete Klänge verstummen beim Loslassen der Taste.
- Alternate Assign: Mit derselben Nummer gekennzeichnete Klänge werden von demselben Instrument erzeugt und können daher nicht gleichzeitig produziert werden. Spielt einer dieser Klänge gerade, wird er beim Anschlagen einer anderen Taste mit derselben "Alternate Assign"-Nummer stummgeschaltet.

Schlagzeugklänge / touche du clavier /

Bank Select MSB				127	127	127	127	126	126	
Bank Select LSB				0	0	0	0	0	0	
Program # (1-128)				28	33	41	49	1	2	
Keyboard Note	MIDI		Key off	Alternate assign	Dance Kit	Jazz Kit	Brush Kit	Symphony Kit	SFX Kit 1	SFX Kit 2
	Note #	Note								
C# 1	13	C# -1		3	Surdo Mute	Surdo Mute	Surdo Mute	Surdo Mute		
D 1	14	D -1		3	Surdo Open	Surdo Open	Surdo Open	Surdo Open		
D# 1	15	D# -1			Hi Q	Hi Q	Hi Q	Hi Q		
E 1	16	E -1			Whip Slap	Whip Slap	Whip Slap	Whip Slap		
F 1	17	F -1		4	Scratch H	Scratch H	Scratch H	Scratch H		
F# 1	18	F# -1		4	Scratch L	Scratch L	Scratch L	Scratch L		
G 1	19	G -1			Finger Snap	Finger Snap	Finger Snap	Finger Snap		
G# 1	20	G# -1			Click Noise	Click Noise	Click Noise	Click Noise		
A 1	21	A -1			Mtrnm Click	Mtrnm Click	Mtrnm Click	Mtrnm Click		
A# 1	22	A# -1			Mtrnm Bell	Mtrnm Bell	Mtrnm Bell	Mtrnm Bell		
B 1	23	B -1			Seq Click L	Seq Click L	Seq Click L	Seq Click L		
C 2	24	C 0			Seq Click H	Seq Click H	Seq Click H	Seq Click H		
C# 2	25	C# 0			Brush Tap	Brush Tap	Brush Tap	Brush Tap		
D 2	26	D 0	○		Brush Swirl	Brush Swirl	Brush Swirl	Brush Swirl		
D# 2	27	D# 0			Brush Slap	Brush Slap	Brush Slap	Brush Slap		
E 2	28	E 0	○		ReversCymbal	BrushTapSwrl	BrushTapSwrl	BrushTapSwrl		
F 2	29	F 0	○		Snare Roll	Snare Roll	Snare Roll	Snare Roll		
F# 2	30	F# 0			Hi Q 2	Castanet	Castanet	Castanet		
G 2	31	G 0			SnareTechno3	Snare Soft	Brush Slap 2	Brush Slap 2		
G# 2	32	G# 0			Sticks	Sticks	Sticks	Sticks		
A 2	33	A 0			KickTechno Q	Kick Soft	Kick Soft	Kick Soft 2		
A# 2	34	A# 0			Rim Gate	OpenRimShot	OpenRimShot	OpenRimShot		
B 2	35	B 0			KickTechno L	Kick Tight	Kick Tight	Gran Cassa		
C 3	36	C 1			KickTechno 2	Kick Jazz	Kick Small	GranCassa Mu	CuttingNoiz	Phone Call
C# 3	37	C# 1			SideStickAn	Side Stick	Side Stick	CuttingNoiz2		Door Squeak
D 3	38	D 1			Snare Clap	Snare	Brush Slap 3	Band Snare		Door Slam
D# 3	39	D# 1			Hand Clap	Hand Clap	Hand Clap	String Slap		Scratch Cut
E 3	40	E 1			Snare Dry 2	Snare Tight	Brush Tap 2	Band Snare 2		Scratch H 3
F 3	41	F 1			Tom Analog 1	Tom Jazz 1	Tom Brush 1	Tom Jazz 1		Wind Chime
F# 3	42	F# 1		1	HiHatClose 3	Hi-HatClosed	Hi-HatClosed	Hi-HatClosed		Telephone 2
G 3	43	G 1			Tom Analog 2	Tom Jazz 2	Tom Brush 2	Tom Jazz 2		
G# 3	44	G# 1		1	HatCloseAn 2	Hi-Hat Pedal	Hi-Hat Pedal	Hi-Hat Pedal		
A 3	45	A 1			Tom Analog 3	Tom Jazz 3	Tom Brush 3	Tom Jazz 3		
A# 3	46	A# 1		1	HiHat Open 3	Hi-Hat Open	Hi-Hat Open	Hi-Hat Open		
B 3	47	B 1			Tom Analog 4	Tom Jazz 4	Tom Brush 4	Tom Jazz 4		
C 4	48	C 2			Tom Analog 5	Tom Jazz 5	Tom Brush 5	Tom Jazz 5		
C# 4	49	C# 2			Crash Analog	CrashCymbal1	CrashCymbal1	Hand Cymbal		
D 4	50	D 2			Tom Analog 6	Tom Jazz 6	Tom Brush 6	Tom Jazz 6		
D# 4	51	D# 2			RideCymbal 1	RideCymbal 1	RideCymbal 1	HandCymShort		
E 4	52	E 2			Chinese Cym	Chinese Cym	Chinese Cym	Chinese Cym	Fl.Key Click	Ignition
F 4	53	F 2			Ride Cym Cup	Ride Cym Cup	Ride Cym Cup	Ride Cym Cup		Squeal
F# 4	54	F# 2			Tambourine	Tambourine	Tambourine	Tambourine		Exhaust
G 4	55	G 2			SplashCymbal	SplashCymbal	SplashCymbal	SplashCymbal		Crash
G# 4	56	G# 2			Cowbell Anlg	Cowbell	Cowbell	Cowbell		Siren
A 4	57	A 2			CrashCymbal2	CrashCymbal2	CrashCymbal2	HandCymbal 2		Train
A# 4	58	A# 2			Vibraslap	Vibraslap	Vibraslap	Vibraslap		Jet Plane
B 4	59	B 2			RideCymbal 2	RideCymbal 2	RideCymbal 2	HandCym2Shrt		Starship
C 5	60	C 3			Bongo H	Bongo H	Bongo H	Bongo H		Burst
C# 5	61	C# 3			Bongo L	Bongo L	Bongo L	Bongo L		Coaster
D 5	62	D 3			Conga Anlg H	Conga H Mute	Conga H Mute	Conga H Mute		Submarine
D# 5	63	D# 3			Conga Anlg M	Conga H Open	Conga H Open	Conga H Open		
E 5	64	E 3			Conga Anlg L	Conga L	Conga L	Conga L		
F 5	65	F 3			Timbale H	Timbale H	Timbale H	Timbale H		
F# 5	66	F# 3			Timbale L	Timbale L	Timbale L	Timbale L		
G 5	67	G 3			Agogo H	Agogo H	Agogo H	Agogo H		
G# 5	68	G# 3			Agogo L	Agogo L	Agogo L	Agogo L	Shower	Laugh
A 5	69	A 3			Cabasa	Cabasa	Cabasa	Cabasa	Thunder	Scream
A# 5	70	A# 3			Maracas 2	Maracas	Maracas	Maracas	Wind	Punch
B 5	71	B 3	○		SambaWhistlH	SambaWhistlH	SambaWhistlH	SambaWhistlH	Stream	Heartbeat
C 6	72	C 4	○		SambaWhistlL	SambaWhistlL	SambaWhistlL	SambaWhistlL	Bubble	Footsteps
C# 6	73	C# 4			Guiro Short	Guiro Short	Guiro Short	Guiro Short	Feed	
D 6	74	D 4	○		Guiro Long	Guiro Long	Guiro Long	Guiro Long		
D# 6	75	D# 4			Claves 2	Claves	Claves	Claves		
E 6	76	E 4			Wood Block H	Wood Block H	Wood Block H	Wood Block H		
F 6	77	F 4			Wood Block L	Wood Block L	Wood Block L	Wood Block L		
F# 6	78	F# 4			Scratch H 2	Cuica Mute	Cuica Mute	Cuica Mute		
G 6	79	G 4			Scratch L 3	Cuica Open	Cuica Open	Cuica Open		
G# 6	80	G# 4		2	TriangleMute	TriangleMute	TriangleMute	TriangleMute		
A 6	81	A 4		2	TriangleOpen	TriangleOpen	TriangleOpen	TriangleOpen		
A# 6	82	A# 4			Shaker	Shaker	Shaker	Shaker		
B 6	83	B 4			Jingle Bells	Jingle Bells	Jingle Bells	Jingle Bells		
C 7	84	C 5			Bell Tree	Bell Tree	Bell Tree	Bell Tree	Dog	Machine Gun
-	85	C# 5							Horse	Laser Gun
-	86	D 5							Bird Tweet 2	Explosion
-	87	D# 5								Firework
-	88	E 5								
-	89	F 5								
-	90	F# 5							Ghost	
-	91	G 5							Maou	

- **Key off :** Le son produit par les touches marquées "○" cesse à l'instant où la touche est relâchée.
- **Alternate Assign :** Le fait de jouer un instrument appartenant à un groupe ayant un numéro arrête immédiatement le son de tout autre instrument appartenant à un groupe ayant le même numéro.

- **Key Off:** Las teclas marcadas con "○" dejan de sonar en el momento en que se sueltan.
- **Alternate Assign:** Al tocar algún instrumento con un grupo numerado detendrá inmediatamente el sonido de cualquier otro instrumento del mismo grupo con el mismo número.

Style List / Style-Verzeichnis / Liste des styles / Lista de estilos



Category	Style Name
POP	8Beat Pop 1
	8Beat Pop 2
	8Beat Standard
	8Beat Medium
	8Beat Ballad
	Piano Ballad
	Pop Ballad 1
	Pop Ballad 2
	Organ Ballad
	New Age
16BEAT	16Beat Pop
	16Beat Shuffle 1
	16Beat Shuffle 2
	16Beat Ballad 1
	16Beat Ballad 2
	16Beat Ballad 3
	Fusion
	Fusion Ballad
	Funk 1
	Funk 2
	DANCE POP
Dance Pop 2	
Techno	
Eurobeat	
Synth Boogie	
70s Disco	
Tropical	
Party Pop	
Jungle	
ROCK	
	16Beat Rock
	8Beat Uptempo
	Rock Shuffle
	Pop Shuffle
	Rhythm & Blues
	Soul
	Gospel Shuffle
	Rock & Roll
	Twist
	BALLAD
Slow Rock 2	
6/8 Ballad	
Jazz Ballad	
Orchestral Jazz Ballad	
Rock Ballad	
Soul Ballad	
6/8 Gospel	
Blues	
Enka	

Category	Style Name	
JAZZ	Swing	
	Big Band Swing	
	Big Band Ballad	
	Jazz Quartet	
	Cool Jazz	
	Dixieland	
	Boogie	
	Bebop	
	Jazz Rock	
	BALLROOM	Foxtrot
		Jive
		Big Band Quickstep
		Cha Cha
Rhumba		
Tango Continental		
Mambo		
Beguine		
LATIN POP		Bossa Nova 1
		Bossa Nova 2
	Bossa Nova 3	
	Salsa	
	Samba	
	Jazz Samba	
	Reggae	
	Pop Reggae	
	TRADITIONAL	March 1
March 2		
6/8 March		
Polka		
Ragtime		
Showtune		
Showtime		
COUNTRY		Bluegrass 1
	Bluegrass 2	
	Country Rock	
	Country Shuffle	
	8Beat Country	
	Light Pop	
	Folkrock	
	Country Ballad	
	Cowboy Boogie	
	Country 2Step	
	WALTZ	Standard Waltz
Traditional Waltz		
Pop Waltz		
Jazz Waltz		
Big Band Waltz		
Viennese Waltz		
Musette Waltz		
Country T. Waltz		
Country Waltz		

● Pianist Style List / Pianist-Style-Verzeichnis / Liste des styles Pianiste / Lista de estilos de pianista

Piano Ballad
Swing1
March
Arpeggio1
Samba
Rock & Roll
80's Pop
6/8 March
Pop Ballad
Petit Waltz
Jazz Ballad
Swing2
Ragtime1
Arpeggio2
Bossa Nova
Honky Tonk
Tight Rock
Ragtime2
Rock Piano
Jazz Waltz
16beatBallad
2beat
Musical
Arpeggio3
Rhumba
BoogieWoogie
Dance Pop
Fanfare
Arpeggio4
Minuet
Rocca Ballad
Old Jazz
Galop
Like Harp
Beguine
16beat Rock
8beat
Cha Cha
Like Swan
Birthday



Parameter Chart / Parameterübersicht / Tableau des paramètres / Gráfica de parámetros

Group	Parameters	Basic Setting	One Touch Setting Parameters	Registration Parameters (Freeze Parameters)	Registration All Setup (*1)	Backup Group	Recall Group	
VOICE	First voice name *2	Grand Piano	○	VOICE SETTING	○	VOICE SETTING	VOICES ETTING	
	Octave Shift of first voice	0	○	VOICE SETTING	○	VOICE SETTING	VOICES ETTING	
	Voice selected on each group	First voice of a voice group	○	VOICE SETTING	○	VOICE SETTING	VOICES ETTING	
DUAL	Dual ON/OFF	OFF	—	—	○	VOICE SETTING	VOICES ETTING	
	Second voice name	Strings Slow 1	○	VOICE SETTING	○	VOICE SETTING	VOICES ETTING	
	Octave Shift of second voice	0	○	VOICE SETTING	○	VOICE SETTING	VOICES ETTING	
	Detune Depth	5	○	VOICE SETTING	○	VOICE SETTING	VOICES ETTING	
	Dual Volume Balance	Equal level	○	VOICE SETTING	○	VOICE SETTING	VOICES ETTING	
SPLIT	Split ON/OFF	OFF	○	VOICE SETTING	○	VOICE SETTING	VOICES ETTING	
	Left range voice name	Acous.Bass 1	○	VOICE SETTING	○	VOICE SETTING	VOICES ETTING	
	Octave Shift of left range voice	0	○	VOICE SETTING	○	VOICE SETTING	VOICES ETTING	
	Split Volume Balance	Equal level	○	VOICE SETTING	○	VOICE SETTING	VOICES ETTING	
	Split Point	F#2	—	VOICE SETTING	○	VOICE SETTING	VOICES ETTING	
ORGAN COMBINATION	Six types of Organ settings.	Initial data	—	—	—	VOICE SETTING	VOICE SETTING	
REVERB	Reverb ON/OFF	Differs depending on the voice	○	REVERB/EFFECT	○	REVERB/EFFECT	REVERB/EFFECT	
	Reverb Type	Differs depending on the style	○	REVERB/EFFECT	○	REVERB/EFFECT	REVERB/EFFECT	
	Reverb Total Depth	50	○	REVERB/EFFECT	○	REVERB/EFFECT	REVERB/EFFECT	
	Reverb Part Depth (BASS, CHORD, RHYTHM, KBD, MIC.)	50	○	REVERB/EFFECT	○	REVERB/EFFECT	REVERB/EFFECT	
EFFECT	Effect ON/OFF	Differs depending on the voice	○	REVERB/EFFECT	○	REVERB/EFFECT	REVERB/EFFECT	
	Effect Type	Differs depending on the voice	○	REVERB/EFFECT	○	REVERB/EFFECT	REVERB/EFFECT	
	Effect Depth (R1,R2, L)	Differs depending on the voice	○	REVERB/EFFECT	○	REVERB/EFFECT	REVERB/EFFECT	
	Effect Depth (MIC.)	0	○	REVERB/EFFECT	○	REVERB/EFFECT	REVERB/EFFECT	
MASTER EQUALIZER	Equalizer Type	FLAT	○	VOICE SETTING	○	VOICE SETTING	VOICES ETTING	
POWER BASS (CVP-98 only)	Power Bass ON/OFF	OFF	—	—	○	VOICE SETTING	VOICES ETTING	
	Power Bass Volume	6	—	—	○	VOICE SETTING	VOICES ETTING	
REGISTRATION	Regist Freeze ON/OFF	OFF	—	—	—	REGISTRATION	REGISTRATION	
	Freeze Parameters ON/OFF (VOICE SETTING, REVERB/EFFECT, TUNE, PEDAL)	OFF	—	—	—	REGISTRATION	REGISTRATION	
	Freeze Parameters ON/OFF (ACMP SETTING)	ON	—	—	—	REGISTRATION	REGISTRATION	
	Memorized Parameters of all 20 Registrations	Initial data	—	—	—	REGISTRATION	REGISTRATION	
MIXER	Registration Name	REGIST A-1 — E-4	—	—	—	REGISTRATION	REGISTRATION	
	Mixer Part Volume (BASS, CHORD, PAD, PHRASE, RHYTHM)	90	○	ACMP SETTING	○	ACMP SETTING	ACMP SETTING	
	Mixer Part Volume (HARMONY)	90	○	ACMP SETTING	○	ACMP SETTING	ACMP SETTING	
STYLE	Mixer Part Volume (KBD)	100	○	VOICE SETTING	○	VOICE SETTING	VOICES ETTING	
	Style Name	8 Beat Pop 1	○	ACMP SETTING	○	ACMP SETTING	ACMP SETTING	
	Style selected on each group	First style of a style group	—	—	○	ACMP SETTING	ACMP SETTING	
	MAIN A/B setting	MAIN A	○	ACMP SETTING	○	ACMP SETTING	—	
	Auto Accompaniment ON/OFF	OFF	○	ACMP SETTING	○	ACMP SETTING	ACMP SETTING	
	Auto Accompaniment type	MULTI FINGER	—	ACMP SETTING	○	ACMP SETTING	ACMP SETTING	
	SMALL ACMP ON/OFF	OFF	○	ACMP SETTING	○	ACMP SETTING	ACMP SETTING	
	Virtual Arranger ON/OFF	ON	○	ACMP SETTING	○	ACMP SETTING	ACMP SETTING	
	Harmony ON/OFF	OFF	○	ACMP SETTING	○	ACMP SETTING	ACMP SETTING	
	Harmony type	Trio	○	ACMP SETTING	○	ACMP SETTING	ACMP SETTING	
METRONOME	Metronome type	NORMAL	—	—	○	ACMP SETTING	ACMP SETTING	
	Metronome volume	50	—	—	○	ACMP SETTING	ACMP SETTING	
SONG	Guide mode	NORMAL	—	—	○	SONG SETTING	SONG SETTING	
	Guide Repeat number	3	—	—	○	SONG SETTING	SONG SETTING	
	Piano Roll display	AUTO	—	—	○	SONG SETTING	SONG SETTING	
	Lyric Display ON/OFF	ON	—	—	○	SONG SETTING	SONG SETTING	
HELP FUNCTION	Help language	ENGLISH	—	—	—	Always set to BACKUP	—	
FUNCTION	Tune	440.0 Hz	—	—	○	TUNE	TUNE	
	Transpose	0	—	VOICE SETTING	○	VOICE SETTING	VOICE SETTING	
	Effect setting	AUTO	—	—	○	REVERB/EFFECT	REVERB/EFFECT	
	Key Touch	NORMAL	—	VOICE SETTING	○	VOICE SETTING	VOICE SETTING	
	Volume when [FIXED] is selected	76	—	VOICE SETTING	○	VOICE SETTING	VOICE SETTING	
	Pan (LEFT, RIGHT1, RIGHT2) settings	CENTER	—	VOICE SETTING	○	VOICE SETTING	VOICE SETTING	
	Left pedal setting	SOFT	—	PEDAL	○	PEDAL	PEDAL	
	Damper range	R	—	PEDAL	○	PEDAL	PEDAL	
	Damper mode	CONT.	—	PEDAL	○	PEDAL	PEDAL	
	Soundboard depth (CVP-98 only)	50	—	—	○	VOICE SETTING	VOICE SETTING	
	Transmission channel of left range voice	3	—	—	○	MIDI SETTING	MIDI SETTING	
	Transmission channel of first voice	1	—	—	○	MIDI SETTING	MIDI SETTING	
	Transmission channel of second voice	2	—	—	○	MIDI SETTING	MIDI SETTING	
	Local Control ON/OFF	ON	—	—	○	MIDI SETTING	MIDI SETTING	
	Sync. setting	INT.	—	—	○	MIDI SETTING	MIDI SETTING	
	Program receive/send ON/OFF	Tx&Rx	—	—	○	MIDI SETTING	MIDI SETTING	
	Control receive/send ON/OFF	Tx&Rx	—	—	○	MIDI SETTING	MIDI SETTING	
	System Exclusive receive/send ON/OFF	Tx&Rx	—	—	○	MIDI SETTING	MIDI SETTING	
	Start/Stop receive/send ON/OFF	Tx&Rx	—	—	○	MIDI SETTING	MIDI SETTING	
	MIDI transpose receive ON/OFF	ON	—	—	○	MIDI SETTING	MIDI SETTING	
	Auto Accompaniment and rhythm send ON/OFF	OFF	—	—	○	MIDI SETTING	MIDI SETTING	
	Harmony send ON/OFF	OFF	—	—	○	MIDI SETTING	MIDI SETTING	
	Remote Keyboard	OFF	—	—	○	MIDI SETTING	MIDI SETTING	
	Micro Tuning ON/OFF	OFF	—	—	○	TUNE	TUNE	
	Micro Tuning parameter settings	0	—	—	○	TUNE	TUNE	
	Scale Tuning setting	PRESET	—	TUNE	○	TUNE	TUNE	
	Preset Scale setting	EQUAL	—	TUNE	○	TUNE	TUNE	
	Basic key of Preset Scale	C	—	TUNE	○	TUNE	TUNE	
	User Scale parameter setting	0	—	TUNE	○	TUNE	TUNE	
	Backup parameter ON/OFF settings	Differs depending on each parameter (*3)	—	—	—	—	Always set to BACKUP	—
	Pop-up Time (VOICE/STYLE)	15	—	—	○	UTILITY	UTILITY	
	Pop-up Time (OTHERS)	8	—	—	○	UTILITY	UTILITY	
	Alert Voice	STEEL DRUMS	—	—	○	UTILITY	UTILITY	
	Alert Volume	50	—	—	○	UTILITY	UTILITY	

*1 These are the [ALL SETUP] parameters in the FUNCTION [REGISTRATION] page (display page 7).

*2 When an Organ Combination voice is selected, the edited settings are also included.

*3 REGISTRATION, UTILITY are set to ON, and others are set to OFF.

*1 Ce sont les paramètres de [ALL SETUP] dans la page FONCTION [REGISTRATION] (page 7 de l'afficheur).

*2 Quand vous sélectionnez une voix de combinaison d'orgues, les réglages édités sont également inclus.

*3 REGISTRATION, UTILITY sont activés et les autres désactivés.

*1 Dies sind die [ALL SETUP]-Parameter auf der FUNCTION [REGISTRATION]-Anzeigeseite (Nr. 7).

*2 Wenn eine ORGAN COMBINATION-Stimme gewählt ist, sind die bearbeiteten Einstellungen ebenfalls eingeschlossen.

*3 REGISTRATION und UTILITY sind auf "BACKUP ON" (Speichererhalt EIN) gesetzt, alle anderen sind OFF (kein Speichererhalt).

*1 Etos son los parámetros de [ALL SETUP] de la página [REGISTRATION] de FUNCTION (página 7 de la visualización).

*2 Cuando se selecciona una voz de combinación de órgano, los ajustes editados también se incluyen.

*3 REGISTRATION y UTILITY se activan (ON) y los demás se desactivan (OFF).

Fingering Chart / Akkordliste / Tablature / Gráfica de digitado



* All fingerings shown are simple root-position types.
 * Die hier gezeigten Akkorde sind jeweils die Grundakkorde.
 * Tous les doigtés indiqués sont du type à position fondamentale simple.
 * Todos los digitados se muestran como tipos de posición de raíz sencilla.

Example for "C" chords Beispiele für "C"-Akkorde Exemples d'accords en "C" Ejemplo de acordes "C"

C	C6	CM7	CM7 (b5)	CM7 (#11)
Cadd9	CM7 (9)	C6 (9)	C (b5)	Caug
C7 (#5)	CM7 (#5)	Cm	Cm6	Cm7
Cm7 (b5)	Cmadd9	Cm7 (9)	Cm7 (11)	CmM7 (b5)
CmM7	CmM7 (9)	Cm (b5)	Cdim7	C7
C7sus4	C7 (9)	C7 (#11)	C7 (13)	C7 (b5)
C7 (b9)	C7 (b13)	C7 (#9)	Csus4	



Specifications / Technische Daten / Spécifications / Especificaciones



	CVP-98	CVP-96	CVP-600
KEYBOARD	88 keys (A-1 — C7)		
TONE GENERATOR	AWM (Advanced Wave Memory)		
MAXIMUM SIMULTANEOUS POLYPHONY	128	64	
VOICES	Clavinova voices: 133 ; XG voices: 480 ; Drum Kits: 12 sets Voice Groups: Piano, Electric Piano, Vibraphone, Guitar, Clavinova Tone/Synth, Organ, Strings/Choir, Brass, Sax/Flute, Bass, Drums, XG Organ Combination, Dual/Split		
EFFECTS	Effect (25 types), Reverb (16 types)		
TONE CONTROLS	Master Equalizer, Power Bass (CVP-98 only)		
ACCOMPANIMENT STYLES	Accompaniment Styles: 100; Pianist Styles: 40 Style Groups: Pop, 16 Beat, Dance Pop, Rock, Ballad, Jazz, Ballroom, Latin Pop, Traditional, Country, Waltz Disk/Custom Pianist Controls: Start/Stop, Syncro, Tap, Intro, Main A, Main B, Auto-fill, Ending, Fade in/out buttons Metronome, Tempo +/- buttons		
AUTO ACCOMPANIMENT	Single Finger, Multi Finger, Fingered, Full Keyboard Harmony, Pianist, One Touch Setting, Virtual Arranger, Synchro Stop, Small ACMP, Chord Assist, Individual Part Volume Control (Mixer)		
REGISTRATION	Bank A - E x 4 memory locations (20), Freeze		
SONG PLAY MODE	Song Playback, Repeat, Volume control of individual Parts (Mixer) Controls: Song, Play/Stop, Rewind, Fast forward, Pause Guide Control: Easy Play, Next Note, Sound Repeat Lyric Disply		
SONG RECORD MODE	Quick Recording, Track Recording, Chord Sequence, Song Name, Track Edit, Initial Edit		
LCD/CONTROLS	320 x 240 dot liquid crystal display, Contrast dial, Beat lamp, Function button, Mixer button, Page ◀ ▶ buttons, Display hold button, LCD buttons, data dial, +/- buttons, Exit button		
VOLUME CONTROLS	Master volume, ACMP/Song volume		
DEMO/HELP	27 Demo Songs; 5 help languages (English, Japanese, German, French, Spanish)		
DISK DRIVE	3.5-inch micro floppy disk drive		
PEDAL CONTROLS	RIGHT	Damper	
	CENTER	Sostenuto	
	LEFT	Soft, Start/Stop, Harmony On/Off, Registration+, Main A, Main B, Ending/Rit, Break, Fade In/Out	
JACKS AND TERMINALS	Headphone jacks x 2, AUX OUT jacks (L/L+R, R), AUX IN jacks (L/L+R, R), EXP.PEDAL jack, MIC. jack, TO HOST terminal, MIDI terminals (IN, OUT, THRU)		
INPUT/OUTPUT SPECIFICATIONS	AUX OUT: Output Impedance: 600 Ω AUX IN: Input Impedance: 10 kΩ; Input Sensitivity: -10 dBm		
MAIN AMPLIFIERS	240 W (60 W x 4)	120 W (60 W x 2)	
SPEAKERS	16 cm x 2, 14 cm x 2, 2.5 cm x 2, 5 cm x 2	16 cm x 2, 5 cm x 4	
DIMENSIONS (W x D x H)	Music stand down		Lid down
	1415 mm x 603 mm x 890 mm (55-3/4" x 23-3/4" x 35")	1415 mm x 603 mm x 890 mm (55-3/4" x 23-3/4" x 35")	1417 mm x 870 mm x 908 mm (55-3/4" x 34-1/4" x 35-3/4")
	Music stand up		Lid up
	1415 mm x 603 mm x 1055 mm (55-3/4" x 23-3/4" x 41-1/2")	1415 mm x 603 mm x 1050 mm (55-3/4" x 23-3/4" x 41-3/8")	1417 mm x 870 mm x 1253 mm (55-3/4" x 34-1/4" x 49-3/8")
WEIGHT	69.5 kg (153 lbs., 4 oz.)	66.0 kg (145 lbs., 8 oz.)	84.0 kg (185 lbs., 3 oz.)

• Specifications and descriptions in this owner's manual are for information purposes only. Yamaha Corp. reserves the right to change or modify products or specifications at any time without prior notice. Since specifications, equipment or options may not be the same in every locale, please check with your Yamaha dealer.

• Die technischen Daten und Beschreibungen in dieser Bedienungsanleitung dienen nur der Information. Yamaha Corp. behält sich das Recht vor, Produkte oder deren technische Daten jederzeit ohne vorherige Ankündigung zu verändern oder zu modifizieren. Da die technischen Daten, das Gerät selbst oder Sonderzubehör nicht in jedem Land gleich sind, setzen Sie sich im Zweifel bitte mit Ihrem Yamaha-Händler in Verbindung.

• Les caractéristiques techniques et les descriptions du mode d'emploi ne sont données que pour information. Yamaha Corp. se réserve le droit de changer ou modifier les produits et leurs caractéristiques techniques à tout moment sans aucun avis. Du fait que les caractéristiques techniques, les équipements et les options peuvent différer d'un pays à l'autre, adressez-vous au distributeur Yamaha le plus proche.

• Las especificaciones y descripciones de este manual del propietario tienen sólo el propósito de servir como información. Yamaha Corp. se reserva el derecho a efectuar cambios o modificaciones en los productos o especificaciones en cualquier momento sin previo aviso. Puesto que las especificaciones, equipos u opciones pueden no ser las mismas en todos los mercados, solicite información a su distribuidor Yamaha.

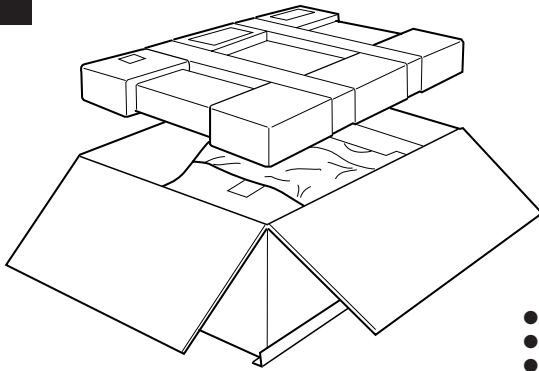
1

5 x 20 mm long screws
Lange Schrauben
(5 x 20 mm)
Vis longue 5 x 20 mm
Tornillos largos de 5 x 20 mm

x 20

● Cord holders
● Kabelhalter
● Serre-câble
● Soportes de cable

x 2

● AC power cord
● Netzkabel
● Cordon d'alimentation
● Cable de alimentación de CA

● Front leg **A**
● Vorderes Standbein **A**
● Pied avant **A**
● Pata frontal **A**

● Front leg **B**
● Vorderes Standbein **B**
● Pied avant **B**
● Pata frontal **B**

● Rear leg **C**
● Hinteres Standbein **C**
● Pied arrière **C**
● Pata trasera **C**

● Pedal box **D**
● Pedalkasten **D**
● Pédalier **D**
● Caja de pedales **D**

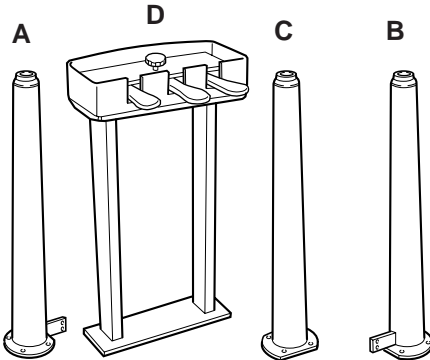

CVP-600: Assembly

- NOTE**
- Be careful not to confuse parts, and be sure to install all parts in the correct direction. Please assemble in accordance with the sequence given below.
 - Assembly should be carried out by at least two persons.
 - Be sure to use the correct screw size, as indicated above. Use of incorrect screws can cause damage.
 - Be sure to tighten up all screws upon completing assembly of each unit.
 - The entire package must be turned over during assembly, so select an area that is large enough for the unpacking and assembly operation.

1 Open the carton and remove the parts from the upper level.

Referring to the illustration, make sure that you have all the required parts.

- NOTE**
- A bench may be supplied or optional, depending on the location in which the instrument was purchased.

2 Attach the three legs (A, B, C).

Use scissors or a cutter to remove the packing material in which the main unit is wrapped. Then attach the legs to the bottom of the main unit using four 5 x 20 mm long screws per leg. Please refer to the illustration carefully when attaching the legs, to ensure that the positions of the (A) and (B) legs are not reversed. Also make sure that there is minimum space between the (A) and (B) leg flanges and the metal frame on the bottom of the main unit (the screws which attach the legs to this frame will be installed later, in step **6**).

CVP-600: Zusammenbau

- NOTIZ**
- Achten Sie darauf, die Teile nicht zu verwechseln, und installieren Sie alle Teile in der richtigen Ausrichtung. Gehen Sie beim Zusammenbau bitte in der angegebenen Reihenfolge vor.
 - Die Montage sollte von mindestens zwei Personen vorgenommen werden.
 - Achten Sie darauf, die richtige Schraubengröße zu verwenden, wie es oben gezeigt ist. Die Verwendung der falschen Schrauben kann zu Schäden führen.
 - Achten Sie während der Montage darauf, bei jedem Arbeitsgang alle Schrauben festzuziehen.
 - Das Instrument wird im Karton zusammengebaut und muß abschließend zum Aufstellen umgedreht werden. Achten Sie darauf, daß ausreichend Platz zum Auspacken und Aufstellen vorhanden ist.

1 Den Karton öffnen und die Teile der obersten Lage herausnehmen.

Prüfen Sie anhand der Abbildung, ob die Teile vollständig vorhanden sind.

- NOTIZ**
- Je nach Vertriebsland wird eine Sitzbank entweder standardmäßig mitgeliefert oder ist als Sonderzubehör erhältlich.

2 Die drei Standbeine (A, B und C) montieren.

Entfernen Sie das Verpackungsmaterial an der Unterseite des Instruments mit einer Schere oder einem anderen Schneidwerkzeug. Schrauben Sie dann die drei Standbeine mit jeweils vier langen Schrauben (5 x 20 mm) an das Instrument. Richten Sie sich bei der Montage der Standbeine bitte nach der Abbildung — die vorderen Standbeine (A und B) dürfen nicht vertauscht werden. Achten Sie auch darauf, daß zwischen den Ansätzen an den vorderen Standbeinen (A und B) und dem Metallrahmen an der Unterseite des Instruments ein möglichst kleiner Zwischenraum verbleibt (die Standbeine werden an späterer Stelle, in Schritt **6**, mit diesem Rahmen verschraubt).

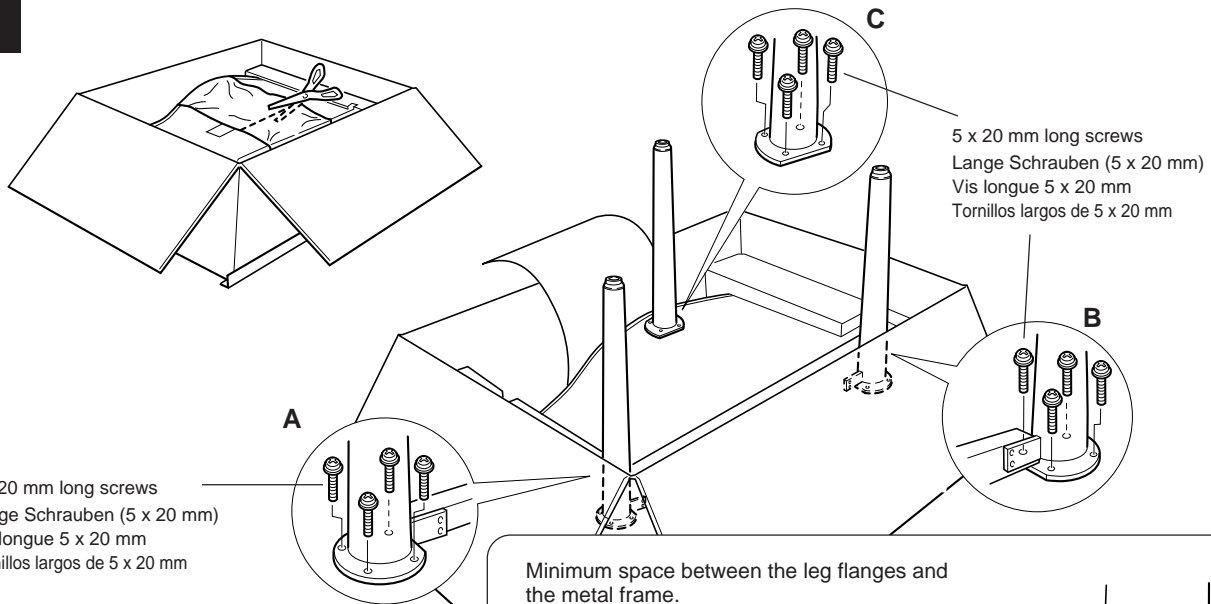
2

5 x 20 mm long screws
Lange Schrauben (5 x 20 mm)
Vis longue 5 x 20 mm
Tornillos largos de 5 x 20 mm

5 x 20 mm long screws
Lange Schrauben (5 x 20 mm)
Vis longue 5 x 20 mm
Tornillos largos de 5 x 20 mm

Minimum space between the leg flanges and the metal frame.

Minimaler Zwischenraum zwischen Ansatz und Metallrahmen.

Espace minimum entre les collerettes de pieds et le châssis métallique.

Espacio mínimo entre las bridas de las patas y el bastidor metálico.

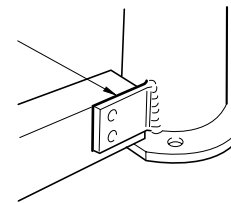

CVP-600: Montage

- NOTE**
- Veiller à ne pas mélanger les pièces et à les installer dans le sens correct. Veuillez assembler l'instrument dans l'ordre indiqué ci-dessous.
 - La présence de deux personnes minimum est nécessaire pour procéder au montage.
 - Toujours utiliser des vis aux dimensions correctes, comme indiqué cidessus. L'utilisation de vis aux dimensions incorrectes pourrait en effet endommager l'instrument.
 - Resserrer convenablement toutes les vis après le montage de chaque élément.
 - L'ensemble du carton d'emballage doit être retourné pendant le montage aussi, choisir un endroit suffisamment spacieux pour les opérations de déballage et de montage.

1 Ouvrir le carton et retirer les pièces du niveau supérieur.

Vérifier que toutes les pièces figurant sur l'illustration se trouvent bien dans le carton.

- NOTE**
- Un banc peut être fourni ou en option, selon l'endroit où l'instrument a été acheté.

2 Monter les trois pieds (A, B, C).

Utiliser une paire de ciseaux ou un cutter pour retirer les matériaux dans lesquels l'instrument est emballé. Puis, monter les pieds au-dessous de l'instrument avec quatre vis longues 5 x 20 mm par pied. Pour le montage des pieds, se référer soigneusement à l'illustration afin de garantir que la position des pieds (A) et (B) n'est pas inversée. S'assurer aussi qu'il y a un espace minimum entre les collerettes de pieds (A) et (B) et le châssis métallique sous l'instrument (les vis qui fixent les pieds sur ce châssis seront installées ultérieurement, à l'étape 6).

CVP-600: Montaje

- NOTA**
- Observe cuidado para no confundir las piezas, y asegúrese de montar todas ellas en el sentido correcto. Proceda al montaje en el orden indicado a continuación.
 - El montaje deberá realizarse al menos por dos personas.
 - Procure utilizar los tornillos del tamaño adecuado, según se indica arriba. El empleo de tornillos inadecuados puede ocasionar daños en el instrumento.
 - Asegúrese de apretar bien todos los tornillos después de montar cada unidad.
 - Deberá dar la vuelta a todo el paquete durante el montaje, por lo que es mejor que seleccione un lugar espacioso para efectuar el desembalaje y el montaje.

1 Abra el cartón y extraiga las partes del nivel superior.

Consultando la ilustración, asegúrese de que dispone de todas las partes necesarias.

- NOTA**
- Es posible que se suministre un banco o que sea opcional, dependiendo del lugar de venta del instrumento.

2 Coloque las tres patas (A, B, C).

Emplee unas tijeras o un cortador para sacar el material de embalaje en el que está envuelta la unidad principal. Luego, monte las patas en la parte inferior de la unidad principal empleando cuatro tornillos largos de 5 x 20 mm por pata. Consulte con cuidado la ilustración para asegurarse de que las posiciones de las patas (A) y (B) no se invierten. Asegúrese también que existe un espacio mínimo entre las bridas de las patas (A) y (B) y el bastidor metálico en la parte inferior de la unidad principal (los tornillos que se unen las patas a este bastidor se instalarán después, en el paso 6).

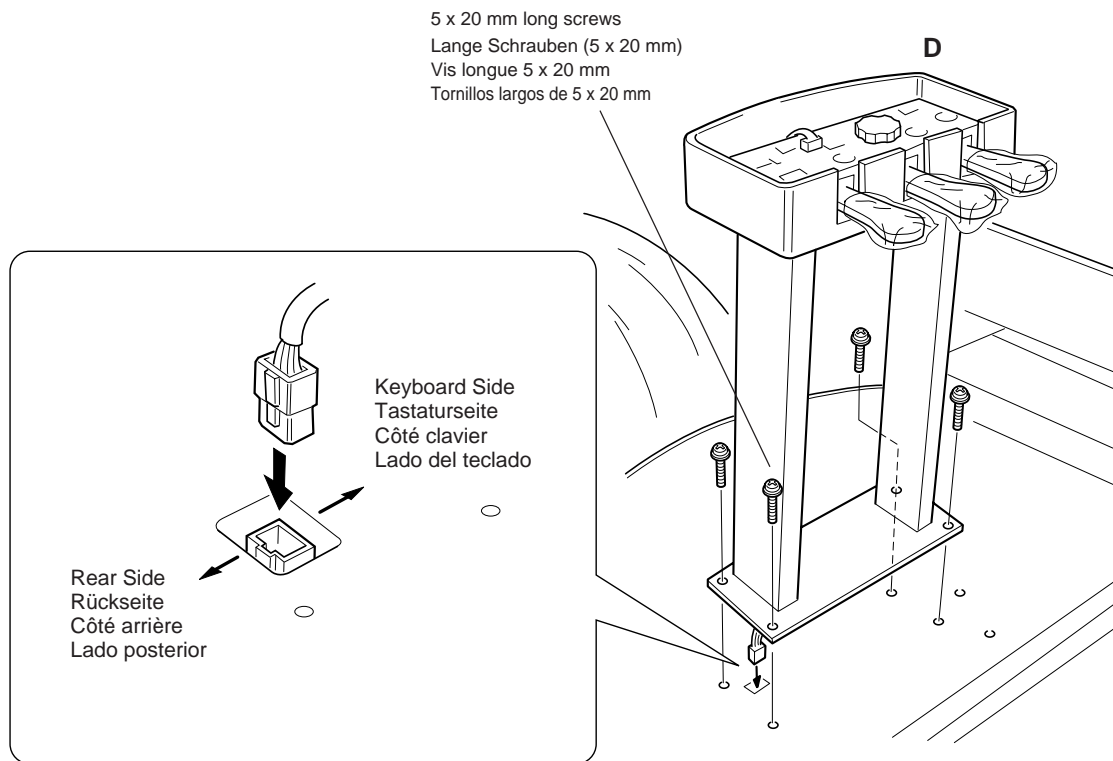

3 Attach the pedal box (D).

Before attaching the pedal box, connect the pedal cord. Pull the pedal plug out from the hole in the base plate and plug it into the socket in the bottom of the main unit with the lug on the plug facing the rear of the main unit (refer to the illustration). If the plug won't go in properly, don't force it ... check the plug orientation and try again.

Making sure that the pedal cord doesn't get caught between the base plate and main unit, carefully lower the pedal box assembly onto the bottom of the main unit and line up the screw holes. Finally, attach the pedal box with four 5 x 20 mm long screws.

4 Turn over the instrument and packing.

Make sure that the three legs are firmly attached, then using the front legs (A) and (B) for support, turn over the instrument and packing so that the carton is on top of the instrument.

3 Den Pedalkasten (D) montieren.

Schließen Sie vor der Montage des Pedalkastens zunächst das Pedalkabel an. Führen Sie den Kabelstecker durch das Loch in der Grundplatte, um ihn dann, mit der Führungsnase zur Rückseite des Instruments weisend, an die Buchse an der Unterseite anzuschließen (siehe Abbildung). Wenn der Stecker nicht in die Buchse paßt, bitte nicht mit Gewalt hineinstecken ... prüfen Sie seine Ausrichtung, und versuchen Sie es dann noch einmal.

Setzen Sie den Pedalkasten nun so auf der Unterseite des Instruments an, daß das Pedalkabel nicht zwischen Grundplatte und Instrument eingeklemmt wird und die Schraubenbohrungen zur Deckung kommen. Schrauben Sie den Pedalkasten dann mit vier langen Schrauben (5 x 20 mm) fest.

4 Das Instrument mit dem Karton aufstellen.

Prüfen Sie noch einmal, ob die drei Standbeine fest montiert sind, und stellen Sie das Instrument dann über die vorderen Standbeine (A und B) so aufrecht, daß der Karton oben ist.

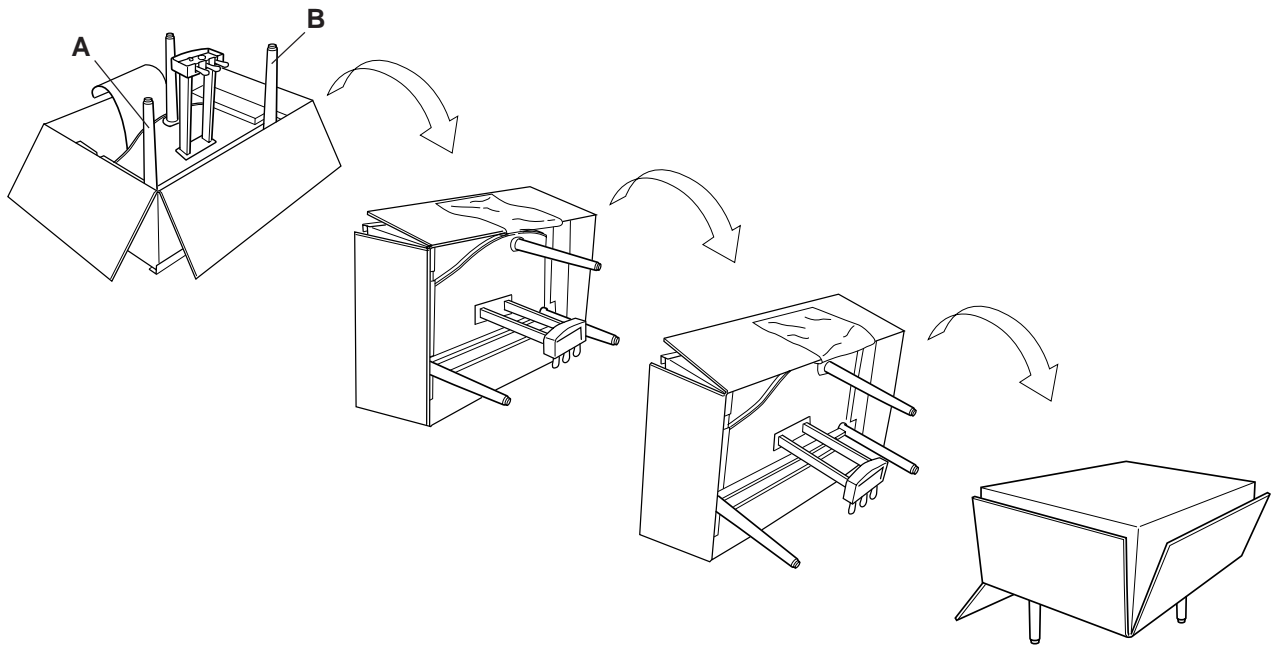

3 Monter le pédalier (D).

Avant de monter le pédalier, raccordez son cordon. Sortir le connecteur de pédalier de l'orifice de l'embase et le brancher dans la prise sous de l'instrument, la cosse du connecteur orienté vers l'arrière de l'instrument (comme indiqué sur l'illustration). Si la prise est difficile à enclencher, ne pas forcer... vérifier l'orientation de la prise et essayer à nouveau.

En vérifiant que le cordon du pédalier n'est pas pincé entre l'embase et l'instrument, abaisser soigneusement l'ensemble de pédalier en place au bas de l'instrument et l'aligner sur les trous de vis. Pour finir, monter le pédalier avec quatre vis longues 5 x 20 mm.

4 Retourner l'instrument et l'emballage.

Vérifier que les trois pieds sont fermement fixés, puis, en utilisant les pieds avant (A) et (B) comme support, retourner l'instrument et l'emballage, de manière à ce que le carton se trouve sur l'instrument.

3 Coloque la caja de pedales (D).

Antes de montar la caja de pedales, conecte el cable de los pedales. Tire de la clavija de pedales desde el orificio de la placa de la base y enchúfelo a la toma de la parte inferior de la unidad principal con el apéndice de la clavija encarado a la parte posterior de la unidad principal (consulte la ilustración). Si la clavija no entra correctamente, no la fuerza ... compruebe la orientación de la clavija e inténtelo de nuevo.

Teniendo cuidado de que el cable de los pedales no queda pillado entre la placa de la base y la unidad principal, baje con cuidado el conjunto de la caja de pedales a la parte inferior de la unidad principal y alinee los orificios de los tornillos. Finalmente, monte la caja de pedales con cuatro tornillos largos de 5 x 20 mm.

4 Dé la vuelta al instrumentos y al embalaje.

Asegúrese de que las tres patas estén firmemente unidas, y empleando las patas frontales (A) y (B) como soporte, dé la vuelta al instrumento y al embalaje de modo que el cartón quede en la parte superior del instrumento.

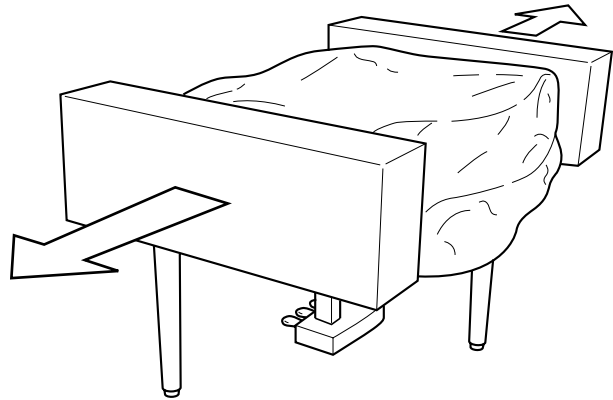
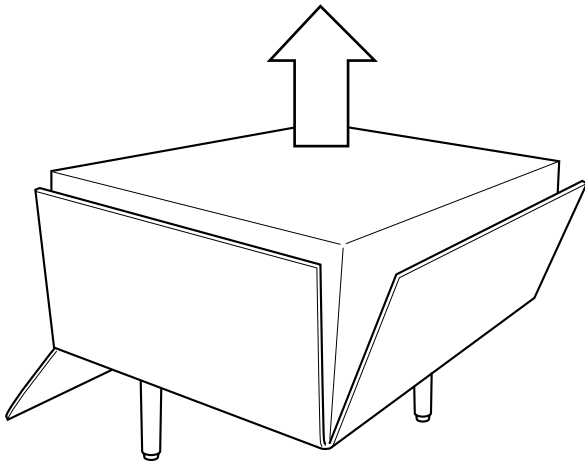
5**5 Remove the carton and packing material.**

Lift and remove the carton, then remove the remaining packing material from the main unit.

6 Attach the front leg/frame screws.

Firmly attach the front legs (A) and (B) to the frame on the bottom of the main unit using two 5 x 20 mm long screws for each leg.

7 Voltage Selector

Check the setting of the voltage selector which is provided in some areas. To set the selector for 110V, 127V, 220V or 240V main voltages, use a "minus" screwdriver to rotate the selector dial so that the correct voltage for your region appears next to the pointer on the panel. The voltage selector is set at 240V when the unit is initially shipped.

5 Den Karton und das Verpackungsmaterial entfernen.

Heben Sie zunächst den Karton weg, und entfernen Sie dann die beiden Formstücke und das übrige Verpackungsmaterial.

6 Die vorderen Standbeine mit dem Rahmen verschrauben.

Schrauben Sie die vorderen Standbeine (A und B) mit jeweils zwei langen Schrauben (5 x 20 mm) gut am Rahmen an der Unterseite des Instruments fest.

7 Den Spannungswähler einstellen.

Stellen Sie den Spannungswähler (falls vorhanden) auf die örtliche Netzspannung ein. Zum Verstellen drehen Sie den Spannungswähler mit einem Schlitzschraubendreher, bis der richtige Spannungswert (110, 127, 220 oder 240) an der Pfeilmarkierung steht. Bei der Auslieferung werden alle Instrumente mit Spannungswähler auf "240" voreingestellt.

6

5 x 20 mm long screws
Lange Schrauben (5 x 20 mm)
Vis longue 5 x 20 mm
Tornillos largos de 5 x 20 mm

5 x 20 mm long screws
Lange Schrauben (5 x 20 mm)
Vis longue 5 x 20 mm
Tornillos largos de 5 x 20 mm

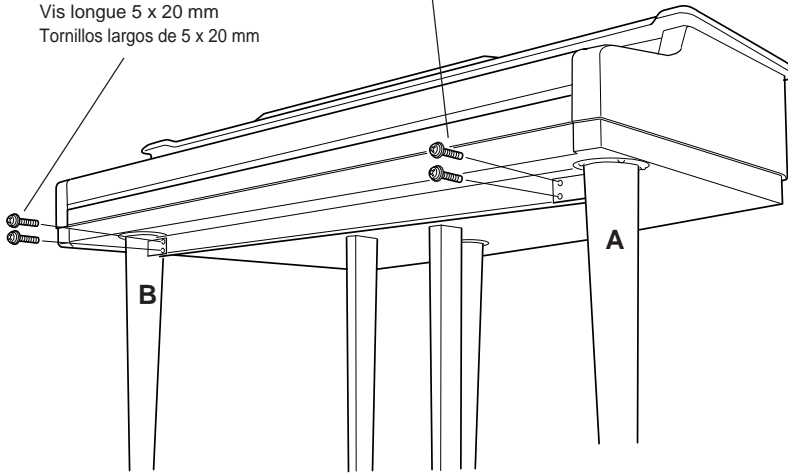
**7**

- A voltage selector is provided in some areas.
- Spannungswähler (nur in bestimmten Verkaufsgebieten)
- Un sélecteur de tension est prévu pour certaines régions
- El selector de tensión está provisto para ciertos destinos.

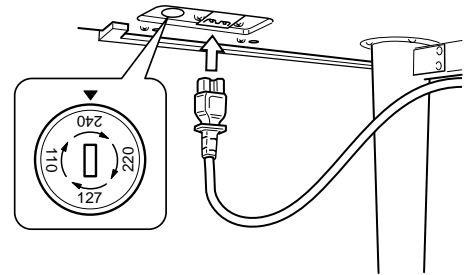

5 Retirer le carton et les matériaux de garniture.

Soulever le carton et le retirer, puis retirer les matériaux d'emballage qui restaient sur l'instrument.

6 Fixer les vis pieds avant/châssis.

Fixer fermement, sous l'instrument, les pieds avant (A) et (B) au châssis avec deux vis longues 5 x 20 mm par pied.

7 Sélecteur de tension.

Vérifiez le réglage du sélecteur de tension qui est prévu pour certaines régions. Pour régler le sélecteur sur 110 V, 127 V, 220 V ou 240 V, utilisez un tournevis à lame plate pour tourner le cadran du sélecteur afin de mettre l'indication correspondant à la tension de votre région vis à vis du repère triangulaire situé sur le panneau. Le sélecteur de tension est réglé sur 240 V au départ d'usine.

5 Extraiga el cartón y el material de embalaje.

Levante y extraiga el cartón, y saque entonces el material de embalaje restante de la unidad principal.

6 Monte los tornillos de las patas frontales/bastidor.

Coloque firmemente las patas frontales (A) y (B) en el bastidor en la parte inferior de la unidad principal empleando dos tornillos largos de 5 x 20 mm para cada pata.

7 Selector de tensión.

Compruebe el ajuste del selector de tensión que se incorpora para ciertos destinos. Para ajustar el selector a 110V, 127V, 220V ó 240V de la red de alimentación, emplee un destornillador de cabeza recta "-" para girar el selector de modo que la tensión correcta de su zona aparezca al lado del indicador del panel. El selector de tensión se ajusta a 240V cuando la unidad sale de fábrica.

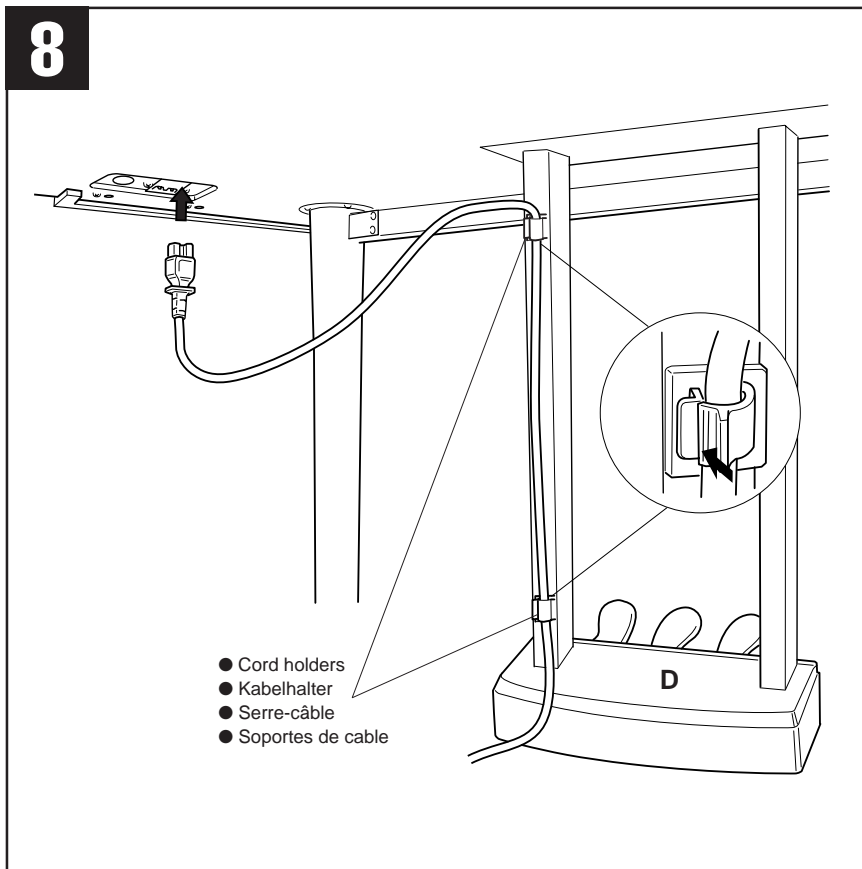

8 Attach the cord holders and plug in the AC cord.

Remove the protective backing from the adhesive surface of the cord holders, and attach at approximately the locations shown in the illustration. Plug the main-unit end of the AC cord into the corresponding socket on the bottom of the main unit, then secure the cord with the cord holders.

A plug adaptor may be also provided in some areas to match the pin configuration of the AC wall outlets in your area.

9 Set the adjuster.

For stability, an adjuster is provided on the bottom of the pedal box (D). Rotate the adjuster until it comes in firm contact with the floor surface. The adjuster ensures stable pedal operation and facilitates pedal effect control. If the adjuster is not in firm contact with the floor surface, distorted sound may result.

■ After completing the assembly, please check the following.

- Are there any parts left over?
→ Review the assembly procedure and correct any errors.
- Is the Clavinova clear of doors and other movable fixtures?
→ Move the Clavinova to an appropriate location.
- Does the Clavinova make a rattling noise when you shake it?
→ Tighten all screws.
- Does the pedal box rattle or give way when you step on the pedals?
→ Turn the adjuster so that it is set firmly against the floor.
- Are the pedal and power cords inserted securely into the sockets?
→ Check the connection.
- If the main unit creaks or is otherwise unsteady when you play on the keyboard, refer to the assembly diagrams and retighten all screws.

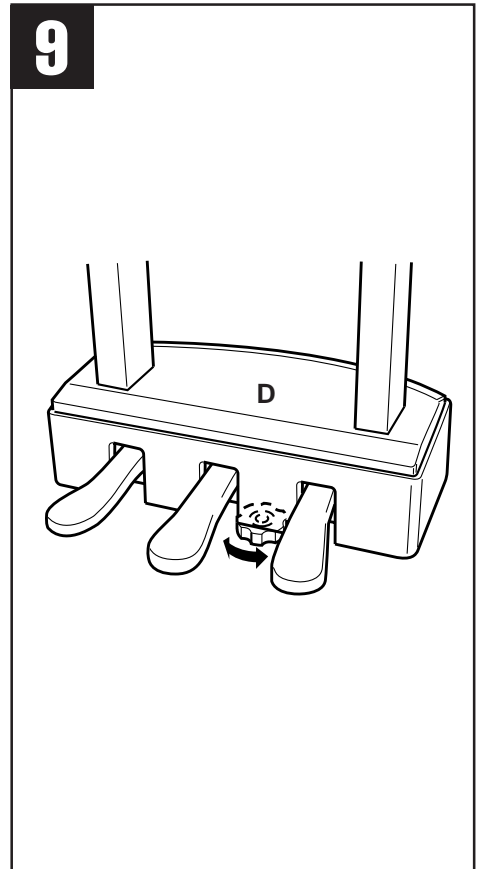

8 Die Kabelhalter anbringen und das Netzkabel anschließen.

Ziehen Sie das Schutzpapier von der Klebefläche der Kabelhalter ab, und bringen Sie die Halter ungefähr an den in der Abbildung gezeigten Stellen an. Stecken Sie den kleineren Stecker des Netzkabels in die entsprechende Buchse an der Unterseite des Instruments, um das Kabel dann in die Kabelhalter zu legen.

In manchen Gebieten wird ein Steckeradapter mitgeliefert, um den Anschluß an die evtl. unterschiedlich geformte Steckdose zu ermöglichen.

9 Den Pedalfuß einstellen.

Um dem Pedalkasten (D) mehr Standfestigkeit zu geben, ist er mit einem verstellbaren Pedalfuß ausgestattet. Drehen Sie diesen Fuß heraus, bis er fest auf der Bodenfläche steht. Der Pedalfuß stabilisiert den Pedalkasten und ermöglicht eine präzise Pedalbetätigung. Wenn der Pedalfuß nicht fest auf dem Boden steht, können Klangverzerrungen auftreten.

■ Wenn der Zusammenbau beendet ist, prüfen Sie bitte folgende Dinge:

- Sind Teile übrig geblieben?
→ Gehen Sie den Vorgang des Zusammenbaus noch einmal durch und korrigieren Sie eventuelle Fehler.
- Befindet sich das Clavinova weit genug von Türen und anderen beweglichen Vorrichtungen entfernt?
→ Bewegen Sie das Clavinova an einen entsprechend sicheren Ort.
- Macht das Clavinova Klappergeräusche, wenn Sie es schütteln?
→ Ziehen Sie alle Schrauben fest.
- Klappert der Pedalkasten oder gibt er nach, wenn Sie das Pedal treten?
→ Drehen Sie den Höhenversteller, bis er fest auf dem Fußboden steht.
- Sind Pedal- und Netzkabel richtig an den Buchsen angeschlossen?
→ Prüfen Sie die Verbindung.
- Wenn die Haupteinheit knarrt oder beim Spielen wackelt, betrachten Sie die Abbildungen und ziehen Sie alle Schrauben noch einmal nach.

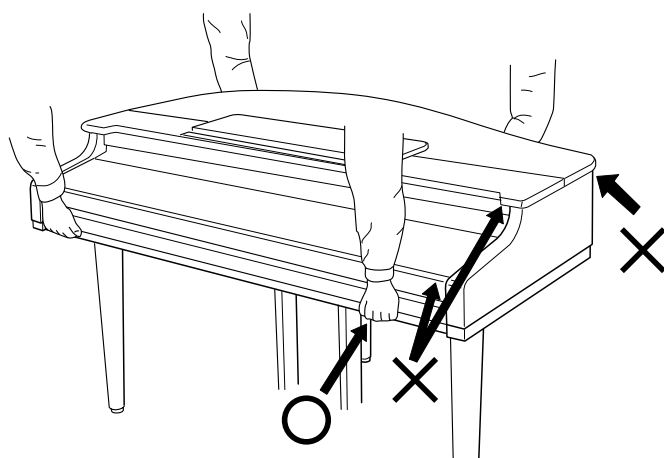

CAUTION • When moving the instrument after assembly, always hold the lower surface of the main unit, NEVER the lid or keyboard cover. Improper handling can result in damage to the instrument or personal injury.

VORSICHT • Fassen Sie zum Umstellen des Instruments nach dem Zusammenbau stets unter das Gehäuse; heben Sie es niemals am Gehäuse- oder Tastaturdeckel. Bei Nichtbeachtung dieses Punkts kann das Instrument beschädigt und im Extremfall eine Verletzung hervorgerufen werden.

PRECAUTION • Pour déplacer l'instrument après le montage, toujours tenir l'instrument par la surface inférieure, JAMAIS par le couvercle ou le protège-clavier. Une mauvaise manipulation peut provoquer des dommages ou des blessures.

CUIDADO • Cuando mueva el instrumento después del montaje, sostenga siempre la superficie inferior de la unidad principal. NUNCA por la tapa ni cubierta del teclado. La manipulación indebida puede causar daños en el instrumento o personales.

8 Fixer les serre-fils et brancher le cordon de l'alimentation secteur.

Retirer le film protecteur des surfaces adhésives aux serre-fils et les fixer approximativement aux emplacements indiqués sur l'illustration. Brancher l'extrémité instrument du cordon secteur dans la prise correspondante au bas de l'instrument et fixer le cordon avec les serre-fils.

Un adaptateur de prise peut également être fourni dans certaines régions pour pouvoir brancher le cordon à la prise secteur murale.

9 Régler la hauteur du pédalier

Pour assurer la stabilité, un dispositif de réglage du pédalier (D) est équipé. Tourner ce dispositif jusqu'à ce qu'il soit en contact ferme avec le sol. Ce dispositif assure la stabilité du pédalier pendant son utilisation et facilite la commande au pied des effets. Si ce dispositif n'est pas fermement en contact avec le sol, le son pourra être déformé.

■ Lorsque le montage est terminé, veuillez mener à bien les vérifications suivantes.

- Reste-t-il des pièces non utilisées?
→ Passer en revue la procédure de montage et corriger toute erreur éventuelle.
- Le Clavinova est-il placé à l'écart des portes et de toute autre structure mobile?
→ Déplacer le Clavinova vers un emplacement approprié.
- Lorsque vous secouez quelque peu le Clavinova, entendez-vous un cliquetis?
→ Serrer convenablement toutes les vis.
- Le pédalier fait-il du bruit ou s'écarte-t-il lorsque vous appuyez sur les pédales?
→ Tourner le stabilisateur de sorte qu'il repose fermement sur le sol.
- Les cordons des pédales et d'alimentation sont-ils bien enfoncés dans les prises?
→ Vérifier toutes les connexions.
- Si la partie principale de l'appareil craque ou est instable lorsque vous jouez sur le clavier, consulter les diagrammes de montage et resserrer toutes les vis.

8 Monte los soportes de cable y enchufe el cable de CA

Extraiga el dorso protector de la superficie adhesiva de los soportes de cable, y colóquelos aproximadamente en los lugares mostrados en la ilustración. Enchufe e extremo de la unidad principal del cable de CA en la toma correspondiente de la parte inferior de la unidad principal, y fije el cable con los soportes de cables.

En algunas zonas puede suministrarse también un adaptador para adaptar la configuración de las patillas de los tomacorrientes de CA de su localidad.

9 Ajuste el ajustador.

Para mayor estabilidad, se proporciona un ajustador en la parte inferior de la caja de pedales (D). Gire el ajustador hasta que se ponga firmemente en contacto con la superficie del suelo. El ajustador asegura la operación estable de los pedales y facilita el control de efectos de los pedales. Si el ajustador no está firmemente en contacto con la superficie del suelo, puede producirse sonido distorsionado.

■ Cuando haya concluido el montaje, compruebe los siguientes puntos:

- ¿Ha quedado alguna pieza sin instalar?
→ Revise el procedimiento de montaje y corrija cualquier error que se haya podido cometer.
- ¿Está el Clavinova alejado del recorrido de puertas y muebles?
→ Traslade el Clavinova a una posición adecuada.
- ¿Suena algún ruido de holgura cuando se mueve el Clavinova?
→ Apriete con firmeza todos los tornillos.
- ¿Vibra o cede la caja de pedales cuando se pisan los pedales?
→ Gire el ajustador hasta que se apoye firmemente sobre el suelo.
- ¿Están perfectamente insertados los cables de pedal y alimentación en los conectores?
→ Revise las conexiones.
- Si la unidad principal cruje o presenta algún signo de inestabilidad cuando se toca el teclado, consulte los esquemas de montaje y vuelva a apretar todos los tornillos.

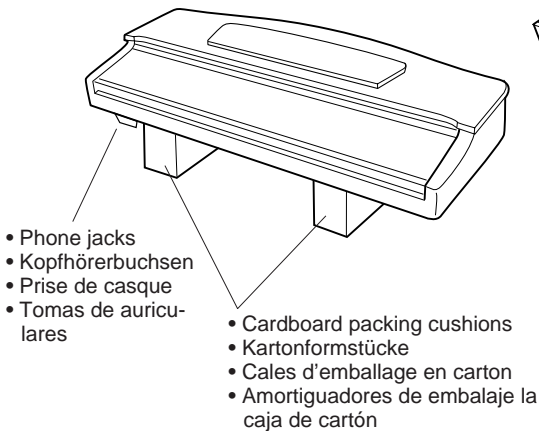

- Phone jacks
- Kopfhörerbuchsen
- Prise de casque
- Tomas de auriculares

- Cardboard packing cushions
- Kartonformstücke
- Cales d'emballage en carton
- Amortiguadores de embalaje la caja de cartón

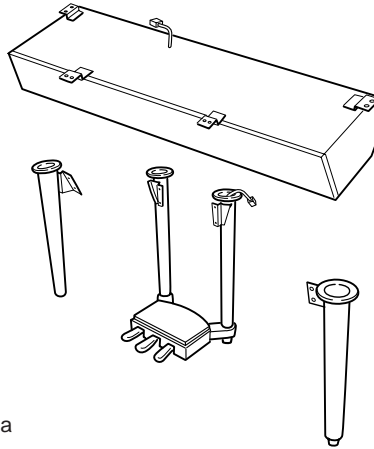

- AC power cord
- Netzkabel
- Cordon d'alimentation
- Cable de alimentación de CA

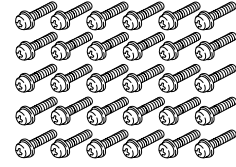

- 5 x 18 mm screws x 30
- Schrauben (5 x 18 mm) x 30
- Vis de 5 x 18 mm x 30
- Tornillos de 5 x 18 mm x 30

CVP-98/96: Assembly

NOTE

- Be careful not to confuse parts, and be sure to install all parts in the correct direction. Please assemble in accordance with the sequence given below.
- Assembly should be carried out by at least two persons.
- Be sure to use the correct screw size, as indicated above. Use of incorrect screws can cause damage.
- Be sure to tighten up all screws upon completing assembly of each unit.
- To disassemble, reverse the assembly sequence given below.

1 Open the box and remove all the parts.

Take out the two cardboard packing cushions and place them on the floor. Then take out main unit and place it on top of the packing cushions. Position the cushions so as to protect the phone jacks on the base of the unit. Remove all parts from the box. Confirm that all parts shown in the illustration above are provided.

CAUTION

- When you lift the pedal box assembly, make sure that you lift by both legs.

2 Carefully lean the main unit against a wall.

To make it easier to install the legs, place a soft blanket or similar material on the floor near a wall, close the Clavinova keyboard cover, place the front panel of the Clavinova (the side with the keyboard) on the blanket and gently lean the unit against the wall — **MAKING SURE THAT IT CAN NOT FALL** — as shown in the illustration.

CAUTION

- Do not lay the main unit upside-down on the floor.

3 Attach the front legs.

Securely attach the two front legs using three screws for each leg (use a Philips “+” screwdriver) as shown in the illustration. Make sure that the screws are firmly tightened.

CVP-98/96: Zusammenbau

NOTIZ

- Achten Sie darauf, die Teile nicht zu verwechseln, und installieren Sie alle Teile in der richtigen Ausrichtung. Gehen Sie beim Zusammenbau bitte in der angegebenen Reihenfolge vor.
- Die Montage sollte von mindestens zwei Personen vorgenommen werden.
- Achten Sie darauf, die richtige Schraubengröße zu verwenden, wie es oben gezeigt ist. Die Verwendung der falschen Schrauben kann zu Schäden führen.
- Achten Sie während der Montage darauf, bei jedem Arbeitsgang alle Schrauben festzuziehen.
- Für die Demontage muß die angegebene Reihenfolge umgekehrt befolgt werden.

1 Den Versandkarton öffnen und alle Teile auspacken.

Nehmen Sie die beiden Kartonformstücke heraus, und legen Sie sie auf den Boden. Nehmen Sie dann die Haupteinheit heraus, und stellen Sie sie auf die abgelegten Formstücke. Positionieren Sie die Formstück dabei so, daß die Kopfhörerbuchsen unten am Instrument nicht beschädigt werden können. Vergewissern Sie sich, daß alle in der obigen Abbildung aufgeführten Teile vollständig vorhanden sind.

VORSICHT

- Halten Sie die Pedalkasten-Baugruppe beim Heben stets an beiden Beinen.

2 Die Haupteinheit vorsichtig an eine Wand lehnen.

Um das Anschrauben der Beine zu erleichtern, breiten Sie eine Decke oder ein weiches Tuch neben der Wand auf dem Boden aus, schließen die Tastaturabdeckung des Clavinova, stellen das Instrument mit der Vorderkante (Seite mit der Tastatur) vorsichtig auf die Decke und lehnen es an die Wand, wie in der Abbildung gezeigt. **VERGEWISSERN SIE SICH, DASS DAS INSTRUMENT NICHT KIPPEN ODER WEGRUTSCHEN KANN!**

VORSICHT

- Legen Sie die Haupteinheit nicht mit der Oberseite nach unten auf den Boden!

3 Die vorderen Beine montieren.

Schrauben Sie die beiden vorderen Beine mit jeweils drei Schrauben (Kreuzschlitzschraubendreher verwenden!) gut am Clavinova fest, wie in der Abbildung gezeigt. Ziehen Sie die Schrauben fest an.

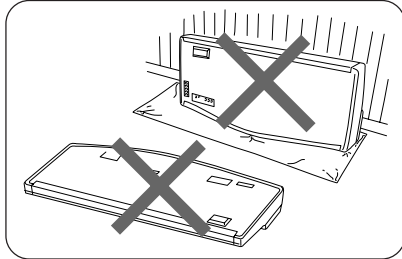
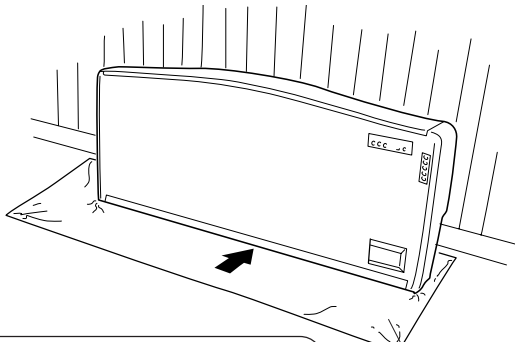
2

- Blanket, etc.
- Decke o. ä.
- Couverture, etc.
- Manta, etc.

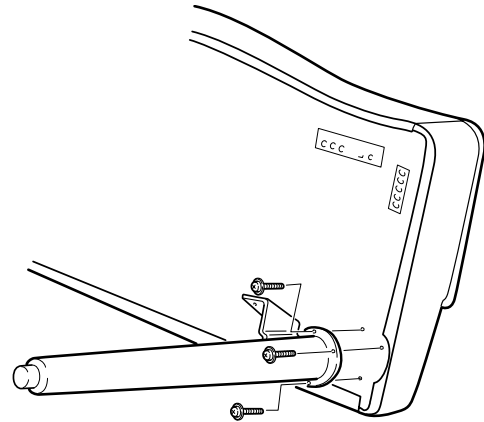
3

- Three screws on each side
- Drei Schrauben pro Bein
- Trois vis de chaque côté
- Tres tornillos en cada lado

CVP-98/96: Montage

NOTE

- Veiller à ne pas mélanger les pièces et à les installer dans le sens correct. Veuillez assembler l'instrument dans l'ordre indiqué ci-dessous.
- La présence de deux personnes minimum est nécessaire pour procéder au montage.
- Toujours utiliser des vis aux dimensions correctes, comme indiqué ci-dessus. L'utilisation de vis aux dimensions incorrectes pourrait en effet endommager l'instrument.
- Resserrer convenablement toutes les vis après le montage de chaque élément.
- Pour démonter le Clavinova, inverser l'ordre des indications données ci-dessous.

1 Ouvrez le carton et retirez toutes les pièces.

Sortez les deux cales d'emballage en carton et placez-les sur le sol. Puis sortez le clavier et placez-le sur ces cales. Positionnez les cales de manière à protéger la prise de casque d'écoute sur la base du clavier. Vérifiez que toutes les pièces qui figurent sur l'illustration sont bien fournies.

PRECAUTION

- Lorsque vous soulevez l'ensemble de boîtier de pédale, soulevez-le par les deux bords.

2 Appuyez le clavier contre un mur en faisant très attention.

Pour faciliter la pose des pieds, placez une couverture épaisse, ou un matériau similaire, sur le plancher à proximité d'un mur. Fermez le protège-clavier et placez la face avant du Clavinova (côté clavier) sur la couverture et appuyez ensuite le clavier contre le mur de la manière illustrée. **ASSUREZ-VOUS QU'IL NE PEUT PAS TOMBER.**

PRECAUTION

- Ne posez pas le clavier à l'envers sur le sol.

3 Posez les pieds avant.

Fixez les deux pieds avant en utilisant trois vis par pied (utilisez un tournevis cruciforme "+") comme illustré. Vérifiez que les vis sont serrées à fond.

CVP-98/96: Montaje

NOTA

- Observe cuidado para no confundir las piezas, y asegúrese de montar todas ellas en el sentido correcto. Proceda al montaje en el orden indicado a continuación.
- El montaje deberá realizarse al menos por dos personas.
- Procure utilizar los tornillos del tamaño adecuado, según se indica arriba. El empleo de tornillos inadecuados puede ocasionar daños en el instrumento.
- Asegúrese de apretar bien todos los tornillos después de montar cada unidad.
- Para desmontar las unidades, invierta la secuencia de montaje facilitada a continuación.

1 Abra la caja y extraiga todas las partes.

Saque los dos amortiguadores de embalaje de la caja de cartón y póngalos en el suelo. Entonces, saque la unidad principal y póngala encima de los amortiguadores de embalaje. Coloque los amortiguadores de modo que protejan las tomas de auriculares de la base de la unidad. Extraiga todas las partes de la caja. Confirme que están incluidas todas las partes que se muestran en la ilustración de arriba.

CUIDADO

- Cuando levante el conjunto de la caja de pedales, asegúrese de que levanta ambas patas.

2 Incline con cuidado la unidad principal contra una pared.

Para facilitar la instalación de las patas, coloque una manta blanda o un material semejante sobre el piso cerca de una pared, cierre la cubierta del teclado de la Clavinova, coloque el panel frontal de la Clavinova (el lado con el teclado) sobre la manta e incline con cuidado la unidad contra la pared — **ASEGURÁNDOSE DE QUE NO PUEDA CAERSE** — como se muestra en la ilustración.

CUIDADO

- No ponga la unidad principal al revés sobre el suelo.

3 Coloque las patas delanteras.

Fije las dos patas delanteras usando tres tornillos para cada pata (emplee un destornillador de cabeza en cruz "+") como se muestra en la ilustración. Asegúrese de que los tornillos queden bien apretados.

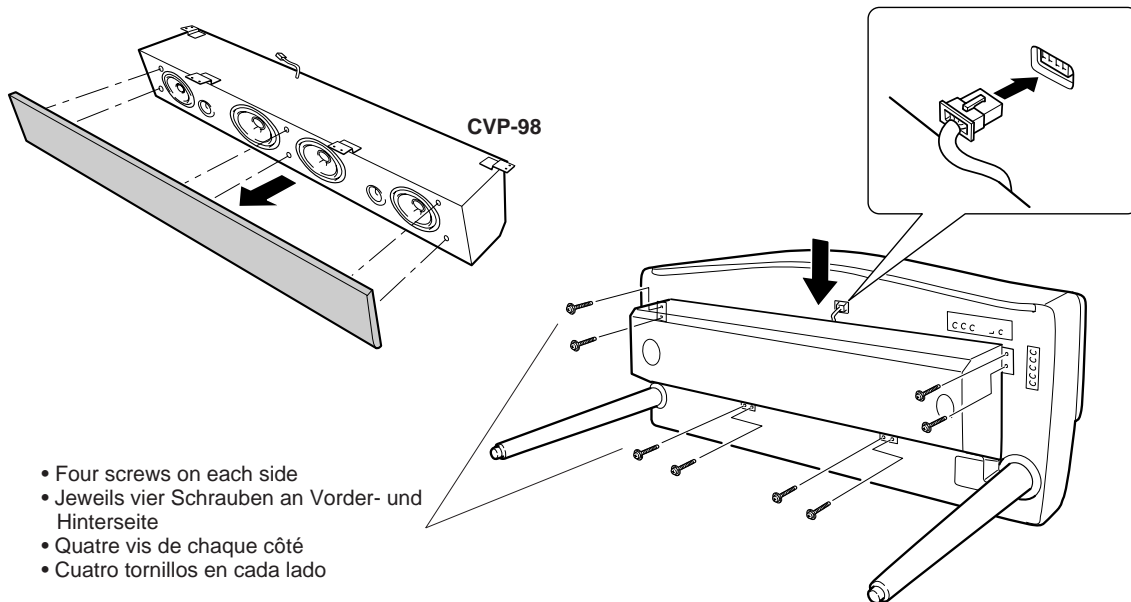
4

- Four screws on each side
- Jeweils vier Schrauben an Vorder- und Hinterseite
- Quatre vis de chaque côté
- Cuatro tornillos en cada lado

4 Attach the speaker box.

Remove the speaker box cover (attached to the speaker box in 6 places with plastic plugs) from the speaker box. Gently rest the speaker box onto the corresponding brackets on the front legs. (Be careful not to touch the speakers when handling the speaker box. Damage may result.)

Make sure the speaker cord is extending out from the rear of the speaker box. Secure the speaker box to the main keyboard unit using four screws on each side. Insert the speaker cord connector into the corresponding socket on the main keyboard unit, making sure that the protruding clip on the connector is facing up.

5 Attach the pedal box assembly.

Before attaching the rear leg and pedal box assembly, insert the pedal cord plug extending from the rear leg into the corresponding socket in the main unit. Make sure that the protruding clip on the connector is facing up. Put the excess cord into the leg and loosely secure the rear leg and pedal assembly using 6 screws for each leg (four screws per leg and two screws on each leg bracket). Once the rear leg and pedal assembly has been loosely attached, go back and tighten all 12 of the screws on the rear leg and pedal assembly.

4 Den Lautsprecherkasten montieren.

Nehmen Sie die Bespannung (wird an 6 Punkten von Plastikdübeln gehalten) vom Lautsprecherkasten ab. Setzen Sie den Lautsprecherkasten vorsichtig auf die Halterungen an den vorderen Beinen. (Vermeiden Sie dabei unbedingt ein Berühren der Lautsprechermembrane.) Das Lautsprecherkabel muß an der Hinterseite (d.h. oben) aus dem Lautsprecherkasten ragen. Schrauben Sie den Lautsprecherkasten mit jeweils vier Schrauben an Vorder- und Hinterseite an der Haupteinheit fest. Schließen Sie dann das Lautsprecherkabel an die Buchse der Haupteinheit an (die Führungsnase am Stecker muß dabei nach oben weisen).

5 Die Pedalkastengruppe montieren.

Bevor Sie die Pedalkastengruppe mit den hinteren Beinen montieren, schließen Sie das aus dem einen Bein ragende Pedalkabel an die entsprechende Buchse der Haupteinheit an (die Führungsnase am Stecker muß dabei nach oben weisen). Schieben Sie überlanges Kabel wieder in das Bein zurück, und schrauben Sie dann die hinteren Beine mit der Pedalkastengruppe provisorisch mit 6 Schrauben pro Bein (jeweils 4 für das Bein selbst und 2 für die Halterung am Bein) an die Haupteinheit. Nachdem Sie die hinteren Beine mit dem Pedalkasten fixiert haben, ziehen Sie die 12 Schrauben fest an.

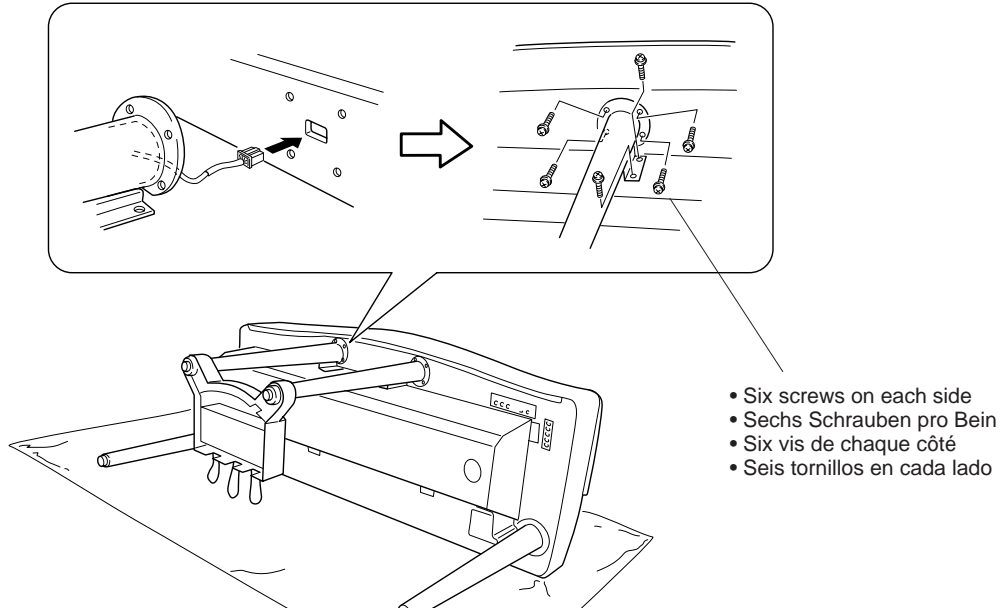
5**4 Posez la boîte des haut-parleurs.**

Retirez le couvercle du coffret du haut-parleur (fixé au coffret du haut-parleur en six endroits avec des chevilles en plastique) au coffret du haut-parleur. Poser la boîte des haut-parleurs sur les ferrures correspondantes des pieds avant. (Faites bien attention de ne pas toucher les haut-parleurs lorsque vous manipulez la boîte. Cela pourrait les endommager.) Assurez-vous que le cordon des haut-parleurs sort de l'arrière de la boîte. Fixez la boîte sur le clavier en utilisant quatre vis de chaque côté. Branchez le connecteur du cordon des haut-parleurs à la prise correspondante du clavier en veillant à ce que la partie en saillie du connecteur soit orientée vers le haut.

5 Fixez le pédalier.

Avant de poser l'ensemble pied arrière/pédalier, branchez le connecteur du cordon de pédalier sortant du pied arrière à la prise correspondante du clavier. Veillez à ce que la partie en saillie du connecteur soit dirigée vers le haut. Placez le cordon en excès dans le pied et montez sans trop serrer l'ensemble pied arrière/pédalier en utilisant six vis pour chaque pied (4 vis par pied et 2 vis pour chaque ferrure de fixation). Une fois que l'ensemble pied arrière/pédalier est provisoirement monté, serrez à fond ses 12 vis.

4 Monte la caja de altavoces.

Extraiga la cubierta de la caja de altavoces (unida a la caja de altavoces en 6 lugares con tapones de plástico) desde la caja de altavoces. Apoye con cuidado la caja de altavoces en las ménsulas correspondientes de las patas delanteras. (Tenga cuidado en no tocar los altavoces cuando se manipule la caja de altavoces. Podrían ocasionarse daños.) Asegúrese de que el cable de altavoz se extienda desde la parte posterior de la caja del altavoz. Fije la caja de altavoces a la unidad del teclado principal usando cuatro tornillos en cada lado. Inserte el conector del cable de altavoces en el receptáculo correspondiente de la unidad del teclado principal, asegurándose de que el retenedor que sobresale del conector queda orientado hacia arriba.

5 Monte el conjunto de la caja de pedales

Antes de montar la pata trasera y el conjunto de la caja de pedales, inserte la clavija del cables de los pedales, que se extiende desde la pata trasera al receptáculo correspondiente de la unidad principal. Asegúrese de que el retenedor que sobresale del conector queda orientado hacia arriba. Ponga el cable sobrante en la pata y fije sin apretar la pata trasera y el conjunto de pedales usando 6 tornillos para cada pata (cuatro tornillos por pata y dos tornillos en la ménsula de cada pata). Después de haber montado sin apretar la pata trasera y el conjunto de pedales, apriete los 12 tornillos de la tapa trasera y el conjunto de pedales.

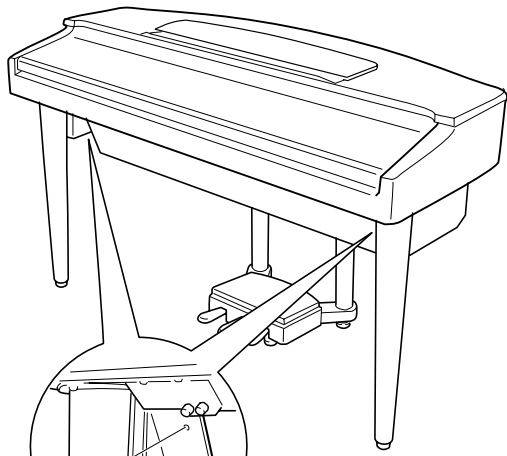

- Two screws on each side
- Jeweils zwei Schrauben links und rechts
- Deux vis de chaque côté
- Dos tornillos en cada lado

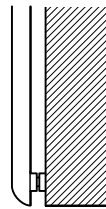
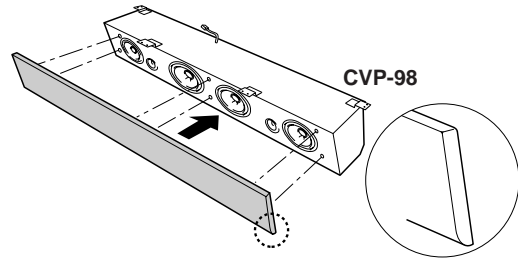

- Make sure the plugs are fully inserted and there is no space left around the plugs and holes.
- Vergewissern Sie sich, daß die Dübel bis zum Anschlag in den Löchern sitzen und kein Zwischenraum verbleibt.
- Vérifiez que les chevilles sont complètement insérées et qu'il n'y a pas d'espace entre la cheville et le matériau.
- Asegúrese de que los tapones estén insertados a fondo y que no quede espacio en torno a los tapones y los orificios.

6 Secure the speaker box.

Stand the main unit on its legs and securely attach the speaker box to the bracket on the front legs using two screws for each bracket. If it is impossible to align the bracket holes with the speaker box holes, slightly loosen the three screws on each of the front legs, align the holes, and secure the speaker box. After the speaker box is firmly attached, retighten the screws on the front legs firmly. Put the speaker box cover back in place with the rounded edge of the cover at the bottom, insert the plugs on the cover into their corresponding holes on the speaker box.



- When attaching the cover, make sure you push where the plugs are. The speaker cover is made of a soft material so pushing in a place where there are no plugs may cause damage to the speaker.

7 Voltage Selector

Before connecting the AC power cord, check the setting of the voltage selector which is provided in some areas. To set the selector for 110V, 127V, 220V or 240V main voltages, use a “minus” screwdriver to rotate the selector dial so that the correct voltage for your region appears next to the pointer on the panel. The voltage selector is set at 240V when the unit is initially shipped.

After the proper voltage has been selected connect the AC power cord.

8 Set the adjuster.

For stability, an adjuster is provided on the bottom of the pedal box. Rotate the adjuster until it comes in firm contact with the floor surface. The adjuster ensures stable pedal operation and facilitates pedal effect control. If the adjuster is not in firm contact with the floor surface, distorted sound may result.

6 Den Lautsprecherkasten an den vorderen Beinen sichern.

Stellen Sie das Instrument nun auf seine Beine, um den Lautsprecherkasten zusätzlich mit jeweils zwei Schrauben an die Halterungen der beiden vorderen Beine zu schrauben. Sollten die Schraubenbohrungen nicht zur Deckung gebracht werden können, lösen Sie die Befestigungsschrauben der vorderen Beine ein wenig. Nach Festschrauben des Lautsprecherkastens dürfen Sie jedoch nicht vergessen, die Schrauben der Beine wieder fest anzuziehen. Bringen Sie nun die Bespannung mit der abgerundeten Kante nach unten weisend wieder am Lautsprecherkasten an, indem Sie die Plastikdübel in die entsprechenden Löcher stecken.



- Drücken Sie beim Anbringen der Bespannung nur auf die Stellen mit den Plastikdübeln. Die Bespannung besteht aus sehr weichem Material, so daß der Lautsprecher beim Drücken auf eine andere Stelle leicht beschädigt wird.

7 Den Spannungswähler einstellen.

Bevor Sie nun das Netzkabel anschließen, müssen Sie den Spannungswähler (falls vorhanden) auf die örtliche Netzspannung einstellen. Zum Verstellen drehen Sie den Spannungswähler mit einem Schlitzschraubendreher, bis der richtige Spannungswert (110, 127, 220 oder 240) an der Pfeilmarkierung steht. Bei der Auslieferung werden alle Instrumente mit Spannungswähler auf “240” voreingestellt.

Nachdem Sie den Spannungswähler richtig eingestellt haben, können Sie nun das Netzkabel anschließen.

8 Die Pedalstützen einstellen.

Zur Stabilisierung ist an der Unterseite des Pedalkastens ein Höhenversteller vorgesehen. Schrauben Sie den Höhenversteller heraus, bis er fest auf dem Fußboden steht. Der Höhenversteller sorgt für stabile Pedalbetätigung und ermöglicht eine präzise Regelung des Betätigungshubs. Wenn er nicht fest auf dem Boden steht, können beim Treten der Pedale Klangverzerrungen auftreten.

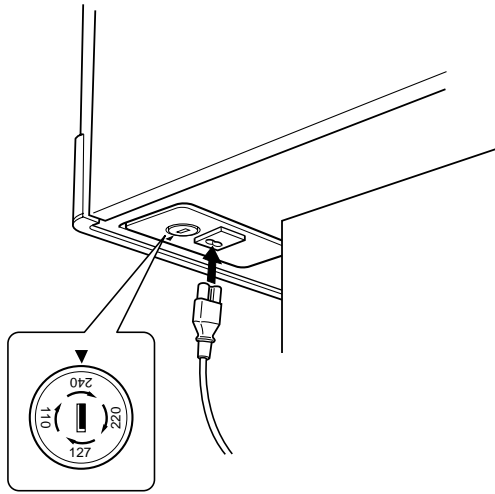
7

- A voltage selector is provided in some areas.
- Spannungswähler (nur in bestimmten Verkaufsgebieten)
- Un sélecteur de tension est prévu pour certaines régions
- El selector de tensión está provisto para ciertos destinos.

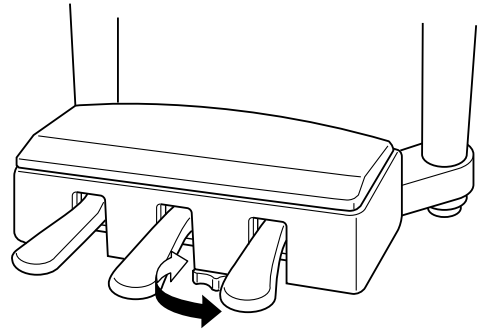
8

6 Fixer la boîte des haut-parleurs.

Mettez le clavier sur ses pieds et fixez la boîte des haut-parleurs à la ferrure de fixation des pieds avant à l'aide de deux vis par ferrure. S'il est impossible d'aligner les trous des ferrures de fixation sur les trous de la boîte des haut-parleurs, desserrez légèrement les trois vis de chaque pied avant, alignez les trous et fixez la boîte des haut-parleurs. Remettez le couvercle du coffret du haut-parleur à sa place, avec le bord arrondi de ce couvercle en bas, insérez les chevilles dans le couvercle et dans leurs trous correspondant sur le coffret du haut-parleur.



- En montant le couvercle, appuyez bien à l'endroit où se trouvent les chevilles. Le couvercle du haut-parleur est constitué d'une matière souple et le fait d'appuyer à un endroit où il n'y a pas de cheville pourrait endommager le haut-parleur.

7 Sélecteur de tension

Avant de connecter le cordon d'alimentation, vérifiez le réglage du sélecteur de tension qui est prévu pour certaines régions. Pour régler le sélecteur sur 110 V, 127 V, 220 V ou 240 V, utilisez un tournevis à lame plate pour tourner le cadran du sélecteur afin de mettre l'indication correspondant à la tension de votre région vis à vis du repère triangulaire situé sur le panneau. Le sélecteur de tension est réglé sur 240 V au départ d'usine.

Une fois que vous avez réglé le sélecteur de tension, connectez le cordon d'alimentation.

8 Réglez la hauteur du pédalier.

Pour assurer la stabilité du pédalier, un dispositif de réglage a été prévu à sa partie inférieure. Tournez ce dispositif jusqu'à ce qu'il soit en contact ferme avec la surface du sol. Ce dispositif assure la stabilité du pédalier lors de son utilisation et facilite la commande au pied des effets. Si ce dispositif n'est pas en contact ferme avec le sol, il pourra se produire une distorsion du son.

6 Fije la caja de altavoces

Apye la unidad principal sobre sus patas y monte con seguridad la caja de altavoces en la ménsula de las patas delanteras usando dos tornillos para cada ménsula. Si es imposible alinear los orificios de las ménsulas con los orificios de la caja de altavoces, afloje un poco los tres tornillos de cada una de las patas delanteras, alinee los orificios, y fije la caja de altavoces. Después de haber montado firmemente la caja de altavoces, vuelva a apretar bien los tornillos de las patas delanteras. Vuelva a poner la cubierta de la caja de altavoces en su lugar con el borde redondeado de la cubierta en la parte inferior, e inserte los tapones de la cubierta en sus orificios correspondientes de la caja de altavoces.



- Cuando monte la cubierta, asegúrese de empujar por la parte de los tapones. La cubierta de altavoces está hecha de material blando, por lo que si se empuja por una parte que no hay tapones, pueden dañarse los altavoces.

7 Selector de tensión

Antes de conectar el cable de alimentación de CA, compruebe el ajuste del selector de tensión que se incorpora para ciertos destinos. Para ajustar el selector a 110V, 127V, 220V ó 240V de la red de alimentación, emplee un destornillador de cabeza recta "-" para girar el selector de modo que la tensión correcta de su zona aparezca al lado del indicador del panel. El selector de tensión se ajusta a 240V cuando la unidad sale de fábrica.

Después de haber seleccionado la tensión correcta, enchufe el cable de alimentación.

8 Ajuste los reguladores

Para la estabilidad del aparato, se proporciona un ajustador en la parte inferior de la caja de pedales. Gire el ajustador hasta que contacte firmemente con el suelo. El ajustador asegura una operación estable de los pedales y facilita el control del efecto de los pedales. Si el ajustador no contacta firmemente con el suelo, puede resultar en sonido distorsionado.

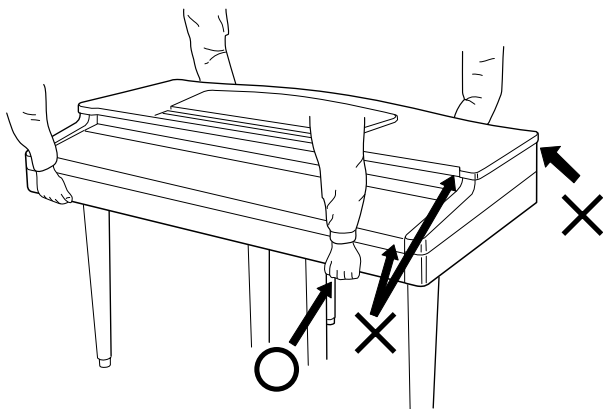

CAUTION

- When moving the instrument after assembly, always hold the lower surface of the main unit, NEVER the top portion or keyboard cover. Improper handling can result in damage to the instrument or personal injury.

VORSICHT

- Fassen Sie zum Umstellen des Instruments nach dem Zusammenbau stets unter das Gehäuse; heben Sie es NIE-MALS am oberen Teil des Gehäuses oder am Tastaturdeckel. Bei Nichtbeachtung dieses Punkts kann das Instrument beschädigt und im Extremfall eine Verletzung hervorgerufen werden.

PRECAUTION

- Pour déplacer l'instrument après le montage, toujours tenir l'instrument par la surface inférieure, JAMAIS par sa partie supérieure ou par le protège-clavier. Une mauvaise manipulation peut provoquer des dommages ou des blessures.

CUIDADO

- Cuando mueva el instrumento después del montaje, sostenga siempre la superficie inferior de la unidad principal, y NUNCA la parte superior de la cubierta del teclado. La manipulación indebida puede causar daños en el instrumento o personales.

After completing the assembly, please check the following.

- Are there any parts left over?
 - Review the assembly procedure and correct any errors.
- Is the Clavinova clear of doors and other movable fixtures?
 - Move the Clavinova to an appropriate location.
- Does the Clavinova make a rattling noise when you shake it?
 - Tighten all screws.
- Does the pedal box rattle or give way when you step on the pedals?
 - Turn the adjuster so that it is set firmly against the floor.
- Are the pedal and power cords inserted securely into the sockets?
 - Check the connection.
- If the main unit creaks or is otherwise unsteady when you play on the keyboard, refer to the assembly diagrams and retighten all screws.

Lorsque le montage est terminé, veuillez mener à bien les vérifications suivantes.

- Reste-t-il des pièces non utilisées?
 - Passer en revue la procédure de montage et corriger toute erreur éventuelle.
- Le Clavinova est-il placé à l'écart des portes et de toute autre structure mobile?
 - Déplacer le Clavinova vers un emplacement approprié.
- Lorsque vous secouez quelque peu le Clavinova, entendez-vous un cliquetis?
 - Serrer convenablement toutes les vis.
- Le pédalier fait-il du bruit ou s'écarte-t-il lorsque vous appuyez sur les pédales?
 - Tourner le stabilisateur de sorte que le Clavinova repose fermement sur le sol.
- Les cordons des pédales et d'alimentation sont-ils bien enfoncés dans les prises?
 - Vérifier toutes les connexions.
- Si la partie principale de l'appareil craque ou est instable lorsque vous jouez sur le clavier, consulter les diagrammes de montage et resserrer toutes les vis.

Wenn der Zusammenbau beendet ist, prüfen Sie bitte folgende Dinge:

- Sind Teile übrig geblieben?
 - Gehen Sie den Vorgang des Zusammenbaus noch einmal durch und korrigieren Sie eventuelle Fehler.
- Befindet sich das Clavinova weit genug von Türen und anderen beweglichen Vorrichtungen entfernt?
 - Bewegen Sie das Clavinova an einen entsprechend sicheren Ort.
- Macht das Clavinova Klappergeräusche, wenn Sie es schütteln?
 - Ziehen Sie alle Schrauben fest.
- Klappert der Pedalkasten oder gibt er nach, wenn Sie das Pedal treten?
 - Drehen Sie den Höhenversteller, bis er fest auf dem Fußboden steht.
- Sind Pedal- und Netzkabel richtig an den Buchsen angeschlossen?
 - Prüfen Sie die Verbindung.
- Wenn die Haupteinheit knarrt oder beim Spielen wackelt, betrachten Sie die Abbildungen und ziehen Sie alle Schrauben noch einmal nach.

Cuando haya concluido el montaje, compruebe los siguientes puntos:

- ¿Ha quedado alguna pieza sin instalar?
 - Revise el procedimiento de montaje y corrija cualquier error que se haya podido cometer.
- ¿Está el Clavinova alejado del recorrido de puertas y muebles?
 - Traslade el Clavinova a una posición adecuada.
- ¿Suena algún ruido de holgura cuando se mueve el Clavinova?
 - Apriete con firmeza todos los tornillos.
- ¿Vibra o cede la caja de pedales cuando se pisan los pedales?
 - Gire el estabilizador hasta que apoye firmemente sobre el suelo.
- ¿Están perfectamente insertados los cables de pedal y alimentación en los conectores?
 - Revise las conexiones.
- Si la unidad principal cruje o presenta algún signo de inestabilidad cuando se toca el teclado, consulte los esquemas de montaje y vuelva a apretar todos los tornillos.

