

YAMAHA PORTATONE

PSR-1700

PSR-2700

ENGLISH

DEUTSCH

FRANÇAIS

ESPAÑOL

Owner's Manual

Bedienungsanleitung

Mode d'emploi

Manual de instrucciones

Wichtiger Hinweis für die Benutzung in der Bundesrepublik Deutschland.

Bescheinigung des Importeurs

Hiermit wird bescheinigt, daß der/die/das

Electronic Keyboard Typ: PSR-1700/PSR-2700

(Gerät, Typ, Bezeichnung)

in Übereinstimmung mit den Bestimmungen der

VERFÜGUNG 1046/84

(Amtsblattverfügung)

funk-entstört ist.

Der Deutschen Bundespost wurde das Inverkehrbringen dieses Gerätes angezeigt und die Berechtigung zur Überprüfung der Serie auf Einhaltung der Bestimmungen eingeräumt.

Yamaha Europa GmbH

Name des Importeurs

- This applies only to products distributed by Yamaha Europa GmbH.
- Dies bezieht sich nur auf die von der Yamaha Europa GmbH vertriebenen Produkte.

Entsorgung leerer Batterien (nur innerhalb Deutschlands)

Leisten Sie einen Beitrag zum Umweltschutz. Verbrauchte Batterien oder Akkumulatoren dürfen nicht in den Hausmüll. Sie können bei einer Sammelstelle für Altbatterien bzw. Sondermüll abgegeben werden. Informieren Sie sich bei Ihrer Kommune.

CANADA

THIS DIGITAL APPARATUS DOES NOT EXCEED THE "CLASS B" LIMITS FOR RADIO NOISE EMISSIONS FROM DIGITAL APPARATUS SET OUT IN THE RADIO INTERFERENCE REGULATION OF THE CANADIAN DEPARTMENT OF COMMUNICATIONS.

LE PRESENT APPAREIL NUMERIQUE N'EMET PAS DE BRUITS RADIOELECTRIQUES DEPASSANT LES LIMITES APPLICABLES AUX APPAREILS NUMERIQUES DE LA "CLASSE B" PRESCRITES DANS LE REGLEMENT SUR LE BROUILLAGE RADIOELECTRIQUE EDICTE PAR LE MINISTERE DES COMMUNICATIONS DU CANADA.

- This applies only to products distributed by Yamaha Canada Music Ltd.
- Ceci ne s'applique qu'aux produits distribués par Yamaha Canada Music Ltd.

NAME PLATE LOCATION: The graphic below indicates the location of the name plate. The model number, serial number, power requirements, etc., are located on this plate. You should record the model number, serial number, and the date of purchase in the spaces provided below and retain this manual as a permanent record of your purchase.

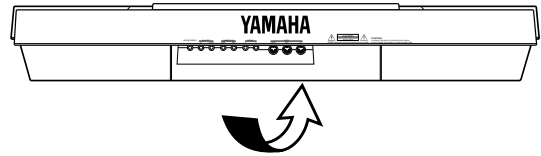

Model _____

Serial No. _____

Purchase Date _____

Dit produkt is gefabriceerd in overeenstemming met de radiostoringsvoorschriften van de Richtlijn van de Raad (82/499/EEG).

ΑΥΤΗ Η ΣΥΣΚΕΥΗ ΑΝΤΑΠΟΚΡΙΝΕΤΑΙ ΣΤΙΣ ΑΠΑΙΤΗΣΕΙΣ ΤΩΝ ΟΔΗΓΙΩΝ ΤΗΣ ΕΥΡΩΠΑΙΚΗΣ ΟΙΚΟΝΟΜΙΚΗΣ ΚΟΙΝΟΤΗΤΑΣ 82/499/Ε.Ο.Κ..

Este produto está de acordo com o radio de interferencia frequente requeridos do Conselho Diretivo 82/499/EEC.

Dette apparat overholder det gældende EF-direktiv vedrørende radiostøj.

Cet appareil est conforme aux prescriptions de la directive communautaire 87/308/CEE.

Diese Geräte entsprechen der EG-Richtlinie 82/499/EWG und/oder 87/308/EWG.

This product complies with the radio frequency interference requirements of the Council Directive 82/499/EEC and/or 87/308/EEC.

Questo apparecchio è conforme al D.M.13 aprile 1989 (Direttiva CEE/87/308) sulla soppressione dei radiodisturbi.

Este producto está de acuerdo con los requisitos sobre interferencias de radio frecuencia fijados por el Consejo Directivo 87/308/CEE.

YAMAHA CORPORATION

OBSERVERA!

Apparaten kopplas inte ur växelströmskällan (nätet) så länge som den är ansluten till vägguttaget, även om själva apparaten har stängts av.

ADVARSEL: Netspændingen til dette apparat er IKKE afbrudt, så længe netledningen sidder i en stikkontakt, som er t endt — også selvom der er slukket på apparatets afbryder.

VAROITUS: Laitteen toisiopiiriin kytketty käyttökytkin ei irroita koko laitetta verkosta.

Congratulations!

You are the proud owner of a Yamaha PSR-1700/PSR-2700. Your PSR-1700/PSR-2700 is a high-quality musical instrument that incorporates advanced Yamaha digital technology and many versatile features. In order to obtain maximum performance and enjoyment from your PSR-1700/PSR-2700, we urge you to read this Owner's Manual thoroughly while trying out the various features described. Keep the Owner's Manual in a safe place for later reference.

Contents

Panel Controls	2	Custom Accompaniment	47
Taking Care of Your PortaTone	4	■ Realtime Custom Accompaniment Recording	47
Preparation	5	■ Using a Custom Accompaniment	49
■ Power Supply	5	Step Recording	50
■ Installing the Backup Batteries	5	Editing Functions	53
■ Using Headphones	6	■ Quantization	53
■ Connecting to an External Sound System	6	■ Clearing Tracks	54
■ Using Pedals	6	■ Changing the Recorded Settings	55
■ The Music Stand	6	Using Floppy Disks	56
Listen to the Demo!	7	■ Formatting a New Floppy Disk	57
■ Try the Disk Demo, Too!	8	■ Saving, Loading, & Deleting Disk Files	58
Basic Editing Procedure	9	● Saving to Disk	58
Selecting & Playing the Voices	11	● Loading From Disk	60
■ Orchestration	11	● Deleting a Disk File	61
■ Voice Assignment	13	■ Quick Play: Disk Orchestra Collection & Standard MIDI File Disks	62
■ Volume	14	● Minus One Playback	62
■ Octave	14	PSR-2700 Digital Sampling	63
■ DSP Depth	15	■ Connections	63
■ Pan	15	■ Setting the Input Level	63
■ Auto Harmony	16	■ Setting the Sampling Frequency	64
■ Effects	17	■ Setting the Trigger Level	65
■ Keyboard Percussion	18	■ Recording	66
■ Pitch Bend	18	■ Playing the Sample Pads	67
■ Modulation	19	■ Editing Samples	68
Overall Control	20	● Clearing Samples	68
■ Split Point Change	20	● Tuning the Samples	68
■ Transpose	21	● Volume, DSP Depth, & Pan Settings	69
■ Tuning	21	◆ Individual SAMPLE PAD Volume Settings	69
■ DSP Type	22	■ Playing Samples via the Keyboard	70
■ Touch Sensitivity	23	● Mapping	70
Auto Accompaniment	24	■ Sample Memory Backup & Disk Storage	71
■ Selecting a Style	24	Pedal Assign	72
■ Setting the Auto Accompaniment Split Point	25	MIDI	73
■ Auto Accompaniment Fingering	25	MIDI Reception Modes	74
■ Tempo Control	28	■ Channel Reception Modes	74
■ Accompaniment Control	29	■ Clock Mode	75
■ Accompaniment Volume	32	■ Start/Stop Mode	75
■ The Track Buttons	33	MIDI Transmission	76
■ Re-voicing the Tracks	34	■ MIDI Transmit Channels	76
One Touch Setting	36	■ Local & MIDI Output ON/OFF	76
Registration Memory	37	Appendix	77
Record Functions	39	■ Voice & Polyphony List	77
Song Memory	39	■ Style List	78
■ Realtime Accompaniment Track Recording	40	■ Error Messages	81
■ Realtime Melody Track Recording	42	■ System Reset Procedure	82
■ Accompaniment And Melody Playback	43	■ Troubleshooting	83
■ The [RESET] Button	44	Index	84
■ Record Or Play from a Specified Measure	44	Percussion Kit List	338
The Multi Pads	45	MIDI Implementation Chart	340
■ Realtime Recording	45	Specifications	343
■ Playback	46		

Panel Controls

PSR-1700

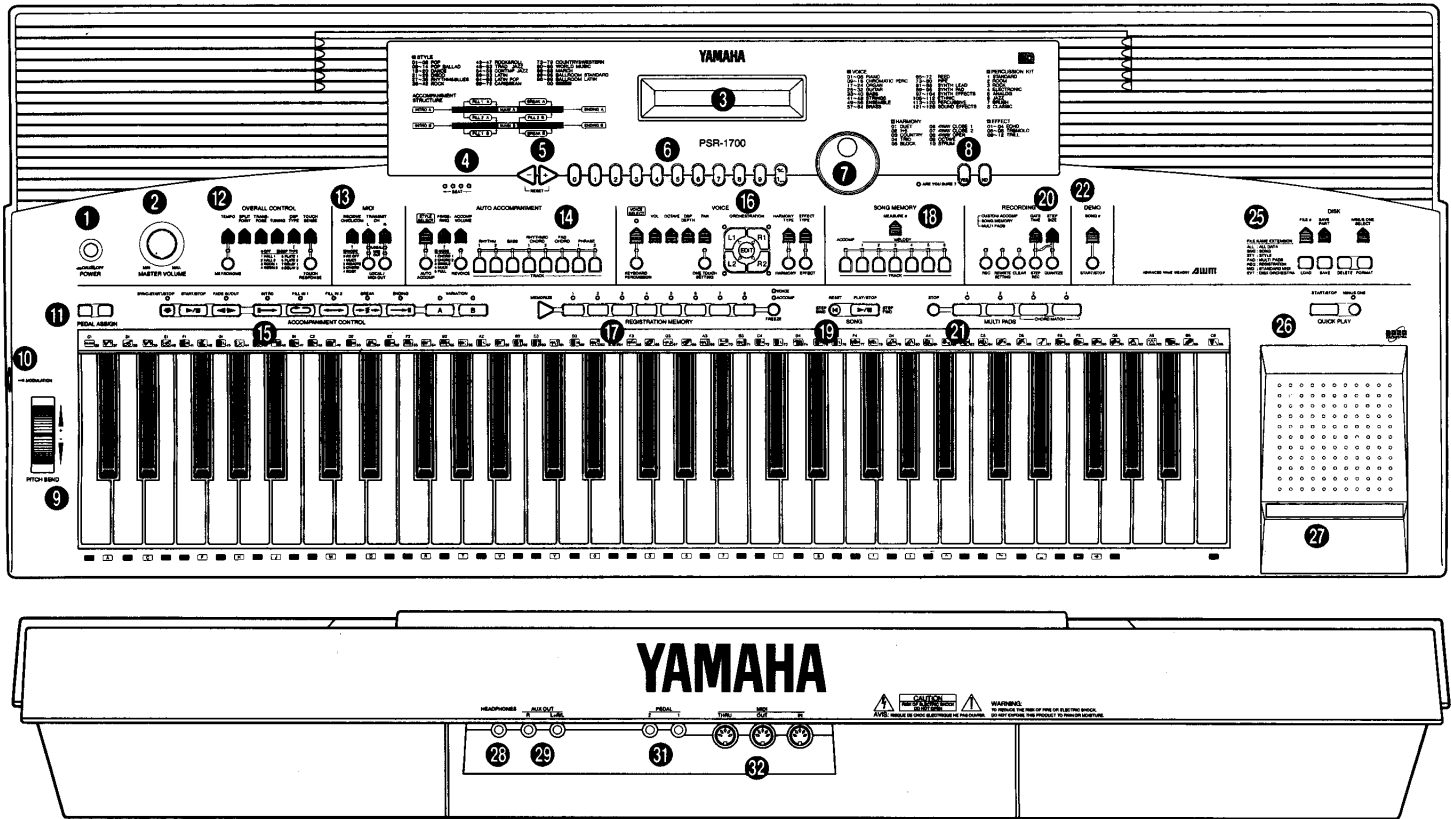

Top Panel Controls

- ❶ POWER Buttonpage 7
- ❷ MASTER VOLUME Controlpage 7
- ❸ LCD Display Panelpage 7
- ❹ BEAT Indicatorpage 29
- ❺ [+], [-] Buttonspage 10
- ❻ Number Buttons [0]...[9], [+/-]page 10
- ❼ Data Dialpage 10
- ❽ ARE YOU SURE ? [YES], [NO] Buttonspage 10
- ❾ PITCH BEND Wheelpage 18
- ❿ MODULATION Buttonpage 19
- ⓫ PEDAL ASSIGN [1], [2] Buttonspage 72
- ⓬ OVERALL CONTROL Section
 - TEMPO Buttonpage 28
 - METRONOME Buttonpage 28
 - SPLIT POINT Buttonpage 20
 - TRANSPOSE Buttonpage 21
 - TUNING Buttonpage 21
 - DSP TYPE Buttonpage 22
 - TOUCH SENSE Buttonpage 23
 - TOUCH RESPONSE Buttonpage 23
- ⓭ MIDI Section
 - RECEIVE CH/CL/COM Buttonpage 74, 75
 - TRANSMIT CH [L] Buttonpage 76
 - LOCAL/MIDI OUT Buttonpage 76
 - TRANSMIT CH [R] Buttonpage 76
 - LOCAL/MIDI OUT Buttonpage 76
- ⓮ AUTO ACCOMPANIMENT Section
 - STYLE SELECT Buttonpage 24

- AUTO ACCOMP Buttonpage 25
- FINGERING Buttonpage 25
- ACCOMP VOLUME Buttonpage 32
- REVOICE Buttonpage 34
- TRACK (RHYTHM1, 2, BASS, RHYTHMIC CHORD 1, 2, PAD CHORD, PHRASE1, 2) Buttonspage 33
- ⓯ ACCOMPANIMENT CONTROL Section
 - SYNC-START/STOP Buttonpage 29
 - START/STOP Buttonpage 29, 31
 - FADE IN/OUT Buttonpage 32
 - INTRO Buttonpage 30
 - FILL IN 1 Buttonpage 30
 - FILL IN 2 Buttonpage 30
 - BREAK Buttonpage 30
 - ENDING Buttonpage 31
 - VARIATION A/B Buttonspage 30
- ⓰ VOICE Section
 - VOICE SELECT Buttonpage 13
 - KEYBOARD PERCUSSION Buttonpage 18
 - SAMPLED VOICE Button (PSR-2700 only)page 70
 - VOL Buttonpage 14
 - OCTAVE Buttonpage 14
 - DSP DEPTH Buttonpage 15
 - PAN Buttonpage 15
 - ONE TOUCH SETTING Buttonpage 36
 - ORCHESTRATION R1, R2, L1, L2, & EDIT Buttonspage 11, 12
 - HARMONY TYPE Buttonpage 16
 - HARMONY Buttonpage 16
 - EFFECT TYPE Buttonpage 17
 - EFFECT Buttonpage 17

PSR-2700

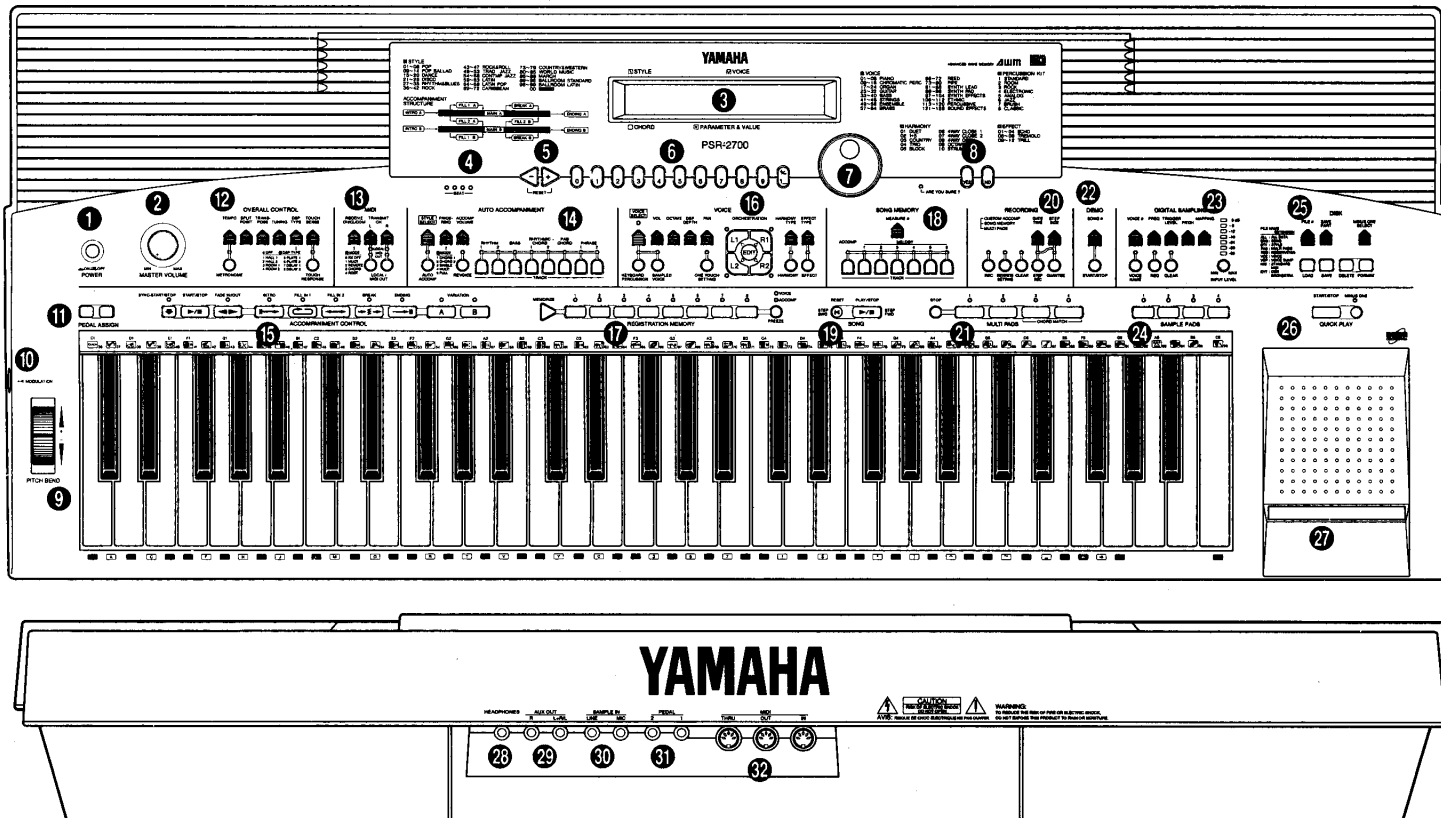

17 REGISTRATION MEMORY Section

- MEMORIZE Buttonpage 37
- [1]...[8] Buttonspage 37
- FREEZE Buttonpage 38

18 SONG MEMORY Section

- MEASURE# Buttonpage 44
- TRACK (ACCOMP, MELODY1...6) Buttonspage 40-43

19 SONG Section

- RESET (STEP BWD) Buttonpage 44, 51
- PLAY/STOP (STEP FWD) Buttonpage 43, 51

20 RECORDING Section

- REC Buttonpage 40, 42, 45, 48
- REWRITE SETTING Buttonpage 55
- CLEAR Buttonpage 54
- GATE TIME Buttonpage 51
- STEP REC Buttonpage 50
- STEP SIZE Buttonpage 50
- QUANTIZE Buttonpage 53

21 MULTI PADS Section

- STOP Buttonpage 46
- PAD [1]...[4] Buttonspage 45

22 DEMO Section

- SONG# Buttonpage 7
- START/STOP Buttonpage 7

23 DIGITAL SAMPLING Section (PSR-2700 only)

- VOICE # Buttonpage 66
- VOICE NAME Buttonpage 67
- FREQ Buttonpage 64
- REC Buttonpage 63, 66
- TRIGGER LEVEL Buttonpage 65

- CLEAR Buttonpage 68
- PITCH Buttonpage 68
- MAPPING Buttonpage 70
- INPUT LEVEL Control & Indicatorpage 64

24 SAMPLE PADS Section (PSR-2700 only)

- PAD [1]...[4] Buttonspage 66

25 DISK Section

- FILE # Buttonpage 58, 60, 61
- SAVE PART Buttonpage 58
- MINUS ONE SELECT Buttonpage 62
- LOAD Buttonpage 60
- SAVE Buttonpage 59
- DELETE Buttonpage 61
- FORMAT Buttonpage 57

26 QUICK PLAY Section

- START/STOP Buttonpage 62
- MINUS ONE Buttonpage 62

27 Floppy Disk Drivepage 56

Rear Panel Controls

- 28 HEADPHONES Jackpage 6
- 29 AUX OUT L+R/L & R Jackspage 6
- 30 SAMPLE IN LINE & MIC Jacks (PSR-2700 only)page 6, 23
- 31 PEDAL 1 & 2 Jackspage 6, 72
- 32 MIDI IN, OUT and THRU Connectorspage 73

Taking Care of Your PortaTone

Your PortaTone will give you years of playing pleasure if you follow the simple rules given below:

■ Location

Do not expose the instrument to the following conditions to avoid deformation, discoloration, or more serious damage.

- Direct sunlight (e.g. near a window).
- High temperatures (e.g. near a heat source, outside, or in a car during the daytime).
- Excessive humidity.
- Excessive dust.
- Strong vibration.

■ Power Supply

- Turn the power switch OFF when the instrument is not in use.
- The power cord should be unplugged from the AC outlet if the instrument is not to be used for an extended period of time.
- Unplug the instrument during electric storms.
- Avoid plugging the instrument into the same AC outlet as appliances with high power consumption, such as electric heaters or ovens. Also avoid using multi-plug adaptors since these can result in reduced sound quality and possibly damage.

■ Turn Power OFF When Making Connections

- To avoid damage to the instrument and other devices to which it is connected (a sound system, for example), turn the power switches of all related devices OFF prior to connecting or disconnecting audio and MIDI cables.

■ Handling and Transport

- Never apply excessive force to the controls, connectors or other parts of the instrument.
- Always unplug cables by gripping the plug firmly, not by pulling on the cable.
- Disconnect all cables before moving the instrument.
- Physical shocks caused by dropping, bumping, or placing heavy objects on the instrument can result in scratches and more serious damage.

■ Cleaning

- Clean the cabinet and panel with a dry soft cloth.
- A slightly damp cloth may be used to remove stubborn grime and dirt.
- Never use cleaners such as alcohol or thinner.
- Avoid placing vinyl objects on top of the instrument (vinyl can stick to and discolor the surface).

■ Electrical Interference

- This instrument contains digital circuitry and may cause interference if placed too close to radio or television receivers. If this occurs, move the instrument further away from the affected equipment.

■ Service and Modification

- The PSR-1700/PSR-2700 contains no user serviceable parts. Opening it or tampering with it in anyway can lead to irreparable damage and possibly electric shock. Refer all servicing to qualified YAMAHA personnel.

■ Data Backup

- Internal data (e.g. Song Memory data) is retained in memory even if the power switch is turned off as long as backup batteries are installed (page 5) or the AC plug is connected. The internal memory can, however, be corrupted by incorrect operation. Be sure to save important data to floppy disk frequently so you have a backup to revert to if the data in memory is accidentally damaged. Also note that magnetic fields can damage data on floppy disks, so it is advisable to make a second backup copy of disks that contain particularly important data. Always keep backup disks in a safe place away from stray magnetic fields (e.g. those produced by speakers, appliances containing motors, etc.). More important precautions for floppy disk use are given in the “Floppy Disk” section beginning on page 56.

Preparation

This section contains information about setting up your PSR-1700 or PSR-2700 and preparing to play. Be sure to go through this section carefully before using your PSR-1700/PSR-2700.

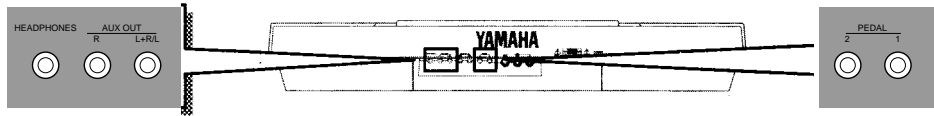

Power Supply

After making sure that the AC mains voltage and frequency specified for your PSR-1700/PSR-2700 matches your local power supply (check the label on the bottom panel), plug the power cord into a convenient AC outlet.

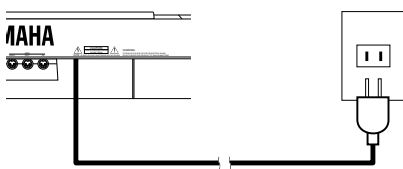

- **Never interrupt the power supply (e.g. unplug the power cord) during any record or disk operation! Doing so can result in a loss of data.**

Installing the Backup Batteries

For memory backup the PSR-1700/PSR-2700 requires four 1.5V SUM-3, “AA” size, R-6 or equivalent batteries. All PSR-1700 and PSR-2700 features will operate without these batteries installed, but song memory and other data that is not saved to disk will be lost when the power is turned off. To prevent accidental loss of data, we recommend that a set of backup batteries be installed while the instrument is in regular use. When the backup batteries need to be replaced “Backup Battery Low” will appear on the LCD display panel when the power is initially turned on (this also occurs if no backup batteries are installed). Try to replace the batteries before they fail and the backup memory contents are lost.

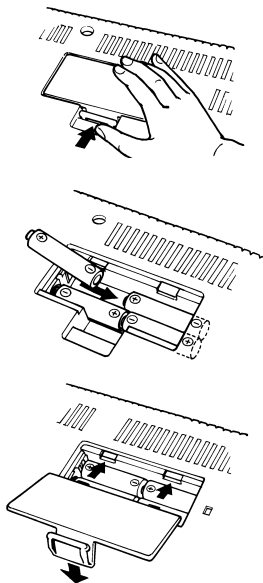

- 1** Open the battery compartment cover located on the instrument’s bottom panel.
- 2** Insert the four new batteries, being careful to follow the polarity markings on the inside of the compartment.
- 3** Replace the compartment cover, making sure that it locks firmly in place.



- **When the batteries run down, replace them with a complete set of four new batteries. NEVER mix old and new batteries.**
- **Do not use different kinds of batteries (e.g. alkaline and manganese) at the same time.**
- **To prevent possible damage due to battery leakage, remove the batteries from the instrument if it is not to be used for an extended period of time.**
- **When you replace the batteries, any backed-up data will be lost. To avoid this, be sure to save your valuable data to a floppy disk before replacing the batteries.**

Preparation

Using Headphones

HEADPHONES

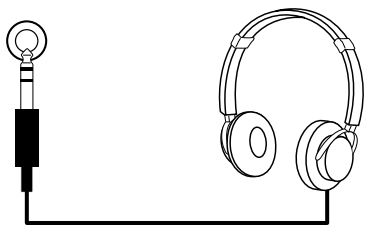

A standard pair of stereo headphones can be plugged into the rear-panel **HEADPHONES** jack for private practice or late-night playing. The internal speaker system is automatically shut off when a pair of headphones is plugged into the **HEADPHONES** jack.

Connecting to an External Sound System

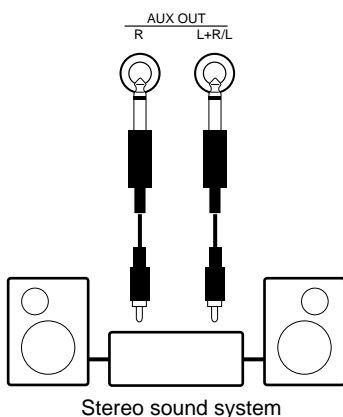

The **AUX OUT L+R/L** and **R** jacks deliver the output of the PSR-1700/PSR-2700 for connection to an instrument amplifier, mixing console, PA system, or recording equipment. If you will be connecting the PSR-1700/PSR-2700 to a monophonic sound system, use only the **L+R/L** jack. When a plug is inserted into the **L+R/L** jack only, the left- and right-channel signals are combined and delivered via the **L+R/L** jack so you don't lose any of the instrument's sound.

Using Pedals

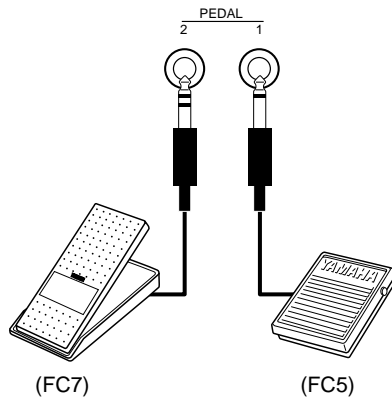

An optional Yamaha FC4 or FC5 footswitch or FC7 foot controller can be plugged into either or both of the rear-panel **PEDAL** jacks.

The **PEDAL 1** jack is initially assigned to sustain control. A footswitch connected to this jack functions as a damper pedal, controlling sustain. Press the pedal to sustain notes after the keys are released.

The **PEDAL 2** jack is initially assigned to the voice volume control (MIDI Expression control). An FC7 foot controller connected to this jack can be used to control voice volume: press the pedal forward to increase voice volume; backward to decrease voice volume.

Both the **PEDAL** jacks can be assigned to a wide range of other functions as described in the "Pedal Assign" section on page 72.

The Music Stand

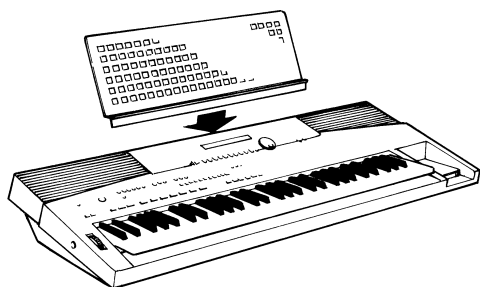

Insert the bottom edge of the music stand into the slot located at the rear of the control panel.

Listen to the Demo!

Once you've set up your PSR-1700/PSR-2700, try listening to the pre-programmed demonstration songs — they'll give you a good idea of what the PSR-1700/PSR-2700 can do!

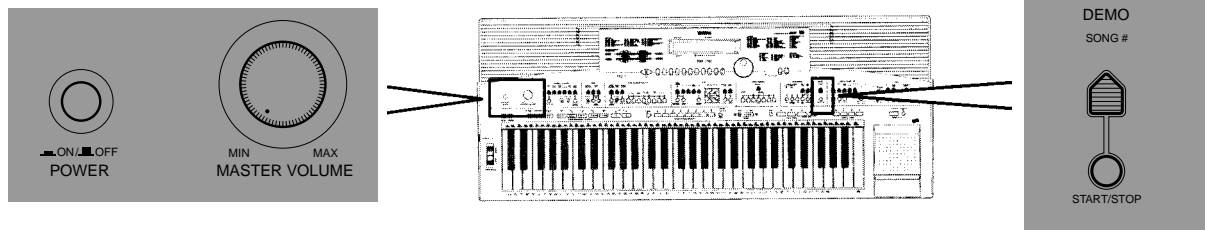

1 Turn the Power ON & Set the Volume

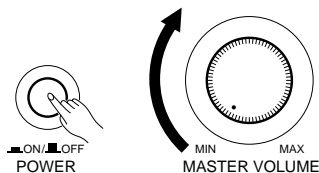

Before playing the demo turn the power ON by pressing the **POWER** switch (the panel indicators and LCD display panel will light), and turn the **MASTER VOLUME** control up (clockwise) about a quarter-turn from its minimum position.

2 Select a Song

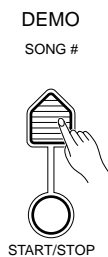

Press the DEMO [SONG #] button a few times until the number of the desired demo song appears on the LCD display.

PSR-1700

Demo=0:ChainPlay

PSR-2700

08:Showtune 001:GrandPno
AccOff Demo=0:ChainPlay

0 (ChainPlay): Repeat playback of all demo songs in sequence.

1-8: Repeat playback of the selected demo song number.



• "0:ChainPlay" is automatically selected whenever the power switch is turned on.

3 Press DEMO [START/STOP] to Start

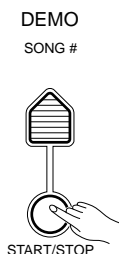

Press the DEMO [START/STOP] button to start playback, and use the **MASTER VOLUME** control to set the ideal listening level. The selected demonstration will play repeatedly.



• During demo playback you can select different voices and play along on the keyboard — see the "Selecting & Playing the Voices" section beginning on page 11.

4 Press DEMO [START/STOP] to Stop

Press the DEMO [START/STOP] button again to stop demo playback.

Listen to the Demo!

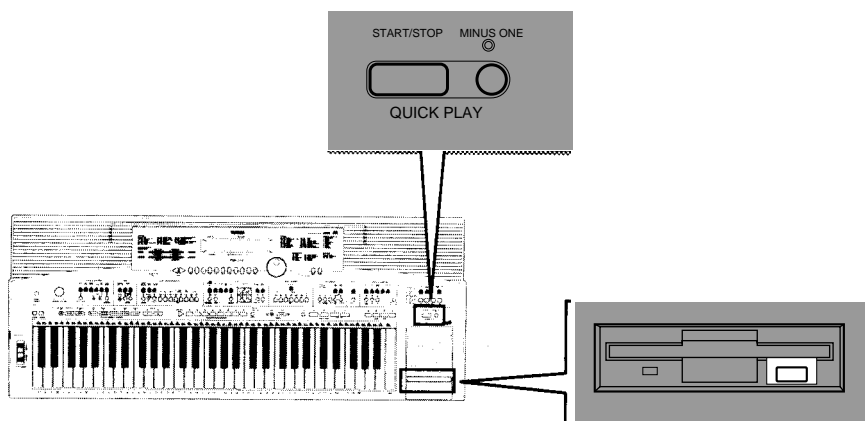

■ Try the Disk Demo, Too!

The PSR-1700 and PSR-2700 also come supplied with demonstration floppy disks that you can play as follows:



- *The PSR-1700 comes with one demonstration disk containing 4 demonstration songs, while the PSR-2700 includes an additional disk containing 2 demo songs that make use of the PSR-2700's Digital Sampling feature.*

1 Insert the Demo Disk

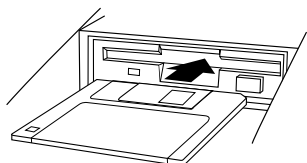

Insert demonstration disk into the disk drive unit with the sliding door facing the drive slot and the label side of the disk facing upward. The disk should click securely into place.

2 Start Playback

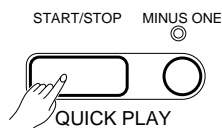

Press the QUICK PLAY [START/STOP] button to start playback. The disk demo songs will play back in sequence.



- *If the demo requires sampled voice data included in the disk (PSR-2700 only) the sampled voice data will automatically be loaded into sampled voice number 128 before demo playback begins. If there is already sampled voice data in memory or the wave RAM is full, the disk may not load automatically. See page 60 for details.*
- *If you simply press the QUICK PLAY [START/STOP] button playback will begin from the lowest file number on the disk. It is also possible to specify the file number from which playback is to begin prior to pressing the [START/STOP] button.*



- *Never attempt to eject the demonstration disk(s) or turn the power off during demo playback. Doing so can damage both the disk drive and the disk.*

3 Stop the Demo & Eject the Disk

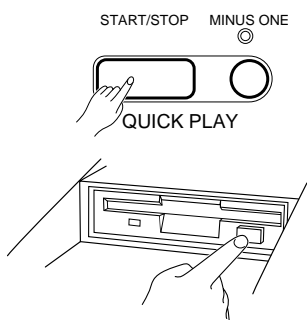

When you're ready to stop the demo, press the QUICK PLAY [START/STOP] button to stop playback, then press the disk drive eject button and remove the disk.

Basic Editing Procedure

The PSR-1700 and PSR-2700 feature a flexible-but-consistent interface that lets you edit just about all of its parameters using the same basic procedure. Once familiar with the system, you'll be able to edit any parameter quickly and easily. Here's the basic procedure:

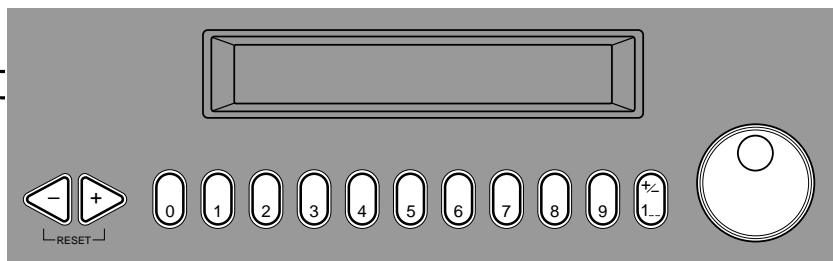
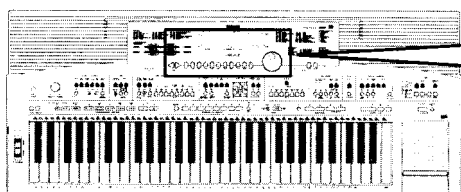

1 Press a Function Button



First press the button corresponding to the function or parameter you want to edit. To select voice numbers, for example, press the **[VOICE SELECT]** button (its indicator will light). The name of the selected parameter and its current value will be shown on the LCD display panel.

● The LCD Display Panel

The PSR-2700 and PSR-1700 feature backlit LCD display panels that make it easy to select and edit parameters as well as perform all other operations. The PSR-2700 display has two lines of 24 characters each, while the PSR-1700 has one line of 16 characters.

PSR-2700

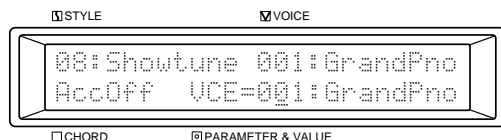

The PSR-2700 display has four sections: **STYLE**, **VOICE**, **CHORD**, and **PARAMETER & VALUE**. The **STYLE** and **VOICE** sections on the upper line always show the currently selected accompaniment style and voice. The **CHORD** section on the lower line shows the detected chord when the Auto Accompaniment feature is used, and the **PARAMETER & VALUE** section shows the parameter and value currently selected for editing.

PSR-1700

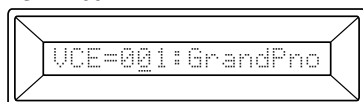

The PSR-1700 display always shows the parameter and value currently selected for editing.



- "Now Processing" may appear on the LCD display panel while the PSR-1700/PSR-2700 is processing the data (for example recorded data) or ready to process it.

2 Edit the Parameter

The PSR-1700 and PSR-2700 let you edit parameters using four different methods. Use the one that best suits the parameter you have selected:

2-1: The Function Button



Each time you press a function button after initially selecting the function, the value of the corresponding parameter will be incremented (increased) by one. If you hold the function button for a few seconds, the parameter will begin to increment continuously as long as you hold the button.

If, for example, you press the **[VOICE SELECT]** button and LCD display panel shows that voice number 36 (VCE=036:Fretless) is currently selected, you can select voice number 37 (VCE=037:SlapBas1) simply by pressing the **[VOICE SELECT]** button again.



- The **SPLIT POINT** button, **MAPPING** button (PSR-2700), and **PITCH** button (PSR-2700) are exceptions.

Basic Editing Procedure

2-2: The [+] and [-] Buttons

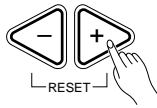

The [+] and [-] buttons can be used to increment (increase by one) or decrement (decrease by one) the currently selected parameter. Press the [+] button briefly to increment the parameter value, or the [-] button to decrement. If you hold the [+] or [-] button down, the value will increment or decrement continuously — simply release the button when the desired value has been reached.

2-3: The Number Buttons

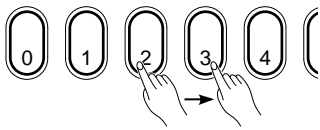

The number buttons — to the right of the [+] and [-] buttons — allow direct numeric entry of the desired value, and are therefore the fastest way to edit in many situations.

To select a voice, for example, choose one of the 128 voices — numbered “01” through “128” — listed in the “Voice & Polyphony List” on page 77, then enter its number using the number buttons. To select “Harmonica” (number 23), for example, first press [2] then [3]. The number “23” should then appear on the LCD display panel along with the name “Harmnica”.

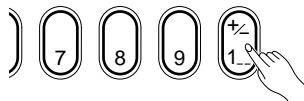

The [+/-] button is used to switch between positive and negative values with parameters that allow negative values (Transpose, Tuning, Octave, and Pan, for example). A “-” appears before negative values on the LCD display panel.

Example: Voice number “120”

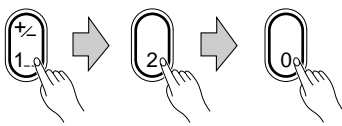

When selecting voice numbers the [+/-] button is used to enter the hundreds digit of the voice number (the button alternately selects no hundreds digit or “1”), as required, prior to entering the tens and ones digits. The [1] number button cannot be used to enter the hundreds digit when selecting voices.

Values outside the range of the selected parameter can not be entered.

2-4: The Data Dial

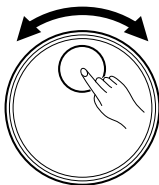

This is undoubtedly the easiest way to edit most parameters. Simply rotate the dial clockwise to increment or counter-clockwise to decrement.



- After editing a parameter other than [VOICE SELECT], the [VOICE SELECT] parameter will automatically be re-selected after a brief delay.
- If you attempt to change a parameter that can not be edited in the current mode, “IllegalOperation” will appear on the LCD display.

● Yes/No Confirmation



Some operations that change important settings or erase data may require you to confirm your choice by pressing the [YES] or [NO] button. When a choice needs to be confirmed the ARE YOU SURE? indicator will flash and a digitally sampled voice will ask “Are you sure?”. Press the [YES] button to execute the specified operation or the [NO] button to cancel and leave the settings or data unaffected.

If you don’t want to hear the “Are you sure?” confirmation sound, hold down the [NO] button while initially turning the power switch on. To restore the confirmation sound, turn the power switch off, then turn it back on again while holding down the [YES] button. The on/off status of the confirmation sound is retained in memory even when the power switch is turned off as long as the backup batteries are installed or an AC plug is connected.

Selecting & Playing the Voices

The PSR-1700 and PSR-2700 have 128 stunning voices plus 8 different drum and percussion kits that you can select and play in a number of ways.

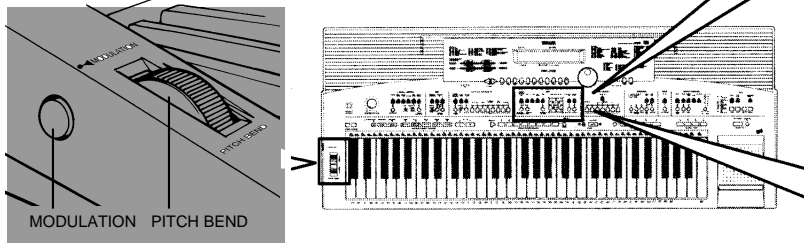

PSR-1700

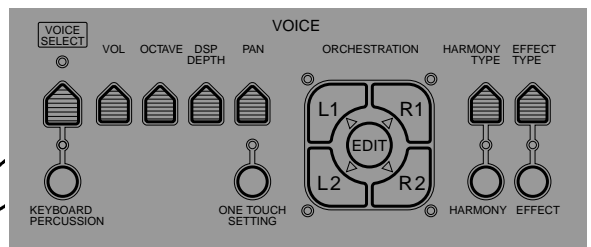

PSR-2700

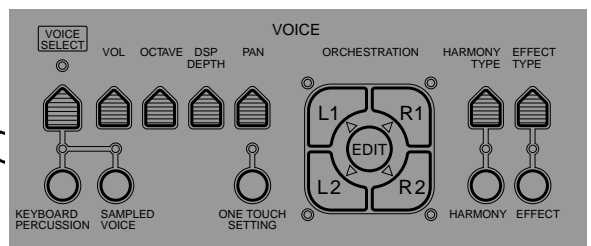

Orchestration

The unique ORCHESTRATION button group in the VOICE control section lets you select and play from one to four “parts” at the same time using a variety of “orchestrations”. One of the 128 voices is assigned to each part.

- **Single:** One voice over the entire keyboard.
- **Dual:** Two voices simultaneously over the entire keyboard.
- **Split:** Different voices with the left and right hands.
- **Split & Dual:** Combinations of the Split and Dual modes.

There are actually a number of variations on each of the above orchestrations. The ORCHESTRATION buttons are used to choose the type of orchestration you want.

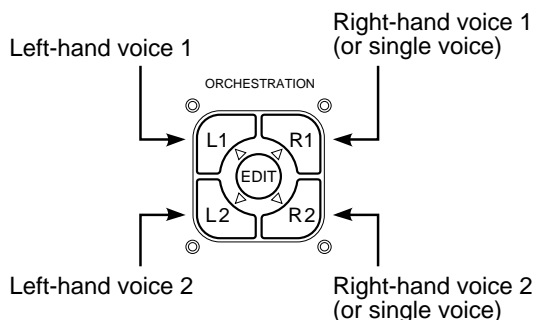

The four available parts are turned on and off by the [R1], [R2], [L1], and [L2] buttons. The indicators next to each of these buttons tell you which parts are on and which are off, and therefore indicate the current orchestration mode. The [EDIT] button determines which of the four orchestration parts is to be edited. You can, for example, assign any of the 128 voices to each of the orchestration parts. But before we discuss voice assignment and editing, let’s take a look at the various orchestration modes:

● Single Modes

In the “single” modes either the [R1] or [R2] part voice can be played over the entire keyboard. The R1 and R2 single-voice modes are selected simply by pressing either the [R1] or [R2] button if neither the [L1] or [L2] indicators are lit. If the [L1] and/or [L2] indicators are lit, press them so that both indicators go out.

Note that when you select the [R1] or [R2] single-voice mode, the triangular EDIT indicator for the selected voice also lights. This means you can select a different voice number or otherwise edit the current voice using the procedures described on page 13.

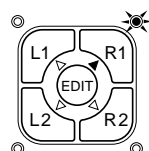

The R1 voice is played across the entire keyboard.

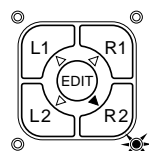

The R2 voice is played across the entire keyboard.

Selecting & Playing the Voices

● Dual Mode

In the dual mode both the [R1] and [R2] part voices are selected so they can be played simultaneously across the entire keyboard. To select the dual mode, make sure that both the [L1] and [L2] indicators are out, then press both the [R1] and [R2] buttons simultaneously (or hold one while pressing the other).

You can switch back to either of the single modes from the dual mode simply by pressing the [R1] or [R2] button, as required.

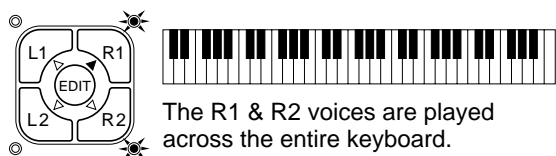

● Split Modes

The PSR-1700 and PSR-2700 allow four different split modes, with one voice played on the left-hand section of the keyboard ([L1] or [L2]) and a different voice on the right-hand section of the keyboard ([R1] or [R2]). Selecting a split mode is simply a matter of pressing the buttons corresponding to the desired left- and right-hand parts.

The split point (i.e. the key at which the voices change over) can be set at any desired key by using the SPLIT POINT CHANGE function described on page 20.

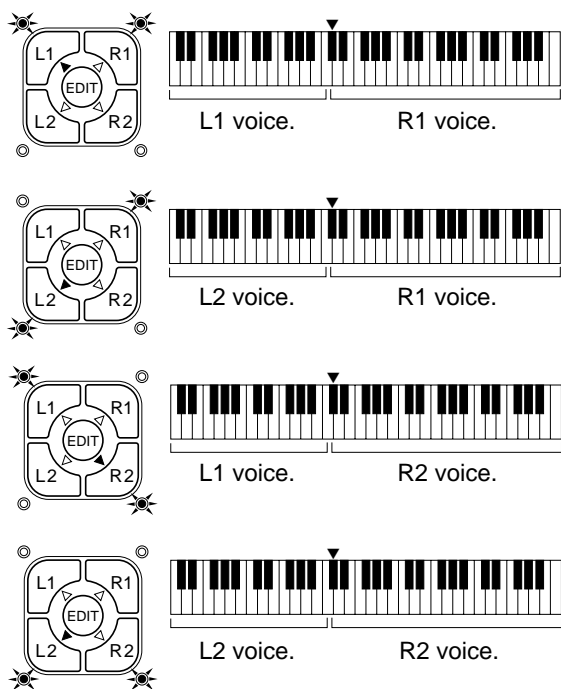

● Split & Dual Modes

There are five possible combinations of the split and dual modes, as shown below. The part for the single-voice side of the combination is selected simply by pressing the appropriate part button, while for the dual-voice side both buttons must be pressed simultaneously (or one while holding the other).

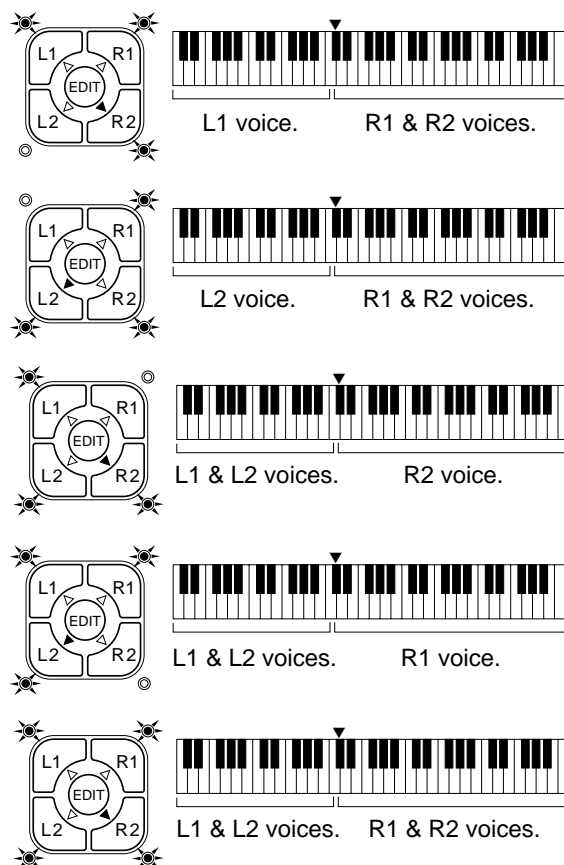

Voice Assignment

You can assign any of the 128 voices to each of the ORCHESTRATION parts, whether the part is currently ON or OFF.

1 Press the [VOICE SELECT] Button

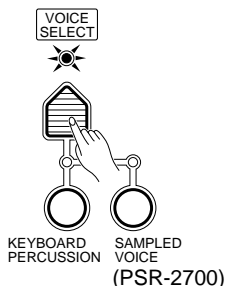

You don't need to do this if the [VOICE SELECT] indicator is already lit. Also make sure that the [KEYBOARD PERCUSSION] and [SAMPLED VOICE] (PSR-2700) indicators are out.

2 Select the Part You Want to Edit



Use the ORCHESTRATION [EDIT] button to select the part to which you want to assign a new voice. The [EDIT] indicators light in sequence in the clockwise direction each time the [EDIT] button is pressed.



- You can edit the voice number of a part that is OFF while playing a different part.
- Actually, the [VOICE SELECT] mode is automatically selected whenever the [EDIT] button is pressed, so you don't really need to press [VOICE SELECT] as described in step 1 if you're going to use the [EDIT] button prior to selecting a voice number.

3 Select a Voice Number



Use the [+], [-], the number buttons, the data dial, or the [VOICE SELECT] button itself to select the required voice number (see page 9 for editing procedure details).

Example: Voice number "120"

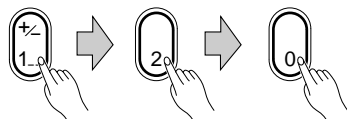

When entering voice numbers higher than 99, use the [+/-] button to enter the hundreds digit prior to entering the tens and ones digits: the button alternately selects no hundreds digit or "1".



- The voice categories are listed in the "VOICE" list on the PSR-1700/PSR-2700 panel. See page 77 for a complete list.
- The optimum keyboard range is preset for each voice.

Selecting & Playing the Voices

Volume

You can individually set the volume of each orchestration part to set up the ideal balance between parts.

1 Select the Part You Want to Edit

Use the ORCHESTRATION [EDIT] button to select the part you want to edit.

2 Press the [VOL] Button

VOL



Press the VOICE control section [VOL] button. The current volume value of the selected part will appear on the LCD display panel.

PSR-1700

Volume=21

PSR-2700

08:Showtune 001:GrandPno
AccOff Volume=21

3 Set the Volume



Use the [+] and [-] buttons, the number buttons, the data dial, or the [VOL] button itself to set the desired volume. The volume range is from 00 (no sound) to 24 (maximum volume). The default volume value (21) can be recalled instantly by pressing both the [+] and [-] buttons at the same time.

Octave

You can individually shift the octave of each orchestration part up or down by up to two octaves. This makes it easy, for example, to lower the pitch of a bass voice to an appropriate octave without affecting the other parts in your orchestration.

1 Select the Part You Want to Edit

Use the ORCHESTRATION [EDIT] button to select the part you want to edit.

2 Press the [OCTAVE] Button

OCTAVE



Press the VOICE control section [OCTAVE] button. The current octave value of the selected part will appear on the LCD display panel.

PSR-1700

Octave= 0

PSR-2700

08:Showtune 001:GrandPno
AccOff Octave= 0

3 Set the Octave



Use the [+] and [-] buttons, the number buttons, the data dial, or the [OCTAVE] button itself to set the desired octave. The octave range is from -2 (down two octaves) to +2 (up two octaves). The normal octave value for the selected voice can be recalled instantly by pressing both the [+] and [-] buttons at the same time.

DSP Depth

The PSR-1700 and PSR-2700 features a built-in digital signal processor (DSP) that can be used to apply a range of reverb and delay effects to the voices. The **[DSP TYPE]** button in the OVERALL CONTROL section (page 22) determines the type of effect to be applied, while the VOICE section **[DSP DEPTH]** button lets you individually set the amount of effect applied to each orchestration part.

1 Select the Part You Want to Edit

Use the ORCHESTRATION **[EDIT]** button to select the part you want to edit.

2 Press the [DSP DEPTH] Button



Press the VOICE control section **[DSP DEPTH]** button. The current DSP depth value of the selected part will appear on the LCD display panel.

PSR-1700

DSP Depth=06

PSR-2700

08:Showtune 001:GrandPno
AccOff DSP Depth=06

3 Set the DSP Depth



Use the **[+]** and **[-]** buttons, the number buttons, the data dial, or the **[DSP DEPTH]** button itself to set the desired DSP depth. The depth range is from **00** (OFF: no effect, direct sound only) to **15** (maximum effect).

The default DSP depth value (06) can be recalled instantly by pressing both the **[+]** and **[-]** buttons at the same time.

Pan

The PSR-1700 and PSR-2700 delivers true stereo sound, and you can use this parameter to individually set the stereo (pan) position of each orchestration part to create a broad stereo image of your sound.

1 Select the Part You Want to Edit

Use the ORCHESTRATION **[EDIT]** button to select the part you want to edit.

2 Press the [PAN] Button



Press the VOICE control section **[PAN]** button. The current pan value of the selected part will appear on the LCD display panel.

PSR-1700

PanPot= 0:Center

PSR-2700

08:Showtune 001:GrandPno
AccOff PanPot= 0:Center

3 Set the Pan Position



Use the **[+]** and **[-]** buttons, the number buttons, the data dial, or the **[PAN]** button itself to set the desired pan value. The pan range is from **-7** (full left) to **+7** (full right). A setting of “0” places the sound of the selected part in the center of the stereo sound field. Other settings produce in-between positions. “-4”, for example, would place the sound between center and full left.

The center pan position (0) can be recalled instantly by pressing both the **[+]** and **[-]** buttons at the same time.



- The new pan value will apply from the next note played — i.e. you can't pan the sound of a note while it is playing.

Selecting & Playing the Voices

■ Auto Harmony

Auto Harmony is used with the Auto Accompaniment feature (see page 24). It automatically adds appropriate harmony notes to a single-note melody line you play on the keyboard. You can choose from 10 different types of harmony that can be assigned to the right-hand orchestration parts.



• The Auto Harmony feature cannot be used when Auto Accompaniment fingering mode 5 “Full” is selected (page 28).

1 Turn Auto Harmony ON

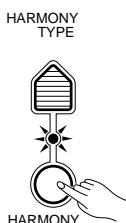

Press the [HARMONY] button so that its indicator lights. This turns Auto Harmony ON.



• The HARMONY can't be engaged when Keyboard Percussion is ON.

2 Press the [HARMONY TYPE] Button



Press the VOICE control section [HARMONY TYPE] button. The number of the currently selected harmony type will appear on the LCD display panel.

PSR-1700

Harm.=01:Duet

PSR-2700

08: Showtune 001: GrandPho
AccOff Harm.=01:Duet

3 Select a Harmony Type



Use the [+] and [-] buttons, the number buttons, the data dial, or the [HARMONY TYPE] button itself to select the desired effect.

The Harmony Types

01: Duet	This harmony type produces a duophonic melody with the second voice below the melody line. If you turn both the R1 and R2 voices on (DUAL mode) the notes you play on the keyboard will be played by the R1 voice, and the harmony notes by the R2 voice. You can individually set the R1 and R2 voices and voice parameters as required.	06: 4-way close 1	Three harmony notes are generated to produce a four-note chord. If both the R1 and R2 voices are turned on (dual mode), the 1st (melody) and 3rd notes are assigned to R1 while the 2nd and 4th are assigned to R2.
02: 1 + 5	A parallel voice is produced a fifth above the melody voice. As in the Duet type, the R1 and R2 voices can be set individually in the dual mode.	07: 4-way close 2	Similar to the preceding type, but depending on the chords played this type will sometimes produce a more colorful sound. The note assignment in the dual mode is also different: 1st and 2nd notes to R1, 3rd and 4th notes to R2.
03: Country	Similar to Duet, but the second voice is above the melody line. The R1 and R2 voices can be set individually in the dual mode.	08: 4-way open	Four-note chords with open voice (large intervals between the notes). The result is a very “open” sound. Since the harmony notes can be as much as two octaves below the melody, avoid playing in the lower registers. With certain voices you might find that changing the octave (see “Octave” on page 14) results in better sound. In the dual mode the top (melody) note is assigned to R1 and all three harmony notes are assigned to R2.
04: Trio	This harmony type generates two voices in addition to the melody voice. Both of the harmony voices are assigned to R2 in the dual mode.	09: Octave	One note is added an octave below the melody. In the dual mode the melody is assigned to R1 and the lower note to R2.
05: Block	Three or four notes are added to the melody to produce four or five-note chords. In the dual mode the highest and lowest voices (always one octave apart) are assigned to R1, and the inner two or three notes are assigned to R2.	10: Strum	The notes and assignments are the same as in the Block type, but the notes are arpeggiated.

4 Turn Auto Harmony ON or OFF as Required

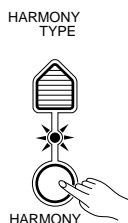

Use the [**HARMONY**] button to turn Auto Harmony ON or OFF. Auto Harmony is ON when the [**HARMONY**] button indicator is lit.



- Only a single note can be played at a time on the keyboard (or the right-hand section of the keyboard) when the Auto Harmony feature is used.
- If you play more than one note at the same time while Auto Harmony is ON, only the highest note will sound.
- Auto Harmony will only function when the Auto Accompaniment function is being used (page 24).

Effects

The PSR-1700 and PSR-2700 have a range of 12 delay-based effects — in addition to the DSP effects (pages 15 and 22) — that can be selected and applied to the right-hand orchestration parts (the left-hand orchestration parts are not affected).

1 Turn the Effect ON

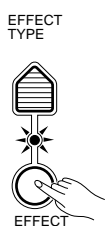

Press the [**EFFECT**] button so that its indicator lights. This turns ON the effect.



- The **EFFECT** can't be engaged when Keyboard Percussion is ON.

2 Press the [EFFECT TYPE] Button



Press the VOICE control section [**EFFECT TYPE**] button. The number of the currently selected effect will appear on the LCD display panel.

PSR-1700

Eff.=04:Echo4

PSR-2700

08:Showtune 001:GrandPro
AccOff Eff.=04:Echo4

3 Select an Effect



Use the [+], [-], the number buttons, the data dial, or the [**EFFECT TYPE**] button itself to select the desired effect.

The Effects

01	Echo 1		05	Tremolo 1		09	Trill 1	
02	Echo 2		06	Tremolo 2		10	Trill 2	
03	Echo 3		07	Tremolo 3		11	Trill 3	
04	Echo 4		08	Tremolo 4		12	Trill 4	

4 Turn the Effect ON or OFF as Required

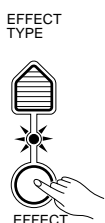

Use the [**EFFECT**] button to turn the effect ON or OFF. The selected effect is ON when the [**EFFECT**] button indicator is lit.



- You can change the effect type whether the effect is ON or OFF.

Selecting & Playing the Voices

Keyboard Percussion

The PSR-1700 and PSR-2700 have 8 different drum and percussion “kits” that can be played on the keyboard when the Keyboard Percussion function is turned ON. The types of drum and percussion instruments played by the various keys when Keyboard Percussion function is selected are marked by symbols above the keys.

1 Turn Keyboard Percussion ON

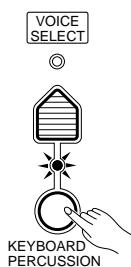

Press the [**KEYBOARD PERCUSSION**] button so that its indicator lights to turn Keyboard Percussion ON. The percussion kit number will appear on the LCD display panel.

PSR-1700

VCE=1:STANDARD

PSR-2700

08: Showtune 1:STANDARD
AccOff VCE=1:STANDARD

2 Select a Percussion Kit



Use the [+] and [-] buttons, the number buttons, the data dial, or the [**VOICE SELECT**] button to select the desired percussion kit (1 through 8). See page 338 for a complete list of the percussion kit instruments.

The Percussion Kits

1	Standard	5	Analog
2	Room	6	Jazz
3	Rock	7	Brush
4	Electronic	8	Classic



NOTES

- The *HARMONY*, *EFFECT*, and *TRANSDPOSE* functions (pages 16, 17, and 21) do not affect the percussion sounds. The *HARMONY* and *EFFECT* functions will be canceled when Keyboard Percussion is turned ON.
- The *ORCHESTRATION [EDIT]* button does not function when Keyboard Percussion is turned ON.

Pitch Bend

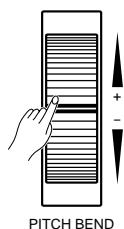

The **PITCH BEND** wheel to the left of the keyboard allows the pitch of notes played on the keyboard to be bent up or down — roll the wheel away from you to bend up, and toward you to bend down (this situation can be reversed, as described below). When the **PITCH BEND** wheel is moved almost all the way in either direction, the current pitch bend range value will appear on the LCD display panel (see below).

● Setting the Pitch Bend Range

The maximum amount of pitch bend produced by the **PITCH BEND** wheel can be set anywhere from ± 1 semitone to ± 12 semitones (i.e. plus or minus one octave).

1 Call the Pitch Bend Range Parameter



To set the pitch bend range, roll the **PITCH BEND** wheel all the way in either direction so that the current range value appears on the LCD display panel.

PSR-1700

P.B.Range=±02

PSR-2700

08: Showtune 001: GrandPno
AccOff P.B.Range=±02

2 Set the Pitch Bend Range



While holding the **PITCH BEND** wheel at its maximum position, use the [+] and [-] buttons, the number buttons, or the data dial to select the desired pitch bend range. Use the [+/-] button to enter negative values. The pitch bend range value is displayed in semitones (-12 through 12). If a minus setting is selected pitch bend wheel operation is reversed — i.e. roll the wheel away from you to lower pitch. The default pitch bend range (02) can be instantly recalled by pressing [+] and [-] buttons simultaneously.

3 Release the PITCH BEND Wheel

Release the **PITCH BEND** wheel when you've set the required pitch bend range.

Modulation

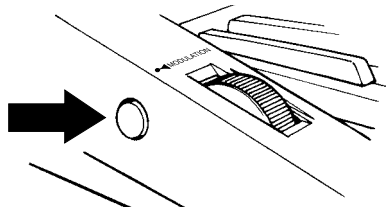

The **MODULATION** button on the side panel of the instrument, next to the **PITCH BEND** wheel, can be used to apply pitch modulation (vibrato) to most voices. The modulation speed is preset for each voice, but the depth can be set as required.

1 Call the Modulation Depth Parameter

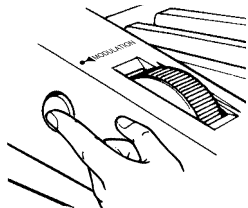

To set the modulation depth, press and hold the **MODULATION** button so that the current depth value appears on the LCD display panel.

PSR-1700

Mod.Depth=2

PSR-2700

08: Showtune 001: GrandPno
AccOff Mod.Depth=2

2 Set the Modulation Depth



While holding the **MODULATION** button, use the [+] and [-] buttons, the number buttons, or the data dial to select the desired modulation depth. The available modulation depth range is from 1 (minimum depth) to 3 (maximum depth).

3 Release the MODULATION Button

Release the **MODULATION** button when you've set the required modulation depth.



• The same modulation depth setting may produce slightly different effects with different voices.

Overall Control

The OVERALL CONTROL section includes a range of parameters that, as their title suggests, apply to the overall sound of the PSR-1700 and PSR-2700.

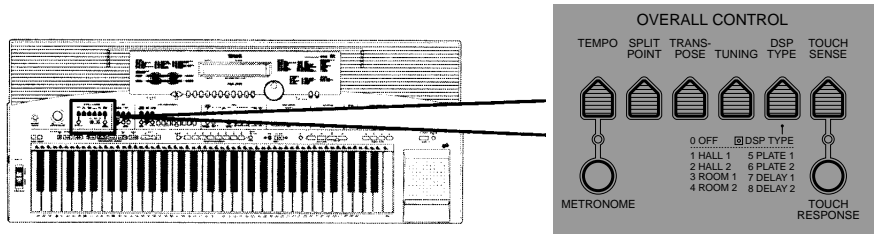

Split Point Change

This function lets you set the split point (the key that separates the left-hand and right-hand orchestration parts) to any key on the keyboard.

1 Turn Auto Accompaniment OFF



To set the split point for the left- and right-hand orchestration parts, make sure that the [AUTO ACCOMP] indicator is off before proceeding.



- The PSR-1700/PSR-2700 actually memorizes two separate split points: one for the left- and right-hand orchestration parts, and one for Auto Accompaniment mode. See page 25 for details on setting the Auto Accompaniment split point.

2 Press the [SPLIT POINT] Button



Press the OVERALL CONTROL section [SPLIT POINT] button. The key number of the current split point will appear on the LCD display panel.

PSR-1700
SplitPt=061:C#3

PSR-2700
08:Showtune 001:GrandPho
AccOff SplitPt=061:C#3



- The key numbers for each note are listed above the keyboard. The C3 (middle C) key number, for example, is 60.

3 Set the Split Point

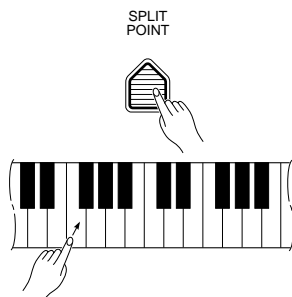

The easiest way to set the split point is to press the key you want to set as the split point while holding the [SPLIT POINT] button. The number of the selected key will appear on the LCD display panel.

PSR-1700
SplitPt=065:F3

PSR-2700
08:Showtune 001:GrandPho
AccOff SplitPt=065:F3

As with all other parameters, you can also use the [+] and [-] buttons, the number buttons, or the data dial to select the desired split point. The default split point (69) can be recalled instantly by pressing both the [+] and [-] buttons at the same time.



- The split-point key becomes the lowest key in the right-hand section of the keyboard.

Transpose

The [TRANPOSE] button makes it possible to shift the pitch of the PSR-1700/PSR-2700 up or down in semitone intervals up to a maximum of 12 semitones (one octave). Transposing the pitch of the keyboard makes it easier to play in difficult key signatures, and you can easily match the pitch of the keyboard to the range of a singer or other instrumentalist.

1 Press the [TRANPOSE] Button



Press the OVERALL CONTROL section [TRANPOSE] button. The current transpose value will appear on the LCD display panel.

PSR-1700

Transpose= 00

PSR-2700

08: Showtune 001: GrandPno
AccOff Transpose= 00

2 Set the Desired Degree of Transposition



Use the [+] and [-] buttons, the number buttons, the data dial, or the [TRANPOSE] button itself to set the desired degree of transposition. Use the [+/-] button to enter negative values.

The transposition range is from **-12** to **+12**, with **-12** corresponding to downward transposition by 12 semitones (one octave), and **+12** corresponding to upward transposition by 12 semitones. **00** is the “normal” keyboard pitch value. The normal transpose value (00) can be recalled instantly by pressing both the [+] and [-] buttons at the same time.



- The new transpose value will apply from the next note played — i.e. you can't transpose the sound of a note while it is playing.

Tuning

The [TUNING] button makes it possible to tune the pitch of the PSR-1700/PSR-2700 to match other instruments. Tuning can be accomplished over a ± 50 -cent range (that's 100 cents total, or one semitone) in 33 steps.

1 Press the [TUNING] Button



Press the OVERALL CONTROL section [TUNING] button. The current tuning value will appear on the LCD display panel.

PSR-1700

Tune= 00:440.0Hz

PSR-2700

08: Showtune 001: GrandPno
AccOff Tune= 00:440.0Hz

2 Set the Tuning



Use the [+] and [-] buttons, the number buttons, the data dial, or the [TUNING] button itself to set the desired tuning value.

The tuning range is from **-16** (-50 cents) to **+16** (+50 cents). “00” (± 0 cents) is the “normal” tuning value. The normal tuning value (00) can be recalled instantly by pressing both the [+] and [-] buttons at the same time.



- The tuning setting is retained in memory even when the power switch is turned off, as long as the backup batteries are installed or the AC plug is connected.

Overall Control

DSP Type

The **[DSP TYPE]** button selects one of eight digital effects that you can use for extra depth and expressive power. This button determines the type of effect to be used, while the **[DSP DEPTH]** button in the VOICE section allow the depth of the effect to be individually set for each orchestration part.

1 Press the **[DSP TYPE]** Button

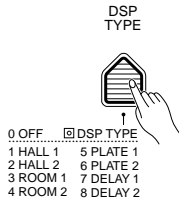

Press the OVERALL CONTROL section **[DSP TYPE]** button. The number of the current DSP type will appear on the LCD display panel.

PSR-1700

DspType=1:Hall1

PSR-2700

00:Showtune 001:GrandPro
AccOff DspType=1:Hall1

2 Select a DSP Type



Use the **[+]** and **[-]** buttons, the number buttons, the data dial, or the **[DSP TYPE]** button itself to select the desired DSP type (0 for OFF, or 1 ... 8 as listed below). The default DSP type (1) can be recalled instantly by pressing both the **[+]** and **[-]** buttons at the same time.

The DSP Types

1	Hall 1	For a spacious reverb sound use one of the Hall settings. These effects simulate the natural reverberation of a concert hall. Hall 2 has a longer reverb time and therefore simulates a larger hall than Hall 1.
2	Hall 2	
3	Room 1	These settings add relatively short reverb effects to the sound that are similar to the type of acoustic reverberation you might hear in different rooms.
4	Room 2	
5	Plate 1	These are simulations of the large plate reverb devices traditionally used in professional recording studios.
6	Plate 2	
7	Delay 1	Delay 1 produces a distinct series of delay repeats, while Delay 2 produces a smoother multiple-delay sound.
8	Delay 2	

NOTES

- DSP effects may sound different with different voices.
- The DSP Type setting is retained in memory even when the power switch is turned off, as long as the backup batteries are installed or the AC plug is connected.

■ Touch Sensitivity

This function varies the touch sensitivity of the keyboard. Use this capability to adjust the keyboard touch sensitivity for the best results with your own particular playing style.

1 Press the [TOUCH SENSE] Button



Press the OVERALL CONTROL section [TOUCH SENSE] button. The current sensitivity setting will appear on the LCD display panel.

PSR-1700

Touch=4:Mid-High

PSR-2700

@8:Showtune @01:GrandPno
AccOff Touch=4:Mid-High

2 Turn Touch Sensitivity ON

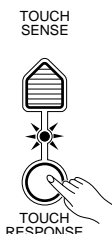

Press the [TOUCH RESPONSE] button so that its indicator lights. This turns touch sensitivity ON.

3 Set the Sensitivity



Use the [+] and [-] buttons, the number buttons, the data dial, or the [TOUCH SENSE] button itself to set the desired sensitivity value (1 ... 5).

A setting of “1” produces the least touch sensitivity, and therefore the smallest dynamic range. A setting of “5” produces the greatest sensitivity and broadest dynamic range. The default touch sensitivity value (4) can be recalled instantly by pressing both the [+] and [-] buttons at the same time.

4 Turn Touch Sensitivity ON or OFF as Required

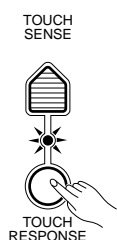

Use the [TOUCH RESPONSE] button to turn touch sensitivity ON or OFF as required. When OFF (i.e. when the indicator is off) the same volume is produced no matter how hard you play on the keyboard. Touch sensitivity can be turned OFF to produce a more realistic effect with voices that normally do not have touch response: e.g. organ and harpsichord.

Auto Accompaniment

The PSR-1700 and PSR-2700 have 100 accompaniment styles that can be used to provide fully-orchestrated Auto Accompaniment. When the Auto Accompaniment function is turned ON, the PSR-1700 and PSR-2700 create fully-orchestrated rhythm, bass, and chord accompaniment based on chords you play with the left hand in the Auto Accompaniment section of the keyboard (i.e. all keys to the left of the Auto Accompaniment split point). The right-hand section of the keyboard is available for normal playing.

The default Auto Accompaniment split point is the G2 (55) key. The Auto Accompaniment section of the keyboard consists of all keys to its left. The Auto Accompaniment split point can be set to any other key as described in "Setting the Auto Accompaniment Split Point" on page 25.

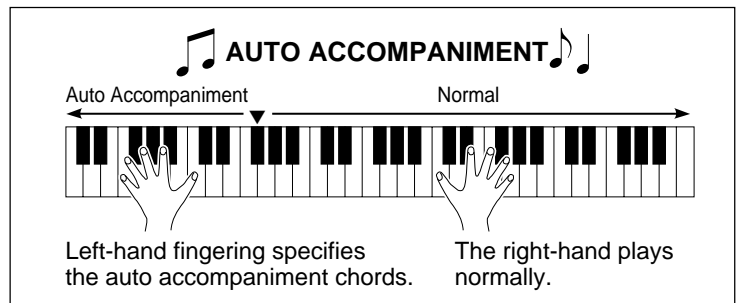

NOTES

• The PSR-1700/PSR-2700 also has a special "Full" Auto Accompaniment fingering mode in which chords played anywhere on the keyboard determine the Auto Accompaniment chords. See page 28 for details.

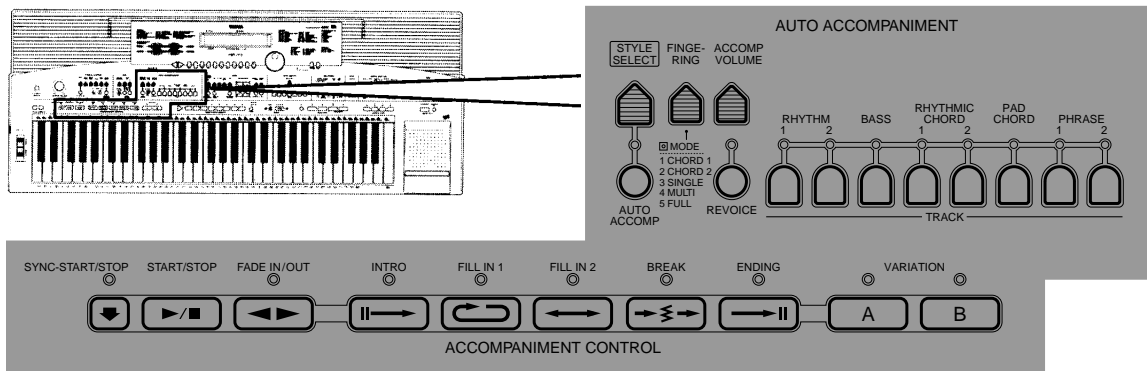

Selecting a Style

Any of the 100 accompaniment styles can be selected via the normal editing procedure. This can be done either before or during accompaniment playback. See page 78 for descriptions of all 100 styles.

NOTES

• Eight additional styles are provided on floppy disk. These can be loaded, one at a time, into the PortaTone's "Custom Style" memory location — style number "00" — and used in the same way as the 100 preset styles. See page 60 for instructions on loading styles from disk.

1 Press the [STYLE SELECT] Button



When you press the [STYLE SELECT] button the currently selected style number and name will appear on the LCD display panel.

PSR-1700

Styl=08: Showtune

PSR-2700

08: Showtune 001: GrandPno
AccOff Styl=08: Showtune

2 Select a Style Number



Use the [+] and [-] buttons, the number buttons, the data dial, or the [STYLE SELECT] button itself to select the required style number (see page 9 for editing procedure details).

■ Setting the Auto Accompaniment Split Point

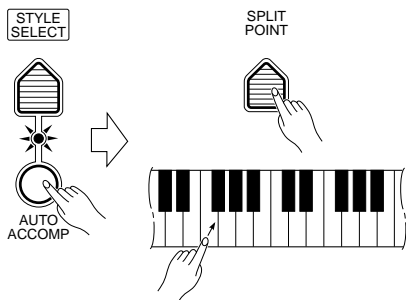

To set the Auto Accompaniment split point, first turn Auto Accompaniment ON — press the [AUTO ACCOMP] button so that its indicator lights — then proceed with steps 2 and 3 as described in “Split Point Change” on page 20. The default Auto Accompaniment split point (55) can be instantly recalled by pressing both the [+] and [-] buttons at the same time.

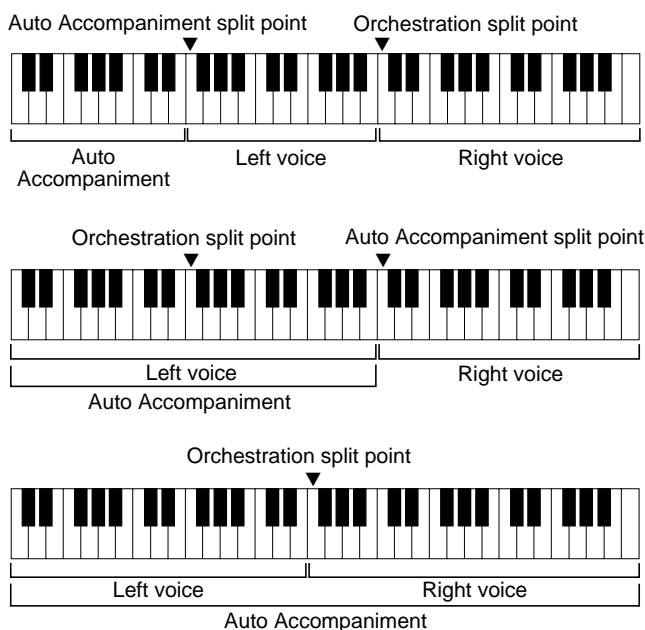

NOTES

- If the Auto Accompaniment split point is set at a lower key than the orchestration split point, the L1 and/or L2 voice will sound between the Auto Accompaniment and orchestration split points.
- If the Auto Accompaniment split point is set at a higher key than the orchestration split point, the L1 and/or L2 voice will sound throughout the entire Auto Accompaniment section.
- If the Auto Accompaniment “Full” fingering mode is selected, the L1 and/or L2 voice will sound to the left of the orchestration split point while the R1 and/or R2 voice will sound to the right of the orchestration split point.

■ Auto Accompaniment Fingering

The PSR-1700 and PSR-2700 have 5 Auto Accompaniment fingering modes, selected via the [FINGERING] button.

1 Press the [FINGERING] Button



When you press the [FINGERING] button the currently selected Auto Accompaniment fingering number and type name will appear on the LCD display panel.

PSR-1700

Fing9rn9=1:Chord1

PSR-2700

08:Showtune 001:GrandPno
C Fing9rn9=1:Chord1

2 Select a Fingering Mode



Use the [+] and [-] buttons, the number buttons, the data dial, or the [FINGERING] button itself to select the required fingering mode (see page 9 for editing procedure details).

Auto Accompaniment

● Mode 1: Chord 1

PSR-1700

Fingrn9=1:Chord1

PSR-2700

008:Showtune 001:GrandPho
C Fingrn9=1:Chord1

The Chord 1 mode is ideal if you already know how to play chords on a keyboard, since it allows you to supply your own chords for the Auto Accompaniment feature.

The PSR-1700/PSR-2700 will accept the following chord types:

Example for “C” chords

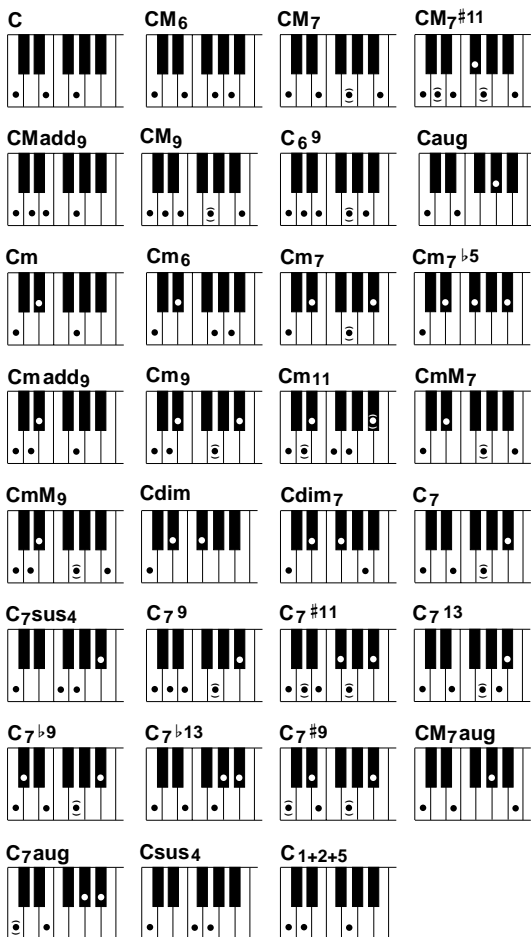

Major [M]	1 - 3 - 5
Major sixth [M6]	1 - 3 - 5 - 6
Major seventh [M7]	1 - 3 - (5) - 7
Major seventh sharp eleventh [M7#11]	..	1 - (2) - 3 - #4 - (5) - 7
Major add ninth [Madd9]	1 - 2 - 3 - 5
Major ninth [M9]	1 - 2 - 3 - (5) - 7
Major sixth add ninth [6 9]	1 - 2 - 3 - (5) - 6
Augmented [aug]	1 - 3 - #5
Minor [m]	1 - b3 - 5
Minor sixth [m6]	1 - b3 - 5 - 6
Minor seventh [m7]	1 - b3 - (5) - b7
Minor seventh flatted fifth [m7b5]	1 - b3 - b5 - b7
Minor add ninth [madd9]	1 - 2 - b3 - 5
Minor ninth [m9]	1 - 2 - b3 - (5) - b7
Minor eleventh [m11]	1 - (2) - b3 - 4 - 5 - (b7)
Minor major seventh [mM7]	1 - b3 - (5) - 7
Minor major ninth [mM9]	1 - 2 - b3 - (5) - 7
Diminished [dim]	1 - b3 - b5
Diminished seventh [dim7]	1 - b3 - b5 - 6
Seventh [7]	1 - 3 - (5) - b7
Seventh suspended fourth [7sus4]	1 - 4 - 5 - b7
Seventh ninth [7 9]	1 - 2 - 3 - (5) - b7
Seventh sharp eleventh [7#11]	1 - (2) - 3 - #4 - (5) - b7
Seventh thirteenth [7 13]	1 - 3 - (5) - 6 - b7 or 2 - 3 - 5 - 6 - b7
Seventh flatted ninth [7b9]	1 - b2 - 3 - (5) - b7
Seventh flatted thirteenth [7b13]	1 - 3 - 5 - b6 - b7
Seventh sharp ninth [7#9]	(1) - #2 - 3 - (5) - b7
Major seventh augmented [M7aug]	1 - 3 - #5 - 7
Seventh augmented [7aug]	(1) - 3 - #5 - b7
Suspended fourth [sus4]	1 - 4 - 5
One plus two plus five [1+2+5]	1 - 2 - 5

NOTES

- Notes in parentheses can be omitted.
- A perfect fifth (1+5) produces accompaniment based only on the root and fifth which can be used with many major and minor chords.
- An octave (1+8) produces accompaniment based only on the root.
- If three adjacent keys are played simultaneously (white and black keys), chord accompaniment will be cancelled and only the rhythm accompaniment will sound. (Chord 1/Chord 2 mode)
- The chord fingerings listed are all in “root position”, but other inversions can be used — with the following exceptions:
 - * M6 chords are only recognized in root position. All other inversions are interpreted as m7.

- * 6 9 chords are only recognized in root position. All other inversions are interpreted as m11.
- * m6 chords are only recognized in root position. All other inversions are interpreted as m7b5.
- * 1+2+5 chords are only recognized in root position. All other inversions are interpreted as sus4.
- * With aug and dim7 chords the lowest note played is assumed to be the root.
- * With 7#11 chords the lowest note played is assumed to be the root or b7.

● Mode 2: Chord 2

PSR-1700

Fingrng=2:Chord2

PSR-2700

@8:Showtune @01:GrandPno
C Fingrng=2:Chord2

This is essentially the same as the Chord 1 mode, above, except that the lowest note played in the Auto Accompaniment section of the keyboard will be played by the bass part rather than the chord root.



● Mode 3: Single

PSR-1700

Fingrng=3:Single

PSR-2700

@8:Showtune @01:GrandPno
C Fingrng=3:Single

SINGLE mode fingering makes it simple to produce beautifully orchestrated accompaniment using major, seventh, minor and minor-seventh chords by pressing a minimum number of keys in the Auto Accompaniment section of the keyboard. The accompaniment produced is perfectly matched to the currently selected accompaniment style.

Major Chords:

If you press a “C” key in the left-hand section of the keyboard, for example, a C-major accompaniment will be played. Press another key in the left-hand section of the keyboard to select a new chord. The key you press will always determine the “root” of the chord played (i.e. “C” for a C chord).

Minor Chords:

Simultaneously press the root key and a black key to its left.

Seventh Chords:

Simultaneously press the root key and a white key to its left.

Minor-seventh Chords:

Simultaneously press the root key and both a white and black key to its left.

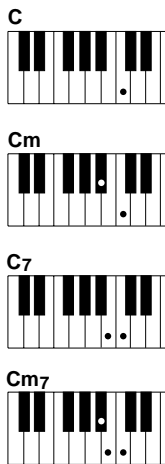

- The Auto Accompaniment will continue playing even if you lift your fingers from the Auto Accompaniment keys. You only need to press the Auto Accompaniment keys when changing chords.

● Mode 4: Multi

PSR-1700

Fingrng=4:Multi

PSR-2700

@8:Showtune @01:GrandPno
C Fingrng=4:Multi

This is a combination of the Single and Chord 1 modes. In this mode the PSR-1700/PSR-2700 automatically discriminates between Single and Chord 1 mode fingerings and generates the appropriate accompaniment.



- If more than two keys are played and all but the highest key are black keys, and the chord is not recognized by the Chord 1 mode, the highest note will be interpreted as the root of a minor (m) chord.
- If more than three keys are played and, excluding the highest key, are a mixture of black and white keys, and the chord is not recognized by the Chord 1 mode, the highest note will be interpreted as the root of a minor-seventh (m7) chord.
- If more than two keys are played and all but the highest key are white keys, and the chord is not recognized by the Chord 1 mode, the highest note will be interpreted as the root of a seventh (7) chord.

Auto Accompaniment

● Mode 5: Full

PSR-1700

Fingrn9=5:Full

PSR-2700

08:Showtune 001:GrandPno
C Fingrn9=5:Full

In this mode chords played anywhere on the keyboard are detected and used for Auto Accompaniment. Otherwise the keyboard functions normally, and the entire range is available for playing. Chord recognition is the same as in the Chord 1 mode. Please note that in this mode all notes you play on the keyboard at any one time will be interpreted as the Auto Accompaniment chord.



- A single note played more than one octave below the lowest note in a chord will be interpreted as a bass note, and notes played more than an 11th above the lowest chord note will be interpreted as melody.

Playing Chords When the Accompaniment is Stopped

Chords played in the Auto Accompaniment section of the keyboard are also detected and played by the PSR-1700/PSR-2700 Auto Accompaniment system when the accompaniment is stopped (except in the Full fingering mode). In this case the bass note and chord voices are selected automatically.

■ Tempo Control

The [TEMPO] button can be used to control the tempo of AUTO ACCOMPANIMENT, SONG MEMORY and MULTI PAD playback (see pages 43 and 46).

1 Press the [TEMPO] Button

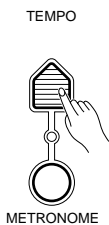

Press the OVERALL CONTROL section [TEMPO] button. The current tempo (quarter-note beats per minute) will appear on the LCD display panel.

PSR-1700

Tempo ♩=128

PSR-2700

08:Showtune 001:GrandPno
C Tempo ♩=128

2 Set the Tempo



Use the [+] and [-] buttons, the number buttons, the data dial, or the [TEMPO] button itself to set the desired tempo.

Each accompaniment style has a different “default” tempo which is automatically set whenever a new style is selected (but not when a new style is selected while the accompaniment is playing). The default tempo for the currently selected accompaniment style can be recalled instantly by pressing both the [+] and [-] buttons at the same time.

● The [METRONOME] Button

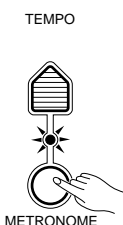

The PSR-1700 and PSR-2700 include a metronome function that you'll use primarily with the recording functions described on page 39. If you press the [METRONOME] button so that its indicator lights when using Auto Accompaniment, the metronome will sound at the currently set tempo when the synchro-start mode is engaged, and while the accompaniment is playing.

■ Accompaniment Control

The PSR-1700 and PSR-2700 provide a range of accompaniment “sections” — introduction, fill-ins, break, variations on the main pattern, ending — that you can select to control the “flow” of the accompaniment to achieve the desired musical results. Accompaniment start/stop and sections are controlled by the ACCOMPANIMENT CONTROL buttons.

● Straight Start



The [START/STOP] button starts the selected accompaniment style immediately.

Press the [AUTO ACCOMP] button so that its indicator lights before starting the accompaniment. The accompaniment will start with the rhythm sound only when the [START/STOP] button is pressed, then the bass and chord parts will begin playing as soon as the first note or chord is played on the Auto Accompaniment section of the keyboard.



- A different accompaniment style can be selected at any time while the accompaniment is playing. The style number and name on the LCD display panel will change as soon as the selection is made, but the new style will begin playback from the top of the next measure. The only exception is if you change styles while an intro is playing (see page 30), in which case the new style begins playing after the intro has finished. The tempo will not change when the new style begins playing.

4/4 time

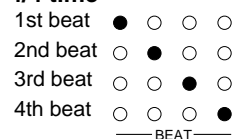

3/4 time



6/8 time

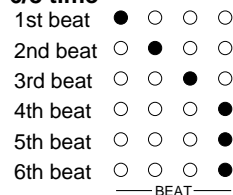

The Beat Indicator

The four BEAT indicator LEDs located above the AUTO ACCOMPANIMENT control section flash to indicate the tempo and beat as the accompaniment plays. The LEDs flash individually in sequence on each beat of the measure. In 4/4, 3/4, and 6/8 time, for example, the beat indicator LEDs will flash as shown to the left.



- Each accompaniment style has a preset “normal” tempo which is automatically selected whenever the style is selected while the accompaniment is stopped. The current tempo is maintained if you select a different style during accompaniment playback (except when the One Touch Setting function is used — page 36). You can change the tempo as required by using the TEMPO function described on page 28.

● Synchro Start

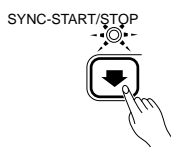

Press the [SYNC-START/STOP] button if you want the accompaniment to start when you play the first note or chord on the keyboard. In this case the accompaniment is started by playing in the left-hand section of the keyboard.



- If the AUTO ACCOMP mode is OFF, playing anywhere on the keyboard causes the rhythm-only accompaniment to start.

If you press the [SYNC-START/STOP] button, the BEAT indicator LEDs will flash at the current tempo. The synchro start mode can be disengaged by pressing the [SYNC-START/STOP] button again so that its indicator goes out.

Auto Accompaniment

● Starting the Accompaniment with an Introduction

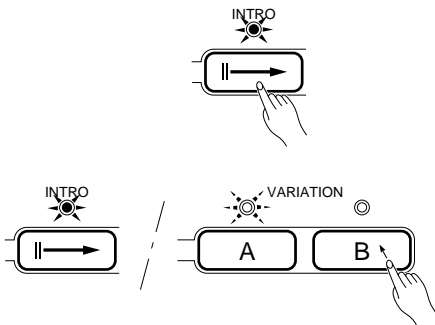

Any of the accompaniment styles can be started with an appropriate introduction by pressing the [INTRO] button and then the [START/STOP] button. If you press the [SYNC-START/STOP] button and then the [INTRO] button, the accompaniment will start from the introduction as soon as a chord is detected in the Auto Accompaniment section of the keyboard.

Once the [INTRO] button is pressed, the [INTRO] indicator will be lit continuously and the VARIATION [A] or [B] indicator will flash to indicate which section will play when the introduction has finished. You can change the “destination” section by pressing the VARIATION [A] or [B] button while its indicator is flashing. When the introduction ends, the [INTRO] indicator will go out and the [A] or [B] indicator will light continuously. The introductions for the VARIATION [A] and [B] sections are different. The A intro has no chord progression while the B intro has its own chord progression. The actual format of the intro, however, depends on the selected style. Although it is generally not advisable to change chords manually while the B intro is playing, the A intro has no progression of its own so you can play your own chords as required.



- It is possible to start the accompaniment from any section — even the ending — by pressing the corresponding button prior to pressing the [START/STOP] button. The destination MAIN [A] or [B] section can be selected as described above.
- The [INTRO] button can be used to select the introduction pattern even while the accompaniment is playing.

● The Main [A] and [B] Sections

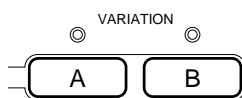

Each accompaniment style has two main sections — [A] and [B]. These are variations of the same musical style. If the VARIATION [A] or [B] button is pressed while the accompaniment is playing, the corresponding section will begin from the top of the next measure. You can also select [A] or [B] before starting the accompaniment.



- The Main [A] section is automatically selected whenever the power switch is turned on (the VARIATION [A] indicator will be lit).

● Adding Fill-ins & Breaks

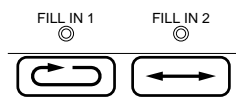

The PSR-1700 and PSR-2700 provide two types of fill-ins that can be used as musical transitions between sections of a song or simply to add variety where required. Press the [FILL IN 1] button at any time while the accompaniment is playing to add a one-measure fill-in and or return to the current MAIN section, or press the [FILL IN 2] button to add a one-measure fill-in and go to the other MAIN section. Although there are two FILL IN buttons there are actually four fill-ins per style: FILL IN 1 for the MAIN [A] section, FILL IN 1 for the MAIN [B] section, FILL IN 2 for the transition MAIN [A] to [B], and FILL IN 2 for the transition MAIN [B] to [A].

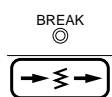

While the fill-ins are one measure long, the BREAK is two measures. The first measure is similar to a fill-in while the second measure is an actual rhythmic break — a thinner arrangement with drums and percussion predominating. Like the fill-ins, there are actually two BREAK patterns — one for the MAIN [A] section and one for the MAIN [B] section.

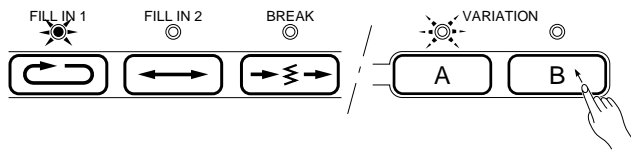

If the MAIN A section is playing, for example, the [A] indicator will flash while FILL IN 1 or the BREAK plays, and the [B] indicator will flash while FILL IN 2 plays. You can change the section that will begin playing after the selected fill-in or break by pressing the desired section button while the indicator is still flashing.

NOTES

- If you hold the [FILL IN 1], [FILL IN 2] or [BREAK] button, the fill-in or second measure of the break pattern will repeat until the button is released, then the MAIN A or B section will play from the beginning of the next measure.
- If the [FILL IN 1], [FILL IN 2] or [BREAK] button is pressed after the last beat of a measure, the fill-in or break will begin from the first beat of the next measure. If pressed at any other time the fill-in or break will begin immediately.
- It is also possible to start the accompaniment with a fill-in or break by pressing the desired fill-in or break button prior to pressing the [START/STOP] button. The destination MAIN [A] or [B] section can be selected in the normal way.

● **Stopping the Accompaniment**.....



An accompaniment in progress can be stopped immediately by pressing the [START/STOP] button or the [SYNC-START/STOP] button. In the latter case the synchro start mode will be engaged when the accompaniment stops. The accompaniment can also be stopped with an appropriate ending by pressing the [ENDING] button. The endings for the MAIN [A] and [B] sections are different. The A ending has no chord progression while the B ending has its own chord progression. The actual format of the ending, however, depends on the selected style.

NOTES

- The ending will begin from the first beat of the next measure.
- If the [FILL IN 1], [FILL IN 2], or [BREAK] button is pressed while the ending pattern is playing, a fill-in or break will be played, followed by a return to the MAIN A or B pattern.

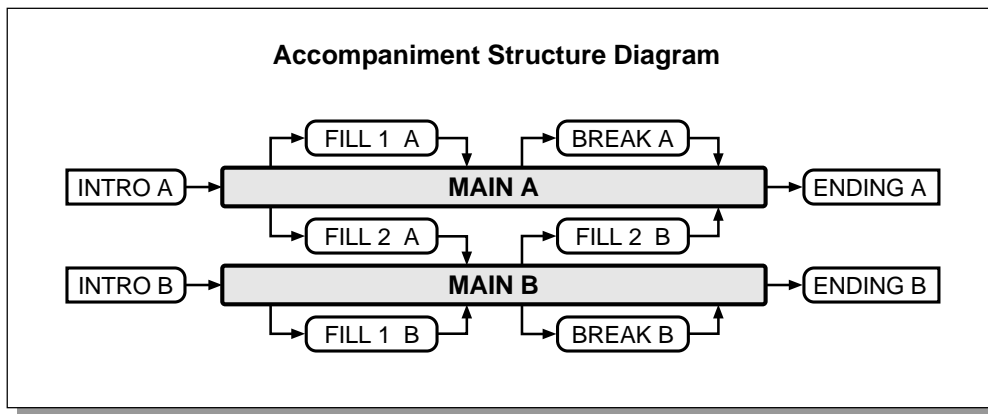

Auto Accompaniment

● Fade In & Fade Out

The [FADE IN/OUT] button can be used to produce smooth accompaniment and melody fade-ins or fade-outs.

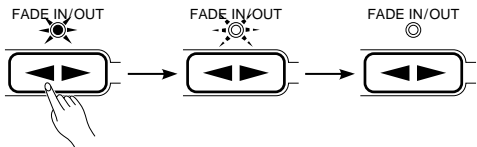

Start Playback with a Fade-in

You can start the accompaniment with a fade-in by pressing the [FADE-IN/OUT] button before starting playback. The [FADE-IN/OUT] button indicator will light continuously until the accompaniment is started. The fade-in will begin automatically as soon as the accompaniment is started. The [FADE-IN/OUT] button indicator will flash during the fade-in, and will go out when the fade-in is complete.

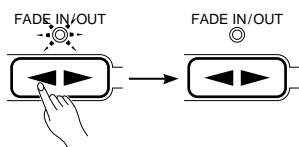

Fade-out to stop the accompaniment during Playback

Press the [FADE-IN/OUT] button during accompaniment playback to fade out the accompaniment and melody sound. The [FADE-IN/OUT] button indicator will flash during the fade-out, and will go out when the fade-out is complete.

■ Accompaniment Volume

While the VOICE control section [VOL] button can be used to set the volume levels of the orchestration parts, the [ACCOMP VOLUME] button can be used to adjust the volume of the selected accompaniment in relation to the voices.

1 Press the [ACCOMP VOLUME] Button



Press the AUTO ACCOMPANIMENT control section [ACCOMP VOLUME] button. The current accompaniment volume value will appear on the LCD display panel.

PSR-1700

Accomp. Volume=21

PSR-2700

08: Showtune 001: GrandPho
C Accomp. Volume=21

2 Set the Volume



Use the [+] and [-] buttons, the number buttons, the data dial, or the [ACCOMP VOLUME] button itself to set the desired volume. The volume range is from 00 (no sound) to 24 (maximum volume). The default volume value (21) can be recalled instantly by pressing both the [+] and [-] buttons at the same time.

■ The Track Buttons

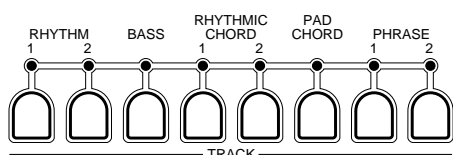

The Auto Accompaniment system includes eight TRACK buttons which allow you to control the accompaniment arrangement in real time. You can turn tracks on or off while playing for extra accompaniment variety.

The various tracks are turned on or off by pressing the corresponding TRACK button. When a part is turned off the corresponding indicator will go out. To silence the bass part, for example, press the TRACK [BASS] button so that its indicator goes out. Press the button again to turn that part back on.



- The indicators for all tracks that contain data in any section will light whenever an accompaniment style is selected. (Depending on the selected accompaniment style, some tracks may not contain any data.)

● What's In the Tracks

Here's how the tracks are normally used:

RHYTHM 1: This is the main rhythm track, and usually plays a drum kit.

RHYTHM 2: Additional rhythm. Turning the RHYTHM 2 track ON will usually increase the “energy” of the rhythm. In many styles this track plays percussion instruments such as congas, bongos, etc. This means you can turn off the RHYTHM 1 track and use only RHYTHM 2 for a “light” rhythm sound.

BASS: The BASS track always plays a bass line, but the voice will change to fit the selected style ... acoustic bass, synth bass, tuba, etc.

RHYTHMIC CHORD 1 & 2: Both these tracks provide the rhythmic chordal accompaniment required by each style. You'll find guitar, piano, and other chordal instruments here.

PAD CHORD: This track plays long chords where necessary, using sustained instruments such as strings, organ, choir.

PHRASE 1 & 2: This is where the musical embellishments reside. The PHRASE tracks are used for punchy brass stabs, arpeggiated chords, and other extras that make the accompaniment more interesting.

Try different combinations of tracks with each style. Some styles will sound best with the full arrangement (all tracks ON), while others might suit your needs better if a smaller arrangement is used. To “thin out” an arrangement, the PHRASE 1 and PHRASE 2 tracks are the first ones you'll want to turn OFF.

Another way to use the tracks is to gradually build up the arrangement during the course of a song. Start with a small arrangement — e.g. RHYTHM 1, BASS, and RHYTHMIC CHORD 1 — then add tracks one by one as you want to thicken the musical texture.

Some styles will actually sound quite different depending on the combination of tracks you choose. Try, for example, just RHYTHM 1, BASS, and PAD CHORD.

Auto Accompaniment

■ Re-voicing the Tracks

To make the TRACK buttons even more versatile, the PSR-1700 and PSR-2700 feature a REVOICE function that lets you individually change the voices and several related VOICE section parameters assigned to each track. The parameters that can be changed using the REVOICE function are as follows:

- Voice Number (Percussion Kit, Sampled Voice Number (PSR-2700))
- Volume
- Pan
- DSP Depth
- Octave

1 Select a Track to Re-voice

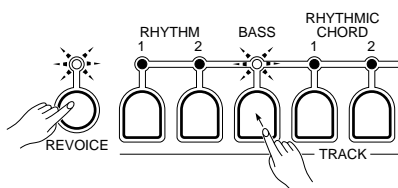

Press the TRACK button corresponding to the track you want to re-voice while holding the [REVOICE] button. Both the selected TRACK and [REVOICE] button indicators will flash. At the same time, the number of the voice currently assigned to the selected track will appear on the LCD display panel.

PSR-1700

UCE=034:FngBass

PSR-2700

08: Showtune 034: FngBass
C UCE=034:FngBass



- At this point you can play the selected track's voice on the keyboard.
- Keyboard percussion is automatically turned on if the RHYTHM 1 or 2 track is selected.

2 Make the Required Voice Settings

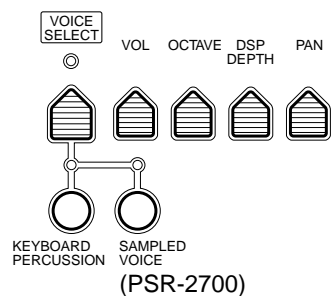

Use the [+] and [-] buttons, the number buttons, the data dial, or the [VOICE SELECT] button itself to select a new voice for the selected track. You can also use the [VOL], [OCTAVE], [DSP DEPTH], and [PAN] buttons to change the corresponding parameters for the selected voice.



- You can use the REVOICE function either while the accompaniment is playing or stopped.
- You cannot edit the orchestration parts while the REVOICE indicator is flashing.
- You can play the keyboard and hear the re-voiced voice except for octave changes.

3 Repeat For All Tracks To Be Re-voiced

Repeat steps 1 and 2 to re-voice all the tracks you want to change.

4 Confirm the Re-voiced Data

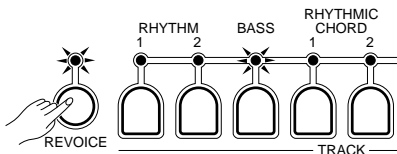

Press the [REVOICE] button when you've finished re-voicing the desired tracks to confirm the re-voiced data. The [REVOICE] button and selected track indicators will light.

5 Play the Re-voiced Accompaniment

Play and use the re-voiced accompaniment as required.

6 Turn REVOICE OFF to Restore the Original Voices

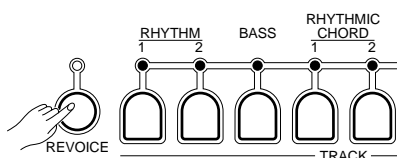

Press the [REVOICE] button so that its indicator goes out to disengage the REVOICE function when done. The re-voiced settings will be cancelled and the original voices for the selected accompaniment style will be restored.

NOTES

- **ALL REVOICE settings are reset to their default values if you changes styles while the REVOICE function is OFF. If you want to keep a re-voiced setup so that it can be easily recalled later, store it in the PSR-1700/PSR-2700 REGISTRATION MEMORY, described on page 37.**
- As long as you don't change styles while the REVOICE function is OFF, the re-voiced settings are maintained and can be recalled at any time simply by turning the REVOICE function ON.
- If you change styles while the REVOICE function is engaged, the re-voiced settings will be maintained.
- In some cases it may not be possible to re-voice a Custom Accompaniment during accompaniment playback. If this problem occurs, try re-voicing the style while the accompaniment is stopped.

One Touch Setting

Each accompaniment style has a suitable preset voice and other settings that can be instantly recalled by pressing the [ONE TOUCH SETTING] button in the VOICE control section. This makes it simple to recall the optimum settings for each style in one quick operation.

To use the One Touch Setting function: select a style, press the [ONE TOUCH SETTING] button so that its indicator lights, then play. As long as the [ONE TOUCH SETTING] indicator is lit the ideal voice and other settings (see list below) will be automatically recalled whenever you select a new style. The One Touch Settings can be turned off by pressing the [ONE TOUCH SETTING] button so that its indicator goes out.

If you don't want to use the One Touch Settings as they are, they can be edited and stored in a Registration Memory for easy recall at any time (see page 37 for details on the Registration memory).

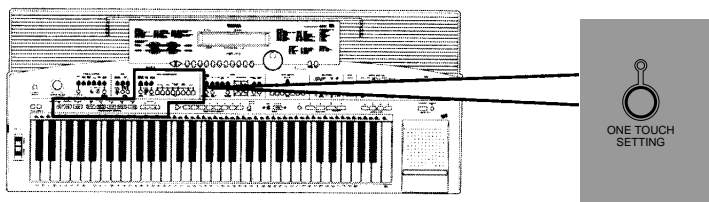

The One Touch Setting function recalls the following settings:



- The preset voice settings for the currently selected style — including orchestration, voice assignments, volume, octave, DSP depth, pan, harmony, and effect settings.
- ACCOMP VOLUME level (21).
- AUTO ACCOMP is turned ON.
- The default tempo for the currently selected style.
- The track ON/OFF status for the currently selected style.
- [REVOICE] is turned OFF.
- KEYBOARD PERCUSSION is turned OFF.
- Auto Accompaniment split point (55).
- Orchestration split point (69).

NOTES

- If you press [ONE TOUCH SETTING] while rhythm-only accompaniment is playing, AUTO ACCOMP will be turned ON.
- The synchro start mode will be engaged if the [ONE TOUCH SETTING] button is turned on while the accompaniment is stopped.
- The [ONE TOUCH SETTING] button cannot be turned on when style number "00" is selected.

Registration Memory

The REGISTRATION MEMORY can be used to store eight complete sets of VOICE and AUTO ACCOMPANIMENT settings that can be recalled anytime at the touch of a button.

The REGISTRATION MEMORY stores the following parameters:

VOICE

1. Voice numbers for all four orchestration parts.
2. Keyboard percussion ON/OFF & percussion kit number.
3. PSR-2700
Sampled voice ON/OFF (all four orchestration parts).
Sampled voice number in DIGITAL SAMPLING section.
Sampled voice volume in DIGITAL SAMPLING section.
Sampled voice DSP depth in DIGITAL SAMPLING section.
Sampled voice pan in DIGITAL SAMPLING section.
4. Volume (all four orchestration parts and percussion).
5. Pan (all four orchestration parts and percussion).

6. DSP Depth (all four orchestration parts and percussion).
7. Octave (all four orchestration parts and percussion).
8. Harmony ON/OFF & Harmony type.
9. Effect ON/OFF & Effect type.
10. Orchestration & Edit ON/OFF.
11. Split point.
12. Touch sense & Touch response.
13. Pitch bend range.
14. Modulation depth.
15. Local ON/OFF status (L & R)
16. MIDI OUT ON/OFF (L & R)
17. Pedal assign 1 & 2.

AUTO ACCOMPANIMENT

1. Style number.
2. Accompaniment volume.
3. Track button settings.
4. Tempo.
5. REVOICE ON/OFF and settings.
6. Split point.
7. Transpose.
8. Accomp. ON/OFF.
9. Fingering mode.

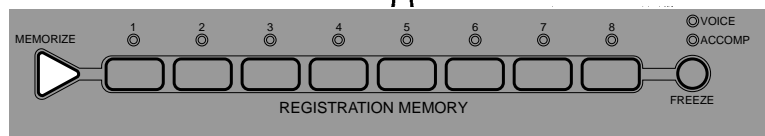
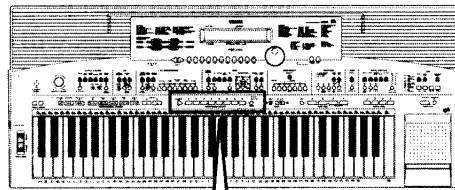

● Memorizing the Settings

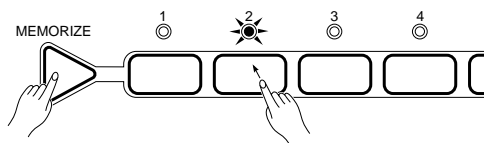

The panel settings listed above can be stored to any one of the eight REGISTRATION MEMORY buttons by pressing the button — [1] through [8] — while holding the [MEMORIZE] button. The indicator of the selected button will light continuously indicating that the data has been stored.

NOTES

- Please note that anytime you store to a REGISTRATION MEMORY button, all settings previously stored in that button will be erased and replaced by the new settings.
- The indicator of the selected REGISTRATION MEMORY will flash as soon as any change is made to the panel settings. In other words, if the REGISTRATION MEMORY indicator is flashing, the current panel settings are different from those stored in the memory.
- The Registration Memory data is retained in memory even when the power switch is turned off, as long as the backup batteries are installed or the AC plug is connected.

Registration Memory

● Recalling the Settings

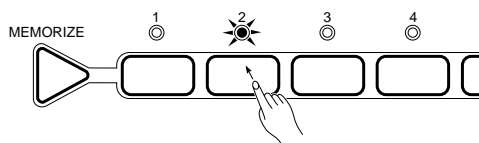

The settings stored to a REGISTRATION MEMORY button can be recalled at any time simply by pressing the appropriate button. The indicator of the selected button will light continuously when initially recalled, but will flash as soon as any change is made to the panel settings. A flashing REGISTRATION MEMORY indicator therefore indicates that the current panel settings do not correspond to those stored in the REGISTRATION MEMORY.



- REGISTRATION MEMORY number 1 is always initially selected when the power is turned on.

● The FREEZE Function

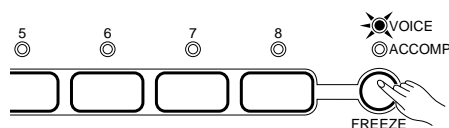

The [FREEZE] button can be used to “freeze” the VOICE or AUTO ACCOMPANIMENT settings so that they are not recalled when a REGISTRATION MEMORY button is pressed. If you press the [FREEZE] button so that only the VOICE indicator is lit, for example, then only the stored AUTO ACCOMPANIMENT settings will be recalled when a REGISTRATION MEMORY button is pressed.

To use the [FREEZE] button, simply press it as many times as necessary to cause the appropriate indicators to light. When an indicator is lit, then the corresponding group of settings is “frozen”.



- The FREEZE on/off status is retained in memory even when the power switch is turned off, as long as the backup batteries are installed or the AC plug is connected.

Record Functions

The PSR-1700/PSR-2700 RECORDING section controls three recording functions:

- **The SONG MEMORY:**

Record complete songs including an accompaniment track and up to six melody tracks. Songs can be saved to and loaded from floppy disk as required (page 56).

- **MULTI PADS:**

Record short chord, melody, or rhythm sequences that can be played back anytime by simply pressing a button. The MULTI PAD data can be saved to and loaded from floppy disk as required.

- **CUSTOM ACCOMPANIMENT:**

Create your own accompaniment style for use with the Auto Accompaniment feature. Custom accompaniments can be saved to and loaded from floppy disk as required.

Operation of all three functions is essentially the same, so once you're familiar with the basic procedure, recording songs, multi-pad phrases, or custom accompaniments should be easy. We'll start with the SONG MEMORY.



• *Turning the power OFF during recording or while the record-ready mode is engaged can result in a loss of recorded data.*

Song Memory

The SONG MEMORY allows you to record and play back complete songs including chord sequences created using the Auto Accompaniment feature and melody lines you play on the keyboard. The SONG MEMORY has one ACCOMP track and six MELODY tracks. You also have a choice of realtime and step recording modes: the realtime mode records what you play as you play it; the step mode lets you record one step at a time.

Only one song can be retained in the PSR-1700 or PSR-2700 memory at a time, but your songs can be saved to floppy disk — at most 99 songs per disk (the actual number depends on the volume of the song data) — and then reloaded later whenever you want to play them (page 56).



• *Material recorded using the SONG MEMORY is retained in memory even when the POWER switch is turned OFF if backup batteries are present or the AC plug is connected.*

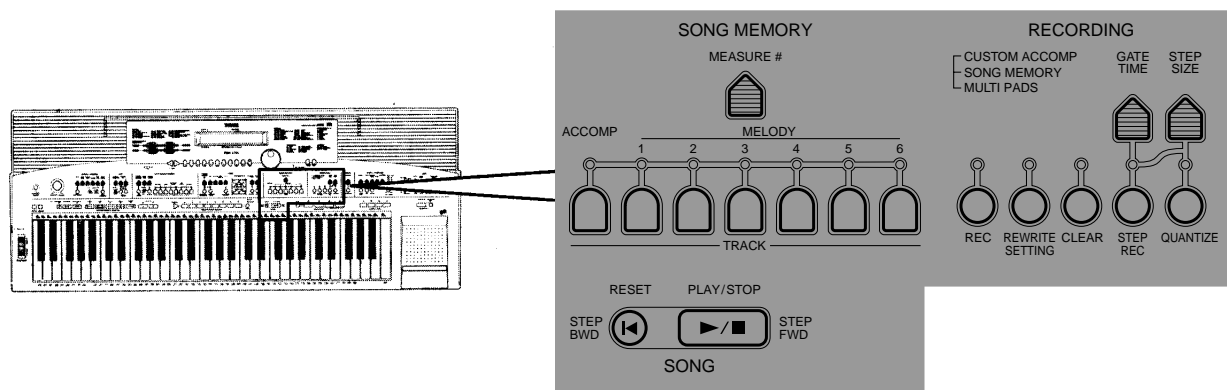

Record Functions

Realtime Accompaniment Track Recording

The SONG MEMORY ACCOMP track records the following operations and data:

- Chord changes.
- Intro, Main, Fill in, Break, & Ending sections.
- Accompaniment volume.
- Fade-in/out.
- Auto accompaniment TRACK button operations.
- Tempo.
- Style number.
- Revoice.

1 Select a Style

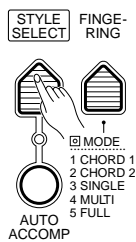

Select an accompaniment style that is appropriate for the type of music you want to record. Also select the fingering mode you want to use, if necessary.

2 Engage the Accompaniment Track Record Ready Mode

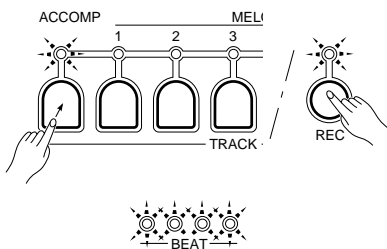

Press the SONG MEMORY section [ACCOMP] track button while holding the RECORDING section [REC] button. This engages the record ready mode for the accompaniment track. If [AUTO ACCOMP] is not already turned on, it will be automatically engaged. The [REC], [ACCOMP], and [SYNC-START/STOP] button indicators will flash, and the BEAT indicator dots will flash at the currently selected tempo. If the OVERALL CONTROL section [METRONOME] button indicator is lit, the metronome will sound at the currently selected tempo.

The current measure (“Mes”) and beat (“BT”) — in this case “Mes=001:BT=1” — will be shown on the LCD display panel.

PSR-1700

Mes=001:BT=1

PSR-2700

00: Showtune 001: GrandPho
Mes=001:BT=1

NOTES

- Accompaniment track recording is carried out using the currently selected Auto Accompaniment fingering mode (page 25).
- Previously-recorded SONG MEMORY tracks that are turned ON (their indicators are lit) can be monitored while recording. If you don't want to hear any of the previous tracks while recording, simply press the corresponding SONG MEMORY TRACK buttons so their indicators go out.
- It is also possible to record one MELODY track at the same time as you record the ACCOMP track. Hold the [REC] button and press the MELODY track button on which you want to record after engaging the ACCOMP track record ready mode. Refer to “Realtime Melody Track Recording” on page 42.
- The ACCOMP track record-ready mode can be disengaged by pressing the [ACCOMP] track button. ACCOMP track record ready cannot be disengaged by pressing the [SYNC-START/STOP] button.

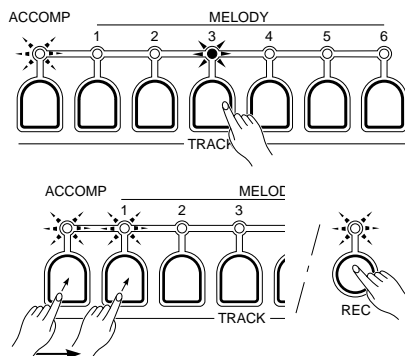

3 Record

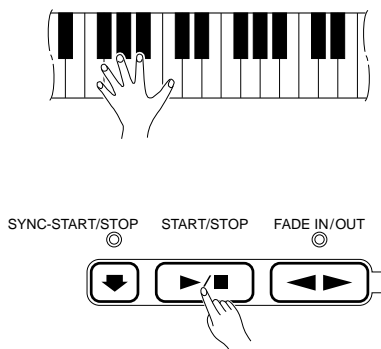

Recording will begin as soon as you play a chord on the Auto Accompaniment section of the keyboard. If you've selected a MELODY track to record with the ACCOMP track, a right-hand note will also start the recording process. The [REC] indicator lights continuously once recording has started, and the current measure and beat will appear on the LCD display panel.

Recording can also be started by pressing the ACCOMPANIMENT CONTROL [START/STOP] button. In this case only the rhythm will begin without bass and chord accompaniment until you play the first chord on the Auto Accompaniment section of the keyboard.

Play the required chords in the Auto Accompaniment section of the keyboard. If you've also selected a MELODY track to be recorded, play the melody on the right-hand section of the keyboard.

NOTES

- **Whenever you record using the SONG MEMORY, any previously recorded material in the same track will be erased and replaced by the new material.**
- You can also start recording from any specified measure number — see page 44.
- If the SONG MEMORY becomes full while recording, "Memory Full" will appear on the LCD display panel and recording will stop. Up to approximately 4,800 notes can be recorded in all MELODY tracks. Up to approximately 4,800 chords can be recorded. These figures only apply, however, if only chords or notes are recorded. The total is reduced when notes and chords are recorded together.
- If you start recording by pressing the [PLAY/STOP] button, nothing will be recorded until you begin playing on the keyboard.
- If you use a function button during recording the corresponding value will appear on the LCD display panel while the button is held. The measure number display will resume a few seconds after the button is released.
- The SONG MEMORY ACCOMP track can also be recorded using the Step Record mode (page 50).

4 Stop Recording

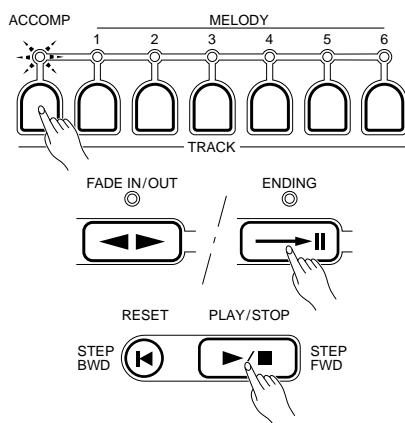

Stop recording by pressing the [ACCOMP] track button. Recording can also be stopped by pressing the [ENDING] button, [FADE IN/OUT] button, or the SONG [PLAY/STOP] button. The [REC] indicator will go out and "Now Processing" will appear on the LCD display panel while the PSR-1700/2700 is processing recorded data. "Completed" will appear briefly when the data has been processed.

NOTES

- When recording is stopped the Song Memory automatically returns to the measure at which recording was started.

Record Functions

Realtime Melody Track Recording

The SONG MEMORY MELODY tracks record the following operations and data:

- Key on/off (i.e. notes played on the keyboard).
- Key velocity.
- Voice number (Percussion Kit, Sampled Voice Number (PSR-2700)).
- Volume.
- Pan.
- DSP depth.
- Harmony on/off & harmony type.
- Effect on/off & effect type.
- Sustain (footswitch) on/off.
- Pitch bend.
- Octave.
- Modulation.
- Expression (foot controller).

* SAMPLE PAD (PSR-2700) and MULTI PAD data cannot be recorded to SONG MEMORY.

1 Select a Voice and Set the Voice Parameters

Select the voice you want to record with (the R1 and R2 voices can be used), and set the voice effects and other parameters as required.

2 Select a Track and Engage the Record Ready Mode

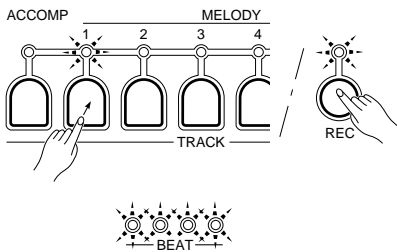

Press one of the MELODY track buttons — [1] through [6] — while holding the RECORDING section [REC] button. Both the [REC] button indicator and the selected MELODY track indicator will flash, indicating that the SONG MEMORY is ready to record. If the OVERALL CONTROL section [METRONOME] button indicator is lit the metronome will also begin to sound at the currently selected tempo, while the BEAT indicator dots flash at the current tempo.

The current measure (“Mes”) and beat (“BT”) — in this case “Mes=001:BT=1” — will be shown on the LCD display panel.



NOTES

- Previously-recorded SONG MEMORY tracks that are turned ON (their indicators are lit) can be monitored while recording. If you don't want to hear any of the previous tracks while recording, simply press the corresponding SONG MEMORY TRACK buttons so their indicators go out.
- Only one melody track can be recorded at a time.
- If the MELODY track record ready mode is engaged, Auto Accompaniment is automatically turned off.

3 Record

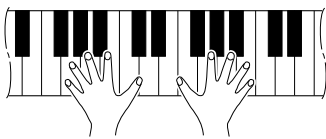

Recording will begin as soon as you play a note on the keyboard or press the SONG [PLAY/STOP] button, and the BEAT indicator dots will begin to indicate the current beat as in the Auto Accompaniment mode, and the current measure and beat number will appear on the LCD display panel.

Play the melody using the entire keyboard if you are recording only a MELODY track, or on the right-hand section of the keyboard if you are recording a MELODY track at the same time as the ACCOMP track.



NOTES

- The SONG MEMORY MELODY tracks can also be recorded using the Step Record mode — see page 50.

4 Stop Recording

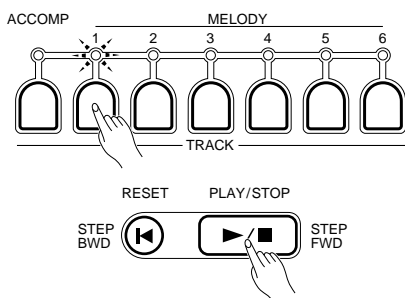

Stop recording by pressing the TRACK button of the melody track being recorded, or the SONG [PLAY/STOP] button. The [REC] indicator will go out and “Now Processing” will appear on the LCD display panel while the PSR-1700/2700 is processing recorded data. “Completed” will appear briefly when the data has been processed. The measure number will automatically return to the measure at which recording was started.

5 Save Your Completed Song to Floppy Disk

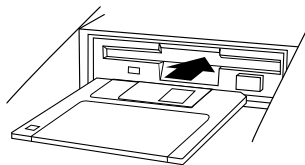

When you've finished recording your song — or have recorded as much as you want to in the current session — save your song to floppy disk as described on page 58. Making this step a habit will prevent accidental loss of data.



- The song data is retained in memory even when the power switch is turned off as long as the backup batteries are installed or the AC plug is connected. It is nevertheless a good idea to save important song data to floppy disk so you have a backup in case of accidental erasure.

■ Accompaniment And Melody Playback

1 Load a Song If Necessary

If necessary, load the song you want to play back from floppy disk (refer to page 60). This step can be ignored if the song you want to play is already in the PSR-1700 or PSR-2700 memory.

2 Select the Tracks to Play Back

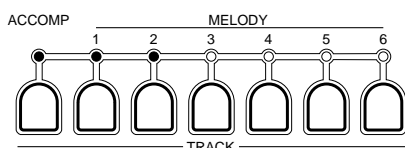

Any number of MELODY tracks and/or the ACCOMP track can be played back at the same time. Press the SONG MEMORY TRACK buttons corresponding to the tracks you want to play back — the indicators of the selected tracks will light.



- All SONG MEMORY tracks that contain recorded data are automatically turned ON when the power switch is turned on or a song is loaded from floppy disk.
- Measure number 1 is automatically selected whenever the power switch is turned on or a song is loaded from floppy disk.

3 Start Playback

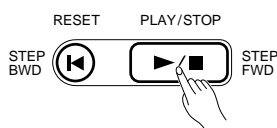

Playback will begin as soon as the SONG [PLAY/STOP] button is pressed. You can turn the ACCOMP and MELODY tracks on and off during playback by pressing the appropriate TRACK buttons. During playback the current measure and beat will appear on the LCD display panel.



- Use the [RESET] button to return to the first measure of the song at any time (see page 44).
- You can also start playback from any specified measure by using the [MEASURE #] button (see page 44).

4 Play Along If You Like

Play along on the keyboard if you like. You can also change the tempo during playback.



- The maximum polyphony is 28. If more than 28 notes are played at the same time, some notes may be truncated. If you are using a sampled voice an additional 26 notes are available for the sampled voice only.

5 Stop Playback

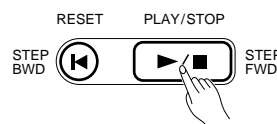

Accompaniment and melody playback will stop automatically when all recorded data has been played back. You can also stop playback at any time by pressing the SONG [PLAY/STOP] button.

Record Functions

■ The [RESET] Button

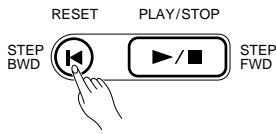

Press the SONG [RESET] button to go directly to the first measure of the song and turn ON all tracks that contain data. Measure number “001” will appear on the LCD display panel. The [RESET] button also functions during playback or realtime recording.

PSR-1700

Mes=001:BT=1

PSR-2700

08:Showtune 001:GrandPho
AccOff Mes=001:BT=1

■ Record Or Play from a Specified Measure

You can start SONG MEMORY recording or playback from any specified measure, as long as the specified measure is within the range of measures that has already been recorded:

1 Press the [MEASURE #] Button If Necessary



If the measure number is not currently shown on the LCD display panel, press the [MEASURE #] button. If the measure number is already showing, go directly to step 2.

2 Enter the Desired Measure Number



Use the [+] and [-] buttons, the number buttons, the data dial, or the [MEASURE #] button itself to enter the desired measure number.

3 Start Playback or Recording

Start playback or recording. You can now start playback or recording from the specified measure number.



NOTES

- This function allows you to “punch-in” and “punch-out” at any measure to re-record a section of a previously-recorded track.

Example:

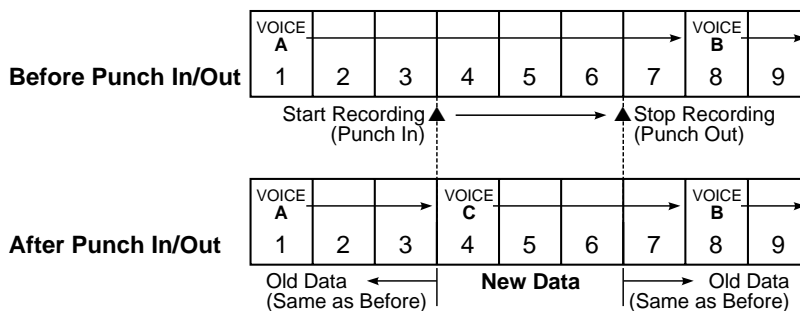

- Voice, volume, pan, pitch bend, modulation, tempo, harmony on/off, effect on/off, dual on/off, DSP depth and revoice data changes made during the punch-in remain in effect even after the punch-out point until further parameter changes are encountered in the old data.



NOTES

- Recording is carried out in 1-measure units. If you punch out in the middle of a measure, rests will be recorded for the remainder of that measure.

The Multi Pads

The PSR-1700 and PSR-2700 MULTI PADS can be used to record short rhythmic or melodic sequences, percussion fill-ins, or single percussion sounds that can be played at any time simply by pressing the appropriate pad. Pads [1] and [2] play back exactly as recorded, while pads [3] and [4] are “CHORD MATCH” types which are automatically transposed to match chords played using the Auto-accompaniment feature.

Only one set of MULTI PAD data can be retained in the PSR-1700 or PSR-2700 memory at a time, but any number of MULTI PAD sets can be saved to floppy disks and then reloaded later when needed (page 56).

The MULTI PADS record the following operations and data:

- Key on/off (i.e. notes played on the keyboard).
- Key velocity.
- Voice number (Percussion Kit, Sampled Voice Number (PSR-2700)).
- Volume.
- Pan.
- DSP depth.
- Octave.
- Harmony on/off & harmony type.
- Effect on/off & effect type.
- Sustain on/off (footswitch).
- Pitch bend.
- Modulation.
- Expression (foot controller).

NOTES

- Before recording, the PSR-1700/PSR-2700 memory contains a preset set of MULTI PAD data that will be erased when new MULTI PAD data is recorded. The original preset data can be restored by using the “System Reset” function described on page 82.

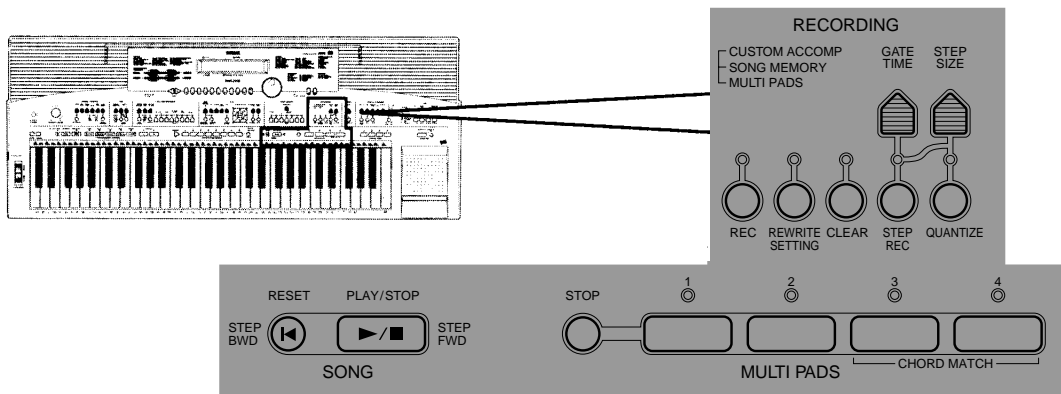

Realtime Recording

1 Select a Voice to Record and an Appropriate Tempo

Select the voice you want to record on the MULTI PADS. Only the [R1] and [R2] voices can be used. You might also want to set a tempo that will be easy to record at.

2 Engage the MULTI PAD Record Ready Mode

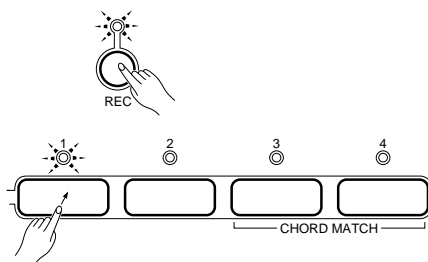

Press one of the MULTI PAD buttons — [1] through [4] — while holding the [REC] button. The [REC] button indicator and the selected MULTI PAD indicator will flash to indicate that the record ready mode is engaged, and the metronome will begin to sound at the currently selected tempo if the OVERALL CONTROL section [METRONOME] button indicator is lit.

NOTES

- Only the R1 and R2 orchestration parts can be recorded to the MULTI PADS.
- If the MULTI PAD record ready mode is engaged, Auto Accompaniment is automatically turned off.

Record Functions

3 Record

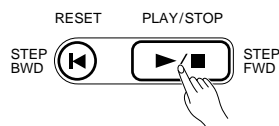
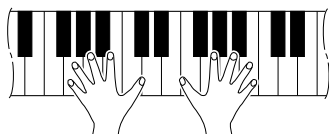

Play a short sequence. The MULTI PADS can record up to approximately 550 quarter notes. The [REC] button indicator will light during recording, and the BEAT indicator will indicate the current beat as in the Auto Accompaniment mode.



- Whenever you record to a MULTI PAD, all previous data in the same pad will be completely erased and replaced by the new material.
- Recording can also be started by pressing the [PLAY/STOP] button.
- The MULTI PADS can also be recorded using the Step Record mode — see page 50.
- When recording the CHORD MATCH pads — [3] and [4] — base all melodic and chordal phrases on a CM7 chord so that the sound will be properly transposed when used with the Auto Accompaniment feature (see “Playback” below).

4 Stop Recording

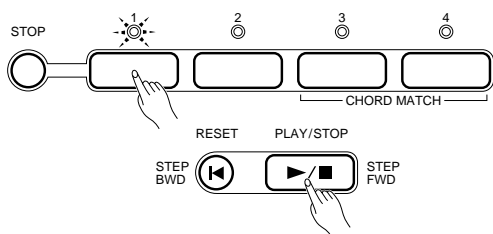

Press the MULTI PAD button being recorded, the MULTI PADS [STOP] button or the [PLAY/STOP] button to stop recording. Recording will also stop automatically and “Memory Full” will appear on the LCD display panel when the pad memory becomes full.

5 Save Your MULTI PAD Data to Floppy Disk

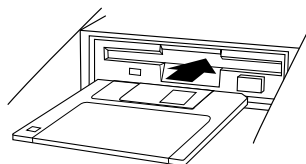

When you’ve finished recording your MULTI PAD data save it to floppy disk as described on page 58. Making this step a habit will prevent accidental loss of data.

Playback

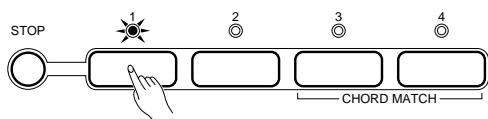

Simply tap any of the MULTI PADS at any time to play back the data they contain. MULTI PAD playback begins as soon as the button is pressed. You can even play two, three, or four MULTI PADS at the same time. Also, you can create “retriggered sample” effects by repeatedly pressing a pad before its contents are completely played back.

The MULTI PAD voices are independent from the voices you have currently selected for keyboard performance. You could, for example, play piano on the keyboard while a MULTI PAD plays a brass chord stab.

MULTI PADS [3] and [4] are “CHORD MATCH” types, and the data they contain will be automatically transposed to match chords played using the Auto Accompaniment feature.

MULTI PAD playback can be terminated by pressing the MULTI PADS [STOP] button.



- MULTI PAD playback speed is determined by the current TEMPO setting.
- The contents of the MULTI PAD memory are retained in memory even when the power is turned off as long as backup batteries are present or the AC plug is connected.
- Percussion data recorded to either of the CHORD MATCH pads will play back in the same way as the normal pads.
- To use MULTI PAD data from disk, load the data into the PSR-1700/2700 as described on page 60.

Custom Accompaniment

Style number “00” is a “custom accompaniment” that you can record yourself and use with the Auto Accompaniment feature.

Only one custom accompaniment can be retained in the PSR-1700 or PSR-2700 memory at a time, but any number of custom accompaniments can be saved to floppy disks and then reloaded later when needed (page 56).

The CUSTOM ACCOMPANIMENT records the following operations and data:

- Key on/off (i.e. notes played on the keyboard).
- Key velocity.
- Voice number (Percussion Kit, Sampled Voice Number (PSR-2700)).
- Volume.
- Pan.
- DSP depth.
- Sustain (footswitch) on/off.
- Pitch Bend
- Modulation

NOTES

- Expression (foot controller) data can not be recorded to a custom accompaniment.
- Before recording, style number 00 contains a preset accompaniment that will be erased when a custom accompaniment is recorded. The original preset accompaniment can be restored by using the “System Reset” function described on page 82.

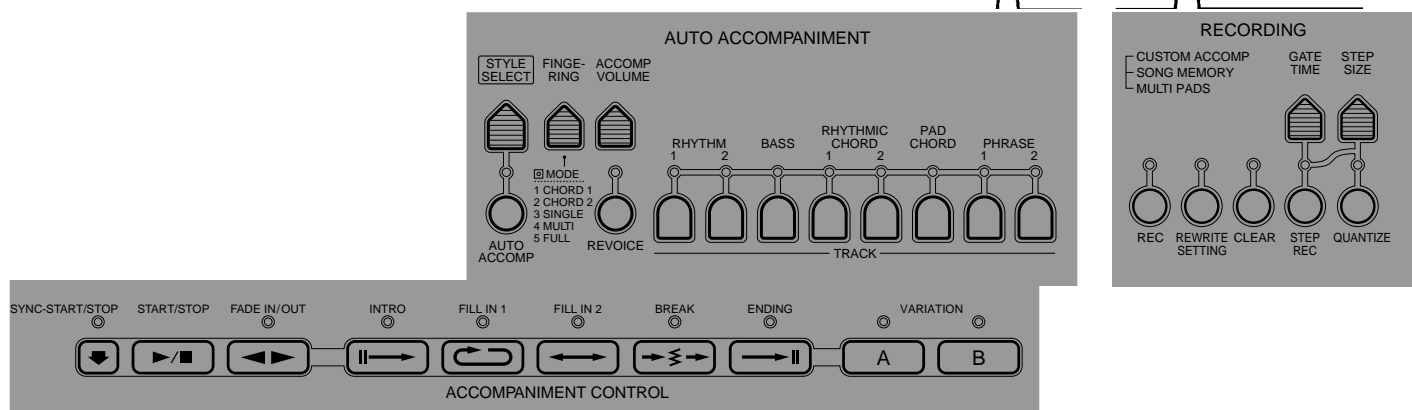
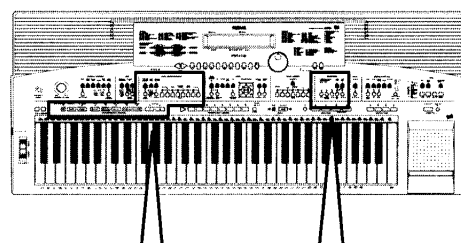

Realtime Custom Accompaniment Recording

1 Select a Style & Section

Select an accompaniment style that will serve as an appropriate foundation for the type of accompaniment you want to record. Also use the ACCOMPANIMENT CONTROL buttons to select the particular section you want to record. When selecting a section other than a main section, be sure to also select the main A or main B section, as required.

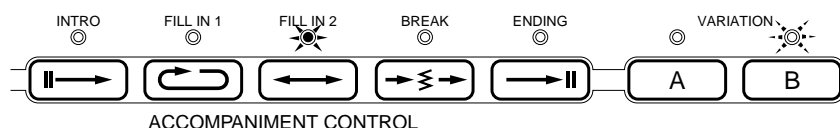

Example: Selecting FILL IN 2B

Record Functions

2 Engage the Custom Accompaniment Record Ready Mode

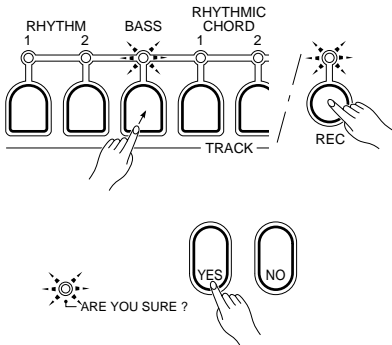

Press the AUTO ACCOMPANIMENT section TRACK button corresponding to the accompaniment track you want to record while holding the RECORDING section [REC] button. (If the selected track contains no preset data, “IllegalOperation” will appear on the LCD display and the custom accompaniment record ready mode cannot be engaged.) Both the [REC] and track indicators will flash and, if you’ve selected a preset accompaniment style on which to base your custom accompaniment (not number “00”), the ARE YOU SURE? indicator will light and the PSR-1700/PSR-2700 will ask “Are you sure?” (see NOTES, below). Press the [YES] button if you want to go ahead with the record procedure, thus erasing the previous contents of the custom accompaniment. This engages the record ready mode for the specified track. If the OVERALL CONTROL section [METRONOME] button indicator is lit, the metronome will sound at the currently selected tempo. Press [NO] to cancel the operation and preserve the contents.

NOTES

- If you select a style number other than “00” on which to base your custom accompaniment, the selected style is copied to the custom accompaniment being recorded as soon as the record ready mode is engaged and the [YES] button is pressed, thus erasing all previous custom accompaniment data.
- When the built-in preset style data is copied to custom style number 00, “@” will be shown at the beginning of the custom style name on the LCD display.
- Auto Accompaniment, Auto Harmony, and Effect are turned OFF, the R1 orchestration part is selected, and the [EDIT] button is disabled when the custom accompaniment record ready mode is engaged.
- If a track containing rhythm data is specified for recording, Keyboard Percussion is automatically turned on.
- When the record-ready mode for the selected track is engaged, other track(s) of the corresponding section having no accompaniment style data will automatically be turned off.
- A track that does not contain data in any section (the track indicator is off) cannot be used for custom accompaniment recording.

3 Select a Voice & Set the Tempo as Required

If necessary, select the voice you want to record with, and set a comfortable recording tempo.

NOTES

- The specified voice parameters can be changed later by using the REWRITE SETTING and REVOICE functions (pages 55 and 34).

4 Record

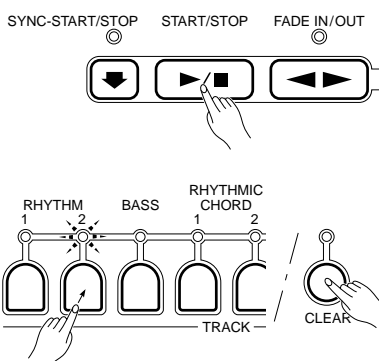

Recording will begin as soon as you press the ACCOMPANIMENT CONTROL section [START/STOP] button or play a chord or note on the keyboard. The accompaniment will play repeatedly, and you can add new material to the selected track by playing on the keyboard.

During recording you can clear a track if you want to record new material from scratch: press the TRACK button corresponding to the track you want to clear while holding the [CLEAR] button. Individual notes, including Keyboard Percussion instruments, can be cleared by pressing the appropriate key while holding the [CLEAR] button.



- Be sure to record your CUSTOM ACCOMPANIMENT based on a CM7 chord. The parts will be automatically transposed to match the chord played when the CUSTOM ACCOMPANIMENT is played back.
- The “Are you sure?” confirmation will not occur when you clear recorded data while in the record mode.
- Custom accompaniments can also be recorded using the Step Record mode — see page 50.
- With some styles there may be a slight delay between the end of the section and beginning of the next cycle when recording.
- If the CUSTOM ACCOMPANIMENT becomes full while recording, “Memory Full” will appear on the LCD display panel and recording will stop.

5 Repeat to Complete the Accompaniment

Repeat steps **2**, **3**, and **4**, selecting and recording the various tracks as required until your custom accompaniment is complete. You can also switch sections while recording, so you can record an entire custom accompaniment without having to stop recording.



- If you change sections while recording and the current track contains no preset data, “IllegalOperation” will appear on the LCD display panel to indicate that recording is not possible.

6 Stop Recording

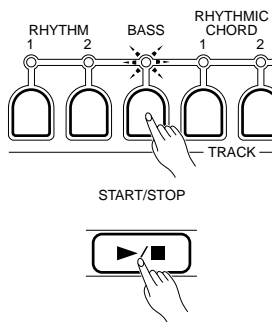

Stop recording by pressing the TRACK button being recorded or the ACCOMPANIMENT CONTROL section [START/STOP] button. The [REC] indicator will go out and “Now Processing” will appear on the LCD display panel while the PSR-1700/2700 is processing recorded data. “Completed” will appear briefly when the data has been processed. The recorded accompaniment data will automatically be stored in the CUSTOM ACCOMPANIMENT (style number “00”).

If you stop recording by pressing the [SYNC-START/STOP] button you will be returned to step **2**, above (the record-ready mode).

7 Save Your Completed Accompaniment to Floppy Disk

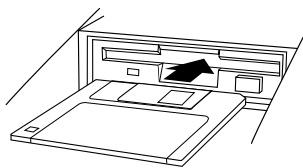

When you’ve finished recording your custom accompaniment — or have recorded as much as you want to in the current session — save your accompaniment to floppy disk as described on page 58. Making this step a habit will prevent accidental loss of data.



- The Custom Accompaniment data is retained in memory even when the power switch is turned off as long as the backup batteries are installed or the AC plug is connected. It is nevertheless a good idea to save important data to floppy disk so you have a backup in case of accidental erasure.

Using a Custom Accompaniment



To use a custom accompaniment simply select style number “00” and use the Auto Accompaniment feature in the normal way (page 24).

PSR-1700

```
Styl=00:qShowtun
```

PSR-2700

```
00:qShowtun 001:GrandPno  
AccOff Styl=00:qShowtun
```



- To use style data from disk, load the data into the PSR-1700/2700 as described on page 60.

Step Recording

In addition to the realtime-recording procedures described above, the PSR-1700 and PSR-2700 have a “step recording” mode in which notes can be entered one at a time with precise timing and length.



- Only chord sequences can be step-recorded to the Song Memory ACCOMP track. The REWRITE SETTING function (page 55) can be used after recording to change other parameters as required.
- You can specify the measure from which you want to begin song memory step recording as described on page 44.
- The Metronome does not function during step recording.
- The following parameters cannot be changed during Song Memory ACCOMP track step recording: style number, section, track on/off, revoice on/off, registration memory, fade in/out.

1 Engage the Step Record Ready Mode

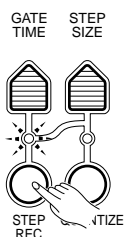

Press the track or pad button corresponding to the track or pad you want to record (see NOTES below) while holding the RECORDING section [STEP REC] button. This engages the record ready mode for the specified track or pad. Both the [STEP REC] and track/pad button indicators will flash.



- When the step record ready mode for the Song Memory ACCOMP track is engaged, the VARIATION A section indicator will light.
- To step record a SONG MEMORY track press the appropriate SONG MEMORY track button; to step record a CUSTOM ACCOMPANIMENT track press the appropriate AUTO ACCOMPANIMENT track button; to step record a MULTI PAD press the appropriate pad.

2 Specify the Required Step Size

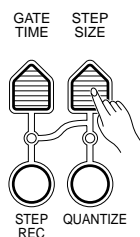

“Step Size” refers to the length of the note to be entered. To enter an eighth note and advance to the next eighth note, for example, the step size should be set to “1/8”.

Press the [STEP SIZE] button and the current step size will appear on the LCD display panel. Then use the [+] and [-] buttons, the number buttons, the data dial, or the [STEP SIZE] button itself to select the required step size (1/4... 1/32).

The “1/16” step size can be instantly selected by pressing the [+] and [-] buttons simultaneously.

PSR-1700

Step=0: 1/4Note

PSR-2700

08:Shoutune 001:GrandPro
AccOff Step=0: 1/4Note

Step Size Settings

1 : 1/4 Note	
2 : 1/6 Note	
3 : 1/8 Note	
4 : 1/12 Note	
5 : 1/16 Note	
6 : 1/24 Note	
7 : 1/32 Note	



- The currently selected step size is retained in memory even when the power switch is turned off, as long as the backup batteries are installed or the AC plug is connected.

3 Specify the Required Gate Time

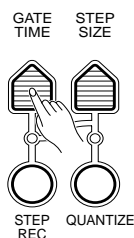

“Gate Time” refers to the actual length of the note to be entered in relation to the note’s step size — i.e. whether the note is staccato, legato, etc. Gate times are specified as percentages of the total note length, as shown in the list below.

Press the [GATE TIME] button and the current gate time will appear on the LCD display panel. Then use the [+] and [-] buttons, the number buttons, the data dial, or the [GATE TIME] button itself to select the required gate time (0% ... 100%). The “80%” gate time can be instantly selected by pressing the [+] and [-] buttons simultaneously.

PSR-1700

GateT.=08:80%

PSR-2700

08:Showtune 001:GrandPno
AccOff GateT.=08:80%

Gate Time Settings

00 : 0%	(Most staccato)	06 : 60%] Normal
01 : 10%		07 : 70%	
02 : 20%		08 : 80%	
03 : 30%		09 : 90%	
04 : 40%		10 : 100%	
05 : 50%			



NOTES

- The current gate time setting is retained in memory even when the power switch is turned off, as long as the backup batteries are installed or the AC plug is connected.

4 Play a Note or Chord

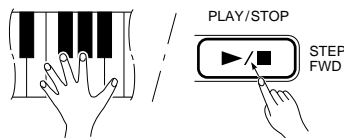

Play the note on the keyboard corresponding to the pitch of the note you want to enter, or a chord if you want to enter a chord. You can then press the [STEP FWD (PLAY/STOP)] button while still holding the note or chord as many times as necessary to extend the length of the note or chord by the specified step size.



NOTES

- When several notes are played simultaneously, all the notes will be recorded at one time as a chord after the last key pressed is released. This is a handy technique for the chord progression recording.
- The BEAT indicator LEDs function in the same way as they do in the Auto Accompaniment mode.

PSR-1700

Mes=001:BT=1---|---

PSR-2700

08:Showtune 001:GrandPno
AccOff Mes=001:BT=1---|---

The LCD display panel During Step Record

During step recording the LCD display panel shows the current measure number (“Mes”), the current beat (“BT” — there are, for example, four beats per measure in 4/4 time), and the position of the current note within the current beat (the bar to the right of the “BT” value). Each division on the bar represents a 32nd note. If you are entering 16th notes, for example, the vertical marker on the bar graph will move forward by two divisions when each note is entered.

To Enter a Rest ...

Rests can be entered by pressing only the [STEP FWD (PLAY/STOP)] button immediately after specifying the required step size for the rest.

Stepping Backward

In the STEP RECORD mode the [RESET] button functions as the [STEP BWD] (step backward). You can use this button to step backward through the recording by the currently specified step size while erasing the data.

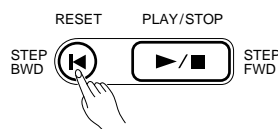
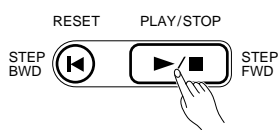











Record Functions





Example

The following chart shows the step size and gate time settings required to enter a variety of notes:



LCD DISPLAY (Measure)	Mes=001	Mes=001	Mes=001	Mes=001	Mes=001	—	Mes=002	Mes=003
LCD DISPLAY (Beat/Clock)	BT=1 ----	BT=2 --	BT=3 ----	BT=3 --	BT=4 ----	—	BT=3 ----	BT=1 ----
LCD DISPLAY (Step Size)	1/8Note	1/16Note	1/8Note	1/8Note	1/4Note	—	1/4Note	1/4Note
LCD DISPLAY (Gate Time)	80%	80%	80%	80%	80%	—	40%	80%
Note	 Hold			—	 Hold	—		 Hold
Press [PLAY/STOP]	 Twice	—	—	 Once	 Twice	—	—	 Three times

It's also possible to specify the step sizes for all notes by specifying the shortest required step size and then using the [STEP FWD] button to enter all other note lengths.

  • In the case shown to the left, press and hold , press [STEP FWD] and then , and then release .

5 Repeat

Repeat steps **2**, **3**, and **4** until the required number of notes has been entered.

 • Previously-recorded tracks can not be monitored during step recording.

6 Stop Recording

Stop recording by pressing the track or MULTI PAD button being recorded. The [STEP REC] indicator will go out.

 • PSR-1700/2700 allows you to "punch-in" and "punch-out" at any measure to step re-record Song Memory data. Step recording is carried out in 1-measure units, so if you punch out in the middle of measure rests will be recorded for the remainder of that measure.

• "Now Processing" may appear on the LCD display panel while the PSR-1700/2700 is processing step-recorded data. "Completed" may appear briefly when the data has been processed.

Editing Functions

The following functions make it possible to “edit” recorded data to polish and refine your sound.



- When using any of the editing functions on a custom style, be sure to select style number 00 before engaging the editing function.

Quantization

It is possible to “quantize” recorded data to straighten out the timing of a track or pad.

1 Set the Quantize Step Size

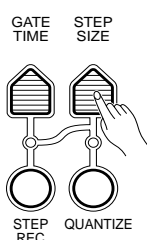

Set the required quantize step size in the same way as the step-record step size (see page 50).

PSR-1700

Step=@:1/4Note

PSR-2700

@8:Showtune @01:GrandPro
AccOff Step=@:1/4Note

2 Select the Track or Pad to Be Quantized

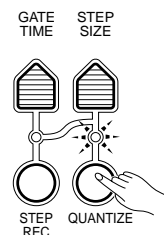

Press the track or pad button corresponding to the track or pad you want to quantize while holding the RECORDING section [QUANTIZE] button. Both the [QUANTIZE] and track/pad button indicators will flash. The ARE YOU SURE? indicator will light and the PSR-1700/PSR-2700 will ask “Are you sure?”



- You can quantize several Song Memory or Custom Accompaniment tracks at the same time. Press the required track buttons one after another while holding the [QUANTIZE] button.

3 Confirm or Cancel the Quantize Operation

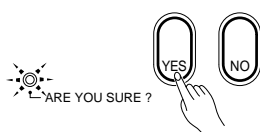

Press the [YES] button if you want to go ahead with the quantize operation, thus irreversibly altering the selected track or pad. Press [NO] to cancel the operation and preserve the contents of the track or pad. “Now Quantizing” will appear on the LCD display panel while the data is being quantized. “Completed” will appear briefly when the data has been quantized.



- Preset accompaniment track data cannot be quantized.

Record Functions

■ Clearing Tracks

The [CLEAR] button can be used to completely erase the following data:

- All data after the current measure in the specified SONG MEMORY track.
- All data from the specified CUSTOM ACCOMPANIMENT track.
- All data from the specified MULTI PAD.

1 For a SONG MEMORY Track, Set the Start Measure

MEASURE #



Use the [MEASURE #] button to set the first measure to be cleared (page 44). All subsequent measures up to the end of the song will be cleared.

2 Specify the Track or Pad to Be Cleared



Press the appropriate track or pad button while holding the [CLEAR] button. The ARE YOU SURE? indicator will light and the PSR-1700/PSR-2700 will ask “Are you sure?”



CAUTION

- **Turning the power OFF during the clear-ready mode can result in a loss of recorded data.**



NOTES

- *You can clear several Song Memory or Custom Accompaniment tracks at the same time. Press the required track buttons one after another while holding the [CLEAR] button.*

3 Confirm or Cancel the Clear Operation

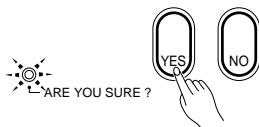

Press the [YES] button if you want to go ahead with the clear operation, thus erasing the selected track or pad. Press [NO] to cancel the operation and preserve the contents of the track or pad. “Now Clearing” will appear on the LCD display panel while the data is being cleared. “Completed” will appear briefly when the data has been cleared.



NOTES

- *Since the track indicators light when there is data in any accompaniment section, clearing a Custom Accompaniment track will not cause the track indicator to go out if data is present in any other section.*

■ Changing the Recorded Settings

The **[REWRITE SETTING]** button can be used to change the settings of all recordable parameters for any specified track or pad. You could, for example, use this function to change the voice or effect used in a SONG MEMORY track.

Rewritable Data

All data in the following tracks and pads except note on/off, octave, sustain, pitch bend, modulation, expression, and chord changes:

- Song Memory Accompaniment Track
- Song Memory Melody Tracks
- Custom Accompaniment
- Multi Pad

1 For Song Memory Settings Set the Start Measure



Only if you will be rewriting Song Memory settings, use the **[MEASURE #]** button in conjunction with the **[+]** and **[-]** buttons, the number buttons, or the data dial to specify the measure at which you want the settings to be rewritten. The specified measure number will appear on the LCD display panel.

2 Select the Track or Pad to be Altered



Press the track or pad button corresponding to the track or pad you want to alter while holding the RECORDING section **[REWRITE SETTING]** button (for a Custom Accompaniment, first select the section you want to edit). Both the **[REWRITE SETTING]** and track/pad button indicators will flash.

3 Change the Settings as Required

■ SONG MEMORY/MULTI PADS

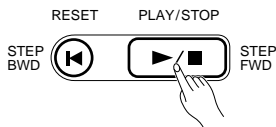

For the Song Memory or Multi Pads use the **[PLAY/STOP]** button to start playback. Make the required setting changes to the recordable parameters at the appropriate point during playback.

If you make any changes during rewrite standby — i.e. after engaging the Rewrite Setting function but before starting playback — the specified changes will be at the very beginning of the track/pad data (at the beginning of the specified measure for the Song Memory).

■ CUSTOM ACCOMPANIMENT

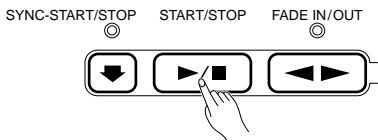

For a Custom Accompaniment, use the ACCOMPANIMENT CONTROL section **[START/STOP]** button or play a note on the keyboard to start playback and then make the required setting changes to the recordable parameters. Rewriting data in the middle of a Custom Accompaniment pattern affects the entire track.



- Preset accompaniment track data cannot be rewritten.

4 Stop

Press the track or pad button for which the settings have been rewritten.

Using Floppy Disks

The PSR-1700 and PSR-2700 feature a floppy disk drive that allows virtually unlimited storage of songs you record using the Song Memory, custom accompaniments, Multi Pad data, Registration Memory data, and sampled voices (PSR-2700 only). The disk drive also allows the PSR-1700 and PSR-2700 to play standard MIDI music files (file format 0) and Yamaha Disk Orchestra Collection disks.

PSR-1700

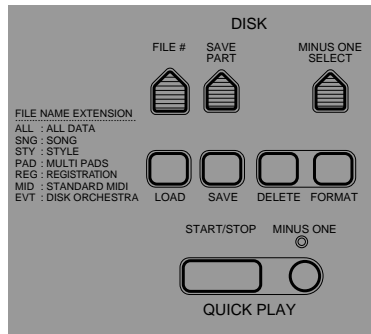

PSR-2700

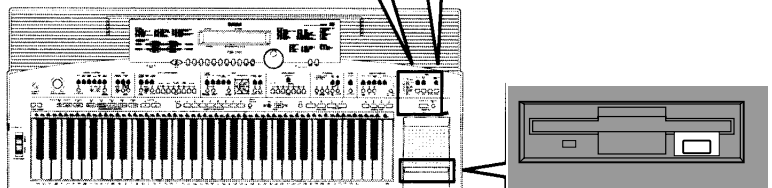
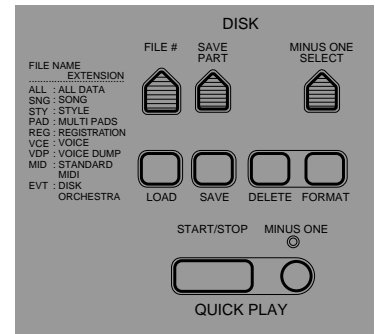

● Floppy Disk Handling Precautions

Floppy disks are an inexpensive, convenient, and reliable way to store your music data. They are not indestructible, however, and should be handled with care. Observe the following points to ensure the long-term safety of your disks and data.

● Type of Disk

- Use only double-sided double density (2DD) 3.5-inch floppy disks with the PSR-1700 and PSR-2700.

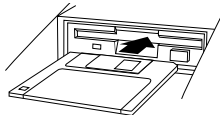

● Taking Care of Your Floppy Disks

- Never attempt to eject a disk during a read or write operation (i.e. while the disk drive is operating). Doing so can damage both the disk and the drive.
- Never turn the power on or off while a disk is in the drive. Always eject the disk before turning the power off.
- To eject a floppy disk from the disk drive press the eject button slowly as far as it will go. Then when the disk is fully ejected, remove it by hand.

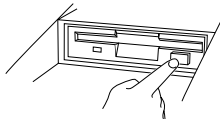

The disk may not be ejected properly if the eject button is pressed too quickly or if it is not pressed in far enough (the eject button may become stuck halfway with the disk extending from the slot by only a few millimeters). If this is the case, do not attempt to pull out the partially ejected disk. Doing so may damage the disk drive mechanism and/or the floppy disk. To remove a partially ejected disk, try pressing the eject button once again or push

the disk back into the slot, then repeat the eject procedure carefully.

- Do not insert anything but floppy disks into the disk drive. Other objects can damage the disk drive or floppy disk.
- Never open the disk's shutter by hand or touch the internal surface of the disk. Dirt, dust, or grease on the disk's magnetic surface can cause data errors.
- Never leave disks near a speaker, TV, or other device that emits a strong magnetic field. Strong magnetic fields can partially erase the data on the disk.
- Do not store disks in places exposed to direct sunlight or other sources of heat. The acceptable storage temperature range is approximately 4° to 53°C (39° to 127°F).
- Do not store disks in areas subject to extreme dryness or humidity. The acceptable relative humidity range is approximately 8 to 90%.
- Do not store disks in areas contaminated with dust, sand, smoke, etc.
- Do not place heavy objects such as books on top of a disk.
- Avoid getting floppy disks wet, particularly with oily or sticky fluids. A disk that has been wet with water should be allowed to dry naturally before use. Disks contaminated by other fluids can cause damage to the disk drive and should be discarded.
- Be sure to apply the disk label at the proper position. When changing the label never cover the old label with a new label; always remove the old label first.

● Head Cleaning

With extended use the read/write head of the disk drive will pick up dust and other particles that will eventually cause data errors. If this occurs, clean the head with a 3.5 inch head cleaning disk available from most computer supply stores.

● Data Backup

For maximum data security we strongly recommend that you keep two copies of important data on separate floppy disks. These disks should ideally be stored in separate locations. This gives you a backup if one disk is lost or damaged.

● Protecting Your Data (Write Protect Tab)

To prevent accidental erasure of important data, slide the disk's write-protect tab to the "protect" position (tab open). With the tab in this position data can be read from the disk but nothing can be written to it.

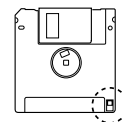

Write protect tab on (locked — write protected)



Write protect tab off (unlocked — write enabled)

■ Formatting a New Floppy Disk

The PSR-1700 and PSR-2700 use only 3.5" 2DD floppy disks. Before you can use a new disk for saving data, the disk must be "formatted" as described below.

1 Insert the Disk To Be Formatted

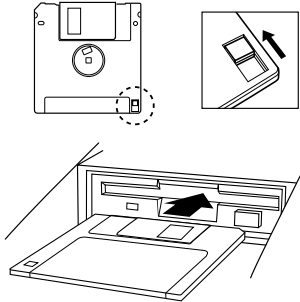

Insert a new blank disk. Make sure that the disk's write protect tab is set to the "write" position (tab closed), and insert the new disk into the disk drive unit with the sliding door facing the drive slot and the label side of the disk facing upward. The disk should click securely into place.

When an unformatted disk is properly loaded, "Format?" will appear on the LCD display panel, the ARE YOU SURE? indicator will flash and the PSR-1700/PSR-2700 will ask "Are you sure?"

PSR-1700

Format?

PSR-2700

08:Showtune 001:GrandPno
AccOff Format?



NOTES

- If an unformatted disk is already in the drive and the format operation was cancelled prior to execution, press the [FORMAT] button to re-engage the format function.
- The [FORMAT] button can also be used when you want to re-format a formatted disk - to erase all the data it contains, for example.
- "Unformatted Disk" will appear on the display if an unformatted write-protected disk is loaded. Make sure the disk's write protect tab is in the write position before formatting.

2 Confirm and Format



Press the [YES] button to confirm and execute the format operation (or press [NO] to cancel). Formatting an entire disk takes a few seconds, and the progress of the operation is shown on the LCD display panel in percent formatted: "0%" through "100%". When the disk has been 100% formatted the format function will be automatically disengaged.

PSR-1700

Formatting: 75%

PSR-2700

08:Showtune 001:GrandPno
AccOff Formatting: 75%



NOTES

- **Be careful not to format a disk that already contains data you want to keep. The format operation erases all data on the floppy disk!**
- The "Format?" display will also appear if you insert a disk that has been formatted on a piece of equipment other than the PSR-1700 or PSR-2700.



CAUTION

- **Never remove the disk or turn the power off while the "Formatting" display is showing.**

Using Floppy Disks

■ Saving, Loading, & Deleting Disk Files

● Saving to Disk

A single floppy disk can hold up to 99 separate files (depending on the file size). Each file on a disk has a unique file number (01 through 99) and file name. You can specify both the file number and file name you want to save to.

When saving data to disk you must also specify a file type according to the type of data you want to save. The file types are listed below (they're also listed on the panel in the DISK control section). The "file extension" is a period and three-character suffix attached to the end of each file name to identify the file type.

Type	File Extension	Data Saved
All	.ALL	All data except sampled voices: song, custom accompaniment, multi pad, registration memory.
Song	.SNG	The song data currently in the song memory.
Custom Style	.STY	The current custom style (style no. 00)
Multi Pad	.PAD	All current multi pad data; pads [1] through [4].
Registration Memory	.REG	All current registration memory settings; [1] through [8].
Single Voice (PSR-2700)	.VCE	A single specified sampled voice (the currently selected sampled voice in the digital sampling section).
Sample Dump (PSR-2700)	.VDP	All sampled voices currently in the sample memory.



NOTES

- In the case of a Single Voice (.VCE) the currently selected sampled voice number will be saved with the sampled voice data. The same sampled voice number will then be automatically selected when the voice is loaded (the load destination voice number can be changed as required).

1 Insert a Formatted Disk

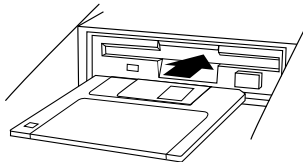

If an appropriate disk is not already in the drive, insert the disk you want to save the data to. If necessary, format the disk as described in the previous section before proceeding.



NOTES

- When a formatted disk is inserted the amount of space remaining on the disk is displayed in kilobytes.

2 Select a File Type



Press the [SAVE PART] button and use the [+] and [-] buttons, the number buttons, the data dial, or the [SAVE PART] button itself to specify the file type that you want to save.

PSR-1700

PART=ALL

PSR-2700

08:Showtune 001:GrandPho
AccOff PART=ALL

3 Select a File Number

FILE #



Press the [FILE #] button and use the [+] and [-] buttons, the number buttons, the data dial, or the [FILE #] button itself to specify the file number you want to save to.

PSR-1700

F01:*****.*

PSR-2700

08:Showtune 001:GrandPho
AccOff F01:*****.*



CAUTION

- If you select a file number that already contains data, the original data will be erased and replaced by the new data!

4 Press the [SAVE] Button and Confirm

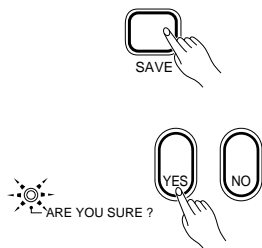

When the desired file type and number have been specified, press the [SAVE] button. The ARE YOU SURE? indicator will flash, and the PSR-1700/PSR-2700 will ask “Are you sure?”. Press [YES] to continue or [NO] to cancel the save operation.

“Saving” will appear on the LCD display panel for a few seconds while the data is being saved. “Save Completed” will appear briefly when the data has been saved.

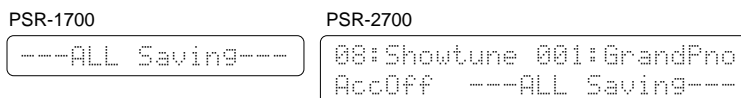

NOTES

- An “S” will appear in front of the file number when the save function is selected .

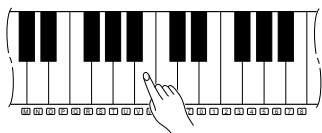

● Enter an Original File Name Prior to Saving

The PSR-1700/PSR-2700 automatically creates a file name (for example “PSR_ _01”) for the file you are about to save. If you want to enter a more descriptive name for easier file identification (and this is recommended), this can be done via the keyboard immediately before executing step 4, above. A file name can consist of up to eight characters. Each key on the keyboard enters a different character, listed immediately below the key. The lowest key (C1) functions as a shift key that shifts between lower- and upper-case characters: hold the **SHIFT** key while pressing a character key to enter the upper-case character. Each time a character is entered the cursor moves to the next character position (you cannot write over the file extension following the period at the end of the file name). The **F5** and **F#5** keys move the cursor backward and forward within the file name. Use these keys to place the cursor where you want to enter or change a character. The **DELETE** key (G5) deletes the character at the cursor position.

When you’ve completed the name, start the save operation by pressing the **ENTER** key (C6) or by pressing the [YES] button as described in step 4. Duplicate file names are not accepted. If you enter a file name that already exists on the disk, the “Same Name” error message will appear on the display.

CAUTION

- **Never remove the disk or turn the power off while the “Saving” display is showing.**

NOTES

- If the file number you have selected already contains data, the PSR-1700/PSR-2700 will ask for confirmation with the “Overwrite OK?” display. If you’re sure you want to write of the existing data press the [YES] button. Press [NO] if you want to cancel.
- If the disk becomes full during a save operation “Disk Full” will appear on the display and the save operation will be aborted. In this case the data saved up to that point will be cleared. Sampled voices are an exception, however, since they can be saved individually. If the disk becomes full while saving sampled voices the PSR-2700 will request a new disk in order to save the remaining voices (“Insert Disk No. X” display — “X” being the number of the required disk).
- When saving song, custom accompaniment, or multi pad data which uses a sampled voice, be sure to save the sampled voice separately. The sampled voice must then be independently loaded when the song, custom accompaniment, or multi pad data is loaded for use. The sampled voice data will automatically be loaded into the appropriate voice number (do not change the destination voice number when loading).
- Save and Load operations can be canceled by pressing and holding the [NO] button.

Using Floppy Disks

● Loading From Disk

1 Select a File

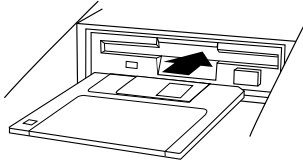

FILE #



With the disk containing the file you want to load properly inserted in the disk drive, press the [FILE #] button and use the [+] and [-] buttons, the number buttons, the data dial, or the [FILE #] button itself to specify the file number you want to load. The name of the selected file appears to the right of the file number on the display.

PSR-1700

F01:PSR__01.ALL

PSR-2700

08:Showtune 001:GrandPno
AccOff F01:PSR__01.ALL

2 Press the [LOAD] Button and Confirm

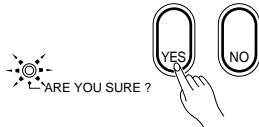

Press the [LOAD] button. The ARE YOU SURE? indicator will flash and the PSR-1700/PSR-2700 will ask “Are you sure?”. Press [YES] to load or [NO] to cancel the load operation. “NowLoading” will appear on the display while the data is being loaded, “Load Completed” will appear briefly when the specified data has been loaded.

PSR-1700

---NowLoading---

PSR-2700

08:Showtune 001:GrandPno
AccOff ---NowLoading---



- **Never remove the disk or turn the power off while the “NowLoading” display is showing. If you turn the power off while loading sampled voices from disk, all data in the PSR-2700 Wave Ram will be lost.**



- **Please note that when you load data from disk the loaded data will replace any current data of the same type in the PSR-1700/PSR-2700 memory.**
- An “L” will appear in front of the file number when the load function is selected.
- If you select a file number with data that cannot be loaded or a file number with no corresponding data, the “Can’t Load!” or “File Not Found!” error message will appear (see “Error Messages” on page 81).
- If you load style data from disk, it will automatically be loaded into style number “00” and can be selected and used in the same way as the preset styles.

● Loading Data From the Supplied Demonstration Disk

File numbers 01 through 04 on the PSR-1700/2700 demonstration disk and file numbers 01 and 02 on the PSR-2700 demonstration disk are demo songs that can be played by using the quick play function. When the PSR-2700 demonstration disk is inserted, the sampled voice data will automatically be loaded into sampled voice number 128. The sampled voice will not be loaded automatically if there is already data in sampled voice number 128, or if the wave RAM is full. If there is already data in voice number 128 “Replace OK?” will appear on the LCD display and the “Are you sure?” prompt will sound. press [YES] to continue with the load operation. If the wave RAM is full “Wave Ram Full” will appear on the LCD display. You will have to delete unnecessary data before continuing with the load operation.

File numbers 05 through 12 on the demonstration disk are accompaniment styles that load into style number 00 and can be played by selecting that number. A complete set of 8 voice and other settings appropriate for use with the selected style are also loaded and stored in the registration memory. Press the various REGISTRATION MEMORY buttons to try out these settings.

File numbers 13 through 20 contain complete sets of MULTI PAD data.

For the PSR-2700 file numbers 21 through 24 contain a range of sampled sound effects (sampled voice). Select the destination sampled voice number before loading these (below).



• If you set the supplied data disk's write protect tab to the "off" position and execute a save or delete operation, the data on the disk will be lost. Keep the disk's write protect tab in the "on" position to prevent this.

• When the style data from the supplied disk is loaded, any previous data in style number 00 and the contents of registration memories 1 through 8 will be overwritten.



• Demo song data on the supplied disk(s) are in Standard MIDI File format.

● Loading Sampled Voices (PSR-2700)

When loading individual sampled voices it is also necessary to select the sampled voice number to which you want the voice from disk to be loaded. First select the sampled voice (single) file, press [LOAD], press [YES], and "Load SVC to xxx" will appear on the LCD display. The first number to appear in the "xxx" position is the voice number saved with the voice. At this point you should select the destination sampled voice number (refer to page 66) and the press [YES] to begin loading the voice.



• When you try to load the sound effect data, file numbers 21 through 24, of the included disk to your PSR-2700, the sampled voice numbers 124 through 127 will automatically be shown on the LCD display.

● Deleting a Disk File

1 Select the File To Be Deleted

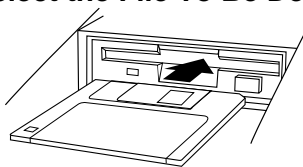

FILE #



With the disk containing the file you want to delete properly inserted in the disk drive, press the [FILE #] button and use the [+] and [-] buttons, the number buttons, the data dial, or the [FILE #] button itself to specify the file number you want to delete. The name of the selected file appears to the right of the file number on the display.

PSR-1700

F01:PSR_01.ALL

PSR-2700

08:Showtune 001:GrandPno
AccOff F01:PSR_01.ALL

2 Press the [DELETE] Button and Confirm



Press the [DELETE] button. The ARE YOU SURE? indicator will flash and the PSR-1700/PSR-2700 will ask "Are you sure?". Press [YES] to delete the selected file or [NO] to cancel the delete operation. "Delete Completed" will appear briefly when the specified file has been deleted.

PSR-1700

Delete Completed

PSR-2700

08:Showtune 001:GrandPno
AccOff Delete Completed

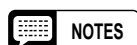

• "File Not Found!" will appear on the display if you attempt to delete a file number that is already empty.

• A "D" will appear in front of the file number when the delete function is selected.

Using Floppy Disks

■ Quick Play: Disk Orchestra Collection & Standard MIDI File Disks

In addition to using files recorded by the PSR-1700 or PSR-2700 itself, the PSR-1700/PSR-2700 can play back pre-recorded Yamaha Disk Orchestra Collection music disks, Yamaha Disklavier PianoSoft, ESEQ files, and Standard MIDI File (file format 0) disks recorded on other equipment.

1 Insert the Disk

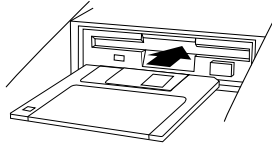

Insert the Disk Orchestra Collection, PianoSoft, or Standard MIDI File disk.



- You can select the song from which you want to start playback by using the standard file number selection procedure (page 60).
- Touch sense 2 is automatically selected when a Disk Orchestra Collection disk is inserted.

2 Start Playback

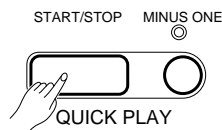

Press the QUICK PLAY [START/STOP] button to start playback. Playback will begin from the first song on the disk (or the selected song) and all songs on the disk will be automatically played in sequence.



- During Quick Play the file number and file name will appear on the LCD display, and “Q” will appear in front of the file number.
- If you press one of the PSR-1700/2700 function buttons during Quick Play, the value of the corresponding function will be displayed for a few seconds then the Quick Play file number/name display will re-appear.
- During Quick Play you can adjust the tempo of playback (page 28).
- If you press the QUICK PLAY [START/STOP] button while a disk that does not contain data that can be played by the Quick Play function is inserted, “Can’t Play!” will appear on the display and the Quick Play operation will be aborted.
- If a Standard MIDI File or ESEQ File is not based on GM voice allocation, the data will not be played back correctly.

• The file extensions for the playable files are as follows:

- Disk Orchestra Collection:
.EVT
- Standard MIDI File (format 0):
.MID and .Xxx (“Xxx” is a number)
- ESEQ File:
.EVT and .Pxx (“xx” is a number)
- PianoSoft:
.spaces

3 Stop Playback

Press the QUICK PLAY [START/STOP] button to stop playback.



- If you re-start playback after stopping it, playback will begin from the top of the song that was in progress when playback was stopped.

● Minus One Playback

This function lets you mute (turn off) various parts of a Quick Play song so you can play them yourself on the keyboard while the others are played automatically.

1 Select the Part to Mute



Press the [MINUS ONE SELECT] button — the currently selected part will appear on the LCD display panel. Use the [+] and [–] buttons, the number buttons, the data dial, or the [MINUS ONE SELECT] button itself to specify the part you want to mute:

- 0: L+R mutes the left- and right-hand parts.
- 1: R mutes the right-hand part.
- 2: L mutes the left-hand part.



- In the case of Disk Orchestra Collection or PianoSoft disks, the left and right-hand parts will be set automatically. With other files the MIDI transmit channels corresponding to “R” and “L” will be selected.

2 Engage the Minus One Mode

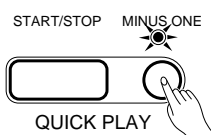

Press the [MINUS ONE] button so that its indicator lights to actually mute the selected part. The Minus One mode can be engaged either before or during Quick Play playback.

Press the [MINUS ONE] button again so that its indicator goes out to exit from the Minus One mode.



- The Metronome function cannot be used during Quick Play.

PSR-2700 Digital Sampling

The PSR-2700 features a built-in digital voice sampling system that lets you digitally record any sounds from a microphone or line-level source and play those sounds via the four SAMPLE PADS and/or the keyboard. The Digital Sampling system can record a maximum of 6 seconds of sound per sample pad, up to a total of 60 seconds. A sampled "voice" is a complete set of data for the four SAMPLE PADS.



• *Never interrupt the PSR-2700 power supply - either by unplugging the power cord or by turning the power switch off - during sampling, during a clear operation, while the PSR-2700 is processing sampled data (i.e. while "Squeezing" appears on the display), or while loading sampled voices from disk. Doing so will result in the loss of all data in the PSR-2700 wave RAM!*

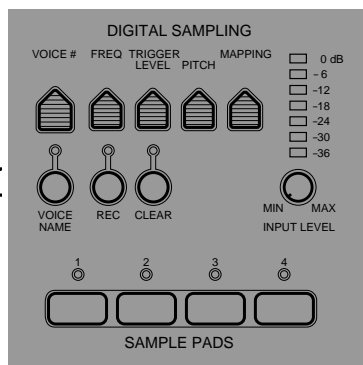
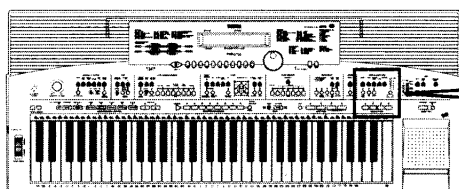

Connections

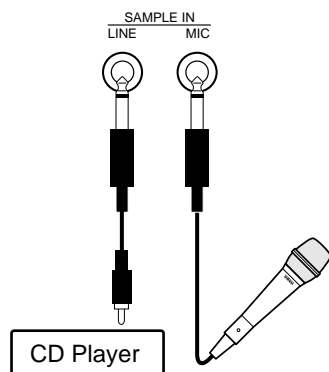

To use the Digital Sampler you'll need to connect the source you intend to use to either the rear-panel **SAMPLE IN LINE** or **MIC** jack. If you'll be recording via a microphone, plug the microphone into the **SAMPLE IN MIC** jack. If you'll be recording from a line-level source such as a cassette player or other audio playback device, plug the player's line output into the **SAMPLE IN LINE** jack. If your audio playback device has RCA pin-jack type outputs you'll need to acquire a cable or connector converter that allows connection to the PSR-2700's 1/4-inch mono phone jack.



• *Be sure to obtain proper permission when sampling copyrighted material.*

Setting the Input Level

For optimum sound quality you'll need to match the input sensitivity on the PSR-2700 Digital Sampling system to the output level of your source. After connecting and preparing your source:

1 Engage the Level Check Mode



Press the DIGITAL SAMPLING section **[REC]** button. "LEVEL CHECK MODE" will appear on the display and the **[REC]** indicator will flash.

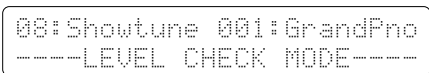

PSR-2700 Digital Sampling

2 Play the Source and Adjust the Level

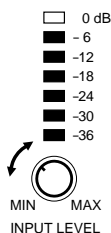

Play the sound you intend to record, via microphone or line, and adjust the **INPUT LEVEL** control while watching the level indicators above the control. The length of the “bar” formed by the level indicators increases as input level increases. For optimum sound quality, your input signal should cause most of the indicators to light, but not all. If all indicators including the red “0 dB” indicator light in response to the input signal you’re probably overloading the input circuitry and will end up with distorted sound. At the other extreme, if none of the indicators light, or only the lowest one or two indicators light, then the input signal is too small and the level of the recorded sound will be too low.



NOTES

• The keyboard and other function buttons will not operate in the level check mode.

3 Exit



Once the input level has been set properly, press the **DIGITAL SAMPLING [REC]** button to exit from the level check mode.

Setting the Sampling Frequency

The length of the sample you can record and its sound quality are determined by the “sampling frequency”. A high sampling frequency produce better sound quality but shorter samples; a low sampling frequency allow longer recording but with reduced sound quality. The PSR-2700 gives you two sampling frequency settings:

Setting	Length	Sound Quality
1: LOW	6 sec. (approx.)	Low
2: HIGH	3 sec. (approx.)	High

1 Press the [FREQ] Button

FREQ



Press the **DIGITAL SAMPLING** section **[FREQ]** button. The current sampling frequency setting will appear on the LCD display panel.

```
08: Showtune 001: GrandPno
AccOff Frequency=1:LOW
```

2 Select a Frequency Setting



Use the **[+]** and **[-]** buttons, the number buttons, the data dial, or the **[FREQ]** button itself to select the desired sampling frequency setting (“LOW” or “HIGH”).



NOTES

• The “LOW” setting is automatically selected when the PSR-2700 power is initially turned on.

■ Setting the Trigger Level

There are two ways to start sample recording: manual and triggered. With manual recording recording starts the moment you press the [REC] and pad buttons, as described in the “Recording” section, below. With triggered recording you initially engage the record standby mode and recording actually begins as soon as the PSR-2700 detects an input signal that is higher than the selected trigger level. The [TRIGGER LEVEL] button lets you select the method you want to use, and provides 5 different trigger levels. The trigger level you choose will depend on the type of signal you want to record and the level of the background noise where you record. The idea is to set the highest trigger level that will start recording without cutting off the attack of the sound you are recording. If the trigger level is too low, recording can be triggered by ambient background noise at the wrong time.

1 Press the [TRIGGER LEVEL] Button

TRIGGER
LEVEL



Press the DIGITAL SAMPLING section [TRIGGER LEVEL] button. The current trigger level setting will appear on the LCD display panel.

```
08:Shoutune 001:GrandPno  
AccOff Trig.Level=3
```

2 Select a Trigger Level



Use the [+] and [-] buttons, the number buttons, the data dial, or the [TRIGGER LEVEL] button itself to select the desired trigger level setting (“OFF” or “1” through “5”).

When the trigger level is set to “OFF”, manual recording is selected and recording will start immediately when the [REC] and pad buttons are pressed (see the “Recording” section, below). Automatic triggering is selected when a value from 1 to 5 is selected. “1” produces the lowest triggering level, triggering recording when even a very soft sound is detected at the input. Increasing values produce progressively higher trigger levels. Try a trigger level of 2 or 3 to begin with. The default setting of “3” can be instantly selected by pressing the [+] and [-] buttons simultaneously.

NOTES

- Proper trigger operation depends on proper input level adjustment. Make sure you set the input level properly as described on page 63.
- The trigger level is set to “3” when the PSR-2700 power is initially turned on.

PSR-2700 Digital Sampling

Recording

Each sampled “voice” recorded by the PSR-2700 can contain four separate samples, one in each SAMPLE PAD. You can play the individual samples included in the selected sample voice by playing the appropriate pad, or by playing on the keyboard when the VOICE section SAMPLED VOICE indicator is lit. When you play a sampled voice via the keyboard, the four separate samples it contains are assigned to different ranges of the keyboard. This will be explained in more detail in the “Playing Samples via the Keyboard” section on page 70.

Your sampled voices will be retained in the PSR-2700 sample memory even when the power is turned off as long as the backup batteries are installed on the AC plug is connected. Your samples can also be saved to and loaded from disk so you can create and original sample library.

NOTES

- Although a maximum of 255 individual samples can be recorded, the samples have to be extremely short — a fraction of a second each — to achieve this number. During normal sample recording the sample memory is likely to become full long before the maximum of 255 samples is reached. The maximum total recording time — 60 seconds — is a more reliable guide as to how much of the sample memory has been used or is available.

1 Select a Sample Voice Number

VOICE #



```
08:Showtune 001:GrandPno  
AccOff SUC=001:*****
```

Press the DIGITAL SAMPLING section [VOICE #] button. The current selected sample voice number will appear on the LCD display panel. Use the [+] and [-] buttons, the number buttons, the data dial, or the [VOICE #] button itself to select the desired sample voice number. If the selected voice number contains no data, “*****” will appear on the display in place of the voice name.

2 Record

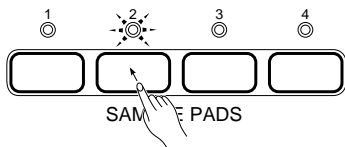

```
SUC=001 Frq=LOW Trg=3  
>>>> Sampling !!!!! <<<<
```

NOTES

Press the **SAMPLE PAD** to which you want to record while holding the DIGITAL SAMPLING section [REC] button. “Sampling Ready” will appear on the display. Recording will begin immediately if you set the trigger level to “OFF” (see “Setting the Trigger Level, above). If you selected automatic triggering, the [REC] button and selected SAMPLE PAD will flash until recording is triggered by an input signal. When recording starts, whether manual or triggered, the [REC] button indicator will light continuously and “Sampling” will appear on the display.

- The keyboard and other function buttons will not operate during sample recording.
- If the “No Bank” or “Wave Ram Full” error message appears, there is not enough memory available for sampling and some data will have to be cleared before sampling will be possible (See “Error Messages” on page 81).

3 Stop Recording

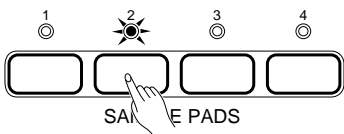

NOTES

Press the **SAMPLE PAD** to which you are recording to stop recording. Both the [REC] button and SAMPLE PAD indicators will go out.

- Try to stop record immediately after the sound has finished in order to conserve sample memory and allow maximum total recording time.
- If the maximum sampling time is exceeded, “Sampling End” will appear on the display and recording will stop automatically.
- In some cases “SQUEEZING XXX%” will appear on the display while the PSR-2700 processes the sampled data after recording. “XXXKByteFree” will then appear, indicating the amount of RAM remaining after the data has been processed.

4 Repeat as Necessary

Repeat the above procedure to record the remaining SAMPLE PADS, as required.



- The PSR-2700 has 1,020 kilobytes (1.02 megabytes) of waveform RAM memory for sampled voice storage. To find out how much of this memory is available for recording press the [CLEAR] button: “XXXX KByteFree” will appear on the display (“XXXX” indicates the remaining RAM in kilobytes).
- The sample data is retained in memory even when the power switch is turned off as long as the backup batteries are installed or the AC plug is connected.

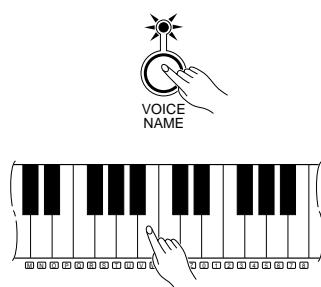

```
08: Showtune 001: GrandPno
AccOff SVC=001: Hello!
```

● Enter an Original Voice Name

The PSR-2700 automatically creates a voice name for each sampled voice. If you want to enter a more descriptive name for easier identification (and this is recommended), this can be done via the keyboard after pressing the DIGITAL SAMPLING section [VOICE NAME] button so that its indicator lights. A voice name can consist of up to eight characters. Each key on the keyboard enters a different character, listed immediately below the key. The lowest key (C1) functions as a shift key that shifts between lower- and upper-case characters: hold the **SHIFT** key while pressing a character key to enter the upper-case character. Each time a character is entered the cursor moves to the next character position. The **F5** and **F#5** keys move the cursor backward and forward within the voice name. Use these keys to place the cursor where you want to enter or change a character. The **DELETE** key (G5) deletes the character at the cursor position. Press the **ENTER** key (C6) when you’ve finished entering the voice name — this returns you to the voice number display (your voice name will not be entered if you don’t press the **ENTER** key).



- Playing the keyboard will produce no sound during voice name entry.
- No name can be entered for a voice that contains no data.

■ Playing the Sample Pads

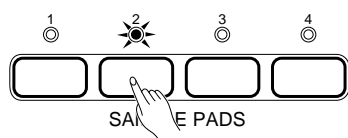

VOICE #



The recorded samples can be played simply by pressing the appropriate **SAMPLE PAD**. The sample sounds only as long as the pad is held, so you play only a section of a sample by releasing the pad early, or rapidly retrigger the first section of the sample by repeatedly pressing the pad. The pads can also be played at the same time so you can play all four samples simultaneously, as required.

To select a different sample voice for playback via the pads, then press the DIGITAL SAMPLING section [VOICE #] button and use the [+] and [-] buttons, the number buttons, the data dial, or the [VOICE #] button itself to select the desired sample voice number.



- Different voices can be selected for playback via the pads and keyboard (see page 70), and these can be played simultaneously via the pads and keyboard.
- To use sample pad data from disk, load the data into the PSR-2700 as described on page 60.

PSR-2700 Digital Sampling

■ Editing Samples

The following functions provide a range of useful sample editing capabilities.



- If the sample data cannot be edited the following messages will appear on the LCD display: “No Wave Data” if there is no data in the pad; “Protected Voice” if the data is protected and cannot be edited by the PSR-2700.

● Clearing Samples

The contents of an entire sampled voice (four pads) or individual SAMPLE PADS can be completely cleared (erased) as follows:

1 Hold [CLEAR] and Select the Voice Or a Pad

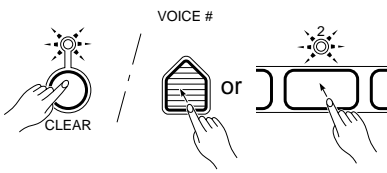

While holding the [CLEAR] button press the [VOICE #] button if you want to clear the entire voice, or the **SAMPLE PAD** you want to clear if you only want to clear one pad. The [CLEAR] button, pad indicator if a pad was selected, and ARE YOU SURE? indicators will flash and the “Are you sure?” prompt will also sound.

2 Clear the Voice or Pad

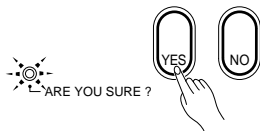

Press the [YES] button to clear the current sample voice or selected pad, or the [NO] button to cancel the clear operation.

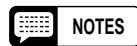

- In some cases “SQUEEZING XXX%” will appear on the display while the PSR-2700 processes the sampled data during the clear process. “XXXXKByteFree” will then appear, indicating the amount of RAM remaining after the data has been processed.
- When a sample pad is cleared, the mapping applied to that pad is also cleared and the default mapping will be restored.

● Tuning the Samples

The pitch of each SAMPLE PAD can be adjusted over approximately a ± 50 -cent range (100 cents total — approximately one semitone). This is a convenient way to tune samples to match the music in which they will be used.

1 Hold [PITCH] and Select a Pad

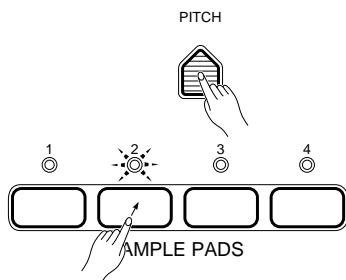

While holding the [PITCH] button press the **SAMPLE PAD** containing the sample you want to tune. The selected SAMPLE PAD indicator will flash and its current pitch value will appear on the LCD display.

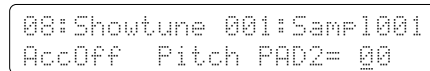

If you press only the [PITCH] button SAMPLE PAD 1 will automatically be selected.

2 Select the Pitch



Use the [+] and [-] buttons, the number buttons, or the data dial to set the pitch as required. The pitch range is from “-10” through “0” to “+10”. A setting of “0” produces normal pitch. Each increment raises (+) or lowers (-) the pitch by approximately 5 cents. You can play the pads while tuning to check the sound.

The normal tuning value can be recalled instantly by pressing the [+] and [-] buttons at the same time.

3 Exit

Press the [PITCH] button or any other function button — the [VOICE#] button, for example — to exit from the pitch function.

● Volume, DSP Depth, & Pan Settings

The VOICE section [VOL], [DSP DEPTH], and [PAN] buttons can be used to set the overall volume, DSP depth, and pan position of all four SAMPLE PADS.

1 Hold [EDIT] and Press [VOICE #]

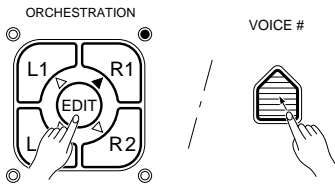

While holding the ORCHESTRATION [EDIT] button press the DIGITAL SAMPLING section [VOICE #] button. All four SAMPLE PAD indicators will flash and the volume parameter will appear on the LCD display panel.

```
08: Showtune 001: SamP1001
AccOff Volume=21
```

2 Select & Set the Parameters

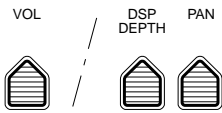

Use the [VOL], [DSP DEPTH], and [PAN] buttons to select the parameter you want to adjust, then use the [+] and [-] buttons, the number buttons, the data dial, or the selected function button itself to set the parameter as required (see page 14 for details on the volume parameter, page 15 for the DSP depth, and page 15 for pan).

3 Exit

Press any other function button to exit from the parameter adjustment mode.

◆ Individual SAMPLE PAD Volume Settings

It is also possible to individually adjust the volume of each pad as follows:

1 Hold [EDIT] and Select a Pad

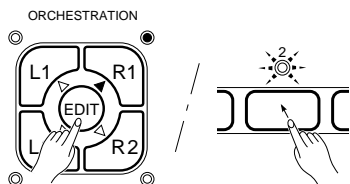

While holding the ORCHESTRATION [EDIT] button press the SAMPLE PAD containing the sample you want to adjust. The selected SAMPLE PAD indicator will flash and its current volume value will appear on the LCD display panel.

```
08: Showtune 001: SamP1001
AccOff Volume=21
```

2 Set the Volume



Use the [+] and [-] buttons, the number buttons, or the data dial to set the volume as required (“0” for no sound through “24” for maximum volume).

3 Exit

Press any other function button to exit from the individual pad volume adjustment mode.



• The individual volume setting also apply when the sampled voices are played via the keyboard.

PSR-2700 Digital Sampling

■ Playing Samples via the Keyboard

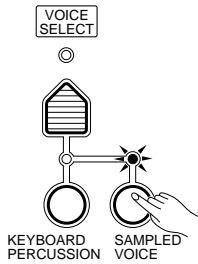

To play your samples via the PSR-2700 keyboard, press the VOICE section [SAMPLED VOICE] button so that its indicator lights. If all four SAMPLE PADS have been recorded for the currently selected sampled voice, the individual samples will initially be assigned to the keyboard as follows:

PAD	Key	Range
PAD 1	C2	C1 ... F#2
PAD 2	C3	G2 ... F#3
PAD 3	C4	G3 ... F#4
PAD 4	C5	G4 ... C6

Initial mapping

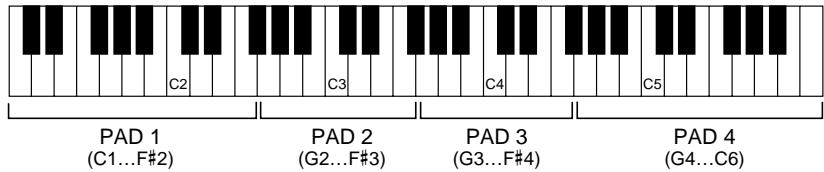

In the above chart “Key” is the key on the keyboard to which the original pitch of the recorded sample is assigned. For example, pressing the C2 key will produce exactly the same sound as pressing PAD 1. Other keys within the specified range play the sample at appropriately higher or lower pitches. If only one sample is recorded, the sample will play across the entire range of the keyboard. If two or three samples are recorded they will be assigned to the same keys but the ranges will be adjusted to suit the number of samples. The sample key assignments can be changed by using the “Mapping” function, described below.



To select a different sample voice for playback via the keyboard, make sure the VOICE section [SAMPLED VOICE] indicator is on, then use the [+] and [-] buttons, the number buttons, the data dial, or the [VOICE SELECT] button to select the desired sample voice number.

Press the [SAMPLED VOICE] button so that its indicator goes out when you want to return to the normal voice mode.



- The sampled voices have 26-note polyphony *in addition to* the 28 notes available for the normal voices.
- The sampled voices can be assigned to any of the ORCHESTRATION parts.

● Mapping

This function allows the original pitch of the sampled sound to be “mapped” to any key on the keyboard, thus changing the key assignments and keyboard ranges described above.

1 Hold [MAPPING] and Select a Pad

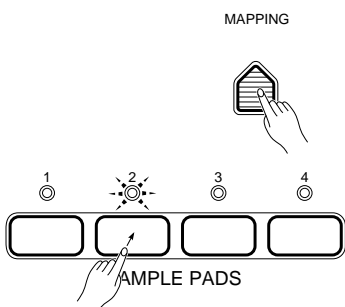

While holding the [MAPPING] button press the SAMPLE PAD containing the sample you want to re-map to the keyboard. The selected SAMPLE PAD indicator will flash and the note number to which it is currently assigned will appear on the display.

```
08:Shoutune 001:SamF1001
AccOff Mapping PAD2=060
```

If you press only the [MAPPING] button SAMPLE PAD 1 will automatically be selected.

2 Select a New Key

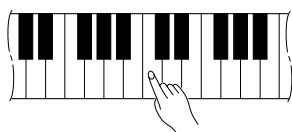

Press the key to which the original voice of the sample is to be mapped. The note number of the selected key will appear on the LCD display panel. The key can also be selected by using the [+] and [-] buttons, the number buttons, or the data dial to select the appropriate note number on the display (the note numbers, 36 through 96, are listed above the keys). You can play the pad while mapping to confirm the sound.

3 Exit

MAPPING



Press the [MAPPING] button or any other function button — the [VOICE SELECT] button, for example — to exit from the mapping function.



- Normally the key to which a sample is mapped will become approximately the center of its range. The actual range will depend on how many of the four samples are recorded and to which keys they are mapped.
- The default mapping assignments are restored for pads which are cleared as described in “Clearing Samples”: PAD 1 to C2, PAD 2 to C3, PAD 3 to C4, and PAD 4 to C5.
- If you press several keys simultaneously while mapping the last key pressed take priority.
- Mapping assignments are retained even if new samples are recorded.
- Mapping is not possible for: pads that contain no data (“No Wave Data” error); a key that is already mapped (“Same Note” error).

Sample Memory Backup & Disk Storage

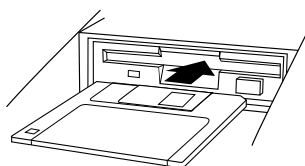

The PSR-2700 is backed up by the backup batteries and will remain intact as long as a good set of batteries is installed. Even if no batteries are installed the memory will be maintained as long as the power plug is connected to an AC outlet. It is always a good idea, however, to save samples you want to keep to floppy disk. You can save either single voices or the entire contents of the sample memory to disk as required. Full instructions on floppy disk use are given in the “Floppy Disk” section beginning on page 56.

Pedal Assign

Optional Yamaha FC4 or FC5 footswitches and/or or FC7 foot controllers can be plugged into either or both of the rear-panel PEDAL jacks and used to control a wide range of functions.

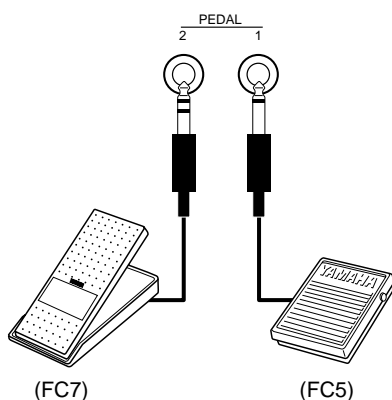
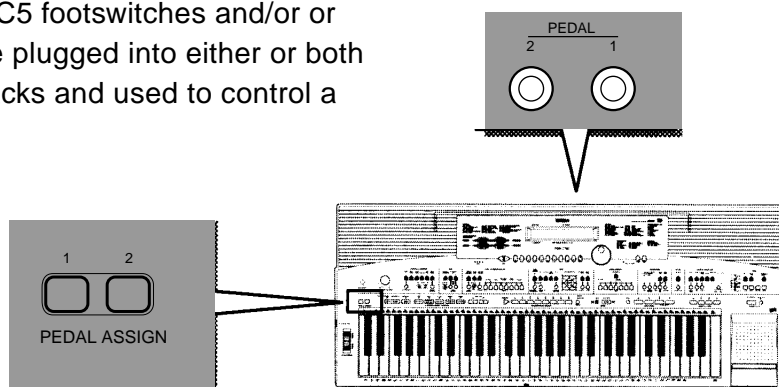

The functions listed below can be assigned to the footswitch or foot controller connected to the **PEDAL 1** and **PEDAL 2** jacks by pressing the appropriate function button while holding the PEDAL ASSIGN [1] or [2] button.

Assignable Footswitch Functions (FC4, FC5)

- | | | |
|----------------------|------------------------------------|------------------|
| • AUTO ACCOMP ON/OFF | • BREAK | • HARMONY ON/OFF |
| • FADE IN/OUT | • ENDING | • SONG RESET |
| • INTRO | • ACCOMPANIMENT CONTROL START/STOP | • SONG PLAY/STOP |
| • VARIATION [A] | • SYNC-START ON/OFF | • GATE TIME |
| • VARIATION [B] | • CHORD 2 FINGERING | • STEP SIZE |
| • FILL IN 1 | • EFFECT ON/OFF | |
| • FILL IN 2 | | |

Assignable Foot Controller Function (FC7)

VOICE	• VOLUME (24 steps)	• DSP DEPTH (15 steps)	• PAN (14 steps)
ACCOMP	• VOLUME (24 steps)		

Example: Assigning AUTO ACCOMP on/off switching to the pedal.

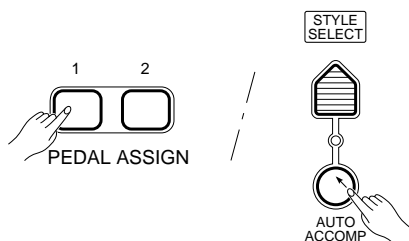

NOTES

- Using the foot controller while an Assignable Foot Controller Function is assigned has the same effect as holding the corresponding panel button.
- The PEDAL 1 jack is initially assigned to sustain control. A footswitch connected to this jack functions as a damper pedal, controlling sustain. Press the pedal to sustain notes after the keys are released.
- The PEDAL 2 jack is initially assigned to the voice volume control (MIDI Expression control). An FC7 foot controller connected to this jack can be used to control voice volume: press the pedal forward to increase voice volume; backward to decrease voice volume.
- A footswitch or foot controller can be returned to its default function by pressing it while holding the corresponding PEDAL ASSIGN button.
- The ON/OFF operation of a footswitch or the control direction of a foot controller can be reversed by double-clicking the corresponding PEDAL ASSIGN button (press the button twice rapidly) without pressing the pedal.
- If the GATE TIME or STEP size parameter is assigned to PEDAL 1, the parameter will be decremented each time the pedal is pressed. If assigned to PEDAL 2, the parameter will be incremented each time the pedal is pressed.
- For CHORD 2 mode control press the [FINGERING] button while holding the appropriate PEDAL ASSIGN button. Then the footswitch can be pressed while the Auto Accompaniment is playing to switch to the CHORD 2 mode. The CHORD 2 mode remains active only as long as the footswitch is pressed.
- The pedal assignment can be stored in the Registration Memory.

MIDI, the Musical Instrument Digital Interface, is a world-standard communication interface that allows MIDI-compatible musical instruments and equipment to share musical information and control one another. This makes it possible to create “systems” of MIDI instruments and equipment that offer far greater versatility and control than is available with isolated instruments.

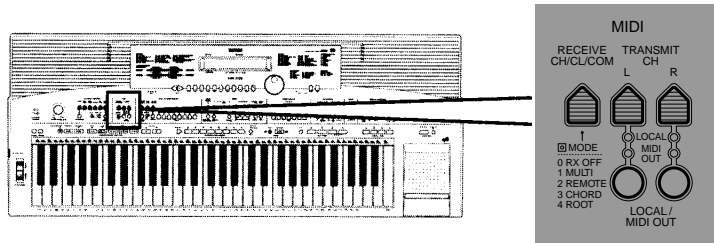

● The MIDI Connectors

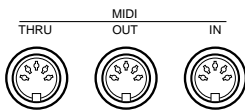

The **MIDI IN** connector receives MIDI data from an external MIDI device which can be used to control the PSR-1700 or PSR-2700. The **MIDI THRU** connector re-transmits data received at the MIDI IN connector, allowing “chaining” of several MIDI devices. The **MIDI OUT** connector transmits MIDI data generated by the PSR-1700 or PSR-2700 (e.g. note and velocity data produced by playing the keyboard).

● Simple MIDI Control

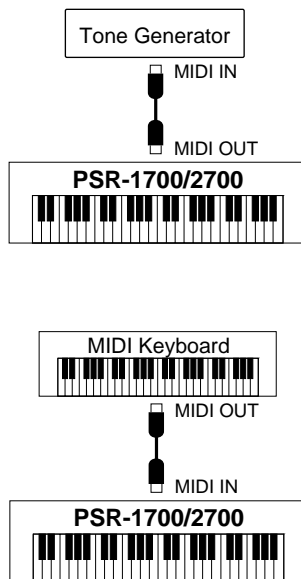

Most MIDI keyboards transmit note and velocity (touch response) information via the MIDI OUT connector whenever a note is played on the keyboard. If the MIDI OUT connector is connected to the MIDI IN connector of a second keyboard (synthesizer, etc.) or a tone generator (essentially a synthesizer with no keyboard), the second keyboard or tone generator will respond precisely to notes played on the original transmitting keyboard. The result is that you can effectively play two instruments at once, providing thick multi-instrument sounds. The PSR-1700 and PSR-2700 also transmit “program change” data when one of its voices is selected. Depending on how the receiving device is set up, the corresponding voice will be automatically selected on the receiving keyboard or tone generator whenever a voice is selected on the PSR-1700 or PSR-2700.

The PSR-1700 and PSR-2700 are capable of receiving the same MIDI data, so a second MIDI keyboard connected to the PSR-1700 or PSR-2700 MIDI IN connector can be used to remotely play the instrument and select voices as required.

● MIDI Sequence Recording

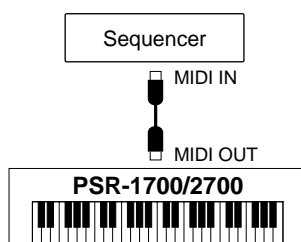

Although the PSR-1700 and PSR-2700 feature a built-in “sequencer” (the Song Memory is a type of sequencer), the same type of musical information transfer described above can be used for more sophisticated MIDI sequence recording using an external sequencer or music computer. A MIDI sequence recorder or music computer can be used to “record” MIDI data received from a PSR-1700 or PSR-2700, for example. When the recorded data is played back, the PSR-1700 or PSR-2700 automatically “plays” the recorded performance in precise detail.



• Never use MIDI cables longer than about 15 meters, since cables longer than this can pick up noise which can cause data errors.

MIDI Reception Modes

The [RECEIVE CH/CL/COM] button is used to specify the reception mode for each of the 16 MIDI channels, the internal or external clock mode, and MIDI start/stop command reception mode.

Channel Reception Modes

The PSR-1700 and PSR-2700 allow any of five reception modes to be individually assigned to MIDI channels 1 through 16. The five modes are:

Mode “0” RX OFF: Reception disabled.

Mode “1” MULTI: Received MIDI note data directly controls the PSR-1700/PSR-2700 tone generator. Different voices can be played on different channels.

Mode “2” REMOTE: Received MIDI note data is handled in the same way as data from the PSR-1700/PSR-2700’s own keyboard.

Mode “3” CHORD: Received MIDI note data is interpreted as Auto Accompaniment chord commands.

Mode “4” ROOT: Received MIDI note data is interpreted as Auto Accompaniment bass note commands .



• If the PSR-1700/2700 receives more than one note at the same time while mode “4” (Root) is selected, the last note will be interpreted as the Auto Accompaniment bass note.

1 Press the [RECEIVE CH/CL/COM] Button & Select a Channel



Press the [RECEIVE CH/CL/COM] button, then use the [+] and [-] buttons, the number buttons, the data dial, or the [RECEIVE CH/CL/COM] button itself to select the MIDI channel (1 ... 16) for which you want to specify a new reception mode. The channel number appears on the right of the LCD display panel.

PSR-1700

RxCh@1=1:Multi

PSR-2700

@8:Showtune @01:GrandPho
AccOff RxCh@1=1:Multi



• “Clock Rx” and “Cmnd Rx” will appear on the display if you increment above channel number 16 or below channel number 1. These selections are used for the Clock Mode and Start/Stop Mode functions described below.

• Be sure to set the transmit channel to the same channel specified in mode 2, 3, or 4.

2 Select the Desired Mode

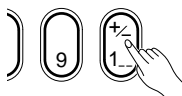

Use the [+/-] button in the number-button row to select the desired reception mode for the selected channel. The modes are selected in sequence each time the [+/-] button is pressed, and the mode number appears on the LCD display panel.



• The currently selected reception mode is retained in memory even when the power switch is turned off, as long as backup batteries are installed or an AC plug is connected.

■ Clock Mode

Reception of an external MIDI clock signal can be enabled or disabled as required. When disabled, all of the time-based functions (Auto Accompaniment, SONG MEMORY, etc.) are controlled by the PSR-1700/PSR-2700's own internal clock, the speed of which is set by the [TEMPO] button. When MIDI clock reception is enabled, however, all timing is controlled by an external MIDI clock signal received via the MIDI IN terminal (the [TEMPO] setting has no effect).



- If clock reception is enabled but no MIDI clock signal is received for more than 400 milliseconds, external clock reception is automatically disabled and normal internal clock operation resumes.
- If you attempt to change the tempo setting when MIDI clock reception is enabled, "Tempo ♩=External" will appear on the LCD display panel.

1 Press the [RECEIVE CH/CL/COM] Button & Select "Clock Rx"



Press the [RECEIVE CH/CL/COM] button, then use the [+] and [-] buttons, the number buttons, the data dial, or the [RECEIVE CH/CL/COM] button itself to select "Clock Rx" on the LCD display panel ("Clock Rx" is the next step above MIDI channel 16).

2 Select the Desired Mode

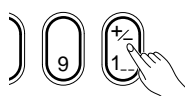

Use the [+/−] button in the number-button row to select the desired clock mode. The disable and enable modes are selected alternately each time the [+/−] button is pressed, and the selected mode appears on the right digit of the LCD display panel ("Clock Rx=0:Off" for disable; "Clock Rx=1:On" for enable).

■ Start/Stop Mode

This function determines the effect of external MIDI start and stop signals. There are three start/stop modes, as follows:

- Mode "0"** Start/stop reception disabled.
- Mode "1"** MIDI start and stop commands start and stop the PSR-1700/PSR-2700 Auto Accompaniment feature.
- Mode "2"** MIDI start and stop commands start and stop the PSR-1700/PSR-2700 SONG MEMORY feature.

1 Press the [RECEIVE CH/CL/COM] Button & Select "Cmnd Rx"



Press the [RECEIVE CH/CL/COM] button, then use the [+] and [-] buttons, the number buttons, the data dial, or the [RECEIVE CH/CL/COM] button itself to select "Cmnd Rx" on the LCD display panel ("Cmnd Rx" is the next step above "Clock Rx" — or the next step below MIDI channel 1).

2 Select the Desired Mode

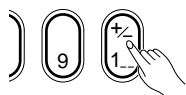

Use the [+/−] button in the number-button row to select the desired start mode. The start/stop modes are selected in sequence each time the [+/−] button is pressed: "Cmnd Rx=0:Off", "Cmnd Rx=1:Accomp", or "Cmnd Rx=2:Song".

MIDI Transmission

The PSR-1700/PSR-2700 allows independent MIDI transmit channels to be assigned to the L and R ORCHESTRATION voices. It is also possible to independently turn local control and MIDI output on or off for the L and R voices.

MIDI Transmit Channels

The L and R ORCHESTRATION voices can be independently set to transmit on any of the 16 MIDI channels as follows:

1 Press the [L] or [R] TRANSMIT CH

Press the [L] button if you want to set the L voice transmit channel, or the [R] to set the R voice transmit channel. The currently selected channel for the selected voice will appear on the LCD display panel.

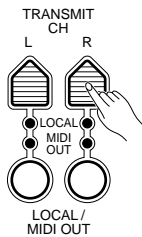

PSR-1700



PSR-2700

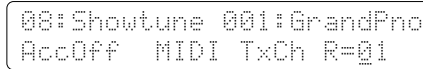

NOTES

- After selecting L or R, as described above, the default transmit channel can be recalled by simultaneously pressing the [+] and [-] buttons. The default "L" channel number is "2", and the default "R" channel is "1".

2 Select the Desired Transmit Channel

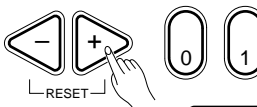

NOTES

Use the [+] and [-] buttons, the number buttons, the data dial, or the [L] or [R] button itself to select the desired transmit channel.

- The currently selected transmit channel is retained in memory even when the power switch is turned off, as long as backup batteries are installed or an AC plug is connected.
- To record the Song Memory data to an external sequencer, start the sequencer running in the record mode, press the [RESET] button, and then press the [PLAY/STOP] button.
- To record the Auto Accompaniment data to an external sequencer, start the sequencer running in the record mode, select the style you want to record, then start Auto Accompaniment playback.
- Notes played on the keyboard are transmitted on channel 1 or 2 (selectable), Auto Accompaniment data is transmitted on channels 10 through 16, and Song Memory data is transmitted on channels 3 through 8. Normally the Auto Accompaniment Rhythm 1 and Rhythm 2 tracks are both transmitted on channel 10. To transmit these tracks separately, hold the C1 key while turning the power on. When this is done the Rhythm 1 data will be transmitted on channel 9 and the Rhythm 2 data will be transmitted on channel 10.

Local & MIDI Output ON/OFF

The [LOCAL/MIDI OUT] buttons and indicators below the TRANSMIT CH [L] and [R] buttons can be used to turn local control and MIDI output ON or OFF as required. The status of the LOCAL and MIDI OUT indicators changes as shown below each time the corresponding [LOCAL/MIDI OUT] button is pressed:

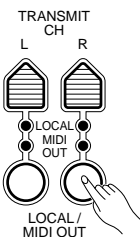

NOTES

- When "LOCAL" control is turned ON (indicator lit), the PSR-1700/PSR-2700 is controlled by its own keyboard. When "LOCAL" control is off, playing the keyboard produces no sound — it can only be played by MIDI data received via the MIDI IN terminal.
- When MIDI OUT is turned ON (indicator lit), operating the PSR-1700/PSR-2700 produces corresponding MIDI output. When MIDI OUT is turned OFF (indicator out) no MIDI output is produced by the PSR-1700/PSR-2700.
- LOCAL & MIDI OUT ON/OFF controls note on/off only. All other data is always output automatically.
- Since LOCAL & MIDI OUT ON/OFF status is memorized in the Registration Memory, you can select the tone generator to be used (PSR-1700/PSR-2700 or an external tone generator) by changing the registration memory.
- Auto accompaniment will not function when Left LOCAL OFF is selected. Auto accompaniment note on/off data will not be output when Left MIDI OUT OFF is selected.

Appendix

Voice & Polyphony List

The PSR-1700 and PSR-2700 can play up to 28 individual notes at the same time (i.e. it has a maximum “polyphony” of 28). This number includes all voices used: dual, split, auto accompaniment, song memory, and multi pads. If the maximum polyphony is exceeded excess notes will be truncated (they will not sound).

Another feature affecting polyphony is the fact that some voices actually use two voices at once, as shown in the voice list below. The effective maximum polyphony is correspondingly reduced when these voices are used.



- The voice list includes the MIDI program numbers that control each voice when the PSR-1700/PSR-2700 is played from an external MIDI device.
- An additional 26 notes are available in the PSR-2700 when a sampled voice is used. These notes are only available for the sampled voice.

Voice Number	MIDI Program Number	Voice Name	Number of Voices Used	Voice Number	MIDI Program Number	Voice Name	Number of Voices Used	Voice Number	MIDI Program Number	Voice Name	Number of Voices Used
Piano				45	44	Tremolo Strings	2	Synth Pad			
01	0	Acoustic Grand Piano	1	46	45	Pizzicato Strings	2	89	88	Pad 1 (new age)	2
02	1	Bright Acoustic Piano	1	47	46	Orchestral Harp	1	90	89	Pad 2 (warm)	2
03	2	Electric Grand Piano	2	48	47	Timpani	1	91	90	Pad 3 (polysynth)	2
04	3	Honky-tonk Piano	2	Ensemble				92	91	Pad 4 (choir)	2
05	4	Electric Piano 1	2	49	48	Strings Ensemble 1	1	93	92	Pad 5 (bowed)	2
06	5	Electric Piano 2	2	50	49	Strings Ensemble 2	1	94	93	Pad 6 (metallic)	2
07	6	Harpsichord	1	51	50	Synth Strings 1	2	95	94	Pad 7 (halo)	2
08	7	Clavi	1	52	51	Synth Strings 2	2	96	95	Pad 8 (sweep)	2
Chromatic Percussion				53	52	Choir Aahs	2	Synth Effects			
09	8	Celesta	1	54	53	Voice Oohs	1	97	96	FX 1 (rain)	2
10	9	Glockenspiel	1	55	54	Synth Voice	1	98	97	FX 2 (soundtrack)	2
11	10	Music Box	2	56	55	Orchestra Hit	1	99	98	FX 3 (crystal)	2
12	11	Vibraphone	1	Brass				100	99	FX 4 (atmosphere)	2
13	12	Marimba	1	57	56	Trumpet	1	101	100	FX 5 (brightness)	2
14	13	Xylophone	1	58	57	Trombone	1	102	101	FX 6 (goblins)	2
15	14	Tubular Bells	1	59	58	Tuba	1	103	102	FX 7 (echoes)	2
16	15	Dulcimer	2	60	59	Muted Trumpet	1	104	103	FX 8 (sci-fi)	2
Organ				61	60	French Horn	1	Ethnic			
17	16	Drawbar Organ	2	62	61	Brass Section	1	105	104	Sitar	1
18	17	Percussive Organ	2	63	62	Synth Brass 1	2	106	105	Banjo	1
19	18	Rock Organ	2	64	63	Synth Brass 2	2	107	106	Shamisen	1
20	19	Church Organ	2	Reed				108	107	Koto	1
21	20	Reed Organ	1	65	64	Soprano Sax	1	109	108	Kalimba	1
22	21	Accordion	2	66	65	Alto Sax	1	110	109	Bagpipe	2
23	22	Harmonica	1	67	66	Tenor Sax	1	111	110	Fiddle	1
24	23	Tango Accordion	2	68	67	Baritone Sax	1	112	111	Shanai	1
Guitar				69	68	Oboe	1	Percussive			
25	24	Acoustic Guitar (nylon)	1	70	69	English Horn	1	113	112	Tinkle Bell	2
26	25	Acoustic Guitar (steel)	1	71	70	Bassoon	1	114	113	Agogo	1
27	26	Electric Guitar (jazz)	1	72	71	Clarinet	1	115	114	Steel Drums	2
28	27	Electric Guitar (clean)	2	Pipe				116	115	Woodblock	1
29	28	Electric Guitar (muted)	1	73	72	Piccolo	1	117	116	Taiko Drum	1
30	29	Overdriven Guitar	1	74	73	Flute	1	118	117	Melodic Tom	1
31	30	Distortion Guitar	1	75	74	Recorder	1	119	118	Synth Drum	1
32	31	Guitar Harmonics	1	76	75	Pan Flute	1	120	119	Reverse Cymbal	1
Bass				77	76	Blown Bottle	2	Sound Effects			
33	32	Acoustic Bass	1	78	77	Shakuhachi	1	121	120	Guitar Fret Noise	1
34	33	Electric Bass (finger)	1	79	78	Whistle	1	122	121	Breath Noise	1
35	34	Electric Bass (pick)	1	80	79	Ocarina	1	123	122	Seashore	2
36	35	Fretless Bass	1	Synth Lead				124	123	Bird Tweet	2
37	36	Slap Bass 1	1	81	80	Lead 1 (square)	2	125	124	Telephone Ring	1
38	37	Slap Bass 2	1	82	81	Lead 2 (sawtooth)	2	126	125	Helicopter	2
39	38	Synth Bass 1	1	83	82	Lead 3 (calliope)	2	127	126	Applause	2
40	39	Synth Bass 2	1	84	83	Lead 4 (chiff)	2	128	127	Gunshot	1
Strings				85	84	Lead 5 (charang)	2	<i>* The following voices use only one voice in the indicated ranges: 46 (Pizzicato Strings): all notes below C#2 and above F5. 110 (Bagpipe): all notes above A#2.</i>			
41	40	Violin	1	86	85	Lead 6 (voice)	2				
42	41	Viola	1	87	86	Lead 7 (fifth)	2				
43	42	Cello	1	88	87	Lead 8 (bass+Lead)	2				
44	43	Contrabass	1								

Appendix

Style List

#	Name	Rhythm	Comments
Pop			
01	16-Beat Pop	16-Beat	Contemporary 16-beat pop.
02	8-Beat Pop	8-Beat	Bright piano/guitar-based '70s pop.
03	8-Beat Light	8-Beat	Eight-beat easy-listening style with arpeggiated piano part.
04	FolkRock	16-Beat	Guitar-based folk-rock.
05	Detroit Pop	12-Beat	Motown-style rhythm, with modern touches.
06	Pop Shuffle	12-Beat	'70s European pop-shuffle.
07	Pop Rock	12-Beat	Upbeat, fast pop-rock. Try using your own chords in the Intro B and Ending B. The lead guitar part plays various phrases according to the chords chosen.
08	Showtune	8-Beat	Bouncy, fully orchestrated style from '40s/'50s musicals.
Pop Ballad			
09	16-Beat Ballad	16-Beat	Warm, romantic American soul ballad style.
10	Pop Ballad	8-Beat	Romantic pop ballad
11	Big Ballad	8-Beat	Slow ballad with full arpeggios and fancy organ fills.
12	Piano Ballad	8-Beat	Piano-based ballad with slow arpeggios. Huge drum fills in Intro and Fill In 2.
13	Epic Ballad	8-Beat	Pop ballad style from the '60s and '70s, featuring gentle strings accompaniment in MAIN A and full orchestra in MAIN B.
14	6/8 Ballad	Six-Eight	Slow rock ballad with triplet feel and classical overtones.
Dance			
15	Eurobeat	16-Beat	Fast, 16-beat Eurobeat sound, for disco and house music.
16	Dance Pop	16-Beat	80s English disco sound.
17	Casa	16-Beat	Italian house music.
18	Dance Shuffle	24-Beat	Rap/dance feel, especially for one-chord songs. Try playing with CHORD 1 & 2 off. There are two separate types for Intro B/Ending B: major and minor.
19	Groundbeat	24-Beat	Contemporary soul ballad with funky bass. PHRASE 1 adds high string lines and PHRASE 2 adds bass.
20	Synth Boogie	Six-Eight	Fast, machine-like 6/8 computer groove with synth bass.
Disco			
21	Disco Party	16-Beat	Big band disco party style, hugely popular in Europe.
22	Disco Soul	16-Beat	Philadelphia disco style from the '70s.
23	Disco Tropical	16-Beat	Disco sound with a Latin feel — echoes of American TV themes from the '80s.
24	Disco Funk	16-Beat	Late '70s New York disco style.
25	Disco Pop	16-Beat	The world-famous (and recently revived) '70s Swedish disco sound.
26	Polka Pop	8-Beat	Updated Polka style. Latin percussion in Rhythm 2.
Rhythm & Blues			
27	R&B	8-Beat	Eight-beat rhythm and blues from the '60s .
28	R&B Ballad	16-Beat	Upbeat West Coast soul ballad.
29	Fast Gospel	8-Beat	Bright and brassy '60s Chicago Rhythm & Blues style.
30	Gospel	Six-Eight	Gospel ballad groove for slow tempo songs.
31	6/8 Blues	Six-Eight	New Orleans R&B from the '50s.
32	Blues Shuffle	12-Beat	Chicago-type blues shuffle.
33	Soul	8-Beat	Simple-but-effective Memphis R&B groove.
34	Funk	16-Beat	Oakland's East Bay funk style, with fat horn section and big finale for ending.
35	Funk Shuffle	24-Beat	Funky guitar and funky brass stabs in a funky organ-driven shuffle. Funky!
Rock			
36	Hard Rock	8-Beat	Fast, hard-driving rock. P2 brings in cymbal crashes with every chord change.
37	Rock Boogie	12-Beat	Hard-driving boogie with distorted guitar.
38	Rock Pop	8-Beat	Mid-tempo guitar-based rock.
39	Rock Shuffle	12-Beat	Smooth pop-rock style. Try bringing in the instrument parts one by one.
40	6/8 Rock	Six-Eight	Slow rock pattern with triplet feel and "House of the Rising Sun"-style arpeggios.
41	Rock Ballad	8-Beat	Slow rock ballad. Use RHYTHM 2 to add crash cymbal at chord changes. Take out PHRASE 1 & 2 (guitars) for smoother sound.
42	Rock Classical	16-Beat	Classical instruments like harpsichord and strings over a pop music rhythm section.

#	Name	Rhythm	Comments
Rock & Roll			
43	Rock & Roll	12-Beat	Old-time '60s Rock&Roll.
44	Boogie Woogie	12-Beat	Late '50s piano-based rock 'n' roll, with boogie woogie bass. Brass in PHRASE 1 & 2, piano bass in PAD.
45	Twist	8-Beat	Straight-eight boogie, with a "Twist."
46	Rockabilly	12-Beat	Simple, updated version of the Memphis "Sun" sound.
47	16-beat Rock & Roll	16-Beat	Hard rock & roll — bringing the "Bo Beat" into the '90s. Bring in more complex guitar, brass comping by playing more complex chords.
Traditional Jazz			
48	Ragtime	8-Beat	Turn-of-the-century piano style. Piano fills at PHRASE 1, piano bass at PHRASE 2.
49	Dixieland	12-Beat	Old-time New Orleans jazz. Trumpet at PHRASE 1, Trombone at PHRASE 2, and Clarinets at PAD.
50	Big Band	12-Beat	Big Band orchestra style and instrumentation. Piano at CHORD 1, guitar at CHORD 2, trumpets at PHRASE 1, trombones at PHRASE 2, and saxes at PAD.
51	Big Band Ballad	12-Beat	Slowly swaying Big Band sound. Use in medley with Jazz Ballad to switch to piano/guitar quartet.
52	Swing	12-Beat	European big-band swing style. Good for all mid-tempo swing tunes.
53	Swing Waltz	Nine-Eight	Mid-tempo 9/8 waltz.
Contemporary Jazz			
54	BeBop	12-Beat	'40s New York fast Bepop style. Good also for instantly adding a double-time feel to any style!
55	Jazz Ballad	12-Beat	Slow jazz style with piano, guitar, bass and brush drums. Turn off PHRASE 1 & 2 when playing piano melody. Use in medley with Big Band Ballad to change orchestration.
56	Jazz Waltz	Nine-Eight	Swing style in 3/4 time for playing jazz waltz standards.
57	Fusion	16-Beat	Latin flavored 16-beat fusion.
58	Fusion Shuffle	24-Beat	West Coast type funk shuffle.
Latin			
59	Mambo	8-Beat	Contemporary Latin dance music. If playing the melody with a piano sound, turn off CHORD 2.
60	Merengue	8-Beat	High-energy Latin style with lots of percussion and punchy brass.
61	Beguine	8-Beat	Slow rumba rhythm, a la "Begin the Beguine."
62	Bomba	16-Beat	Puerto Rican dance rhythm, cousin to the Merengue.
63	Guaguanco	16-Beat	Another high-powered Latin dance style, usually played with drums/percussion only. Use RHYTHM 1 & 2, PHRASE 1 & 2 to bring individual percussion in and out.
Latin Pop			
64	Pop Bossa	8-Beat	Soft, electric-piano based Latin pop sound.
65	Bossa Nova Slow	8-Beat	Mellow and jazzy Bossa Nova style, good for mid to slow tempos. There are two separate types for Intro B/Ending B: major and minor.
66	Jazz Samba	16-Beat	Traditional Brazilian samba with an added drum set.
67	Modern Cha Cha	16-Beat	Afro-Cuban dance style for medium slow tempos.
68	Latin Rock	16-Beat	Contemporary Cha Cha with electric bass and drum kit.
Caribbean			
69	Ska	8-Beat	Ska rhythm. Minor keys add doubled "skank."
70	Calypso	16-Beat	Traditional Jamaican Calypso music from the '60s.
71	Reggae 16	16-Beat	Modern Jamaican Reggae rhythm with fat synth bass.
72	Reggae 12	12-Beat	Reggae shuffle.
Country & Western			
73	Bluegrass	16-Beat	Try this one with just CHORD 1 and RHYTHM 1 at first, then build up the arrangement by adding different instruments.
74	Country Pop	8-Beat	Contemporary country style.
75	Country Rock	8-Beat	Soft country style with pedal steel sound. Guitar voicings are most authentic for simple chords, like major, minor, 7th, etc.
76	Country Ballad	8-Beat	Especially suited to slow tempos. Also, try playing with CHORD 1 only.
77	Country Waltz	Nine-Eight	Simple, versatile country style with acoustic guitar. Guitar voicings are most authentic for simple chords, like major, minor, 7th, etc.
78	Country Shuffle	12-Beat	Traditional country style using acoustic guitar. Guitar voicings are most authentic for simple chords, like major, minor, 7th, etc.
79	Western Shuffle	12-Beat	Down-home Country and Western shuffle, with a modern touch.

Appendix

■ Style List

#	Name	Rhythm	Comments
World Music			
80	Polka	8-Beat	Traditional Polka style with acoustic instruments. Try altering the arrangement by bringing the accordion and the horn parts in and out.
81	Traditional Waltz	Three-Four	European waltz with guitar, accordion, clarinet, bass, drums and a string pad. Use CHORD 1 & 2 and PHRASE 1 for guitar/accordion arrangement.
82	Sevillianas	Three-Four	Fast waltz time — almost flamenco style.
83	Bolero Lento	8-Beat	Guitar-based style, quite romantic. Bolero Lento is related to Rumba and can be used as a slower variation.
84	Rumba Espagnole	16-Beat	Spanish guitar style, with relatively full orchestration.
85	Dangdut	8-Beat	Contemporary Indonesian pop sound.
March			
86	Military March	8-Beat	Traditional march style. Trombones at CHORD 1, trumpets at CHORD 2, french horn at PHRASE 1, piccolo at PHRASE 2, xylophone at PAD.
87	6/8 March	Six-Eight	Marching brass band. Brass is added to the drum sound when you change chords during Intro B. Enjoy different drum fills with breaks A and B.
88	Tarantella	Six-Eight	Named after the Tarantula spider, whose bite might cause one to dance in this style, this rhythm is used in the popular song “Funiculi Funicula.”
Ballroom Standard			
89	Slow Waltz	Three-Four	This slow waltz (or English waltz) style has been arranged in the style of a small band.
90	Tango Argentina	8-Beat	Traditional ballroom style Tango.
91	Tango Habanera	8-Beat	Latin rhythm best known from the opera “Carmen.”
92	Slowfox	12-Beat	A standard ballroom dance. This style is suitable for many ballads and slow mellow jazz or swing tunes.
93	Viennese Waltz	Three-Four	Relaxed, ballroom waltz. Guitar is at CHORD 1, accordion at CHORD 2, pizzicato strings at PHRASE 1, clarinets at PHRASE 2 and mid-register strings at PAD.
94	Foxtrot	12-Beat	Strict tempo Foxtrot for ballroom dancing.
95	Jive	12-Beat	Jive (or Boogie) is a fast ballroom dance.
Ballroom Latin			
96	Rumba	8-Beat	Rumba played in the style of a ballroom orchestra. Related to Beguine and Bolero Lento.
97	Samba	16-Beat	Standard ballroom Samba. Guitar is at CHORD 1 & 2, with 2 playing the lower strings. Turning RHYTHM 2 on/off provides additional variation.
98	Cha Cha	8-Beat	Strict tempo ChaCha style for ballroom dancing. Try starting only with RHYTHM 2, BASS and CHORD , then bring in other instruments one by one.
99	Pasodoble	8-Beat	Flamenco-style rhythm, featuring Spanish guitar. Turning RHYTHM 2 on/off provides additional variation.
Custom			
00	Enka	8-Beat	Modern arrangement of old Japanese pop style.
Disk Style			
FILE # 05	Rap	16-Beat	Modern rap/hip-hop rhythm with turntable scratching and other effects. RHYTHM 1 & 2 can stand on their own as basic rhythm tracks.
FILE # 06	Rave	16-Beat	Hard-driving synth bass and “space bleep” synth percussion.
FILE # 07	Enka	8-Beat	Modern arrangement of old Japanese pop style.
FILE # 08	Zouk	16-Beat	Upbeat Afro-Caribbean dance rhythm with kalimba at PHRASE 1 and xylophone at PHRASE 2.
FILE # 09	Charleston	12-Beat	'20s dance music.
FILE # 10	Modern Jazz	12-Beat	Contemporary jazz style. Rhythm 2 adds drum comping.
FILE # 11	Batucada	16-Beat	Also known as a Carnival or Street Samba.
FILE # 12	Rock Cha Cha	8-Beat	An exciting rock style embellished with Latin percussion instruments.

* Disk Style (FILE# 05 ... 12) are the styles provided on the supplied PSR-1700/2700 demonstration disk.

■ Error Messages

If an error occurs during operation of the PSR-1700/2700, one of the following error messages will appear so you'll know what went wrong and how to remedy the situation.

Disk-related Error Messages

Can't Load	You have attempted to load a file that cannot be loaded. Check the file number, select an appropriate file and try again.
Can't Play	You have attempted to start the QUICK PLAY function with a disk that contains no files suitable for quick playback. Only Yamaha DOC files, SMF format-0 files, ESEQ files, or PianoSoft files can be used with the Quick Play function.
Disk Full	The disk does not have sufficient capacity remaining for the file you have attempted to save. Either delete unwanted data from the disk to make more room, or use a different disk.
Disk Not Ready!	You have attempted to execute a disk operation while no disk is loaded. Insert an appropriate disk and try again.
Disk Protected	You have attempted to save to, delete, or format a write-protected disk. Slide the floppy disk write-protect tab to the write-enable position and try again.
File Not Found!	The file you have attempted to delete or load cannot be found. This error message will also appear if you specify a file number that has no data for deleting or loading.
File Protected	You have attempted to save to or delete a write-protected file. Such files can not be overwritten or deleted by the PSR-1700/2700.
Read Error	An error occurred while reading data from the disk. If the error persists there could be something wrong with the floppy disk or the data on the disk might be corrupted. If possible try a different disk.
Same Name	You have specified a file name that already exists on the current disk. Try again and change the name.
Unformatted Disk!	The loaded disk is not formatted for use with the PSR-1700/2700. Either format the disk or replace it with an already-formatted disk.
Write Error	An error occurred while writing data to the disk. Try the operation again. If the error persists there could be something wrong with the floppy disk. Try re-formatting the disk. If this doesn't help, try a different disk.
Wrong File Name	You have attempted to save a file with a file name consisting of all spaces. Try again with a different file name.

Appendix

Digital Sampling-related Error Messages (PSR-2700)

No Bank	The maximum of 255 “banks” of data has been exceeded (one pad contains one “bank”). Clear all unnecessary pads and voice data before attempting to sample more data.
No Wave Data	You have attempted to map or tune a pad or entering an original voice name that contains no sampled voice data.
Protected Voice	You have attempted to clear, record, or edit a pre-programmed disk voice file. In some cases pre-programmed sampled voices (“Protected Voices”) can only be loaded.
Same Note	You have attempted to map a pad to key to which another pad is already mapped. Map either pad to a different key.
Wave Ram Full	The wave RAM memory is full and can accept no more sampled voice data (the wave RAM is 1,020 kilobytes). Clear all unnecessary pads and voice data before attempting to sample more data.
Wrong Disk	You have inserted the wrong disk or a disk that does not contain the required data. Large sampled voice data files may span more than one disk, and these must be inserted in the correct order when loading the file. Check the disk number and try again.

Other Error Messages

IllegalOperation	You have pressed a button that can not be used in the current mode. Read the instructions for the function you are using carefully, and use appropriate function button.
Memory Full	The PSR-1700/2700 recording memory has become full while recording Song Memory, Custom Accompaniment, or Multi Pad data. Save data you want to keep to disk and clear all unnecessary data from memory to make more room.

System Reset Procedure

All internal memory settings are retained in memory even when the power switch is turned OFF as long as a good set of backup batteries is present or the AC plug is connected. You can, however, restore the factory default settings by following the procedures outlined below.

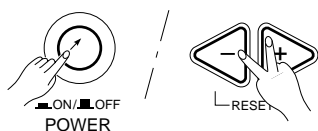

- 1 Press the [POWER] switch to turn the PSR-1700/PSR-2700 power OFF.
- 2 Turn the power back ON while holding both the [+] and [-] buttons. “Backup RAM Clear” will appear on the LCD display panel while the data is being reset.



• Executing the System Reset function will erase all internal memory settings

■ Troubleshooting

Something not working as it should? In many cases what appears to be a malfunction can be traced to a simple error that can be remedied immediately. Before assuming that your PortaTone is faulty, please check the following points.

PROBLEM	POSSIBLE CAUSE/SOLUTION
<ul style="list-style-type: none"> The speakers produce a “pop” sound whenever the power is turned ON or OFF. 	<ul style="list-style-type: none"> This is normal and is no cause for alarm.
<ul style="list-style-type: none"> Not all simultaneously-played notes sound. 	<ul style="list-style-type: none"> You are probably exceeding the instrument's maximum polyphony. The PSR-1700 and PSR-2700 can play up to 28 notes at the same time — including split, dual, auto-accompaniment, and multi pad notes. Notes exceeding this limit will not sound. The same applies to the 26-note polyphony of the PSR-2700 sampled voices.
<ul style="list-style-type: none"> Auto accompaniment won't function properly. No lower keyboard sound. 	<ul style="list-style-type: none"> Auto accompaniment won't sound right if you're using SINGLE type fingering when the SINGLE mode is not selected (page 27). Are you sure you're playing in the Auto-Accompaniment section of the keyboard? Are you playing chords that the PSR-1700 and PSR-2700 can recognize (see chord types on pages 26, 27, and 28)?
<ul style="list-style-type: none"> The selected voice does not sound when the keyboard is played. 	<ul style="list-style-type: none"> The orchestration part to which the voice is assigned must be turned ON (page 11). Make sure that the voice volume parameter for the orchestration part to which the voice is assigned is set to an appropriate level (page 14).
<ul style="list-style-type: none"> Voice parameter changes do not affect the desired voice. 	<ul style="list-style-type: none"> The edit mode for the voice to which the changes are to be applied must be turned ON (page 13).
<ul style="list-style-type: none"> No sound when rhythm started. 	<ul style="list-style-type: none"> Some sections of some styles have no data in the rhythm track. Try turning Auto Accompaniment on and fingering an appropriate chord — the Auto Accompaniment should begin to play.
<ul style="list-style-type: none"> Song Memory track indicator does not go out when the track is cleared. 	<ul style="list-style-type: none"> You may have executed the clear function from a point in the middle of the track, thus only clearing the data after that point. Press the [RESET] button to go to the beginning of the track, then clear.
<ul style="list-style-type: none"> No sound when the keyboard is played. 	<ul style="list-style-type: none"> LOCAL OFF is selected for the left- or right-hand section of the keyboard. Set to LOCAL ON (page 76).

Index

+ and – buttons 10

A

Accompaniment control 29
Accompaniment & melody playback 43
Accompaniment structure 31
Accompaniment track recording,
 realtime 40
Auto accompaniment 24
Auto harmony 16

B

Backup batteries 5
Beat indicator 29
Breaks 30

C

Chord 1 mode, fingering 26
Chord 2 mode, fingering 27
Clear, song memory/custom
 accompaniment/multi pad 54
Clock mode, MIDI 75
Connections for sampling (PSR-2700) 63
Connectors, MIDI 73
Control, MIDI 73
Custom accompaniment 47

D

Data backup 4
Data dial 10
Delete disk file 61
Demo playback 7
Digital sampling (PSR-2700) 63
Disk demo 8
Disk operations 56
Disk Orchestra Collection disks 62
DSP depth 15
DSP depth, sample (PSR-2700) 69
DSP type 22
Dual mode 12

E

Editing procedure 9
Editing samples (PSR-2700) 68
Effects 17
Ending 31
Error messages 81
Expression 72

F

Fade-in & Fade-out 32
File extension 58
File name 59
File types 58
Fill-ins 30
Fingering, auto accompaniment 25
Floppy disks, using 56
Formatting disks 57
Freeze 38
Full mode, fingering 28
Function button 9

G

Gate time 51
GM System Level 1 342

H

Harmony 16
Headphones 6

I

Input level, sampling (PSR-2700) 63
Introduction (intro) 30

K

Keyboard percussion 18

L

Level check mode,
 sampling (PSR-2700) 63
LCD display panel 9
Load from disk 60
Local & MIDI output 76

M

Main A and B sections 30
Mapping samples (PSR-2700) 70
Measure number 44
Melody track recording, realtime 42
Metronome 28
MIDI 73
MIDI implementation chart 340
Minus-one playback 62
Modulation 19
Multi mode, fingering 27
Multi pads 45
Music stand 6

N

Number buttons 10

O

Octave 14
One touch setting 36
Orchestration 11
Overall control 20

P

Pan 15
Pan, sample (PSR-2700) 69
Panel Controls 2
Pedal assign 72
Percussion kit list 338
Pitch bend 18
Power supply 5

Q

Quantization 53
Quick play 62

R

Receive modes, MIDI 74
Record functions 39
Recording samples (PSR-2700) 66
Registration memory 37
Reset, song memory 44
Revoice 34
Rewrite setting 55

S

Sample pads (PSR-2700) 67
Sampled voice name (PSR-2700) 67
Sampling frequency (PSR-2700) 64
Save to disk 58
Selecting & playing voices 11
Single mode 11
Single modes, fingering 27
Song memory 39
Specifications 343
Split & Dual modes 12
Split modes 12
Split point change 20
Split point, auto accompaniment 25
Standard MIDI file disks 62
Star/stop mode, MIDI 75
Step recording 50
Step size 50
Stopping the accompaniment 31
Straight start 29
Style list 78
Style selection 24
Supplied demonstration disk 60
Sustain 72
Synchro start 29
System reset 82

T

Tempo control 28
Touch sensitivity 23
Track buttons 33
Transmit channels, MIDI 76
Transpose 21
Trigger level, sampling (PSR-2700) 65
Troubleshooting 83
Tuning 21
Tuning samples (PSR-2700) 68

V

Voice & polyphony list 77
Voice assignment 13
Volume 14
Volume, accompaniment 32
Volume, sample (PSR-2700) 69

Y

Yes/no confirmation 10

Percussion Kit List

* “<—” indicates the content is the same as that of Standard Kit.

* Only 1 note can be played at a time when Keyboard Percussion is engaged.

* The number in parentheses () after the percussion kit name is the MIDI program number.

* The corresponding MIDI note numbers for the notes listed in the chart below are actually one octave lower. For example, the MIDI note number for note #36 (C1) in the chart is note #24 (C0).

Note#	Note	1: Standard (0)	2: Room (8)	3: Rock (16)	4: Electronic (24)
36	C1	Click (Square wave)	<—	<—	<—
37	C#1	Brush Tap	<—	<—	<—
38	D1	Brush Swirl	<—	<—	<—
39	D#1	Brush Slap	<—	<—	<—
40	E1	Brush Swirl W/Attack	<—	<—	Reverse Cymbal
41	F1	Snare Roll	<—	<—	<—
42	F#1	Castanet	<—	<—	Hi-Q
43	G1	Snare H Soft	Snare Room L	Snare Rock L	Snare Gate L
44	G#1	Sticks	<—	<—	<—
45	A1	Bass Drum H Soft	Bass Drum Room L	Bass Drum Rock L	Bass Drum Gate L
46	A#1	Open Rim Shot	<—	<—	<—
47	B1	Bass Drum L	Bass Drum Room M	Bass Drum Rock M	Bass Drum Gate M
48	C2	Bass Drum H Hard	Bass Drum Room H	Bass Drum Rock H	Bass Drum Gate H
49	C#2	Closed Rim Shot	<—	<—	<—
50	D2	Snare L	Snare Room M	Snare Rock M	Snare Gate M
51	D#2	Hand Clap	<—	<—	<—
52	E2	Snare H Hard	Snare Room H	Snare Rock H	Snare Gate H
53	F2	Floor Tom L	Room Tom 1	Rock Tom 1	Electronic Tom 1
54	F#2	Hi-Hat Closed	<—	<—	<—
55	G2	Floor Tom H	Room Tom 2	Rock Tom 2	Electronic Tom 2
56	G#2	Hi-Hat Pedal	<—	<—	<—
57	A2	Low Tom	Room Tom 3	Rock Tom 3	Electronic Tom 3
58	A#2	Hi-Hat Open	<—	<—	<—
59	B2	Mid Tom L	Room Tom 4	Rock Tom 4	Electronic Tom 4
60	C3	Mid Tom H	Room Tom 5	Rock Tom 5	Electronic Tom 5
61	C#3	Crash Cymbal 1	<—	<—	<—
62	D3	High Tom	Room Tom 6	Rock Tom 6	Electronic Tom 6
63	D#3	Ride Cymbal 1	<—	<—	<—
64	E3	Chinese Cymbal	<—	<—	<—
65	F3	Ride Cymbal Cup	<—	<—	<—
66	F#3	Tambourine	<—	<—	<—
67	G3	Splash Cymbal	<—	<—	<—
68	G#3	Cowbell	<—	<—	<—
69	A3	Crash Cymbal 2	<—	<—	<—
70	A#3	Vibraslap	<—	<—	<—
71	B3	Ride Cymbal 2	<—	<—	<—
72	C4	Bongo H	<—	<—	<—
73	C#4	Bongo L	<—	<—	<—
74	D4	Conga H Mute	<—	<—	<—
75	D#4	Conga H Open	<—	<—	<—
76	E4	Conga L	<—	<—	<—
77	F4	Timbale H	<—	<—	<—
78	F#4	Timbale L	<—	<—	<—
79	G4	Agogo H	<—	<—	<—
80	G#4	Agogo L	<—	<—	<—
81	A4	Cabasa	<—	<—	<—
82	A#4	Maracas	<—	<—	<—
83	B4	Samba Whistle H	<—	<—	<—
84	C5	Samba Whistle L	<—	<—	<—
85	C#5	Guiro Short	<—	<—	<—
86	D5	Guiro Long	<—	<—	<—
87	D#5	Claves	<—	<—	<—
88	E5	Wood Block H	<—	<—	<—
89	F5	Wood Block L	<—	<—	<—
90	F#5	Cuica Mute	<—	<—	Scratch H
91	G5	Cuica Open	<—	<—	Scratch L
92	G#5	Triangle Mute	<—	<—	<—
93	A5	Triangle Open	<—	<—	<—
94	A#5	Shaker	<—	<—	<—
95	B5	Jingle Bell	<—	<—	<—
96	C6	Bell Tree	<—	<—	<—
97	C#6	Voice 'One'	<—	<—	<—
98	D6	Voice 'Two'	<—	<—	<—
99	D#6	Voice 'Three'	<—	<—	<—
100	E6	Voice 'Four'	<—	<—	<—
101	F6	Voice 'Are You Sure?'	<—	<—	<—

Note#	Note	5: Analog (25)	6: Jazz (32)	7: Brush (40)	8: Classic (48)
36	C1	<—	<—	<—	<—
37	C#1	<—	<—	<—	<—
38	D1	<—	<—	<—	<—
39	D#1	<—	<—	<—	<—
40	E1	Reverse Cymbal	<—	<—	<—
41	F1	<—	<—	<—	<—
42	F#1	Hi-Q	<—	<—	<—
43	G1	Snare Analog L	<—	Brush Slap L	Snare Classic L
44	G#1	<—	<—	<—	<—
45	A1	Bass Drum Analog L	<—	<—	Gran Casa L
46	A#1	<—	<—	<—	<—
47	B1	Bass Drum Analog M	<—	<—	Gran Casa M
48	C2	Bass Drum Analog H	<—	<—	Gran Casa H
49	C#2	Closed Rim Shot Analog	<—	<—	<—
50	D2	Snare Analog M	<—	Brush Slap H	Snare Classic M
51	D#2	<—	<—	<—	<—
52	E2	Snare Analog H	<—	Brush Tap	Snare Classic H
53	F2	Analog Tom 1	Natural Tom 1	Brush Tom 1	Natural Tom 1
54	F#2	Analog Hi-hat Closed 1	Dark Hi-Hat Closed	Dark Hi-Hat Closed	Dark Hi-Hat Closed
55	G2	Analog Tom 2	Natural Tom 2	Brush Tom 2	Natural Tom 2
56	G#2	Analog Hi-hat Closed 2	Dark Hi-Hat Pedal	Dark Hi-Hat Pedal	Dark Hi-Hat Pedal
57	A2	Analog Tom 3	Natural Tom 3	Brush Tom 3	Natural Tom 3
58	A#2	Analog Hi-hat Open	Dark Hit Hat Open	Dark Hit Hat Open	Dark Hit Hat Open
59	B2	Analog Tom 4	Natural Tom 4	Brush Tom 4	Natural Tom 4
60	C3	Analog Tom 5	Natural Tom 5	Brush Tom 5	Natural Tom 5
61	C#3	<—	<—	<—	Hand Cymbal Long L
62	D3	Analog Tom 6	Natural Tom 6	Brush Tom 6	Natural Tom 6
63	D#3	<—	<—	<—	Hand Cymbal Short L
64	E3	<—	<—	<—	<—
65	F3	<—	<—	<—	<—
66	F#3	<—	<—	<—	<—
67	G3	<—	<—	<—	<—
68	G#3	<—	<—	<—	<—
69	A3	<—	<—	<—	Hand Cymbal Long H
70	A#3	<—	<—	<—	<—
71	B3	<—	<—	<—	Hand Cymbal Short H
72	C4	<—	<—	<—	<—
73	C#4	<—	<—	<—	<—
74	D4	<—	<—	<—	<—
75	D#4	<—	<—	<—	<—
76	E4	<—	<—	<—	<—
77	F4	<—	<—	<—	<—
78	F#4	<—	<—	<—	<—
79	G4	<—	<—	<—	<—
80	G#4	<—	<—	<—	<—
81	A4	<—	<—	<—	<—
82	A#4	<—	<—	<—	<—
83	B4	<—	<—	<—	<—
84	C5	<—	<—	<—	<—
85	C#5	<—	<—	<—	<—
86	D5	<—	<—	<—	<—
87	D#5	<—	<—	<—	<—
88	E5	<—	<—	<—	<—
89	F5	<—	<—	<—	<—
90	F#5	Scratch H	<—	<—	<—
91	G5	Scratch L	<—	<—	<—
92	G#5	<—	<—	<—	<—
93	A5	<—	<—	<—	<—
94	A#5	<—	<—	<—	<—
95	B5	<—	<—	<—	<—
96	C6	<—	<—	<—	<—
97	C#6	<—	<—	<—	<—
98	D6	<—	<—	<—	<—
99	D#6	<—	<—	<—	<—
100	E6	<—	<—	<—	<—
101	F6	<—	<—	<—	<—

MIDI Implementation Chart

[Portable Keyboard]

Model: PSR-1700/PSR-2700

MIDI Implementation Chart

Date: 1993. 11. 1

Version: 1.00

Function	Transmitted	Recognized	Remarks
Basic Default Channel Changed	1~16 CH 1~16 CH	1~16 CH (*1) 1~16 CH (*1)	
Mode Default Messages Altered	Mode 3 × *****	(*1) × ×	
Note Number : True voice	0~127 *****	0~127 0~127	
Velocity Note on Note off	○ 9nH, v=1~127 × 9nH, v=0	○ 9nH, v=1~127 × 9nH, v=0 or 8nH	
After key's Touch Ch's	× ×	× ○ (*2)	
Pitch Bender	○	○	
Control Change	0, 32 ○ (*3) 1 ○ 6, 38 ○ 7 ○ 10 ○ 11 ○ 64 ○ 66 × 84 ○ 90 × 91 ○ 96 × 97 × 100, 101 ○ (*6) 120 ○ 121 ×	○ (*4) ○ ○ ○ ○ ○ ○ ○ ○ (*5) ○ ○ ○ ○ (*7) ○ (*8)	Bank select MSB, LSB Modulation depth Data entry MSB, LSB Volume Pan Expression Sustain Sostenuto Portamento control Reverb send level RPN data increment RPN data decrement RPN MSB, LSB All sound off Reset all controllers
Program Change : True #	○ 0~127 *****	○ 0~127 0~127 (*9)	
System Exclusive	○ (*10)	○ (*10)	
System : Song Position : Song Select Common : Tune	× × ×	× × ×	
System : Clock Real Time : Commands	○ ○ (*12)	○ (*11) ○ (*12)	
Aux : Local ON/OFF : All Notes Off Messages : Active Sense : Reset	× ○ ○ ×	× ○ ○ ×	

Mode 1: OMNI ON, POLY
Mode 3: OMNI OFF, POLY

Mode 2: OMNI ON, MONO
Mode 4: OMNI OFF, MONO

○: Yes
×: No

*1. The following modes can be set individually for each channel via the panel control:

- Mode 00: Reception OFF.
- Mode 01: Direct tone generator control.
- Mode 02: Same as keyboard note on/off operation.
- Mode 03: Same as auto-accompaniment chord fingering.
- Mode 04: Same as the lowest-note (bass note) played in the auto-accompaniment chord fingerings.

*2. Channel pressure handled as vibrato.

*3. For bank selection transmission only the MSB changes. The LSB is fixed at 00H.

*4. Bank select reception.

The bank select MSB is used for melody voice and rhythm voice switching.

The bank select LSB is ignored.

- MSB 00H: GM melody voice.
- MSB 01H: Sample voice (PSR-2700).
- MSB 7FH: GM rhythm voice.

The default for all the channels excepting channel 10 is 00H. Bank select reception with channel 10 is not possible since channel 10 is assigned to the rhythm accompaniment. However, bank select reception with channel 10 will be possible when you do the following operation: turning the POWER back on while holding the C1 key down.

When the bank select MSB is 01H ... 7EH, all subsequent key-ons received will be ignored.

No voice change will occur when only a bank select is received.

When a program change is received the latest bank select value is used.

*5. Portamento control is effective only when Reception is set in the Multi mode.

*6. A pitch bend sensitivity message is transmitted when a panel pitch bend range setting is made.

Pitch bend sensitivity: BnH, 64H, 00H, 65H, 00H

*7. RPN receives the following data:

Pitch bend sensitivity: BnH, 64H, 00H, 65H, 00H
Default: 02H, 00H

Fine tuning: BnH, 64H, 01H, 65H, 00H
Default: 40H, 00H

Coarse tuning: BnH, 64H, 02H, 65H, 00H
Default: 40H, 00H

Null: BnH, 64H, 7FH, 65H, 7FH

*8. Reset all controllers.

Pitch bend, channel pressure, modulation, expression, sustain, and sostenuto are returned to their default values.

All RPN data is set to NULL.

Portamento is reset.

*9. GM melody voices 0 through 127 become panel voices 1 through 128.

Sample voices 0 through 127 become panel sample voices 1 through 128. (PSR-2700)

Rhythm voices 0, 8, 16, 24, 25, 32, 40, and 48 become panel voices 1 through 8.

*10. Exclusive.

<GM1 System ON> F0H, 7EH, 7FH, 09H, 01H, F7H
All parameters except MIDI Master Tuning are reset to their default values.

<MIDI Master Volume> F0H, 7FH, 7FH, 04H, 01H, ll, mm, F7H
Allows the volume of all channels to be changed simultaneously (universal system exclusive).

mm is used as the MIDI Master Volume value (ll is ignored).

The default value for mm is 7FH.

This message is receive-only.

<MIDI Master Tuning>

F0H, 43H, 1nH, 27H, 30H, 00H, 00H, mm, ll, cc, F7H
Allows the pitch of all channels to be changed simultaneously (panel tuning).

mmll is used as the MIDI Master Tuning value, and the actual tuning is shown by the expression:

$$T = M \times 200 / 256 - 100$$

Where T is the actual tuning value in cents. M is decimal value represented by 1-byte using bits 0...3 of mm as the MSB and bits 0...3 of ll as the LSB.

The default values of mm and ll are 07H and 0FH, respectively. n and cc are also recognized.

This value is not reset by a GM System ON or Reset All Controllers message.

This message is transmitted and received.

<DOC On> F0H, 43H, 73H, 01H, 14H, F7H

Reception only.

MIDI IN channels 1 through 16 apply to the DOC data. The panel voice assignments are not affected.

<Panel Control>

Dual data change: F0H, 43H, 76H, 17H, 04H, <Data>, F7H

Dual ON/OFF: F0H, 43H, 76H, 17H, 05H, <Data>, F7H

Harmony/Effect: F0H, 43H, 76H, 17H, 0EH, <Data>, F7H

DSP type: F0H, 43H, 76H, 17H, 0EH, 00H, 01H, <Data>, F7H

Chord/Bass: F0H, 43H, 76H, 17H, 0BH, <Data>, F7H

*11. Internal/external clock selectable.

*12. Operation when a start/stop command is received is determined by the RECEIVE CHANNEL, CLOCK, AND COMMAND panel settings.

0. Start/stop command ignored.

1. Auto-accompaniment start/stop.

2. Song memory start/stop.

Continue neither transmitted nor received.

■ GM System Level 1

The existing MIDI protocol allows performance and other data to be transferred between different instruments, even if they are from different manufacturers. This means, for example, that sequence data that was originally created to control a tone generator from manufacturer A can also be used to control a different tone generator from manufacturer B. Since the voice allocation in different devices from different manufacturers is usually different, however, appropriate program change data must be transmitted to select the right voices.

The General MIDI protocol was developed to minimize confusion and the need for re-programming when playing software created by one MIDI device on another. This has been achieved by defining a standard voice allocation in which the same or similar voices are accessed by the same program change numbers or MIDI channels. The current standard recognized by the International MIDI Association is known as "GM System Level 1." The PSR-1700/PSR-2700 voice allocation complies with the GM System Level 1 standard.

Specifications

Keyboards:

61 standard-size keys (C1~C6) with touch response.

VOICE:

AWM128 voices: 01~128
Polyphony: 28
KEYBOARD PERCUSSION: 1~8
VOL: 00~24
OCTAVE: -2~2
DSP DEPTH: 00~15
PAN: -7~7
ONE TOUCH SETTING
ORCHESTRATION: R1/R2/L1/L2
HARMONY: TYPE 01~10, ON/OFF
EFFECT: TYPE 01~12, ON/OFF

Setup:

POWER: ON/OFF
MASTER VOLUME: MIN~MAX

PEDAL ASSIGN:

1, 2

OVERALL CONTROL:

TEMPO
METRONOME: ON/OFF
SPLIT POINT
TRANSPOSE: -12~12
TUNING: -16~16
DSP TYPE: 1~8
TOUCH: SENSE 1~5,
TOUCH RESPONSE ON/OFF
PITCH BEND: -12~12
MODULATION: 1~3

AUTO ACCOMPANIMENT:

100 styles: 00~99
(00: Custom Accompaniment)
AUTO ACCOMP: ON/OFF
FINGERING: 1~5
ACCOMP VOLUME: 00~24
REVOICE
TRACK: RHYTHM 1/2, BASS,
RHYTHMIC CHORD 1/2, PAD CHORD,
PHRASE 1/2
ACCOMPANIMENT CONTROL: SYNC-
START/STOP, START/STOP, FADE IN/
OUT, INTRO, FILL IN 1, FILL IN 2,
BREAK, ENDING, VARIATION A/B

REGISTRATION MEMORY:

MEMORIZE
1~8
FREEZE

MULTI PADS:

STOP
1~4 (including 2 chord-match types).

DEMO:

SONG #: Chain Play, 1~8 (8 songs)
START/STOP

SONG MEMORY:

MEASURE #
TRACK: ACCOMP, MELODY 1~6

SONG:

RESET (STEP BWD),
PLAY/STOP (STEP FWD)

RECORDING:

REC, REWRITE SETTING, CLEAR,
STEP REC, QUANTIZE, GATE TIME,
STEP SIZE

DIGITAL SAMPLING (PSR-2700):

VOICE #: 01~128 (26-note polyphony),
VOICE NAME, FREQ, TRIGGER
LEVEL, PITCH, MAPPING, REC,
CLEAR, INPUT LEVEL

SAMPLE PADS (PSR-2700):

1~4

DISK:

FILE #, SAVE PART, MINUS ONE
SELECT, LOAD, SAVE, DELETE,
FORMAT

QUICK PLAY:

START/STOP, MINUS ONE

ARE YOU SURE ?:

YES, NO

LCD Display Panel:

Number Buttons: [+], [-], [0]~[9], [+/-]
Data Dial

MIDI:

RECEIVE CH/CL/COM, TRANSMIT CH
L/R (LOCAL/MIDI OUT)

Auxiliary Jacks:

MIDI IN/OUT/THRU, PEDAL 1/2,
SAMPLE IN (MIC/LINE: PSR-2700),
AUX OUT (L+R/L, R), HEADPHONES

Main Amplifiers:

8W x 2
AUX OUT output: 680Ω impedance.

Speakers:

12cm (4-3/4") x 2

Backup Batteries:

Four SUM-3, "AA" size, R6P or equivalent
batteries

Dimensions (W x D x H):

1045mm x 412mm x 164mm
(41-1/8" x 16-1/4" x 6-1/2")

Weight:

12.0kg (26.4 lbs.) excluding batteries

Supplied Accessories:

- PSR-1700/2700 Demonstration Disk
Demo Songs (4 songs): 01~04
Styles (8 styles with registration data):
05~12
Multi Pads (8 sets): 13~20
Sound Effects (4 sets): 21~24
- PSR-2700 Demonstration Disk (PSR-2700)
Demo Songs (2 songs with sampled
voices): 01~02
- Music Stand
- Owner's Manual

Optional Accessories:

- Headphones HPE-3, HPE-150
- Foot switch FC4, FC5
- Foot controller FC7
- Keyboard stand L-2C

* Specifications subject to change without notice.

IMPORTANT SAFETY INSTRUCTIONS

INFORMATION RELATING TO PERSONAL INJURY, ELECTRICAL SHOCK, AND FIRE HAZARD POSSIBILITIES HAS BEEN INCLUDED IN THIS LIST.

WARNING- When using any electrical or electronic product, basic precautions should always be followed. These precautions include, but are not limited to, the following:

- 1.** Read all Safety Instructions, Installation Instructions, Special Message Section items, and any Assembly Instructions found in this manual BEFORE making any connections, including connection to the main supply.
- 2.** **Main Power Supply Verification:** Yamaha products are manufactured specifically for the supply voltage in the area where they are to be sold. If you should move, or if any doubt exists about the supply voltage in your area, please contact your dealer for supply voltage verification and (if applicable) instructions. The required supply voltage is printed on the name plate. For name plate location, please refer to the graphic found in the Special Message Section of this manual.
- 3.** This product may be equipped with a polarized plug (one blade wider than the other). If you are unable to insert the plug into the outlet, turn the plug over and try again. If the problem persists, contact an electrician to have the obsolete outlet replaced. Do NOT defeat the safety purpose of the plug.
- 4.** Some electronic products utilize external power supplies or adapters. Do NOT connect this type of product to any power supply or adapter other than one described in the owners manual, on the name plate, or specifically recommended by Yamaha.
- 5.** **WARNING:** Do not place this product or any other objects on the power cord or place it in a position where anyone could walk on, trip over, or roll anything over power or connecting cords of any kind. The use of an extension cord is not recommended! If you must use an extension cord, the minimum wire size for a 25' cord (or less) is 18 AWG. NOTE: The smaller the AWG number, the larger the current handling capacity. For longer extension cords, consult a local electrician.
- 6.** **Ventilation:** Electronic products, unless specifically designed for enclosed installations, should be placed in locations that do not interfere with proper ventilation. If instructions for enclosed installations are not provided, it must be assumed that unobstructed ventilation is required.
- 7.** **Temperature considerations:** Electronic products should be installed in locations that do not significantly contribute to their operating temperature. Placement of this product close to heat sources such as; radiators, heat registers and other devices that produce heat should be avoided.
- 8.** This product was NOT designed for use in wet/damp locations and should not be used near water or exposed to rain. Examples of wet/damp locations are; near a swimming pool, spa, tub, sink, or wet basement.
- 9.** This product should be used only with the components supplied or; a cart, rack, or stand that is recommended by the manufacturer. If a cart, rack, or stand is used, please observe all safety markings and instructions that accompany the accessory product.
- 10.** The power supply cord (plug) should be disconnected from the outlet when electronic products are to be left unused for extended periods of time. Cords should also be disconnected when there is a high probability of lightening and/or electrical storm activity.
- 11.** Care should be taken that objects do not fall and liquids are not spilled into the enclosure through any openings that may exist.
- 12.** Electrical/electronic products should be serviced by a qualified service person when:
 - a. The power supply cord has been damaged; or
 - b. Objects have fallen, been inserted, or liquids have been spilled into the enclosure through openings; or
 - c. The product has been exposed to rain; or
 - d. The product does not operate, exhibits a marked change in performance; or
 - e. The product has been dropped, or the enclosure of the product has been damaged.
- 13.** Do not attempt to service this product beyond that described in the user-maintenance instructions. All other servicing should be referred to qualified service personnel.
- 14.** This product, either alone or in combination with an amplifier and headphones or speaker/s, may be capable of producing sound levels that could cause permanent hearing loss. DO NOT operate for a long period of time at a high volume level or at a level that is uncomfortable. If you experience any hearing loss or ringing in the ears, you should consult an audiologist. **IMPORTANT:** The louder the sound, the shorter the time period before damage occurs.
- 15.** Some Yamaha products may have benches and/or accessory mounting fixtures that are either supplied as a part of the product or as optional accessories. Some of these items are designed to be dealer assembled or installed. Please make sure that benches are stable and any optional fixtures (where applicable) are well secured BEFORE using. Benches supplied by Yamaha are designed for seating only. No other uses are recommended.

PLEASE KEEP THIS MANUAL

FCC INFORMATION (U.S.A.)

IMPORTANT NOTICE: DO NOT MODIFY THIS UNIT!

This product, when installed as indicated in the instructions contained in this manual, meets FCC requirements. Modifications not expressly approved by Yamaha may void your authority, granted by the FCC, to use the product.

IMPORTANT:

When connecting this product to accessories and/or another product use only high quality shielded cables. Cable/s supplied with this product **MUST** be used. Follow all installation instructions. Failure to follow instructions could void your FCC authorization to use this product in the USA.

NOTE:

This product has been tested and found to comply with the requirements listed in FCC Regulations, Part 15 for Class "B" digital devices. Compliance with these requirements provides a reasonable level of assurance that your use of this product in a residential environment will not result in harmful interference with other electronic devices. This equipment generates/uses radio frequencies and, if not installed and used according to

the instructions found in the users manual, may cause interference harmful to the operation of other electronic devices. Compliance with FCC regulations does not guarantee that interference will not occur in all installations. If this product is found to be the source of interference, which can be determined by turning the unit "OFF" and "ON", please try to eliminate the problem by using one of the following measures:

- Relocate either this product or the device that is being affected by the interference.
- Utilize power outlets that are on different branch (circuit breaker or fuse) circuits or install AC line filter/s.
- In the case of radio or TV interference, relocate/reorient the antenna. If the antenna lead-in is 300 ohm ribbon lead, change the lead-in to co-axial type cable.

If these corrective measures do not produce satisfactory results, please contact the local retailer authorized to distribute this type of product. If you can not locate the appropriate retailer, please contact Yamaha Corporation of America, Electronic Service Division, 6600 Orangethorpe Ave, Buena Park, CA90620

- This applies only to products distributed by Yamaha Corporation of America.

IMPORTANT NOTICE FOR THE UNITED KINGDOM

Connecting the Plug and Cord

IMPORTANT. The wires in this mains lead are coloured in accordance with the following code:

BLUE : NEUTRAL
BROWN : LIVE

As the colours of the wires in the mains lead of this apparatus may not correspond with the coloured markings identifying the terminals in your plug proceed as follows:

The wire which is coloured BLUE must be connected to the terminal which is marked with the letter N or coloured BLACK.

The wire which is coloured BROWN must be connected to the terminal which is marked with the letter L or coloured RED.

Making sure that neither core is connected to the earth terminal of the three pin plug.

- This applies only to products distributed by Yamaha-Kemble Music (U.K.) Ltd.

Dit produkt is gefabriceerd in overeenstemming met de radiostoringsvoorschriften van de Richtlijn van de Raad (82/499/EEG).

ΑΥΤΗ Η ΣΥΣΚΕΥΗ ΑΝΤΑΠΟΚΡΙΝΕΤΑΙ ΣΤΙΣ ΑΠΑΙΤΗΣΕΙΣ ΤΩΝ ΟΔΗΓΙΩΝ ΤΗΣ ΕΥΡΩΠΑΙΚΗΣ ΟΙΚΟΝΟΜΙΚΗΣ ΚΟΙΝΟΤΗΤΑΣ 82/499/Ε.Ο.Κ..

Este produto está de acordo com o radio de interferencia frequente requeridos do Conselho Diretivo 82/499/EEC.

Dette apparat overholder det gaeldende EF-direktiv vedrørende radiostøj.

Cet appareil est conforme aux prescriptions de la directive communautaire 87/308/CEE.

Diese Geräte entsprechen der EG-Richtlinie 82/499/EWG und/oder 87/308/EWG.

This product complies with the radio frequency interference requirements of the Council Directive 82/499/EEC and/or 87/308/EEC.

Questo apparecchio è conforme al D.M.13 aprile 1989 (Direttiva CEE/87/308) sulla soppressione dei radiodisturbi.

Este producto está de acuerdo con los requisitos sobre interferencias de radio frecuencia fijados por el Consejo Directivo 87/308/CEE.

YAMAHA CORPORATION

